

FCC Information

This device complies with Part 15 of the FCC Rules. Operation is subject to the following two conditions:

- (1) this device may not cause harmful interference, and
- (2) this device must accept any interference received, including interference that may cause undesired operation.

NOTE: This equipment has been tested and found to comply with the limits for a Class B digital device, pursuant to Part 15 of the FCC rules. These limits are designed to provide reasonable protection against harmful interference in a residential installation. This equipment generates, uses, and can radiate radio frequency energy and, if not installed and used in accordance with the instructions, may cause harmful interference to radio communications. However, there is no guarantee that interference will not occur in a particular installation. If this equipment does cause harmful interference to radio or television reception, which can be determined by turning the equipment off and on, the user is encouraged to try to correct the interference by one or more of the following measures:

- Reorient or relocate the receiving antenna.
- Increase the separation between the equipment and receiver.
- Connect the equipment into an outlet on a circuit different from that to which the receiver is connected.
- Consult the dealer or an experienced radio/TV technician for help.

WARNING: Changes or modifications to this unit not expressly approved by the party responsible for compliance could void the user's authority to operate the equipment.

CAN ICES-3 (B)/NMB-3(B)

FCC Radiation Exposure Statement

This device complies with FCC radiation exposure limits set forth for an uncontrolled environment and it also complies with Part 15 of the FCC RF Rules. This equipment must not be co-located or operating in conjunction with any other antenna or transmitter. End-users and installers must be provided with antenna installation instructions and consider removing the no-collocation statement.

Battery Use Cautions & Tips

For Safety & Best Performance: (Proper use and care of product)

- Only use the recommended/supplied batteries or equivalent.
- Use alkaline batteries for longer life.
- Do not mix old and new batteries, and do not mix alkaline, carbon-zinc or rechargeable nickel-cadmium batteries.
- Insert batteries with proper polarity (+/-) as indicated.
- Remove exhausted batteries from product.
- Recharge rechargeable batteries under adult supervision.
- Do not attempt to recharge non-rechargeable batteries.
- Do not open batteries or heat them beyond normal ambient temperatures.
- To prevent battery leakage or damage remove batteries from a product if it will not be used for a month or longer.
- Use extreme caution handling leaking batteries (avoid direct contact with eyes and skin). If battery leakage comes in contact with eyes, IMMEDIATELY flush the eye with lukewarm and gently flowing water for at least 30 minutes. If skin contact occurs, wash skin with clear water for at least 15 minutes. Seek medical attention if any symptoms occur.
- Store in cool, dry, ventilated area away from hazardous or combustible material.
- Do not dispose of batteries in the household trash or fire.
- Follow applicable laws and local regulations for the disposal and transportation of batteries.

Cleaning – The unit should be cleaned only using a warm damp cloth. Do not use solvents, etc.

Parents: Examine your unit periodically for conditions that may result in the risk of fire, electric shock, or injury to persons and that, in an event such conditions, the product should not be used until properly repaired.

Troubleshooting

If the unit is experiencing a fuzzy or distorted sound, check the batteries. They are most likely weak and need to be replaced with 8 brand new "C" batteries.

IC Statement

FCC ID: EMO673

IC: 986B-673

This device complies with Industry Canada license-exempt RSS standard(s). Operation is subject to the following two conditions: (1) this device may not cause interference, and (2) this device must accept any interference, including interference that may cause undesired operation of the device.

Le présent appareil est conforme aux CNR d'Industrie Canada applicables aux appareils radio exempts de licence. L'exploitation est autorisée aux deux conditions suivantes :

- (1) l'appareil ne doit pas produire de brouillage;
- (2) l'utilisateur de l'appareil doit accepter tout brouillage radioélectrique subi, même si le brouillage est susceptible d'en compromettre le fonctionnement.

The device meets the exemption from the routine evaluation limits in section 2.5 of RSS 102 and compliance with RSS-102 RF exposure, users can obtain Canadian information on RF exposure and compliance.

Le dispositif rencontre l'exemption des limites courantes d'évaluation dans la section 2.5 de RSS 102 et la conformité à l'exposition de RSS-102 rf, utilisateurs peut obtenir l'information canadienne sur l'exposition et la conformité de rf.

Questions or Comments

For questions or comments regarding this or other eKids products, please call our toll-free number: **1-888-TOP-TOYS**

Please also visit our website: www.ekids.com

Limited One Year Warranty

eKids warrants this product to be free from defects in workmanship and materials, under normal use and conditions, for a period of one (1) year from the date of original purchase.

Should this product fail to function in a satisfactory manner, it is best to first return it to the store where it was originally purchased. Should this fail to resolve the matter and service still be required by reason of any defect or malfunction during the warranty period, eKids will repair or, at its discretion, replace this product without charge. This decision is subject to verification of the defect or malfunction upon delivery of this product to the Factory Service Center authorized by Customer Service. If service is required, please call Customer Service at 1-888-TOP-TOYS (867-8697) to obtain a Return Authorization Number and shipping instructions. A copy of the sales receipt is required to validate in-warranty coverage.

Disclaimer of Warranty

NOTE: This warranty is valid only if the product is used for the purpose for which it was designed. It does not cover (i) products which have been damaged by negligence or willful actions, misuse or accident, or which have been modified or repaired by unauthorized persons; (ii) cracked or broken cabinets, or units damaged by excessive heat; (iii) damage to digital media players, CD's or tape cassettes (if applicable); (iv) the cost of shipping this product to the Factory Service Center and its return to the owner.

This warranty is valid only in the United States of America and does not extend to owners of the product other than to the original purchaser. In no event will eKids or any of its affiliates, contractors, resellers, their officers, directors, shareholders, members or agents be liable to you or any third party for any consequential or incidental damages, any lost profits, actual, exemplary or punitive damages. (Some states do not allow limitations on implied warranties or exclusion of consequential damages, so these restrictions may not apply to you.) This warranty gives you specific legal rights, and you may also have other rights which vary from state to state.

Your acknowledgement and agreement to fully and completely abide by the above mentioned disclaimer of warranty is contractually binding to you upon your transfer of currency (money order, cashier's check, or credit card) for purchase of your eKids product.

© 2018 eKids LLC.
Questions? Visit www.ekids.com
or call 1-888-TOP-TOYS
1299 Main Street Rahway NJ 07065

Printed in China

673_062518-C

eKids™

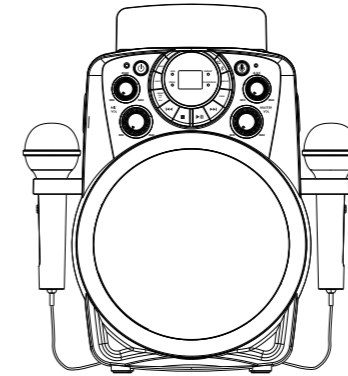

Model: JJ-673

Bluetooth + CD+G Karaoke

Important Message to Customers

Thank you for purchasing one of our many top-quality electronic products. Please take a moment to read through these instructions to help you understand the safe and proper way to use this toy to extend its usability.

Keep these instructions for future reference as they contain important information.

CAUTION-ELECTRICALLY OPERATED PRODUCT

NOT RECOMMENDED FOR CHILDREN UNDER 8 YEARS OF AGE. AS WITH ALL ELECTRIC PRODUCTS, PRECAUTIONS SHOULD BE OBSERVED DURING HANDLING AND USE TO PREVENT ELECTRIC SHOCK. AC 100~240V, 50~60Hz 0.5 A UL LISTED.

What's Included:

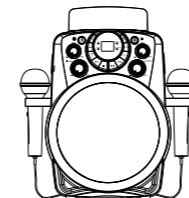

Karaoke Player



2 Microphones

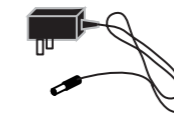

AC/DC Adapter



RCA Cable



Sample CDG Disc

Installing the Batteries

1. Open the battery compartment door located on the back of the unit.
2. Insert 8 new C batteries in the battery compartment. Make sure batteries match the + and - as indicated in the battery compartment diagram.
3. Replace battery compartment door.

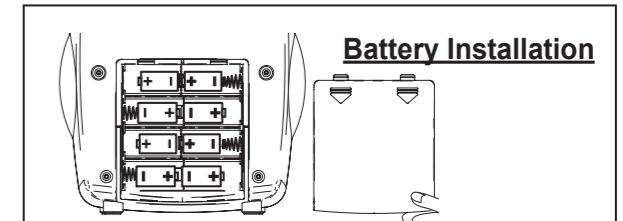

Battery Installation

Using AC Power

This unit also works on AC Power. Plug the small end of the power adapter (included) into the DC-IN jack on the back of the unit, and plug the power adapter into the household AC outlet.

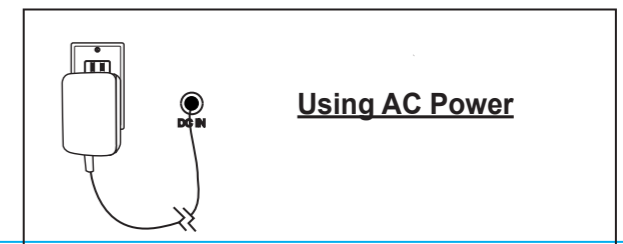

Using AC Power

Using the Microphone

Connect the included microphones to the two input jacks (26) on the unit. Turn on the unit and choose Bluetooth, AUX, or CDG modes using the Mode Button (6).

- Slide the switch on the Microphone to ON. Now you can sing along to your favorite music in either CD, Bluetooth, or AUX modes, and hear your voice through the speaker!
- When not in use, slide the Microphone switch to OFF. Unlock the removable slots on the side of the unit to store your microphone, as shown in the image on the right.

CDG Mode

This unit plays CD, CDR, and CDG formats. To play a CD or CDR, turn on the unit and set the Mode Selector (6) to CDG.

- Open the disc compartment on the top of the unit and insert the disc face up. Close the compartment door.
- Use the controls to play/pause (11), stop (10), or navigate tracks (8, 12).

To play a CDG disc on your television:

- Connect the included RCA cable (white and red connectors) to the RCA audio output jacks located at rear of the unit (27).
- Connect the other end of the audio cable to the RCA audio input jack of a TV set.
- Connect the RCA video cable (yellow connector) to the RCA video output jack located at rear of the unit (27).
- Connect the other end of the video cable to the RCA video input jack of a TV set, and make sure your television is set to the corresponding input.
- Turn on the unit and set the Mode Selector (6) to CDG.
- Insert a CDG disc into the unit and press the Play/Pause Button (11). Now you can follow the lyrics on the screen and sing along through the microphone!
- Use the Previous Track (8) and Next Track (12) buttons to navigate tracks on the CDG.

Repeat/Program Buttons

To repeat a track on your CD, press the Repeat Button (16) on the unit. The "Repeat" LED Indicator will blink. Press again, the "repeat" LED indicator will glow solid, and the unit will repeat all tracks. Press again to cancel the 'repeat all' program.

You can also program up to 20 tracks of the CD in a desired order. With CD playback stopped, press the Program Button (15) once. The "PROG" LED indicator blinks, and the LED display shows the program number.

Press the Previous Track (8) and Next Track (12) Buttons to select a track number. When the desired track number is displayed, press the Program Button to confirm entry. Repeat these steps until all desired tracks are entered. To begin programmed playback, press the Play/Pause Button (11). To cancel programmed playback, press the STOP button twice.

- | | | |
|----------------------------|--------------------------|---|
| 1. Wake Button | 8. Previous Track Button | 15. Program Button |
| 2. Light Button | 9. LED Display | 16. Repeat Button |
| 3. LED Power Indicator | 10. Stop Button | 17. Speakerphone/Voice Control Microphone |
| 4. Power ON/OFF | 11. Play/Pause Button | 18. Voice Control Button |
| 5. Echo Effect Rotary | 12. Next Track Button | 19. Bluetooth Pairing Button |
| 6. Mode Button: CDG/BT/AUX | 13. Master Volume Rotary | 20. CD Compartment |
| 7. Mic Volume Rotary | 14. Auto Voice Control | |

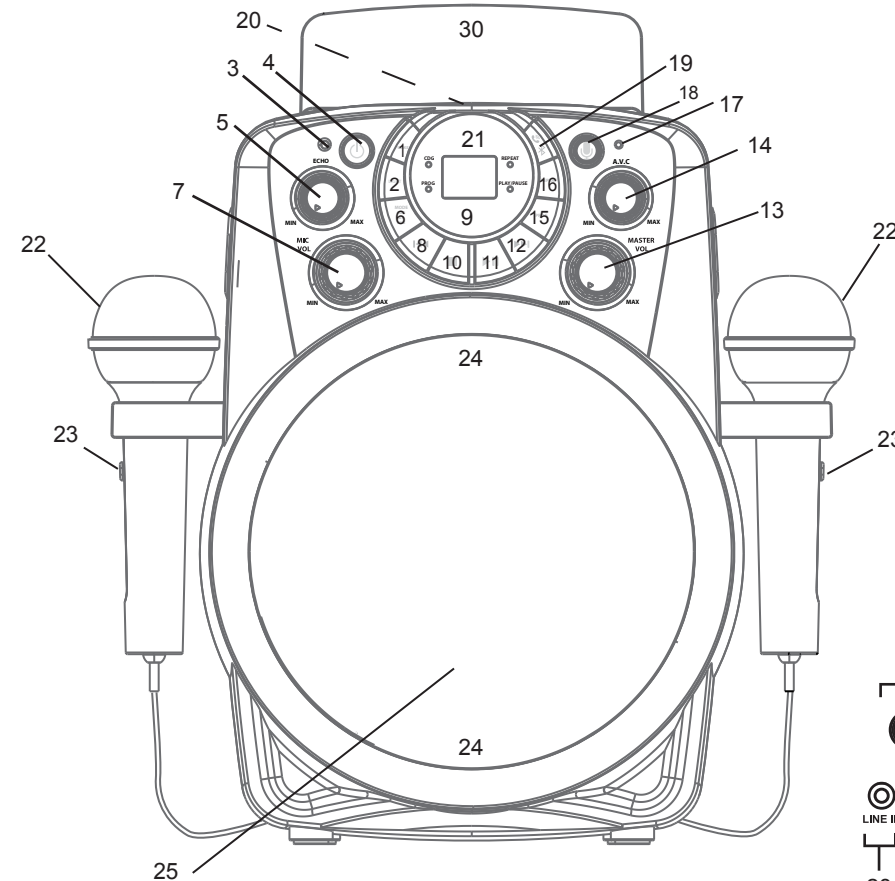

- | |
|---|
| 21. Mode Indicator |
| 22. Microphones |
| 23. Microphone ON/OFF |
| 24. Light Show LEDs |
| 25. Speaker |
| 26. Microphone Jacks |
| 27. RCA Audio/Video Jack |
| 28. AUX-IN Jack |
| 29. DC Power Jack |
| 30. Phone Stand - Not Recommended for Use with Tablets |

Using The Light Button:

By default, the unit will display a repeating light pattern when no music is playing. When music plays, the unit will activate 'beat detection', and lights will pulse along to music.

- Press to turn off speaker lights.
- Press again to return to default setting.

Back of Unit

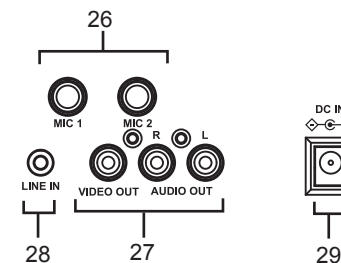

Vocal Effects

Use the Auto Voice Control (14) or the Echo Effect (5) to add vocal effects while you sing! Make sure your microphone is connected to the unit and the microphone switch is turned ON.

Auto Voice Control Dial (For Multiplex CDG discs only):

When playing a Multiplex recording, spin the dial to replace the lead singer's voice with your own!

Echo Effect Rotary Dial:

Spin the dial as you sing to add an echo effect to your voice!

AUX Mode

This unit has an AUX-IN jack, through this jack other audio sources (MP3 players, etc) can be connected to this unit and be amplified.

- Turn on the unit and set the Mode Button to AUX. "AU" will glow solid on the LED screen.
- Connect one end of a 3.5mm audio cable (not included) into the AUX-IN jack and the other end to the headphone jack of your audio device.
- Press PLAY on your audio device to start playback. Control/navigate tracks from your audio device, too.

Pairing Your Device Via Bluetooth

Make sure your Bluetooth device is fully charged. Turn on your Bluetooth device and turn on Bluetooth mode (check in Options or Settings).

- Turn on the unit and set the Mode Button (6) to BT mode. Press the Bluetooth Pairing Button (19). A tone will sound and the LED screen will flash 'bt' as the speaker enters pairing mode.
- "Karaoke 673" should appear on your device's screen. If "Not Connected" or similar message appears, select "Karaoke 673" to connect. If your device asks for a passcode, enter '1234'.
- Once paired, a confirmation tone will sound and 'bt' will glow solid on the LED screen. Put your Bluetooth device in Play mode to stream audio to the speaker. Use your Bluetooth device OR the Play/Pause, Previous Track, and Next Track buttons on the unit to control audio functions.

Voice Control Button / Voice Control App

When the unit is in BT mode, you can access Siri or Google Assistant using voice commands by pressing and holding the Voice Control Button. **This special feature is disabled on the unit when shipped, and requires parental consent to be activated.** To start the one-time activation process, download the free "Voice Control Set Up" app on your smartphone using the App Store or Google Play. Once downloaded and installed on your smartphone, the app will provide prompts to help you set up the Voice Control function.

Speakerphone

When connected via Bluetooth, you can answer and end phone calls. This function is active when the unit is in BT mode.

- When your smartphone receives an incoming call, you will hear it ring through the speaker. Press the Bluetooth Pairing Button (19) to accept the call, and speak into the Speakerphone/ Voice Control Microphone (17).
- To end the call, press the Bluetooth Pairing Button (19) again.

Melody App

The Voice Control Button can also be used to activate Melody, which lets you use voice commands to play any music from iHeartRadio* or Spotify* To use this feature:

- Download the Melody app on your smartphone using the App Store or Google Play.
- Open the app and sign into your iHeartRadio and/or Spotify account within the Melody app.
- With the unit in BT mode, tap the Voice Control Button (18) to activate the Melody app via your paired smartphone. (See Voice Control App instructions above to activate Voice Control on the unit.)
- Once you hear a confirmation tone, speak into the Voice Control Microphone (17) to make your voice commands.
- If music is playing, tap the Voice Control Button (18) once to Pause. After you hear a confirmation tone, speak into the Voice Control Microphone (17) to make your new voice commands.

*iHeartRadio not available in Canada

*Spotify Premium account required