

# HBN20 Staff Quick Start Guide

## Included

- HBN20 system
- Universal AC adaptor

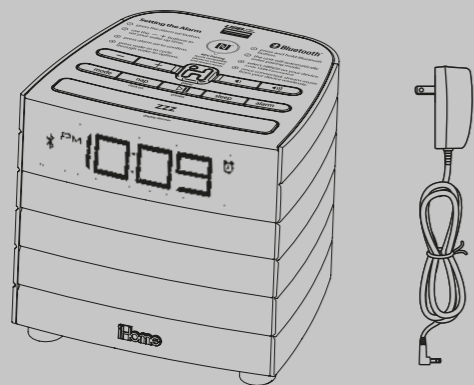

## Set Up

Remove thumbscrew and remove back cover and remove back cover to access staff controls

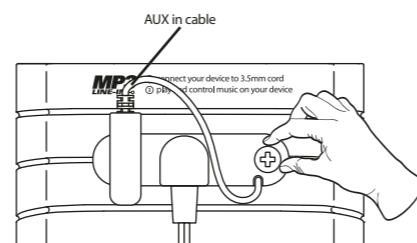

Connect the universal voltage AC adapter to the wall outlet and the DC jack on the back panel of the radio

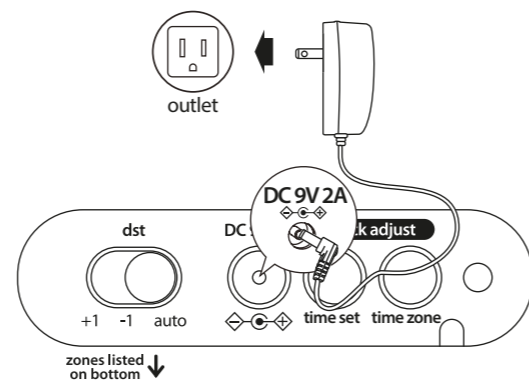

When Low Battery Icon appears on display, replace backup battery with 1 fresh CR2450 battery. Keep unit connected to DC power when replacing battery or you will lose settings.

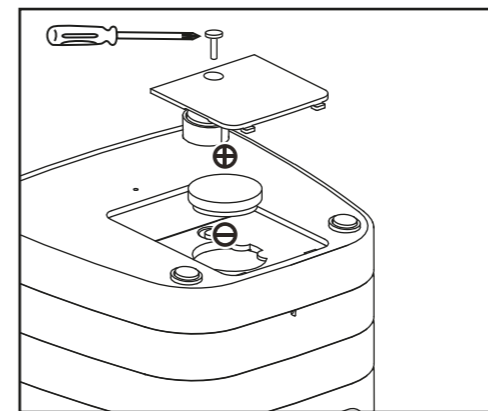

**WARNING:** Lithium batteries can explode or cause burns if disassembled, shorted, recharged, exposed to water, fire, or high temperatures. Do not place loose batteries in a pocket, purse, or other container containing metal objects, mix with used or other battery types, or store with hazardous or combustible materials. Store in cool, dry, ventilated area. Follow applicable laws and regulations for transport and disposal.

Secure the attached Security Tether to a wall or other permanent surface.  
**CAUTION:** DO NOT attach to an AC outlet or cause it to become entangled with anything that can create a hazardous situation.

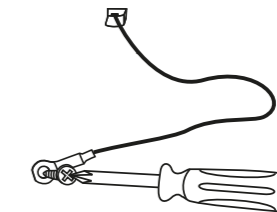

## Daylight Saving Time

The unit ships with the Daylight Saving Time (DST) switch in Auto position, and will automatically adjust when the time changes in March and November.

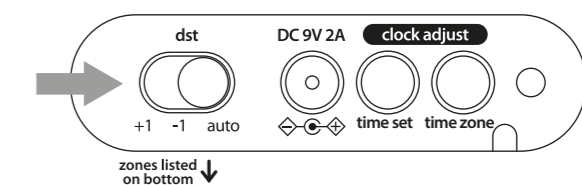

## Setting the Time (Factory Preset Clock)

Including Year, Date, Month: This step would only be required if the pre-set time is lost

### Time Zone Setting

Press and hold the time zone button.

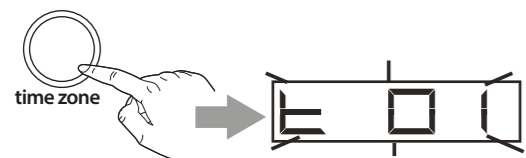

The currently set time zone will flash. Press the - or + button to adjust for your time zone.

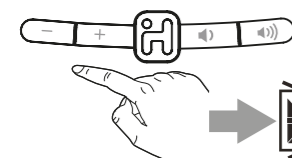

Press the time zone button to confirm

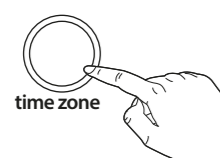

Zones are:  
 00 - ATLANTIC  
 01 - EASTERN  
 02 - CENTRAL  
 03 - MOUNTAIN  
 04 - PACIFIC  
 05 - ALASKA  
 06 - HAWAII

### Clock Setting

Press and hold the time set button to enter clock setting mode

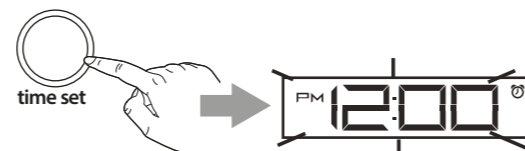

Press the - or + button to adjust time

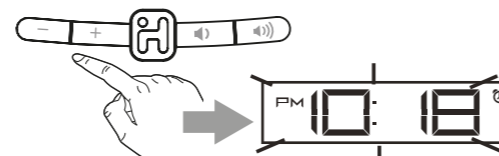

Press the time set button to confirm time

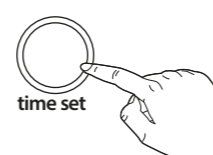

Press the - or + button to set year

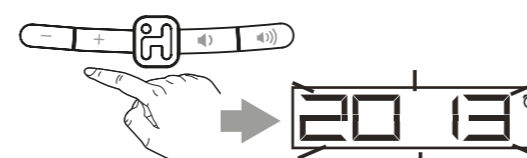

Press the time set button to confirm year

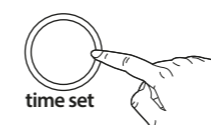

Press the - or + button to set date

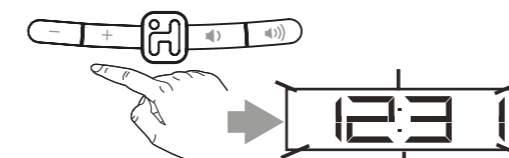

Press the time set button to confirm Clock Setting

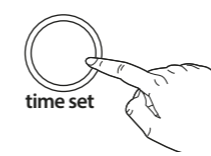

Once staff has completed setup, replace security cover on back of unit and tighten thumbscrew.

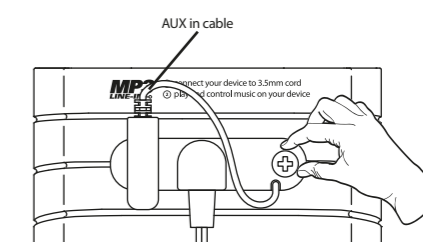

## Maintenance

- Place the unit on a level surface away from sources of direct sunlight or excessive heat.
- Protect your furniture when placing your unit on a natural wood and lacquered finish. A cloth or other protective material should be placed between it and the furniture.
- Clean your unit with a soft cloth moistened only with mild soap and water. Stronger cleaning agents, such as thinner or similar materials can damage the surface of the unit.

HBN20 Legal Sheet - Front  
Size: 108 x 140 mm  
Printing Color: Black  
Mat'l: 100 gsm WF paper  
Oct 15, 2013

## IMPORTANT SAFETY INSTRUCTIONS

When used in the directed manner, this unit has been designed and manufactured to ensure your personal safety. However, improper use can result in potential electrical shock or fire hazards. Please read all safety and operating instructions carefully before installation and use, and keep these instructions handy for future reference. Take special note of all warnings listed in these instructions and on the unit.

- Water and Moisture** – The unit should not be used near water. For example: near a bathtub, washbowl, kitchen sink, laundry tub, swimming pool or in a wet basement.
- Ventilation** – The unit should be situated so that its location or position does not interfere with its proper ventilation. For example, it should not be situated on a bed, sofa, rug or similar surface that may block ventilation openings. Also, it should not be placed in a built-in installation, such as a bookcase or cabinet, which may impede the flow of air through the ventilation openings.
- Heat** – The unit should be situated away from heat sources such as radiators, heat registers, stoves or other appliances (including amplifiers) that produce heat.
- Power Sources** – The unit should be connected to a power supply only of the type described in the operating instructions or as marked on the appliance.
- Power-Cable Protection** – Power supply cables should be routed so that they are not likely to be walked on or pinched by items placed upon or against them. It is always best to have a clear area from where the cable exits the unit to where it is plugged into an AC socket.
- Cleaning** – The unit should be cleaned only as recommended. See the Maintenance section of this manual for cleaning instructions.
- Objects and Liquid Entry** – Care should be taken so that objects do not fall and liquids are not spilled into any openings or vents located on the product.
- Attachments** – Do not use attachments not recommended by the product manufacturer.
- Lightning and Power Surge Protection** – Unplug the unit from the wall socket and disconnect the antenna or cable system during a lightning storm or when it is left unattended and unused for long periods of time. This will prevent damage to the product due to lightning and power-line surges.
- Overloading** – Do not overload wall sockets, extension cords, or integral convenience receptacles as this can result in a risk of fire or electric shock.
- Damage Requiring Service** – The unit should be serviced by qualified service personnel when:
  - the power supply cable or plug has been damaged.
  - objects have fallen into or liquid has been spilled into the enclosure.
  - the unit has been exposed to rain.
  - the unit has been dropped or the enclosure damaged.
  - the unit exhibits a marked change in performance or does not operate normally.
- Periods of Nonuse** – If the unit is to be left unused for an extended period of time, such as a month or longer, the power cable should be unplugged from the unit to prevent damage or corrosion.
- Servicing** – The user should not attempt to service the unit beyond those methods described in the user's operating instructions. Service methods not covered in the operating instructions should be referred to qualified service personnel.

## FCC Information

This device complies with Part 15 of the FCC Rules, operation is subject to the following two conditions: (1) This device may not cause harmful interference, and (2) this device must accept any interference received, including interference that may cause undesired operation.

- Warning: Changes or modifications to this unit not expressly approved by the party responsible for compliance could void the user's authority to operate the equipment.
- NOTE: This equipment has been tested and found to comply with the limits for a Class B digital device, pursuant to Part 15 of the FCC Rules.

These limits are designed to provide reasonable protection against harmful interference in a residential installation. This equipment generates, uses and can radiate radio frequency energy and, if not installed and used in accordance with the instructions, may cause harmful interference to radio communications.

However, there is no guarantee that interference will not occur in a particular installation. If this equipment does cause harmful interference to radio or television reception, which can be determined by turning the equipment off and on, the user is encouraged to try to correct the interference by one or more of the following measures:

- Reorient or relocate the receiving antenna.
- Increase the separation between the equipment and receiver.
- Connect the equipment into an outlet on a circuit different from that to which the receiver is connected.
- Consult the dealer or an experienced radio/TV technician for help.

CAN ICES-3 (B)/NMB-3(B)

Questions? visit [www.hoteltech.com](http://www.hoteltech.com) or call 1-888-744-6835 Toll Free

HBN20 Legal Sheet - Back  
Size: 108 x 140 mm  
Printing Color: Black  
Mat'l: 100 gsm WF paper  
Oct 15, 2013

## LIMITED 30 DAY WARRANTY (valid in contiguous U.S.A. only; not valid in Hawaii or Alaska)

Hotel Technologies, a division of HTI Industries LLC, (hereafter referred to as Hotel Technologies), warrants this product to be free from defects in workmanship and materials, under normal use and conditions, for a period of 30 days from the date of receipt of the item.

Should service be required by reason of any defect or malfunction during the warranty period, Hotel Technologies will repair or, at its discretion, replace this product without charge. This decision is subject to verification of the defect or malfunction upon delivery of this product to the Factory Service Center listed below. Before returning this product for service, please first replace the batteries (if applicable) with fresh ones, as exhausted or defective batteries are the most common cause of problems encountered.

If service is still required:

- Fax a representative at 915.633.1388 with a Return Authorization request including proof of purchase date (i.e., invoice number and date from distributor or HTI) to receive a Return Authorization Number. Issuance of Return Authorization Number is subject to review prior to granting.

**NO ITEM CAN BE ACCEPTED WITHOUT A RETURN AUTHORIZATION NUMBER.**

- Remove batteries (if applicable) and pack the unit in a well-padded, heavy corrugated box.
- Send the unit by method agreed to with your representative to the Factory Service Center listed below:

### Consumer Repair Department

Hotel Technologies Inc.  
1330 Goodyear Drive  
El Paso TX 79936-6420

**NOTE: Improperly packed items or Items received without an RA # cannot receive credit.**

**NOTE:** This warranty is valid only if the product is used for the purpose for which it was designed. It does not cover (i) products which have been damaged by negligence, misuse or accident, or which have been modified or repaired by unauthorized persons; (ii) cracked or broken cabinets, or units damaged by excessive heat; (iii) damage to tape cassettes (if applicable); (iv) the cost of shipping this product to the Factory Service Center and its return to the owner.

This warranty is valid only in the United States of America and does not extend to owners of the product subsequent to the original purchaser. Any applicable implied warranties are also limited to 30 days, and Hotel Technologies will not be liable for consequential damages. (Some states do not allow limitations on implied warranties or exclusion of consequential damages, so these restrictions may not apply to you.) This warranty gives you specific legal rights, and you may also have other rights which vary from state to state.

**If you did not purchase this product directly from Hotel Technologies,  
please contact the appropriate distributor for their warranty terms**

### IC Statement for RF Device

This device complies with Industry Canada licence-exempt RSS standard(s). Operation is subject to the following two conditions: (1) this device may not cause interference, and (2) this device must accept any interference, including interference that may cause undesired operation of the device.

Le présent appareil est conforme aux CNR d'Industrie Canada applicables aux appareils radio exempts de licence. L'exploitation est autorisée aux deux conditions suivantes : (1) l'appareil ne doit pas produire de brouillage, et (2) l'utilisateur de l'appareil doit accepter tout brouillage radioélectrique subi, même si le brouillage est susceptible d'en compromettre le fonctionnement.

The device meets the exemption from the routine evaluation limits in section 2.5 of RSS 102 and compliance with RSS-102 RF exposure, users can obtain Canadian information on RF exposure and compliance.

Le dispositif rencontre l'exemption des limites courantes d'évaluation dans la section 2.5 de RSS 102 et la conformité à l'exposition de RSS-102 rf, utilisateurs peut obtenir l'information canadienne sur l'exposition et la conformité de rf.

HBN20LS-131015-A

© 2013 HTI Industries, LLC. All rights reserved

Printed in China