

HDL50 Staff Quick Start Guide

Included

- HDL50 system
- 100V-240V universal AC adaptor

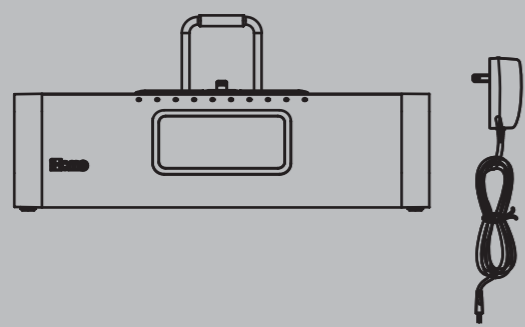

Set Up

Remove thumbscrew and remove back cover to access staff controls

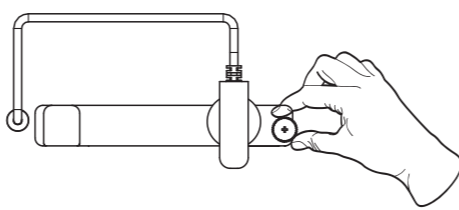

Connect AC adaptor to DC jack/wall outlet

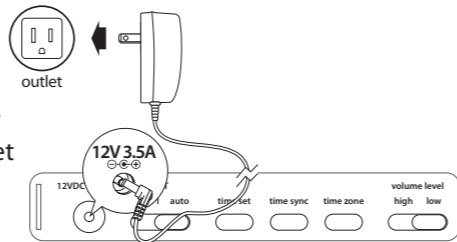

Remove pull tab from Backup Battery Compartment located on bottom of the unit. When Low Battery Icon appears on display, replace backup battery with 1 fresh CR2450 battery. Keep unit connected to power when replacing battery or you will lose settings.

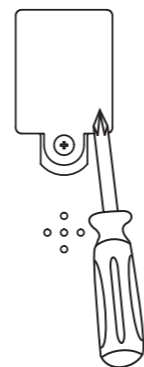

Secure the attached Security Tether to a wall or other permanent surface.
CAUTION: DO NOT attach to an AC outlet or cause it to become entangled with anything that can create a hazardous situation.

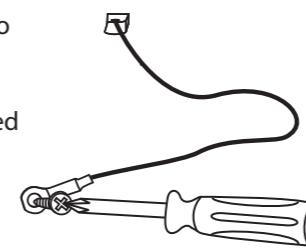

Setting Clock Using Time Sync

a) Connect a Lightning-compatible iPhone to the Dock

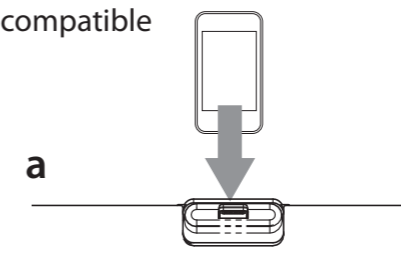

Or

b) connect any iPhone to the USB port using the USB cable that came with it

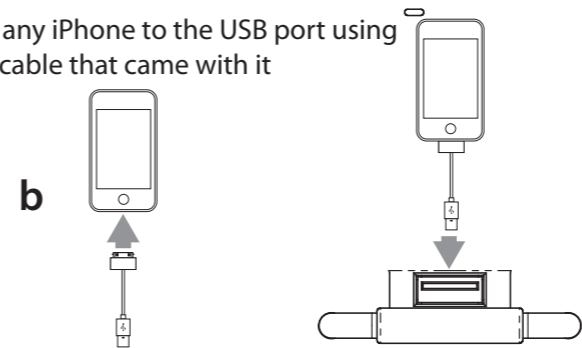

Press the Time Sync Button on the back of the unit to instantly set the time on the HDL50.

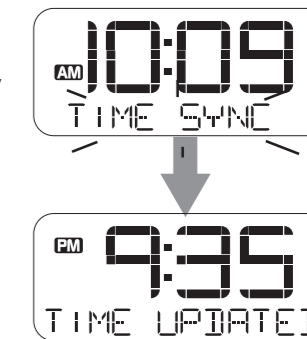
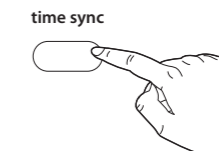

NOTE: For the fastest, most accurate time setting, set the clock using Time Sync with
 a) a docked iPhone *OR*
 b) an iPhone connected to the USB port
 iPhone time is always current because it pings off cell towers; iPad or iPod are only accurate to the last time they were synced to a computer.

Make sure the DST switch is in AUTO position. If you do not have an iPhone or if time sync fails, set the clock manually.

Daylight Saving Time

The unit ships with the Daylight Saving Time (DST) switch in Auto position, and will automatically adjust when the time changes in March and November.

Manual Clock Setting

Press and hold the Time Set Button



Press the ◀ or ▶ button to set time



Press the Time Set Button



Press the ◀ or ▶ button to set year



Press the Time Set Button

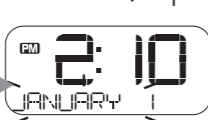

Press the ◀ or ▶ button to set date



Press the Time Set Button to confirm Clock Setting



Beep
Beep

Setting 12/24 Hour Time Display

Press and hold the Time Set Button

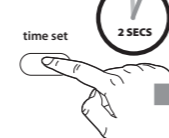

To toggle time display between 12 or 24 hours, press alarm set button

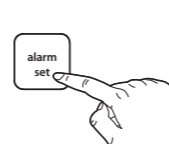

Press the Time Set Button to confirm

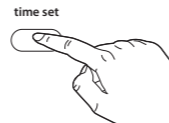

Beep
Beep

FM Radio

Press function Button as needed to cycle to FM mode



Press the ◀ or ▶ button to tune to a desired station (hold to search for next clear station)



FM Presets

Press FM presets Button to cycle to the preset (P1- P6) you wish to set

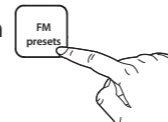

Press and hold FM presets Button to confirm preset number



Press the ◀ or ▶ button to select station to preset



Press FM presets Button to confirm

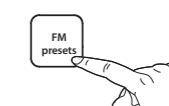

Beep
Beep

Follow steps above to set all 6 FM presets

Once staff has completed setup, replace security cover on back of unit and tighten thumbscrew.