

iBN26A IB-r
Size: 153mm x 120mm
Printing color: Black
July 23, 2012
P16

P1

iHome®



iBN26A

***NFC Bluetooth Wireless
Stereo Speaker System
with Speakerphone
and USB Charging***



instruction manual

iBN26A

Introduction

Thank you for purchasing the iHome **iBN26A**. This product is designed to provide high quality wireless sound for your iPad, iPhone, iPod, computer, or other Bluetooth audio device.

Along with the included Quick Bluetooth Connection Guide this instruction booklet explains the basic operation and care of the unit. Please read them carefully and keep for future reference.

This unit features NFC (near field communication) technology which allows you to wirelessly connect your NFC-enabled device to instantly 'pair and play'. See your device's user manual for details on how to interact with NFC devices. If your Bluetooth device does not support NFC, you can pair it manually with this unit.

Maintenance

- Place the unit on a level surface away from sources of direct sunlight or excessive heat.
- Protect your furniture when placing your unit on a natural wood and lacquered finish. A cloth or other protective material should be placed between it and the furniture.
- Clean your unit with a soft cloth moistened only with mild soap and water. Stronger cleaning agents, such as benzene, thinner or similar materials can damage the surface of the unit.

FCC Information

FCC Radiation Exposure Statement

This equipment complies with FCC RF radiation exposure limits set forth for an uncontrolled environment.

This Device complies with RSS-210 of the IC Rules; Operation is subject to the following two conditions:

- (1) This device may not cause interference and
- (2) This device must accept any interference received, including interference that may cause undesired operation

This device complies with Part 15 of the FCC Rules, operation is subject to the following two conditions: (1) This device may not cause harmful interference, and (2) this device must accept any interference received, including interference that may cause undesired operation.

- Warning: Changes or modifications to this unit not expressly approved by the party responsible for compliance could void the user's authority to operate the equipment.
- NOTE: This equipment has been tested and found to comply with the limits for a Class B digital device, pursuant to Part 15 of the FCC Rules. These limits are designed to provide reasonable protection against harmful interference in a residential installation. This equipment generates, uses and can radiate radio frequency energy and, if not installed and used in accordance with the instructions, may cause harmful interference to radio communications. However, there is no guarantee that interference will not occur in a particular installation. If this equipment does cause harmful interference to radio or television reception, which can be determined by turning the equipment off and on, the user is encouraged to try to correct the interference by one or more of the following measures:
 - Reorient or relocate the receiving antenna.
 - Increase the separation between the equipment and receiver.
 - Connect the equipment into an outlet on a circuit different from that to which the receiver is connected.
 - Consult the dealer or an experienced radio/TV technician for help.

This Class B digital apparatus complies with Canadian ICES-003.

Cet appareil numérique de la classe B est conforme à la norme NMB-003 du Canada.

IC Statement

This device complies with Industry Canada RSS-210. Operation is subject to the following two conditions: (1) this device may not cause interference, and (2) this device must accept any interference, including interference that may cause undesired operation of the device.

Le présent appareil est conforme aux CNR d'Industrie Canada applicables aux appareils radio RSS-210. L'exploitation est autorisée aux deux conditions suivantes : (1) l'appareil ne doit pas produire de brouillage, et (2) l'utilisateur de l'appareil doit accepter tout brouillage radioélectrique subi, même si le brouillage est susceptible d'en compromettre le fonctionnement.

The device meets the exemption from the routine evaluation limits in section 2.5 of RSS 102 and compliance with RSS-102 RF exposure, users can obtain Canadian information on RF exposure and compliance.

Le dispositif rencontre l'exemption des limites courantes d'évaluation dans la section 2.5 de RSS 102 et la conformité à l'exposition de RSS-102 rf, utilisateurs peut obtenir l'information canadienne sur l'exposition et la conformité de rf.

iBN26A
FCC ID:EMOiBN26A
IC:986B-iBN26A

QDID:B020415

iBN26A

Table of Contents

Included/ Meet Your iBN26A	1-2
Setting Up the Unit/ Turning the Unit ON and OFF.....	3
Using Bluetooth: Pairing Your Device Using NFC	4
Pairing Your Device using Bluetooth.....	5
Playing Audio Via Bluetooth.....	6
Using the Speakerphone feature.....	7
Playing Audio Via Aux line-in	7
Charging Via USB Port.....	8
Consumer Product Safety Guide	9-10
Troubleshooting.....	11
Warranty.....	12

iBN26A

Included

- iBN26A Speaker
- 100V-240V universal AC adaptor
- Stereo 3.5 mm audio cable

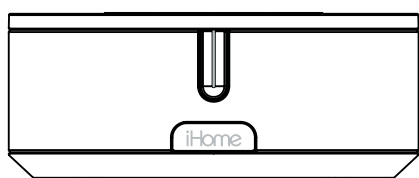

iBN26A Speaker

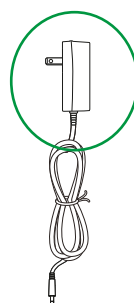

power adaptor



audio cable

Meet Your iBN26A

iBN26A

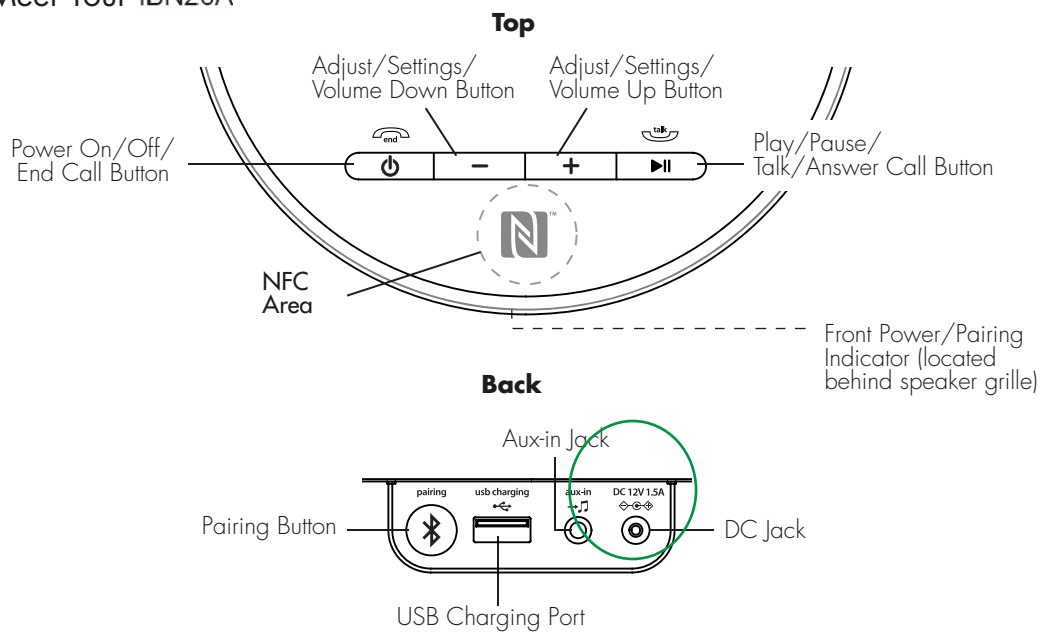

Using the iBN26A

Setting Up the Unit

1. Connect the included AC adaptor to the DC jack located on the back of the unit and connect the other end to a working wall outlet.

Turning the Unit ON and OFF

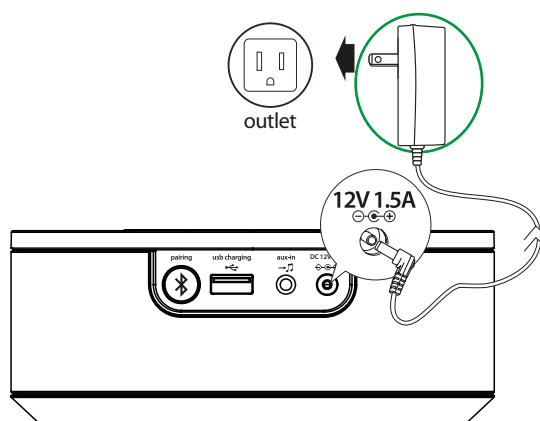

1. Once the AC adaptor is properly connected, press the **Power Button** located on top of the unit to turn the unit ON. The power indicator on the front LED & top buttons of the unit will light and ascending tones will sound.
2. Press the **Power Button** to turn the unit OFF. Descending tones will sound.



Using the iBN26A

Using Bluetooth: Pairing and Playing Your Device Using NFC

This unit features wireless NFC pairing, which allows playing NFC-enabled devices to pair and play instantly. For pairing non-NFC devices, please see the following section "Pairing Your Device Manually".

1. Turn on your Bluetooth-enabled/NFC-enabled device and turn on Bluetooth capability as described in the device's user manual.
2. Place your NFC-enabled device in play mode.
3. Touch the  area of your playing NFC device against the  area on top of the unit. The unit will turn on and enter automatic pairing mode, tones will sound and the light will flash blue while the unit attempts to pair. "iHome iBN26A" should appear on your device's menu. If your device asks if you wish to pair, accept (select "Yes" or similar). Once paired with a device, the blue indicator light will glow steadily, a confirmation tone will sound and your music will play through the unit.
4. Use the controls on your device to play or pause audio and navigate tracks.
5. Press the **- Button** or **+ Button** to adjust the volume on the unit. You can also adjust volume on your device.
6. When done listening, press the  **Power Button** to turn the unit OFF. Remember to turn off your audio device, too.

NOTE: To disconnect your device, simply touch it again on the  area of the unit. To pair a device manually, please see the following "Pairing Your Device Manually" section.

Using the iBN26A

Using Bluetooth: Pairing Your Device Manually

NOTE: See the **iBN26A** Bluetooth Connection Guide for complete pairing details.

1. Turn on your Bluetooth-enabled device and turn on Bluetooth capability as described in the device's user manual.
2. *Press and hold* the **Pairing Button** (located on the back of the unit) for 2 seconds. The unit will turn on and enter pairing mode, 2 tones will sound and the indicator light on front of the unit will flash blue while the unit attempts to pair. "iHome **iBN26A**" should appear on your device's menu. If "Not Paired, "Not Connected" or similar message appears, select "iHome **iBN26A**" on device to begin/complete pairing. If your device asks for a password, enter **1234** on the keyboard of your device. If no device is paired within 2 minutes, the unit will revert to its previous state. To retry pairing, follow steps 1 & 2.
3. Once paired with a device, the blue indicator light will glow steadily and a confirmation tone will sound. There should be an indication on your device that pairing is complete. On some devices, you must then select "Use as Audio Device (stereo)" or similar on the device's Bluetooth menu. Once paired, your device should link to the **iBN26A** whenever within range.

Using the iBN26A

Pairing with a Different Device

When you power ON the speaker, it will automatically link with the previously paired Bluetooth device as long as that device is still within range (about 30 feet). To pair with a different device, follow steps 1 & 2 on page 5.

Playing Audio Via Bluetooth

1. Press the **⏻ Power Button** to turn on the unit. The light on front of the unit will flash blue and ascending tones will sound and the unit will search for a previously paired device. The light will turn solid blue once a previously paired device is detected. You can then listen to audio streamed wirelessly from your paired iPad, iPhone, iPod or other Bluetooth device.
2. Press the **▶|| Play Pause Button** on the unit to play audio from your linked Bluetooth device. While audio is playing, press to pause play, and again to resume play.
3. Adjust the volume on the unit by pressing the **- Button** or **+ Button**. The front panel LED blinks 3x when unit is at maximum volume. You can also adjust volume on your device.
4. When done listening, press the **⏻ Power Button** to turn the unit OFF.

Note: Audio playing through the unit via the Bluetooth will be interrupted whenever the aux in audio is detected.

Using the iBN26A

Using the Speakerphone feature

NOTE: The unit does NOT have to be powered on to receive a call. A Bluetooth phone must be linked.

1. When a call is received, playing music is muted to hear the ring tone. Press the **Talk Button** (▶||) to answer the call, or press the **End Button** (⏻) to ignore it. For call waiting function, press the **Talk Button** (▶||) to place a currently active call on hold and answer a new call; press the **Talk Button** (▶||) to switch between the calls.
2. When a call is completed, press the **End Button** (⏻) to end the call and resume previous function.

Playing Audio via Aux In

1. Connect one end of the included 3.5mm stereo audio cable to the Aux in jack on the back of the unit and connect the other end to the headphone or line-out jack on your audio device.
2. Press the **Power Button** on the unit to turn it on.
3. Power on the audio device and use the controls on the device to play or pause audio, and navigate tracks.
4. Adjust the volume on the unit by pressing the **- Button** or **+ Button**. You can also adjust volume on your device.
5. When done listening, press the **Power Button** to turn the unit OFF. Remember to turn off your audio device, too.

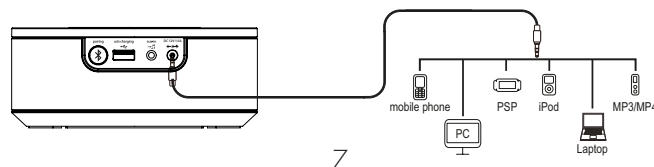

Using the iBN26A

Charging Devices via USB Port

1. Connect the standard size end of a USB cable (not included) to the USB Port on back of the unit and connect the other end to the charging port on your device.
2. Monitor the charging on your device. Some devices use a proprietary charging method and will not charge using the USB Port. If this happens, you must charge your device using the charger that came with it.

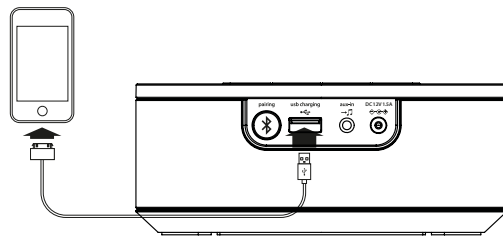

Consumer Product Safety Guide

IMPORTANT SAFETY INSTRUCTIONS

When used in the directed manner, this unit has been designed and manufactured to ensure your personal safety. However, improper use can result in potential electrical shock or fire hazards. Please read all safety and operating instructions carefully before installation and use, and keep these instructions handy for future reference. Take special note of all warnings listed in these instructions and on the unit.

1. **Water and Moisture** – The unit should not be used near water. For example: near a bathtub, washbowl, kitchen sink, laundry tub, swimming pool or in a wet basement.
2. **Ventilation** – The unit should be situated so that its location or position does not interfere with its proper ventilation. For example, it should not be situated on a bed, sofa, rug or similar surface that may block ventilation openings. Also, it should not be placed in a built-in installation, such as a bookcase or cabinet, which may impede the flow of air through the ventilation openings.
3. **Heat** – The unit should be situated away from heat sources such as radiators, heat registers, stoves or other appliances (including amplifiers) that produce heat.
4. **Power Sources** – The unit should be connected to a power supply only of the type described in the operating instructions or as marked on the appliance.
5. **Power-Cable Protection** – Power supply cables should be routed so that they are not likely to be walked on or pinched by items placed upon or against them. It is always best to have a clear area from where the cable exits the unit to where it is plugged into an AC socket.
6. **Cleaning** – The unit should be cleaned only using a warm damp cloth. Do not use solvents, etc.
7. **Objects and Liquid Entry** – Care should be taken so that objects do not fall and liquids are not spilled into any openings or vents located on the product.

8. **Attachments** – Do not use attachments not recommended by the product manufacturer.
9. **Lightning and Power Surge Protection** – Unplug the unit from the wall socket and disconnect the antenna or cable system during a lightning storm or when it is left unattended and unused for long periods of time. This will prevent damage to the product due to lightning and power-line surges.
10. **Overloading** – Do not overload wall sockets, extension cords, or integral convenience receptacles as this can result in a risk of fire or electric shock.
11. **Damage Requiring Service** – The unit should be serviced by qualified service personnel when:
 - A. the power supply cable or plug has been damaged.
 - B. objects have fallen into or liquid has been spilled into the enclosure.
 - C. the unit has been exposed to rain.
 - D. the unit has been dropped or the enclosure damaged.
 - E. the unit exhibits a marked change in performance or does not operate normally.
12. **Periods of Nonuse** – If the unit is to be left unused for an extended period of time, such as a month or longer, the power cable should be unplugged from the unit to prevent damage or corrosion.
13. **Servicing** – The user should not attempt to service the unit beyond those methods described in the user's operating instructions. Service methods not covered in the operating instructions should be referred to qualified service personnel.

Questions? Visit www.ihome.com
or call 1-800-288-2792 Toll Free

Troubleshooting

Unit doesn't respond (no power)

- Check that all connections are correct and properly plugged in.
- Make sure your device is properly paired with the **iBN26A**
- Make sure the **Power** is ON, indicated by lit up buttons.

Unit doesn't respond

- If the unit appears to be "frozen" or locked up, you may need to reset it. To do so, *press and hold the - Button and + Button at the same time for 5 seconds*. A white light on the front of the unit will flash rapidly 5 times to indicate the unit has been reset. Once reset, all previous settings are erased and you will need to adjust them and re-pair with your Bluetooth devices.

Trouble pairing device/computer with iBN26A

Bluetooth implementation varies depending on your device's hardware and operating system. Please see our website for updates on pairing.

- If auto "Pair and play" on your NFC-enabled device fails, make sure Bluetooth is turned on **and screen** is active (not dark) on NFC device. If pairing still fails, try to pair manually by pressing and holding the Pairing Button on the back of the unit for 3 seconds.
- Make sure you have the latest firmware for your device.
- Make sure your device is working properly. Check your device's manual for details on Bluetooth pairing and linking.
- If Bluetooth connection is interrupted by disconnecting the unit from AC power, the Bluetooth icon may remain on the device's menu for up to 20 seconds.

For further information and to see the latest instructions, visit www.ihome.com/support

Limited 1 Year Warranty

iHome Products, a division of SDI Technologies Inc. (hereafter referred to as SDI), warrants this product to be free from defects in workmanship and materials, under normal use and conditions, for a period of one (1) year from the date of original purchase.

Should this product fail to function in a satisfactory manner, it is best to first return it to the store where it was originally purchased. Should this fail to resolve the matter and service still be required by reason of any defect or malfunction during the warranty period, SDI will repair or, at its discretion, replace this product without charge. This decision is subject to verification of the defect or malfunction upon delivery of this product to the Factory Service Center authorized by SDI Customer Service. The product must include proof of purchase, including date of purchase. An out-of-warranty fee for service will be charged for units that are received without proof of purchase.

Before returning this product for service, please first replace the batteries (if applicable) with fresh ones, as exhausted or defective batteries are the most common cause of problems encountered.

If service is still required:

1. Call SDI Customer Service at 1-800-288-2792 for Return Authorization and for the address of the Factory Service Center.
2. Remove the batteries (if applicable) and pack the unit in a well padded, heavy corrugated box. SDI is not responsible for damage that occurs during shipping to the Factory Service Center.
3. Enclose a photocopy of your sales receipt, credit card statement, or other proof of the date of purchase, if within the warranty period. Also include your name and address information, a brief description for why the unit is being returned, and the return authorization number. No unit can be processed without a return authorization number.
4. Write the return authorization number on the side of the shipping package and send the unit prepaid and insured to the Factory Service Center address authorized by SDI Customer Service.

Disclaimer of Warranty

NOTE: This warranty is valid only if the product is used for the purpose for which it was designed. It does not cover (i) products which have been damaged by negligence or willful actions, misuse or accident, or which have been modified or repaired by unauthorized persons; (ii) cracked or broken cabinets, or units damaged by excessive heat; (iii) damage to digital media players, CD's or tape cassettes (if applicable); (iv) the cost of shipping this product to the Factory Service Center and its return to the owner. This warranty is valid only in the United States of America and does not extend to owners of the product other than to the original purchaser. In no event will SDI or any of its affiliates, contractors, resellers, their officers, directors, shareholders, members or agents be liable to you or any third party for any consequential or incidental damages, any lost profits, actual, exemplary or punitive damages. (Some states do not allow limitations on implied warranties or exclusion of consequential damages, so these restrictions may not apply to you.) This warranty gives you specific legal rights, and you may also have other rights which vary from state to state.

Your acknowledgment and agreement to fully and completely abide by the above mentioned disclaimer of warranty is contractually binding to you upon your transfer of currency (money order, cashier's check, or credit card) for purchase of your SDI product.

© 2013 SDI Technologies, Inc. All rights reserved
Questions? Visit www.ihome.com
or call 1-800-288-2792 Toll Free

iBN26A-071513A

Printed in China