

iBT232 Eng IB
Size: 153mm x 120mm
Printing color: Black
Nov 9, 2016

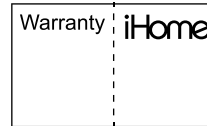

P1

iHome®



Model: iBT232
Bluetooth
FM Clock Radio
with USB Charging



instruction manual

Questions? Contact Customer Service at 1-800-288-2792

iBT232

Introduction

Thank you for purchasing the iHome iBT232. This product is designed to provide high quality wireless sound for your Bluetooth audio device.

This instruction booklet explains the basic operation and care of the unit. Please read it carefully and keep for future reference.

Maintenance

- Place the unit on a level surface away from sources of direct sunlight or excessive heat.
- Protect your furniture when placing your unit on a natural wood and lacquered finish. A cloth or other protective material should be placed between it and the furniture.
- Clean your unit with a soft cloth moistened only with mild soap and water. Stronger cleaning agents, such as benzene, thinner or similar materials can damage the surface of the unit.

iBT232

Table of Contents

| | |
|--|-----|
| What's Included | 3 |
| Meet Your iBT232..... | 4 |
| The Display/Setting Up the Unit..... | 5 |
| Installing and Replacing Clock Backup Batteries..... | 6 |
| Setting the Clock/Setting and Using the Alarms..... | 7-8 |
| Previewing the Alarm and Turning the Alarm On/Off..... | 8 |
| Snooze/Display Dimmer Button/Sleep Mode/FM Radio | 9 |
| Setting and Using FM Presets | 10 |
| Pairing Your Bluetooth Device | 11 |
| Playing Audio Via Bluetooth | 12 |
| Using the Speakerphone Feature | 12 |
| Playing Audio via Aux-In | 13 |
| Charging Devices via USB Port..... | 14 |
| Battery Use Cautions and Tips..... | 15 |
| Consumer Product Safety Guide | 16 |
| FCC Information | 17 |
| Troubleshooting..... | 18 |
| Warranty..... | 19 |

What's Included

- iBT232 unit
- 100V-240V universal AC adapter
- 2 AA batteries



iBT232

3

iBT232

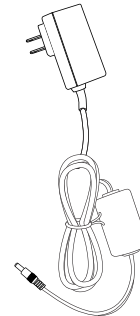

power adapter

Meet Your iBT232

iBT232

Top

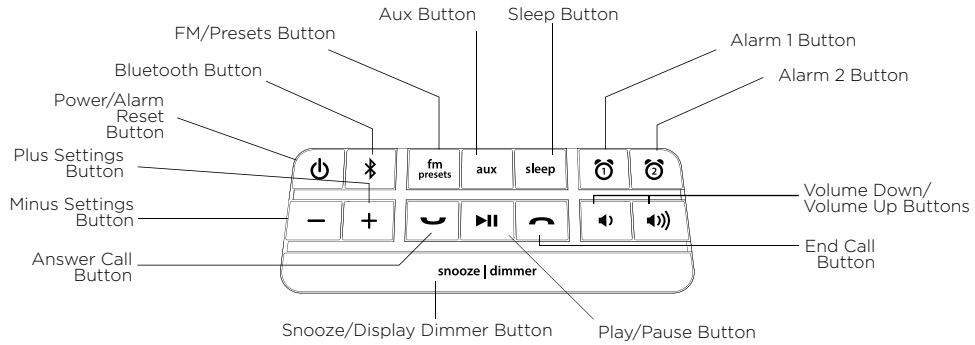

Back

Backup Battery Compartment

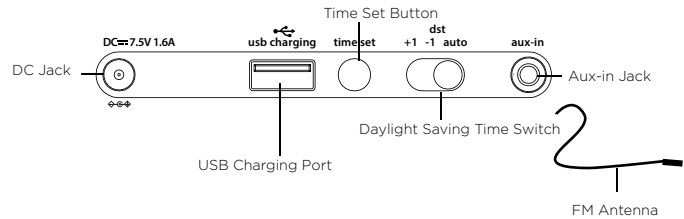
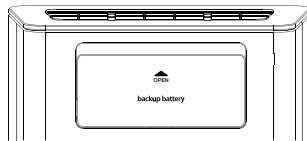

Using the iBT232

The Display

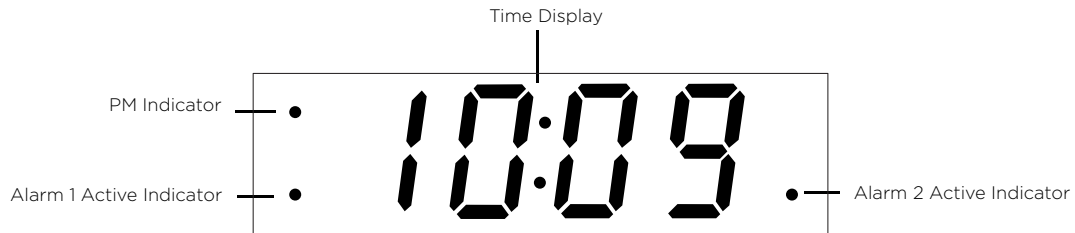

Setting Up the Unit

Connect the included AC adapter to the DC jack located on the back of the unit and connect the other end to a working wall outlet that is not controlled by a switch. Extend FM antenna.

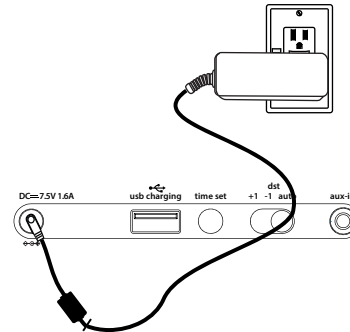

Using the iBT232

Installing and Replacing Clock Backup Batteries

Note: 2 AA batteries are included with the unit. Install batteries before using the unit.

This model is equipped with a battery backup circuit that will maintain the time and alarm time settings in the event of a temporary power interruption. The battery backup circuit will also operate the buzzer alarm to wake you up at the selected wake up time even if the power is out. When the backup battery is getting weak or isn't present, "LO BATT" will flash twice in the display when the unit is powered on. When you see this flashing indicator you should replace the backup batteries as soon as possible.

To install/replace the backup batteries:

IMPORTANT: When replacing the backup batteries be sure to have the unit connected to the AC outlet to maintain all of your settings, otherwise it will be necessary to reset the time and alarm time after the batteries are replaced.

1. Press upwards on the battery compartment door to release it.
2. Insert 2 fresh AA batteries in the backup battery compartment as shown. Make sure polarity (+/-) matches illustration.
3. Close the battery compartment door. Confirm that "LO BATT" battery indicator is not flashing in the display by powering unit on.

Note: Make sure you dispose of batteries properly (see your local regulations).

Installing/Replacing Backup Batteries

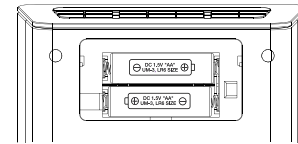

Using the iBT232

Setting the Clock

This unit has a **Daylight Saving Time (DST) Switch** located on the back of the cabinet. By default, it is set to auto and will automatically adjust the time at the start and end of daylight saving time. If your location does not observe daylight saving time or you wish to manually adjust, move the switch to +1 to add an hour or to -1 to subtract an hour.

1. *Press and hold* the **Time Set Button** located on back of the unit for 2 seconds until the clock display flashes and a beep sounds.
2. Press the **—** or **+ Buttons** to adjust the clock to the current time (hold for rapid setting). Make sure you set the correct AM/PM time. The PM indicator appears to the left of the display; there is no AM indicator.
3. Press the **Time Set Button** to confirm the time. The year will flash on the display.
4. Press the **—** or **+ Buttons** to adjust the clock to the current year (hold for rapid setting).
5. Press the **Time Set Button** to confirm the year. The month will flash on the display.
6. Press the **—** or **+ Buttons** to adjust the clock to the current month (hold for rapid setting).
7. Press the **Time Set Button** to confirm the month. The date will flash on the display.
8. Press the **—** or **+ Buttons** to adjust the clock to the current date (hold for rapid setting).
9. Press the **Time Set Button** to confirm the date and exit clock setting mode. 2 beeps will confirm clock setting is complete.

TIP: To toggle the clock display between standard 12 hour time and 24 hour (“military”) time display, press the **Alarm Button** or **Alarm Button** while the display is flashing during clock setting.

Setting and Using the Alarms

This unit features dual alarms which can be set to different times and alarm sources. Each is set in the same way. Instructions are given as “Alarm Button”; use **Alarm Button** or **Alarm Button** to set respective alarms.

Note: Each step must be completed while display is flashing or step will time-out with any changes saved.

Using the iBT232

Setting and Using the Alarms (Continued)

1. *Press and hold* the **Alarm Button** for 2 seconds until the alarm time display, alarm button and alarm icon flash. A beep sounds.
2. Press the **–** or **+ Buttons** to adjust the alarm time to the desired time (hold for rapid setting). Make sure you set the correct AM/PM alarm time. The PM indicator appears to the left of the display; there is no AM indicator.
3. Press the **Alarm Button** to confirm the alarm time setting. The alarm schedule will flash.
4. Press the **–** or **+ Buttons** to cycle to the desired schedule: “7 d” (every day), “5 d” (week days) or “2 d” (weekends).
5. Press the **Alarm Button** to confirm the alarm schedule setting. The wake-to source will flash.
6. Press the **–** or **+ Buttons** to select the desired wake to alarm source: Bluetooth, FM radio or selected tone.

Wake to Bluetooth: You will wake to the currently linked Bluetooth device. If no device is detected at wake time, the alarm will default to tone one (“t1”).

Wake to Radio: Press the **Alarm Button** to confirm. Press the **Presets Button** to select an FM preset to wake to, or press the **–** or **+ Buttons** to tune in a desired wake to station. (To set Presets, see *Setting and Using FM Presets* on page 10.)

Wake to Tones: You will wake to the selected tone. Press the **Alarm Button** to confirm, then press the **–** or **+ Buttons** to preview and select a desired tone (t1 -t4).
7. Press the **Alarm Button** to confirm the wake to source. The alarm volume will flash.
8. Press the **–** or **+ Buttons** to select the desired alarm volume.
9. Press the **Alarm Button** to complete alarm setting and exit alarm setting mode. 2 beeps will confirm alarm setting is complete. The alarm icon will remain on the display, indicating the alarm is armed.
8. To turn off a sounding alarm and reset it to come on the next day at the same time, press the **⏻ Power Button** or the associated alarm button (**⏻** or **⏻**) to reset alarm.

Previewing the Alarm and Turning the Alarm On/Off

Press and release the desired Alarm Button as needed to preview current alarm time/ toggle the alarm ON (indicated by the alarm icon and lit alarm button) or OFF (no alarm icon/alarm button is not lit).

Using the iBT232

Snooze/Display Dimmer Button

1. While the alarm is sounding, press and release the **Snooze/Display Dimmer Button** to temporarily silence the alarm for the set duration (9 minutes is the default). Snooze can be used several times during alarm.
2. To adjust the brightness of the display, press and release the **Snooze/Display Dimmer Button** during normal operation (when no alarm is sounding) to cycle through the brightness display settings, including turning the display off.
3. To program Snooze, press and hold the **Snooze/Display Dimmer Button** for 2 seconds during normal operation (when no alarm is sounding). A beep will sound.
4. Press the **–** or **+** **Buttons** to select the desired snooze time (between 1 and 29 minutes).
5. Press and release the **Snooze/Display Dimmer Button** to confirm Snooze setting. 2 beeps will sound.

Sleep Mode

This unit allows you to sleep to the current sound source for a set time before turning the unit off.

1. To set Sleep time, press and release the **Sleep/Clock Adjust Button** as needed to cycle to the desired sleep duration: 120, 90, 60, 30 or 15 minutes or OFF (turns the unit off).
2. Press the **◀** or **▶** **Buttons** to adjust the sleep volume on the unit. Note that the sleep volume setting is stored separately from other volume settings.

FM Radio

Extend the FM antenna for best reception.

1. Press and release the **FM Presets Button**. The current FM radio frequency appears on the display.
2. Press the **–** or **+** **Buttons** to tune the radio to the desired station (hold to scan for the next clear station).
3. Press the **◀** or **▶** **Buttons** to adjust the volume on the unit.
4. When you are through listening, press the **⏻ Power Button** to turn the unit off.

Using the iBT232

Setting and Using FM Presets

The unit allows you to store up to 6 FM radio station presets

1. Press and release the **FM Presets Button**. The FM current FM station frequency appears on the display.
2. Press and release the **FM Presets Button** as needed until the preset number (P1- P6) you wish to set is displayed, then press and hold the **FM Presets Button** to enter setting mode.
3. Press the **–** or **+** **Buttons** to tune the radio to the desired station (hold to scan for the next clear station).
4. Press and release the **FM Presets Button**. 2 beeps will sound to confirm the preset has been assigned. Repeat steps 2 - 4 until you have set up to 6 preset stations.
5. To listen to a preset FM station at any time, follow steps 1 - 2 to turn on FM radio mode and cycle to the desired preset.

Using the iBT232

Pairing Your Bluetooth Device

Pairing is the set-up process to introduce your Bluetooth-capable device to the iBT232. to a previously paired device. Once your device is paired, the iBT232 can recognize it and you can play your audio through it. For manual pairing, follow steps below.



1. Turn on your Bluetooth device and make it “discoverable” by turning on Bluetooth mode (check in Options or Settings).
2. Press the **Bluetooth Button** to turn on the unit in Bluetooth mode, indicated by “bt” on the display and the Bluetooth Button lighting up green.



3. Press and hold the **Bluetooth Button** for 2 seconds. “PAIR” will flash on the display, indicating the iBT232 is in pairing mode.
4. “iHome iBT232” should appear in your device’s Bluetooth menu. Select “iHome iBT232” to connect it. If prompted for a passcode, enter “1234” on your device’s keypad.

5. If pairing is successful, 2 beeps will sound and the **Bluetooth Button** will glow solid green indicating the iBT232 is ready to play music. There should also be an indication on your device. If no device is successfully paired within 3 minutes the iBT232 will default to previous mode. Once the iBT232 is paired to a device, it will attempt to autolink when the device is within range (about 33 feet).

Using the iBT232

Playing Audio via Bluetooth

1. Press the **Bluetooth Button** to turn the unit ON in Bluetooth mode. “bt” appears on the display and the Bluetooth Button lights up.
3. Press the **Play/Pause Button** on the unit to play audio from your linked Bluetooth device.
4. Press the **–** or **+** **Buttons** to go to the previous or next track.
5. Press the **◀** or **▶** **Buttons** to adjust the volume on the unit. You may need to adjust the volume on your device, too.
6. When done listening, press the **Power Button** to turn the unit off.

Using the Speakerphone feature

NOTE: The unit must be powered on and linked to a Bluetooth phone to receive a call.

1. When a call is received, playing music is muted to hear the ring tone. “CALL” will flash on the display. Adjust call volume on your device and/or on the unit as needed.
Press the **Answer Button** to answer the call; press the **End Button** to ignore the call.
2. When a call is completed, press the **End Button** to end the call and resume previous function.

Using the iBT232

Playing Audio via Aux-In

1. Connect one end of a standard stereo 3.5mm audio cable into the aux-in jack on the back of the unit and the other end into the headphone or output jack of your audio device.
2. Press the **Aux Button** on the unit to turn it on in AUX mode, indicated by “AUX” on the display and the Aux Button lighting up green.
4. Place your audio device in play mode. Navigate tracks and adjust output volume on the device.
5. Press the **⏪** or **⏩** **Buttons** to adjust the volume on the unit. You may need to adjust the volume on your device as well.
6. When done listening, press the **⏻ Power Button** to turn the unit off.

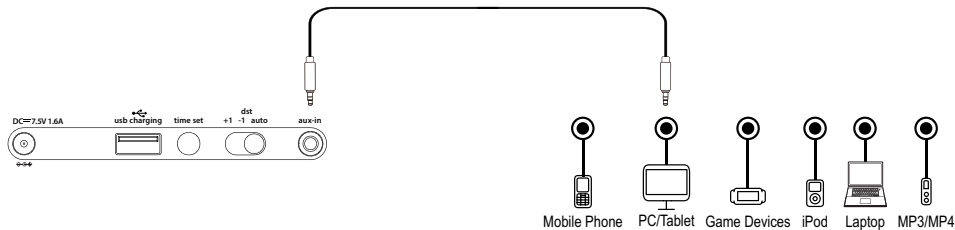

Charging Devices via USB Port

Using the iBT232

1. Connect the standard size end of a USB cable (not included) to the USB Charging Port on back of the unit and connect the other end to the charging port on your device. It's often best to use the charging cable supplied with your device.
2. Monitor the charging on your device. Some devices use a proprietary charging method and will not charge using the USB Port. If this happens, you must charge your device using the charger that came with it.

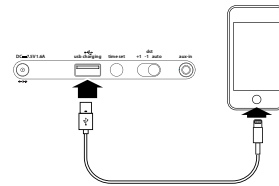

NOTE: Unit must be plugged into working outlet to charge devices

Using the iBT232

Battery Use Cautions and Tips

- Only use the recommended/supplied batteries or equivalent
- Use alkaline batteries for longer life
- Do not mix old and new batteries, and do not mix alkaline, carbon-zinc or rechargeable nickel-cadmium batteries
- Insert batteries with proper polarity (+/-) as indicated
- Remove exhausted batteries from product
- Recharge rechargeable batteries under adult supervision
- Do not attempt to recharge non-rechargeable batteries
- Do not open batteries or heat them beyond normal ambient temperatures.
- To prevent battery leakage or damage remove batteries from a product if it will not be used for a month or longer.
- Use extreme caution handling leaking batteries (avoid direct contact with eyes and skin). If battery leakage comes in contact with eyes, IMMEDIATELY flush the eye with lukewarm and gently flowing water for at least 30 minutes. If skin contact occurs, wash skin with clear water for at least 15 minutes. Seek medical attention if any symptoms occur.
- Store in cool, dry, ventilated area away from hazardous or combustible material.
- Do not dispose of batteries in the household trash or fire
- Follow applicable laws and local regulations for the disposal and transportation of batteries.

Consumer Product Safety Guide

IMPORTANT SAFETY INSTRUCTIONS

When used in the directed manner, this unit has been designed and manufactured to ensure your personal safety. However, improper use can result in potential electrical shock or fire hazards. Please read all safety and operating instructions carefully before installation and use, and keep these instructions handy for future reference. Take special note of all warnings listed in these instructions and on the unit.

1. **Water and Moisture** - The unit should not be used near water. For example: near a bathtub, washbowl, kitchen sink, laundry tub, swimming pool or in a wet basement.
2. **Ventilation** - The unit should be situated so that its location or position does not interfere with its proper ventilation. For example, it should not be situated on a bed, sofa, rug or similar surface that may block ventilation openings. Also, it should not be placed in a built-in installation, such as a bookcase or cabinet, which may impede the flow of air through the ventilation openings.
3. **Heat** - The unit should be situated away from heat sources such as radiators, heat registers, stoves or other appliances (including amplifiers) that produce heat.
4. **Power Sources** - The unit should be connected to a power supply only of the type described in the operating instructions or as marked on the appliance. Only use the AC adapter that came with the unit.
5. **Power-Cable Protection** - Power supply cables should be routed so that they are not likely to be walked on or pinched by items placed upon or against them. It is always best to have a clear area from where the cable exits the unit to where it is plugged into an AC socket.
6. **Cleaning** - The unit should be cleaned only using a warm damp cloth. Do not use solvents, etc.
7. **Objects and Liquid Entry** - Care should be taken so that objects do not fall and liquids are not spilled into any openings or vents located on the product.
8. **Attachments** - Do not use attachments not recommended by the product manufacturer.
9. **Lightning and Power Surge Protection** - Unplug the unit from the wall socket and disconnect the antenna or cable system during a lightning storm or when it is left unattended and unused for long periods of time. This will prevent damage to the product due to lightning and power-line surges.
10. **Overloading** - Do not overload wall sockets, extension cords, or integral convenience receptacles as this can result in a risk of fire or electric shock.
11. **Damage Requiring Service** - The unit should be serviced by qualified service personnel when:
 - A. the power supply cable or plug has been damaged.
 - B. objects have fallen into or liquid has been spilled into the enclosure.
 - C. the unit has been exposed to rain.
 - D. the unit has been dropped or the enclosure damaged.
 - E. the unit exhibits a marked change in performance or does not operate normally.
12. **Periods of Nonuse** - If the unit is to be left unused for an extended period of time, such as a month or longer, the backup batteries should be removed from the unit to prevent damage or corrosion.
13. **Service** - The user should not attempt to service the unit beyond those methods described in the user's operating instructions. Service methods not covered in the operating instructions should be referred to qualified service personnel.

FCC Information

FCC Radiation Exposure Statement

iBT232

FCC ID: EMOIBT232

IC: 986B-IBT232

This equipment complies with FCC RF radiation exposure limits set forth for an uncontrolled environment.

This device complies with Part 15 of the FCC Rules, operation is subject to the following two conditions: (1) This device may not cause harmful interference, and (2) this device must accept any interference received, including interference that may cause undesired operation.

- Warning: Changes or modifications to this unit not expressly approved by the party responsible for compliance could void the user's authority to operate the equipment.
- NOTE: This equipment has been tested and found to comply with the limits for a Class B digital device, pursuant to Part 15 of the FCC Rules.

These limits are designed to provide reasonable protection against harmful interference in a residential installation. This equipment generates, uses and can radiate radio frequency energy and, if not installed and used in accordance with the instructions, may cause harmful interference to radio communications.

However, there is no guarantee that interference will not occur in a particular installation. If this equipment does cause harmful interference to radio or television reception, which can be determined by turning the equipment off and on, the user is encouraged to try to correct the interference by one or more of the following measures:

- Reorient or relocate the receiving antenna.
- Increase the separation between the equipment and receiver.
- Connect the equipment into an outlet on a circuit different from that to which the receiver is connected.
- Consult the dealer or an experienced radio/TV technician for help.

CAN ICES-3 (B)/NMB-3(B)

IC Statement

This device complies with Industry Canada license-exempt RSS standard(s). Operation is subject to the following two conditions: (1) this device may not cause interference, and (2) this device must accept any interference, including interference that may cause undesired operation of the device.

Le présent appareil est conforme aux CNR d'Industrie Canada applicables aux appareils radio exempts de licence. L'exploitation est autorisée aux deux conditions suivantes : (1) l'appareil ne doit pas produire de brouillage, et (2) l'utilisateur de l'appareil doit accepter tout brouillage radioélectrique subi, même si le brouillage est susceptible d'en compromettre le fonctionnement.

The device meets the exemption from the routine evaluation limits in section 2.5 of RSS 102 and compliance with RSS-102 RF exposure, users can obtain Canadian information on RF exposure and compliance.

Le dispositif rencontre l'exemption des limites courantes d'évaluation dans la section 2.5 de RSS 102 et la conformité à l'exposition de RSS-102 rf, utilisateurs peut obtenir l'information canadienne sur l'exposition et la conformité de rf.

Troubleshooting

Unit doesn't respond (no power)

- Check that all connections are correct and properly plugged in.
- Make sure your device is properly paired with the iBT232.
- Make sure the Power is ON.

Unit doesn't respond (locked up or frozen)

- The unit may need to be reset. To do so, unplug the unit from power source and remove the backup batteries. Let unit stand for 2 minutes. Re-install backup batteries and connect unit to power source. You will need to reset the clock, radio, and any other settings.

Trouble pairing device/computer with iBT232

Bluetooth implementation varies depending on your device's hardware and operating system. Please see our website for updates on pairing.

- When you power ON the unit, it will automatically link with the last previously paired Bluetooth device if the device is still within range (about 33 feet).
- Make sure your device is working properly. Check your device's manual for details on Bluetooth pairing and linking.

For further information and to see the latest instructions, visit www.ihome.com/support

Limited 1 Year Warranty

iHome Products, a division of SDI Technologies Inc. (hereafter referred to as SDI), warrants this product to be free from defects in workmanship and materials, under normal use and conditions, for a period of one (1) year from the date of original purchase.

Should this product fail to function in a satisfactory manner, it is best to first return it to the store where it was originally purchased. Should this fail to resolve the matter and service still be required by reason of any defect or malfunction during the warranty period, SDI will repair or, at its discretion, replace this product without charge. This decision is subject to verification of the defect or malfunction upon delivery of this product to the Factory Service Center authorized by Customer Service.

If service is required, please call Customer Service at 1-800-288-2792 to obtain a Return Authorization Number and shipping instructions. A copy of the sales receipt is required to validate in-warranty coverage.

Disclaimer of Warranty

NOTE: This warranty is valid only if the product is used for the purpose for which it was designed. It does not cover (i) products which have been damaged by negligence or willful actions, misuse or accident, or which have been modified or repaired by unauthorized persons; (ii) cracked or broken cabinets, or units damaged by excessive heat; (iii) damage to digital media players, CD's or tape cassettes (if applicable); (iv) the cost of shipping this product to the Factory Service Center and its return to the owner.

This warranty is valid only in the United States of America and does not extend to owners of the product other than to the original purchaser. In no event will SDI or any of its affiliates, contractors, resellers, their officers, directors, shareholders, members or agents be liable to you or any third party for any consequential or incidental damages, any lost profits, actual, exemplary or punitive damages. (Some states do not allow limitations on implied warranties or exclusion of consequential damages, so these restrictions may not apply to you.) This warranty gives you specific legal rights, and you may also have other rights which vary from state to state.

Your acknowledgment and agreement to fully and completely abide by the above mentioned disclaimer of warranty is contractually binding to you upon your transfer of currency (money order, cashier's check, or credit card) for purchase of your SDI product.

© 2017 SDI Technologies, Inc. All rights reserved
Questions? Visit www.ihome.com
or call 1-800-288-2792 Toll Free