

Model: IW05

User Guide

Version 2.0.6.3

2015-09-09

User Guide for the IW05

Version 2.0.6.3

Firmware version 2.0.X

Printed in Korea

Copyright

Copyright 2008~2015, Sena Technologies, Inc. All rights reserved.

Sena Technologies reserves the right to make changes and improvements to its product without providing notice.

Trademark

Parani™ is a trademark of Sena Technologies, Inc.

Windows® is a registered trademark of Microsoft Corporation.

Bluetooth® is a registered trademark of Bluetooth SIG (Special Interest Group).

Notice to Users

When a system failure may cause serious consequences, protecting life and property against such consequences with a backup system or safety device is essential. The user agrees that protection against consequences resulting from system failure is the user's responsibility.

This device is not approved for life-support or medical systems.

Changes or modifications to this device not explicitly approved by Sena Technologies will void the user's authority to operate this device.

Precautions and Safety

Electricity

Use only within the IW05 power specification. Use under incorrect power specification may result electrical shock and damage of the product.

Do not kink or crease the power supply parts or place heavy objects on the power supply parts. Fire can result from damaged parts.

Do not handle power supply parts with wet hands. Electrical shock may result.

Immediately power off the product if smoke or odors emits from the product. Fire can result from improper use.

Immediately power off the product if water or other liquids are present. Fire can result from improper use.

Product

IW05 supports the TTL-level UART function. Do not connect with non-compatible products. Damage to your products may result from improper use.

Do not drop or subject the device to impact. Damage to your products may result from improper use.

Keep away from harsh environments including humid, dusty, and smoky areas. Damage to your products may result from improper use.

Do not use excessive force on the buttons or attempt to disassemble the device. Damage to your products may result from improper use.

Do not place heavy objects on the product. Damage to your products may result from improper use.

Technical Support

Sena Technologies, Inc.

Tel: (+82-2) 576-7362

Fax: (+82-2) 573-7710

E-Mail: support@senaindustrial.com

Website: <http://www.senaindustrial.com>

Revision History

Revision	Date	Name	Description
V2.0.6	2012-04-03	JH Park	Initial Release
V2.0.6.1	2012-05-10	SH Kim	Modify incorrect descriptions
V2.0.6.2	2012-06-12	JH Park	Add contents about BCD210
V2.0.6.3	2015-09-09	TM Kim	Change the website address

Contents

1. Introduction	7
1.1. Overview	7
1.2. Package Check List	7
1.2.1. Unit Package	7
1.2.2. Starter Kit	7
1.3. Product Specification	8
2. Getting Started	10
2.1. Panel Layout	10
2.2. Connecting the Hardware	10
2.2.1. Connecting IW05 to Development Board	11
2.2.2. Connecting Power to Development Board	11
2.2.3. Connecting a Device to Development Board	12
3. Configuration	13
3.1. Operation Modes	13
3.2. Serial Ports	14
3.3. Data Bit	14
3.4. Hardware Flow Control	14
3.5. Remote Configuration	14
3.6. Software and Utility	15
3.7. ParaniWIN	15
3.8. ParaniWizard	21
3.9. Parani Multi Wizard	25
3.10. ParaniUpdater	26
3.11. Terminal Program	27
4. Multiple Connection Mode	29
4.1. Overview	29
4.2. Configuration	30
4.3. AT Commands	31
4.3.1. AT+MULTI,n	31
4.3.2. AT+MLIST?	31
4.3.3. ATHx, ATHbdaddr	31
4.3.4. ATOx, ATObdaddr	31
4.4. Notes	32
5. Approval Information	33
5.1.1. Do not	35
6. RF Information	36
6.1. Radio Frequency Range	36
6.2. Number of Frequency Channel	36
6.3. Transmission Method	36
6.4. Modulation Method	36
6.5. Receiving Sensitivity	36
6.6. Power Supply	36
Appendix A: Connections	37
A.1. Pin Assignment	37
A.1.1. IW05-DU	37
A.1.2. Bluetooth Connection Detect(UART_DCD) Signal	39
A.1.3. Factory Reset(FACTORY_RESET) Signal	39
A.1.4. Pairing (BT_MODE) Signal (Single Connection Mode Only)	39
A.1.5. Flow Control(FC_CTRL) On/Off Signal	40
A.1.6. Bluetooth Status LED(STATUS_LED0, STATUS_LED1) Signal	40
A.1.7. Reset Signal	40
A.2. Connection Diagram	41
A.2.1. IW-05DU	41
Appendix B: AT Commands	43
B.1. Terminology	43

B.1.1. AT Command	43
B.1.2. AT Response	43
B.1.3. Operation Mode	43
B.1.4. Operation Status	43
B.1.5. Security	43
B.1.6. Symbols	43
B.2. Command Category	44
B.3. Command Description	45
B.3.1. ATZ↵	45
B.3.2. AT&F↵	45
B.3.3. AT↵	45
B.3.4. AT+UARTCONFIG,Baudrate,Parity,Stopbit,Hwfc↵	45
B.3.5. AT+BTINFO?↵	45
B.3.6. AT+BTINQ?↵	46
B.3.7. AT+BTLAST?↵	46
B.3.8. AT+BTVER?↵	46
B.3.9. AT+BTRSSI,n↵(Single Connection Mode Only)	46
B.3.10. AT+MLIST?↵	47
B.3.11. AT+BTMODE,n↵	47
B.3.12. AT+MULTI,n↵	47
B.3.13. +++↵	47
B.3.14. AT+SETESC,nn↵	48
B.3.15. ATO↵ (ATOx, ATObdaddr)	48
B.3.16. AT+BTCANCEL↵	48
B.3.17. AT+BTSCAN↵	48
B.3.18. AT+BTSCAN,n,to↵	48
B.3.19. AT+BTSCAN112233445566,to↵	49
B.3.20. ATD↵	49
B.3.21. ATD112233445566↵	49
B.3.22. ATA↵	50
B.3.23. ATA112233445566↵	50
B.3.24. ATH↵ (ATHx, ATHbdaddr)	50
B.3.25. AT+BTKEY=\$string↵	50
B.3.26. AT+BTSD? ↵	51
B.3.27. AT+BTCSD↵	51
B.3.28. AT+BTFP,n↵	51
B.3.29. AT+BTSEC,Authentication,Encryption↵	51
B.3.30. AT+BTNAME=\$string↵	51
B.3.31. AT+BTLPM,n↵	52
B.3.32. AT+PASS=\$string↵	52
B.3.33. AT+CHPASS=\$string↵	52
B.3.34. AT&V↵	52
B.3.35. AT\$nn? ↵	52
B.3.36. AT\$nn=mm↵	53
B.4. Command Validity	53
Appendix C: S-Register	55
C.1. S1: Force to Reconnect (default 1)	55
C.2. S3: Stream UART Policy (default 0)	55
C.3. S4: Enable Remote Name Query (default 1)	55
C.4. S6: Enable Low Power Mode (default 0)	55
C.5. S10: Enable Response Message (default 1)	55
C.6. S11: Enable Escape (default 1)	55
C.7. S12: Clear Data Buffer When Disconnected (default 0)	56
C.8. S13: Enable DCD Signal (default 1)	56
C.9. S14: Enable DTR Transfer (default 1)	56
C.10. S15: Enable Disconnect by DTR (default 0)	56
C.11. S22: Faster Connection (default 3)	56
C.12. S23: Intercharacter Timeout Setting (default 0)	56

C.13. S24: Maximum Number of Inquiry Result (default 15)	56
C.14. S26: Intercharacter Timeout (default 0)	56
C.15. S28: Escape Sequence Character (default 43)	57
C.16. S31: Page Timeout (default 20)	57
C.17. S33: Inquiry Timeout (default 30)	57
C.18. S37: Supervision Timeout (default 5)	57
C.19. S43: COD (default 001F00)	57
C.20. S44: COD Filter (default 0)	57
C.21. S45: Inquiry Access Code (default 0x9E8B33)	57
C.22. S46: BD Address of Last Connected Device	57
C.23. S48: Low Power Max Interval (default 5000)	58
C.24. S49: Low Power Min Interval (default 4500)	58
C.25. S52: Low Power Timeout (default 5)	58
C.26. S54: BD Address of Last Connected Device	58
C.27. TS55: BD Address of Last Connected Device	58
C.28. S56: BD Address of Last Connected Device	58
C.29. S57: Slave Disconnect Timeout (default 3)	58
C.30. S58: MAX TX POWER (default 0)	58
C.31. S59: Current Slave in Communication (default 0)	59
C.32. S60: Reconnect Time Interval (default 5)	59
Appendix D: Trouble Shooting	60
D.1. No Data Transmission	60
D.1.1. Device Settings	60
D.2. Data Loss or Malfunctioning	60
D.2.1. Hardware Flow Control	60
D.2.2. Response Message	60
D.3. Transmission Delay	60
D.3.1. RF Processing Delay	60
D.3.2. RF Transmission Environment	60
Appendix E: Warranty	61
E.1. GENERAL WARRANTY POLICY	61
E.2. LIMITATION OF LIABILITY	61
E.3. HARDWARE PRODUCT WARRANTY DETAILS	61
E.4. SOFTWARE PRODUCT WARRANTY DETAILS	62
E.5. THIRD-PARTY SOFTWARE PRODUCT WARRANTY DETAILS	62

1. Introduction

1.1. Overview

The IW05 is a Bluetooth OEM SMD/DIP module combining antenna for OEM manufactures who want to implement Bluetooth functionality with their products cost effectively and also in timely manner. IW05 has a built in antenna to lower the overall cost while benefit from the IW05's field-proven standard SPP firmware provided with no additional cost.

The IW05 supports Class2 Bluetooth transmission level for the shorter communication distance typically ranges from 50m up to 300m. The IW05 supports Class1 Bluetooth transmission level for longer communication distance typically ranges from 200m up to 1000m.

The IW05 is provided with Bluetooth v2.0+EDR compatible firmware runs internally for SPP (Serial Port Profile) applications by default. The SPP firmware supports up to 4 simultaneous multiple connections and is designed to work out-of-box for real world SPP applications such as POS (Point-of-sales), industrial automation, remote metering and other various applications. Optionally, the IW05 can be supplied with only software stack up to HCI level so entire Bluetooth stack runs on the host side for the application such as USB dongles for computers or OEM manufacturers can even develop and embed their own firmware into the IW05.

The IW05 is fully qualified with Bluetooth v2.0+EDR specification so OEM manufacturers can save cost and time for overall OEM product certifications, which makes the IW05 ideal solution for larger volume and cost sensitive applications.

1.2. Package Check List

1.2.1. Unit Package

IW05-SC	- Bluetooth embedded OEM module SMD Type, Class 1 or Class2 w/ chip antenna
IW05-SU	- Bluetooth embedded OEM module SMD Type, Class 1 or Class2 w/ U.FL connector
IW05-DC	- Bluetooth embedded OEM module DIP Type, Class 1 or Class2 w/ chip antenna
IW05-DS	- Bluetooth embedded OEM module DIP Type, Class 1 or Class2 w/ SMA connector
IW05-DU	- Bluetooth embedded OEM module DIP Type, Class 1 or Class2 w/ U.FL connector

1.2.2. Starter Kit

- BCDx10DC 1
- BCDx10DS 1
- BCDx10DU 1
- Development board 1
- DC Power adapter 1
- RS232 serial cable 1
- Stub antenna 1
- 3dBi Dipole antenna 1
- U.FL Cable 1

1.3. Product Specification

	IW05
Bluetooth Specifications	Bluetooth v2.0 + EDR
	Class1
	Profile: SPP(<i>Serial Port Profile</i>)
	Working distance: By default antenna is 200m (0.12 mile), Supports up to 1000m (0.62 mile)
Transmit Power (Frame Average Power)	BDR : $\pm 11+1$, EDR : $\pm 6+1$
Receive Sensitivity	-90dBm (0.1% BER)
Frequency range	2402MHz – 2480MHz
Serial Interface	Serial UART speed up to 921.6kbps CTS/RTS flow control, DTR/DSR for loop-back & full transfer
PIN Interface	IW05-Sx: 1.27mm SMD Pad 18x2 (36pin) IW05-Dx: 1.27mm Pin Header 18X2 (36pin)
Configuration	ParaniWIN, ParaniWizard, Modem AT command set
Firmware Update	ParaniUpdater
Power Consumption	Nominal : 70mA @3.3V,DC Maximum : 150mA @3.3V,DC (200mA@3.3V,dc in Test Mode)
Environmental	Operating temperature: -40 ~ 85°C Storage temperature: -40 ~ 85°C Humidity : 90% (Non-condensing)
Physical properties	IW05 Dimension DIP type 16.8(W) x 34.6(L) x 8.0(H) mm (0.661 in x 1.362 in x 0.315 in) SMD type 14.8(W) x 34.6(L) x 3.0(H) mm (0.583 in x 1.362 in x 0.118 in)
	Weight IW05-SC: 2g IW05-SU: 2g IW05-DC: 3g IW05-DU: 3g IW05-DS: 6g
Approvals	FCC, CE, IC, KC, TELEC, SIG
Warranty	1-year limited warranty



Note *:

Bluetooth v2.0 supports improved AFH function. AFH function is to mitigate the interference between WiFi and Bluetooth radios by automatically avoiding the active WiFi channel from Bluetooth link. However, AFH does not provide a complete solution making WiFi and Bluetooth work together in harmony. It is highly recommended for users to test their wireless system enough before deployment since the overall system performance is affected by various environmental factors such as distance between them.

2. Getting Started

This chapter describes how to set up the IW05 for the first time.

- 2.1 *Panel Layout* explains the panel layout.
- 2.2 *Connecting the Hardware* describes how to connect the IW05, the power, and the serial device to the Jig Board.

Following items are pre-required to get started.

- One Jig Board (included in the Starter Kit package).
- One DC power adapter or one USB power cable (included in the Starter Kit package).
- One serial console cable for configuration (included in the Starter Kit package).
- One PC with RS232 serial port.
- Terminal emulation program running on the PC

2.1. Panel Layout

This section describes the panel layout of the Development Board.

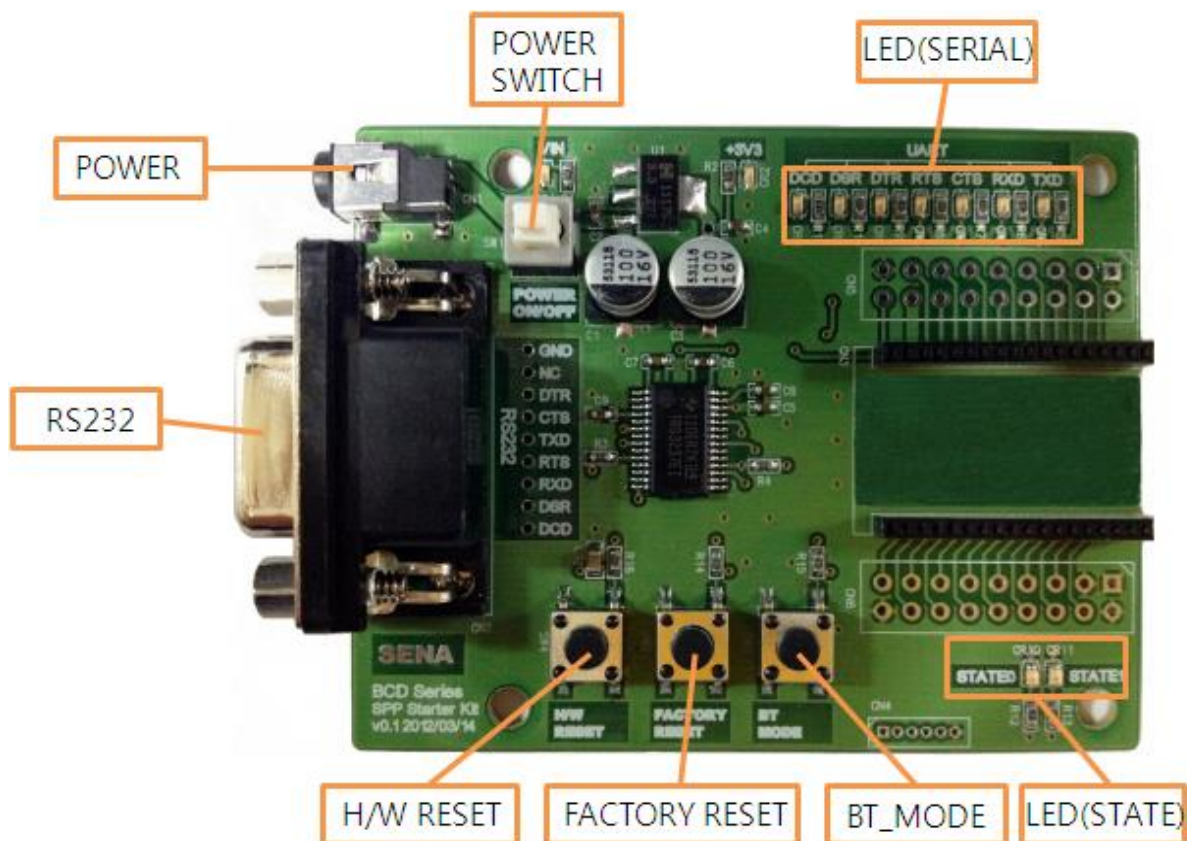

Figure 2-1 The Panel Layout of BCD Development Board

2.2. Connecting the Hardware

This section describes how to connect the IW05 to the Development Board and the Development Board to the serial device for initial testing.

- Connect the IW05 to the Development Board.
- Connect a power source to the Development Board for the IW05.

- Connect the Development Board for the IW05 to a serial device.

2.2.1. Connecting IW05 to Development Board

Connect the IW05 to the Development Board as shown below.

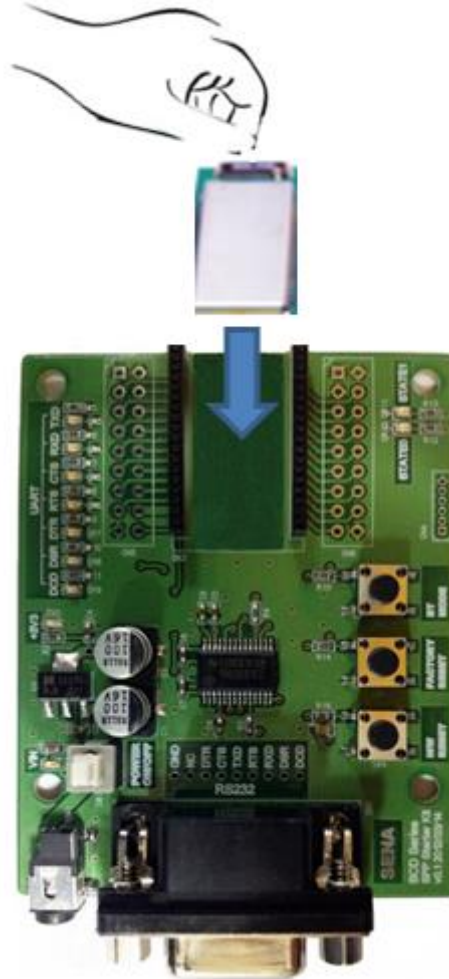

Figure 2-2 Connecting IW05 to Development Board

2.2.2. Connecting Power to Development Board

Connect the power plug to the power connector of the Development Board for the IW05 using the DC power adapter or USB power cable that is included in the package.

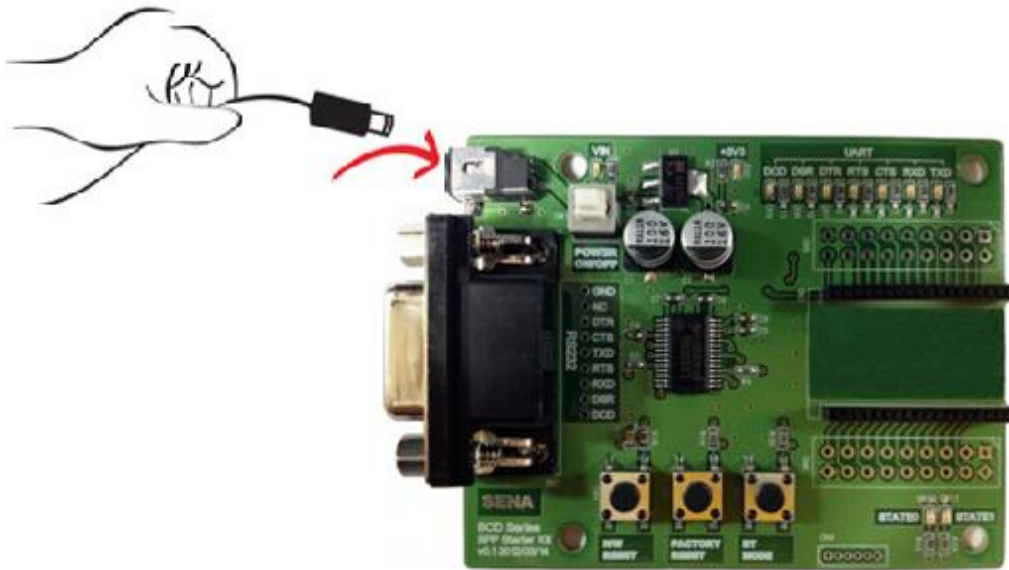

Figure 2-3 Connecting Power to Development Board

2.2.3. Connecting a Device to Development Board

Connect the serial data cable between the Development Board and the serial device. If necessary, supply power to the serial device attached to the Development Board.

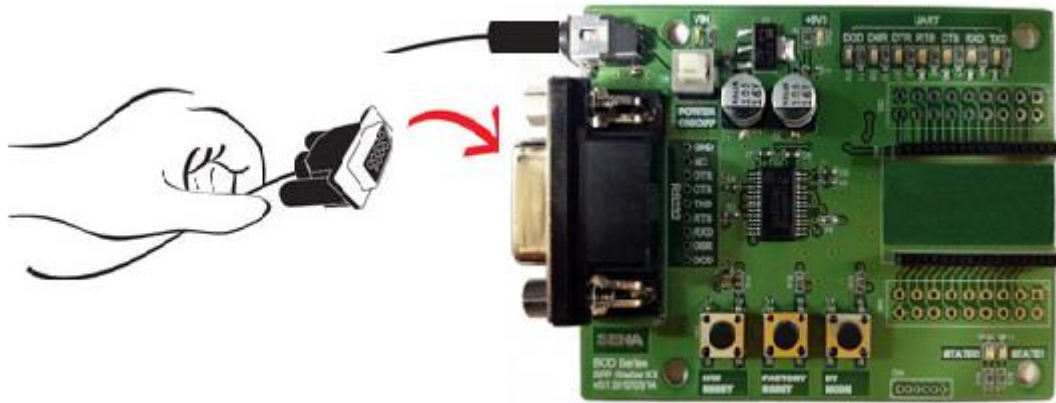

Figure 2-4 Connecting a Device to Development Board

3. Configuration

3.1. Operation Modes

In addition to the serial port configurations, the IW05 requires also includes some settings for Bluetooth. For getting the most out of IW05, user should understand the following Bluetooth connection schemes.

A Bluetooth device can play a role as a master or slave. Master tries to connect itself to other Bluetooth devices, and slave is waiting to be connected from other Bluetooth devices. A Bluetooth connection is always made by a pair of master and slave devices. A slave can be in two modes, Inquiry Scan or Page Scan mode. Inquiry Scan mode is waiting for a packet of inquiry from other Bluetooth device and Page Scan mode is waiting for a packet of connection from other Bluetooth device. Every Bluetooth device has its unique address, called BD (Bluetooth Device) address, which is composed of 12 hexa-decimal numbers.

IW05 has 4 operation modes as follows:

Table 3-1 The IW05 Operation Modes

Mode	Description
Mode0	<p>In this mode, there is no response when power on or software reset, and IW05 is just waiting for AT command input. Neither master nor slave is assigned to IW05 in mode0. User can change the configuration parameters of IW05 in this mode.</p> <p>IW05 must be in Mode0, when it is directly controlled by AT commands.</p> <p>The factory default is set to Mode0.</p>
Mode1	<p>IW05 tries to connect the last connected Bluetooth device.</p> <p>IW05 in Mode1 is to be a master and tries to connect the last connected Bluetooth device. IW05 always stores the BD address of the Bluetooth device to which IW05 has connected last. When IW05 is initially used or after hardware reset, there is no BD address stored in IW05. In this case, Mode1 will not be able to work properly. The mode change to Mode1 can be made after IW05 succeeds to connect to one other Bluetooth device. Once changed to Mode1, IW05 will try to connect automatically the last connected Bluetooth device whenever the unit is powered on or software reset.</p> <p>IW05 in Mode1 cannot be discovered or connected by other Bluetooth devices.</p>
Mode2	<p>IW05 is waits for a connection from the last connected Bluetooth device.</p> <p>IW05 in Mode2 is to be a slave and waiting for the connection only from the last connected Bluetooth device. Just like Mode1, if there is no BD address stored in IW05, the mode change from other operation modes to Mode2 is not work properly. Once changed to Mode2, IW05 will wait for the connection from the last connected Bluetooth device whenever the unit is powered on or software reset.</p> <p>IW05 in Mode2 cannot be discovered or connected to Bluetooth devices other than the last connected device.</p>
Mode3	<p>IW05 is waiting for the connection from any other Bluetooth devices. In Mode 3 the IW05 is discoverable and can be connected to by other Bluetooth devices.</p>

3.2. Serial Ports

The applicable settings for serial ports are as follows.

Table 3-2 The IW05 Serial Port Settings

Serial Port Settings	Values
Baud rate	1200, 2400, 4800, <u>9600</u> , 14400, 19200, 38400, 57600, 115200, 230400, 460800, 921600
Data bite	<u>8</u>
Parity	<u>No parity</u> , Even parity, Odd parity
Stop bit	<u>1</u> , 2
Hardware Flow Control	<u>Use</u> , No Use

The values in box are the factory default settings.

3.3. Data Bit

IW05 supports only 8 data bit. But if both master device and slave device are one of Parani-SD, Parani-ESD or IW05 or Parani-MSP1000 series, Parani series devices can support 7 data bit and even/odd parity by setting both Parani series devices to 8 data bit and none parity. But 7 data bit and none parity cannot be supported even if both master device and slave device are Parani series devices.

3.4. Hardware Flow Control

IW05 plugged into its host system transmits data from host to the other side Bluetooth device. This data is saved temporarily in the internal buffer of IW05 and sent repeatedly until the transmission is completed packet by packet. When the radio transmission condition is not good enough to send data promptly, it can cause a transmission delay. If the host sends more data when the buffer is full, buffer overflow will make IW05 malfunction consequently. In order to prevent this buffer overflow, IW05 works as follows.

When using hardware flow control, IW05 disables RTS so that it stops receiving any further data from the host when the buffer becomes full. RTS will be re-enabled again to begin receiving data from the host when the buffer has created more room for more data.

When hardware flow control is not being used, the IW05 clears the buffer to secure room for the next data when the buffer becomes full. This can mean a loss of data may occur. As the transmission data becomes large, the possibility of data loss becomes greater.

For large data transmissions, the use of hardware flow control is highly recommended. (Not support flow control in Multi-Drop Mode.)

3.5. Remote Configuration

IW05 supports remote configuration. After connecting to the IW05 through Bluetooth, before sending any other character, send three escape character (default :+). Then, the IW05 will enter remote configuration mode and print "Please Enter Password". You have to enter the password with "AT+PASS" command within 2 minutes. After the password authentication, you are able to enter any at command except "ATH", "ATO", "ATD", "AT+BTSCAN", "AT+BTINQ?" and "AT+BTCANCEL". The default password is "0000" and it is configurable with "AT+CHPASS" command.

Example of remote configuration mode.

```
CONNECT 000195000001
+++
Please Enter Password
AT+PASS=0000
Remote Configuration Enabled
AT+BTINFO?
000195000001,BCDx10v2.0.6-095515,MODE0,CONNECT,0,0,HWFC
```

3.6. Software and Utility

This configuration software and utility for firmware update is included with the product, which also can be downloaded from <http://www.senaindustrial.com>

Table 3-3 Configuration Software

Software	Purpose	Operating System
ParaniWIN	Configuration	MS Windows 98SE or Higher
ParaniWizard	Pairing Configuration	MS Windows 98SE or Higher
ParaniMultiWizard	Multi Configuration	MS Windows 98SE or Higher
ParaniUpdater	Firmware Update	MS Windows 98SE or Higher

3.7. ParaniWIN

ParaniWIN is a program that runs on Microsoft Windows for the configuration of IW05. Install ParaniWIN on your computer. Connect the serial port of IW05 into the serial port of the computer and turn on the power.(BCD Development Board or RS232 interface board may be required to access the serial port of IW05.) Run ParaniWIN.

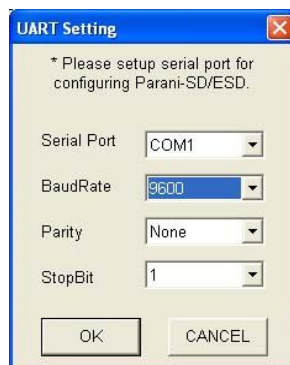

Figure 3-1 Serial Port Setting

Set each option properly and click [Confirm]. If the settings of the IW05 are different from the ParaniWin, an error message will pop up. If the IW05 is in the status of connection, warning message will pop up. Then the current connection can be cancelled by [Disconnect] button on the main window.

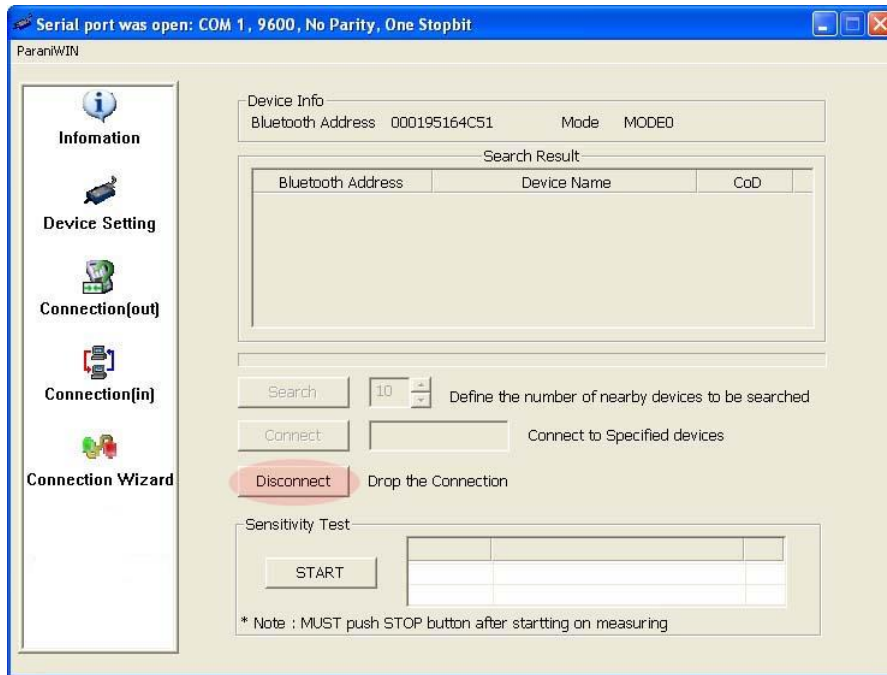

Figure 3-2 Main Window

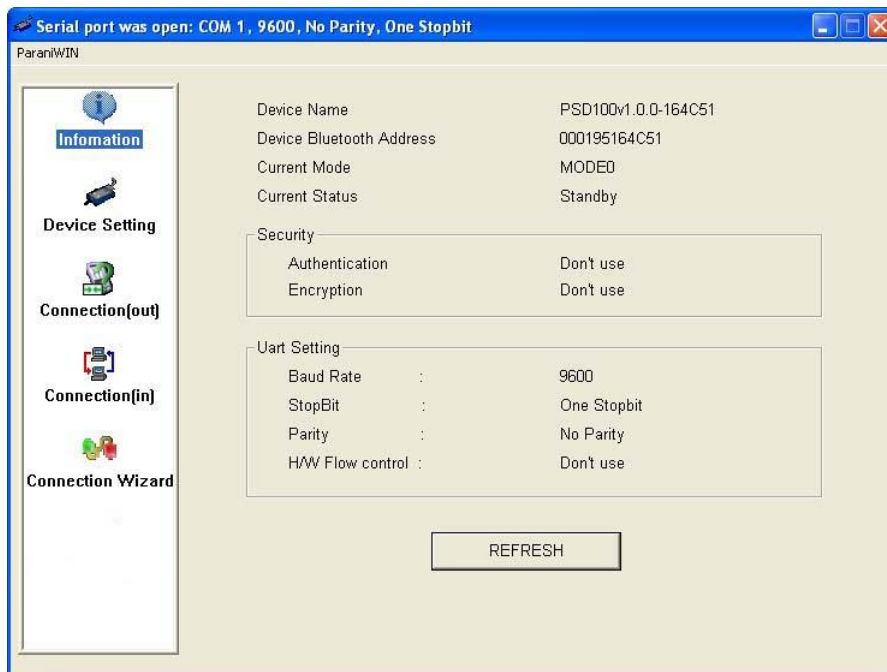

Figure 3-3 Information Window

Serial port settings can be changed by <Start Configuration> and <ParaniWIN Configuration> of ParaniWIN in the menu bar at upper left corner of the window without re-running the ParaniWIN program.

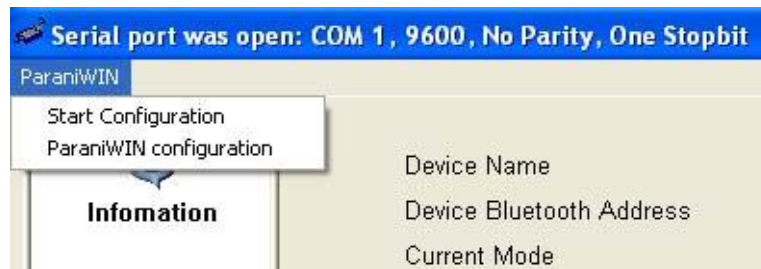

Figure 3-4 Menu Bar at Upper Left corner of ParaniWIN

When the ParaniWin software is able to access the IW05 properly, the icons in the left side window come will become available for use.

In device configuration window, hardware reset can be executed or operation mode and RS232 can be configured as well. Security option also can be configured in this window.

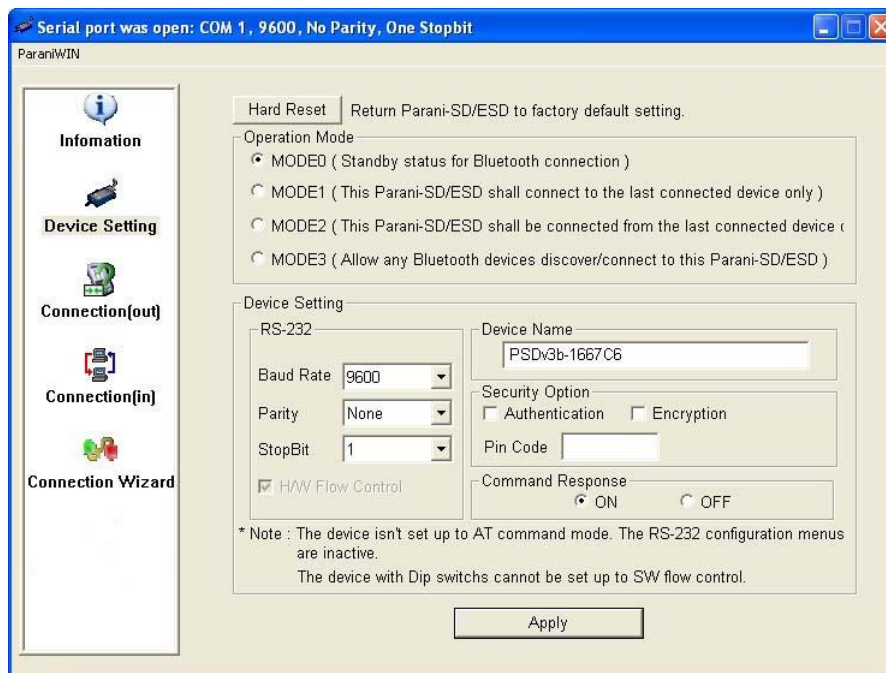

Figure 3-5 Device Setting Window

IW05 supports two security options, Authentication and Encryption. If you check the Authentication option, you must also enter the Pin Code value. If the authentication is activated, the connection, only between the Master and Slave device that share the same Pin Code, is established. IW05 supports two security options, Authentication and Encryption. If you enable the Authentication option, you must

also enter a Pin Code value. If the authentication is enabled, the connection, between the Master and Slave device must share the same Pin Code. In case that IW05 connects to another Bluetooth device, that requires authentication, you must know the other device's Pin Code. In general, most Bluetooth devices have a pincode of 1234 or 0000. If you check Encryption option, the IW05 will encrypt packets and sent to the device. The Encryption options works well in case that only one of the devices between Master and Slave use the Encryption option.

IW05 has 4 response messages, 'OK', 'ERROR', 'CONNECT', and 'DISCONNECT'. In some cases, these responses can affect the host system unexpectedly. To prevent this, user can set the Command response to ON or OFF.

Click [Apply] button to apply any changes made to the IW05.

Connection(out) icon will show the following window to search and connect other Bluetooth devices.

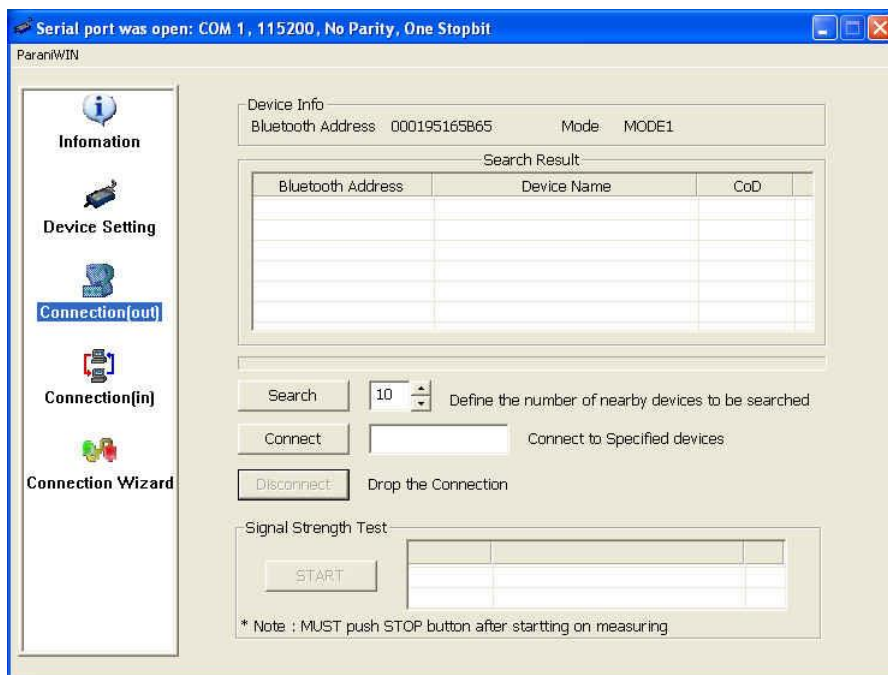

Figure 3-6 Connection(out) Window

Click [Search] button to search nearby Bluetooth devices. Once several Bluetooth devices has been found, select one of the devices and click the [Connect] button. The selected Bluetooth device must be discoverable and connectable. Click [Disconnect] button to cancel the connection.

After the connection has been established, you will be able to test signal strength by pushing the START button.

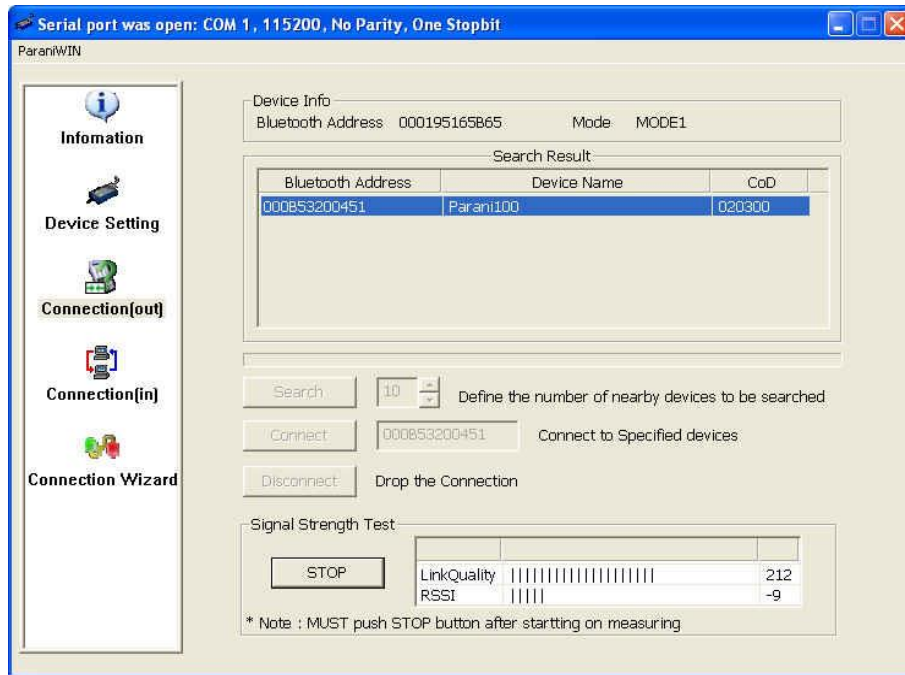

Figure 3-7 Signal Strength Test

The signal strength test shows LinkQuality and RSSI values. The closer LinkQuality is to 255 and RSSI is to 0, this means the IW05 has a good connection to the connected Bluetooth device. In general, the wireless connectivity is at its best within 10 meters. You can push the STOP button at any time in order to terminate the signal strength test. The signal strength test will continue until the STOP button is pushed. If you close the ParaniWIN Window without pushing the STOP button, you must restart IW05 to terminate the test.

Connection(in) icon will show the following window, which enables the IW05 to wait for a connection from another Bluetooth device. If the waiting time is set to 0, IW05 will continually wait for connection until [Cancel] button is clicked.

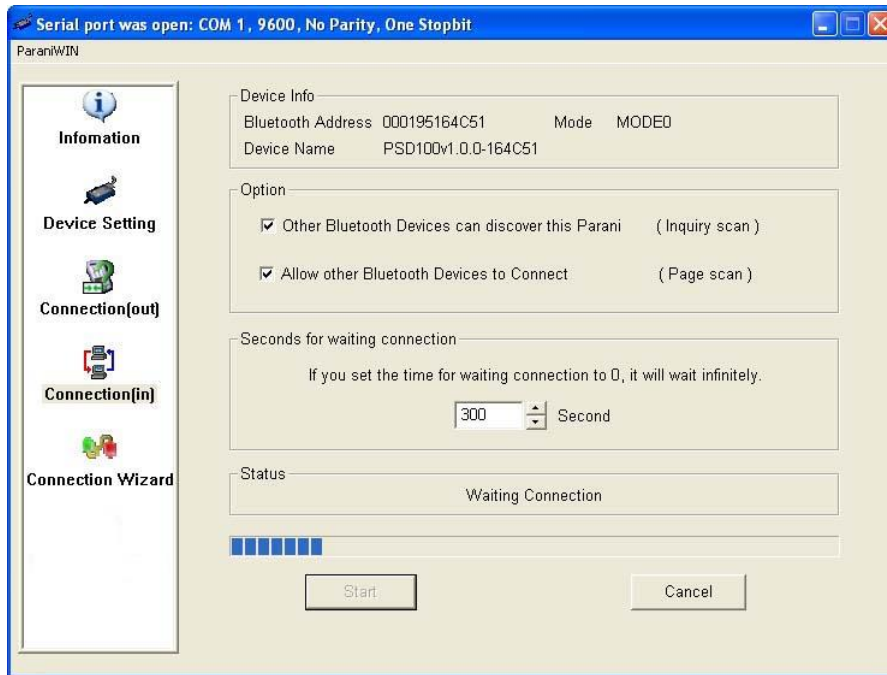

Figure 3-8 Connection(in) Window

If the Connection Wizard icon is clicked, an easy to use pairing menu will appear:

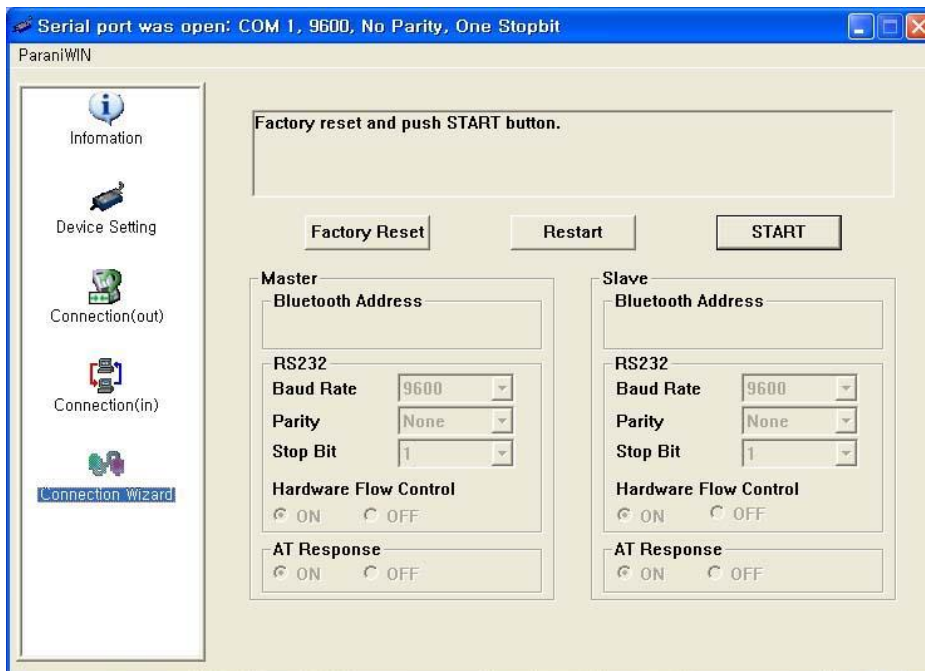

Figure 3-9 Connection Wizard Window

In this example we will refer to the two IW05s as BCD1 and BCD2 respectively. To use this menu, please do the following:

- Step 1.** Connect BCD1 and then push the START button.
- Step 2.** Disconnect BCD1, connect BCD2 and then push the Next button after setting up Slave configuration.
- Step 3.** Disconnect BCD2, once again connect the BCD1 and then push the Finish button. The pairing

configuration should be completed. Make sure that each IW05's connect LED is on. At this point, when both IW05s are restarted the connection will be established automatically.

3.8. ParaniWizard

ParaniWizard is a Wizard program that will allow you to configure a pair of IW05s for an automatic connection. To make connection with Bluetooth devices other than IW05, use ParaniWIN or AT commands on a terminal program.

In this example, we will refer to the two IW05s as BCD1 and BCD2 respectively.

Install and run ParaniWizard.



Figure 3-10 ParaniWizard Step 1

Plug BCD1 into the serial port of the host computer and power on the unit. Click [Wizard Setting] button to configure the serial port settings of BCD1. These settings must be the same as those of the host system, to which BCD1 will be used. Click [Next].



Figure 3-11 ParaniWizard Step 2

Click [Next] with after selecting the check box, which makes the unit discoverable, in which BCD1 can be discovered and connected from the other Bluetooth device.
Remove BCD1 from the host computer, remember to leave the BCD1 powered on.
Now, plug BCD2 into the serial port of the host computer and power on the unit.



Figure 3-12 ParaniWizard Step 3

Click [Wizard Setting] button to configure the serial settings of BCD2. These settings must be same as those of the host system, to which BCD2 will be used. Click [Next].

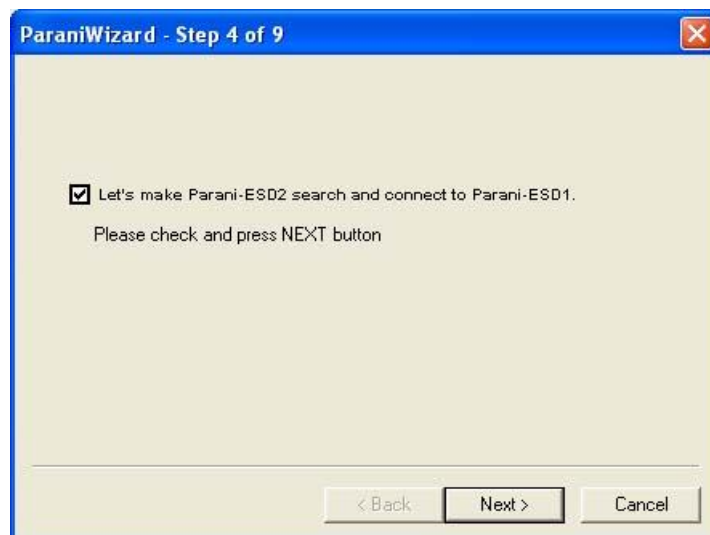

Figure 3-13 ParaniWizard Step 4

Click [Next] after selecting check box. BCD2 will then do a search nearby, and search for Bluetooth

devices for 30 seconds. The program will show the Bluetooth devices with Device Address, Device Name and CoD(Class of Device).



Figure 3-14 ParaniWizard Step 5

Select the BCD1 from the list and click [Connect], then the following message box will be displayed.

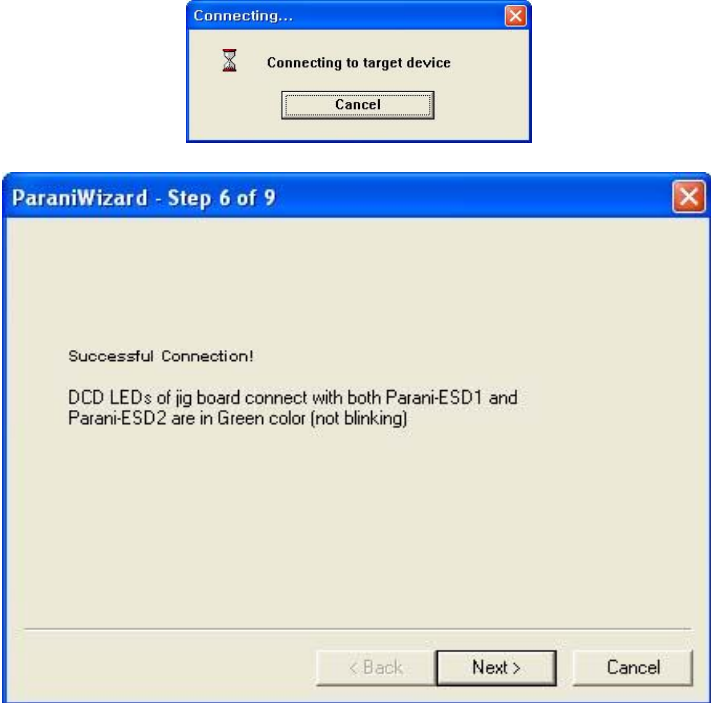

Figure 3-15 ParaniWizard Step 6

It may take about 5 seconds to complete the connection.

For the automatic connection to take place between BCD1 and BCD2, the proper operation mode of BCD1 and BCD2 have to be set.



Figure 3-16 ParaniWizard Step 7

Set the operation mode of BCD2 to Mode1.



Figure 3-17 ParaniWizard Step 8

Remove the BCD2 from the host computer and plug BCD1 into the serial port again. Set the operation mode of BCD1 to Mode2.



Figure 3-18 ParaniWizard Step 9

Now the configuration of BCD1 and BCD2 has been completed. Now when the units are turned off and then turned on again, they will make an automatic connection to each other.

3.9. Parani Multi Wizard

Parani Multi Wizard is the software tool for multiple connection mode configurations of the Parani-SD, Parani-ESD and IW05 products.

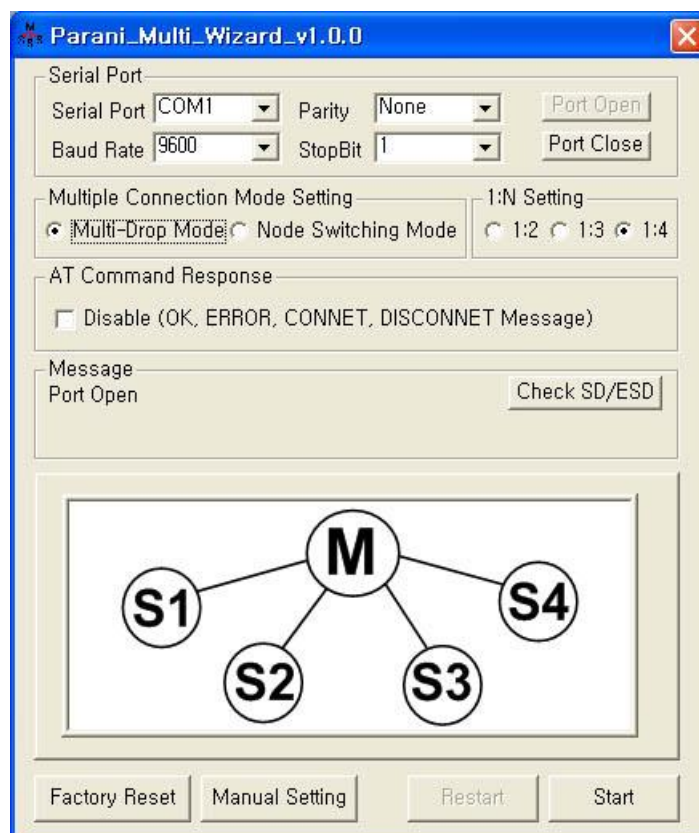

Figure 3-19 Parani Multi Wizard Window

Parani Multi Wizard supports the Wizard mode and the Manual mode. The Wizard mode provide the user step-by-step instructions for multiple mode configurations. To run the Wizard mode, select “Multiple connection mode setting” and “1:N setting”, press “Start” button and follow the instructions.

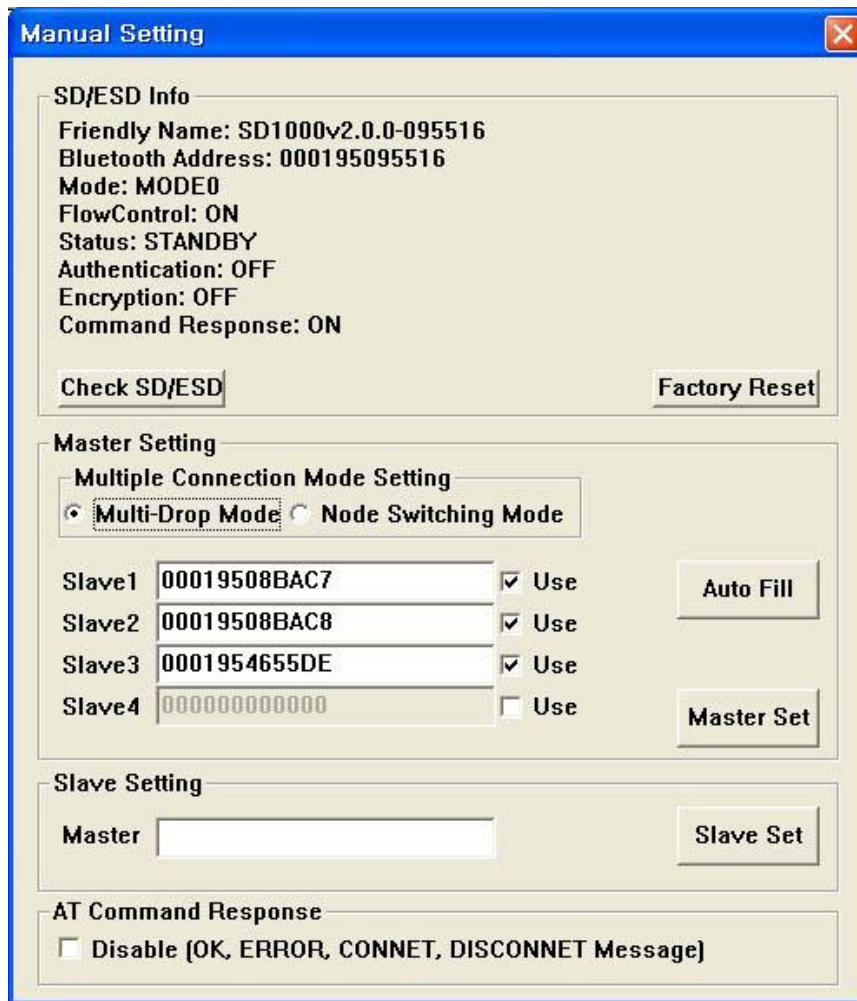

Figure 3-20 Manual Setting Window

In the Manual mode, all settings for the multiple connection mode can be configured in one window. If a Use field is unchecked or a slave address is entered as 000000000000, it is excluded from the Slave settings.

The Auto Fill button will load the existing multiple connection mode settings from the Parani-SD/ESD/BCD connected, which can be useful when only some parts of the settings are changed.

If the AT Command Response Disable check box is checked on, the AT command responses such as OK, ERROR, CONNECT, DISCONNECT are suppressed.

3.10. ParaniUpdater

IW05 supports firmware updates. You can download new firmware images for the IW05 at <http://www.senaindustrial.com>. With the ParaniUpdater, you can update the firmware of IW05 by selecting the firmware image file and pushing Start button.

* Note: DO NOT power off IW05 while the firmware update is progressing, this may damage the IW05.

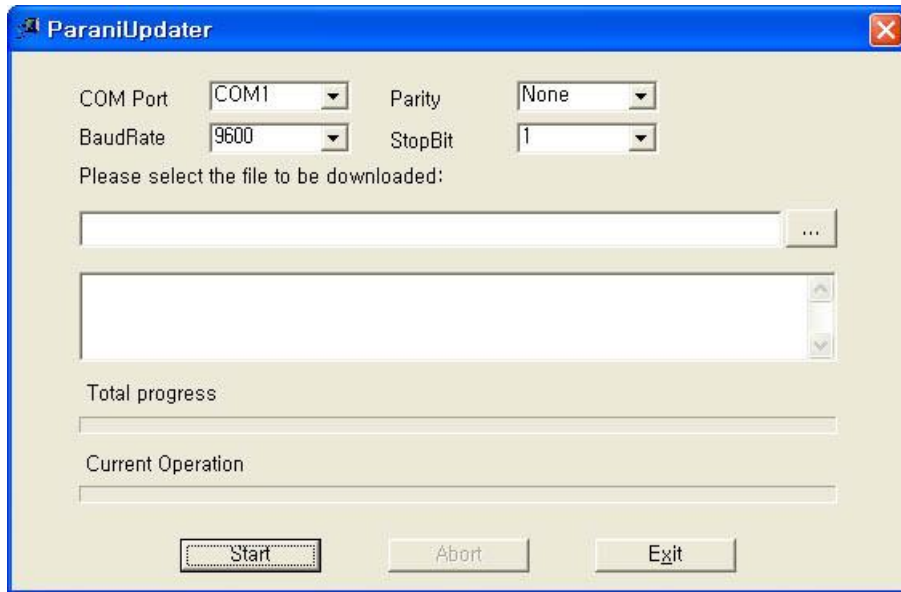

Figure 3-21 ParaniUpdater Window

3.11. Terminal Program

A terminal program is typically an application that will enable a PC to communicate directly with a modem. If you are using Windows 98SE or higher version of Windows, HyperTerminal program is included as part of the operating system. IW05 provides some extended AT commands for configuration of the IW05.

This manual will explain the method using HyperTerminal. If you need to install HyperTerminal, click start>setting>control panel>add/remove programs. For more precise details on HyperTerminal installations, please refer to Microsoft Windows Help section.

Attach IW05 to serial port of host computer and power on the unit.

Launch HyperTerminal. It can be found in start menu >programs >accessories >communication >HyperTerminal. Select the Serial port that IW05 will be connected to.

Input the same settings into Serial port configuration window as IW05 settings.

Select the Serial port setting displayed in the Window, please make sure the serial settings in Hyperterminal are set to the same settings as the IW05's serial settings.

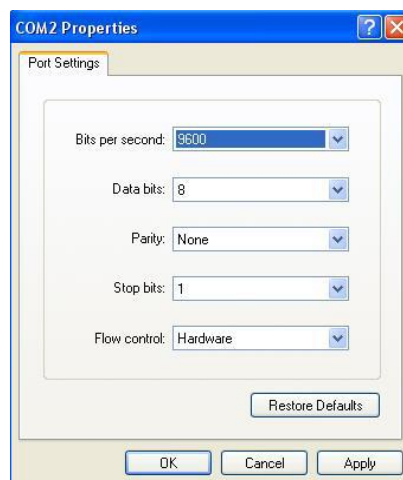

Figure 3-22 HyperTerminal

To view the AT commands that are being typed, you will need to enable the local echo option. Go to File->Properties->Settings->ASCII setup and select the "Echo typed characters locally" option. For expanded AT commands, please refer to Appendix A. AT commands.

Example of AT commands:

```
at
OK
at+btinfo?
000195000144,BCDx10_v2.0.6-000144,MODE0,STANDBY,0,0,NoFC
OK
at+btinq?
000B5320070E,Promi-MSP_20070E,020300
0009DD500027,LEECOM,1E010C
OK
atd000b5320070e
OK
CONNECT 000B5320070E
```

4. Multiple Connection Mode

4.1. Overview

IW05 supports multiple connections up to 4 slave units. There are two types of multiple connection modes: Multi-Drop Mode and Node Switching Mode.

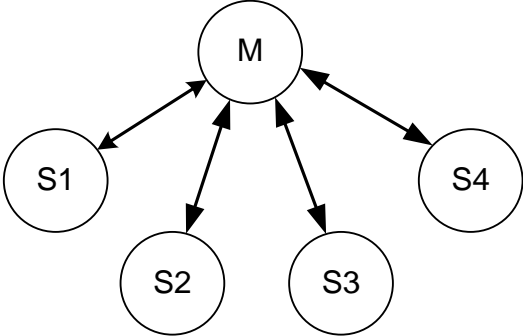

Figure 4-1 Multi-Drop Mode

In Multi-Drop Mode a master unit can connect to maximum 4 slave units at the same time and they transfer data bi-directionally as in Figure 4-1.

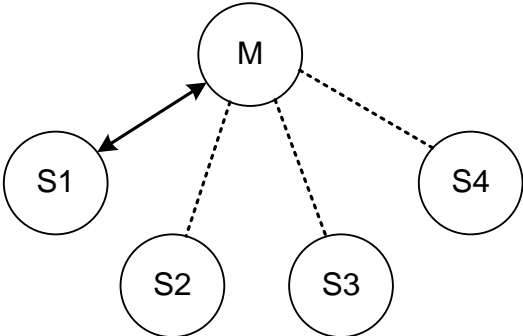

Figure 4-2 Node Switching Mode

In Node Switching Mode, the master unit maintains multiple connections with maximum 4 slave units but only one connection with one slave unit is active and data is transferred as shown in Figure 4-2. After connected to slave, master acts command mode. Active slave is selected by AT commands.

```
On communication after connecting
AT01 - Communicating with #1 Slave
+++
OK
AT0000195000003 - Communicating with slave of BD 000195000003
```

4.2. Configuration

All the slaves should be in the status of waiting for connection either in Mode 2 or Mode 3 and the master unit tries to connect to the slave units. The master unit needs to be configured to work in a multiple connection mode using AT+MULTI,x command, which makes master reboots after execution.

Table 4-1 AT+MULTI,x

AT+MULTI,0	Single Connection Mode
AT+MULTI,1	Multi-Drop Mode
AT+MULTI,2	Node Switching Mode

Table 4-2 Configuration of a Multiple Connection Mode

Manual Connection	Automatic Connection
ATD000195000001 CONNECT000195000001 +++ OK	ATS46=000195000001 OK
ATD000195000002 CONNECT000195000002 +++ OK	ATS54=000195000002 OK
ATD000195000003 CONNECT000195000003 +++ OK	ATS55=000195000003 OK
ATD000195000004 CONNECT000195000004 +++ OK	ATS56=000195000004 OK
	AT+MULTI,1 or AT+MULTI,2 OK
	AT+BTMODE,1 After rebooted automatically master tries to connect to slaves

After input the BD addresses of the slave units into 4 S-registers S46, S54, S55 and S56 and then set operation mode as MODE1, users can use multiple connection function. If S-registers have available slaves' address, AUTO CONNECT message will be displayed following corresponding TASK.

```
TASK1 OK - AUTO CONNECT
TASK2 OK
TASK3 OK - AUTO CONNECT
TASK4 OK
```

4.3. AT Commands

4.3.1. AT+MULTI,n

Select a multiple connection mode. Refer to Table 4-1 for descriptions.

4.3.2. AT+MLIST?

It shows the current mode, the connection status and the BD addresses of slaves.

```
at+mlist?  
  
CURRENT MODE: MULTI DROP  
  
TASK1 - 000195000001  
  
TASK2 - 000195000002  
  
TASK3 - DISCONNECT  
  
TASK4 - 000195000004  
  
OK
```

4.3.3. ATHx, ATHbdaddr

Using the ATH command, connections with all slaves or only connections with specific slaves can be disconnected selectively

Table 4-3 ATH

ATH	Disconnect all the slaves.
ATHx (ATH1, ATH2, ATH3, ATH4)	Disconnect the slave which belongs to the TASK x.
ATHbdaddr (ATH000195000001)	Disconnect the slave with specified BD address.

4.3.4. ATOx, ATObdaddr

Using the ATO command, the communication status with the last active slave or a specific slave can be set to online (only in Node Switching Mode).

Table 4-4 ATO

ATO	Communicate with the slave recently communicated.
ATOx (ATO1, ATO2, ATO3, ATO4)	Communicate with the slave which belongs to the TASK x.
ATObdaddr (ATO000195000001)	Communicate with the slave with specified BD address.

4.4. Notes

When large data exchange occurs in Multi-drop mode without flow-control enabled, the master unit may experience data loss. It may also experience occasional disconnections and/or system rebooting especially when bi-directional communication happens. It is strongly recommended to perform extensive performance test before any real world field applications.

The master unit would try to connect all slave units specified by S-register 46, 54, 55 and 56. If non-existing or inactive slave addresses are entered in these S-registers, the overall performance will degrade due to frequent connection trials to non-existing/inactive slaves. It may also force disconnections for overall performance and outputs disconnect messages repeatedly.

Node-switching mode provides nearly equivalent performance as single connection mode. It is always recommended to use flow-control for both of Multi-Drop Mode and Node Switching Mode.

5. Approval Information

Regulatory Notices

1. FCC

FCC Part 15.19 Statements:

This device complies with Part 15 of the FCC Rules. Operation is subject to the following two conditions: (1) this device may not cause harmful interference, and (2) this device must accept any interference received, including interference that may cause undesired operation.

FCC Part 15.21 statement

Any changes or modifications not expressly approved by the party responsible for compliance could void the user's authority to operate this equipment.

FCC Part 15.105 statement

This equipment has been tested and found to comply with the limits for a Class B digital device, pursuant to part 15 of the FCC Rules.

These limits are designed to provide reasonable protection against harmful interference in a residential installation. This equipment generates, uses and can radiate radio frequency energy and, if not installed and used in accordance with the instructions, may cause harmful interference to radio communications. However, there is no guarantee that interference will not occur in a particular installation. If this equipment does cause harmful interference to radio or television reception, which can be determined by turning the equipment off and on, the user is encouraged to try to correct the interference by one or more of the following measures:

- Reorient or relocate the receiving antenna.
- Increase the separation between the equipment and receiver.
- Connect the equipment into an outlet on a circuit different from that to which the receiver is connected.

OEM Responsibilities to comply with FCC and Industry Canada Regulations

The module has been certified for integration into products only by OEM integrators under the following condition:

- The antenna(s) must be installed such that a minimum separation distance of at least 20 cm is maintained between the radiator (antenna) and all persons at all times.
- The module is limited to installation in mobile or fixed applications.
- The transmitter module must not be co-located or operating in conjunction with any other antenna or transmitter except in accordance with FCC multi-transmitter product procedures.
- Separate approval will be required for all other operating configurations, including portable configurations with respect to Part 2.1093 and different antenna configurations other than supplied antennas.

As long as the two condition above is met, further transmitter testing will not be required. However, the OEM integrator is still responsible for testing their end-product for any additional compliance requirements required with this module installed (for example, digital device emissions, PC peripheral requirements, etc.).

In the event that these conditions cannot be met, then the FCC authorizations are no longer considered valid and the FCC ID cannot be used on the final product. In these circumstances, the OEM integrator will be responsible for re-evaluating the end product including this module and obtaining separate FCC authorizations.

- This device is intended only for OEM integrators
- For OEM integration only – device cannot be sold to general public.
- Manual Information to the End User
The OEM integrator has to be aware not to provide information to the end user regarding how to install or remove this RF module in the user's manual of the end product which integrates this module.
- To ensure compliance for all non-transmitter functions, a host product manufacturer is responsible for ensuring compliance with the module(s) installed and fully operational. Host manufacturer is responsible for ensuring that the host continues to be compliant with the Part 15 subpart B unintentional radiator requirements after the module is installed and operational. The Grantee will provide assistance if necessary.

End Product Labeling

The module is labeled with its own FCC ID and IC Certification Number. If the FCC ID and IC Certification Number are not visible when the module is installed inside another device, then the outside of the device into which the module is installed must also display a label referring to the

enclosed module. In that case, the final end product must be labeled in a visible area with the following:

"Contains FCC ID: S7A-IW05

"Contains IC: 8154A-IW

Hereby, SENA TECHNOLOGIES.Inc Declares that this IW05 is in compliance with the essential requirements and other relevant provisions of directive 1999/5/EC.

2. IC

RSS-GEN, Sec. 7.1.3 – (licence-exempt radio apparatus)

This device complies with Industry Canada licence-exempt RSS standard(s). Operation is subject to the following two conditions: (1) this device may not cause interference, and (2) this device must accept any interference, including interference that may cause undesired operation of the device.

Le présent appareil est conforme aux CNR d'Industrie Canada applicables aux appareils radio exempts de licence. L'exploitation est autorisée aux deux conditions suivantes : (1) l'appareil ne doit pas produire de brouillage, et (2) l'utilisateur de l'appareil doit accepter tout brouillage radioélectrique subi, même si le brouillage est susceptible d'en compromettre le fonctionnement.

RF Exposure

The antenna (or antennas) must be installed so as to maintain at all times a distance minimum of at least 20 cm between the radiation source (antenna) and any individual. This device may not be installed or used in conjunction with any other antenna or transmitter.

l'exposition aux RF

L'antenne (ou les antennes) doit être installée de façon à maintenir à tout instant une distance minimum de au moins 20 cm entre la source de radiation (l'antenne) et toute personne physique.

Caution: Any changes or modifications to this device not explicitly approved by manufacturer could void your authority to operate this equipment. Attention:

Les changements ou modifications de cet appareil non expressément approuvé par le fabricant peuvent annuler votre droit à utiliser cet équipement.

Étiquetage du produit final (IC)

Le module est étiqueté avec sa propre identification FCC et son propre numéro de certification IC. Si l'identification FCC et le numéro de certification IC ne sont pas visibles lorsque le module est installé à l'intérieur d'un autre dispositif, la partie externe du dispositif dans lequel le module est installé devra également présenter une étiquette faisant référence au module inclus. Dans ce cas, le produit final devra être étiqueté sur une zone visible avec les informations suivantes :

« Contient module émetteur identification FCC ID : S7A-IW05

« Contient module émetteur IC : 8154A-IW

5.1.1. Do not

Any changes or modifications to the equipment not expressly approved by the party responsible for compliance could void user's authority to operate the equipment.

6. RF Information

6.1. Radio Frequency Range

2.402~2.480GHz

6.2. Number of Frequency Channel

79 channels

6.3. Transmission Method

FHSS(Frequency Hopping Spread Spectrum)

6.4. Modulation Method

1Mbps: GFSK(Gaussian Frequency Shift Keying)

2Mbps: $\pi/4$ DQPSK($\pi/4$ rotated Differential Quaternary Phase Shift Keying)

3Mbps: 8DPSK(8 phase Differential Phase Shift Keying)

6.5. Receiving Sensitivity

Products	Receiving Sensitivity
IW05-DU	-90dBm
Parani-BCD210	-84dBm

6.6. Power Supply

Products	Power Supply
IW05	DC3.3V

Appendix A: Connections

A.1. Pin Assignment

A.1.1. IW05-DU

	NAME	DEFINE
1	GND	GND
2	GND	GND
3	PVCC	PVCC (+3.3V)
4	AI0_0	
5	AI0_1	
6	UART_RTS	UART_RTS
7	UART_RXD	UART_RXD
8	UART_TXD	UART_TXD
9	UART_CTS	UART_CTS
10	USB_DN	USB_DN
11	USB_DP	USB_DP
12	PCM_IN	PCM_IN
13	PCM_SYNC	PCM_SYNC
14	PCM_CLK	PCM_CLK
15	PCM_OUT	PCM_OUT
16	+3V3	+3V3
17	GND	GND
18	RESETB	RESETB

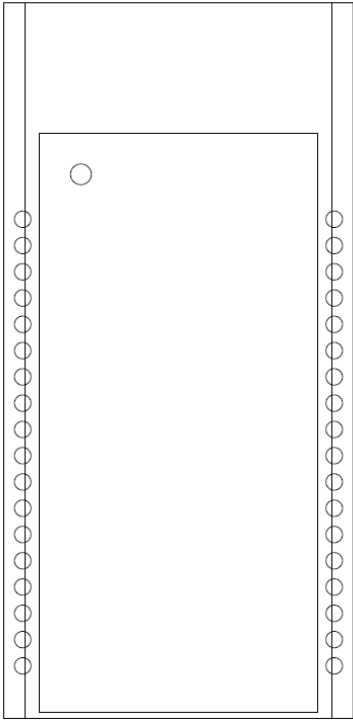

DEFINE	NAME	
GND	GND	36
GND	GND	35
GND	GND	34
STATUS_LED1	PIO_11	33
STATUS_LED0	PIO_10	32
	PIO_9	31
	PIO_8	30
UART_DCD	PIO_2	29
UART_DTR	PIO_3	28
F/C_CTRL	PIO_7	27
BT_MODE	PIO_6	26
FACTORY RESET	PIO_5	25
UART_DSR	PIO_4	24
SPI_MOSI	SPI_MOSI	23
SPI_CSB	SPI_CSB	22
SPI_CLK	SPI_CLK	21
SPI_MISO	SPI_MISO	20
GND	GND	19

Table A-1. Pin Assignment of IW05-DU (SPP)

Pin	Pin Name (SPP Define)	Direction IN/OUT	Pin State	Description
1	GND	-	-	Ground
2	GND	-	-	Ground
3	PVCC	-	-	Power supply for power amplifier, 3.3V
4	N/A	-	-	-
5	N/A	-	-	-
6	UART_RTS	OUT	Pull-up	UART request to send active low
7	UART_RXD	IN	Pull-down	UART data input
8	UART_TXD	OUT	Pull-up	UART data output
9	UART_CTS	IN	Pull-down	UART clear to send active low
10	N/A	-	-	-
11	N/A	-	-	-
12	N/A	-	-	-
13	N/A	-	-	-
14	N/A	-	-	-
15	N/A	-	-	-
16	+3V3	-	-	Power supply for system, 3.3V
17	GND	-	-	Ground
18	RESETB	IN	Pull-up	Reset, active low, > 5ms to cause a reset
19	GND	-	-	Ground
20	N/A	-	-	-
21	N/A	-	-	-
22	N/A	-	-	-
23	N/A	-	-	-
24	UART_DSR	IN	Pull-up	UART data set ready
25	FACTORY_RESET	IN	Pull-up	Input for factory default setting, (Active 'L')
26	BT_MODE	IN	Pull-up	Input for pairing mode
27	F/C_CTRL	OUT	Pull-up	Output for UART flow control ON/OFF
28	UART_DTR	OUT	Pull-down	UART data terminal ready
29	UART_DCD	OUT	Pull-down	UART data carrier detect
30	N/A	-	-	-
31	N/A	-	-	-
32	STATUS_LED0	OUT	Pull-down	Output for Bluetooth status display, LED0
33	STATUS_LED1	OUT	Pull-down	Output for Bluetooth status display, LED1
34	GND	-	-	Ground
35	GND	-	-	Ground
36	GND	-	-	Ground

A.1.2. Bluetooth Connection Detect(UART_DCD) Signal

Status of Bluetooth connection will be delivered to Host PC via UART_DCD signal. When Bluetooth connection is made, UART_DCD signal will be set to low.

A.1.3. Factory Reset(FACTORY_RESET) Signal

Factory reset signal will be used for setting the IW05 to factory defaults. Factory reset signal should be on 0V status for at least 1 second for the reset to occur.

A.1.4. Pairing (BT_MODE) Signal (Single Connection Mode Only)

IW05 provides a pairing signal input for instant configuration and automatic connection to two IW05s. In this example, we will name the two IW05s as BCD1 and BCD2 In pairing mode.

Step 1. Turn on BCD1 and BCD2 and do factory default both of them by using RST signal.

Step 2. Set the pairing signal of BCD1 to a low state and hold the signal for 2 seconds.

Step 3. Set the pairing signal of BCD2 to a low state and hold the signal for 2 seconds.

Set the pairing signal of BCD2 to high state and hold the signal for 2 seconds. Now Set the pairing signal of BCD2 to low state and hold it for 2 seconds

Step 4. Wait for BCD1 & BCD2 to connect to each other. It may take about 10 seconds to make a connection. If there are many Bluetooth devices nearby, the connection time may increase.

Step 5. At this point your pair of IW05 is configured to make automatic connection to each other.

You can now use this pair of IW05's like virtual serial cable.

* Note : During the pairing process, by way of the pairing signal, the Command Response will be deactivated. Thus, the IW05 will not send the response messages such as OK, Connect and Disconnect.

Table A-2 Pairing Process by Pairing Signal

BCD1	Status	Pairing Signal	BCD2	Status	Pairing Signal
1. Reset	Mode0	HIGH	1. Reset	Mode0	HIGH
2. Drop pairing signal	Mode3	LOW	2. Drop pairing signal	Mode3	LOW
3.Restore pairing signal	Mode3	HIGH	3.Restore pairing signal	Mode3	HIGH
			4. Drop pairing signal	Mode1	LOW
			5.Restore pairing signal	Mode1	HIGH
6. Connected	Slave	HIGH	6. Connected	Master	HIGH

Using pairing button, users can make a pairing connection between a IW05 unit and other Bluetooth devices.

Step 1. Turn on BCD1 and do factory default by using RST signal.

Step 2. Set the pairing signal of BCD1 to a low state and hold the signal for 2 seconds.

Step 3. Users can discover and connect to BCD1 by using the software or user interface of other Bluetooth device that they want to connect from.

Step 4. Wait for BCD1 & other Bluetooth device to connect to each other. It may take about 10 seconds to make a connection. If there are many Bluetooth devices nearby, the connection time may increase.

Step 5. Now BCD1 is waiting for a connection from the last connected Bluetooth device. The last connected Bluetooth device can connect to BCD1.

Table A-3 Pairing Process with other Bluetooth device by Pairing Signal

BCD1	Status	Pairing Signal	Other Bluetooth Device	Status
1. Reset	Mode0	HIGH		
2. Drop pairing signal	Mode3	LOW		
			3. Inquiry and connect to BCD1	
4. Connected	Slave	HIGH	4. Connected	Master

A.1.5. Flow Control(FC_CTRL) On/Off Signal

If user wants to set the status of hardware flow control option using AT+UARTCONFIG command, FC_CTRL signal should be connected with UART_CTS signal.

If Hwfc parameter in AT+UARTCONFIG command is set to 1, FC_CTRL signal is set to high and then hardware flow control is enabled. And if Hwfc parameter in AT+UARTCONFIG command is set to 0, FC_CTRL signal is set to low and then hardware flow control is disabled.

A.1.6. Bluetooth Status LED(STATUS_LED0, STATUS_LED1) Signal

<STATUS_LED0>

- If any Bluetooth device is connected, this signal is set to high during 150msec periodically after low status during 1 sec.

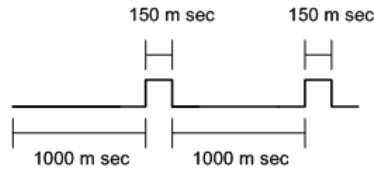

<STATUS_LED1>

- When the connection status is Standby, this signal is set to high.
- When the connection status is Pending, this signal is toggled 3 times periodically after low status during 1 sec.

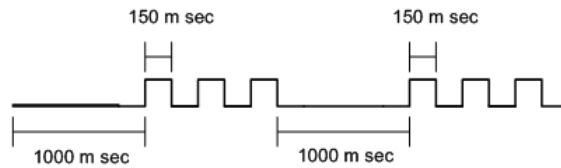

- When the connection status is Connect, this signal is set to low.

A.1.7. Reset Signal

IW05 can be reset from one of following sources:

- RESETB pin
- Power on reset
- UART break character
- Software configured watchdog timer

The RESETB pin is an active low signal and is internally filtered using the internal low frequency clock oscillator. A reset will be performed between 1.5 and 4.0ms following RESETB being active. So it is recommended that RESETB be applied for a period greater than 5ms.

A.2. Connection Diagram

A.2.1. IW-05DU

A.2.1.1. When TTL level of MICOM is 3.3V

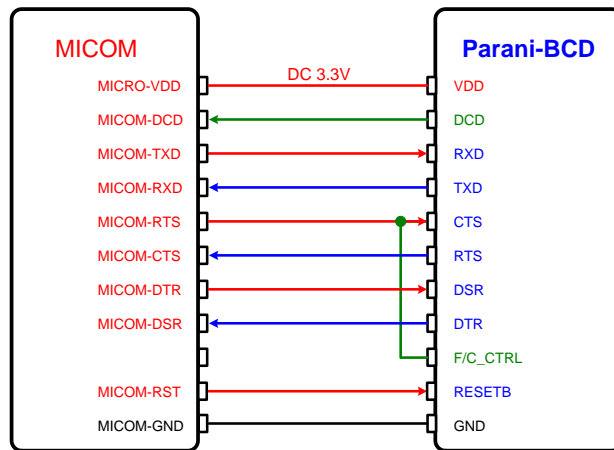

A.2.1.2. When TTL level of MICOM is 3.3V and Hardware Flow Control is not used

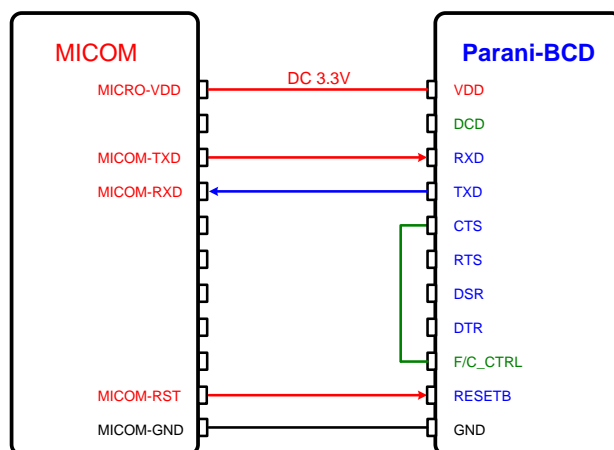

A.2.1.3. When TTL level of MICOM is 5V

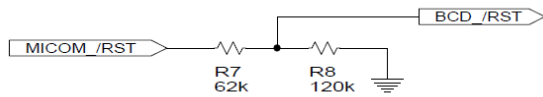
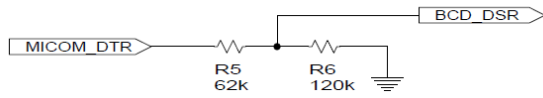
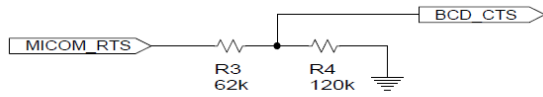
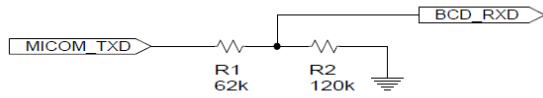
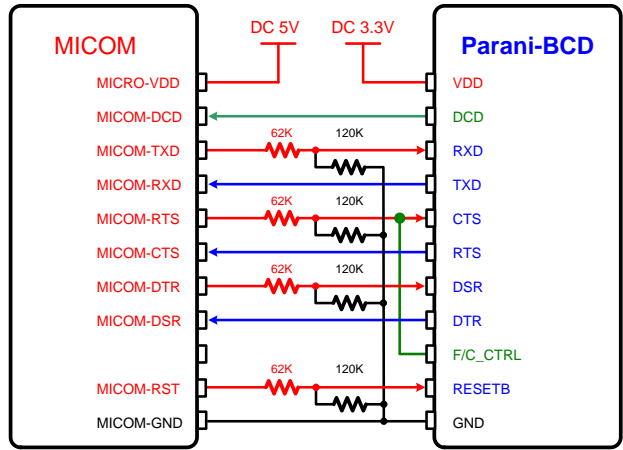

Appendix B: AT Commands

B.1. Terminology

B.1.1. AT Command

AT command set is a in fact standard language for controlling modems. The AT command set was developed by Hayes and is recognized by virtually all personal computer modems. IW05 provides the extended AT command set to control and configure the serial parameters and Bluetooth connection.

B.1.2. AT Response

IW05 replies to AT commands with 4 kinds of message, 'OK', 'ERROR', 'CONNECT' and 'DISCONNECT'.

B.1.3. Operation Mode

Mode	Description
Mode0	Waiting for AT commands
Mode1	Attempting to connect to the last connected Bluetooth device
Mode2	Waiting for a connection from the last connected Bluetooth device
Mode3	Waiting for the connection from another Bluetooth device

B.1.4. Operation Status

Status	Description
Standby	Waiting for AT commands
Pending	Executing tasks
Connect	Transmitting data

B.1.5. Security

Security	Description
Authentication	Pin Code (or Pass key)
Encryption	Data encryption

B.1.6. Symbols

The symbols are used for the description of command syntax as follows:

Symbols	Meaning	ASCII Code
---------	---------	------------

↵	Carriage return	0x0D
↵	Line feed	0x0A
↵↵	Carriage return + Line feed	
112233445566	Bluetooth device address	
N or m	One digit decimal number	
To	Timeout in seconds	

B.2. Command Category

Command Category		Index	AT Commands			
RESET		1 2	ATZ AT&F			
SERIAL PORT		3 4	AT AT+UARTCONFIG,b,p,s,h			
BLUETOOTH	Information	5 6 7 8 9 10	AT+BTINFO? AT+BTINQ? AT+BTLAST? AT+BTVER? AT+BTRSSI,n AT+MLIST?			
		Mode	11 12	AT+BTMODE,n AT+MULTI,n		
			Status	13 14 15 16 17 18 19	+++ AT+SETESC,nn ATO AT+BTCANCEL AT+BTSCAN AT+BTSCAN,n,to AT+BTSCAN112233445566,to	
		Connection		20 21 22 23 24	ATD ATD112233445566 ATA ATA112233445566 ATH	
				Security	25 26 27 28 29	AT+BTKEY=\$string AT+BTSD? AT+BTCSD AT+BTFP,n AT+BTSEC,a,e
					Miscellaneous	30 31
	REMOTE CONFIGURATION					32 33 AT+PASS="nnnnnnnn" AT+CHPASS="nnnnnnnn"
	S-REGISTER				34 35 36	AT&V ATSnn? ATSnn=mm

B.3. Command Description

B.3.1. ATZ↵

Response	↵OK↵
Purpose	Software Reset
Description	This has the same effects as Powercycling the unit. This command disconnects any connected Bluetooth device, and stops ongoing tasks. After rebooting, the status will be decided by the preset operation mode. Some AT commands require the ATZ command be run so that the commands can take effect.

B.3.2. AT&F↵

Response	↵OK↵
Purpose	Hardware reset
Description	This has the same effect as initialization by pressing the factory reset button. All parameters are initialized to factory defaults

B.3.3. AT↵

Response	↵OK↵
Purpose	Check the connection status with host equipment
Description	Check if the connection to host equipment is operating normally. The serial parameters of IW05 must be same as those of host equipment. If not, the IW05 will not respond or 'ERROR' message will appear or an abnormal sequence of strings will appear.

B.3.4. AT+UARTCONFIG,Baudrate,Parity,Stopbit,Hwfc↵

Response	↵OK↵
Purpose	Set Serial parameters
Parameters	Baudrate=1200/2400/4800/9600/14400/19200/38400/57600/115200/230400/460800/921600 (Default=9600) Parity=N/E/O (Default=N) Stopbit=1/2 (Default=1) Hwfc(Hardware Flow Control)=0/1 (Default=1)
Description	The Serial parameters can be set or changed. The factory default is 9600, N, 1, 1. To take effect the ATZ command must be used or Powercycle the unit.
Example	AT+UARTCONFIG,115200,N,1,1

B.3.5. AT+BTINFO?↵

Response	↵112233445566,DeviceName,Mode,Status,Auth,Encryp,FlowControl↵ ↵OK↵
Purpose	Display Bluetooth settings
Description	The current Bluetooth settings are displayed including BD address, Device name, Operation mode, Operation status, Authentication, Data Encryption, and Hardware Flow

	Control. The initial value of Device name is 'BCDx10_v2.0.6-445566'. BCD stands for IW05, v2.0.6 for the version of firmware, and 445566 for the last 6 digits of BD address. Mode=MODE0/MODE1/MODE2/MODE3 Status=STANDBY/PENDING/CONNECT Auth=0/1 (Authentication is not activated when 0) Encrypt=0/1 (Encryption is not activated when 0) FlowControl=HWFC/NoFC
Example	↵000B530011FF,SENA,MODE0,PENDING,1,1,HWFC↵

B.3.6. AT+BTINQ?↵

Response	↵112233445566,FriendlyName,CoD↵ ↵112233445566,FriendlyName,CoD↵ ↵112233445566,FriendlyName,CoD↵ ↵OK↵
Purpose	Search Bluetooth devices nearby
Description	The Bluetooth devices in Inquiry scan mode nearby are displayed with their BD addresses, Device names, and Class of device. Maximum 15 devices are scanned for 30 seconds. (Default 15 value in S-register 24)

B.3.7. AT+BTLAST?↵

Response	↵112233445566↵
Purpose	Display the BD address of the last connected device
Description	The Bluetooth device last connected to this IW05 is displayed with its BD address.

B.3.8. AT+BTVER?↵

Response	↵BCDX10_v2.0.6↵ ↵OK↵
Purpose	Display device firmware version
Description	Display device firmware version

B.3.9. AT+BTRSSI,n↵(Single Connection Mode Only)

Response	↵OK↵ ↵0,255,0,0↵ (repeatedly)
Purpose	Test signal strength
Parameters	n=0: Stop signal strength test n=1: Start signal strength test
Description	When Bluetooth connection is established, you can use this command in Standby status. The signal strength will be displayed repeatedly in order of Status, LinkQuality, Status, RSSI. If the LinkQuality is close to 255 and RSSI is close to 0, the signal strength is in good standing.
Example	+++ AT+BTRSSI,1 ↵OK↵ 0,255,0,0

B.3.10. AT+MLIST?

Response	↵CURRENT MODE:SINGLE CONNECTION MODE↵ ↵OK↵
Purpose	Display the current multiple connection mode and connected slave's Bluetooth addresses.
Description	Display current mode(SINGLE CONNECTION MODE , MULTI-DROP MODE, NODE SWITCHING MODE) and connected slave Bluetooth address.
Example	AT+MLIST? CURRENT MODE: MULTI-DROP MODE TASK1 – 000195000001 TASK2 – DISCONNECT TASK3 – DISCONNECT TASK4 – 000195000004

B.3.11. AT+BTMODE,n

Response	↵OK↵
Purpose	Set operation mode
Parameters	n=0: MODE0 (Default) n=1: MODE1 n=2: MODE2 n=3: MODE3
Description	When the operation status is 'Pending' currently, change the status to 'Standby' with AT+BTCANCEL prior to this command. To take effect the ATZ must be executed or Powercycle the unit
Example	AT+BTMODE,2 ↵OK↵ ATZ

B.3.12. AT+MULTI,n

Response	(n = 0) ↵OK↵ (n = 1 or n = 2) ↵TASK1 OK↵ TASK2 OK↵ TASK3 OK↵ TASK4 OK↵
Purpose	Set multiple connection mode
Parameters	n=0: Single Connection Mode (Default) n=1: Multi-Drop Mode n=2: Node Switching Mode
Description	Set single connection mode, multi-drop mode or node switching mode.

B.3.13. +++

Response	↵OK↵
Purpose	Convert the operation status of 'Connect' to 'Standby'
Description	In 'Connect' status, data from host is transmitted to the other side Bluetooth device, and any AT command is not accepted but this command, which is not echoed on the screen. When IW05 encounters a character '+' from host, it stops the data transmission and waits

	<p>for next 2 characters. If the next 2 characters aren't both '+', it restart to transmit data including the first '+' as well. If not, it converts the operation status to 'Standby'. If the data from host includes '+++', it will convert the operation status to 'Standby'. Notice that IW05 holds data transmission when it encounters '+', until receiving next character. '+' is an escape sequence character by default, which is changeable by AT+SETESC. * Caution : In low power mode, you cannot change online status to command waiting status by using the '+++' string. Entering the '+++' string during low power mode and online status may entail unexpected errors.</p>
--	--

B.3.14. AT+SETESC,nn

Response	↵OK↵
Purpose	Change the escape sequence character
Description	Escape sequence character set to '+' by default is changeable. The parameter nn must be a printable character.
Example	AT+SETESC,42

B.3.15. ATO (ATOx, ATObdaddr)

Response	None
Purpose	Convert the operation status of 'Standby' to 'Connect'
Description	You can convert the operation status of 'Standby' to 'Connect' ready to transmit data. In Node Switching mode, a specific slave can be specified to become an active connection by specifying the connection number or the Bluetooth address.
Example	ATO ATO3 ATO000195000001

B.3.16. AT+BTCANCEL

Response	↵OK↵
Purpose	Terminate the current executing task
Description	This terminates a current executing task, such as Inquiry scan and Page scan, then converts the operation status to 'Standby'

B.3.17. AT+BTSCAN

Response	↵OK↵ ↵CONNECT 112233445566↵
Purpose	Wait for inquiry and connection from other Bluetooth devices
Description	This allows the inquiry and connection from the other Bluetooth devices. The operation status will be in 'Pending' after this command. When connection is made and released, the operation status is back to 'Pending'. To convert the operation status to 'Standby' AT+BTCANCEL must be used. This has the same effect as AT+BTSCAN,3,0. When connection is made with other Bluetooth device, response will be 'CONNECT' with its BD address.

B.3.18. AT+BTSCAN,n,to

Response	↵OK↵ ↵CONNECT 112233445566↵ or ↵OK↵ ↵ERROR↵
Purpose	Wait for inquiry and connection from other Bluetooth devices for a given duration
Parameters	n=1: Allows Inquiry scan n=2: Allows Page scan n=3: Allows both of Inquiry scan and Page scan to= Time duration in seconds
Description	For the given to, IW05 is waiting for the inquiry and connection from other Bluetooth devices. If parameter is set to 0, it will wait forever. When connection is made with other Bluetooth device, response will be 'CONNECT' with its BD address. If there is no connection made within this time duration, response is 'ERROR' and the operation status becomes to 'Standby'.
Example	AT+BTSCAN,2,30

B.3.19. AT+BTSCAN112233445566,to↵

Response	↵OK↵ ↵CONNECT 112233445566↵ or ↵OK↵ ↵ERROR↵
Purpose	Wait for connection by the Bluetooth device with given BD address
Parameters	112233445566=BD address to= time duration in seconds
Description	IW05 will wait to be connected to by the Bluetooth device with the given BD address. If parameter is set to 0, it will wait forever. When connection is made with the Bluetooth device, response will be 'CONNECT' with its BD address. If there is no connection made within this time duration, response is 'ERROR' and the operation status becomes to 'Standby'.
Example	AT+BTSCAN000B530011FF,30

B.3.20. ATD↵

Response	↵OK↵ ↵CONNECT 112233445566↵ or ↵OK↵ ↵ERROR↵
Purpose	Connect to the last connected Bluetooth device
Description	IW05 saves the BD address of the Bluetooth device most recently connected to. If it fails to make a connection, response will display an 'ERROR'.

B.3.21. ATD112233445566↵

Response	↵OK↵ ↵CONNECT 112233445566↵ or ↵OK↵ ↵ERROR↵
-----------------	---

Purpose	Connect to a specific Bluetooth device with a given BD address
Parameters	112233445566=BD address
Description	IW05 attempts to connect to the Bluetooth device with the given BD address. To make successful connection, the Bluetooth device must be in Page scan mode. This attempt continues for 5 minutes. If it fails to make connection, response is 'ERROR'.
Example	ATD000B530011FF

B.3.22. ATA⁻

Response	↵OK↵ ↵Start ACL Open↵ ↵ACL Connect Success↵
Purpose	ACL connect to the last connected Bluetooth device
Description	If it make connection, response will display an 'ACL Connect Success'. Must have reboot for new ACL connection.

B.3.23. ATA112233445566⁻

Response	↵OK↵ ↵Start ACL Open↵ ↵ACL Connect Success↵
Purpose	ACL connect to a specific Bluetooth device with a given BD address
Parameters	112233445566 = BD address
Description	IW05 attempts to ACL connect to the Bluetooth device with the given BD address. To make successful ACL connection, the Bluetooth device must be in Page scan mode. If it makes connection, response will display an 'ACL Connect Success'. Must have reboot for new ACL connection.
Example	ATA0001950011FF

B.3.24. ATH⁻ (ATHx, ATHbdaddr)

Response	↵OK↵ ↵DISCONNECT↵
Purpose	Release the current connection
Description	The current Bluetooth connection will be disconnected. It takes about Supervision Timeout(S37) to detect an abnormal disconnection such as power off and moving out of service range. In multiple connection modes, a specific connection can be specified to be disconnected by specifying the connection number or the Bluetooth address. The response message of 'DISCONNECT' may be displayed on disconnection depending on the disconnection condition. You can make it not displayed using S10 register.
Example	ATH ATH3 ATH000195000001

B.3.25. AT+BTKEY=\$string⁻

Response	↵OK↵
Purpose	Change pin code
Parameters	<i>\$string</i> = New pin code (Default="1234")
Description	Pin code is a string, which allows up to 16 alpha-numeric characters. Based on this pin code, IW05 generates a link key which is used in actual authentication process
Example	AT+BTKEY="apple"

B.3.26. AT+BTSD? ↵

Response	↵112233445566↵ ↵OK↵
Purpose	Display a list of Bluetooth devices sharing the same pin code
Description	Once a connection is made with a pin code, IW05 saves the Bluetooth device with its link key, generated by the pin code. The connection to a device listed in IW05 can be made automatically without the authentication process. The maximum number kept on the list is 7.

B.3.27. AT+BTCSD ↵

Response	↵OK↵
Purpose	Clear the list of Bluetooth devices sharing the same pin code
Description	This clears the list of Bluetooth devices linked with the same key in flash memory. To take effect the ATZ command must be used or Powercycle the unit.

B.3.28. AT+BTFP,*n* ↵

Response	↵OK↵
Purpose	Set generation of link key every time of connection
Parameters	<i>n</i> =0: Inactivate (Default) <i>n</i> =1: Activate
Description	If <i>n</i> is set to 1, IW05 asks for the pin code every time a connection is made. This can be used to increase security.

B.3.29. AT+BTSEC,*Authentication*,*Encryption* ↵

Response	↵OK↵
Purpose	Set authentication and data encryption
Parameters	<i>Authentication</i> =0: Inactivate (Default) <i>Authentication</i> =1: Activate <i>Encryption</i> =0: Inactivate (Default) <i>Encryption</i> =1: Activate
Description	If the authentication is activated, the pin code must be set by AT+BTKEY command. Data encryption cannot be used when authentication is not enabled, i.e. <i>Authentication</i> =0 and <i>Encryption</i> =1 will not work properly.

B.3.30. AT+BTNAME=*\$string* ↵

Response	↵OK↵
Purpose	Change device name
Parameters	<i>\$string</i> = New device name (Default="BCDx10_v2.0.6-445566")
Description	IW05 can have a user friendly name for easy identification. The name allows up to 30 alpha-numeric characters.
Example	AT+BTNAME="My-Parani-BCD "

B.3.31. AT+BTLPM,*n*↵

Response	↵OK↵
Purpose	Set low power mode
Parameters	<i>n</i> =0: Inactivate (Default) <i>n</i> =1: Activate
Description	During no data transmission, IW05 can be in low power mode to save the power. Low Power Timeout is set to S-register S52. So if low power mode is activated and if there is no data transfer during a period specified in S52, IW05 will be entered low power mode. Please note that it takes a few seconds to make the IW05 out of low power mode.

B.3.32. AT+PASS=*\$string*↵

Response	Remote Configuration Enabled↵
Purpose	Input password in remote configuration mode.
Parameters	<i>\$string</i> = Password (Default="0000")
Description	Input password for authentication in remote configuration mode.
Example	AT+PASS=1234

B.3.33. AT+CHPASS=*\$string*↵

Response	↵OK↵
Purpose	Change password used in remote configuration mode.
Parameters	<i>\$string</i> = New password
Description	Change password used in remote configuration mode. Password length is up to 8.
Example	AT+CHPASS=12345678

B.3.34. AT&V↵

Response	↵S0:m0;S1:m1; ...Sn:mn↵ ↵OK↵
Purpose	Display all the S-registers
Description	All parameters are stored at S-register in flash memory. These values are sustained until hardware reset.

B.3.35. ATSn? ↵

Response	↵value↵ ↵OK↵
Purpose	Display a given S-register
Parameters	nn= Address of S-register
Description	A specific S-register will be displayed.

B.3.36. AT\$nn=mm↵

Response	↵OK↵
Purpose	Change S-register value
Parameters	nn= Address of S-register mm= New value of S-register
Description	Some S-registers are optimized for the overall performance and protected and cannot be changed. When users try to change these S-registers, response is 'ERROR'. For details of S-register, refer Appendix. B.
Example	ATS10=0

B.4. Command Validity

AT Command	Operation Status		
	Standby	Pending	Connect
AT	○	○	
ATZ	○	○	
AT&F	○	○	
AT+BINQ?	⊙		
ATD112233445566	⊙		
ATD	⊙		
ATA112233445566	⊙		
ATA	⊙		
AT+BTSCAN	⊙		
AT+BTSCAN,n,to	⊙		
AT+BTSCAN112233445566,to	⊙		
AT+BTCANCEL		○	
+++			○
AT+SETESC	⊙		
ATO	●		
ATH	●		
AT+BTSEC,Auth,Encr	⊙		
AT+BTLAST?	○	○	

AT+BTMODEn	⊙		
AT+BTNAME="Name"	⊙		
AT+BTKEY="nnnn"	⊙		
AT+BTINFO?	○		
AT+BTLPM,n	⊙		
AT+BTSD?	○	○	
AT+BTCSD	⊙		
AT+BTFP,n	⊙		
AT+UARTCONFIG,b,p,s,h	⊙		
AT+BTVER?	○	○	
AT+BTRSSI,n	●		
AT+PASS="nnnnnnnn"	○	○	
AT+CHPASS="nnnnnnnn"	○	○	

⊙ Valid only when IW05 is not connected to other Bluetooth device.

● Valid only when IW05 is connected to other Bluetooth device.

Appendix C: S-Register

S-registers contain 52 parameters for the IW05. These are stored in flash memory and the values will be saved unless hardware reset is executed. The value of S-register can be accessed and changed with ATS command. Some S-registers not shown below are set to maximize the performance of IW05. Thus it is not recommended to change these S-registers.

Change the value of S-register only in Standby status. Turn IW05 off and on.

C.1. S1: Force to Reconnect (default 1)

S1=0, IW05 in Mode1 does not try to reconnect when disconnected.

S1=1, IW05 in Mode1 keeps trying to reconnect when disconnected.

C.2. S3: Stream UART Policy (default 0)

S3=0, the priority of UART streaming is throughput.

S3=1, the priority is latency, which minimizes the delay of data transmission. This is useful in case of transmitting very small data quickly.

When this value is 1, in order to minimize latency, IW05 sends the received data immediately. When this value is 0, the IW05 maximizes throughput, the IW05 stores received data for a short time and sends a large data packet. If the packet length is less than 100 bytes, having latency being the priority is recommended. If the packet length is more than 100 bytes, having throughput as the priority is recommended. Also, if you want to use high baud rate, throughput priority will be more effective. Just for reference, the buffer length for receiving data is 2 Kbytes.

C.3. S4: Enable Remote Name Query (default 1)

S4=0, IW05 will query only the BD address. This speeds up the inquiry process.

S4=1, IW05 will query the BD address, device name and class of device.

When this value is 1, IW05 finds not only BD address but also friendly name. When this value is 0, IW05 finds only BD address. When set to 0 this will make queries much faster. When using the pairing button, finding friendly name will be omitted automatically.

C.4. S6: Enable Low Power Mode (default 0)

S6=0, deactivate Low Power Mode.

S6=1, activate Low Power Mode.

This value decides whether IW05 works in Low Power Mode or not. When this value is 0, IW05 works only in active power mode. When this value is 1, IW05 will be in low power mode to save the power. Therefore, it takes a few seconds to wake the IW05 out of low power mode.

C.5. S10: Enable Response Message (default 1)

S10=0, IW05 does not send response messages to the host system.

S10=1, IW05 sends response messages to host system.

This value decides whether IW05 sends response messages such as OK, ERROR, CONNECT, DISCONNECT or not. When this value is 0, IW05 will not send any response messages. If the response messages conflicts with your host programs or devices that is connected to IW05, change this value to 0.

C.6. S11: Enable Escape (default 1)

S11=0, IW05 does not allow escape sequence characters. The operation status of Connect cannot be changed to Standby. Since the IW05 skips the process of detecting escape sequence characters, more efficient data transmission can be had.

S11=1, IW05 allows for the escape sequence character. Whenever it is needed, the Connect status can be changed to Standby.

C.7. S12: Clear Data Buffer When Disconnected (default 0)

S12=0, IW05 does not clear the data buffer received from host system when disconnected.
S12=1, IW05 clears the data buffer when disconnected.

C.8. S13: Enable DCD Signal (default 1)

S13=0, DCD signal off
S13=1, DCD signal on

C.9. S14: Enable DTR Transfer (default 1)

S14=0, DTR/DSR signal is transferred in a loop-back fashion..
S14=1, DTR signal is transferred to DSR of remote device.

C.10. S15: Enable Disconnect by DTR (default 0)

S15=0, DTR signal cannot release the connection.
S15=1, The Bluetooth connection can be released when DTR signal is off.
This value decides whether Bluetooth connection is released when DTR signal drops or not. If this value is 1, you can use DTR signal in order to disconnect Bluetooth connection.

C.11. S22: Faster Connection (default 3)

S22=0, none
S22=1, page scan
S22=2, inquiry scan
S22=3, page/inquiry scan
Connecting time is average 1.5sec faster than normal mode.

C.12. S23: Intercharacter Timeout Setting (default 0)

S23=0: Not used
S23=1: 1 x S26
S23=2: 10 x S26
S23=3: 100 x S26

C.13. S24: Maximum Number of Inquiry Result (default 15)

The maximum number of inquiry list can be controlled. This value can be set up to 15.
(If 0 is set, inquiry is performed without limitation on number of inquiry list.)

C.14. S26: Intercharacter Timeout (default 0)

This value describes time interval between characters used to separate the data from serial port. If there is no more data coming from serial port in this value, data is sent to client.

S23=1 x S26=50: Timeout-> 50msec
S23=2 x S26=50: Timeout-> 500msec
S23=3 x S26=3: Timeout-> 300msec

Inter Character Time Out	* Optimal Value(S23 x S26)
50ms	180
100ms	235
200ms	340

* When 10 bytes data are sent every intercharacter timeout, they are sent separately by 10 bytes at the optimal value. If the intercharacter timeout is set below the optimal value, the data will be put together and sent by 20, 30, 40 bytes or more.

C.15. S28: Escape Sequence Character (default 43)

The decimal number of the ASCII code of escape sequence character can be controlled. The initial value is 43, the ASCII code of '+'. .

C.16. S31: Page Timeout (default 20)

This is the timeout in seconds to attempt connection with the ATD command. After this timeout expires, the IW05 will restart automatically. If this value is 0, IW05 will attempt to connect without restarting. . It must set at 5 second units.

C.17. S33: Inquiry Timeout (default 30)

This is the timeout in seconds to execute inquiry scan.

C.18. S37: Supervision Timeout (default 5)

This is the timeout to presume disconnection, which is set to 5 seconds initially. The smaller the value becomes, the more quickly IW05 can detect an abnormal disconnection. But when the communication is suspended, it may be regarded as disconnection. This value should be greater than the Slave Disconnect Timeout(S57). (Slave unit depends on the value of master unit.)

C.19. S43: COD (default 001F00)

This value describes the sort of the Bluetooth device and is editable.

C.20. S44: COD Filter (default 0)

This value is used to filter the sort of the Bluetooth devices on inquiring. All the Bluetooth devices are inquired in case of 0. In case of 3E0100, Bluetooth devices with CoD 3E0100 are inquired.

C.21. S45: Inquiry Access Code (default 0x9E8B33)

Inquiry access code is used during inquiry state. The reserved IAC addresses are 0x9E8B00 ~ 0x9E8B3F. The general inquiry IAC is 0x9E8B33.

IW05 is able to find the Bluetooth devices that are configured as the same IAC.

C.22. S46: BD Address of Last Connected Device

This saves the BD address of the Bluetooth device connected most recently in single connection mode. This saves the Task1 BD address of the Bluetooth device connected most recently in a multiple connection mode.

C.23. S48: Low Power Max Interval (default 5000)

This is the max interval value to use low power mode, which is set to 5000 initially. (5000 x 625µsec = 3125msec)

C.24. S49: Low Power Min Interval (default 4500)

This is the min interval value to use low power mode, which is set to 4500 initially. (4500 x 625µsec = 2812msec)

A small interval increases power consumption, a large interval increases latency.

C.25. S52: Low Power Timeout (default 5)

This is the low power timeout value, which is set to 5 initially. (5sec)

During no data transmission in the timeout, IW05 will be in low power mode to save the power. Therefore, it takes a few seconds to wake the IW05 out of low power mode.

C.26. S54: BD Address of Last Connected Device

This saves the Task2 BD address of the Bluetooth device connected most recently in a multiple connection mode.

C.27. TS55: BD Address of Last Connected Device

This saves the Task3 BD address of the Bluetooth device connected most recently in a multiple connection mode.

C.28. S56: BD Address of Last Connected Device

This saves the Task4 BD address of the Bluetooth device connected most recently in a multiple connection mode.

C.29. S57: Slave Disconnect Timeout (default 3)

This S57 register value defines the time period in seconds that a master unit waits in case a slave unit does not receive the data sent from the master. For this time period, the master unit will not send data to all slave units if any slave unit does not receive the data. If the slave unit does not receive the data after this time period elapses, the master unit will disconnect the connection with the problematic slave unit. The value should be greater than 0 and smaller than the Supervision Timeout(S37).

C.30. S58: MAX TX POWER (default 0)

This value describes the peak output power. Setting this causes rebooting and applying. (There is a little deviation according to the devices.)

BCD110

Parameter	dBm
0	Use chip setting.
1	-14
2	-10
3	-5
4	0
5	5
6	10

7	14
8	18

BCD210

Parameter	dBm
0	Use chip setting.
1	-12
2	-8
3	-4
4	0
5	4

C.31. S59: Current Slave in Communication (default 0)

This value shows the current slave number in communication. The value is automatically stored when the slave is selected for communication. This value can also be set by user so the master unit connects to a specific slave to connect first in case the master unit reboots. The value range is 0~4. 0 means the maser unit never connected to a slave. The master will connect to a slave whatever responses first.

C.32. S60: Reconnect Time Interval (default 5)

This value defines reconnect time interval in case a slave is disconnected in multiple connection mode. The actual reconnect time interval will be the value multiplied by two in seconds. For example, if the value is set to 5, the reconnect time interval will be 10 seconds. The value should be greater than or equal to 5. The master unit will only try to reconnect when its mode is set to Mode1.

Appendix D: Trouble Shooting

D.1. No Data Transmission

D.1.1. Device Settings

Check whether the Baud rate of IW05 matches that of its host equipment.
Check whether the host equipment of IW05 uses Hardware Flow Control. IW05 is initially set to Use of Hardware Flow Control. If your host equipment does not use Hardware Flow Control, please disable the Hardware flow control option by ParaniWIN or AT command.

D.2. Data Loss or Malfunctioning

D.2.1. Hardware Flow Control

When transmitting large amounts of data with No Hardware Flow Control, IW05 may clear the data buffer unexpectedly. The possibility becomes greater as the RF transmission environment becomes worse.

D.2.2. Response Message

The messages of IW05 response may affect the function of host system. Set `ATS10=0` not to send IW05 response to host system and try again. Refer Appendix B. for details.

D.3. Transmission Delay

D.3.1. RF Processing Delay

It takes 30msec approximately for a IW05 to complete a data transmission to the other Bluetooth device. This time delay cannot be reduced and may enlarge as the RF transmission environment becomes worse. Do not use IW05. If your applications cannot allow for this time delay.

D.3.2. RF Transmission Environment

If there are many Bluetooth devices working in a small area and/or the RF communication distance is too great and/or there are some obstacles affecting RF performance, the IW05 repeats the transmission packet by packet due to interferences and/or low RF performance. This may lead to increased data transmission time delays.

Appendix E: Warranty

E.1. GENERAL WARRANTY POLICY

Sena Technologies, Inc. (hereinafter referred to as SENA) warrants that the Product shall conform to and perform in accordance with published technical specifications and the accompanying written materials, and shall be free of defects in materials and workmanship, for the period of time herein indicated, such warranty period commencing upon receipt of the Product.

This warranty is limited to the repair and/or replacement, at SENA's discretion, of defective or non-conforming Product, and SENA shall not be responsible for the failure of the Product to perform specified functions, or any other non-conformance caused by or attributable to: (a) any misapplication or misuse of the Product; (b) failure of Customer to adhere to any of SENA's specifications or instructions; (c) neglect of, abuse of, or accident to, the Product; or (d) any associated or complementary equipment or software not furnished by SENA.

Limited warranty service may be obtained by delivering the Product to SENA or to the international distributor it was purchased through and providing proof of purchase or receipt date. Customer agrees to insure the Product or assume the risk of loss or damage in transit, to prepay shipping charges to SENA, and to use the original shipping container or equivalent.

E.2. LIMITATION OF LIABILITY

EXCEPT AS EXPRESSLY PROVIDED HEREIN, SENA MAKES NO WARRANTY OF ANY KIND, EXPRESSED OR IMPLIED, WITH RESPECT TO ANY EQUIPMENT, PARTS OR SERVICES PROVIDED PURSUANT TO THIS AGREEMENT, INCLUDING BUT NOT LIMITED TO THE IMPLIED WARRANTIES OF MERCHANTABILITY AND FITNESS FOR A PARTICULAR PURPOSE. NEITHER SENA NOR ITS DEALER SHALL BE LIABLE FOR ANY OTHER DAMAGES, INCLUDING BUT NOT LIMITED TO DIRECT, INDIRECT, INCIDENTAL, SPECIAL OR CONSEQUENTIAL DAMAGES, WHETHER IN AN ACTION IN CONTRACT OR TORT (INCLUDING NEGLIGENCE AND STRICT LIABILITY), SUCH AS, BUT NOT LIMITED TO, LOSS OF ANTICIPATED PROFITS OR BENEFITS RESULTING FROM, OR ARISING OUT OF, OR IN CONNECTION WITH THE USE OF FURNISHING OF EQUIPMENT, PARTS OR SERVICES HEREUNDER OR THE PERFORMANCE, USE OR INABILITY TO USE THE SAME, EVEN IF SENA OR ITS DEALER HAS BEEN ADVISED OF THE POSSIBILITY OF SUCH DAMAGES. IN NO EVENT WILL SENA OR ITS DEALERS TOTAL LIABILITY EXCEED THE PRICE PAID FOR THE PRODUCT.

E.3. HARDWARE PRODUCT WARRANTY DETAILS

WARRANTY PERIOD: SENA warranties embedded hardware Product for a period of one (1) year, and external hardware Product for a period of three (3) or five (5) years according to the Product type.

WARRANTY PROCEDURE: Upon return of the hardware Product SENA will, at its option, repair or replace Product at no additional charge, freight prepaid, except as set forth below. Repair parts and replacement Product will be furnished on an exchange basis and will be either reconditioned or new. All replaced Product and parts become the property of SENA. If SENA determines that the Product is not under warranty, it will, at the Customers option, repair the Product using current SENA standard rates for parts and labor, and return the Product at no charge in or out of warranty.

WARRANTY EXCLUSIONS: Damages caused by

- Accidents, falls, objects striking the SENA product,
- Operating the Product in environments that exceed SENA's temperature and humidity specifications,
- Power fluctuations, high voltage discharges,
- Improper grounding, incorrect cabling,
- Misuse, negligence by the customer or any other third party,
- Failure to install or operate the product (s) in accordance to their SENA User Manual,
- Failure caused by improper or inadequate maintenance by the customer or any other third party,

- Floods, lightning, earthquakes,
- Water spills,
- Replacement of parts due to normal wear and tear,
- Hardware has been altered in any way,
- Product that has been exposed to repair attempts by a third party without SENA's written consent,
- Hardware hosting modified SENA Software, or non-SENA Software, unless modifications have been approved by SENA.
- Battery component capacity degradation due to usage, aging, and with some chemistry, lack of maintenance.

E.4. SOFTWARE PRODUCT WARRANTY DETAILS

WARRANTY PERIOD: SENA warrants software Product for a period of one (1) year.

WARRANTY COVERAGE: SENA warranty will be limited to providing a software bug fix or a software patch, at a reasonable time after the user notifies SENA of software non-conformance.

E.5. THIRD-PARTY SOFTWARE PRODUCT WARRANTY DETAILS

The warranty policy of the third-party software is conformed to the policy of the corresponding vendor