

PANOVIEW 360° Panoramic Camera

——— User's Manual ———

PDV3635

Overview

Thank you for purchasing this product!

PANOVIEW 360°Camera is a digital panoramic camera with two lenses. Through the application of up-to-date technologies, it enables you to get panoramic videos and photos, creating an experience of brand new panoramic world.

Important

- Before using this product, please carefully read this Manual
- Prepare one 32G Micro SD card
- Check the camera power. A full charging is recommended before use (Until the charging indicator goes out)
- Scan the QR Code on next page, or search for “VRCAM720” on Apple Store and Google Play, and then download and install it

About Camera

1. OLED display
2. Power button/Mode button
3. WIFI indicator (red)
4. Power indicator (red) /Charging indicator (blue)
5. Wifi button/MENU button
6. Busy indicator (red)
7. Shutter button/OK button
8. Lensx2
9. Triangle nut
10. Interface cover (USB/TF)
11. Speaker
12. Microphone

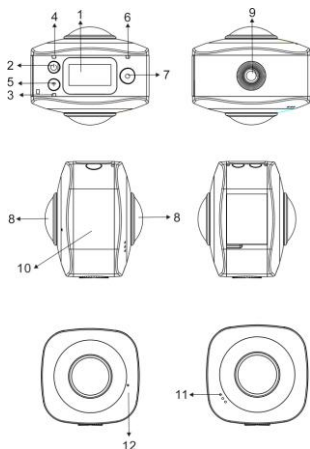

QR Code:

For IOS system, please scan this QR Code to get access to Apple Store to download and install “VRCAM720”.



or Android system, please scan this QR Code to get access to Google Play to download and install “VRCAM720”.



Quick start guide

1. Install SD card:

Insert the Micro SD card you prepare into the slot as indicated, as shown on the right.

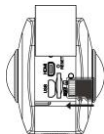

Important:

- A high-speed Micro SD card is Class10 above ; or else, this product may not work normally.
- 3.5K@28FPS use U3 high-speed Micro SD card.
- Always turn off the camera before inserting or pulling out of the card.

2. Power-on/off

Power-on: Press and hold Power button for about 2 seconds and release, until it beeps. The display screen will be lighted, as shown below, indicating the product is ready to work (the default work mode after power-on is Shooting mode).



Important:

- If power-on fails, charge the camera first, and see whether the blue indicator lights up during charging. If yes, it indicates the product is being charged.

Power-off: After shooting stops, press and hold Power button for about 3 seconds and release. The Display will display "GOODBYE" and turns off. No operation on mainframe for 3 minutes under Power-save mode (default), the camera will automatically power off.



3. Charging

Use data cable included in the product pack for camera charging. During charging, the indicator displays in blue and lights constantly; when charging completed, the blue indicator goes out.

Important:

- If other charger is used, check the output power before use to ensure it within 5V/1.5A above.

4. Recording or shooting

This camera has **Recording** mode and Shooting mode. After power-on, press MODE (Power button) to switch between different modes, and the corresponding mode icon will be displayed on the screen.

Video: In Recording mode, press Shutter button, and the camera get started to work. The display screen displays the video recording timing.

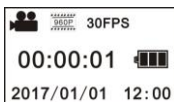

Stop recording: During recording, press Shutter button to stop it. The video will automatically be saved on your camera storage card. At that moment, the display screen will show remaining time available for recording as below:



Shooting: In Shooting mode, press Shooting button to take photos. After shooting, the display screen will display the number (estimated value) of pictures the available space on you camera storage card can save.

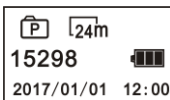

5. Menu setting

To operate Menu, press and hold WIFI button for about 2 seconds to enter menu setting (as shown below):



Menu operation:

In Menu mode, press WIFI button to move cursor. Press Shutter button to confirm. Press and hold WIFI button to back to previous menu or exit Menu mode.

Explanation of menu functions:

Movie Size: 3.5K (28FPS)、3.5K (15FPS)、2.7K (30FPS)、960P (30FPS)

Resolution: 24M(6912x3456) 、18M(6000x3000) 、16M(5760x2880) 、12M(4896x2448) 、8M(4000x2000) 、4M (2880x1440)

Power Save: Set Power-save mode. You may set the camera to enter Power-save mode after a certain period of time. The available options are 1min/3min/5min or Power-save mode off.

Date & Time: Set system time for the camera manually.

Language: Set system language for the camera, with English as its default language.

Factory Reset: Restore factory default settings.

System: Check system and storage card information.

Format: Format storage card.

Important:

After formatting, all existing data on the storage card will be lost due to such formatting. Please be cautious to this operation!

6. How to use accessories properly

It is strongly recommended to use the accessories originally provided by the manufacturer. It helps create a better product use experience and better shooting/recording effect.

Tripod: Screw the tripod nut attached into the screw hole on the bottom of the camera. It serves both as a hand-held or fixed device.

Fix to use tripod

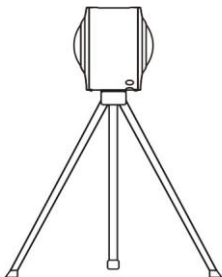

Hold to use tripod

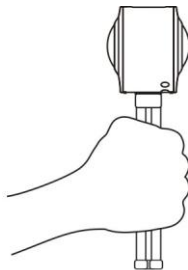

7. Use of watch remoter (optional)

1. Power button
2. Shooting button
3. Recording button

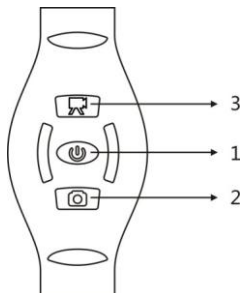

Play panoramic video or picture

Note: The videos or pictures may be played in right panoramic effect only on smart mobile phone, panel computer or PC procedures.

1. Use mobile phone or panel computer to play

Follow these steps to play panoramic videos or pictures on mobile phone or tablet.

Download APP:

Scan QR Code on Page 2 or search for "VRCAM720" on App Store to download and install the product APP.



Connect mobile phone and camera: Connect mobile phone and camera through WIFI connection

- i. Turn on camera WIFI: Press camera WIFI button, and the display screen will display "WI-FI ON", and then "P3635SA_XXXX", and initial password is "1234567890".



- ii. Turn on mobile phone WIFI, search for AP hot "P3635SA_XXXX" and select Connect.



- iii. If connected, the camera display screen will display as below picture.

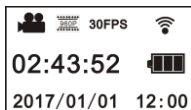

Activate APP: Activate “VRCAM720” APP on mobile phone or tablet, and click the upper right corner to “Search for Camera”.



Download: Enter camera folder, select the file to be downloaded and click to download.



Play: Select the file on mobile phone and click to play.



Important

It is recommended to follow the above steps in order to achieve the best HD video or picture playing effect.

Before connection, remember to make sure the SD card properly inserted into camera.

After connection, it will not affect 4G communication function of mobile phone or tablet .

Share:

Videos files can be shared via Youtube, Facebook, Wechat, QQ and etc. The sharing videos can be searched on its relevant websites or webpages.

The share files can be played with effects playing: Plane mode、Fisheye mode、Tiny planet mode、VR mode.

Notice: The merged video file is in .mov format.

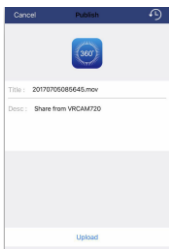
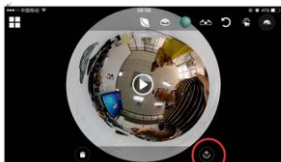

Effect of panoramic playing

The following effects are available if played on APP player

Tiny planet mode



Fisheye mode



Plane mode



VR mode



Run player: Open the video or picture downloaded and stored on PC in the player.



Playback video with player



Click the icon, choose the video which you want to play.

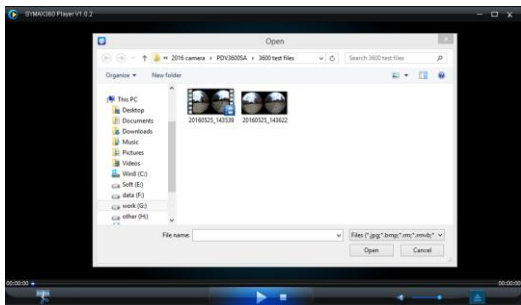

When playing the video, move the mouse to top right cone, it will show some different mode(Plane/Planet/Invert). Click it and will show different effects. Please click and move the mouse, you could enjoy the video with full angle 360 degree.

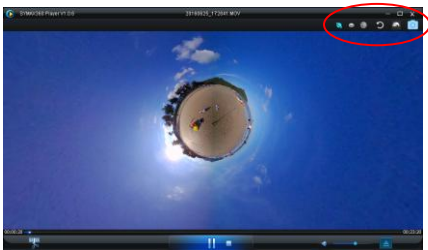

Edit and share video:

The video and photo which are recorded by this device could be edited and shared, as above picture, it could be shared to YouTube, Facebook, Youku and some other popular social website.

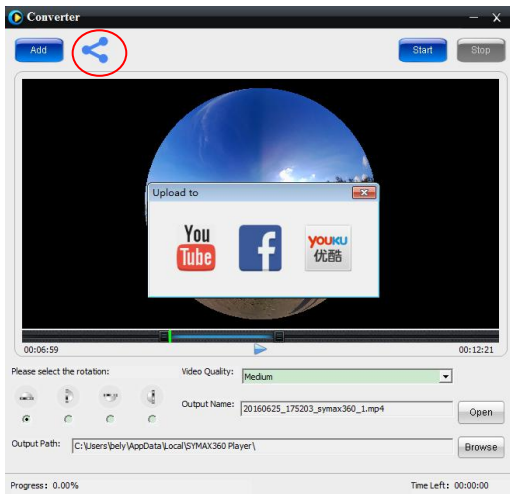

Important:

On current video websites, the videos uploaded by users have been compressed automatically. This may lead to different video play effects between website and local videos.

Technological parameters:

Image sensor	16.0M (CMOS)×2
Functional mode	Recording & shooting
Lens	F2.2 f=1.6mm
Video resolution	3.5K(28fps)、3.5K(15fps)、 2.7K(30fps)、960P(30fps)
Picture resolution	24M(6912*3456)、18M(6000*3000)、 16M(5760*2880)、12M(4896*2448)、 8M(4000*2000)、4M(2880*1440)
File format	Video H.264 (MOV) Image JPG
Storage medium	TF card (supportive 32GB at most)
USB interface	High-speed USB2.0 interface
Power supply	Built-in high voltage lithium battery 1200mAh
Size	61.0*60.0*50.5mm

Instructions for use

- The product is equipped with a built-in battery. Do not put it directly into fire, or it may cause explosion or other dangers.
- The product may radiate heat due to long-time use or exposure to direct sunlight. This is normal.
- If the camera stops working or fails to respond to any operation during use, use a needle to press and hold Reset button for about 3 seconds to restart the product.
- Do not use the camera under any environment with temperature lower than 0℃ or higher than 40℃; or else it may not turn on normally.
- Do not use the camera in humid place, for the humidity may damage important parts of the camera.
- Do not put the camera directly into water.
- Do not use the camera during charging, for it may cause system halt or other failure due to improper heat radiation.
- Do not contact the lens with hard articles to avoid any damage.

Thank you again for purchasing this product. Have fun with it!

Label Statement:

This device complies with part 15 of the FCC Rules. Operation is subject to the following two conditions: (1) This device may not cause harmful interference, and (2) this device must accept any interference received, including interference that may cause undesired operation.

FCC Statement This equipment has been tested and found to comply with the limits for a Class B digital device, pursuant to part 15 of the FCC rules. These limits are designed to provide reasonable protection against harmful interference in a residential installation. This equipment generates, uses, and can radiate radio frequency energy and, if not installed and used in accordance with the instructions, may cause harmful interference to radio communications. However, there is no guarantee that interference will not occur in a particular installation.

If this equipment does cause harmful interference to radio or television reception, which can be determined by turning the equipment off and on, the user is encouraged to try to correct the interference by one or more of the following measures:

- Reorient or relocate the receiving antenna.
- Increase the separation between the equipment and receiver.
- Connect the equipment into an outlet on a circuit different from that to which the receiver is connected.
- Consult the dealer or an experienced radio/TV technician for help.

WARNING: Changes or modifications not expressly approved by the party responsible for compliance could void the user's authority to operate the equipment.

This equipment complied with FCC radiation exposure limits set forth for an uncontrolled environment.

To assure continued compliance, any changes or modifications not expressly approved by the party responsible for compliance could void the user's authority to operate this equipment.

