

STARMATE

ST1 Satellite Radio Receiver User Guide



CONGRATULATIONS! Your new Sirius Starmate™ ST1 portable Plug-n-Play Receiver kit lets you enjoy SIRIUS® Satellite Radio's digital entertainment on the road or at home. (Home use requires the Home Docking Kit sold separately.) Use this manual to familiarize yourself with all of Sirius Starmate's features and capabilities. For the latest information about this and other SIRIUS products, visit www.sirius.com

Table of Contents

Box Contents	3		
Safety Precautions	4	Menu Display Options	22
Receiver Controls and Features	6	Sirius ID	22
Remote Control	8	FM Transmitter	22
Activating your SIRIUS Subscription	9	Display Settings	23
Vehicle Installation	10	Auto Select	24
Basic Operation	14	Signal Indicator	25
Changing Channels	14	Confirm Tone Options	25
Display Button	14	Channel Block	26
Search Modes (Category, Channel, Artist, Song) ..	15	Time-Based Features	27
Direct Tuning	16	Factory Default	29
Setting Channel Presets	16	Troubleshooting	30
Recalling Channel Presets	16	Specifications	31
Searching for a Channel Preset (P.TUNE Mode) ...	17	Optional Accessories	32
Preset Tune List Mode	17	Warranty	34
Memory (MEMO) and SongSeek (S-Seek) Functions	18		

STARMATE

Box Contents

Unpack your Sirius Starmate carefully and make sure that everything shown here is present:

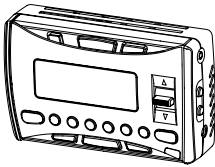

Sirius Starmate Receiver



Remote Control

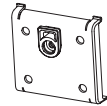

Clip Mount

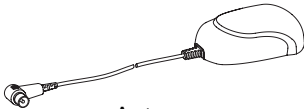

Antenna

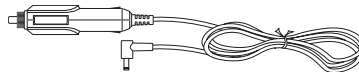

Vehicle Power Adapter

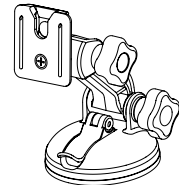

Suction Cup Mount

If anything is missing or damaged, or if your Sirius Starmate Receiver fails to operate, notify your dealer immediately. It is recommended that you retain the original carton and packing materials in case you need to ship your Receiver in the future.

Safety Precautions

Warning

Take the following precautions to prevent traffic accidents and avoid personal injury:

- Installation must be performed according to this user guide. Sirius Satellite Radio is not responsible for issues arising from installations not performed according to the procedures in this manual.
- Do not install the unit where it may obstruct your view through the windshield or your vehicle's indicator displays.
- Do not install the unit where it may hinder the function of safety devices such as an airbag. Doing so may prevent the airbag from functioning properly in the event of an accident.
- The installation and use suggestions contained in this user guide are subject to any restrictions or limitations that may be imposed by applicable law—the purchaser should check applicable law for any restrictions or limitations before installing and/or operating this unit.
- Failure to follow these safety instructions and warnings may result in a serious accident.

Warning

Take the following precautions to prevent fire and avoid personal injury:

- To avoid short circuits, never put or leave any metallic objects (coins, tools, etc.) inside the unit.
- If the unit emits smoke or unusual odors, turn the power off immediately and contact Technical Support at 800-869-5187.
- Do not drop the unit or subject it to strong shocks.
- If the LCD display becomes damaged or broken, do not touch the liquid crystal fluid. The fluid can be dangerous to your health. If the liquid crystal fluid contacts your body or clothing, immediately wash it off with soap and water.

Caution

Take the following precautions to keep the unit in proper working order:

- Be sure the unit is connected to a 12V DC power supply with a negative ground connection.
- Do not open the unit.
- Do not install the unit where it will be exposed to high levels of humidity, moisture, or dust.

- When replacing a fuse, use only a new one with the proper rating. Using a fuse with the wrong rating may cause the unit to malfunction.
- To prevent a short circuit when replacing a fuse, first disconnect the wiring harness.

Note

If the unit doesn't seem to be working properly:

- Turn the unit's power off, wait 5 – 10 seconds, then turn the power on again.
- If the unit still malfunctions, turn the unit's power off, remove it from the cradle, wait 5 – 10 seconds, replace it in the cradle and turn the power back on. If the problem persists, contact Technical Support at 800-869-5187.

FCC Warning

This equipment may generate or use radio frequency energy. Changes or modifications to this equipment may cause harmful interference unless the modifications are expressly approved in this user guide. The user could lose the authority to operate this equipment if an unauthorized change or modification is made.

Note

This equipment has been tested and found to comply with Part 15 of the FCC Rules. These rules are designed to provide reasonable protection against harmful interference. This equipment may cause harmful interference to radio communications if it is not installed and used in accordance with these instructions. However, there is no guarantee that interference will not occur in a particular installation. If this equipment does cause harmful interference to radio or television reception, which can be determined by turning the equipment off and on, the user is encouraged to try to correct the interference by one of more of the following measures:

- Reorient or relocate the receiving antenna.
- Increase the separation between the equipment and Sirius Starmate Receiver.
- Connect the equipment into an outlet on a circuit different from that to which the Sirius Starmate Receiver is connected
- Consult the dealer or an experienced radio/TV technician for help.

Cleaning the Unit

If the unit becomes dirty, turn its power off and wipe it clean with a soft dry cloth. Do not use hard cloths, paint thinner, alcohol, or other volatile solvents to clean the unit. These may cause damage or remove indicator characters.



Warning

Do not operate the unit in a way that might divert your attention from driving safely. As a driver, you alone are responsible for safely operating your vehicle in accordance with traffic safety laws at all times.

Receiver Controls and Features

1. **POWER Button** (⏻) : Turns Receiver On and Off.
2. **Channel Switch (CHAN) & Select Button:** Navigates through channels & display screens and makes selections of items highlighted on the display. Pressing up increases or moves up in the menus. Pressing down decreases or moves down in the menus. Pressing in duplicates the function of the Select button.
3. **CATEGORY Buttons:** Navigates through Category List Screen which displays SIRIUS Channel Categories.
4. **Display Button:** Toggles display between category and channel name.
5. **Menu Button:** Used to access menu options to make setup and feature changes.
6. **Select Button:** Selects an option on the screen.
7. **Preset Number Buttons (0-6):** Sets and selects preset channels.
8. **Memory (MEMO) Button (S-Seek Function):** Saves and recalls artist names and song titles. You can store up to 20 artist/song title combinations.

STARMATE

- 9. Band Button (P.Tune):** Pressing and releasing switches between the five preset banks (A... E), which hold six presets each. Pressing and holding enables “Preset Tune Mode”, which allows for viewing and listening of stored presets with the Channel Switch.
- 10.Remote Control Receiver:** Receives signals from the included wireless remote control.
- 11.DC 12V:** Input jack for cigarette lighter adapter or 12V DC power supply.
- 12.FM OUT:** FM Output for use with wired FM switch box accessory (sold separately).
- 13.ANTENNA:** Input jack for SIRIUS antenna.
- 14.VOL:** Volume control for audio out jack.
- 15.AUDIO OUT:** Audio line output or headphone jack.

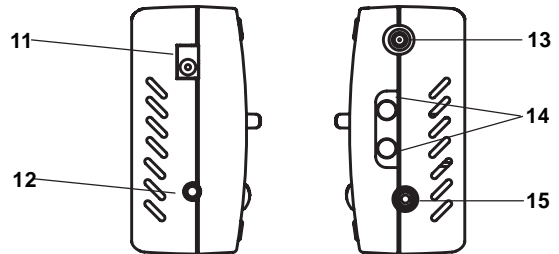
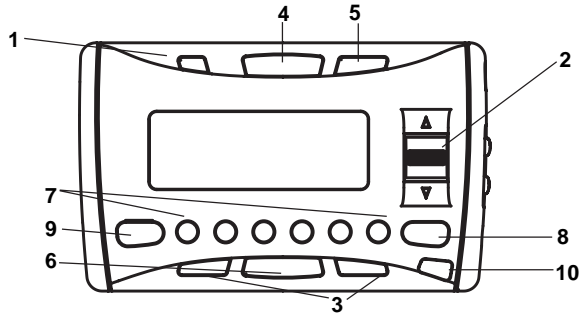

Remote Control

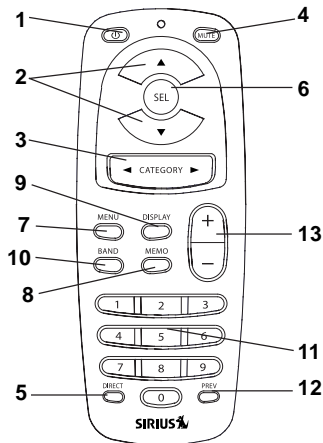

- 1. POWER Button** (⏻) : Turns Receiver ON and OFF.
- 2. Channel Buttons:** Navigate through channels and display screens.
- 3. Category Buttons:** Navigate through categories and display screens.
- 4. Mute Button:** Mutes audio.
- 5. DIRECT Button:** Accesses channels directly by number.
- 6. SELECT (SEL) Button:** Selects items highlighted on the display; hold-down to jump to the previously-received Channel.
- 7. MENU Button:** Enters and exits the Setup Mode.
- 8. MEMORY (MEMO) Button:** Saves & recalls song & artist information; sets Parental Lock code number.
- 9. DISPLAY Button:** Changes text size of artist names and song titles.
- 10. BAND Button:** Switches between preset bands A... E.
- 11. Number Buttons (0-9):** Select channels directly and by preset.
- 12. Previous Button:** Tunes to the last tuned channel.
- 13. VOL+ / VOL- Buttons:** Adjust the volume up & down.

Installing Batteries in the Remote

1. Remove the battery cover.
2. Install CR2025 battery. (+ side is up)
3. Replace the battery cover.

Activating your SIRIUS Subscription

Before you can listen to the Receiver, you must subscribe to SIRIUS Satellite Radio's service.

1. Make sure that the Sirius Starmate Receiver is properly connected and that its antenna is oriented to receive the SIRIUS satellite signal.
2. Press the power button to turn the Receiver ON. After displaying the SIRIUS logo, the Receiver will update all the SIRIUS channels. The display will read "UPDATING CHANNELS" on the top line and "X% Completed" (0%-20%-40%-60%-80%-100%) on the bottom line until the update completes.

NOTE: Don't push any buttons or perform any operations until updating has been completed. Once updated and the SIRIUS channels are received, the display will change to "Call 1-888-539-SIRIUS to Subscribe" and will place you in SIRIUS Satellite Radio's Preview Channel. Channel 184 is the SIRIUS preview channel. You will not be able to tune to any other channels until you activate your SIRIUS subscription.

4. Press the MENU button to enter the "Menu Options" mode. The "SIRIUS ID" menu option will now be highlighted.
5. Push the Select button to select "SIRIUS ID". This will display your unit's unique 12-digit SIRIUS ID Number (SID). This SID number should also be available on the Sirius Starmate Receiver packaging. Write the number down and have your credit card handy. A space has been provided at the end of this manual to write your SID.



6. Contact SIRIUS on the Internet: <https://activate.siriusradio.com/>
Follow the prompts to activate your subscription. You can also call SIRIUS toll-free at 1-888-539-SIRIUS (1-888-539-7474).

Vehicle Installation: Mounting the Receiver

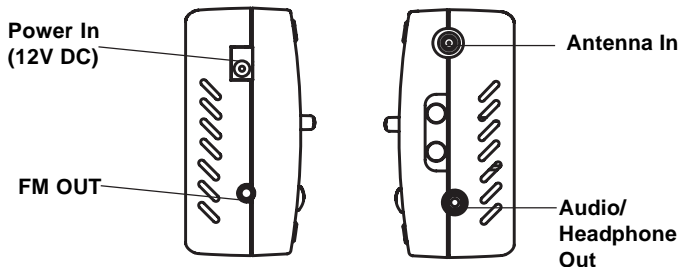
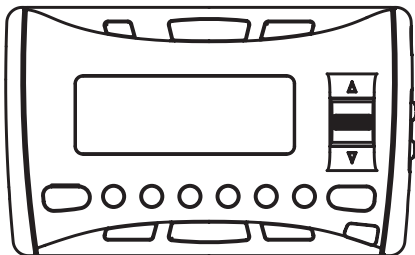

1. Determine where you want to mount the ST1 Receiver with the Mobile Docking Station:
 - Do not install the ST1 Receiver where it may obstruct your view through the windshield or your view of your vehicle's indicator displays.
 - Do not install the ST1 Receiver where it will hinder your access to the vehicle's controls.
 - Do not install the ST1 Receiver where it may hinder the function of safety devices such as an airbag. Doing so may prevent the airbag from functioning properly in the event of an accident.
 - Find a location that provides good visibility of and access to the ST1 Receiver's front panel.
 - It is strongly recommended that you mount the ST1 Receiver using the provided Suction Cup Mount, adhered to the windshield.

- Snap the Clip Mount on to the back of the ST1 Receiver.
 - Slide the ST1 Receiver with Clip Mount on to the Suction Cup Mount so that the Clip Mount is securely locked in place.
2. Plug the vehicle power adapter into the ST1 Receiver. Don't plug the adapter into the cigarette lighter until the installation is completed.

Connecting to your Car Stereo

1. If your vehicle stereo has an AUX input, plug a 3.5mm audio cable into the Audio Out connector on the ST1. Plug the audio cable's white (L ch) and red (R ch) connectors into your car stereo.
2. Alternatively, you can use the integrated FM transmitter to connect your Sirius Starmate Receiver. See the Menu Options section in this manual for more information on configuring the FM transmitter. Tune your vehicle's radio to the appropriate frequency to listen to the Receiver.

Vehicle Installation: Mounting the Antenna

1. Temporarily plug the antenna into the "ANTENNA" connector on Sirius Starmate until it is firmly seated.

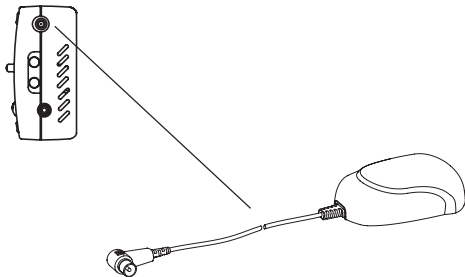

2. Find a location on a metal surface of your vehicle at least 12" x 12", and at least 6" from a window.
3. The antenna's powerful magnet will secure it to the metal surface. Before routing the antenna cable, confirm that the antenna is mounted in a good location.

4. Temporarily plug the Vehicle Power Adapter into the cigarette lighter.
5. Press and hold the POWER button to turn the ST1 Receiver on.
6. If your ST1 Receiver has been properly connected and the antenna is receiving the SIRIUS signal you will hear audio. If you do not hear audio and the display shows "Acquiring Signal", reposition the antenna until the message goes away and you hear audio. (See Antenna Signal, on page 21 of the ST1 Receiver manual to use the ANTENNA SIGNAL screen to aim the antenna.)
 - Make sure the vehicle is not in a garage or somewhere the satellite signal could be blocked.
 - Best reception is achieved with the antenna mounted on the roof or the trunk for convertibles.
 - If the vehicle has a roof rack or skid ribs, it may be necessary to mount the antenna off-center.

Vehicle Installation: Running the Antenna Cable

1. Turn the ST1 receiver power OFF and remove it from the mount; unplug the Car Power Adapter from the cigarette lighter; unplug the antenna from the Receiver.

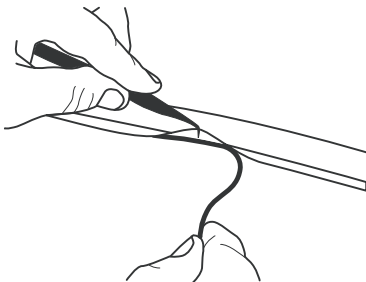

2. Route the cable from the antenna to the vehicle's interior by tucking it underneath the rubber molding around rear window, as shown.
3. Route the cable from the lowest point of the rear window into the trunk. Take advantage of any existing cable channels or wiring conduits.
 - For SUVs, minivans & 5-door vehicles, bring the cable into the vehicle under the rubber molding for the tailgate, and continue under the interior trim.
4. From the trunk, route the cable around the passenger compartment and to the back of the cradle.
 - Do not pull the wire across sharp edges that could damage it.
 - Keep the wire away from areas where it could become tangled in driver's and passenger's feet.
5. Plug the antenna back into the ST1 Receiver's ANTENNA jack.
6. Plug the car power adapter into the cigarette lighter. IT IS RECOMMENDED THAT YOU UNPLUG THE CAR POWER ADAPTER AFTER THE VEHICLE'S IGNITION IS TURNED OFF.

Basic Operation

After you have successfully activated your SIRIUS subscription, the Normal Operation (Default) screen will appear (*Below*): Use the Channel Switch (CHAN) to select channels.

- The selected channel will automatically start playing. The name and artist of the currently playing song will scroll across the display.

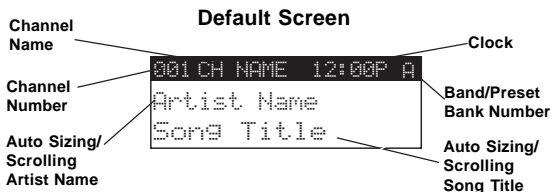

Display Button

Pressing the DISPLAY button from the Default display toggles channel name and category on the top line of the display.

Pressing and holding the DISPLAY button for 3 seconds will enter Channel List mode, described in the next section.

Changing Channels

Pressing the Channel Switch up will increase or move up to the next channel. Pressing the Channel Switch down will decrease or move to the previous channel.

Search Modes (Category, Channel, Artist, Song Title)

The Sirius Starmate Receiver has several ways to search for and select music: by channel, by category, by artist and by song title.

Searching Channels

If you want to find a different channel to listen to, press and hold the DISPLAY button to enter Channel List mode:

1. Use the CATEGORY buttons to scroll through music and entertainment categories.
 2. Use the Channel Switch to scroll through the available channels in each category.
 3. When the channel you want is highlighted, press SELECT to tune to it. The channel will change and the display will revert to the Default screen for the new channel.
- Pressing the DISPLAY button while in the Channel List Mode will change between Channel Name, Artist Name and Song Title to preview what is playing on other channels before selecting.

To exit this mode without changing to a new channel, press and hold the DISPLAY button for 1 second.



Press one of the CATEGORY buttons to activate the category list.



Press DISPLAY to show the Artist Name



Press DISPLAY again to show the Song Title

Note: If you are viewing a sports category channel list (NFL Zone, NHL Zone), pressing the DISPLAY button will toggle between the team names and the current score of any live play-by-play game.

Direct Tuning (Remote Control Only)

Channels can be directly accessed by pressing the DIRECT button on the remote control and then using the 0-9 keys to enter the desired channel number. Once the desired number has been entered, the channel will change and the display will revert to the Default screen for the new channel. The receiver will change immediately if three numbers are entered (ex. “0”, “0”, “7”), but if just one or two digits are entered, the unit will wait for 3 seconds before changing the channel.



Setting Channel Presets

You can store up to 30 of your favorite channels as presets, for quick access. Presets are stored in 5 banks, each containing 6 channel presets.

1. Press the BAND button to activate the preset bank you want. The selected bank is shown in the top right corner of the Default screen.
2. Select the channel you want to preset (see *the Basic Operation and Changing Channels* section).
3. Hold the numbered preset button you want to store the channel in for at least 2 seconds.
 - You will hear a beep and “Preset Stored” will flash to indicate that the channel has been memorized.
 - If the preset button already has a channel stored in it, it will be replaced by the new channel.

Recalling Channel Presets

The 6 presets in the active bank (A - E) can be selected by pressing the “0” – “6” buttons.

1. Press the BAND button to activate the preset bank you want. The selected bank is shown in the top right corner of the Default screen.
2. Press the desired preset button to recall the preset. The channel will change and the display will revert to the Default screen for the new channel.

Searching for a Channel Preset (P.TUNE Mode)

It is possible to quickly search through all of your presets using the Channel Switch.

1. Press and hold the BAND button to enter the Preset Tune Mode (P.TUNE).
2. "Preset Tuning Mode" will be displayed and the top corners of the display will invert to indicate Preset Tune Mode.
3. Use the Channel Switch to move up or down through your presets. Only channels stored in your presets will be displayed, regardless of which bank they are stored in.
- Presets will be grouped and displayed by preset bank and number (ex. A-1, A-2...B-1, B-2) and rotate back to the beginning.

```
001 CH NAME 12:00P A
Artist Name
Song Title
```

Default Display

```
001 CH NAME 12:00P A
Artist Name
Song Title
```

P.TUNE Display

To exit Preset Tune Mode and return to Channel Tuning Mode, press and hold the BAND button.

Preset Tune List Mode

In the Preset Tuning Mode you can view your list of presets showing Channel Name, Artist Name, or Song Title just like in the Channel List Mode:

1. Press and hold the BAND button to enter the Preset Tune Mode (P.TUNE).
2. Press the DISP button for 2-seconds which will bring up the Preset Tune List Mode displaying up to 3 preset channel names.
 - Pressing the DISP button while in this mode will change between Channel Name, Artist Name and Song Title list modes.
 - The name field will scroll only if the length of the artist or song title cannot be viewed in its entirety.
3. Use the Channel Switch to select the desired preset.
4. Push SELECT to select the channel. The channel will change and the display will revert to the P.TUNE Display.

```
001 CH NAME 12:00P A
Preset Tuning Mode
```

```
A-1 CH Name  
A-2 CH Name  
A-3 CH Name
```

P.TUNE
Channel Name
List Display

```
A-1 Artist Name  
A-2 Artist Name  
A-3 Artist Name
```

P.TUNE Artist
Name List
Display

```
A-1 Song Title  
A-2 Song Title  
A-3 Song Title
```

P.TUNE Song
Title List
Display

Memory (MEMO) and Song Seek (S-Seek) Functions:

This feature allows the user to capture and store information about the programming (Artist/Song, sports team or traffic city) on the currently tuned channel, up to a total of 10 listings. The receiver also has the capability to continuously search all incoming SIRIUS channels and alert the user when a saved program is being played.

Storing Song Titles

1. While the Receiver is in the Default display mode, momentarily pressing and releasing the MEMO button stores the current program data information within the Receiver's memory. A memory "**Stored**" pop-up screen, followed by "**X Used/Y Empty**" will each appear for 1 second (*below*).

```
001 CH NAME 12:00P A  
Stored
```

```
001 CH NAME 12:00P A  
X Used/Y Empty
```

If the current tuned channel is an NFL play-by-play sports broadcast, pressing the MEMO button will allow you to select one of the teams playing to be stored in memory. In the future, as long as your receiver is turned on, you will be alerted when your team is playing in a game being broadcast.

If the current tuned channel is a non-NFL sports play-by-play broadcast, pressing the MEMO button will store the name of both teams and you will only be alerted when these same teams are playing each other.

2. If the MEMO button is pressed and all of the memory spaces are full, **S-Seek Full** will flash on the display for 1 second, followed by a pop-up screen presenting the **Replace-Cancel** options.

This prompt allows you to make the following Replace/Cancel choices:

- By selecting **Replace**, the memory list will appear, and you can use the Channel Switch to select the data that you would like to overwrite with the new Artist/Song Title. After highlighting the selected title in the list, press SELECT to delete the stored Artist/Song Title and replace it with the updated information. The display will show the "Stored" screen.
- By selecting **Cancel**, the prompt screen will disappear and revert to the original screen. Nothing will be stored.

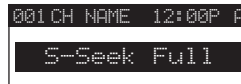

Viewing Program Information stored in Memory

1. Press and hold the MEMO button for 3 seconds to enter S-Seek Mode. The program information stored in memory will be displayed one-at-a-time in page format.
2. Use the Channel Switch to scroll through the listings. This function allows you to review previously stored program information.
2. Use the Channel Switch to highlight the "Delete" option.
3. Press SELECT and a Delete confirmation screen will appear.
4. To permanently delete the program from your list, select "Yes" using the Channel Switch and press SELECT to confirm.



Deleting a Song Title Stored into Memory

1. Press SELECT while in S-Seek Mode. A pop-up screen displaying two selectable options - "Delete" and "S-Seek" - is displayed.



Activating the Song (S-Seek) Alert

1. Press and hold the MEMO button for 3 seconds to enter the S-Seek Mode.
2. Press and release SELECT. A pop-up screen displaying two selectable options - “Delete” and “S-Seek” will appear (below left).
3. Use the Channel Switch to highlight the “S-Seek” option.
4. Press and release SELECT and an S-Seek confirmation screen will appear. Select the “Yes” option using the Channel Switch and press SELECT to confirm (below right).



With the S-Seek option enabled, whenever the Sirius Starmate Receiver is turned on, it automatically searches the incoming channels to determine if a match exists with the program information stored in receiver's memory. If one or more matches are found, a pop-up screen momentarily appears for 2-seconds and displays

“S-Seek Alert”. An audible beep tone will be heard indicating that a match has been found. The display then reverts to the S-Seek Alert screen which displays the current matches. You can now select the Artist/Song Title or game that you wish to listen to. No stored match alert is provided for the currently selected channel. To ensure that no duplicate entries are stored in memory, the Receiver will check the stored input data to ensure the information about to be stored is not already in memory.

- If one or more matches are found, a list appears. You can scroll through the list and select a program using the Channel Switch. Your selection will be tuned and the display will revert to the last active display mode.
- If a selection is not chosen within 10 seconds, the screen will revert to the last active display and tuning modes.

NOTE: Play of the current selection will continue until a new selection is made.

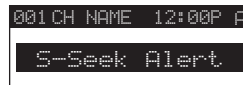

Menu Display Options

To enter the Menu Options page, press and release the MENU Button. The “**Menu Options**” list will appear on the display (*below*).

Using the Channel Switch, highlight the option you wish to adjust and press SELECT. The following options are available:

Sirius ID	Signal Indicator
FM Transmitter	Confirm Tone
Brightness Control	Channel Block
Contrast Control	Time Based Features
Auto Select	Factory Default



Note: If a button is not pressed within 10 seconds, the Receiver will exit the “**Menu Options**” function and revert back to the Default screen display.

Sirius ID

Displays your 12 digit Sirius ID (SID) number. The SID is unique to every Sirius Starmate Receiver and is required to activate your service. It is recommended that you write this number in the space provided on the last page of this user guide. No adjustments are allowed in this mode. To exit this option, press the SELECT or Menu Button.



FM Transmitter Options

If you would like to use the built-in FM Transmitter, you must turn ON the function and select an FM frequency:

1. Use the Channel Switch to highlight “**FM Transmitter**”. Press SELECT.
2. Use the Channel Switch to select “**FM On/Off**”. Press SELECT.
3. Use the Channel Switch to select “On”. Press SELECT.
4. Use the Channel Switch to highlight the “**Frequency**”. Press SELECT.
5. Use the Channel Switch and Category Buttons to adjust the FM frequency. The Channel Switch adjusts in 0.1 MHz increments and the Category Buttons adjust in 1 MHz increments.



Display Settings

It is possible to adjust the Brightness and Contrast of the Receiver's display. While in the “**Menu Options**” list, use the Channel Switch to highlight the display setting you wish to adjust. Press SELECT to select.

1. **Brightness Control:** Adjusts the overall intensity of the display to help with viewing in different lighting conditions. Use the Channel Switch to adjust brightness up or down. The bar graph at the bottom of the screen will move to indicate the change.



2. **Contrast Control:** Adjusts the relationship between the background and the text on the LCD display. Use the Channel Switch to adjust the contrast up or down. The bar graph at the bottom of the screen will move to indicate the change.

To exit the Display settings, push the MENU button.

Auto Select

With Auto Select turned OFF, you must press SELECT in order to tune to a highlighted channel in any of the list modes. Turn Auto Select ON if you would like to automatically tune to the highlighted channel without pressing SELECT. This will allow you to quickly listen to the available programming on a given list. The default is OFF. To change the Auto Select option, perform the following:

1. From the Menu, use the Channel Switch to highlight **“Auto Select”**. Press SELECT.
2. Use the Channel Switch to Select **“ON”** or **“OFF”**. Press SELECT to set the option.

To exit, push the MENU button.

Signal Indicator

When using the optional Sirius Starmate Receiver indoor, such as with the Home Docking Kit, it is important to locate the antenna in an acceptable location (See the individual installation guides for more information).

1. Use the Channel Switch to highlight “**Signal Indicator**”. Press SELECT.
2. Two 10 segment horizontal bar graphs will be displayed (SAT and TER) with a “-” sign to the left and a “+” sign to the right. SAT indicates satellite signal and TER indicates terrestrial signal – if available.
3. Adjust the antenna for greatest signal reception, per the Home Docking Kit manual.

To exit this function, press SELECT or MENU.



Confirm Tone Options

The Sirius Starmate Receiver will sound an Audio “Tone” alert when the unit powers ON and OFF as well as when the S-Seek Alert is activated. The default is ON. To change the tone options, perform the following:

1. From the Menu, use the Channel Switch to highlight the “**Confirm Tone**”. Press SELECT.
2. Use the Channel Switch to Select “**ON**” or “**OFF**”. Press SELECT to set the Tone Option.

To exit, push the MENU button.

Channel Block

The Sirius Starmate Receiver has the ability to lockout the use of any channels you do not want others to access without your permission. The locked channel will not appear when the user changes channels with the Channel Switch. When the user tries to access a locked channel using the Direct Tuning function, the “Enter Code” screen will be displayed and the channel will not be accessed until the proper code is entered.

While in the “**Menu Options**” List mode, follow the steps below to Lock a channel:

1. Use the Channel Switch to highlight the “**Channel Block**”. Press SELECT.
2. Select “**Lock/Unlock**” from the Lock Options Menu (*below left*) and press SELECT.
3. Use the Channel Switch to select the channel you want to lock. Press SELECT (*below right*).

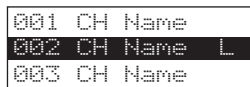

Changing the Lock/Unlock Code

The first time the Lock/Unlock function is accessed, the user must enter the default lock code. The default lock code is “1111”. This code can be maintained or changed. To change the lock code, perform the following procedure while in the “**Menu Options**” List mode:

1. Use the Channel Switch to highlight “**Lock Options**”. Press SELECT.
2. Select “**Edit Code**” from the Lock Options Menu and press SELECT.
3. Enter your current code or the default code “**1111**”.
4. The “**New Code**” prompt will appear. Enter your new four digit code using the 1-6 number buttons. You will then be prompted to confirm the new code by entering it again.
5. The lock code is now changed.

Note: You can use this same method to edit the code after it has changed from the default.



Time Based Features

This Menu Option allows for adjustment of the following items:

- Clock
- Auto Shutdown
- Sleep Mode

To change the Time-Based Features, use the following procedure while in the “**Menu Options**” List mode:

1. Use the Channel Switch to highlight the “**Time Based Features**”. Press SELECT.
2. Use the Channel Switch to select one of the following Time-Based Features to adjust:
 - a. **Clock:** The clock data is provided via the SIRIUS Satellite data stream, and will update based on the received signal.

- **Time Zone:** Since the clock adjusts automatically, it is important to specify your proper time zone. Use the Channel Switch to select the proper time zone. The following is a list of time zones available:
 - (GMT-9:00) Alaska
 - (GMT-8:00) Pacific
 - (GMT-7:00) Mountain
 - (GMT-6:00) Central
 - (GMT-5:00) Eastern
 - (GMT-4:00) Atlantic
 - (GMT-3:30) Newfoundland (Abbreviated as NewfndlnD)
- **Daylight Savings Time:** Activate this function if your area is subject to DST; use the Channel Switch to toggle between **DST Observed** (default) or **DST Not Observed**.

- b. **Auto Shutdown:** You can program the unit to automatically shut off after a 1-hour period without any user intervention. After 59 minutes of inactivity, a beep tone sounds and a display prompt appears on the screen, “**Cancel Auto Shutdown**”. To activate the Auto Shutdown feature, use the Channel Switch to select it from the Time Based Features Menu and press SELECT to enter the menu. Once in the Auto Shutdown Menu, use the Channel Switch to either “Enable” or “Disable” the feature.
 - **Cancel Auto Shutdown:** If you want to temporarily deactivate the Auto Shutdown feature once the beep tone sounds, press SELECT. The Auto Shutdown sequence will reset to 1 hour.
 - c. **Sleep Mode:** You can program the unit to turn off automatically after a selected period of time. The screen displays Sleep Mode on the top line, with optional time settings as follows:
 - Sleep Off
 - 15 Minutes
 - 30 Minutes
 - 45 Minutes
 - 60 Minutes
- Use the Channel Switch to select the desired Sleep Time. When the desired time is highlighted, press SELECT. The Receiver will now turn off after the selected time has elapsed.

Factory Default

This Menu option will restore all original factory settings. To activate this feature, perform the following procedure while in the “**Menu Options**”

List Mode:

1. Use the Channel Switch to highlight the “**Factory Default**” option. Press SELECT. “**Restore Settings**” will pop up on the Receiver’s display.
2. Use the Channel Switch to select “Yes” to restore all settings to the settings from the factory or select “No” to leave them as-is and return to the **Menu Options** List Mode.



If “Yes” is chosen, the unit reverts to the original factory settings for the following parameters:

- All Presets revert to empty
- Auto Dimming On
- Display Contrast to 50%
- Display Mode to Auto
- FM Modulator to On
- FM Frequency to 88.1 MHz
- Audio Output Level to 70%
- Access to all skipped Channels (Locked channels remain locked)
- Memory Search On
- Memory Locations are erased
- Eastern Time Zone
- Daylight Savings Time Observed
- Auto Shutdown Off
- Sleep Mode Off

Troubleshooting

FAULT	PROBABLE CAUSE	REMEDY
Receiver does not turn on	Blown Fuse, power cable not properly connected	Check fuse, check power cable
“ANTENNA NOT DETECTED” message	Satellite antenna not connected	Check satellite connection to receiver
	Antenna or cable is faulty	Contact system installer or vendor
Audio static or loss of clarity	FM modulator frequency contains static	Switch to another FM frequency
	Vehicle antenna not connected to radio	Check vehicle antenna cable
No signal on receiver display	Check for obstacles over or around antenna	Change location to eliminate nearby obstacles (bridge, etc.)
No Sound	<ol style="list-style-type: none"> 1. Audio Cables not connected 2. Incorrect FM modulator frequency 	<ol style="list-style-type: none"> 1. Check cables at Receiver and radio 2. Select another FM modulator frequency.

Specifications

Audio Output	2.2V (Peak-to-Peak)
Total Harmonic Distortion (THD)	<0.3%
Signal-to-noise (S/N)	Greater than 75dB
Fuse Requirement	3A Slow Blow
Power Supply	10-16V, Negative Ground, DC
Receiver Dimensions	100mm(W) x 60mm(H) x 27mm(D) (4" W x 2-3/8" H x 1-1/8" D)
Receiver Weight	5oz.
Remote Control Dimensions	49mm(W) x 104mm(H) x 23mm(D) (1-7/8"W x 4-1/8"H x 7/8"D)
Remote Control Battery Requirements	CR2025

Note: Features and Specifications subject to change without notice.

Optional Accessories for your Sirius Starmate Receiver

Add these accessories to maximize your SIRIUS experience.

STH1 Home Docking Kit

The STH1 is a compact docking kit that positions the receiver for easy viewing and operation. Designed for quick and easy self-installation, it includes all necessary cabling to connect to your home audio system.

Includes the Following:

- Compact tabletop/desktop docking cradle
- Audio cable for connection to any stereo bookshelf system
- Adjustable indoor/outdoor antenna with 20' of cable
- AC Adapter

12 MONTH LIMITED WARRANTY

Sirius Satellite Radio Inc. (the "Company") warrants to the original retail purchaser of this product that should this product or any part thereof, under normal use and conditions, be proven defective in material or workmanship within 12 months from the date of original purchase, such defect(s) will be repaired or replaced with new or reconditioned product (at the Company's option) without charge for parts and repair labor. To obtain repair or replacement within the terms of this Warranty, the product is to be delivered with proof of warranty coverage (e.g. dated bill of sale), specification of defect(s), transportation prepaid, to the location shown below under **WARRANTY RETURN**.

This Warranty does not extend to the elimination of externally generated static or noise, to correction of antenna problems, to costs incurred for installation, removal or reinstallation of the product, or to damage to tapes, compact discs, speakers, accessories, or vehicle electrical systems.

This Warranty does not apply to any product or part thereof which, in the opinion of the Company, has suffered or been damaged through alteration, improper installation, mishandling, misuse, neglect, accident, or by removal or defacement of the factory serial number/bar code label(s). THE EXTENT OF THE COMPANY'S LIABILITY UNDER THIS WARRANTY IS LIMITED TO THE REPAIR OR REPLACEMENT PROVIDED ABOVE AND, IN NO EVENT, SHALL THE COMPANY'S LIABILITY EXCEED THE PURCHASE PRICE PAID BY PURCHASER FOR THE PRODUCT.

This Warranty is in lieu of all other express warranties or liabilities. ANY IMPLIED WARRANTIES, INCLUDING ANY IMPLIED WARRANTY OF MERCHANTABILITY, SHALL BE LIMITED TO THE DURATION OF THIS WRITTEN WARRANTY. ANY ACTION FOR BREACH OF ANY WARRANTY HEREUNDER INCLUDING ANY IMPLIED WARRANTY OF MERCHANTABILITY MUST BE BROUGHT WITHIN A PERIOD OF 48 MONTHS FROM DATE OF ORIGINAL PURCHASE. IN NO CASE SHALL THE COMPANY BE LIABLE FOR ANY CONSEQUENTIAL OR INCIDENTAL DAMAGES FOR BREACH OF THIS OR ANY OTHER WARRANTY, EXPRESS OR IMPLIED, WHATSOEVER. No person or representative is authorized to assume for the Company any liability other than expressed herein in connection with the sale of this product. Some states do not allow limitations on how long an implied warranty lasts or the exclusion or limitation of incidental or consequential damage so the above limitations or exclusions may not apply to you. This Warranty gives you specific legal rights and you may also have other rights which vary from state to state.

WARRANTY RETURN: To obtain repair or replacement within the terms of this Warranty, please return product to an authorized Sirius Starmate retailer or call Customer Service at (800) 869-5187; proof of purchase and description of defect are required. Products to be returned to an approved warranty station must be shipped freight prepaid.

IMPORTANT INFORMATION

SIRIUS ID (SID): _ _ _ _ _

PSN: _ _ _ _ _

Customer Service: 1-800-869-5187

STARMATE

**Sirius Satellite Radio Inc.
1221 Avenue of the Americas
New York, NY 10020
(800) 869-5590
sirius.com**