

# SOKAR FPV DRONE

SKYRC

SKYRC



## Quick Start Manual

Manufactured by  
SKYRC TECHNOLOGY CO., LTD.  
[www.skyrc.com](http://www.skyrc.com)



© 2015 SkyRC Technology Co., Ltd. All Rights Reserved.

Version 1.0

7504-0694-01

INTRODUCTION.....	01
FPV QUADCOPTER.....	01
REMOTE CONTROLLER & FPV MONITOR.....	02
CHARGER.....	03
PACKAGE CONTENTS.....	03
CHARGING BATTERY.....	04
ATTACHING PROPELLERS.....	05
ATTACHING CLOVERLEAF ANTENNA.....	06
INSTALLING BATTERY.....	06
ATTACHING MONITOR TO REMOTE CONTROLLER.....	07
CHARGING FPV MONITOR.....	08
SWITCH ON/OFF REMOTE CONTROLLER AND MONITOR.....	08
SETTING CHANNEL FREQUENCIES.....	09
SWITCH ON/OFF THE SOKAR DRONE.....	09
ALL DONE READY TO FLY.....	10
STARTING THE MOTORS.....	10
STOPPING THE MOTORS.....	10
CONTROLLING DRONE MOVEMENT.....	11
SPECIFICATIONS.....	12
SAFETY PRECAUTIONS AND LIABILITY EXCLUSION.....	13
WARRANTY AND SERVICE.....	13

Congratulations on your choice of the SkyRC Sokar FPV Drone. This is a high performance quadcopter with FPV camera, video transmitter, video monitor and remote controller. LiPo battery and charger are included also. You just need to recharge your battery and FLY.

Let's meet your Sokar FPV Drone now.

Please review the illustrations below for a full list of your Sokar FPV Drone parts.



## Remote Controller & FPV Monitor



## LiPo Battery Charger



## Package Contents

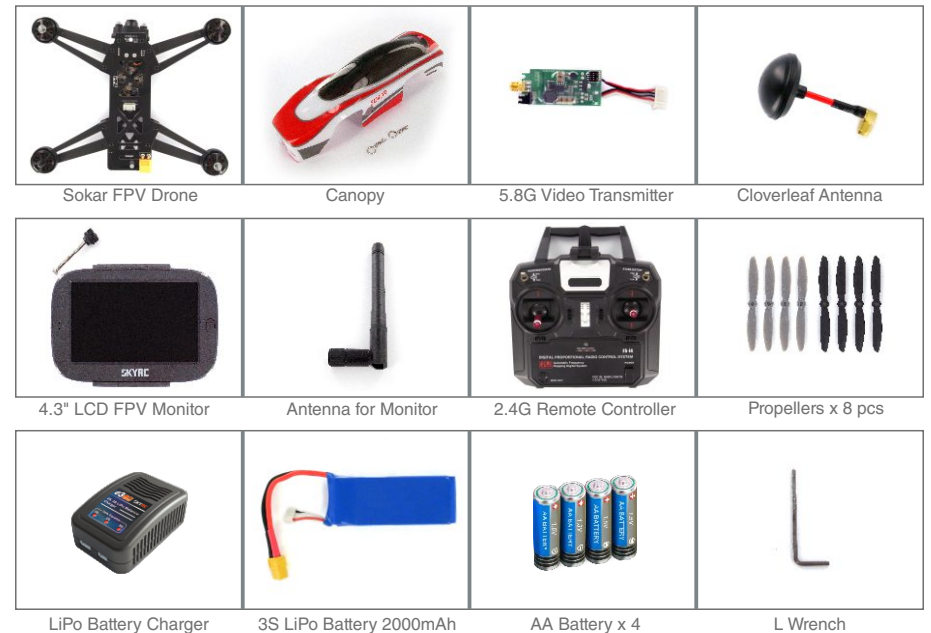

## Charging Battery

SKYRC e3 charger comes with the built in power supply. You can connect the AC power cord to the AC socket (100-240V AC) directly.

Please refer to following steps to charge the battery,

- 1) Insert the AC power cord into the charger.
- 2) Insert the AC plug into a wall socket (100-240V). All LEDs will light green and flash red to indicate the charger is ready to charge.
- 3) Connect battery balance wire to balance port which is in front side of the charger, after 2 seconds, the charger detects the voltage of the battery and starts to charge.
- 4) The charger starts charging. The LEDs will glow constant red. If the battery pack is 2-cell, Cell 1 and Cell 2 LEDs will glow constant red; if the battery pack is 3-cell, Cell 1, Cell 2 and Cell 3 LEDs will glow constant red.
- 5) When a cell is completely charged, its corresponding LED will glow constant green. A 2-cell pack is fully charged when LEDs 1 and 2 are constant green. For 3-cell pack, all LEDs will glow constant green to indicate the pack is fully charged.
- 6) Unplug the battery from the charger and the charge status LED will stay green and flash red which indicates the charger is ready to charge another battery.

### Remark:

- 1 If you unplug the battery while charging, the charger will stop charging automatically and enter into standby status.
- 2 If the charger encounters overload or short circuit while charging, the charger will stop charging and three LEDs will flash red.

LED Indicator	Charger Status
LED stays green and flashes red.	The charger is ready to charge.
LED glows constant red.	The charger is charging.
LED glows constant green.	The charging process finishes.



### CAUTION:

### CONNECTION DIAGRAM

This diagram shows the correct way to connect your battery to the e3 charger while charging. Failure to connect as shown in this diagram will damage this charger.

### \* Error Message for Charger

If the charger encounters a problem, all LEDs will flash red to alert you the errors. In this case, please disconnect the power cord from the wall socket and unplug the battery from the charger.

LED Indicator	Cause of Error
All LEDs flashes red once and stop 1 second in cycle.	The battery connects incorrectly.
All LEDs flashes red twice and stop 1 second in cycle.	The charger encounters overload or short circuit.
All LEDs flashes red four times and stop 1 second in cycle.	The voltage of single cell is too high or too low.
All LEDs flashes red six times and stop 1 second in cycle.	There is a 300mv difference of voltage between battery pack.

## Attaching Propellers

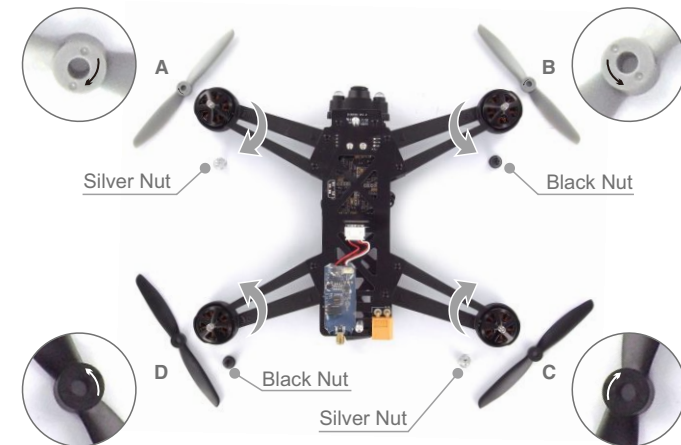

To attach the propellers correctly, you need match the spin direction on the propellers with the marking on each arms.

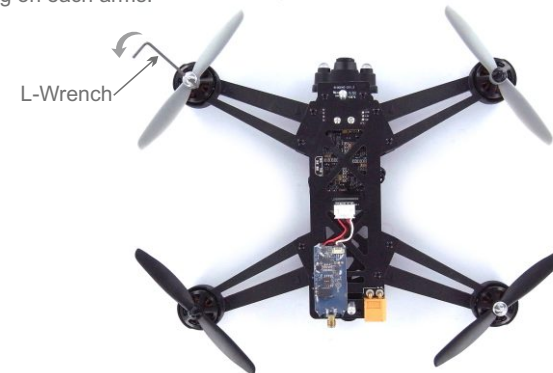

Hold the motor in place with one hand, then using L-Wrench and turn in opposite direction to secure the propeller.

## ATTACHING ANTENNA AND BATTERY

### Attaching Cloverleaf Antenna

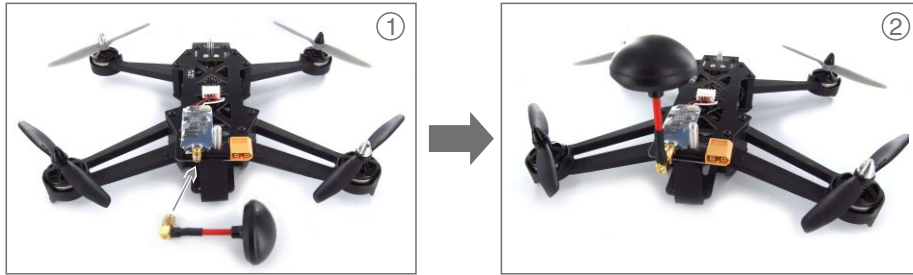

### Installing Battery



## ATTACHING MONITOR TO REMOTE CONTROLLER

### Attaching Monitor to Remote Controller



Install 4 x AA Battery

## Charging FPV Monitor

Using micro USB charging cable(not included) to charge the FPV monitor. During the charging process, the charging status LED indicator will turn red. When battery is fully charged, the LED indicator will turn green.



## Switch ON/OFF Remote Controller and Monitor



Slide power switch up to turn remote controller power ON, the LED on the remote controller will turn green.



Push the ON/OFF button to turn the monitor ON. Push and hold ON/OFF button for more than 5 seconds to turn it OFF.



For the advance user, you can turn responsiveness switch to fast and turn stabilization switch to low. The drone will be more agile and responsive.

## Setting Channel Frequencies

**The channel frequencies on the transmitter must be equal to the monitor.** The frequency of the channel in the 5.8GHz video transmitter and FPV monitor are set by a total of three (3) dipswitches. The 4th dipswitch is not used for channel selection. Please refer to the below pictures for the channel frequencies and corresponding dipswitch settings:

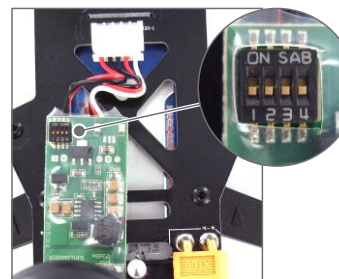

Dipswitch on the transmitter



Dipswitch on the back of monitor

	1	2	3	4	Frequency
CH1	ON	OFF	OFF	x	5745MHz
CH2	OFF	ON	OFF	x	5765MHz
CH3	ON	ON	OFF	x	5785MHz
CH4	OFF	OFF	ON	x	5805MHz
CH5	ON	OFF	ON	x	5825MHz
CH6	OFF	ON	ON	x	5845MHz

It is highly recommended to understand the rules and regulations in your country before using Sokar FPV Drone. Transmitting outside a legal band is something prohibited by authorities and may result in a fine or confiscation of equipment.

## Switch ON/OFF the SOKAR DRONE



Push the ON/OFF button located on the left side to turn ON the Sokar FPV Drone.

Push and hold ON/OFF button for more than 5 seconds to turn it OFF.

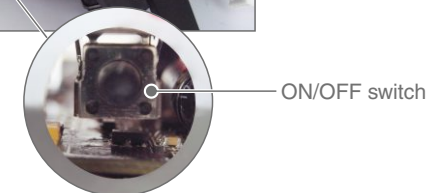

ON/OFF switch

## ALL DONE READY TO FLY

### Safety Precautions

The Sokar FVP Drone is not a toy. It is not suitable for using by any children under 14 years of age. During the flying, the propellers of Sokar FPV Drone could cause injury to people, animals and property. Do not touch Sokar FPV Drone when propellers are spinning and wait until the propellers have completely stopped before handling it.

Do not fly your FPV Drone over any public area, such as beaches, stadiums, populated parks, or other people's backyards and private areas. Do not fly near airport. In some country, you need get appropriate authorisation from local government before your flying.

### Starting the Motors

A combination stick control is used to start the motors. Push both sticks to the bottom inner corners to start the motors.



### Stopping the Motors

When the drone has landed, hold the throttle down. The motors will stop after ten seconds.



## Controlling Drone Movement

This section explains how to control the orientation of the Drone through the remote controller. The remote control is Mode 2.

<p>Flying upwards or downwards</p>	<p>up</p> <p>down</p>
<p>Yawing (rotating towards left or right)</p>	
<p>Pitching (moving onwards or backwards)</p>	
<p>Rolling (turning towards left or right)</p>	

## SPECIFICATIONS

<b>Flight Controller</b>	
IMU	Invensense 6050, 3 Axis Gyro, 3 Axis Accelerometer
CPU	STM32F031K4 32-bit ARM Processor
<b>Video Tx</b>	
Transmitter Module	5.8GHz Module
Channels	6 Programmed via Dipswitch
Frequency	5845, 5825, 5805, 5785, 5765, 5745 Mhz
Power Output	25mW
Antenna	Cloverleaf Antenna
<b>Power System</b>	
Propellers Size	5"
Brushless Motors	2204-2300KV
Battery	LiPo 2000mAh 3S 30C
ESC Rating	12A continuous, 17A peak
<b>Flight Characteristics</b>	
Flight Time	12 Minutes, Also Depends Upon Flight Style
Maximum Range	Highly dependent on battery, and flying style
<b>Video Camera</b>	
Sensor	300,000 Pixel
Lens	FOV (Field Of View) 135°
<b>FPV Monitor</b>	
Size	4.3" TFT LCD
Resolution	480x272
Channel	6 Channels
Frequency	5845, 5825, 5805, 5785, 5765, 5745 MHz
<b>Weight and Size</b>	
Weight(FPV Drone)	405g(without battery)
Weight(Remote Controller)	614g

## SAFETY PRECAUTIONS & WARRANTY AND SERVICE

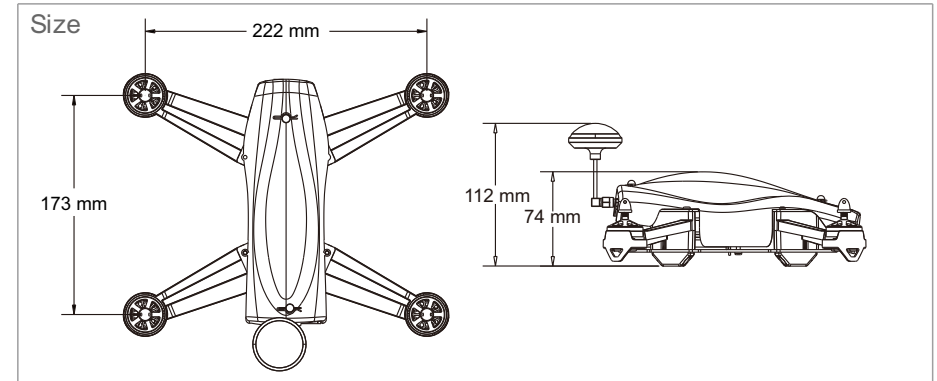

### Safety Precautions and Liability Exclusion

Sokar FPV Drone is NOT a toy. It is not suitable for using by any children under 14 years of age. It is a race quad and not come with GPS hold, and it does require a fair amount of skill to pilot it.

A warning that batteries (battery pack or batteries installed) shall not be exposed to excessive heat such as sunshine, fire or the like.

The propeller can do some serious injury to human body. So when you setting up the drone, it is highly recommended to REMOVE ALL PROPELLERS.

Keep in mind that there is always a chance that propellers spin up unexpectedly.

SkyRC accepts no responsibility or liability for any injury or damage to a person or property caused by the use of Sokar FPV drone.

### Warranty and Service

We guarantee this product to be free of manufacturing and assembly defects for a period of one year from the time of purchase. The warranty only applies to material or operational defects, which are present at the time of purchase. During that period, we will repair or replace free of service charge for products deemed defective due to those causes.

This warranty is not valid for any damage or subsequent damage arising as a result of misuse, modification or as a result of failure to observe the procedures outlined in this manual.

The warranty service is valid in China only.

If you need warranty service overseas, please contact your dealer in the first instance, who is responsible for processing guarantee claims overseas. Due to high shipping cost, complicated custom clearance procedures to send back to China. Please understand SKYRC can't provide warranty service to overseas end user directly.

If you have any questions which are not mentioned in the manual, please feel free to send email to [info@skyrc.cn](mailto:info@skyrc.cn)



### FCC NOTE

This device complies with Part 15 of the FCC Rules.

Operation is subject to the following two conditions: (1) this device may not cause harmful interference, and (2) this device must accept any interference received, including interference that may cause undesired operation.

THE MANUFACTURER IS NOT RESPONSIBLE FOR ANY RADIO OR TV INTERFERENCE CAUSED BY UNAUTHORIZED MODIFICATIONS OR CHANGE TO THIS EQUIPMENT. SUCH MODIFICATIONS OR CHANGE COULD VOID THE USER'S AUTHORITY TO OPERATE THE EQUIPMENT.

This equipment has been tested and found to comply with the limits for a Class B digital device, pursuant to part 15 of the FCC Rules. These limits are designed to provide reasonable protection against harmful interference in a residential installation. This equipment generates, uses and can radiate radio frequency energy and, if not installed and used in accordance with the instructions, may cause harmful interference to radio communications. However, there is no guarantee that interference will not occur in a particular installation. If this equipment does cause harmful interference to radio or television reception, which can be determined by turning the equipment off and on, the user is encouraged to try to correct the interference by one or more of the following measures:

- Reorient or relocate the receiving antenna.
- Increase the separation between the equipment and receiver.
- Connect the equipment into an outlet on a circuit different from that to which the receiver is connected.
- Consult the dealer or an experienced radio/TV technician for help.

To maintain compliance with FCC's RF exposure guidelines, this equipment should be installed and operated with a minimum distance of 20cm between the radiator and your body.