

BLUETOOTH TOUCH OPERATION (PIC 9)

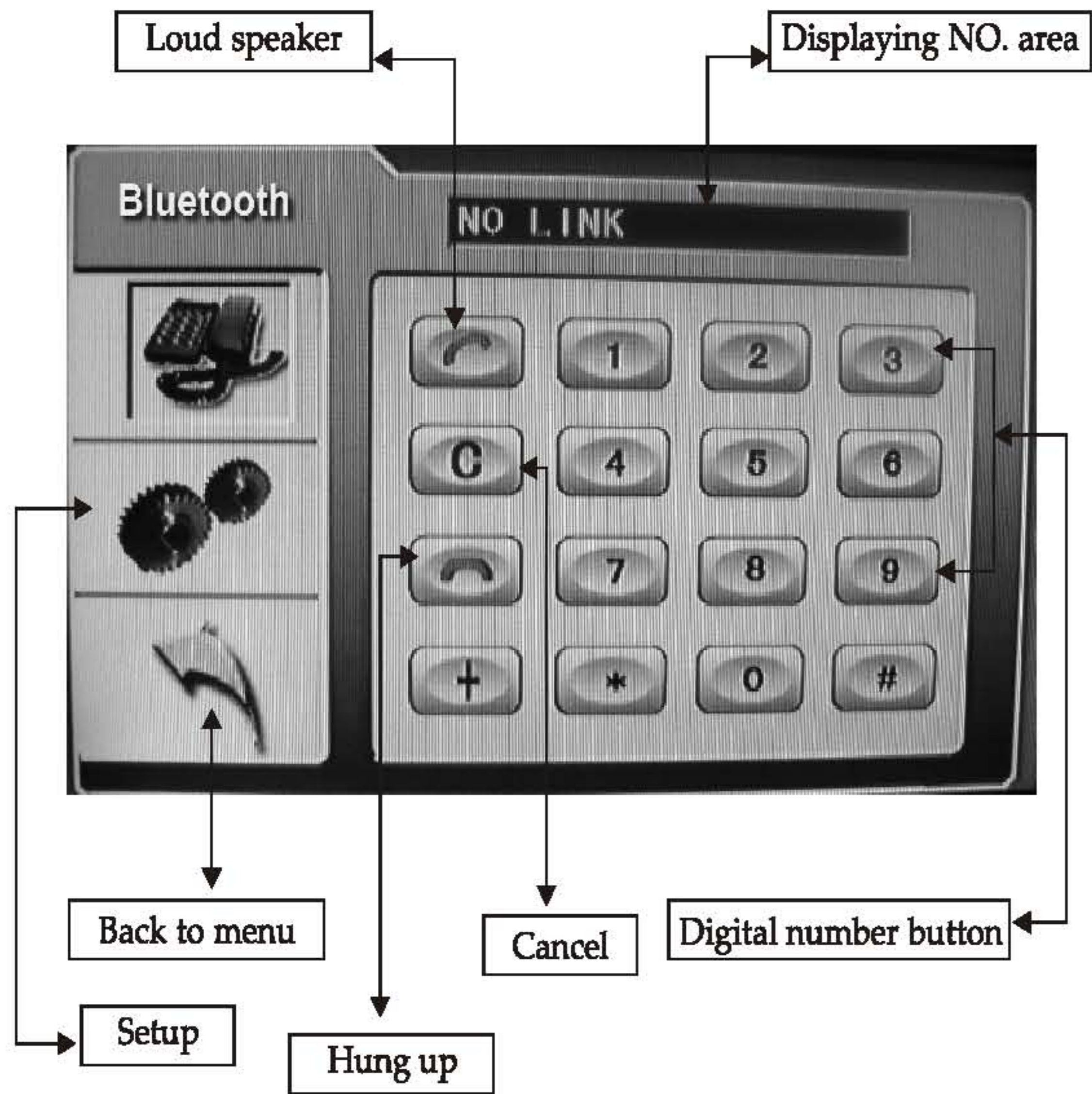

Note: All the operation and sets are introduced detailly on the next page.

MAIN MENU TOUCH OPERATION (PIC 1)

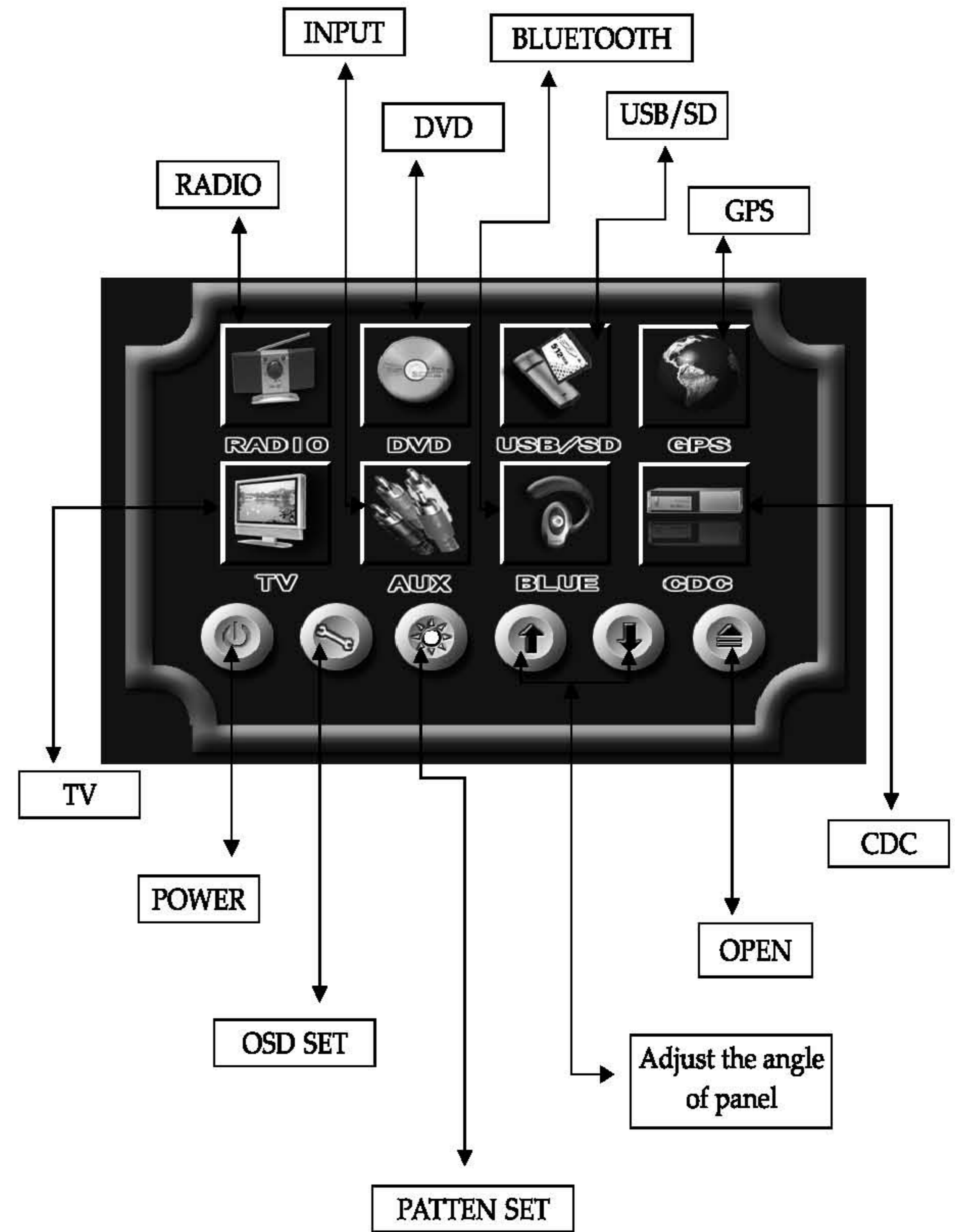

OSD SETUP (PIC 2)

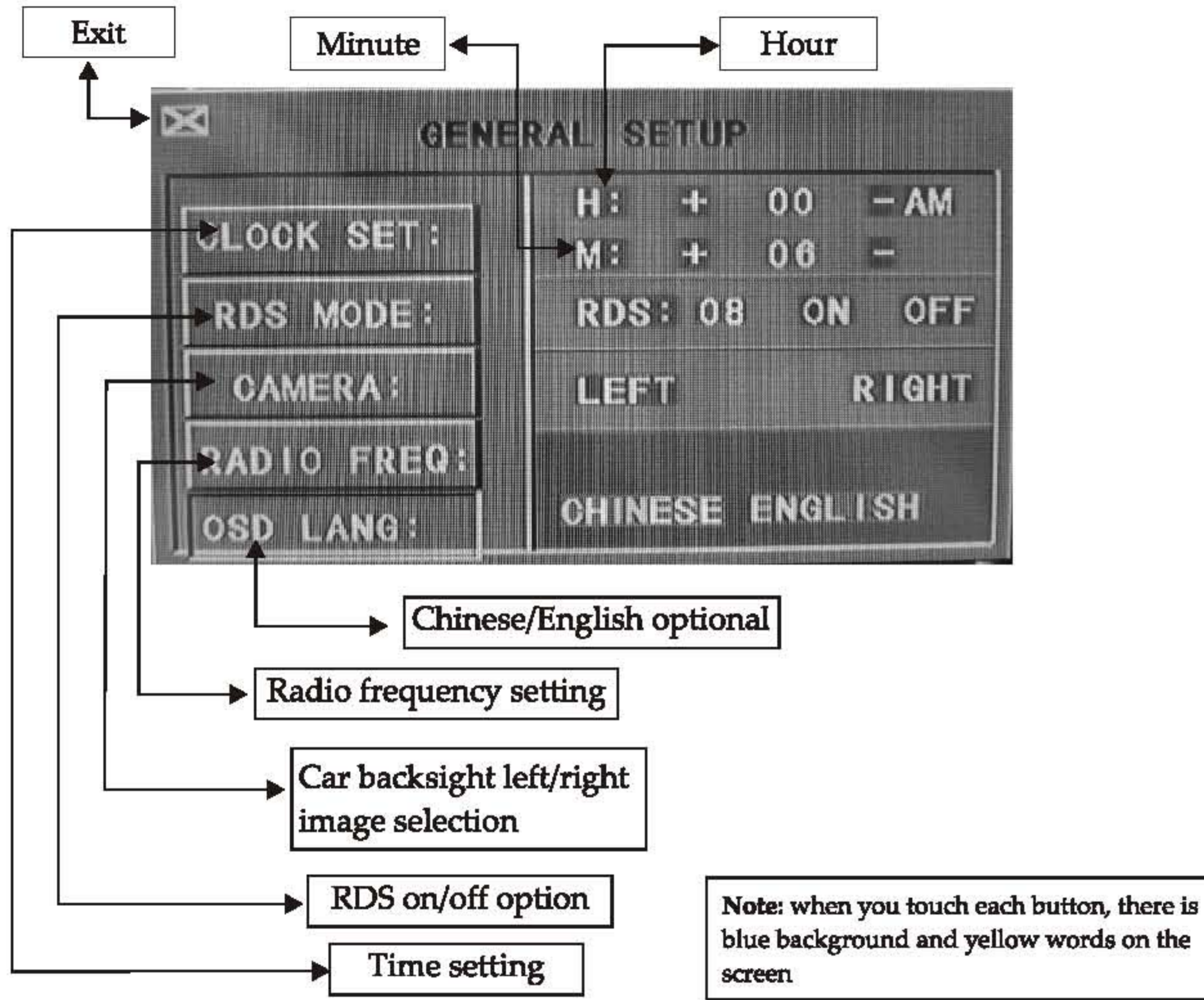

Note: There are 3 buttons automatically changed according to your setting change in radio state when you activate or exit RDS; Changes are as following: PTY ↔ LOUD ; TA ↔ EQ; AF ↔ ST

TIME DISPLAY AND ADJUST

Time display: Touch main menu into adjust mode, press time setup button, the corresponding function will be display in yellow words.

(1) Press "+" on hour to add hour, press "-" to reduce hour.

(2) Press "+" on minute to add minute, press "-" to reduce minute.

Note: Touch the Correspondence function, will be display in green background.

The unit include two times system: Europe time(24 hour setup) , America time(12 hour setup when show the AM mark it indicate Morning time, when appear the PM mark, it show the time of afternoon.)

Remark: This unit is with RDS function, it will automatically adjust the time when you activate RDS function or have received RDS radio channels. At no received RDS radio channels or AM state, you should adjust the time.

TV

Touch TV mode of the menu or press SOURCE button on remote control to switch to TV mode, auto scan and store channels.

Press AMS/RPT button on remote control or SCAN touch button on display to auto scan TV channels. The range of scan is full TV channel. The channels will auto store into number button in sequence.

1. Switch channel

1) Press SEEK+/SEEK- button on panel or SEEK+/SEEK- on remote control or ◀ / ▶ touch button on display, unit will skip to previous or next stored channel.

2) Press number button on remote control, unit will skip to appointed channel, for example, press 6 button ,unit will skip to 6 channel. Press 10+, " _ " will appear on left top corner of display, press number button 3,9, unit will skip to 39 channel.

2. Manual tuning TV channel

1) Press and hold SEEK+ button on panel, SEEK+ button on remote control, or ▶ touch button on display to scan TV channel in increase direction.

2) Press and hold SEEK- button on panel, SEEK- button on remote control, or ◀ touch button on display to scan TV channel in descending direction.

3. TV sound system switch

Press the AUDI button on the touch screen to switch TV sound system. The sequence is as follows:



4. Blue screen

The display will be blue when there is no signal.

INSTRUCTIONS

TV MODE (PIC 8)

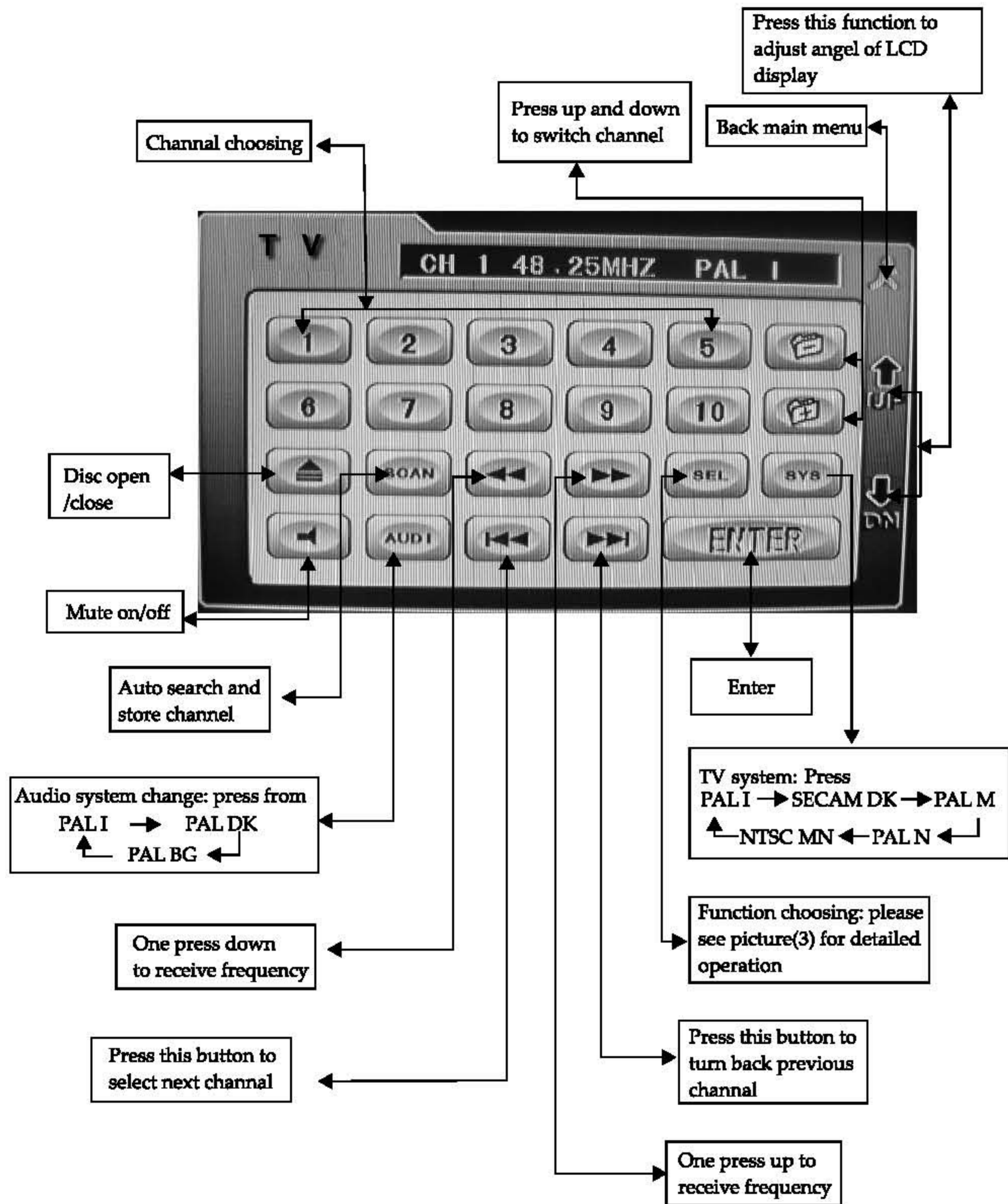

INSTRUCTIONS

ADJUST MODE (PIC 3)

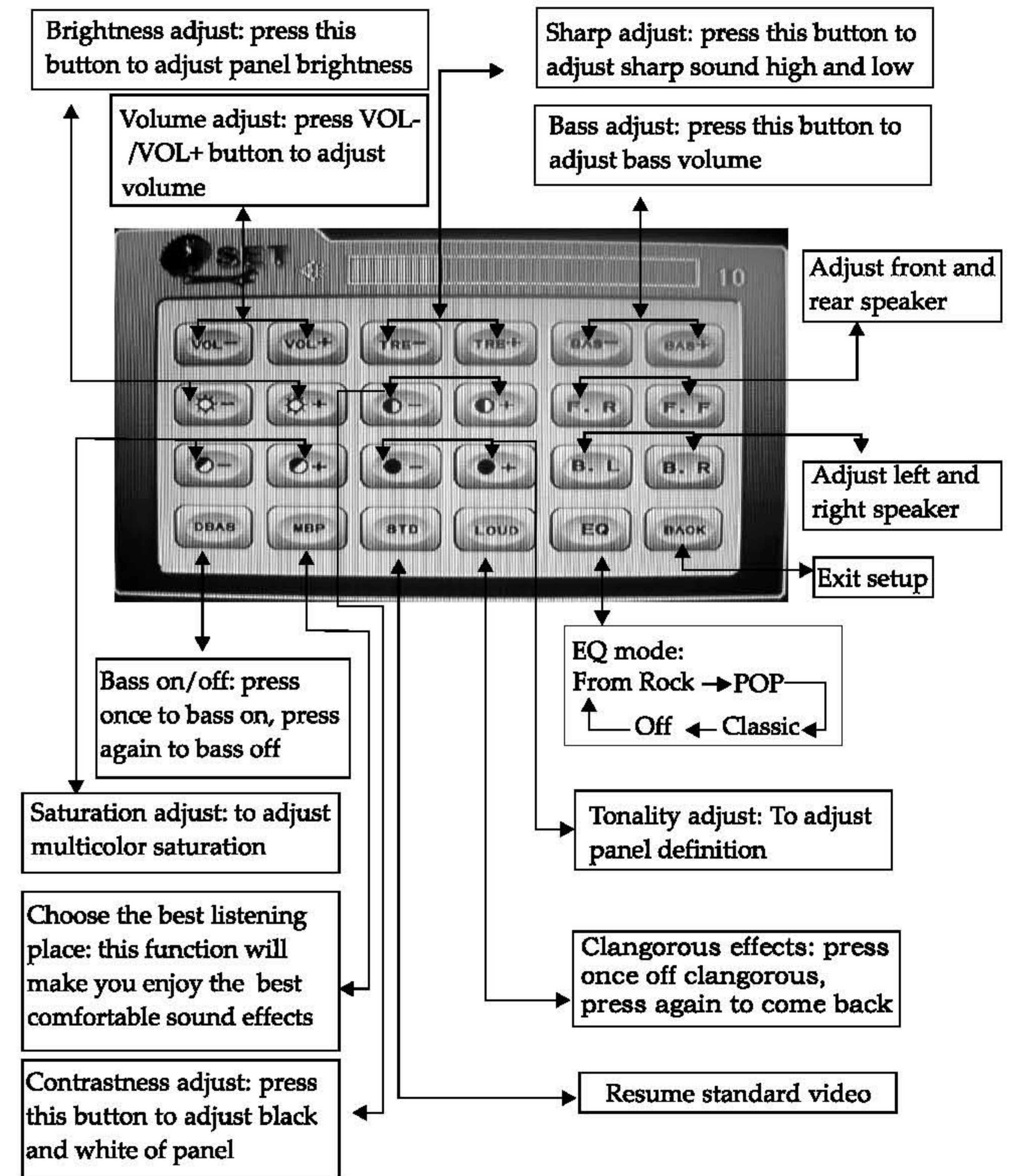

ROMOTE CONTROL FUNCTION

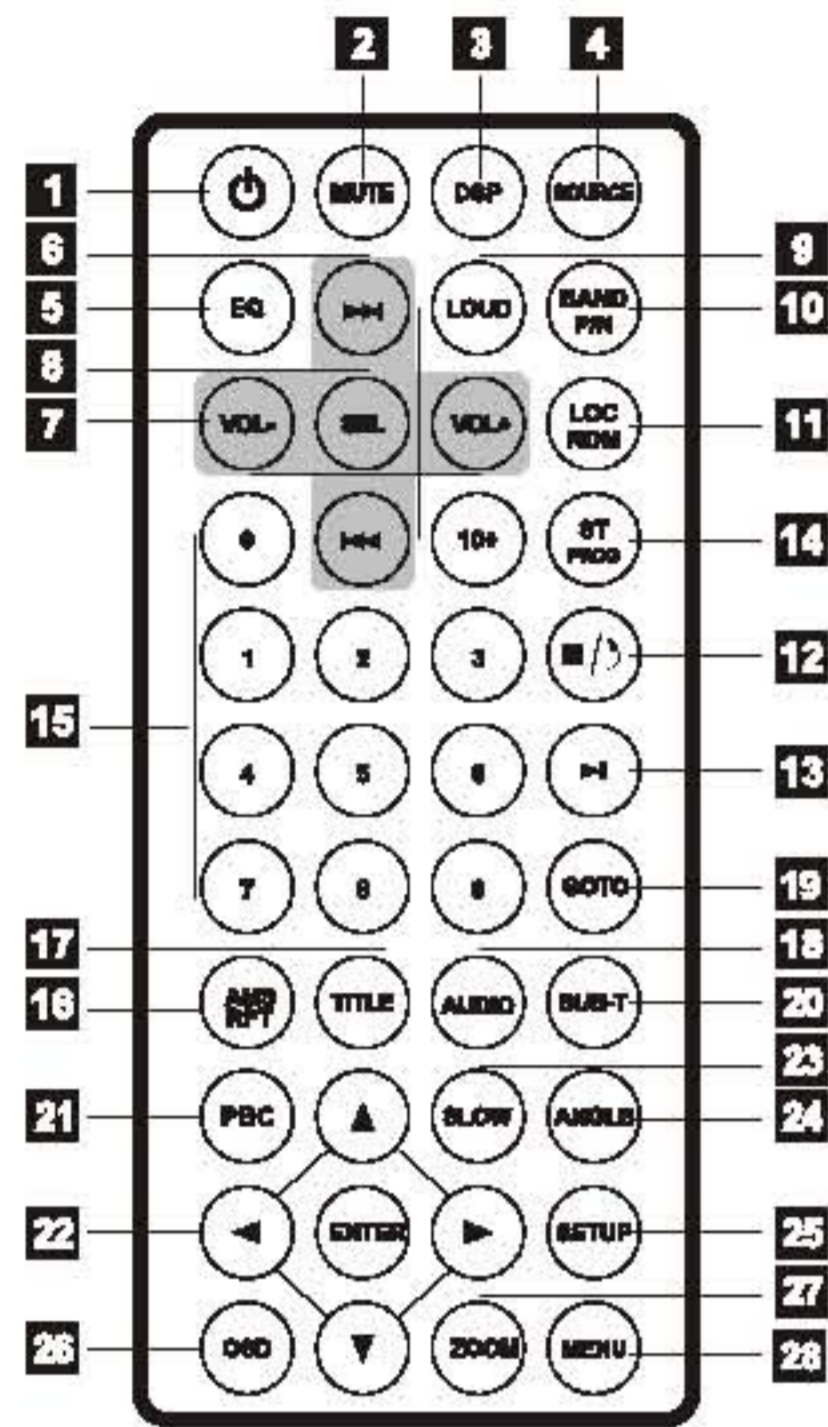

| | |
|-----------------------|-----------------------------|
| 1 POWER ON/OFF | 15 0-10+ |
| 2 MUTE | 16 AMS/RPT |
| 3 TIME DISPLAY | 17 TITLE |
| 4 SOURCE | 18 AUDIO |
| 5 EQ | 19 SET PLAYING TIME |
| 6 SEEK+/SEEK- | 20 SUBTITLE |
| 7 VOL+/VOL- | 21 PBC/MENU |
| 8 SEL | 22 UP/DOWN/L/R ENTER |
| 9 LOUD | 23 SLOW |
| 10 BAND/ P/N | 24 ANGLE |
| 11 LOC / RDM | 25 SET UP |
| 12 STOP | 26 OSD |
| 13 PLAY/PAUSE | 27 ZOOM |
| 14 ST/PROG | 28 MENU |

1.POWER

Press once to switch on, press again to switch off.

2.MUTE button

Press once to turn off audio output, press again to resume volume level.

3.DSP

Press this button to show the time.

4.SOURCE button

Press this button to choose audio sources.

5.EQ button

Press this button to choose POP, ROCK, CLAS, EQ OFF.

6. SEEK+ (▶▶) /SEEK- (◀◀) button

Press this button to manual tuning, speed or quick back, previous song and next song.

7. VOL + (→) /VOL - (←)

Press this button to increase or decrease volume level.

8.SEL button

Press this button to choose sound feature.

9.LOUD button

Press this button to startup LOUD function.

10.BAND /P/N button

In radio mode, press this button to choose band. In VCD,DVD mode,press this button to choose AUTO,PAL or NTSC system.

11.LOC/RDM button

In radio mode, press this button to switch between local and direction. In VCD, CD mode, press this key to randomly play.

12.STOP button

Press this button to stop playing.

13.PLAY/PAUSE button

Press this button to switch between play and pause. In stop mode, press this button to play.

14.ST/PROG button

In radio mode, press this button to choose stereo or mono station. In audio Mode, it can help STOP button to programmed play.

AUDIO FREQUENCY

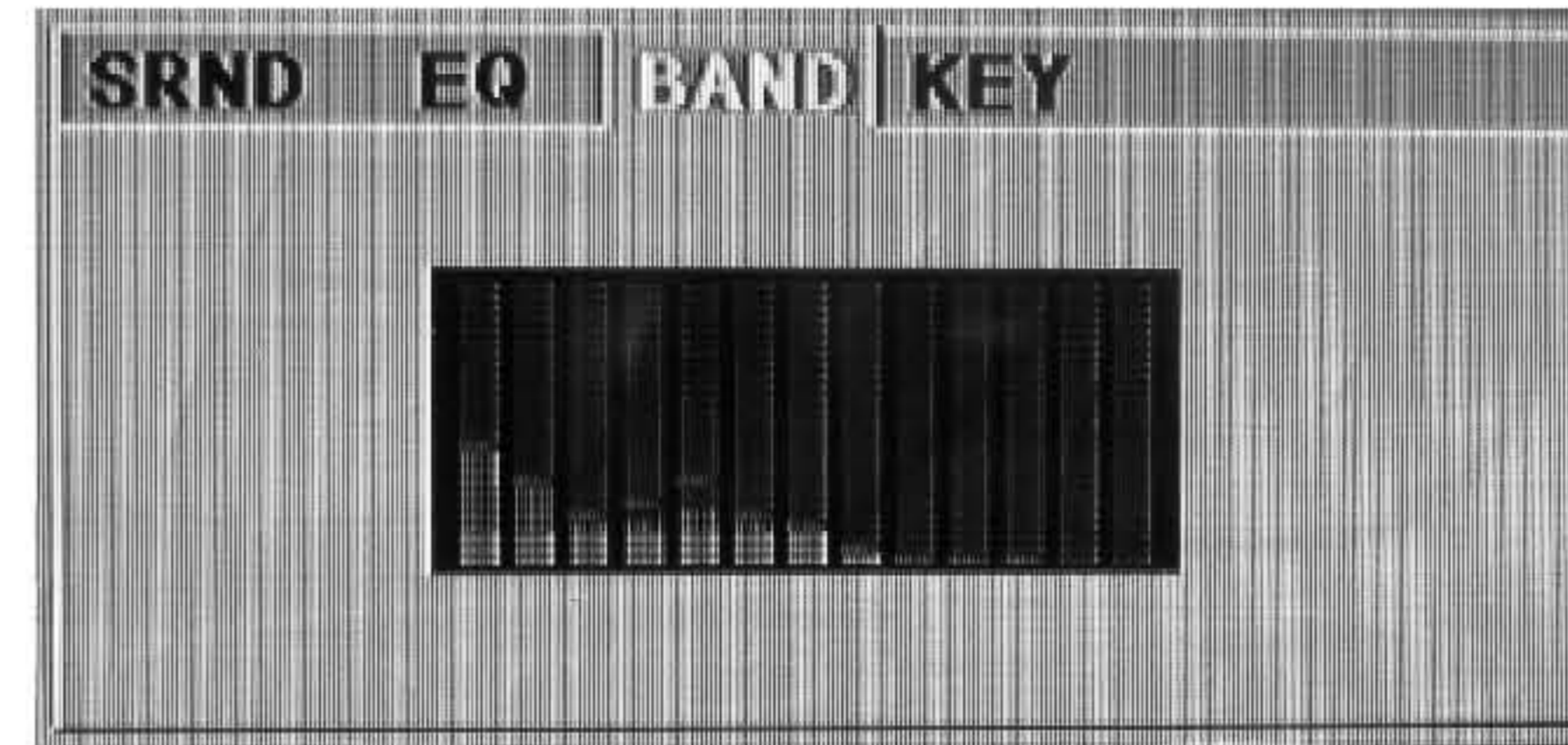

This function shows that the effect of standard audio output.

TONE

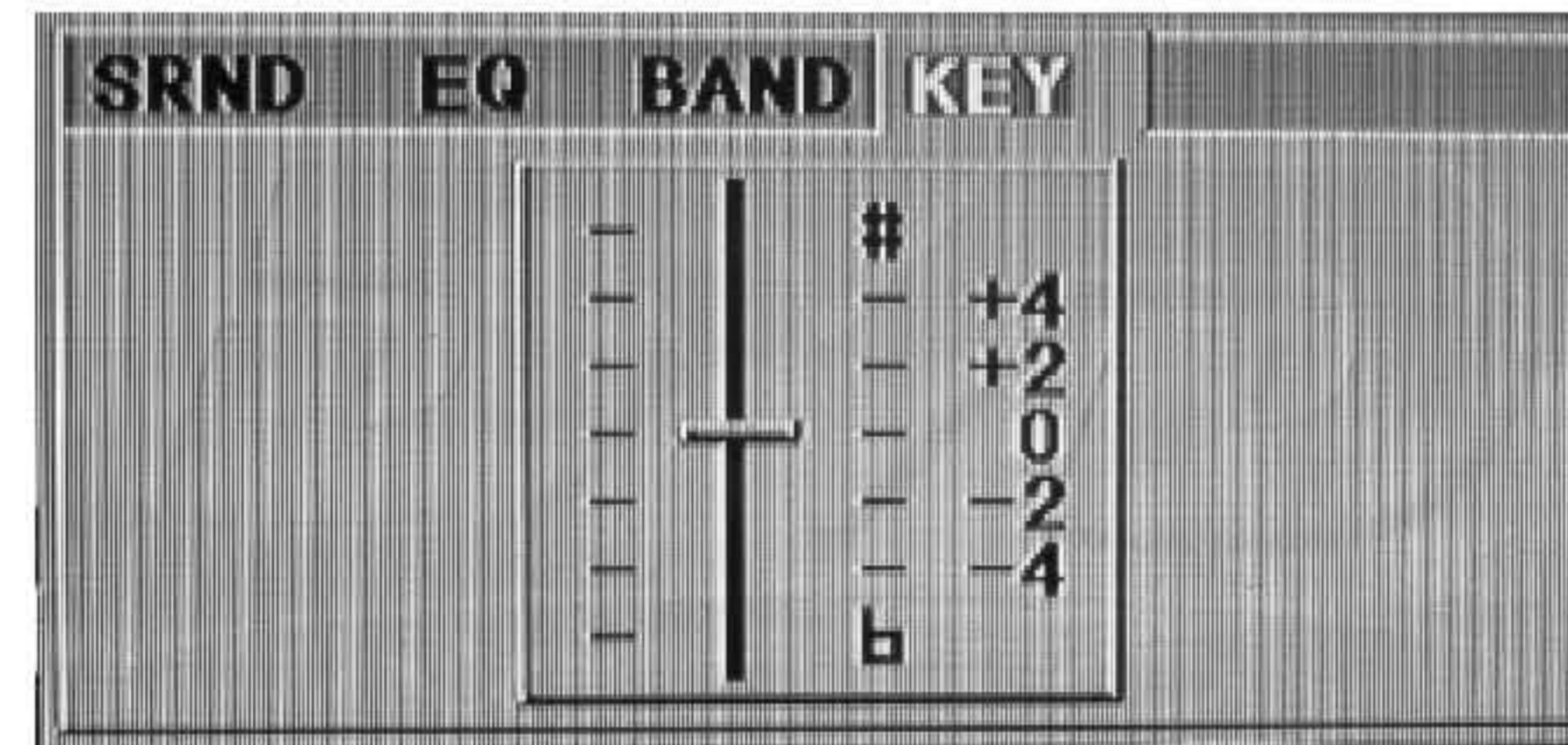

Note: You can change the timbre of the sound in DVD mode. We suggest keep it in the original place.

EQ SETTING

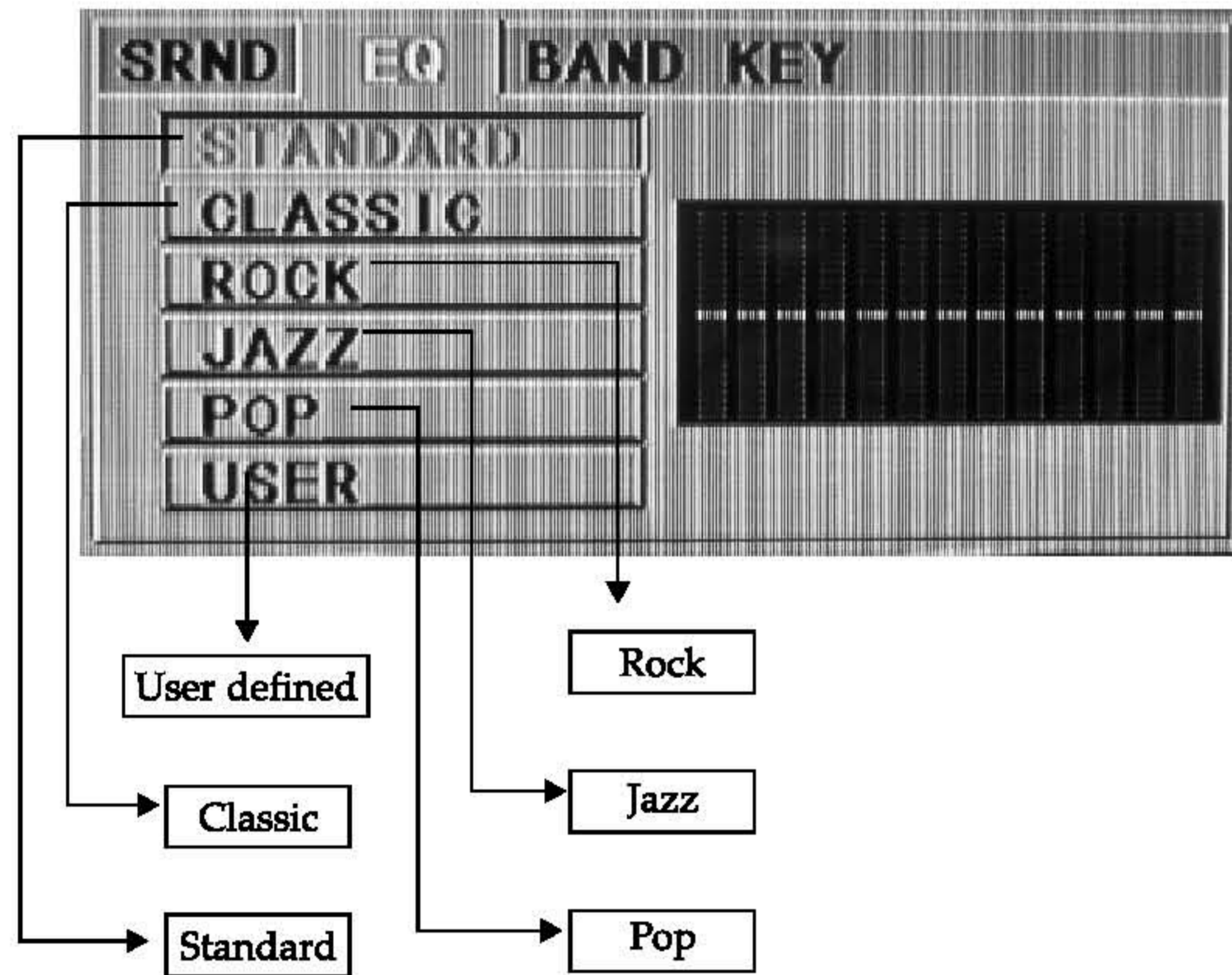

15.0-10+ button

Press this button to choose desired song, section, preset stations.

* Decimal numbers, for example the 19th song, press 1,9 button

* Centesimal numbers, for example, the 120th song, press 1,2,0 button.

16.AMS/RPT button

In radio mode, press this button to browse stored stations. In audio mode, press this button to play repeatedly.

17.TITLE button

In DVD mode, press this button to play back to the top menu of disk.

18.AUDIO button

In DVD mode, press this button to switch language of dialogue. In VCD mode, press this button to choose left track, right track, and stereo.

19.SET playing time

In DVD mode, press this button, you can define playing time.

20.SUBTITLE button

In DVD mode, press this button to switch language of subtitle.

21. PBC button

In VCD mode, press this button to display all song menu, work with number button to choose songs.

22. UP,DOWN,LEFT,RIGHT,ENTER button

In DVD mode, press this button to move cursor up, down, left, right to choose item in menu. Press enter button to confirm choice.

23.SLOW button

In audio mode, press this button to slow backward and slow forward.

24.ANGLE button

In DVD mode, press this button to change play angle.

25.SETUP button

In audio mode, press this button to choose different set items.

26.OSD display

Press this button to display the title chapter and the left time.

27. ZOOM button

In DVD/VCD mode, press this button to ZOOM in.

In CD/MP3/USB/SD mode, press this button to choose EQ.

28.MENU button

Press this button to back to the main menu.

BATTERY CHANGE

When control distance of remote control become shorter or no function, pls change battery. Pls confirm polarity before change.

One hand press stopper, then pull out battery.

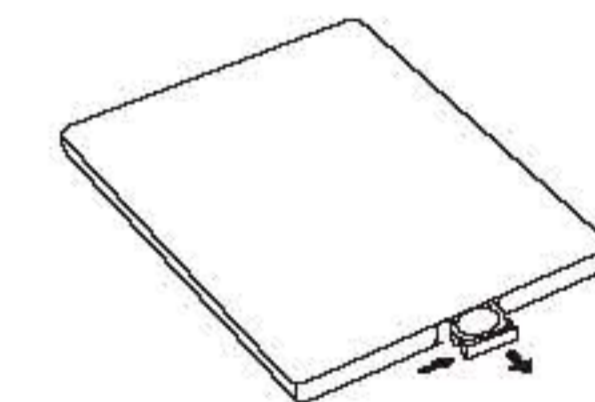

Put battery into controller

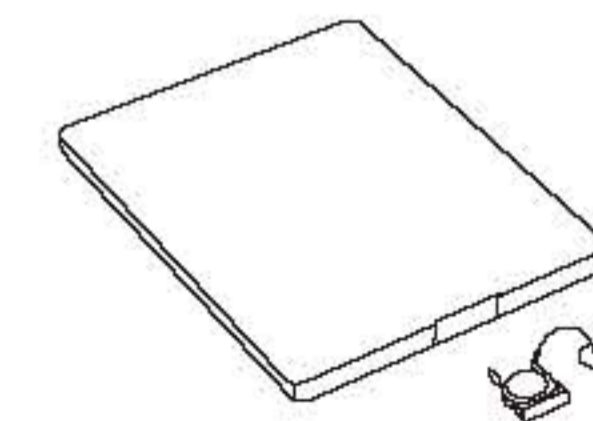

Insert battery holder into controller

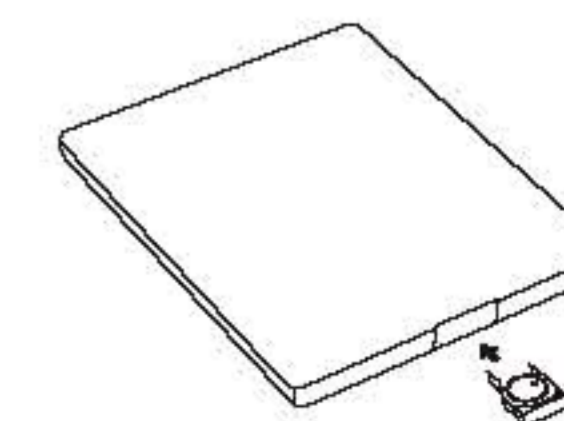

INSTRUCTIONS

LOADING

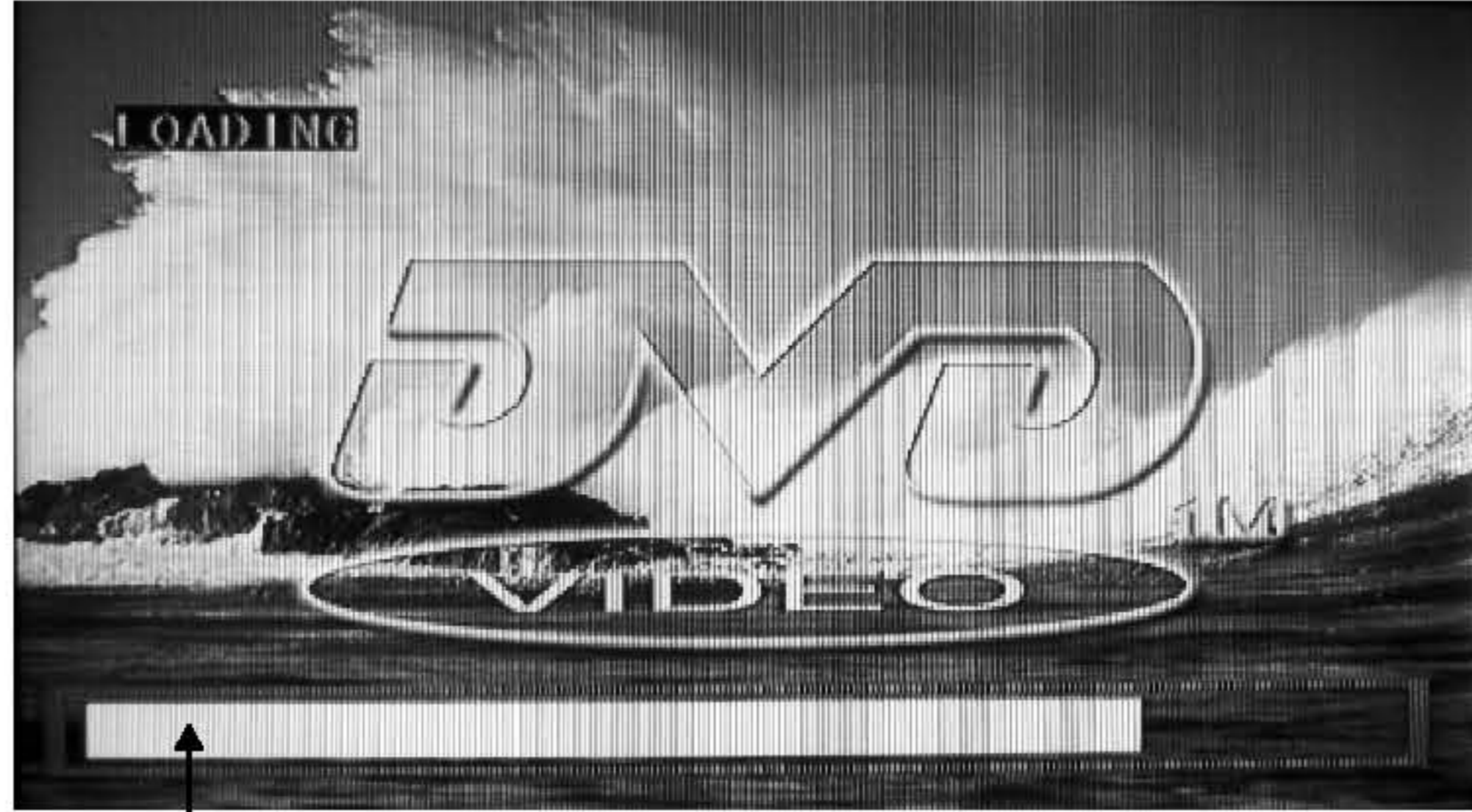

This white bar shows the rate of process of loading a disk

Note: When loading a disk, touch screen function can not be used.

INSTRUCTIONS

MUSIC SURROUNDINGS SETTING (PIC 7)

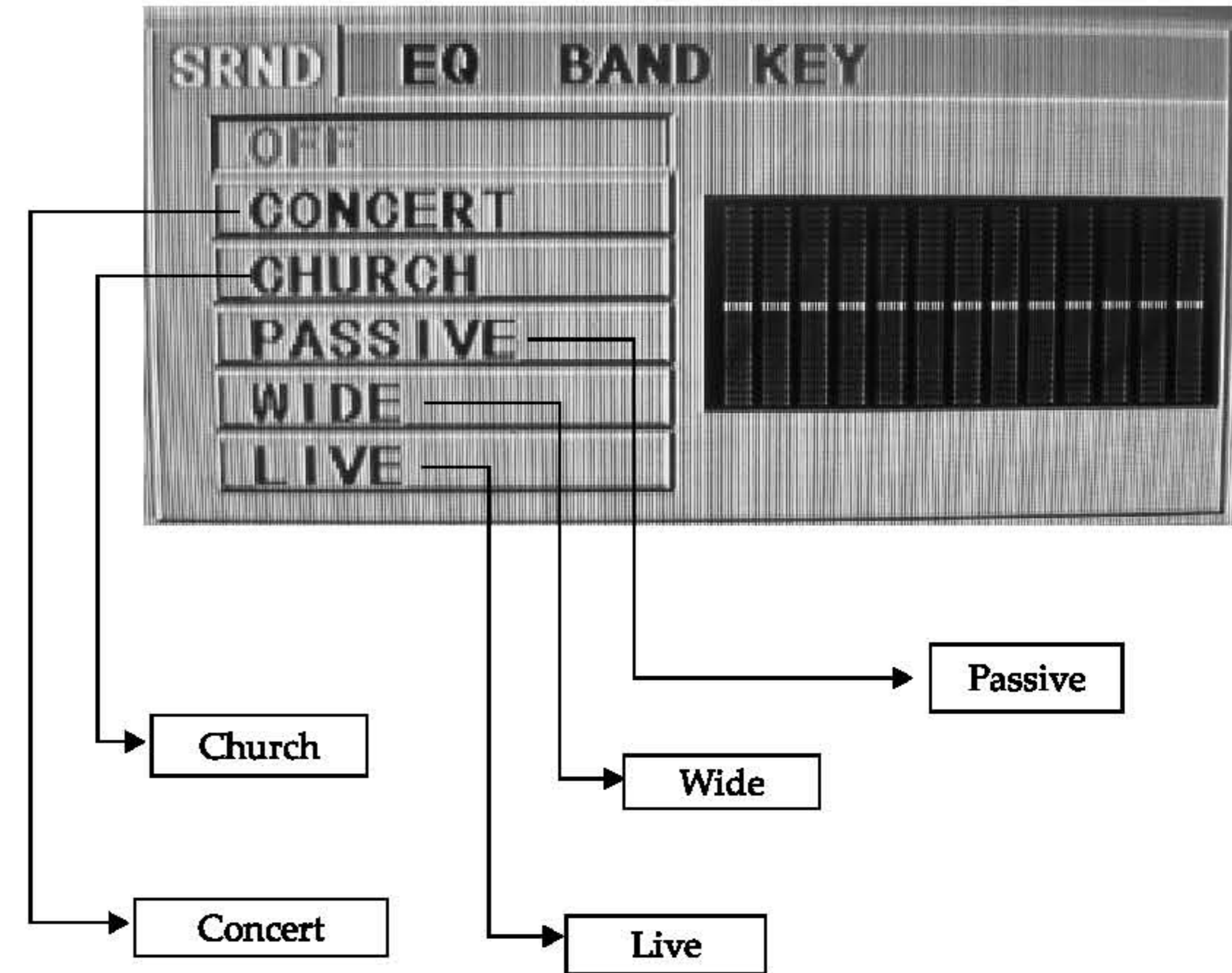

Note: This function only is used with the remote controll in CD/MP3/USB/SD mode.

9. OPEN

Press OPEN button on panel shortly to eject disk.

10. CD program play

In CD mode, you can set the sequence of playing by the program function, the operation is as follow:

When CD is playing, press ST/PROG button, then the display shows:

| PROGRAM | | | |
|---------|------|--------|----|
| 1 | 5 | 9 | 13 |
| 2 | 6 | 10 | 14 |
| 3 | 7 | 11 | 15 |
| 4 | 8 | 12 | 16 |
| | PLAY | DELETE | |

Input the No. of the song you want to program by the remote control. program the first song, input your desired song, for example, the sixth song, and press number button 6 on the remote control. Program the second song, press ▼ button move the cursor to 2[_ _]. input your desired song, for example, the ninth song, press number button 9 on the remote control. Press ► button to program play.

Back to the normal mode, press the ST/PROG button, then press ► button.

Note: this function can only be worked by the remote control.

11. Mp3 program play

In MP3 mode, you can set the sequence of playing by the program function, the operation is as follow:

When MP3 playing, press ST/PORG button, then the display shows:

| PROGRAM | | | |
|---------|------|--------|----|
| 1 | 5 | 9 | 13 |
| 2 | 6 | 10 | 14 |
| 3 | 7 | 11 | 15 |
| 4 | 8 | 12 | 16 |
| | PLAY | DELETE | |

Then, input desired song by remote control.

For example:

program the first song, input 01, press ► button move the cursor to the second lattice, input desired song, for example, the third song. Program the second song, press ► button, work with ▼ button, move the cursor to 2[_ _]. input 01, press ► button move the cursor to the second lattice, input desired song, for example, the sixth song(press 6). Press ► button to program play.

Back to the normal mode, press the ST/PROG button, then press ► button.

Note: this function can only be worked by the remote control.

DISK PLAY TOUCH OPERATION (PIC 4)

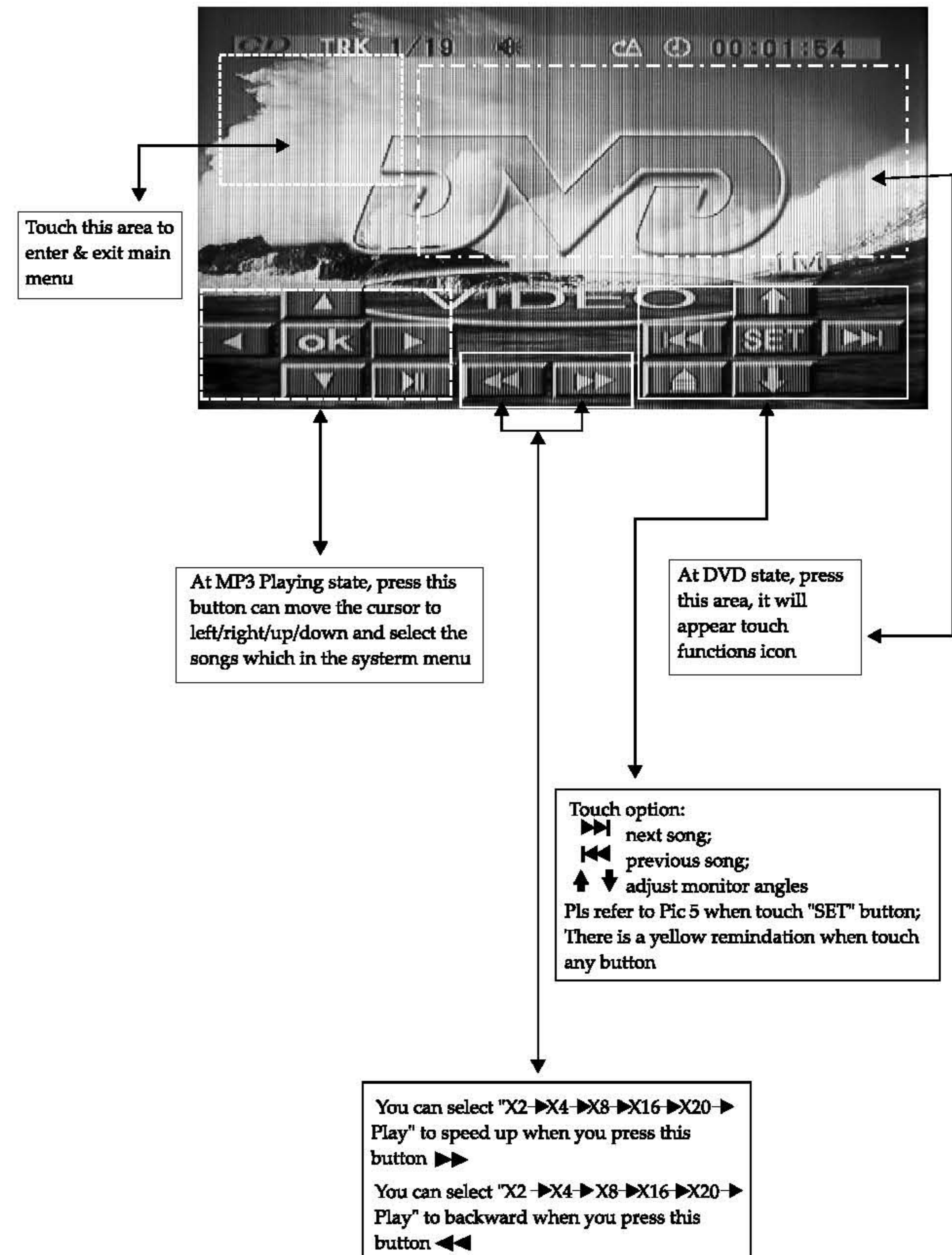

DVD MODE (PIC 5)

AUDIO SETTING ON TOUCH SCREEN

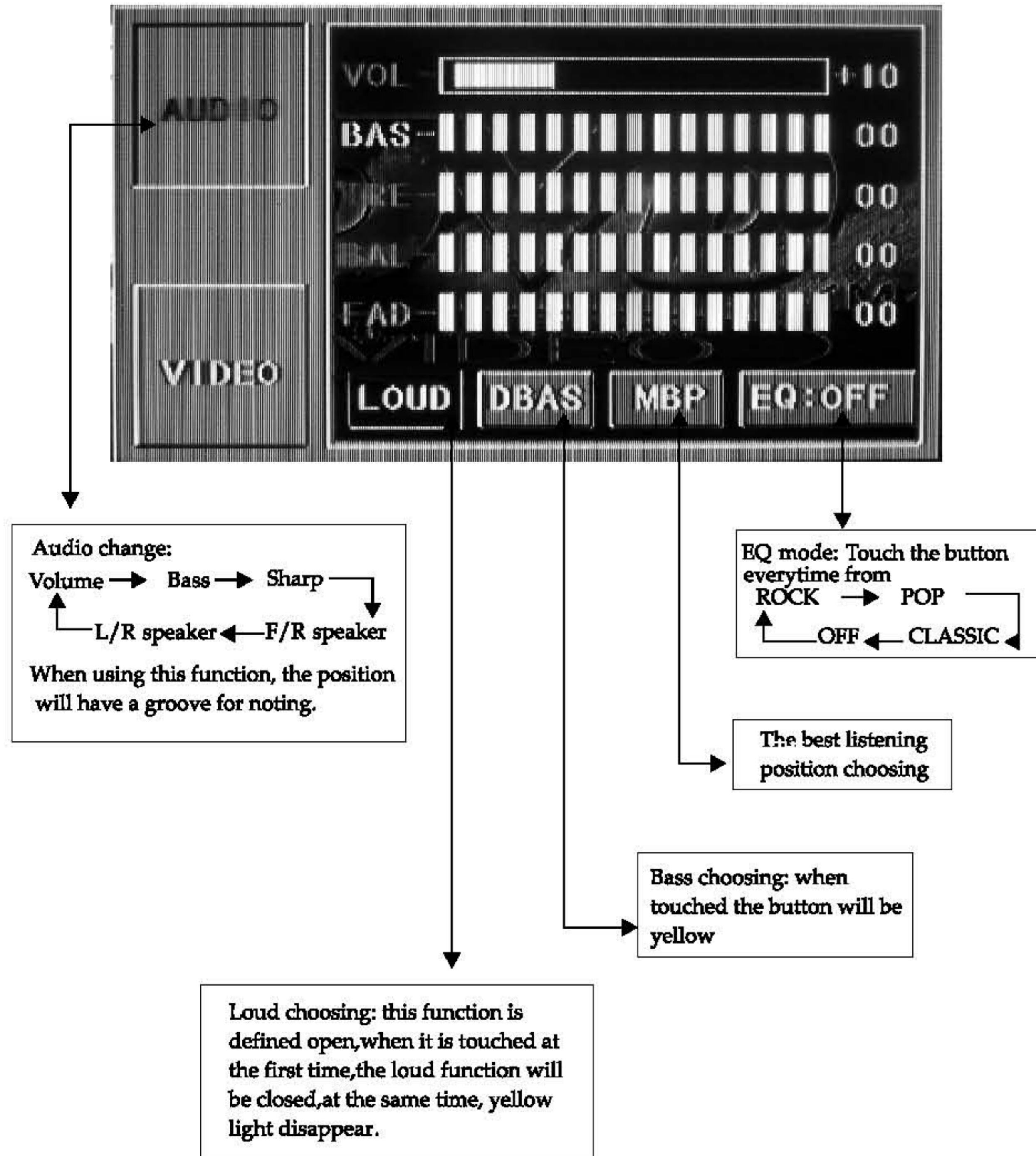

CD/MP3 BASIC OPERATION (Pls link with touch operation at pic4)

Slot in CD/MP3 disk, unit will play it automatically. If disk is in slot, press MODE button on panel to switch to DVD LOADING mode to play.

1. Repeat play

In CD/MP3 mode, press AMS/RPT button on remote control to startup following repeat:

CD disk: single song repeat → repeat play off

MP3 disk: single song repeat → directory repeat → repeat play off

2. Speed forward/backward play

Press SEEK+/SEEK- button on the remote control, or ► / ◀ touch button on display to speed forward or backward playing.

Note : Hold above button a bit longer to operate.

3. Previous/next song play

In playing mode, press SEEK+, SEEK- button on remote control, or ► / ◀ touch button on display shortly to play the previous or next song.

4. Pause play

In playing mode, press ► button on remote control, or ► touch button on display to pause. Press again to back to normal play.

5. Stop play

In playing mode, 1) press ■/▶ button on remote control to enter the pause mode, the position will be stored in unit. At that time, press ► button on remote control or touch button on display to resume playing at the stored position.

2) press ■/▶ button on remote control twice to enter into stop mode, here, press ► button on remote control or touch button on display, unit will play from the first song.

6. OSD

In playing mode, press OSD touch button on display to display the position and time of present song.

7. Randomly play

In CD mode, press LOC/RDM button on remote control, to instantly play each song. Press again to back to the normal play.

8. EQ mode

1) this function can only be worked by remote control

2) when playing CD/MP3, press the "ZOOM" button on the remote control, you can choose the sound mode.

3) when enter this function, press the button ▲/▼/◀/▶ to move the course to select sound mode which in the system menu, after your selection the function position will show red color to indicate the confirmation, detail operation can refer to pic 7.

14.PBC(MENU)play

In VCD mode, press this button then play the PBC and display will show whole menu in disk, work with number button to choose song..when you are playing either song of the PBC,and you want to stop to select another song,press the button to turn off.

Note:

- 1.this function can be worked by the remote control.
- 2.PBC is suitable for the SVCD and VCD2.0 disc.
- 3.In PBC mode,you can not press number button only to choose song.
- 4.In PCB mode, you can press touch button on display to back to menu.

15.VCD program playing

In VCD mode, you can set playing sequence of songs by program play function.The program playing operation steps are as follows:

In VCD mode,press ST/PROG button, display will show:

| PROGRAM | | | |
|---------|---------|----------|----------|
| 1 _____ | 5 _____ | 9 _____ | 13 _____ |
| 2 _____ | 6 _____ | 10 _____ | 14 _____ |
| 3 _____ | 7 _____ | 11 _____ | 15 _____ |
| 4 _____ | 8 _____ | 12 _____ | 16 _____ |
| | PLAY | DELETE | |

Input the songs which you want to programmed by the number buttons on remote control. For example: program the first song, input your desired song, for example, the fourth song, and press number button 4 on the remote control. Program the second song, press ▼ button move the cursor to 2_ __. input your desired song, for example, the eighth song, press number button 8 on the remote control. Press ► button to program play.

Back to the normal mode, press the ST/PROG button, then press ► button.

Note:this function can only be worked by the remote control.

VIDEO SETTING ON TOUCH SCREEN

You can choose: lightness, contrastness, color, sharpness, change the color accord to the user, at the same time, there will be blue light for noting.

VIDEO mode: When using this function,the position will have a groove for noting.

Image mode: you can choose the area in the broken line on the panel, standard, defined, soft, accord what you need to choose, when choosing the function, the blue backlight will disappear.