

No.	Unit	Description	Remark
1	RDU 1900P+AWS-1	RF Module	
2	1900P+AWS-1 BPF	BPF	
3	1900P+AWS-1 RF CABLE	SMA(M) to SMA(M), 390mm	
4	1900P+AWS-1 RF-01	SMA(M) to SMA(M)	Semirigid

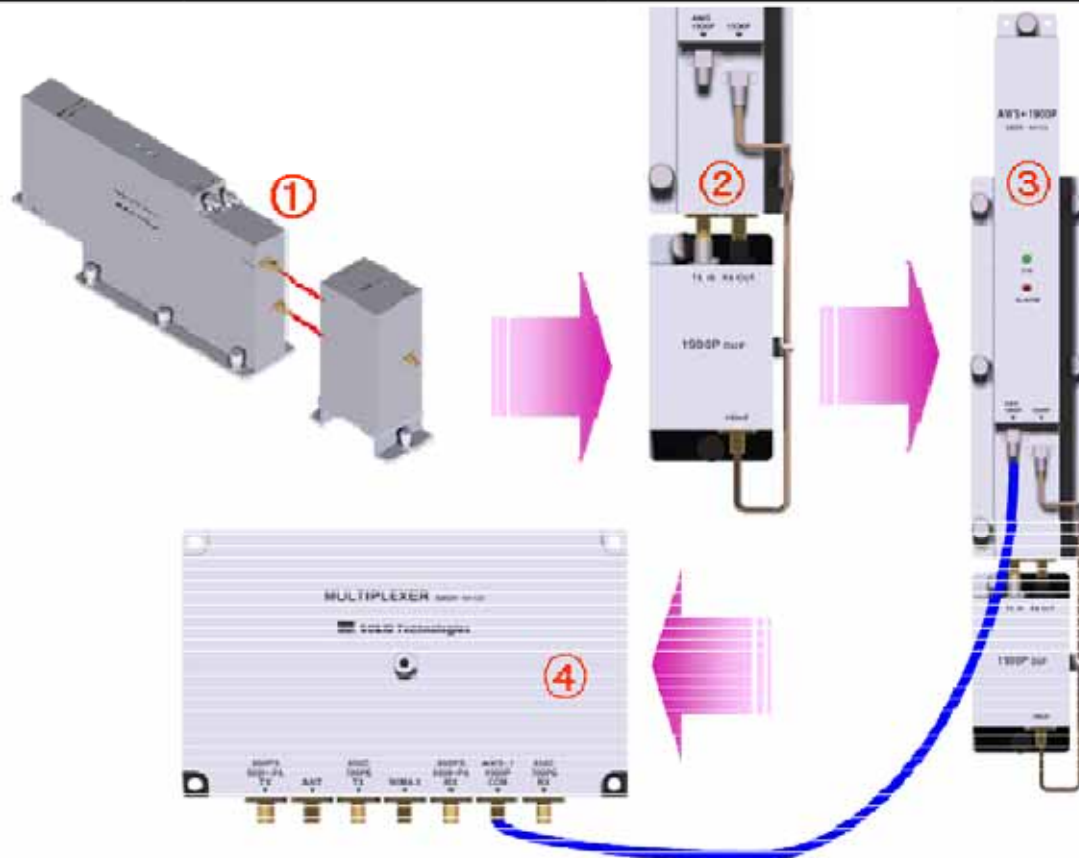

- ① Combine RDU 1900P+AWS-1 with 1900P BPF (As it is a plug type, push the unit to combine with BPF.)
- ② Connect BPF 1900P port with 1900P port of 1900P RDU through 1900P+AWS-1 RF-01 RF CABLE.
- ③ Insert the combined 1900P+AWS-1 BPF Ass'y into any slot of ROU.
- ④ Combination point of 1900P+AWS-1 BPF Ass'y of the multiplexer

Multiplexer Port naming	Interface Point		Remark
	1900P+AWS-1 RDU	1900P BPF	
AWS-1+1900P COM	1900P+AWS	-	

How to install RDU VHF+UHF Ass'y

The following components are required:

No.	Unit	Description	Remark
1	RDU VHF+UHF	RF Module	
2	RDU VHF+UHF RF CABLE	SMA(M) to SMA(M), 460mm	
3	RDU VHF+UHF RF CABLE	SMA(M) to SMA(M), 380mm	

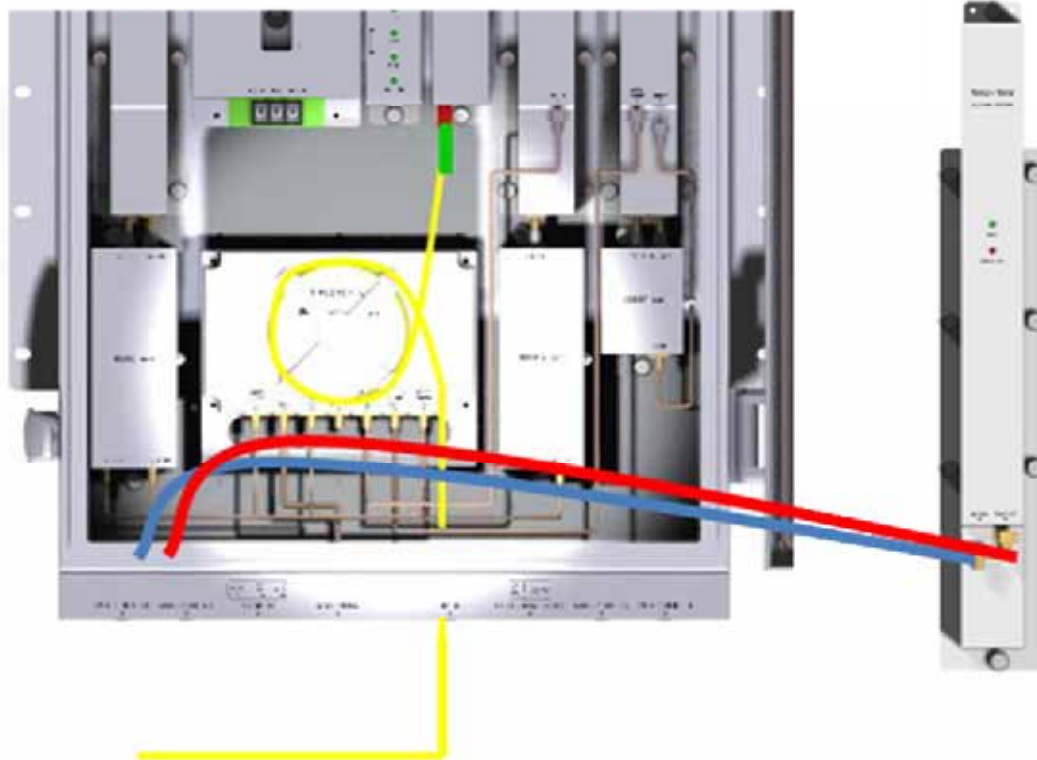

- ① Insert the combined VHF+UHF RDU into any slot of ROU.
- ② Connect RDU VHF+UHF Port with ROU VHF+UHF Port through VHF+UHF RF CABLE

How to install RDU 850C+700LTEC Ass'y

The following components are required:

No.	Unit	Description	Remark
1	RDU 850C+700LTEC	RF Module	
2	850C+700PS BPF	BPF	
3	850C+700PS TX RF CABLE	SMA(M) to SMA(M), 470mm	
4	850C+700PS RX RF CABLE	SMA(M) to SMA(M), 400mm	

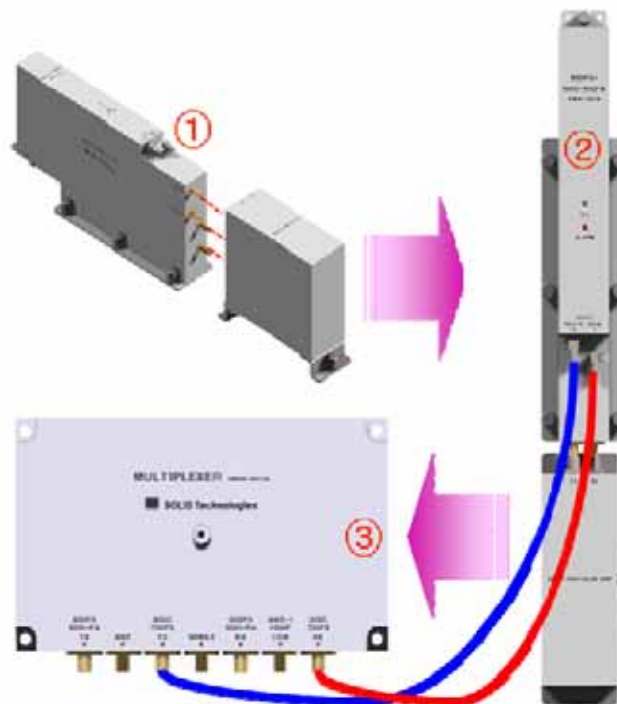

- ① Combine RDU 850C+700 LTEC with 850C+700PS BPF (As it is a plug type, push the unit to combine with BPF.)
- ② Insert the combined 850C+700 LTEC BPF Ass'y into any slot of ROU.
- ③ Combination point of 850C+700PS/700LTE BPF Ass'y of the multiplexer

Multiplexer Port naming	Interface Point		Remark
	850C+700LTEC RDU	850C+700PS BPF	
850C/700PS/700LTE TX	TX OUT	-	
850C/700PS/700LTE RX	RX IN	-	

How to install RDU 700LTEF Ass'y

The following components are required:

No.	Unit	Description	Remark
1	RDU 700LTEF	RF Module	
2	700LTEF BPF	BPF	
3	700LTEF TX SISO RF CABLE	SMA(M) to SMA(M)	SISO
4	700LTEF RX SISO RF CABLE	SMA(M) to SMA(M)	SISO
5	700LTEF TRX MIMO RF CABLE	SMA(M) to SMA(M)	MIMO

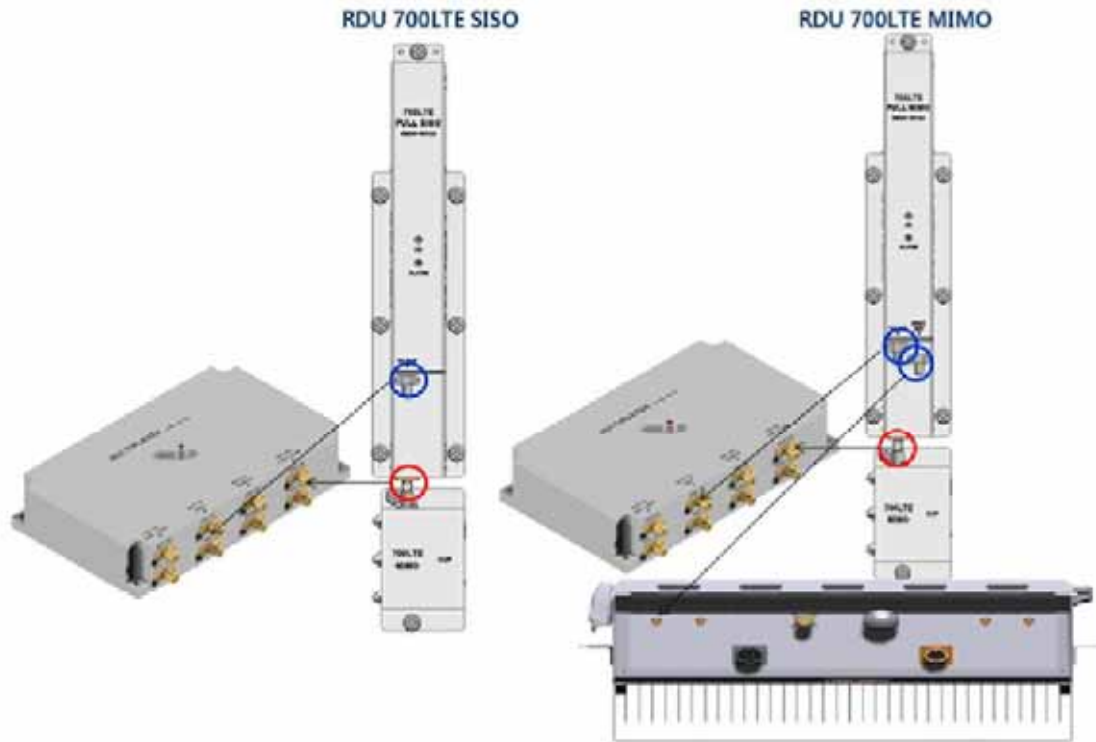

- ① Combine RDU 700LTEF with 700LTEF BPF (As it is a plug type, push the unit to combine with BPF.)
- ② Insert the combined 700LTEF BPF Ass'y into any slot of ROU.
- ③ Combination point of 700LTEF BPF Ass'y of the multiplexer

Multiplexer Port naming	Interface Point		Remark
	700LTEF RDU	700LTEF BPF	
700LTEF SISO TX	TX OUT	-	
700LTEF SISO RX	RX IN	-	
700LTEF MIMO TRX	TRX OUT/IN	-	



You cannot insert the same module and band into MULTIPLEXER port at the same time. For example, you are not supposed to insert both of 800PS RDU and 800PS+900I+PA RDU into ROU at the same time. In the same way, you cannot concurrently insert both of 850C RDU , 850C+700PS RDU and 850C+700LTEC into ROU. In addition, if you want to use 700LTEF RDU and 850C+700PS RDU in the ROU concurrently, you should change the multiplexer supporting these band together

Information of LED at the front RDU

RDU has the structure of enabling a random RDU to be inserted into three slots. ROU can be equipped with a total of three RDUs. If only one RDU is inserted into a slot and the other slots remain reserved, you need to insert BLANK cards into the other slots.

When RDU is inserted into ROU, LED of the front panel shows the following information:



LED		Description
ON	● (Grey)	Power is not supplied
	● (Green)	Power is supplied.
ALM	● (Green)	Normal Operation
	● (Red)	Abnormal Operation



Up to three RDUs can be inserted. If one or two units of them are used, then you need to terminate the unused slot of RDU with a BLANK card.

5.3.7 Consumption of RDU

The following table shows power consumption of RDU:

Part	Unit	Consumption Power		Remark
Common Part	Enclosure	17W		
	RCPU			
	ROPTIC			
	RPSU			
	Multiplexer			
RDU	RDU 800PS	39W		
	RDU 800PS+900I+Paging	800PS	49W	900I+PA HPA OFF
		900I+PA	72W	800PS HPA OFF
		FULL	79W	Both HPA ON
	RDU 850C	39W		
	RDU 850C+700PS	850C	49W	700PS HPA OFF
		700PS	58W	850C HPA OFF
		FULL	93W	Both HPA ON
	RDU 1900P+AWS-1	1900P	46W	AWS-1 HPA OFF
		AWS-1	46W	1900P HPA OFF
		FULL	68W	Both HPA ON
	RDU VHF+UHF RDU E-VHF+UHF	VHF	47W	VHF HPA OFF
		UHF	47W	UHF HPA OFF
		FULL	74W	Both HPA ON
	RDU 850C+700LTEC	850C	49W	700LTEC HPA OFF
		700LTEC	58W	850C HPA OFF
		FULL	93W	Both HPA ON

	RDU 700LTEF SISO	32W	
	RDU 700LTEF MIMO	50W	SISO & MIMO HPA ON

For power consumption of ROU, the common part consumes 17W. Depending on the quantity of each RDU, you can add overall power consumption of ROU. Only, in case of Dual-Band signals, power consumption is calculated respectively when HPA of the other party is turned OFF and two HPA devices are turned ON. Note that when you calculate Power Budget.

5.4 OEU Installation

OEU is used to expand ROU in Campus Site.

OEU is located at a Remote Closet. As it can be equipped with up to two DOUs, you can expand a total of eight ROUs.

5.4.1 OEU Shelf installation

OEU is a shelf in around 2U size. Its width is 19" and so this unit should be inserted into a 19" Standard Rack. OEU is in a Remote Closet, providing optical ports of ROU.

The following table shows power consumption of OEU:

No.	Unit	Description	Remark
Common Part	Shelf	Including EWDM,ERF,EPSU,EPCU, 19",2U	1EA
	Power Cable	-48Vdc Input with two lug terminal	1EA
Optional Part	DOU	Optical Module with 4 Optic Port	Up to 2EA to be inserted

5.4.2 OEU Power Cabling

The input power of OEU is DC -48V. You need to connect DC cable with the Terminal Block seen at the rear of OEU.

Terminal	Color of cable	Description	Remark
-48V	Blue color	Input range: -42 ~ -56Vdc	
NC	Not Connected		
GND	Black color		

Before connecting the power terminal, you need to connect “+” terminal of Multi Voltage Meter probe with the GND terminal and then connect “-” terminal with -48V to see if “-48Vdc” voltage is measured. After the check, connect the power terminal through the terminal seen below.

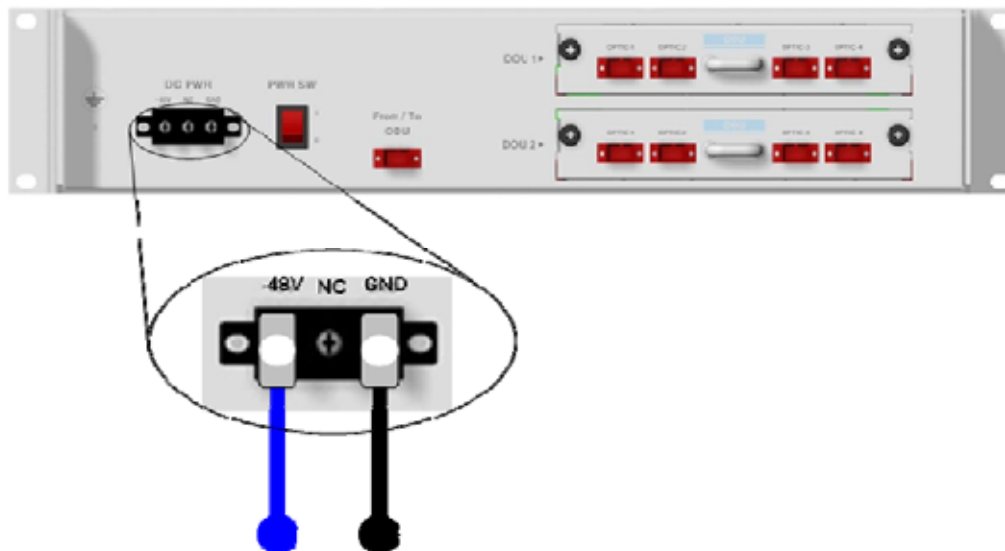

 Note that OEU does not operate if the “+” terminal and the “-” terminal of the -48V power are not inserted into the accurate polarity.

5.4.3 OEU Optic Cabling

OEU is connected with upper ODU. With DOU inserted in it, the unit is connected with ROU. As OEU has a shelf with EWDM in it, the unit makes electronic-optical conversion of TX signals from ODU and makes optical-electronic conversion of RX signals. In addition, OEU can be equipped with up to two DOUs. One DOU supports four optical ports and one optical port can be connected with ROU. With WDM in DOU, the unit can concurrently send/receive two pieces of wavelength (TX:1310nm, RX:1550nm) through one optical core. DOU has SC/APC of optical adaptor type.



Figure 5.7 – Optical cable of SC/ACP Type

For optical adaptor, SC/APC type should be used. To prevent the optical access part from being marred with dirt, it should be covered with a cap during move. When devices are connected through optical cables, you need to clear them using alcohol to remove dirt.

5.4.4 Insert DOU to OEU

Into OEU Shelf, up to two DOUs can be inserted. DOU module is in Plug in Play type. When you insert DOU in OEU, insert the unit into the top DOU1 slot first. You can be careful as the number is silk printed at the left.

The following figure shows installation diagram of OEU with one DOU inserted in it.



The following figure shows installation diagram of OEU with two DOUs inserted in it.

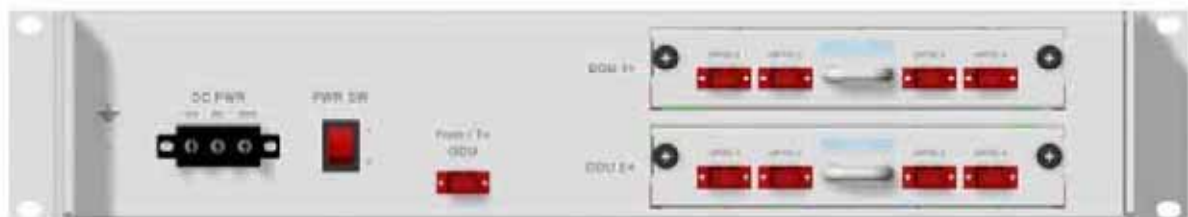

When you insert DOU into OEU, insert the unit into the top DOU1 first. For unused slots, you need to install BLANK UNIT into them.

5.4.5 Consumption Power of OEU

OEU has -48V DC Power supply in it. ODU can be equipped with up to two DOUs. Depending on the quantity of DOU, power consumption is varied.

The following table shows power consumption of OEU:

Part	Unit	Consumption Power	Remark
Common Part	Shelf	12W	
	EWDM		
	ERF		
	EPSU		
OEU_4	DOU 1 EA	23W	
OEU_8	DOU 2 EA	33W	

5.5 ADD ON ROU Installation

5.5.1 AOR Enclosure installation

AOR is designed to be water- and dirt-proof. The unit has the structure of One-Body enclosure. It satisfies water-proof and quake-proof standards equivalent of NEMA4 like existing ROU. AOR can be mounted into either of a 19" Standard Rack or on a Wall.

Basically, AOR has both of a Wall Mount Bracket and a Rack Mount Bracket.

Depending on the usage the Rack Mount Bracket or the Wall bracket can be removed.

The following shows dimension of the fixing point for the Wall Mount Bracket.

AOR should be installed above or under of existing ROU

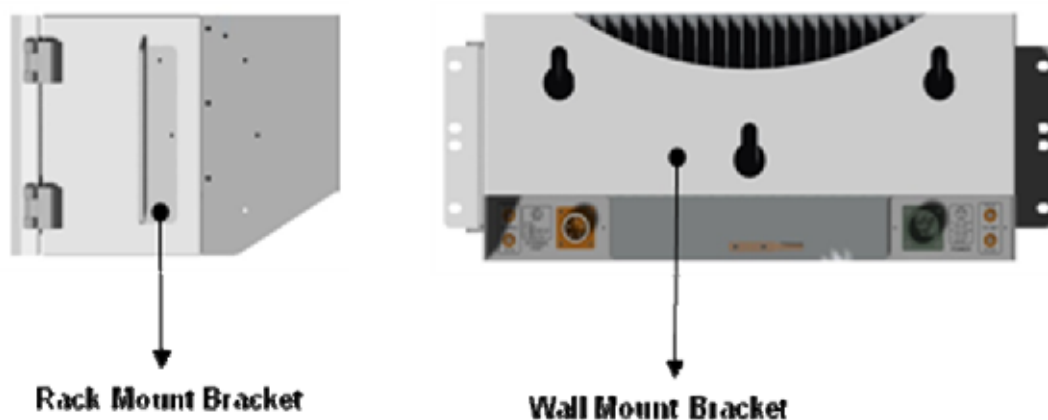

Figure 5.8 – How to install AOR

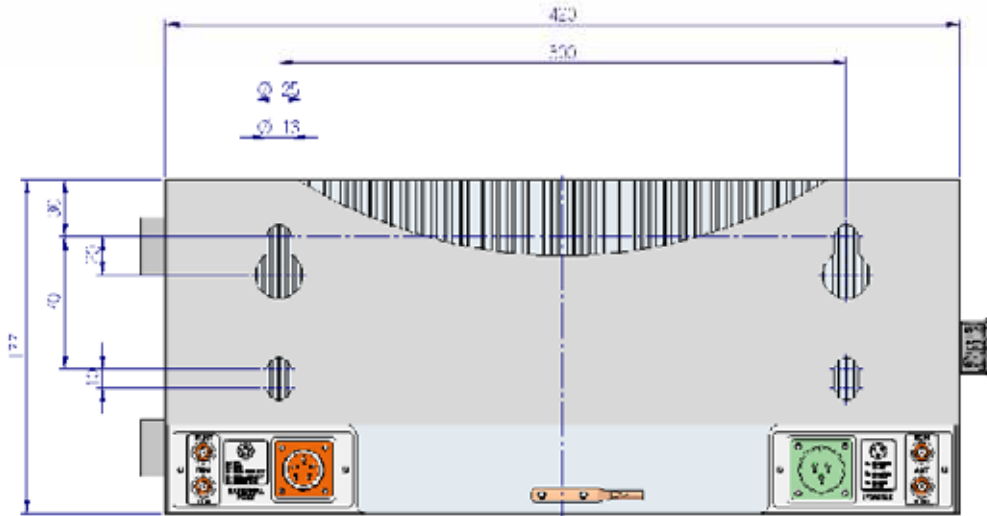
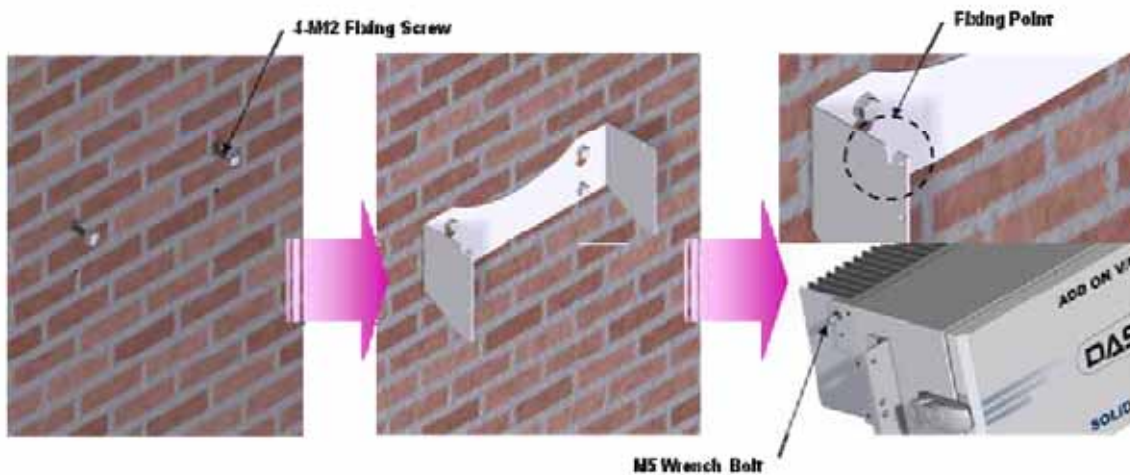

Figure 5.9 – Dimension used to install AOR on the WALL

ROU Wall Mount Installation

Turn M12 Fixing Screws by half on the wall and fully fix the screw with a Wall Mount Bracket on it. For convenience, the Wall Mount Bracket has fixing holes to let you easily mount an enclosure. Turn the M5 Wrench Bolt by half at each side of the Heatsink of the enclosure.



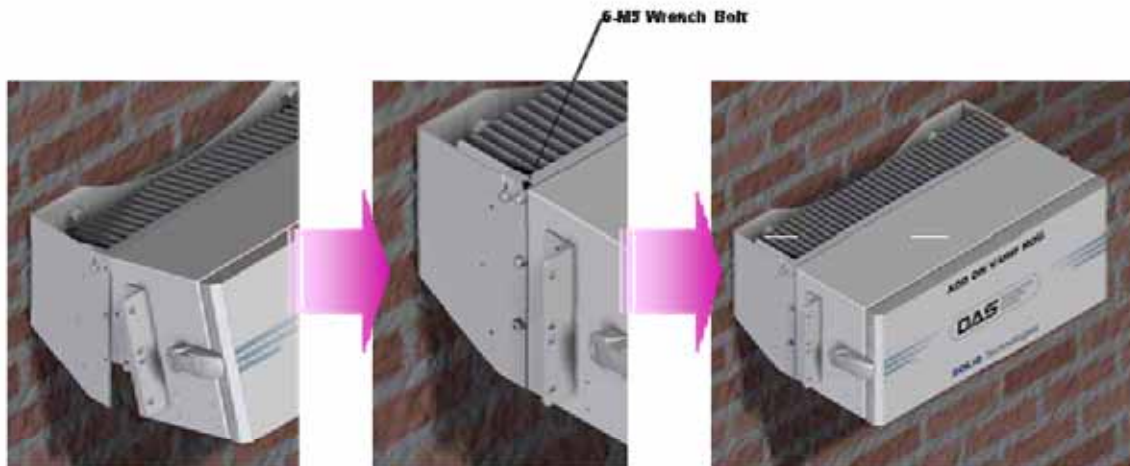

Figure 5.10 – Installation flow diagram when AOR installs on wall

Put the enclosure with the M5 Wrench Bolt fixed on the fixing groove and fix the M5 Wrench Bolts into the remaining fixing holes.

In this case, you will use 6EA of M5 Wrench Bolts in total except bolts used for the fixing groove.

ROU Rack Mount Installation

Like other units, AOR is designed to be inserted into a rack. The unit occupies about 4U of space except cable connection.

In case that AOR is installed more close above/below existing ROU, temperature of ROU/AOR increase ambient temperature, which increase ambient of AOR/ROU. Then, AOR/ROU's temperature is increased. Therefore, we recommend that AOR should be installed with at least constant space from existing ROU(above 2U)

The following shows the installed diagram on rack with existing ROU

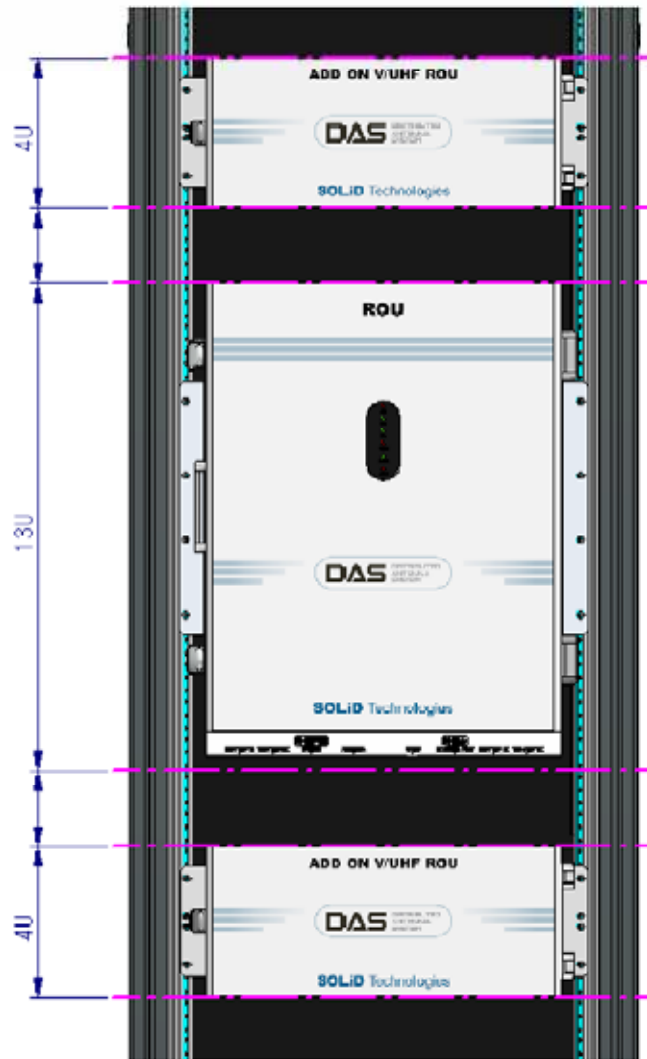

Figure 5.10 – Installation flow diagram when AOR installs in the rack

AOR components

AOR has the following components:

No.	Unit	Description	Remark
Common Part	Enclosure	Including Rack & Wall bracket	1EA
	AOR PSU	Alternative DC-48V or AC 120V	1EA
	RDU	Alternative V/UHF RDU or LTEF RDU	1EA
	Power Cable	- MS Connector with 3 hole to AC 120 plug(AC) - MS Connector with 2 lug termination(DC)	Each 1EA
	Comm Cable	- MS Connector which both end sides has 5hole	1EA
	RF cables	- One for interface TX signal with ROU - Another for interface RX signal with ROU	2EA

5.5.2 AOR Power Cabling

AOR supports both of DC-48V and AC120V of input power. As PSU for DC-48 and PSU for AC120V are separated from each other, you need to select one of them in case of purchase order.

RPSU for DC -48V and RSPU for AC 120V have the same configuration and capacity while each of the units uses different input voltage from each other.

The following figure shows configuration of PSUs for DC -48V and AC 120V.



MC Connector numbering	Lug Naming		AOR PSU Terminal naming		Remark
	AC	DC	AC	DC	
A	AC_H	-48V	AC-H	-48V	
B	AC_N	GND	AC-N	IN_GND	
C	GND	DC NC	FG	FG	

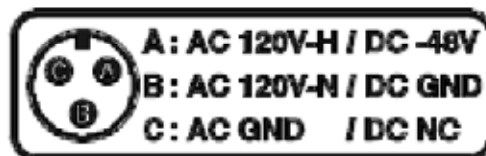

Check if the connection is the same as one seen in the table above and make sure before turn





the power ON. If you want to turn on the power of AOR, move PSU's circuit break switch to "I" status

Check if the POWER LED indicator on the AOR PSU is green lights status

Information of LED at the front RDU

When power of AOR is turned on, LED of the PSU front panel shows the following information:



LED		Description
ON		Power is not supplied
		Power is supplied.
ALM		Normal Operation
		Abnormal Operation

5.5.3 GND Terminal Connection

AOR has one GND terminal port where is on rear side, like below

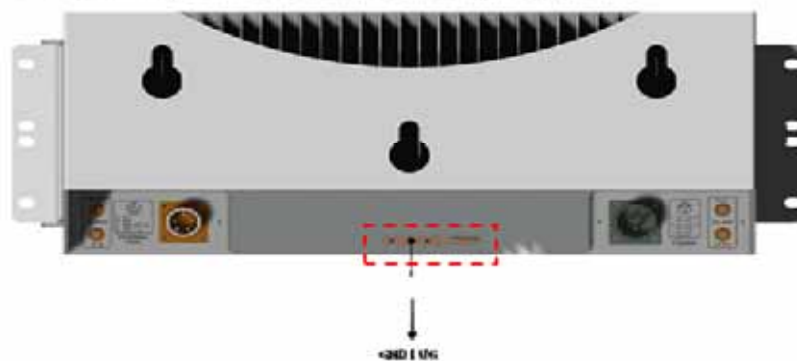

- Take off the GND terminal port from enclosure and connect to ground cable, then fix it the position of enclosure again
- The opposite end of the ground cable should connect to the communication GND of building
- The ground lug is designed meeting the SQ22 standard

5.5.4 Coaxial cable and Antenna Connection

- AOR has two antenna port, the one is TX antenna and the others is RX antenna
- The coaxial cables which are connected to antenna distributed network connect to two antenna port of AOR. Before connection, check the VSWR value of coaxial cable whether it is within specification using SITEMASTER .
- At this time, check if the Return loss have above 15Db or VSWR have below 1.5
- The part of antenna connection fasten to port not to be loosed and not to be injected the dusty and insects
- The antenna connected to AOR is only serviced in inbuilding

5.5.5 Consumption Power of AOR

The following table shows power consumptions of AOR:

Part	Unit	Consumption Power		Remark
AOR	RDU VHF+UHF (E_VHF+UHF)	VHF	47W	VHF HPA OFF
		UHF	47W	UHF HPA OFF
		FULL	74W	Both HPA ON
	RDU 700LTEF	SISO	32W	
		MIMO	50W	SISO & MIMO HPA ON

5.5.6 Interface with existing ROU

AOR is not operated by themselves. TX/ RX signals receive/transmite through RF port terminal of existing ROU. Also for communication with existing ROU, should connect cable on external port of each other. The following shows the connection diagram with existing ROU:

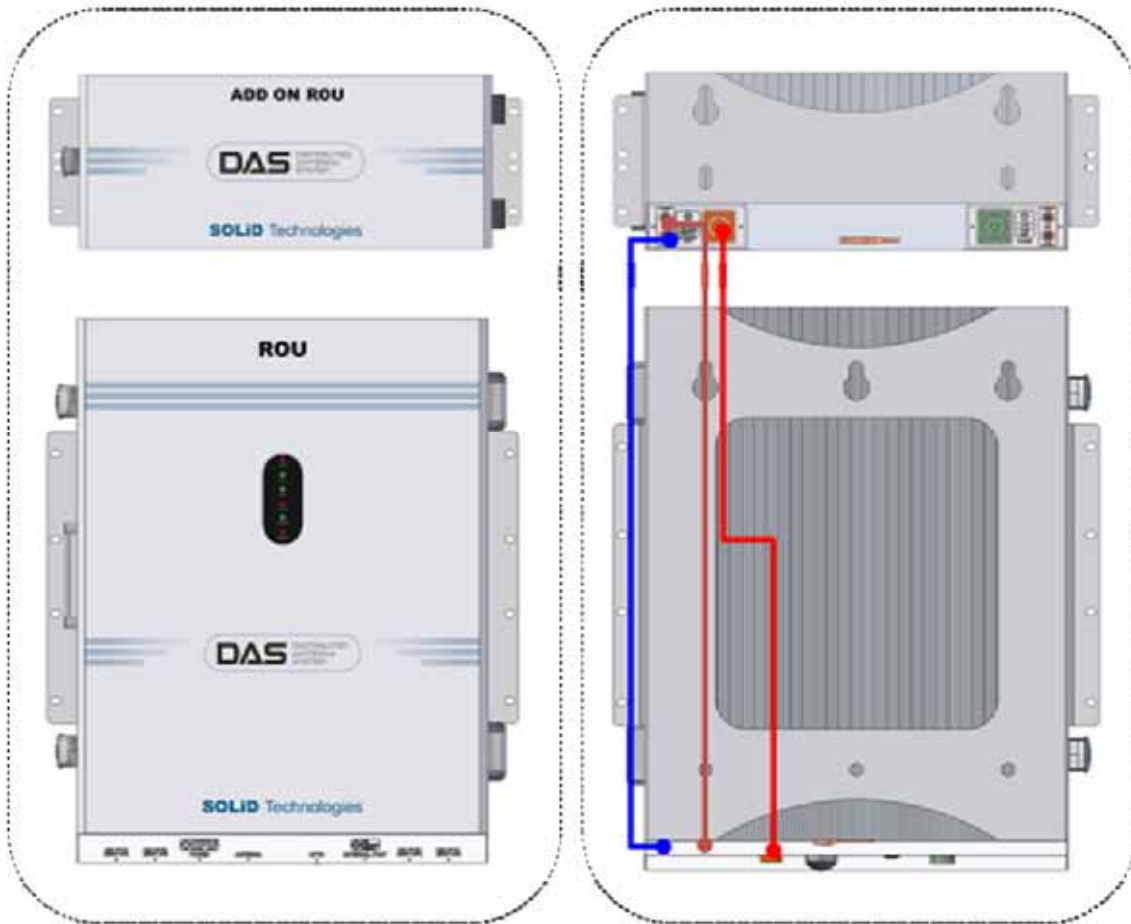

Figure 5.10 – AOR which is installed above of ROU

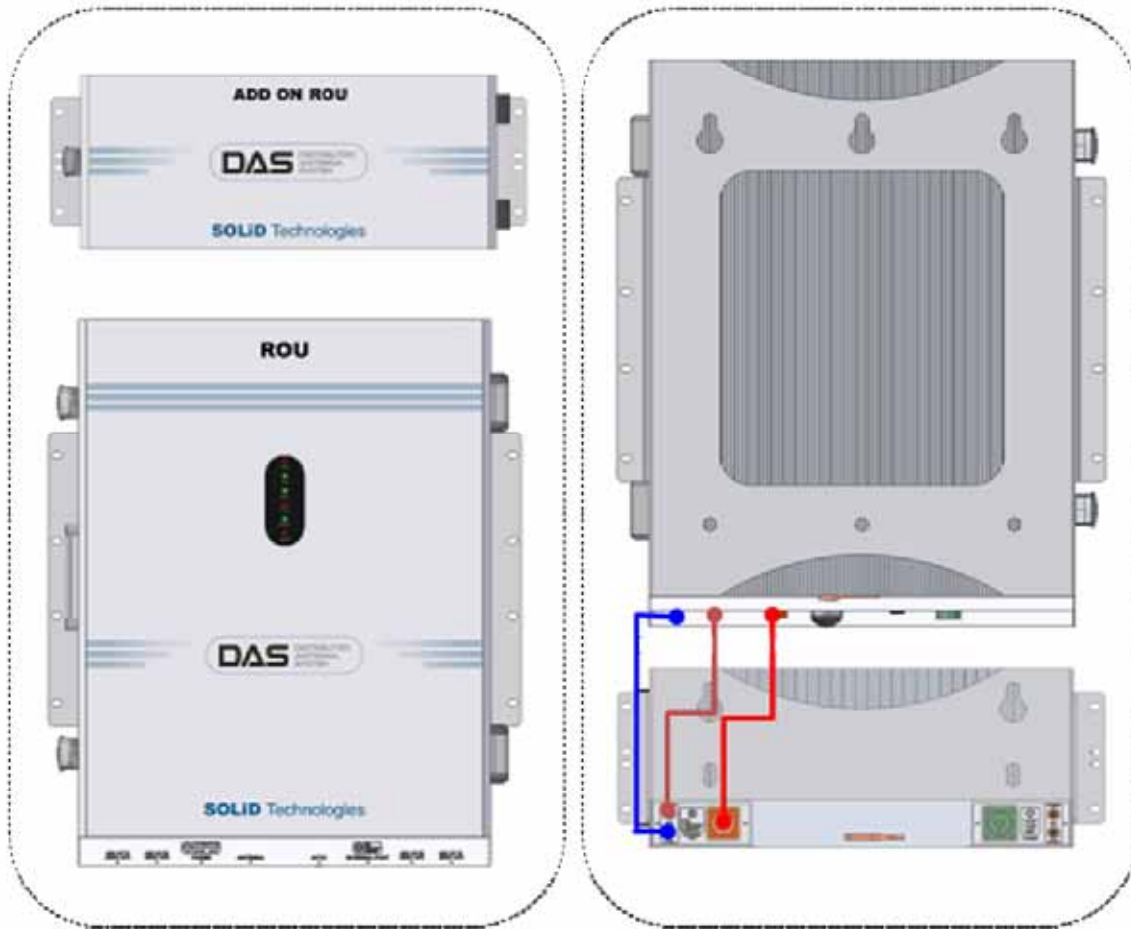

Figure 5.11 – AOR which is installed under of ROU

For connecting with existing ROU, need three sorts of cables

The following shows the interface point between existing ROU and AOR:

Items	Interface Point		Remark
	Existing ROU Port	AOR Port	
TX RF Cable	ADD ON TX (MIMO ANT)	TO ROU	TX IN SMA
RX RF Cable	ADD ON RX (MIMO ANT)		RX OUT SMA
Communication signal Cable	EXTERNAL PORT	EXTERNAL PORT	MS-CON

Section 6

Operation

-
- 6.1 BIU Operation**
 - 6.2 ROU Operation**

This chapter describes operation of SMDR-NH124. It deals with procedures and operations for

normal system operation after installation. It also describes operations per unit and interworking methods.

6.1 BIU Operation

6.1.1 BIU

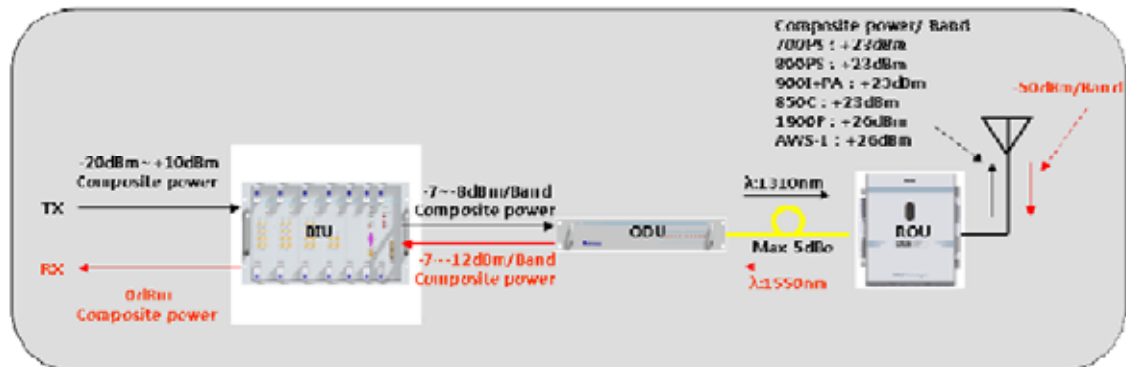

6.1.2 TX Operation at BIU

TX level to be sent to BIU should be in the range of -20dBm ~ + 10dBm. If the level exceeds the range, you need to connect an attenuator with the front end of BIU input and adjust the level in the corresponding range. Out of the range, maximal power cannot be outputted and so you need to increase output power of BDA or adjust attenuation amount of BTS's coupler or ATT to adjust the level.

For signals of all bands, you need to check, using spectrum, if they are in an appropriate level before making connection with input port of BIU and then check if there are spurious signals.

You need MDBU of a band you want to use. Insert the unit into BIU and check if it works normally. For MDBU, up to two TX inputs are provided. Input level per port is -20dBm~+10dBm. The following describe settings for 800MHz Public safety MDBU.

Checking the status of the system's LED Indicator

After turning on the switch of the power supply in BIU, check information on each module's LED of the system. The table below shows normal/abnormal cases depending on the status of each module's LED.

LED information

Unit	LED	Indicates
MDBU	ON	● Green: MDBU is normally power-supplied.
	ALM	● Green: MDBU is normal.
		● Red: MDBU is abnormal; check the alarm through RS-232C.
MCPU	ON	● Green: MCPU is normally power-supplied.
	TXD	● Green flicker: TX signals are transmitted to communicate with ROU.
	RXD	● Green flicker: RX signals are received from ROU.
	ALM	● Green: BIU system is normal.
● Red: BIU system is abnormal; check the alarm through RS-232C.		
MPSU	ON	● Green: BIU is connected with power and MPSU works normally.
	ALM	● Green: DC output is normal.
		● Red: DC output is abnormal.

MDBU Setting

Insert MDBU into BIU. Check if the "ON" LED Indicator at the front panel of MDBU is lit green. Make connection with DEBUG port of MCPU through RS-232 Cable (Direct Cable). Check if the ID of MDBU module is searched for in those 1~4 slots of MDBU through GUI. When you select the tab of a corresponding slot (MDBU 1~4) from the main window, you can inquire and set the status of a corresponding MDBU module.



Check if MDBU is inserted into a corresponding slot of BIU. The ID screen shows the following:

- A. MDBU ID: 800Public Safety, 800PS+900I+Paging, 850C, 700PS+850C, AWS-1,1900P

- B. Not Insert: This status value appears when MDBU has not been set.
- C. Link Fail: This status value appears when MDBU has been set but it fails to communicate with modules.

Use the ON/OFF (Activation/de-activation) function for a port you want to use and turn it ON.



Depnding on whether to use a port, output varies. Thus, make sure to turn OFF unused ports.

The table below shows output power depnding on whether to use a port:

MDBU Band	Output level (Composite power)	No. of Max port (N)
700PS	23dBm-10*LOG(N)	2
700LTEC	23dBm-10*LOG(N)	2
700LTEF	23dBm-10*LOG(N)	2
800PS	23dBm-10*LOG(N)	2
850Cellular	23dBm-10*LOG(N)	2
900I+Paging	23dBm-10*LOG(N)	2
1900PCS	26dBm-10*LOG(N)	4
AWS-1	26dBm-10*LOG(N)	4
VHF	24dBm-10*LOG(N)	1
UHF	24dBm-10*LOG(N)	1

Check if the level of TX IN POWER is the same as the value measured through spectrum (Within ± 3 dB). Use TX IN AGC function and automatically set internal ATT depending on input level. ATT is automatically set based on -20dBm of input . The table below shows TX IN ATT depending on TX IN POWER. For manual setting, you can set ATT depending on input according to the table.

TX IN POWER	TX IN ATT	TX IN POWER	TX IN ATT	TX IN POWER	TX IN ATT
-------------	-----------	-------------	-----------	-------------	-----------

-20dBm	0dB	-9dBm	11dB	+1dBm	21dB
-19dBm	1dB	-8dBm	12dB	+2dBm	22dB
-18dBm	2dB	-7dBm	13dB	+3dBm	23dB
-17dBm	3dB	-6dBm	14dB	+4dBm	24dB
-16dBm	4dB	-5dBm	15dB	+5dBm	25dB
-15dBm	5dB	-4dBm	16dB	+6dBm	26dB
-14dBm	6dB	-3dBm	17dB	+7dBm	27dB
-13dBm	7dB	-2dBm	18dB	+8dBm	28dB
-12dBm	8dB	-1dBm	19dB	+9dBm	29dB
-11dBm	9dB	0dBm	20dB	+10dBm	30dB
-10dBm	10dB				

Edit Naming of a port and set it as a desired character string (up to 12 characters). For example, the figure below shows a screen when you set "SPRINT" for port 1 and "T-MOBILE" for port 2.

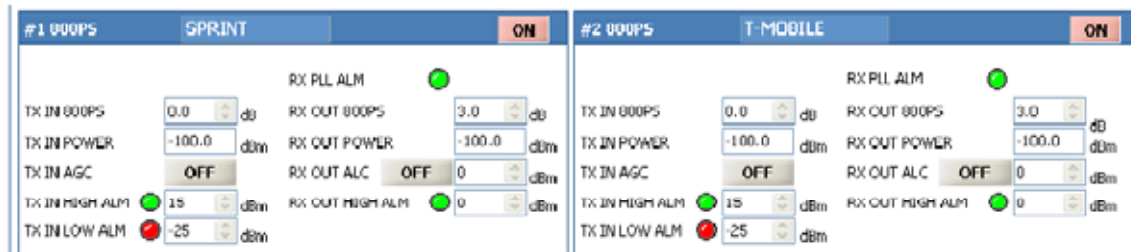

Use various upper/lower limits. The following table shows recommended limit settings:

Item	Recommended Limit	Remark
TX IN HIGH ALM	15dBm	Alarm
TX IN LOW ALM	-25dBm	Alarm
RX OUT ALC	0dBm	Auto Level control
RX OUT HIGH ALM	5dBm	Alarm

As such, when you finish setting normal input levels and alarm limits, check if the value of MODULE FAILUER LED Indicator is lit green (Normal case).

6.1.3 RX Operation at BIU

For RX operation at BIU, you need to set RX gain to prevent BTS or BDA from being affected. There is an ATT setting window to let you adjust gain per band and port.

Total RX gain is 50dB. To adjust a desired gain, you need to do the following. For RX gain of a desired gain, you can set it as 50dB-RX ATT. Use the terminal and check if TX Adjust value and Ec/Io value is appropriate.

To block high signals from entering BTS or BDA, keep ALC mode activated (ON).

6.1.4 Setting whether to use ROU/OEU at BIU

BIU controls overall system, working as common part in any equipment. Connect BIU with such units as ODU, OEU and ROU to be interfaced with the BIU and manually set whether to use the units at the INSTALL window of BIU.

To inquire and set information on units in lower level (OEU and ROU) at BIU, you need to check on a corresponding item at INSTALL Menu for a unit to be actually used. This setting makes BIU actually try to communicate with lower units while collecting the status value of units.

The menu below shows INSTALL menu, where you can see topology for overall units at a glance.

Overall topology for SMDR-NH124 Configuration of BIU-ODU-ROU

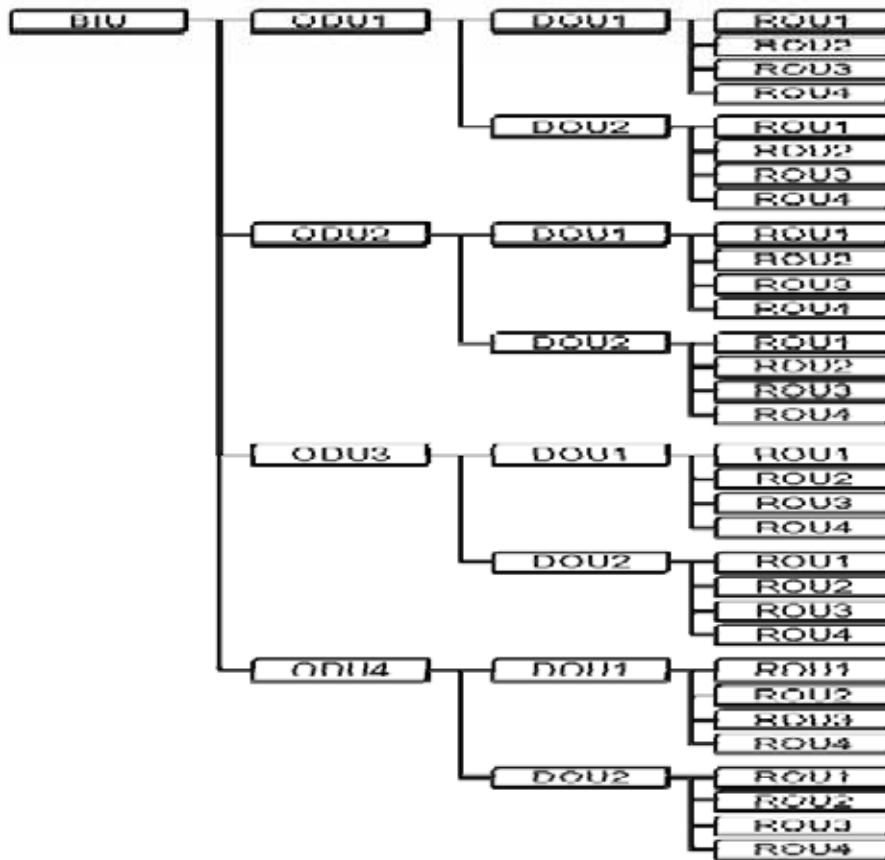

Configuration on whether to use BIU varies depending on the topology above and so you need to check on a unit to be installed.

Ex.) How to set INSTALL menu when ROU is connected with DOU1 of ODU1, which is connected with BIU:

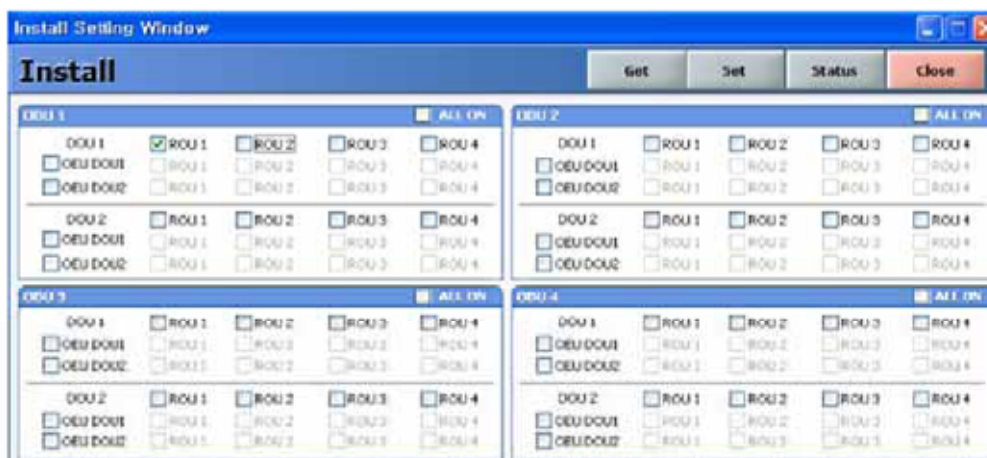

1. Select INSTALL from GUI menu.

2. Check on ODU1 menu>DOU1>ROU1.
3. Close the INSTALL menu.
4. Check if ROU is created, which was checked on at the left TREE panel.

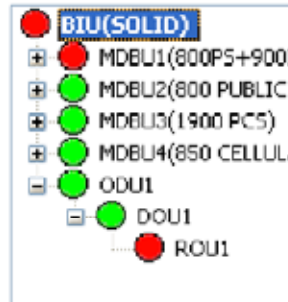

6.1.5 ODU Operation at BIU

BIU can be equipped with up to four ODUs. One ODU can hold two DOUs in it. For information on insertion/deletion of DOU in ODU, you can see at the main window of BIU.

ODU Insert Information		
	DOU#1	DOU#2
ODU#1	<input checked="" type="checkbox"/>	<input type="checkbox"/>
ODU#2	<input type="checkbox"/>	<input type="checkbox"/>
ODU#3	<input type="checkbox"/>	<input type="checkbox"/>
ODU#4	<input type="checkbox"/>	<input type="checkbox"/>

When you select ODU screen from the left TREE panel, you can see DOU1 or DOU2 menu activated depending on whether DOU has been inserted. Then, the optical port set at the INSTALL menu is also activated to let you check PD value of the optical port. Any optical port not set at the INSTALL menu is seen de-activated in grey.

ODU1
Set Mode Close

DOU 1

Reset

Optic Over Pow ●

LD POWER ● 4.0 dBm

OPTIC PORT 1

PD POWER ● 1.7 dBm

RX OPTIC ATT 2.0 dB

RX OPTIC COMP **OFF**

RESULT Success

OPTIC PORT 2

PD POWER ● -10.0 dBm

RX OPTIC ATT 2.0 dB

RX OPTIC COMP **OFF**

RESULT Success

OPTIC PORT 3

PD POWER ● -10.0 dBm

RX OPTIC ATT 12.0 dB

RX OPTIC COMP **OFF**

RESULT Success

OPTIC PORT 4

PD POWER ● -10.0 dBm

RX OPTIC ATT 12.0 dB

RX OPTIC COMP **OFF**

RESULT Success

DOU 2

Reset

Optic Over Pow ●

LD POWER ● 0.0 dBm

OPTIC PORT 1

PD POWER ● 0.0 dBm

RX OPTIC ATT 0.0 dB

RX OPTIC COMP **OFF**

RESULT Success

OPTIC PORT 2

PD POWER ● 0.0 dBm

RX OPTIC ATT 0.0 dB

RX OPTIC COMP **OFF**

RESULT Success

OPTIC PORT 3

PD POWER ● 0.0 dBm

RX OPTIC ATT 0.0 dB

RX OPTIC COMP **OFF**

RESULT Success

OPTIC PORT 4

PD POWER ● 0.0 dBm

RX OPTIC ATT 0.0 dB

RX OPTIC COMP **OFF**

RESULT Success

The level of Laser diode received from ROU/OEU is $+7\text{dBm} \pm 0.5\text{dB}$. The level of Photo diode will be displayed with losses related to the length of optical cables and insertion loss of optical connectors.

In general, the level of optical PD POWER should be $+6\text{dBm} \sim +2\text{dBm} \pm 1.5\text{dB}$.

What is more, ODU has the function of automatically compensating for optical cables. The following procedure is related to how to make optical compensation with ROU connected with port, at a corresponding DOU window of ODU:

1. Check if ODU is smoothly communicating with a corresponding ROU.
2. Select ODU or DOU from the left Tree panel.
3. Set "RX OPTIC COMP" of the optical port of a corresponding DOU as "ON."
4. During optical compensation, the Result window shows "Processing" and then a result value. There are three types of results as follows:
 - A. Success: The optical compensation is normally made.
 - B. Over Optic Loss: Generated optical loss is 5dB or more.
 - C. Communication Fail: Communication with ROU is in poor condition.
5. ATT of optical compensation can work based on the numerical expression of $12-2^*(\text{LD})$

POWER-PD POWER).

6. Optical compensation can be made not only in ODU but also in ROU.

6.2 ROU Operation

The figure below shows the level of the system link of SMDR-NH124 (BIU-ODU-ROU). This section describes ROU-related information. ROU receives various signals through optical modules. The signals are filtered only for corresponding signal band from a corresponding RDU module and amplified with a High Power Amplifier. Then, the multiplexer combines the signals with others and sends them with an antenna.

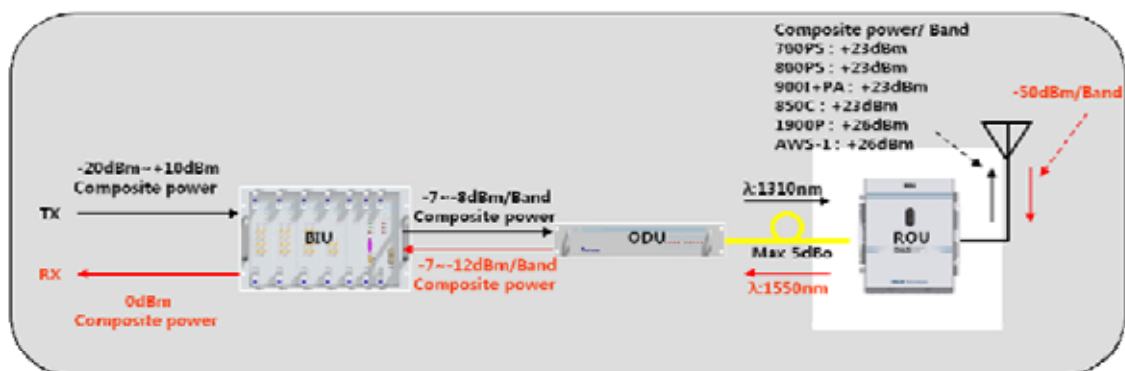

6.2.1 ROU Operation

ROU is in one-body enclosure type. ROU is located at a remote closet in a building. And it can be installed on a wall or into a rack.

Basically, one antenna is provided. To install a variety of antennas, you need such devices as a divider and a coupler. ROU can work with a DC Feeder and an Optic Cable Feeder. For power supply of ROU, a power supply in AC-DC and DC-DC type is provided to let you select a power supply suitable for an application.















For upper level, ROU can be connected with ODU and OEU. It has AGC function for 5dB_o of optical cable loss.

The following show operational procedures after installation of ROU.

Checking the status of ROU's LED Indicator

After turning on the switch of the power supply in ROU, check information on each

module's LED of the system. The table below shows normal/abnormal cases depending on the status of each module's LED.

Unit	LED		Indicates
RCPU	ON		Green: ROU is normally power-supplied.
	LD		Green: Laser Diode is normal.
			Red: Laser Diode is abnormal.
	PD		Green: Photo Diode is normal.
			Red: Photo Diode is abnormal; check optical cables.
	TXD		Green flicker: TX signals are transmitted to communicate with BIU/OEU.
	RXD		Green flicker: RX signals are received from BIU/OEU.
	ALM		Green: ROU system is normal.
		Red: ROU system is abnormal; check the alarm through RS-232C.	
RDU	ON		The power is not supplied.
			The power is supplied.
	ALM		Normal Operation
			Abnormal Operation
RPSU	ON		The power is not supplied or the polarity of -48V is reversed.
			The power is supplied.

ID Setting

Use an RS-232 Cable(Direct Cable) for connection with DEBUG port of ROU RCPUs. Execute GUI (Graphic User Interface). When you connect ROU directly with a Serial port, the screen will show the TREE of a direct line of units connected with ROU. Basic ROU ID is set as ODU1-DOU1-ROU1. Set it with the ID of a designed ROU. Before setting an ROU ID, you need to check if ROU is connected with the optical port of ODU or OEU (See System Topology at "Setting whether to use BIU").

ID



If multiple ROUs connected to BIU share the same ID, the screen will fail to read status information on the ROUs with the same IDs. Therefore, make sure not to redundantly set ROU ID.

Checking Communication LED of RCPU

Check if TXD and RXD LEDs in RCPU make communication. Receiving FSK signals from BIU, ROU sends requested status value to BIU. During reception, RXD LED flicks. During transmission, on the other hand, TXD LED flicks. At this time, you need to check if whether to use a corresponding ROU is checked on (See "whether to use BIU OEU/ROU").

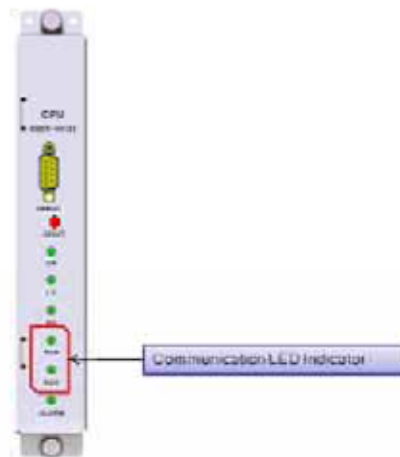

ROU Optic Comp Operation

ROU has the function of automatically compensating for optical loss. It can do the work for up to 5dB_o of optical loss. Set "TX OPTIC COMP" of ROU as "ON." Optical compensation of ROU can not be made without communication with such units in upper level as ODU or OEU. For 1dB_o of optical loss, basic TX OPTIC ATT is 12dB; for 5dB_o of optical loss, TX OPTIC ATT is 4dB. OPTIC COMP works only one time before it stays dormant.

The figure below shows a screen for OPTIC Information in ROU GUI.

LD POWER means output level of ROU Laser Diode, which is sent to a upper unit by ROU. PD POWER means input level of Photo Diode to be received from a upper unit.

OPTIC Information

LD POWER ● dBm

PD POWER ● dBm

TX OPTIC ATT dB

TX OPTIC COMP

RESULT

During optical compensation, the Result window shows "Processing" and then a result value. There are three types of results as follows:

1. Success: The optical compensation is normally made.
2. Over Optic Loss: Generated optical loss is 5dBo or more.
3. Communication Fail: Communication with ROU is in poor condition.



If ROU does not make optical compensation, there will be errors in the budget of system link. It can cause lower output level or make Spurious Emission not satisfying for a standard.

RDU Setting

Insert an RDU+BPF assembly you want to offer service with it and then connect the Multiplexer with interface cable (See Sector 5: How to install RDU at the INSTALL part).

Through GUI, check if the ID of RDU module is inquired at LEFT, MIDDLE and RIGHT slots of RDU. When you select the tab of a corresponding slot (LEFT, MIDDLE and RIGHT) from the main window of ROU, you can inquire and set the status of a corresponding RDU module.

MIDDLE RDU	AWS-1+1900P
LEFT RDU	850C+700PS
RIGHT RDU	800+900I+PA

Set HPA of a corresponding RDU as "ON." Use TX OUTPUT AGS function and set it as a desired output level.

800PS
ON

TX PLL ALM ●		RX PLL ALM ●	
TX OUTPUT ATT	<input type="text" value="12.0"/> dB	RX INPUT ATT	<input type="text" value="0.0"/> dB
TX OUTPUT POWER	<input type="text" value="-100.0"/> dBm	RX INPUT POWER	<input type="text" value="-100.0"/> dBm
TX HPA ON/OFF	<input type="button" value="OFF"/>	RX INPUT ALC	<input type="button" value="OFF"/> <input type="text" value="-48"/> dBm
TX OUTPUT HIGH ALM ●	<input type="text" value="30"/> dBm		
TX OUTPUT LOW ALM ●	<input type="text" value="-111"/> dBm		
TX OUTPUT AGS	<input type="button" value="OFF"/> <input type="text" value="1"/> dBm		
RESULT	<input type="text" value="Success"/>		
TX OUTPUT ALC	<input type="button" value="OFF"/> <input type="text" value="25"/> dBm		
TX OUTPUT SD ●	<input type="button" value="OFF"/> <input type="text" value="-110"/> dBm		

The table below shows maximally available Composite Powerlevels that can be set per band:

RDU Band	Power that can be maximally set	Setting range
700PS	23dBm	0 ~ 23dBm
700LTEC	23dBm	0 ~ 23dBm
700LTEF	23dBm	0 ~ 23dBm
800PS	23dBm	0 ~ 23dBm
850Cellular	23dBm	0 ~ 23dBm
900I+Paging	23dBm	0 ~ 23dBm
1900PCS	26dBm	0 ~ 26dBm
AWS-1	26dBm	0 ~ 26dBm
VHF	24dBm	0~24dBm
UHF	24dBm	0~24dBm

AGS function enables you to adjust output power as you like. While the AGS function is being executed, the Result window shows "Processing" and then a result value. There are three types of results as follows:

- A. Success: The AGS function is normally made.
- B. Not Operate OPTIC Comp: Optic Comp is not executed.
- C. Lack of ATT: There is no attenuation available.

Use various upper/lower limits. The following table shows recommended limit settings:

Item	Recommended Limit	Remark
TX OUTPUT HIGH ALM	Max Composite Power+1dB	Alarm
TX OUTPUT LOW ALM	0dBm	Alarm

TX OUTPUT ALC	Max Composit Power	Auto Level control
TX OUTPUT SD	Max Composit Power+2dB	Shutdown
RX ALC	-45dBm	

If TX OUTPUT HIGH ALM is higher than a setting value, alarms will be genrated.

If TX OUTPUT LOW ALM is lower than a setting value, alarms will be genrated. TX OUTPUT HIGH ALM/LOW ALM tends to work only as warning.

When you activate ("ON") TX OUTPUT ALC, outputs will be restricted depending on a setting output value.

When you activate ("ON") TX OUTPUT SD, output will be turned OFF once output power level reaches the same as SD setting value. Upon SD operation, check output level after 10 minutes and then check the status again.

When you activate ("ON") RX ALC, inputs will be restricted depending on a setting value.

As described above, when normal output level and alarm limit values are set, you need to check if the value of MODULE FAILUER LED Indicator is normally seen green.

For unused bands, you need to use band turning-ON/-OFF function to turn them off. Once a RDU band is turned off, its status value will not be used in case of alarms.

6.3 OEU Operation

The figure below shows the level of the system link of SMDR-NH124 (BIU-ODU-OEU-ROU). This section describes OEU-related information. OEU receives various signals through optical modules. The optical signals are converted to RF signal and the RF signal also is amplified to moderate signal level. To transmit to ROU, the signal is converted to optical signal

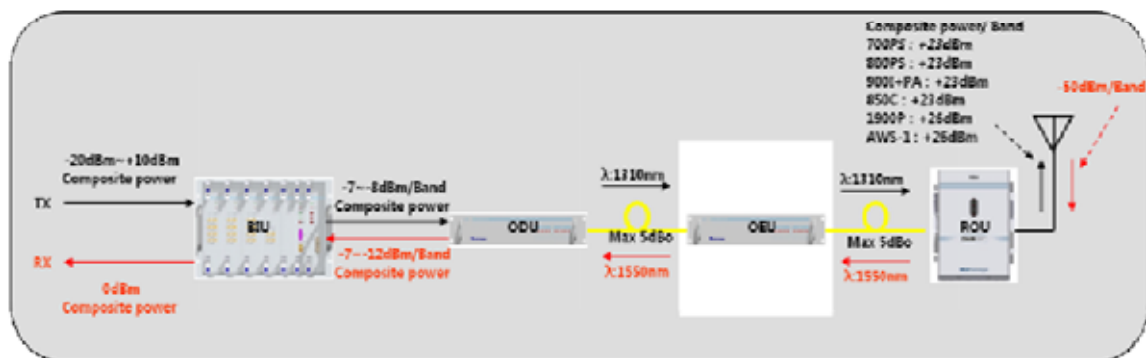

6.3.1 OEU Operation

OEU is in shelf enclosure type. OEU is located at a remote closet in a building. And it can be installed into a rack.









OEU is for role as hub. It is to expand toward campus cluster, it is only one optical cable to expand 8ROU. This is reason why OEU supports up to 2DOU. The DOU supports up to 4optical port to connect ROU

ROU can work with a DC Feeder and an Optic Cable Feeder. For power supply of OEU, a power supply in DC-DC type is provided

For upper level, OEU can be connected with ODU. It has AGC function for 5dB_o of optical cable loss. The following show operational procedures after installation of OEU.

Checking the status of OEU's LED Indicator

After turning on the switch of the power supply in OEU, check information on each module's LED of the system. The table below shows normal/abnormal cases depending on the status of each module's LED.

Unit	LED	Indicates
EWDM	LD	 Green : Laser Diode normal status
		 Red :Laser Diode abnormal status
	PD	 Green : Photo Diode normal status
		 Red : Photo Diode abnormal status, input optic power low alarm
DOU1,2	LD	 Green : Laser Diode normal status
		 Red :Laser Diode abnormal status
	PD1	 Green : Photo Diode(PD) of optic port1 is normal
		 Red : PD of optic port1 is abnormal or input optic power low
	PD2	 Green : Photo Diode(PD) of optic port2 is normal

System	PD3	●	Red : PD of optic port2 is abnormal or input optic power low
		●	Green : Photo Diode(PD) of optic port3 is normal
	PD4	●	Red : PD of optic port3 is abnormal or input optic power low
		●	Green : Photo Diode(PD) of optic port4 is normal
	ALM	●	Green : Power on
		●	Red : PD of optic port4 is abnormal or input optic power low
System	ON	●	Green : Power on
	TXD1	●	Green flicker : ECPU send NMS Tx data to BIU
	RXD1	●	Green flicker : ECPU receive NMS Rx data from BIU
	TXD2	●	Green flicker : ECPU send NMS Tx data to ROU
	RXD2	●	Green flicker : ECPU receive NMS Rx data from ROU
	ALM	●	Green : OEU system normal (no alarm)
		●	Red :OEU system abnormal (alarm)

ID Setting

Use an RS-232 Cable(Direct Cable) for connection with DEBUG port of OEU. Execute GUI (Graphic User Interface). When you connect OEU directly with a Serial port, the screen will show the TREE of a direct line of units connected with OEU. Basic OEU ID is set as ODU1-DOU1. Set it with the ID of a designed OEU. Before setting an OEU ID, you need to check if ROU is connected with the optical port of ODU

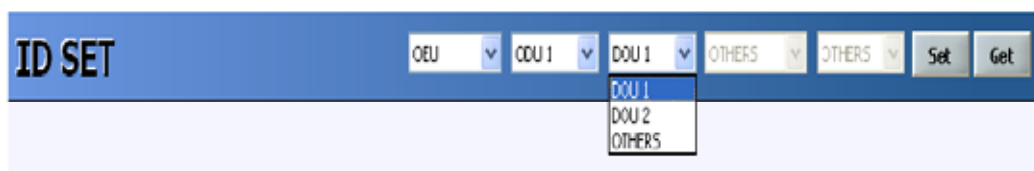
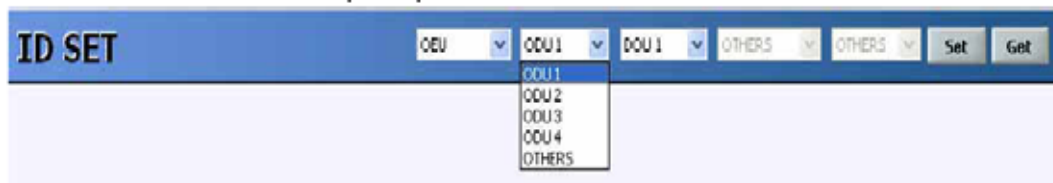

The sort of OEU ID

The sort of OEU ID is as below

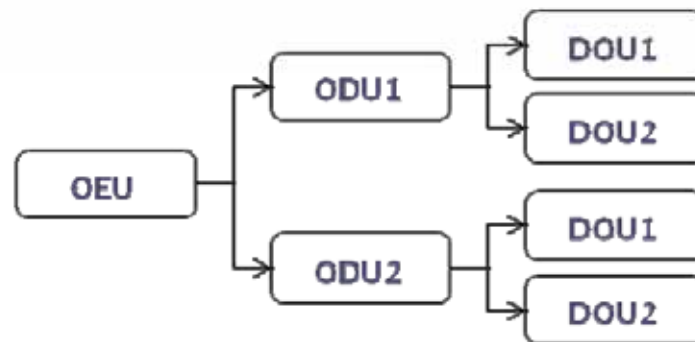

OEU is connected only to 4th optical port of DOU1/2 in the ODU1/2
 Therefore, it need to assign upper unit connected to ODU#-DOU#



If multiple OEUs connected to BIU share the same ID, the screen will fail to read status information on the OEUs with the same IDs. Therefore, make sure not to redundantly set OEU ID.

Checking Communication LED of OEU

Step1 : checking whether communicate with BIU(ODU)

Check if TXD1 and RXD2 LEDs in OEU front LED make communication. Receiving FSK signals from BIU, OEU sends requested status value to BIU. During reception, RXD1 LED flicks. During transmission, on the other hand, TXD1 LED flicks. At this time, you need to check if whether to use a corresponding OEU is checked on (See "whether to use BIU OEU/ROU").

Step2 : Checking whether communicate with ROU

OEU do as Hub. OEU has two optical port. One is connected to ODU and the others is connected to ROU. Communication with ODU is checked at above step1

Step2 is checking stage whether OEU communicate with ROU. OEU request status to ROU and then TXD2 is flicked and if responses data received from ROU RXD2 LED is flicked

OEU Optic Comp Operation

OEU has the function of automatically compensating for optical calbe loss. It can do the work for up to 5dBo of optical loss. Set "TX OPTIC COMP" of OEU's Eoptic as "ON." Optical compensation of OEU can not be made without communication with such units in upper level as ODU. For 1dBo of optical loss, basic TX OPTIC ATT is 12dB; for 5dBo of optical loss, TX OPTIC ATT is 4dB. OPTIC COMP works only one time before it stays dormant.

The figure below shows a screen for OPTIC Information in OEU GUI.

LD POWER means output level of OEU Laser Diode, which is sent to a upper unit by OEU. PD

POWER means input level of Photo Diode to be received from a upper unit.



The screenshot shows a window titled "EOPTIC Information" with the following fields and values:

Parameter	Value	Unit
LD POWER	7.2	dBm
PD POWER	-1.5	dBm
TX OPTIC ATT	4.0	dB
TX OPTIC COMP	OFF	
RESULT	Success	

During optical compensation, the Result window shows "Processing" and then a result value.

There are three types of results as follows:

1. Success: The optical compensation is normally made.
2. Over Optic Loss: Generated optical loss is 5dB_o or more.
3. Communication Fail: Communication with ROU is in poor condition.



If OEU does not make optical compensation, there will be errors in the budget of system link. It can cause lower output level or make Spurious Emission not satisfying for a standard.

Section 7

Additive functions

-
- 7.1 Shutdown function**
 - 7.2 Total power limit function**
 - 7.3 Output power automatic setting function**
 - 7.4 Input power AGC function**
 - 7.5 Input power limit function**
 - 7.6 Optic loss compensation**

This chapter describes additive functions of SMDR-NH124.

7.1 Shutdown function (TX output shutdown)

The DAS has an automatic shutdown function to protect the DAS itself and the wireless network when the normal operational conditions cannot be maintained

The DAS shut down automatically when the composite power downlink output power is above the values defined as average for the device for a period not to exceed 5seconds. Criterion level is set through GUI

After automatic shutdown, the DAS may automatically turn-on in order to assess whether the temporary condition has changed. If the condition is still detected, the DAS shall shutdown again. These actions will be repeated 5 times

After 5time repetition, if the condition is still detected, the DAS will be shutdown permanently. The following diagram shows the shutdown logic

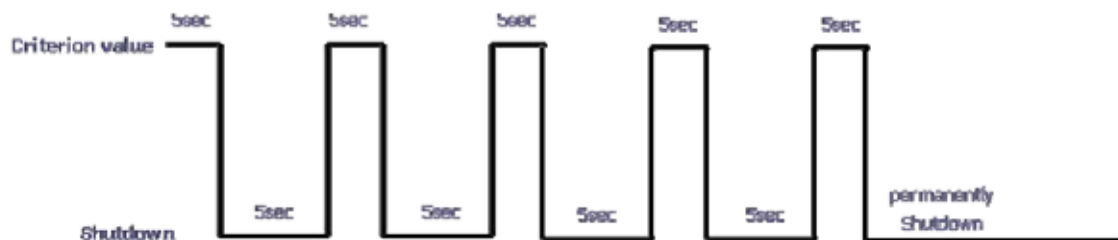

After the retry logic exhausts itself, if the DAS still detected a fault status then the DAS will shutdown permanently and illuminate the fault via visual fault indicator

Permanent shutdowns of the DAS will also be reported to the NOC through the NMS

7.2 Total Power Limit function (TX Output ALC)

In order to protect HPA and not to radiate spurious emission, output power don't radiate above defined value which operator set in advance. To execute this function, operator should turn-on the ALC function and set limit level through GUI. If the output power exceed above the defined value, output attenuator is adjusted to operate within defined value. The output attenuator's adjustment range is above 25dB. If output power decease, applied ATT by AGC function return to initial ATT

7.3 Output power automatic setting function (TX Output AGC)

To provide convenience of setting output power at initial setup automatically, operator set to wanting output level and turn-on the AGC function and then output power is

automatically set to defined level.

If AGC logic finished, logic operation results show on the result window of GUI. There are three types of results as follows

1. Success: The AGS function is normally completed.
2. Not Operate OPTIC Comp: Optic Comp is not executed.
3. Lack of ATT: There is no attenuation available.

If normal logic don't executed, changed ATT return to initial ATT

Through output AGC function, can be checked whether optic compensation is executed or not

7.4 Input power AGC function (TX Input AGC)

This function is to give convenience to operator when setting initial installation

Without spectrum analyzer, we can know input power value through power display window of GUI. Use TX IN AGC function and automatically set internal ATT depending on input level. ATT is automatically set based on -20dBm of input . The table below shows TX IN ATT depending on TX IN POWER. For manual setting, you can set ATT depending on input according to the table.

TX IN POWER	TX IN ATT	TX IN POWER	TX IN ATT	TX IN POWER	TX IN ATT
-20dBm	0dB	-9dBm	11dB	+ 1dBm	21dB
-19dBm	1dB	-8dBm	12dB	+ 2dBm	22dB
-18dBm	2dB	-7dBm	13dB	+ 3dBm	23dB
-17dBm	3dB	-6dBm	14dB	+ 4dBm	24dB
-16dBm	4dB	-5dBm	15dB	+ 5dBm	25dB
-15dBm	5dB	-4dBm	16dB	+ 6dBm	26dB
-14dBm	6dB	-3dBm	17dB	+ 7dBm	27dB
-13dBm	7dB	-2dBm	18dB	+ 8dBm	28dB
-12dBm	8dB	-1dBm	19dB	+ 9dBm	29dB
-11dBm	9dB	0dBm	20dB	+ 10dBm	30dB
-10dBm	10dB				

7.5 Input power limit function (TX Input ALC)

The DAS has TX input ALC function at the BIU to limit level when input power is increased above level by operated input AGC function

Normally, there are more than two input port in the MDBU of BIU

For example, 850cellular band has two input port to support both VzW and AT&T

Two input power may be different each other. The DAS have input attenuator in first stage of MDBU. Through input AGC function, input ATT is adjusted according to input power. If input power increase, input ATT is adjusted again to limit increased input power. Also, if input power decrease input ATT return to initial ATT

7.6 Optic loss compensation

The DAS has the function of automatically compensating for optical loss. It can do the work for up to 5dBo of optical loss. Set "TX OPTIC COMP" of ROU as "ON." Optical compensation of ROU can not be made without communication with such units in upper level as ODU or OEU. For 1dBo of optical loss, basic TX OPTIC ATT is 12dB; for 5dBo of optical loss, TX OPTIC ATT is 4dB. OPTIC COMP works only one time before it stays dormant.

The figure below shows a screen for OPTIC Information in ROU GUI.

LD POWER means output level of ROU Laser Diode, which is sent to a upper unit by ROU. PD POWER means input level of Photo Diode to be received from a upper unit.

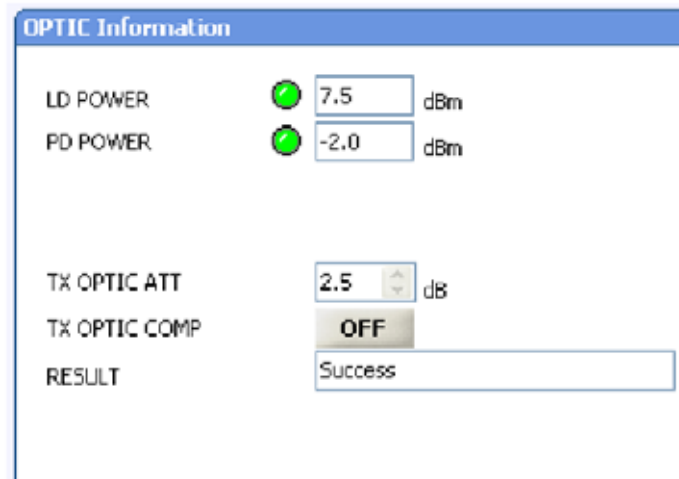

OPTIC Information	
LD POWER	<input type="text" value="7.5"/> dBm
PD POWER	<input type="text" value="-2.0"/> dBm
TX OPTIC ATT	<input type="text" value="2.5"/> dB
TX OPTIC COMP	<input type="button" value="OFF"/>
RESULT	<input type="text" value="Success"/>

During optical compensation, the Result window shows "Processing" and then a result value. There are three types of results as follows:

1. Success: The optical compensation is normally competed
2. Over Optic Loss: Generated optical loss exceed 5dBo or more.
3. Communication Fail: Communication with ROU is under poor condition.