

5.2 ODU Installation

ODU should be, in any case, put on the top of BIU. This unit gets required power and RF signals from BIU. The following table shows components of ODU:

No.	Unit	Description	Remark
Common Part	Shelf	Including Main Board, 19",1U	1EA
	RF Cable	SMA(F) to SMA(F), 400mm	2EA
	Signal Cable	2Row(15P_F) to 2Row(15P_M),650mm	1EA
Optional Part	DOU	Optical Module with 4 Optic Port	Up to 2EA to be inserted

5.2.1 ODU Shelf Installation

ODU is a shelf in around 1U size. Its width is 19" and so this unit should be inserted into a 19" Standard Rack. ODU should be, in any case, put on the top of BIU. BIU should be distant around 1U when the unit is installed.

5.2.2 ODU Power Cabling

ODU does not operate independently. The unit should get power from BIU.

When you connect 2-column, 15-pin D-SUB Signal cable from BIU and install DOU, LED on the front panel is lit. Through this LED, you can check state values of LD and PD of DOU.

5.2.3 ODU Optic Cabling

As optical module shelf, ODU makes electronic-optical conversion of TX signals and then makes optical-electronic conversion of RX signals. ODU can be equipped with up to two DOUs. One DOU supports four optical ports and one optical port can be connected with ROU. Optionally, only optical port 4 can be connected with OEU.

As WDM is installed in DOU, the unit can concurrently send and receive two pieces of wavelength (TX:1310nm, RX:1550nm) through one optical core. DOU has SC/APC of optical adaptor type.



Figure 5.4 – Optical cable of SC/APC Type

For optical adaptor, SC/APC type should be used. To prevent the optical access part from being marred with dirt, it should be covered with a cap during move. When devices are connected through optical cables, you need to clear them using alcohol to remove dirt.

5.2.4 Insert DOU to ODU

In an ODU Shelf, up to two DOUs can be installed. DOU module is in Plug in Play type.

When you insert DOU in ODU, insert the unit into the left DOU1 slot first. You can be careful as the number is silk printed at the left.

The following figure shows installation diagram of ODU with one DOU inserted in it.



The following figure shows installation diagram of ODU with two DOUs inserted in it.



When you insert DOU into ODU, insert the unit into the left DOU1 slot first. Into unused slot, you need to insert BLANK UNIT in any case.

5.2.5 Consumption Power of ODU

ODU gets power from BIU. One ODU can be equipped with up to two DOUs. Depending on how many DOUs are installed, power consumption varies. The table below shows power consumption of ODU:

Part	Unit	Consumption Power	Remark
ODU_4	DOU 1 EA	13W	
ODU_8	DOU 2 EA	26W	

5.3 ROU Installation

5.3.1 ROU Enclosure installation

ROU is designed to be water- and dirt-proof. The unit has the structure of One-Body enclosure. It satisfies water-proof and quake-proof standards equivalent of NEMA4.

ROU can be mounted into either of a 19" Standard Rack or on a Wall.

Basically, ROU has both of a Wall Mount Bracket and a Rack Mount Bracket.

Depending on the use of the Rack Mount Bracket, the bracket can be removed.

The following shows dimension of the fixing point for the Wall Mount Bracket.



Figure 5.5 – How to install ROU

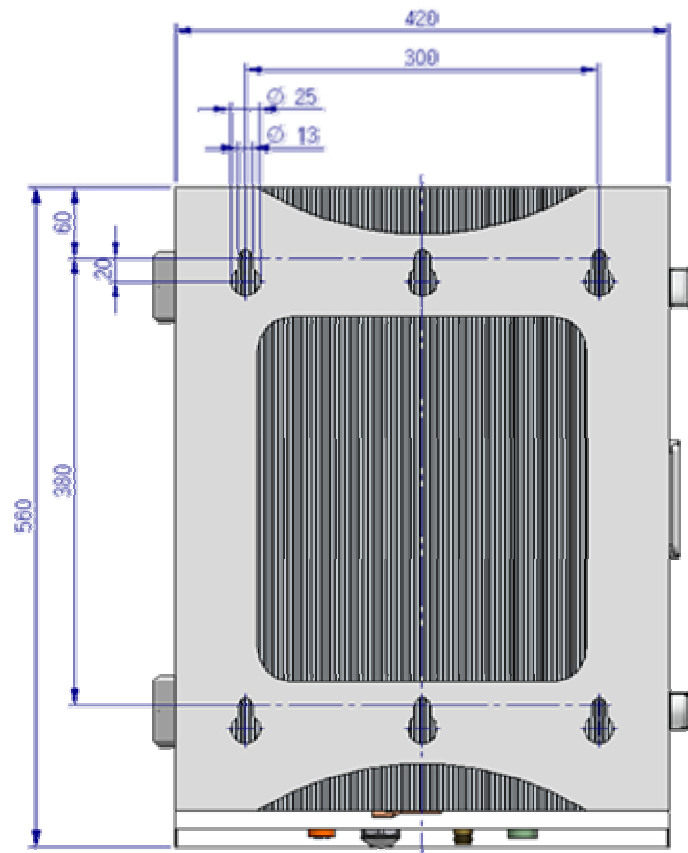

Figure 5.6 – Dimension used to install ROU on the WALL

ROU Wall Mount Installation

Turn M12 Fixing Screws by half on the wall and fully fix the screw with a Wall Mount Bracket on it.

For convenience, the Wall Mount Bracket has fixing holes to let you easily mount an enclosure.

Turn the M5 Wrench Bolt by half at each side of the Heatsink of the enclosure.

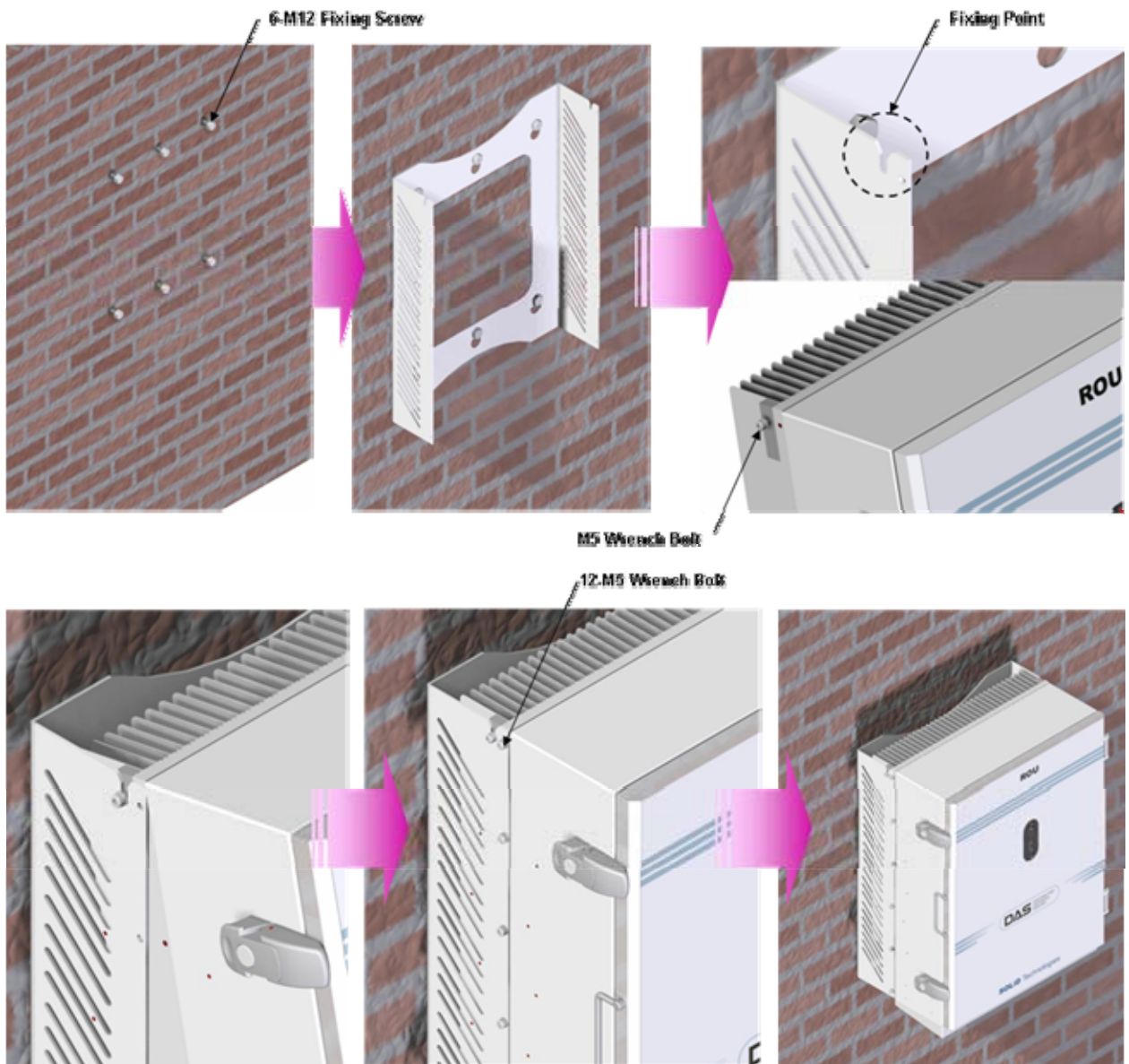

Put the enclosure with the M5 Wrench Bolt fixed on the fixing groove and fix the M5 Wrench Bolts into the remaining fixing holes.

In this case, you will use 12 M5 Wrench Bolts in total except bolts used for the fixing groove.

ROU Rack Mount Installation

Like other units, ROU is designed to be inserted into a rack. The unit occupies around 13U of space except cable connection.

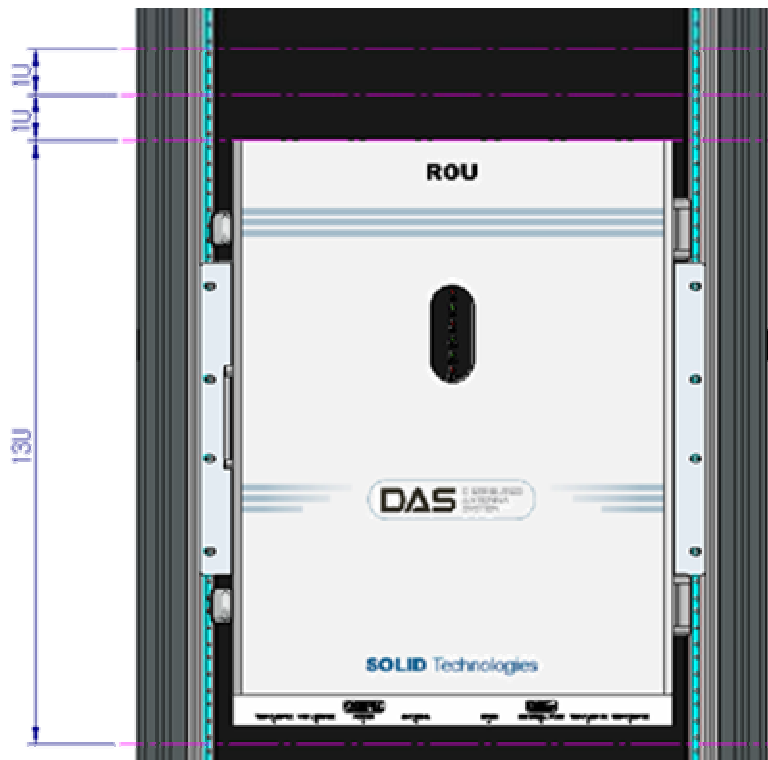

ROU component

ROU has the following components:

No.	Unit	Description	Remark
Common Part	Enclosure	Including Rack & Wall cradle	1EA
	RCPU	-	1EA
	R_OPTIC	With SC/ACP adaptor	1EA
	RPSU	Alternative DC-48V or AC 120V	1EA
	Multi-Plexer	-	1EA
	Power Cable	- MS Connector with 3 hole to AC 120 plug(AC) - MS Connector with 2 lug termination(DC)	
Optional Part	RDU+BPF	800PS,800PS+900I+Paging,850C,850C+700PS, 1900P+ AWS-1 RDU	Up to 3EA to be inserted

Basically, the common part of ROU should have an enclosure and it is equipped with RCPU to inquire and control state of each module, R_OPTIC to make both of electronic-optical and optical-electronic conversions, RPSU to supply power for ROU and a Multi-Plexer to help share multiple TX/RX signals through one antenna. It should have Power Cable for external rectifier or to supply required power.

In addition, RDU can be inserted and removed to provide service for desired band (Optional).

5.3.2 ROU Power Cabling

ROU supports both of DC-48V and AC120V of input power. As RPSU for DC-48 and RPSU for AC120V are separated from each other, you need to select one of them in case of purchase order.

RPSU for DC -48V and RSPU for AC 120V have the same configuration and capacity while each of the units uses different input voltage from each other.

The following figure shows configuration of RPSUs for DC -48V and AC 120V.



MC Connector numbering	Lug Naming		RPSU Terminal naming		Remark
	AC	DC	AC	DC	
A	AC_H	-48V	AC-H	-48V	
B	AC_N	GND	AC-N	IN_GND	
C	GND	DC NC	FG	FG	



Check if the connection is the same as one seen in the table above and make sure to turn the power ON.

5.3.3 Optical Cabling

ROU makes optical-electronic conversion of TX signals from upper ODU and OEU and makes electronic- optical conversion of RX signals. ROU has one optical module in it. As WDM is installed in the R_OPTIC module, two pieces of wavelength (TX:1310nm, RX:1550nm) can be sent/received with one optical core at the same time. ROU has SC/APC of optical adaptor type. For optical adaptor, SC/APC type can be used. To prevent the optical access part from being marred with dirt, it should be covered with a cap during move. When devices are connected through optical cables, you need to clear them using alcohol to remove dirt.

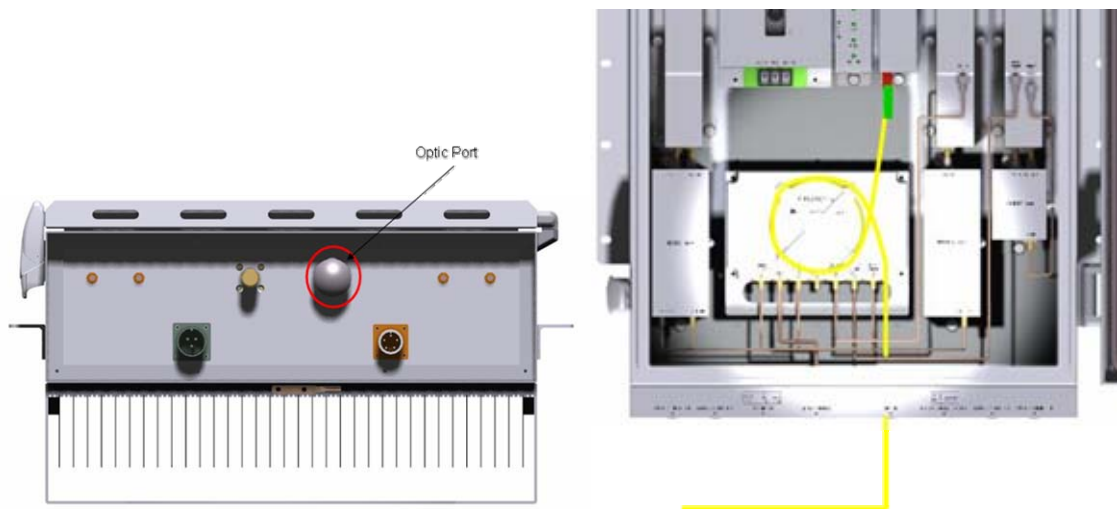

Optical cables should be inserted into Optic Port outside of ROU. Using an optical slack devices in ROU, you need to coil around one or two roll of cables to be connected with the optical adaptor of ROPTIC.

At this time, curvature of the optical cable should be at least 10Ø to prevent insertion loss from being increased.

Through GUI, check if PD value of ROPTIC is in a tolerable range (+4~-1dBm).

5.3.4 Insertion of RDU

ROU has slots to enable up to three RDU modules to be inserted into the unit.

You can insert a RDU into any slot. It is not possible to provide services with a RDU module alone; you need to connect the module with Cavity BPF in any case.

The table below shows types of RDU and CAVITY BPF:

No	Unit naming	Cavity BPF	RF CABLE	Multiplexer Interface	
				TX	RX
1	RDU 800PS	800PS BPF	TX CABLE 1EA RX CABLE 1EA	BPF OUT	RDM RX IN
2	RDU 850C	850C BPF	TX CABLE 1EA RX CABLE 1EA	BPF TX OUT	BPF RX IN
3	RDU 1900P+AWS-1	1900P DUP	TX/RX CABLE 1EA	RDM AWS+1900P	
5	RDU 800PS+900I+PA	800PS+900I+PA BPF	TX CABLE 1EA RX CABLE 1EA	RDM TX OUT	RDM RX IN
6	RDU 850C+700PS	850C+700PS BPF	TX CABLE 1EA RX CABLE 1EA	RDM TX OUT	RDM RX IN

The following describes how to install RDU in ROU.

How to install RDU 800PS Ass'y

The following components are required:

No.	Unit	Description	Remark
1	RDU 800PS	RF Module	
2	800PS BPF	BPF	
3	800PS TX RF CABLE	SMA(M) to SMA(M), 360mm	
4	800PS RX RF CABLE	SMA(M) to SMA(M), 410mm	

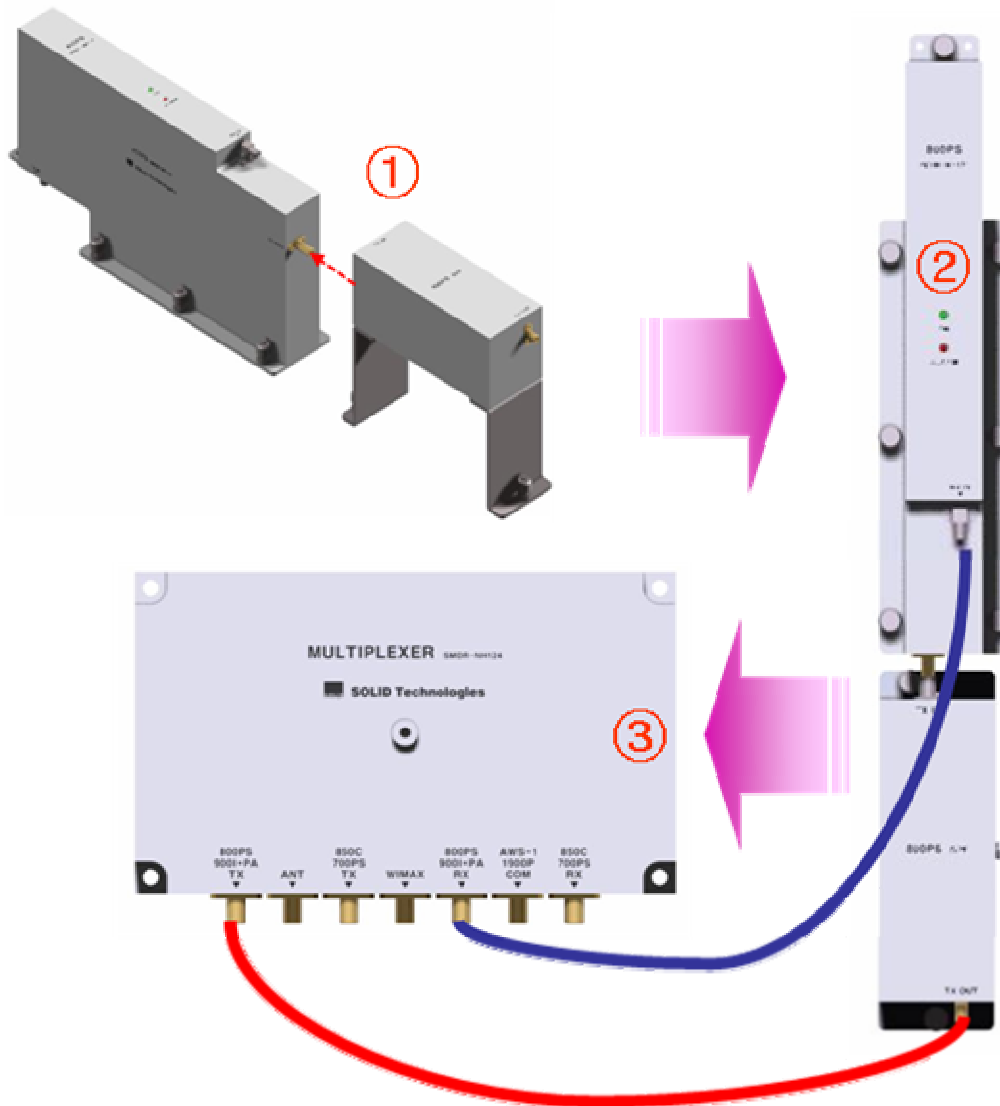

- ① Combine RDU 800PS with 800PS BPF (As it is a plug type, push the unit to combine with BPF.)
- ② Insert the combined 800PS+850C BPF Ass'y into any slot of ROU.
- ③ Combination point of 800PS+800PS BPF Ass'y of the multiplexer

Multiplexer Port naming	Interface Point		Remark
	800PS RDU	800PS BPF	
800PS+900I+PA TX	-	TX OUT	
800PS+900I+PA RX	RX IN	-	

How to RDU install 850C Ass'y

The following components are required:

No.	Unit	Description	Remark
1	RDU 850C	RF Module	
2	850C BPF	BPF	
3	850C TX RF CABLE	SMA(M) to SMA(M), 310mm	
4	850C RX RF CABLE	SMA(M) to SMA(M), 310mm	

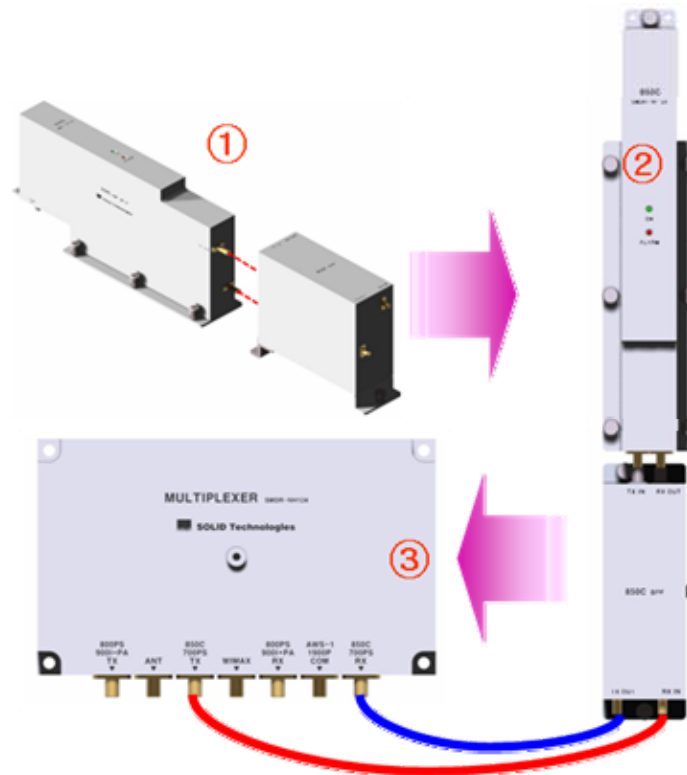

- ① Combine 850C RDU with 850C BPF (As it is a plug type, push the unit to combine with BPF.)
- ② Insert the combined 850C+850C BPF Ass'y into any slot of ROU.
- ③ Combination point of 850C+850C BPF Ass'y of the multiplexer

Multiplexer Port naming	Interface Point		Remark
	850C RDU	850C BPF	
850C TX	-	TX OUT	
850C RX	-	RX IN	

How to install RDU 800PS+900I+PA Ass'y

The following components are required:

No.	Unit	Description	Remark
1	RDU 800PS+900I+PA	RF Module	
2	800PS+900I+PA BPF	BPF	
3	800PS+900I+PA TX RF CABLE	SMA(M) to SMA(M), 460mm	
4	800PS+900I+PA RX RF CABLE	SMA(M) to SMA(M), 380mm	

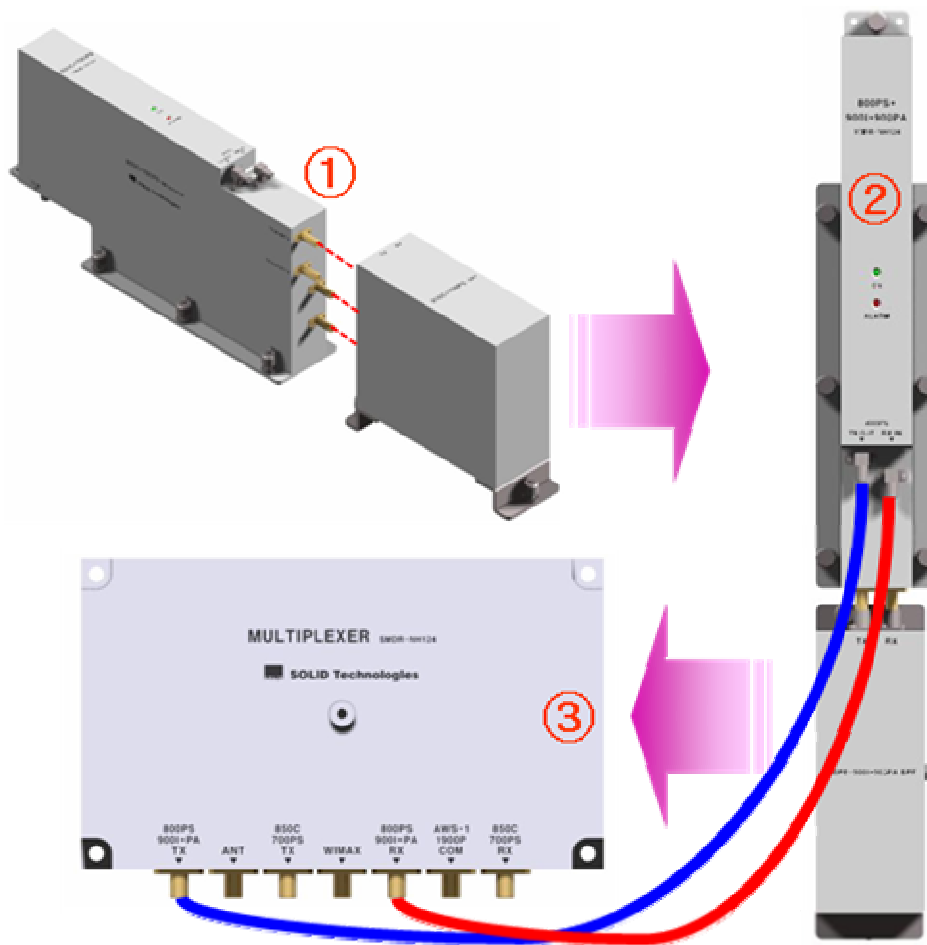

- ① Combine RDU 800PS+900I+PA with 800PS+900I+PA BPF (As it is a plug type, push the unit to combine with BPF.)
- ② Insert the combined 800PS+900I+PA BPF Ass'y into any slot of ROU.
- ③ Combination point of 800PS+900I+PA BPF Ass'y of the multiplexer

Multiplexer Port naming	Interface Point		Remark
	800PS+900I+PA RDU	800PS+900I+PA BPF	
800PS+900I+PA TX	TX OUT	-	
800PS+900I+PA RX	RX IN	-	

How to install RDU 850C+700PS Ass'y

The following components are required:

No.	Unit	Description	Remark
1	RDU 850C+700PS	RF Module	
2	850C+700PS BPF	BPF	
3	850C+700PS TX RF CABLE	SMA(M) to SMA(M), 470mm	
4	850C+700PS RX RF CABLE	SMA(M) to SMA(M), 400mm	

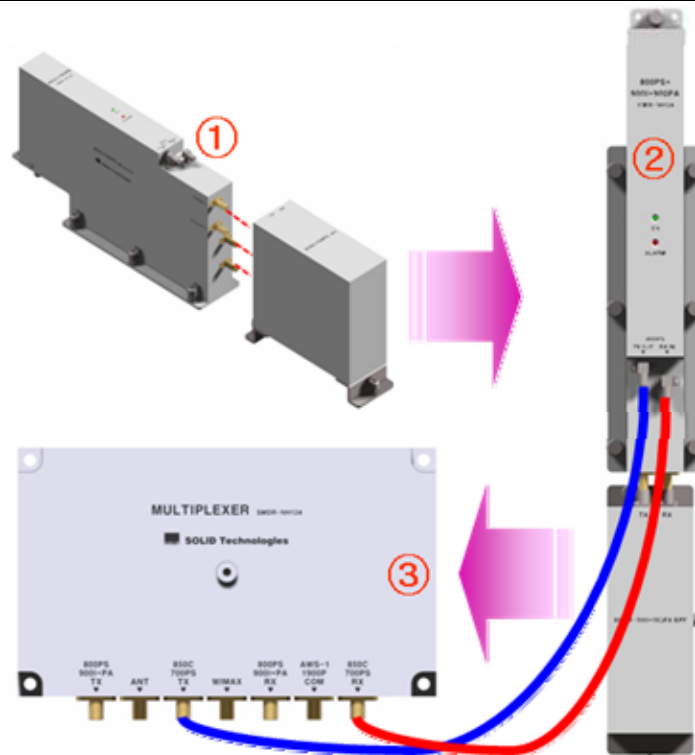

- ① Combine RDU 850C+700PS with 850C+700PS BPF (As it is a plug type, push the unit to combine with BPF.)
- ② Insert the combined 850C+700PS BPF Ass'y into any slot of ROU.
- ③ Combination point of 850C+700PS BPF Ass'y of the multiplexer

Multiplexer Port naming	Interface Point		Remark
	850C+700PS RDU	850C+700PS BPF	
850C+700PS TX	TX OUT	-	
850C+700PS RX	RX IN	-	

How to install RDU 1900P+AWS-1 Ass'y

The following components are required:

No.	Unit	Description	Remark
1	RDU 1900P+AWS-1	RF Module	
2	1900P+AWS-1 BPF	BPF	
3	1900P+AWS-1 RF CABLE	SMA(M) to SMA(M), 390mm	
4	1900P+AWS-1 RF-01	SMA(M) to SMA(M)	Semirigid

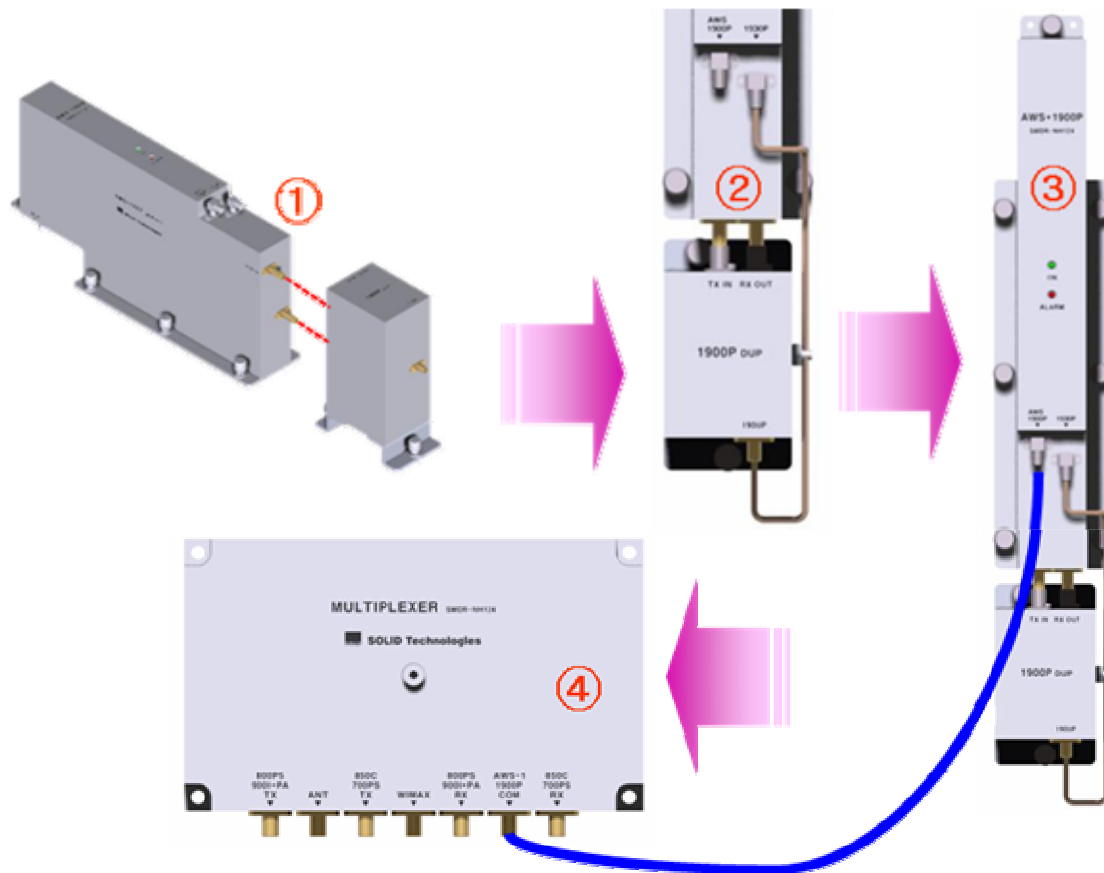

- ① Combine RDU 1900P+AWS-1 with 1900P BPF (As it is a plug type, push the unit to combine with BPF.)

- ② Connect BPF 1900P port with 1900P port of 1900P RDU through 1900P+AWS-1 RF-01 RF CABLE.
- ③ Insert the combined 1900P+AWS-1 BPF Ass'y into any slot of ROU.
- ④ Combination point of 1900P+AWS-1 BPF Ass'y of the multiplexer

Multiplexer Port naming	Interface Point		Remark
	1900P+AWS-1 RDU	1900P BPF	
AWS-1+1900P COM	1900P+AWS	-	



You cannot insert the same module and band into MULTIPLEXER port at the same time. For example, you are not supposed to insert both of 800PS RDU and 800PS+900I+PA RDU into ROU at the same time. In the same way, you cannot concurrently insert both of 850C RDU and 850C+700PS RDU into ROU.

Information of LED at the front RDU

RDU has the structure of enabling a random RDU to be inserted into three slots. ROU can be equipped with a total of three RDUs. If only one RDU is inserted into a slot and the other slots remain reserved, you need to insert BLANK cards into the other slots.

When RDU is inserted into ROU, LED of the front panel shows the following information:



LED		Description
ON		Power is not supplied
		Power is supplied.
ALM		Normal Operation
		Abnormal Operation



Up to three RDUs can be inserted. If one or two units are used, then you need to terminate the unused slot of RDU with a BLANK card.

5.3.5 Consumption of RDU

The following table shows power consumption of RDU:

Part	Unit	Consumption Power	Remark
Common Part	Enclosure	17W	
	RCPU		
	ROPTIC		
	RPSU		
	Multiplexer		
RDU	RDU 800PS	39W	

	RDU 800PS+900I+Paging	800PS	49W	900I+PA HPA OFF
		900I+PA	72W	800PS HPA OFF
		FULL	79W	Both HPA ON
	RDU 850C	39W		
	RDU 850C+700PS	850C	49W	700PS HPA OFF
		700PS	58W	850C HPA OFF
		FULL	93W	Both HPA ON
	RDU 1900P+AWS-1	1900P	46W	AWS-1 HPA OFF
		AWS-1	46W	1900P HPA OFF
		FULL	68W	Both HPA ON

For power consumption of ROU, the common part consumes 17W. Depending on the quantity of each RDU, you can add overall power consumption of ROU. Only, in case of Dual-Band signals, power consumption is calculated respectively when HPA of the other party is turned OFF and two HPA devices are turned ON. Note that when you calculate Power Budget.

5.4 OEU Installation

OEU is used to expand ROU in Campus Site.

OEU is located at a Remote Closet. As it can be equipped with up to two DOUs , you can expand a total of eight ROUs.

5.4.1 OEU Shelf installation

OEU is a shelf in around 2U size. Its width is 19" and so this unit should be inserted into a 19" Standard Rack. OEU is in a Remote Closet, providing optical ports of ROU.

The following table shows power consumption of OEU:

No.	Unit	Description	Remark
Common Part	Shelf	Including EWDM,ERF,EPSU,ECPU, 19",2U	1EA
	Power Cable	-48Vdc Input with two lug terminal	1EA

Optional Part	DOU	Optical Module with 4 Optic Port	Up to 2EA to be inserted
---------------	-----	----------------------------------	--------------------------

5.4.2 OEU Power Cabling

The input power of OEU is DC -48V. You need to connect DC cable with the Terminal Block seen at the rear of OEU.

Terminal	Color of cable	Description	Remark
-48V	Blue color	Input range: -42 ~ -56Vdc	
NC	Not Connected		
GND	Black color		

Before connecting the power terminal, you need to connect "+" terminal of Multi Voltage Meter probe with the GND terminal and then connect "-" terminal with -48V to see if "-48Vdc" voltage is measured. After the check, connect the power terminal through the terminal seen below.

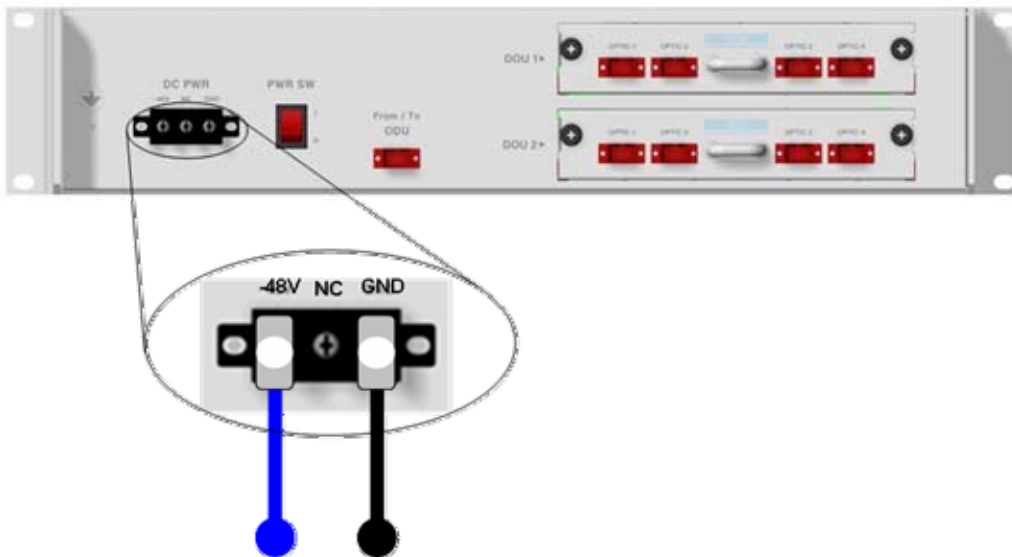

Note that OEU does not operate if the "+" terminal and the "-" terminal of the -48V power are not inserted into the accurate polarity.

5.4.3 OEU Optic Cabling

OEU is connected with upper ODU. With DOU inserted in it, the unit is connected with ROU.

As OEU has a shelf with EWDM in it, the unit makes electronic-optical conversion of TX signals from ODU and makes optical-electronic conversion of RX signals. In addition, OEU can be equipped with up to two DOUs. One DOU supports four optical ports and one optical port can be connected with ROU. With WDM in DOU, the unit can concurrently send/receive two pieces of wavelength (TX:1310nm, RX:1550nm) through one optical core. DOU has SC/APC of optical adaptor type.



Figure 5.7 – Optical cable of SC/APC Type

For optical adaptor, SC/APC type should be used. To prevent the optical access part from being marred with dirt, it should be covered with a cap during move. When devices are connected through optical cables, you need to clear them using alcohol to remove dirt.

5.4.4 Insert DOU to OEU

Into OEU Shelf, up to two DOUs can be inserted. DOU module is in Plug in Play type.

When you insert DOU in OEU, insert the unit into the top DOU1 slot first. You can be careful as the number is silk printed at the left.

The following figure shows installation diagram of OEU with one DOU inserted in it.



The following figure shows installation diagram of OEU with two DOUs inserted in it.

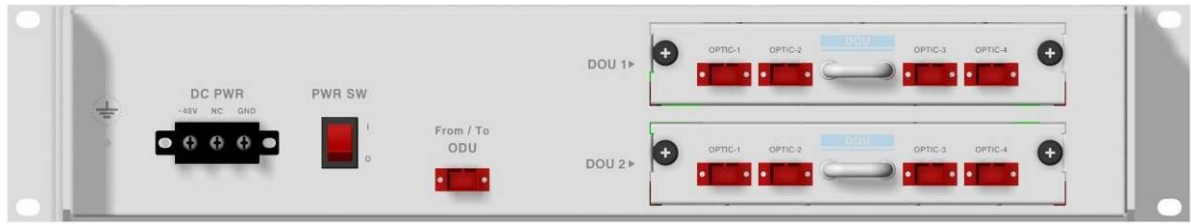

 When you insert DOU into OEU, insert the unit into the top DOU1 first. For unused slots, you need to install BLANK UNIT into them.

5.4.5 Consumption Power of OEU

OEU has -48V DC Power supply in it. ODU can be equipped with up to two DOUs. Depending on the quantity of DOU, power consumption is varied.

The following table shows power consumption of OEU:

Part	Unit	Consumption Power	Remark
Common Part	Shelf	12W	
	EWDM		
	ERF		
	EPSU		
OEU_4	DOU 1 EA	23W	
OEU_8	DOU 2 EA	33W	

5.5 System Operation and Alarm Status

This section describes operation of SMDR-NH124. It deals with procedures and operations for normal system operation after installation. It also describes operations per unit and interworking methods.

5.5.1 System setting and operation

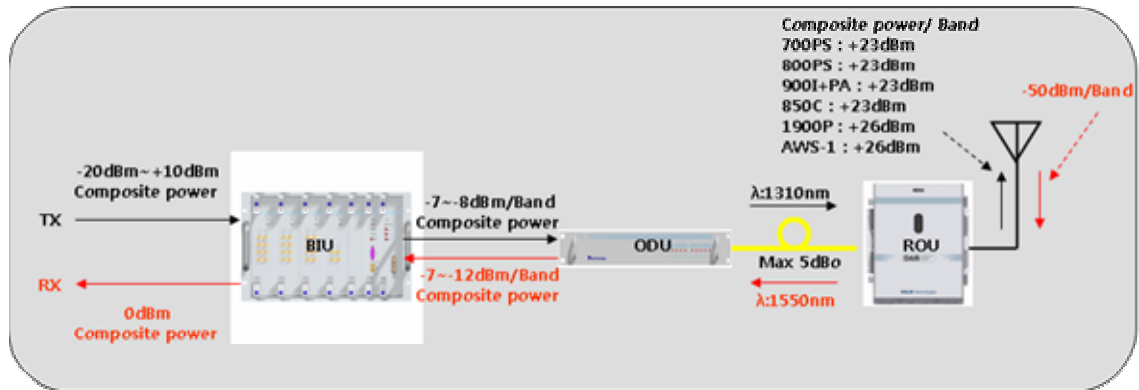











1. Perform system setting shown in the above configuration
2. For downlink performance test, using signal analyzer, provide -20dBm/composite power input to BIU, and set system gain to maximum level.
3. Connect all the unit like above configuration and turn the power on for all units and make sure all the alarms in normal status by GUI monitoring.
4. Using spectrum analyzer and optic power meter, check output power for each unit as described in the above configuration and check whether the output powers are in the normal range.
5. For uplink performance test, using signal analyzer, provide -50dBm/band to remote unit
6. Connect all the unit like above configuration and turn the power on for all units and make sure all the alarms in normal status by GUI monitoring.
7. Using spectrum analyzer and optic power meter, check output power for each unit as described in the above configuration and check whether the output powers are in the normal range.
8. Temporarily, turn the power off for all units.
9. Using spectrum analyzer, measure the input range from BTS/BDA if the range is between -20dBm and +10dBm.
10. If the level exceeds the range, need to connect an attenuator with the front end of BIU input to adjust the level in the corresponding range.
11. turn the power on for all units and make sure all the alarms in normal status by GUI monitoring.
12. For system optimization, through GUI, adjust the all the parmeters such as ALC, AGC, Shut down level, and offset values.

5.5.2 BIU Alarms

Item	Description
1. MDBU LED	LED to show whether MDBU is installed and gets faulty
2. RF Monitor Port	20dB Coupling compared with TX Input Level 20dB Coupling compared with RX Output Level
3. Alarm LED & Reset	Communication state with devices, alarm status of the system and reset switch
4. NMS(RS-232C)	RS-232C port for communication and diagnosis of devices through PC/laptop
5. NMS(Ethernet)	Ethernet port for upper network
6. Pwr Test Port & ALM	Output DC power test port and ALM LED to show abnormal state, if any
7. Power switch	Power ON/OFF switch











LED information

Unit	LED		Indicates
MDBU	ON		Green: MDBU is normally power-supplied.
	ALM		Green: MDBU is normal.
			Red: MDBU is abnormal; check the alarm through RS-232C.
MCPU	ON		Green: MCPU is normally power-supplied.
	TXD		Green flicker: TX signals are transmitted to communicate with ROU.
	RXD		Green flicker: RX signals are received from ROU.
	ALM		Green: BIU system is normal.
			Red: BIU system is abnormal; check the alarm through RS-232C.
MPSU	ON		Green: BIU is connected with power and MPSU works normally.
	ALM		Green: DC output is normal.
			Red: DC output is abnormal.

5.5.3 ODU Alarms

Item	Description
1,2	LED indicator to check DOU module state to see if it is abnormal















LED information

Unit	LED		Indicates
DOU1,2	LD		Green: Laser Diode is normal.
			Red: Laser Diode is abnormal.
	PD1		Green: Photo Diode of optical port 1 is normal.
			Red: Photo Diode of optical port 1 is abnormal; check optical cables.
	PD2		Green: Photo Diode of optical port 2 is normal.
			Red: Photo Diode of optical port 2 is abnormal; check optical cables.
	PD3		Green: Photo Diode of optical port 3 is normal.
			Red: Photo Diode of optical port 3 is abnormal; check optical cables.
	PD4		Green: Photo Diode of optical port 4 is normal.
			Red: Photo Diode of optical port 4 is abnormal; check optical cables.

5.5.4 OEU Alarms

Item	Description
1.EWDM LED	LED indicator to check EWDM state to see if it is abnormal
2.DOUE LED	LED indicator to check DOUE module state to see if it is abnormal
3.System LED and Reset	Communication state with devices, alarm status of the system and reset switch
4. NMS(RS-232C port)	RS-232C port for communication and diagnosis of devices through PC/laptop

LED information

Unit	LED		Indicates	
EWDM	LD		Green: Laser Diode is normal.	
			Red: Laser Diode is abnormal.	
	PD		Green: Photo Diode is normal.	
			Red: Photo Diode is abnormal; check optical cables.	
DOU1,2	LD		Green: Laser Diode is normal.	
			Red: Laser Diode is abnormal.	
	PD1		Green: Photo Diode of optical port 1 is normal.	
			Red: Photo Diode of optical port 1 is abnormal; check optical cables.	
	PD2		Green: Photo Diode of optical port 2 is normal.	
			Red: Photo Diode of optical port 2 is abnormal; check optical cables.	
	PD3		Green: Photo Diode of optical port 3 is normal.	
			Red: Photo Diode of optical port 3 is abnormal; check optical cables.	
	PD4		Green: Photo Diode of optical port 4 is normal.	
			Red: Photo Diode of optical port 4 is abnormal; check optical cables.	
	System	ON		Green: ECPU is normally power-supplied.









	TXD1	●	Green flicker: TX signals are sent to communicate with BIU.
	RXD1	●	Green flicker: RX signals are received from BIU.
	TXD2	●	Green flicker: TX signals are sent to communicate with ROU.
	RXD2	●	Green flicker: RX signals are received from ROU.
	ALM	●	Green: OEU system is normal.
		●	Red: OEU system is abnormal; check the alarm through RS-232C.

5.5.5 ROU Alarms

No.	Unit	Description	Remark
1	RDU+BPF	Remote Drive Unit Filter and high amplify TX signals; Filter and amplify RX signals; Remove other signals through BPF	
2	RPSU	Remote Power Supply Unit Input power: DC -48V, Output power: 27V,9V, 6V For 120V input of AC/DC; For -48V input of DC/DC	
3	R-OPTIC	Remote Optic Make RF conversion of TX optical signals; Convert RX RF signals into optical signals; Compensates optical loss Communicates with BIU/OEU though the FSK modem	
4	RCPU	Remote Central Processor Unit Controls signal of each unit Monitors BIU/ODU/OEU status through FSK modem communication	
5	Multiplexer	Multiplexer Combine TX signals from 3 RDUs; Distribute RX signals to 3 RDUs; Enable you to use a single antenna port	

6	Enclosure	Enclosure to satisfy NEMA4; Enable Wall/Rack Mount; Check if the system is normal, through the front panel LED	
7	SIU	System Interface Unit Distribute power and signals of each module	

LED information

Unit	LED	Indicates
System	ON	 Green: ECPU is normally power-supplied.
	LD	 Green: Laser Diode is normal.
		 Red: Laser Diode is abnormal.
	PD	 Green: Photo Diode is normal.
		 Red: Photo Diode is abnormal; check optical cable.
	TXD	 Green flicker: TX signals are transmitted to communicate with BIU/OEU
	RXD	 Green flicker: RX signals are received from BIU/OEU.
	ALM	 Green: OEU system is normal.
 Red: OEU system is abnormal; check the alarm through RS-232C.		