

### Channel 2 start UTC

This is the hour and minute for transmission on channel 2. This specifies the AIS frame (minute) within a day in which the start slot for channel 2 resides. Typically the channel 2 start time is offset by 3 minutes from the start time used for channel 1. With a 6 minute reporting interval on each channel this results in a transmission every 3 minutes on alternating channels.

### Channel 2 start slot

This is the slot number for the first transmission on channel 2. The slot number can range from -1 (transmission disabled on this channel) to 2249. Note that each message #21 transmission occupies two slots and associated base station slot reservations must therefore reserve two slots.

### Channel 2 interval

This is the interval in slots between transmissions on channel 2. The interval can range from 0 to 3240000 slots, which equates to an interval of one day. Typically the interval is set to 13500 slots (6 minutes) on each channel which results in an overall interval of 3 minutes.

### Example FATDMA schedule

A typical transmission schedule requires that the AIS AtoN transceiver transmit AIS message #21 every three minutes on alternating channels. The transmission schedule is presented diagrammatically in Figure 19.

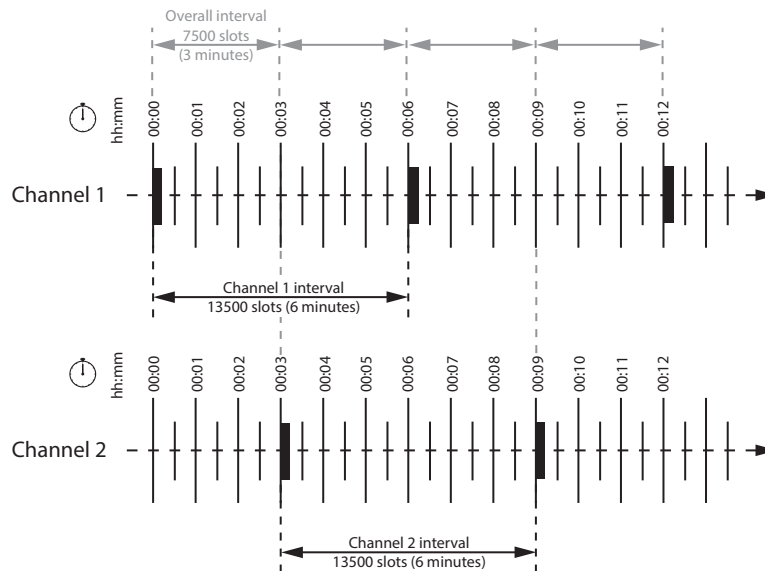

Figure 19 Example FATDMA schedule

This schedule can be configured using the following values:

- Channel 1 start UTC = 00:00 (the first frame of every hour)
- Channel 1 start slot = 0 (the first slot in the frame, so slots 0 and 1 are used by the message #21 transmission)
- Channel 1 interval = 13500 slots (this equates to a 6 minute interval as there are 2250 slots per minute)
- Channel 2 start UTC = 00:03 (the third frame of every hour)
- Channel 2 start slot = 0 (the first slot in the frame, so slots 0 and 1 are used by the message #21 transmission)
- Channel 2 interval = 13500 slots (this equates to a 6 minute interval as there are 2250 slots per minute)

The transceiver is now configured to report message #21 on channel 1 every 6th minute, and on channel 2 every 6th minute, but offset by three minutes from channel 1. This results in a transmission of message #21 every three minutes on alternating channels. The actual start slot selected for each channel will depend on the FATDMA allocations in the area of operation.

### 7.3.4 RATDMA Schedule configuration **T3** **T3+S**

Using the RATDMA (Random Access TDMA) access scheme the time for each transmission made by the transceiver is specified. The transceiver will determine the actual slots used for transmission based on internal knowledge of the AIS environment gained from the AIS receivers.

The parameters required for an RATDMA schedule are as follows.

#### Channel 1 start UTC

This is the hour and minute of the frame in which transmission will occur on channel 1. The slot used within this frame will be determined by the transceiver.

#### Channel 1 interval

This is the interval in minutes between transmissions on channel 1. A typical value is 6 minutes.

#### Channel 2 start UTC

This is the hour and minute of the frame in which transmission will occur on channel 2. The slot used within this frame will be determined by the transceiver.

#### Channel 2 interval

This is the interval in minutes between transmissions on channel 1. A typical value is 6 minutes.

#### Example RATDMA schedule

A typical transmission schedule requires that the AIS AtoN transceiver transmit AIS message #21 every three minutes on alternating channels. The transmission schedule is presented diagrammatically in Figure 20.

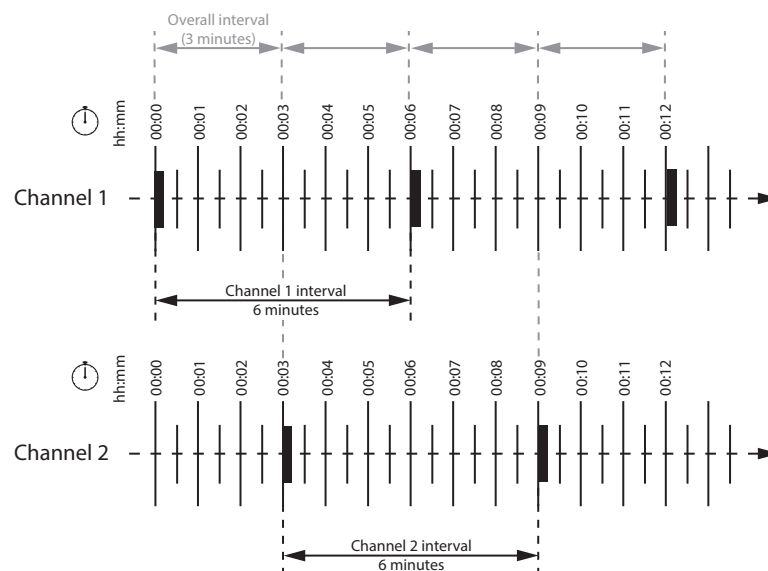

Figure 20 Example RATDMA schedule

This schedule can be configured using the following values:

- Channel 1 start UTC = 00:00 (the first minute of every hour)
- Channel 1 interval = 6 minutes
- Channel 2 start UTC = 00:03 (the third minute of every hour)
- Channel 2 interval = 6 minutes

The transceiver is now configured to report message #21 on channel 1 every 6th minute, and on channel 2 every 6th minute, but offset by three minutes from channel 1. This results in a transmission of message #21 every three minutes on alternating channels. The exact timings of the transmissions within the selected minute will vary as the transceiver selects available slots using RATDMA.

### 7.3.5 Virtual AtoN configuration

The transceiver can be configured to transmit position reports for up to five virtual or synthetic Aids to Navigation. This configuration is carried out using the *Virtual AtoN(s)* tab in proAtoN. Within this tab there are sub-tabs relating to each of the five virtual or synthetic AtoNs. The sub-tabs are visible at the left hand edge of the window. The layout of the virtual AtoN configuration tab is provided in Figure 21.

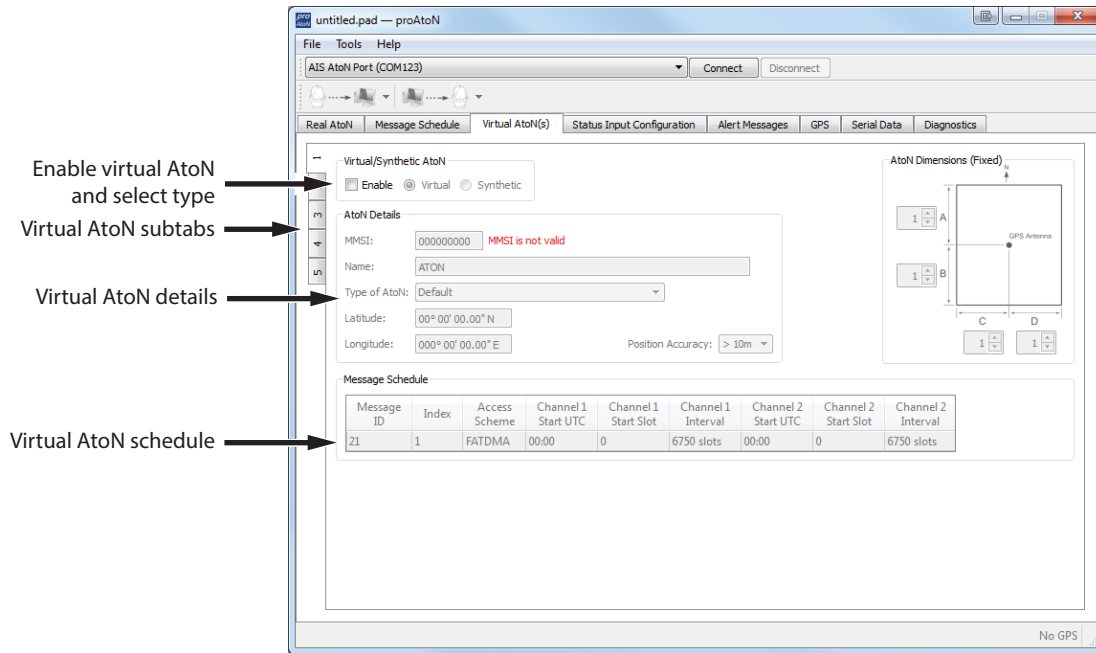

Figure 21 Virtual AtoN configuration tab layout

The following parameters are required to configure a virtual or synthetic AtoN. Note that the 'real' AtoN must be properly configured in order to make use of the virtual AtoN feature.

#### Virtual / Synthetic AtoN

Each virtual AtoN required must be separately enabled by checking the 'Enable' checkbox. The type of virtual AtoN can then be selected.

- Virtual AtoN  
A virtual AtoN is transmission of message #21 for an Aid to Navigation that does not physically exist. A virtual AtoN may be used to mark a temporary hazard to navigation, e.g., a wreck. For further information on the use of virtual AtoNs please refer to IALA A-126, IALA O-143 and IALA guideline 1081.
- Synthetic AtoN  
A synthetic AtoN is transmission of message #21 from an AIS station located remotely from the physical Aid to Navigation. An example of use is to provide an AIS AtoN target for a buoy or mark that is not capable of supporting AIS AtoN hardware.

#### Virtual AtoN Details

The basic configuration of a virtual or synthetic AtoN is comparable to that required for a 'real' AIS AtoN. Note that the MMSI number format is different:

- A virtual AtoN MMSI has the format 99MID6XXX, where MID is the appropriate national MID and XXX is a number unique to this station.

- A synthetic AtoN MMSI has the same format as a real AtoN MMSI, e.g., 99MID1XXX, where MID is the appropriate national MID and XXX is a number unique to this station.

The position of the virtual or synthetic AtoN must be configured appropriately to the position of the aid. The dimensions of the virtual or synthetic AtoN should also be configured.

### Virtual AtoN schedule

The transmission schedule for a virtual or synthetic AtoN must be configured in the same way as that for the 'real' AtoN. The TDMA access scheme, start times and intervals must be configured in the virtual AtoN tab following the guidance in section 7.3.3 or 7.3.4 as appropriate. When an FATDMA schedule is used it is important to ensure the slot allocations used for the virtual and real AtoNs are different in every case. Also note that two consecutive slots are used for each virtual AtoN report.

### 7.3.6 Alert messages

The transceiver can be configured to transmit text messages for three different alert conditions.

- An addressed or broadcast text message can be transmitted when the transceiver detects a Built In Integrity Test (BIIT) failure.
- An addressed text message can be transmitted to an approaching vessel if the vessel comes within a configurable distance of the transceivers location. This function is only available with Type 3 variants and with full time receiver operation.
- An addressed or broadcast text message can be transmitted when the transceiver determines that it is off position (see section 7.3.1). This message is in addition to use of the alternate schedule for off position reporting (if the alternate schedule is enabled) and does not replace that function.

The layout of the alert messages configuration tab is provided in Figure 22.

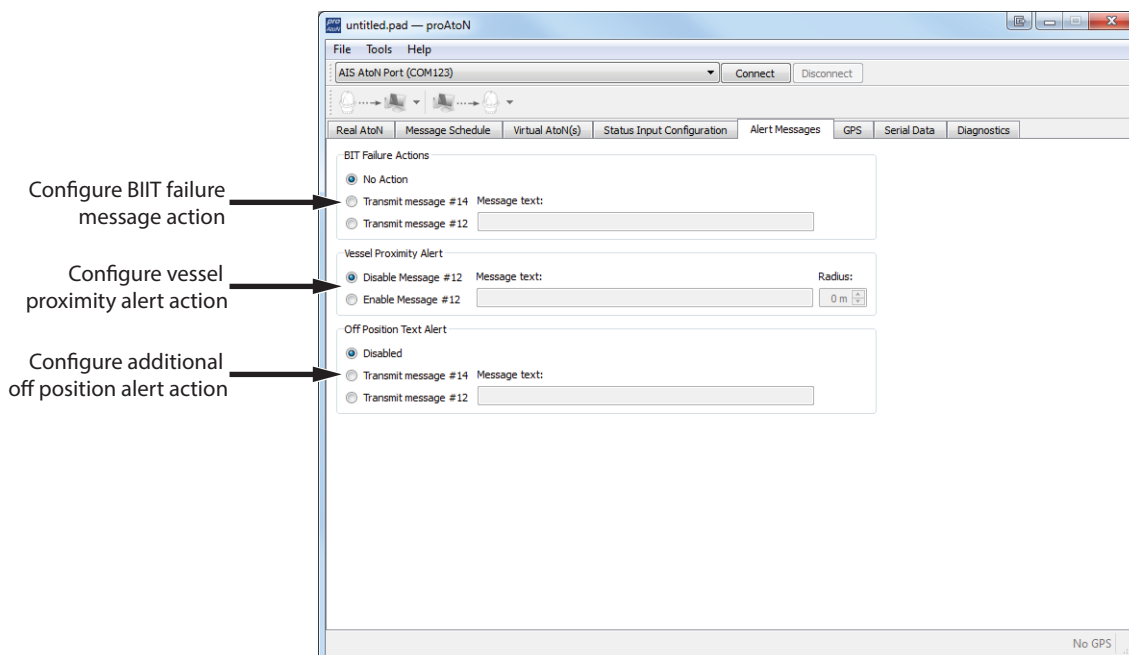

Figure 22 Alert messages configuration tab layout

#### BIIT failure actions

This section allows configuration of the text message to be transmitted on detection of a Built In Integrity Test failure (BIIT failure). Such a failure may indicate a problem with the transceiver and it may be prudent to warn vessels not to rely on the information provided by the transceiver in this situation. Note that the health of the transceiver is always transmitted as part of the standard Aids to Navigation position report (message #21), however the status contained in that message may not be shown on all display systems.

The available actions on BIIT failure are:

- No action - no message is transmitted on detection of a BIIT failure
- Transmit message #14. A broadcast text message is transmitted on detection of a BIIT failure. The text content of the message must be defined in the 'Message text' box.
- Transmit message #12. An addressed text message is transmitted on detection of a BIIT failure. The destination for the addressed message is configured on the 'Real AtoN' tab (see section 7.3.1)

In addition to configuration of the BIIT failure action a schedule for the associated message must be configured in the 'Message schedule' tab.

- Message #14 Index 1 must be configured if the message #14 action is selected.
- Message #12 Index 1 must be configured if the message #12 action is selected.

### **Vessel proximity alert**

This section allows configuration of the text message to be transmitted on detection of vessel breaching a defined radius (or guard ring) around the transceiver. This message can be used to warn approaching vessels of potential collision with the AtoN. The addressed message is automatically sent to all vessels that breach the guard ring radius.

The available vessel proximity alert actions are:

- Disable message #12 - the vessel proximity alert function is disabled
- Enable message #12 - the function is enabled and the text content of the message to be transmitted must be defined in the 'Message text' box. The guard ring radius for the proximity alert must also be configured in the 'Radius' box; note that the value is set in metres.

In addition to configuration of the vessel proximity alert a schedule for the associated message must be configured in the 'Message schedule' tab.

- Message #12 Index 2 must be configured if the message #12 action is selected.

### **Off position alert**

This section allows configuration of the text message to be transmitted when the transceiver detects that it is off position. The settings for off position detection are made on the 'Real AtoN' tab (see section 7.3.1). The configuration of an alternate message #21 reporting schedule when off position is independent of the configuration of this text alert.

The available off position alert actions are:

- Disabled - no text message is transmitted when the transceiver determines that it is off position
- Transmit message #14. A text message is broadcast when the transceiver detects that is off position. The text content of the message must be defined in the 'Message text' box.
- Transmit message #12. An addressed text message is transmitted on detection of an off position condition. The destination for the addressed message is configured on the 'Real AtoN' tab (see section 7.3.1)

In addition to configuration of the vessel proximity alert a schedule for the associated message must be configured in the 'Message schedule' tab.

- Message #14 index 2 must be configured if the message #14 action is selected
- Message #12 index 3 must be configured if the message #12 action is selected

### **7.3.7 Status input configuration tab**

AIS AtoN position reports (message #21) contain status information encoded as a bit sequence. The status bits contain the basic operational state of a connected lamp and RACON along with the overall health of the transceiver itself. Connection of a lamp and/or RACON is optional and requires equipment with a suitable health output. Interfacing of lamp and RACON status is described in sections 6.1.1, 6.1.3 and 6.2.4.

The status information can be obtained from one of three sources as described in section 6.1.3. The status input configuration tab is used to set the source and other associated parameters. The layout of the status input configuration tab is provided in Figure 23.

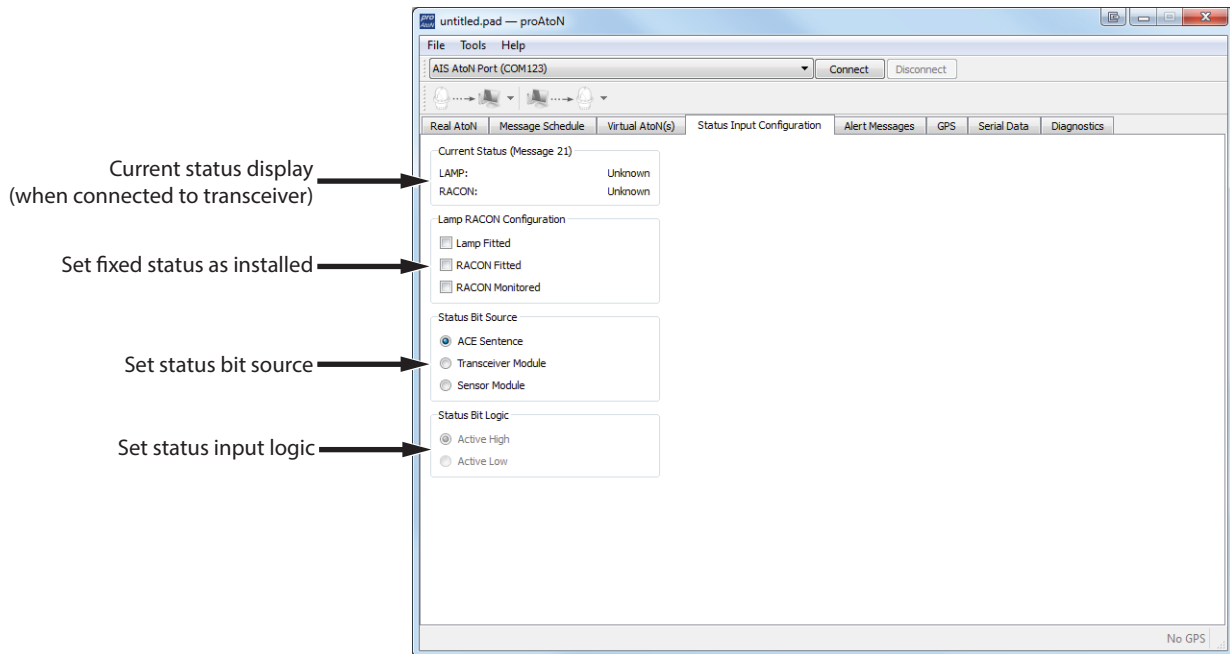

Figure 23 Status input configuration tab layout

### Current status (message 21)

This section shows the current lamp and RACON status determined by the transceiver. The transceiver must be connected and powered from a DC supply in order for this display to operate correctly.

### Lamp & RACON configuration

This section allows the fixed parameters of the lamp and RACON to be configured. The check boxes should be set according to the physical configuration. For example if a lamp status output is connected to the transceiver then the 'Lamp fitted' check box should be checked. If a RACON is connected it is also possible to define if the RACON is monitored or not.

### Status bit source

Select the source for the status information to match the method used to provide status information to the transceiver (this is described in section 6.1.3).

### Status bit logic

The logical sense of the physical status bit inputs (at either the basic or extended sensor interfaces) can be set here. This allows for interface of equipment with active high or active low status outputs.

## 7.4 Transceiver diagnostics

The proAtoN application provides a number of features to assist with installation of an AIS AtoN and diagnosis of fault conditions. These features are available through the GPS, Diagnostics and Serial Data tabs in proAtoN.

### 7.4.1 GPS tab

The GPS tab shows the status of the GNSS receiver built into the transceiver. This provides an indication of the quality of the GNSS satellite signals being received along with the current position of the transceiver.

At least four satellites with a carrier to noise ratio in excess of 40 dBHz are required for an acceptable position fix. Relocating the transceiver or connecting an external GNSS antenna can help improve the signal quality and resulting position accuracy.

The internal GNSS receiver supports SBAS (Satellite Based Augmentation Service) to enable improved accuracy and integrity of GNSS position fixes. The availability of SBAS depends on the installation location of the transceiver (the WAAS SBAS service covers most of the US and the EGNOS service covers Europe).

#### 7.4.2 Diagnostics tab

The Diagnostics tab provides system version and status information. This information may be required when requesting technical support for the product.

##### AtoN Details

- The connected AtoN Type is displayed as Type 1 or Type 3
- The application and bootloader software versions for the connected AtoN are displayed
- The serial number of the connected AtoN is displayed

##### Power status

- The VHF antenna VSWR (Voltage Standing Wave Ratio) as measured at the last AIS transmission is displayed. This value is for indication only. A value better than 3:1 is expected for a good antenna system. The alarm limit for antenna VSWR is set to 5:1. A perfect antenna would give a VSWR of 1:1.
- The system supply voltage is displayed in volts. The supply voltage must be between 9.6V and 32.6V for correct operation. The supply voltage alarm will activate outside of this supply voltage range.

##### Report generation

Clicking the 'Generate' button will produce full report of the transceiver status. This report may be requested by technical support personnel. After clicking the button select a suitable location for the report file before clicking save.

##### Reported messages

During operation the transceiver will output a variety of status messages relating to the current operating state. These messages are for information only and do not represent a fault condition.

Message text	Description / Resolution
TX attempt failed (msg 6 no payload re-broadcast data)	A transmission of message #6 has failed as the payload data required for this message was not provided (by either the extended sensor interface, or an external system). The likely cause is a configuration error relating to data capture.
TX attempt failed (msg 8 no payload re-broadcast data)	A transmission of message #8 has failed as the payload data required for this message was not provided (by either the extended sensor interface, or an external system). The likely cause is a configuration error relating to data capture.
TX attempt failed (msg 12 no payload re-broadcast data)	A transmission of message #12 has failed as the payload data required for this message was not provided (by either the extended sensor interface, or an external system). The likely cause is a configuration error relating to data capture.
TX attempt failed (msg 14 no payload re-broadcast data)	A transmission of message #14 has failed as the payload data required for this message was not provided (by either the extended sensor interface, or an external system). The likely cause is a configuration error relating to data capture.

Message text	Description / Resolution
Standby blocked: Off position algorithm	The transceiver can't enter standby (low power) mode because the 'off position' algorithm has detected an off position condition. Moving the transceiver within the configured operating radius will resolve this.
Standby Blocked: Acquiring GPS	The transceiver can't enter standby (low power) mode because it is currently acquiring a GNSS position fix. Standby operation will resume when a fix is acquired.
Standby disabled	Standby mode (low power operation) is disabled by configuration.
Standby Blocked: USB connected	The transceiver will not enter standby (low power) mode whilst the USB interface is connected to a PC.
Standby Blocked: Shell running	The transceiver will not enter standby (low power) mode whilst the configuration shell is active.
Standby Blocked: Receivers enabled	The transceiver can't enter standby mode if the current configuration requires that the receivers are active.
Exiting standby	Information only on exit of standby mode.
Entering standby for xx seconds	Information only on entry to standby mode.

### Active alarms

The transceiver incorporates BIIT (Built In Integrity Test) routines which continuously monitor key operating parameters. Should an integrity test fail the failure will be indicate in the active alarms area.

Alarm text	Description / Resolution
Tx Malfunction	A transmitter malfunction has been detected - please contact your supplier.
Antenna VSWR exceeds limits	The VHF antenna VSWR is above the permitted limit. Check the VHF antenna, cable and connections are sound. The VSWR measured at the last transmission is displayed on the proAtoN diagnostics tab.
Rx Channel 1 malfunction	A receiver malfunction has been detected - please contact your supplier.
Rx Channel 2 malfunction	A receiver malfunction has been detected - please contact your supplier.
EPFS failure	No position is available from the internal GNSS receiver - please contact your supplier.
DGNSS input failed	No data is available from the external source of differential GNSS correction data. Please check connections, baud rate and equipment configuration.



Alarm text	Description / Resolution
Supply voltage	The transceiver power supply voltage is outside of the permitted range. The measured supply voltage is displayed on the proAtoN diagnostics tab.
Low forward power	The transmitter forward power is below a preset limit - please contact your supplier.
Synchronisation lost	Timing information is not available from the internal GNSS receiver - please contact your supplier.

### 7.4.3 Serial data tab

The serial data page shows all data output from the transceiver in NMEA0183 / IEC61162-1 format. It is also possible to send NMEA0183 / IEC61162-1 commands to transceiver if required for technical support or custom configuration. A facility to record the data to a file is provided by clicking the 'Log to File' button.

Certain sentence types can be filtered out of the output window by checking the relevant sentence type in the 'Filters' section of this tab.

## 7.5 Other features

The proAtoN application provides the following additional features to support transceiver installation and upgrade.

### 7.5.1 Offline configuration

A complete AtoN configuration including all schedule parameters, virtual AtoN configuration and other settings can be saved to a file. This feature allows a configuration file to be created without access to the transceiver hardware. The file can be loaded at a later time and synchronised with the transceiver hardware.

This feature is available using the 'Save File' and 'Load File' items available on the File menu. The configuration is saved as a .pad file using a format proprietary to the proAtoN application.

When the proAtoN application is launched a new blank configuration file is created. You will be prompted to save this file if changes are made without saving the file prior to closing the application, or if a 'New file' is created from the File menu.

### 7.5.2 Upgrade to Type 3 AtoN

This option is available in the 'Tools' menu and can be used to upgrade a Type 1 transceiver to a Type 3 transceiver following purchase of an upgrade key from your dealer. Please contact your dealer to purchase an upgrade key; you will be required to provide the transceiver serial number displayed on the diagnostics tab.

## 8 Operation T1 T1+S T3 T3+S

---

Once configured and connected to a power supply and antennas the transceiver will operate autonomously. Correct operation can be confirmed by checking for reception of Aids to Navigation reports (message 21) using another AIS device.

### 8.1 Standby operation

During operation the transceiver will enter a low power standby mode between scheduled transmissions. The unit will not enter standby mode under the following conditions.



**If entry into standby mode is blocked by one or more of these conditions the power consumption of the transceiver will increase significantly.**

- USB interface connected - the transceiver will not enter standby mode whilst the USB interface is connected to a PC. The USB interface should be disconnected once the AtoN is configured and deployed.
- GPS acquisition - the transceiver will not enter standby mode for the first 12 minutes of operation with GPS position available after power is first applied. This period is used to acquire the current number of UTC leap seconds from the GPS system. This only occurs at initial power up and subsequently on four occasions during each calendar year when it is possible for the number of leap seconds to change.
- Off-position algorithm - the transceiver will not enter standby mode when the off position algorithm is active and the transceiver is determined to be off position. Whilst off position the GPS receiver is permanently enabled in order to monitor the position according to the algorithm provided in IALA A-126 Annex A1. Should the transceiver return on position standby operation will resume

During operation the transceiver will output AITXT sentences to the NMEA0183 port 1 indicating any conditions blocking entry to standby mode.

## 9 Data messages and data sources

The transceiver can be configured to transmit a range of data messages in addition to the standard AIS AtoN position report. The purpose, content and means of configuring supported message types is described in the table below.

ID	Message type	Description and use	Content sources
6	Addressed binary data	This message is addressed to another individual AIS station, usually an AIS base station, which is configured to decode the message content. The message content is binary data in a standardised or proprietary format. The message may be used to communicate status information about the AtoN and / or metrological and hydrological data captured at the AtoN.	The binary content for this message can be generated by the extended sensor interface, or provided by suitably configured third party equipment. See sections 9.1 and 9.2 for further information.
8	Broadcast binary data	This message is broadcast to all other AIS stations. The message content is binary data in a standardised or proprietary format. The message may be used to communicate status information about the AtoN and / or metrological and hydrological data captured at the AtoN.	The binary content for this message can be generated by the extended sensor interface, or provided by suitably configured third party equipment. See sections 9.1 and 9.2 for further information.
12	Addressed safety related message	This message is addressed to another individual AIS station and contains safety related text. The text can warn of a failure of the AtoN equipment, alert an approaching vessel to danger of collision with the AtoN or indicate that the AtoN is operating off position	See section 7.3.6 for further information.
14	Broadcast safety related message	This message is broadcast to all other AIS stations and contains safety related text. The text can warn of a failure of the AtoN equipment or indicate that it is operating off position	See section 7.3.6 for further information.

Configuration of the AtoN for capture of data for messages #6 and #8 is described in the following sections. The options available for data capture depend on the transceiver variant.

### 9.1 Product variants without the extended sensor interface **T1** **T3**

The data payload for binary messages #6 or #8 must be provided by external equipment interfaced to the transceiver using the transceiver NMEA0183 port 1 available at the Power and transceiver interface connector described in section 5.5.1. The payload data for the message is requested by the transceiver using a proprietary MCR sentence and provided by the external equipment using the MPR sentence defined in section 10.2.10. Full detail of the protocol for interface of external equipment using this interface is available in an application note "Interfacing third party sensor interfaces" which is available on request from your supplier.

## 9.2 Variants with the extended sensor interface **T1+S** **T3+S**

The extended sensor interface provides a wide range of input and output capabilities as listed in section 6.2. The transceiver is supplied ready with direct support for a specific set of external sensing equipment and AtoN status inputs. The extended sensor interface can also be adapted through software changes to support almost any equipment that might be encountered in an AtoN application. If your application requires interface to equipment other than that listed here please contact your supplier to discuss your requirements.

The default configuration of the extended sensor interface provides:

- Data for message #8, DAC 001, FI 31 for IMO Metrological and Hydrological data
  - Metrological data is captured from an Airmar PB200 weather station
  - Hydrological data is captured from an Impress Sensors & Systems S12C pressure and temperature sensor (SDI-12 interface sensor)
- Data for message #6, DAC 235, FI 10 for UK GLA AtoN monitoring message
  - Data is captured from voltage measurements and other inputs to the extended sensor interface
  - See IALA A-126, Annex C, Example 1 for the definition of this message structure

### 9.2.1 Configuration for message #8 (DAC 001, FI 31) for Metrological and Hydrological data

In order to transmit this message the transceiver must be appropriately configured and interfaced to compatible sensors which are also configured as described below.

#### Transceiver configuration

The transceiver must be configured with a schedule for message #8 index 1.

- The schedule can be either FATDMA or RATDMA. The recommended interval for this message is 12 minutes (27000 slots). Configure the transceiver with a schedule for message #8 index 1 using proAtoN following the guidance in section 7.3.2.
- Note that each message #8 FI 31 occupies two slots.
- In order for the sensors to be detected and configured appropriately they must be connected to the transceiver and powered prior to application of power to the transceiver.

#### Airmar PB200 Weather station connection

Metrological information is collected by an Airmar PB200 weather station connected to the transceiver extended sensor interface. The NMEA0183 interface variant of the PB200 weather station is required.

The installation must provide a suitable power supply (and optional heater power supply) for the PB200 weather station as this is not provided by the transceiver. Please refer to Airmar product documentation for power supply requirements.

The wiring information below relates to the NMEA0183 cable description in revision 06 of the PB200 installation instructions. Please confirm the signal names and wiring colours with the latest installation guide supplied with the PB200 prior to connection. The sensor is connected to the extended sensor interface NMEA0183/RS422 port available at the transceiver sensor interface connector X.

Transceiver sensor interface connector X pin and function	Signal description	PB200 NMEA0183 cable wire colour	PB200 pin number	PB200 signal name
D (S_RS422_TX1_A)	Data from transceiver to sensor	Yellow	7	A/+ IN
E (S_RS422_TX1_B)	Data from transceiver to sensor	Orange	8	B/- IN
F (S_RS422_RX1_A)	Data from sensor to transceiver	White	3	A/+ OUT
G (S_RS422_RX1_B)	Data from sensor to transceiver	Blue	9	B/- OUT

### Impress S12C pressure and temperature sensor connection

Water pressure (depth / tide level) and temperature are collected by an Impress Sensors & Systems S12C sensor connected to the transceiver extended sensor interface. The S12C sensor communicates using an SDI-12 bus data interface (see section 6.2.8 for further information).

The installation must provide a suitable power supply for the SDI-12 bus as this is not provided by the transceiver. Please refer to the S12C sensor documentation for power supply requirements.



**The wiring information below relates to the cable description provided with the S12C sensor at the time of writing. Please confirm the signal names and wiring colours with the latest installation guide supplied with the S12C prior to connection.**

The sensor is connected to the extended sensor interface SDI-12 port available at the transceiver sensor interface connector Y. A ground for the SDI-12 bus is also required and this may be obtained at any one of the GND pins listed in the tables.

Transceiver sensor interface connection	Signal description	S12C sensor wire colour	S12C signal name
Sensor interface <b>connector Y</b> , Pin E (SDI_DATA)	SDI-12 bus data line	Yellow	SDI-12 output
Sensor interface <b>connector X</b> , Pin T (GND) <b>Or</b> Power and transceiver interface connector Pin N or S	GND  Connect also to SDI-12 bus supply GND	Blue	Supply- (0V)

### Impress S12C pressure and temperature sensor configuration

The SDI-12 bus address of the S12C sensor must be configured as zero (the default address) in order for it to be detected by the transceiver.

### Data mapping for message #8 (DAC 001, FI 31) for Metrological and Hydrological data

The mapping of data collected by the sensors to the message #8 FI 31 data fields is provided in the table below.

Message #8 FI 31 data field	Data source	Notes
Longitude	Transceiver internal GNSS	
Latitude	Transceiver internal GNSS	
Position accuracy	Transceiver internal GNSS	
Time stamp	Transceiver internal GNSS	
Average wind speed	Airmar PB200 weather station WIMWD wind speed output	The wind speed provided by the sensor is averaged over 10 minutes before output
Wind gust	Airmar PB200 weather station WIMWD wind speed output	This value is the peak wind speed recorded during the previous 10 minute period
Wind direction	Airmar PB200 weather station WIMWD wind direction output	The wind direction provided by the sensor is averaged over 10 minutes before output

Message #8 FI 31 data field	Data source	Notes
Wind gust direction	Airmar PB200 weather station WIMWD wind direction output	The direction of the wind at the peak wind speed during the previous 10 minute period
Air temperature	Airmar PB200 weather station WIMDA air temperature output	The air temperature provided by the sensor is averaged over 10 minutes before output
Relative humidity	NA	Data not provided
Dew point	NA	Data not provided
Air pressure	Airmar PB200 weather station WIMDA barometric pressure output	The barometric pressure provided by the sensor is averaged over 10 minutes before output
Air pressure tendency	Airmar PB200 weather station WIMDA barometric pressure output	The air pressure is monitored over a 30 minute period and 'steady', 'increasing' or 'decreasing' tendency reported as appropriate
Horizontal visibility	NA	Data not provided
Water level	IMPRESS S12C sensor water level	Water level averaged over the data reporting interval specified for this message.
Water level trend	NA	Data not provided
Surface current speed	NA	Data not provided
Surface current direction	NA	Data not provided
Current speed #1, #2 and #3	NA	Data not provided
Current direction #1, #2 and #3	NA	Data not provided
Current measuring level #1, #2 and #3	NA	Data not provided
Significant wave height	NA	Data not provided
Wave period	NA	Data not provided
Wave direction	NA	Data not provided
Swell height	NA	Data not provided
Swell period	NA	Data not provided
Swell direction	NA	Data not provided
Sea state	NA	Data not provided
Water temperature	IMPRESS S12C sensor water temperature	Current temperature reported by the sensor

Message #8 FI 31 data field	Data source	Notes
Precipitation (type)	NA	Data not provided
Salinity	NA	Data not provided
Ice	NA	Data not provided

### 9.2.2 Configuration for message #6, DAC 235, FI 10 for UK GLA AtoN monitoring message

In order to transmit this message the transceiver must be appropriately configured and interfaced to appropriate signals as described below.

#### Transceiver configuration

The transceiver must be configured with a schedule for message #6 index 1.

- The schedule can be either FATDMA or RATDMA. The recommended interval for this message is 12 minutes (27000 slots). Configure the transceiver with a schedule for message #6 index 1 using proAtoN following the guidance in section 7.3.2.
- The destination MMSI for addressed messages must also be configured as described in section 7.3.1. This should be the MMSI of a shore station that will receive and display the monitoring message
- Note that each message #6 FI 10 occupies one slot.

#### Data mapping for #6, DAC 235, FI 10 for UK GLA AtoN monitoring message

The data mapping from the extended sensor interface inputs to the message #6 FI 10 fields is defined in the following table.

Message #6 FI 10 data field	Data source	Notes
Analogue voltage (internal)	Supply voltage to the transceiver	No additional connections are required for this measurement
Analogue voltage (external 1)	Extended sensor interface isolated analogue input 1	See pin allocation in section 5.5.4 and input description in section 6.2.1
Analogue voltage (external 2)	Extended sensor interface isolated analogue input 2	See pin allocation in section 5.5.4 and input description in section 6.2.1
Status bits (internal, 5 bits)	Copy of status bits used in message #21	See section 7.3.7 for information on configuration of status source.
Status bits (external, 8 bits)	Bit 0 - Isolated digital input 1 Bit 1 - Isolated digital input 2 Bit 2 - Isolated digital input 3 Bit 3 - Isolated digital input 4 Bit 4 - Isolated digital input 5 Bit 5 - Set to 1 if lamp current sense $\geq 100\text{mA}$ , else set to 0 Bit 6 - non isolated digital input 1 Bit 7 - non isolated digital input 2	See sections 5.5.3 and 5.5.4 for pin allocations and sections 6.2.3, 6.2.4 and 6.2.5 for descriptions of these inputs.
Off position status	Transceiver off position algorithm	No additional connections are required for this measurement

## 10 Manual configuration T1 T1+S T3 T3+S

The transceiver is configured using standardised NMEA0183 (IEC61162-1/2) sentences developed for configuration of AIS Aids to Navigation transceivers.

### 10.1 Basic Type 1 AIS AtoN configuration (FATDMA operation)

The following information is the minimum required configuration for a Type 1 AIS AtoN reporting message #21 only.

- The AtoN station must be configured with the 'real' AtoN MMSI using the AID command.
- The AtoN station must be configured with an Name, Charted position, operating radio channels and dimensions using the ACF and ACE commands.
- The AtoN should be configured to broadcast message 21 using the AAR command. Note that the slots selected for the AIS AtoN transmissions in FATDMA mode must be reserved by a base station operating in the area in which the AIS AtoN will be deployed.

### 10.2 NMEA0183 / IEC61162 configuration sentences

The following section documents the standardised NMEA0183/IEC61162 sentences used for AIS AtoN configuration and control.

Please refer to IEC61162-1 (Edition 4) for complete details of the configuration sentence structure.

The configuration sentence formats described in this section are used to both configure the device and as the response format from the device when queried for current status. The query command format is as follows:

**\$--AIQ,ccc\*hh<CR><LF>**

└─ Sentence formatter of data being requested  
(e.g.,AAR)

For example the query command \$ECAIQ,AAR\*21 requests the transceiver output an AAR sentence containing the currently configured broadcast rates for the AtoN station.

Configuration sentences are communicated using the transceiver USB interface.

#### 10.2.1 AAR - Configure broadcast rates for AtoN station

This sentence assigns the schedule of slots that will be used to broadcast Message 21 and other allowed AIS AtoN Station messages. It provides the start slot and interval between the slots used for consecutive transmissions for the message. The AIS AtoN Station should apply the information provided by this sentence to autonomously and continuously transmit the VDL messages until revised by a new AAR sentence. The AIS AtoN Station, upon receipt of an AAR Query for this information, will generate sentences for configured messages providing the current broadcast schedule. New AAR assignments will override existing AAR assignments.

**\$--AAR,xxxxxxxx,xx,xx,xx,xx,xxxx,x.x,x,xx,xx,xxxx,x.x,a\*hh<CR><LF>**

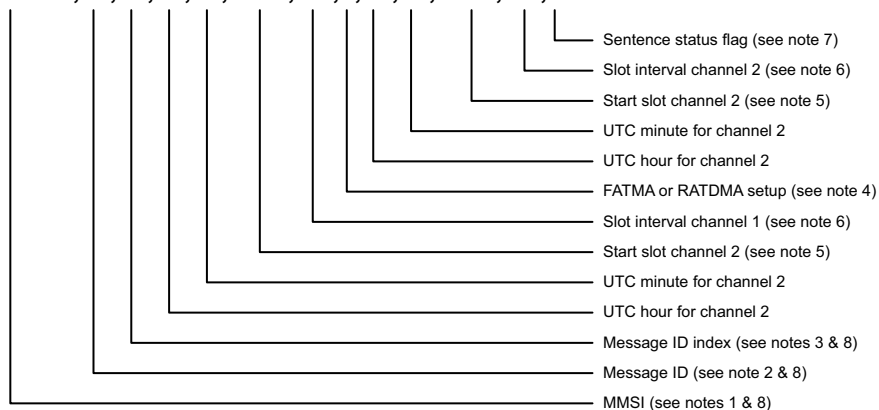



- Note 1 The MMSI is defined in the AID sentence. This field contains the linkage between the MMSI definition (AID), Message 21 configuration (ACF, and ACE) and scheduling (AAR) of Message 21 transmissions.
- Note 2 Message ID is the message identification of the message being scheduled. When Message ID is 0 this indicates that the slots being defined will be used for chaining messages. These slots are not reserved on the VDL via a Message 20 until the competent authority requires their use and will reserve the slots at that time for the proper duration. These slots can be used for chaining or for MPR single transmission.
- Note 3 Message ID Index is used when there are multiple versions of a Message ID. This index value should start at 1.
- Note 4 Used to select whether the AAR is configuring an FATDMA schedule or RATDMA/CSTDMA schedule (0 indicates FATDMA, 1 indicates RATDMA)
- Note 5 For all messages which need to be transmitted in FATDMA mode, starting slot ranging from -1 to 2249 should be used. A value of -1 discontinues broadcasts of the message when the AAR sentence is sent to the AtoN Station, and indicates that no message has been broadcast if the AAR sentence is received from the AtoN Station. A null field indicates no change to the current start slot setting when sent to the AtoN Station, and indicates that the start slot has not been set, i.e. is unavailable, when the AAR sentence is received from the AtoN Station. For an RATDMA transmission schedule, this field will be Null.
- Note 6 For all messages which need to be transmitted, in FATDMA mode slot Interval ranging from 0 to (24\*60\*2250;once per day) and in RATDMA/CSTDMA mode, time interval ranges from 0 to (24\*60\*60) s. A null field indicates no change to the current slot interval setting when sent to the AtoN Station, and indicates that the slot interval has not been set, i.e. is unavailable, when the AAR sentence is received from the AtoN Station.
- Note 7 This field is used to indicate a sentence that is a status report of current settings or a configuration command changing settings. This field should not be null.  
"R" = sentence is a query response  
"C" = sentence is a configuration command to change settings.
- Note 8 The MMSI/Message ID/Message ID index are used to reference a table of messages loaded using MPR, ACF/ACE; this sentence defines the broadcast schedule for each message. Each message in this table is referenced by the combination of MMSI, Message ID, and Message ID index.

### 10.2.2 ACE - Extended general AtoN Station configuration

This sentence and the ACF sentence are used to configure the AtoN Station parameters when it is initially installed, and later in order to make changes to the way it operates. This sentence supports system administration of the AIS AtoN Station operation.

**\$--ACE,xxxxxxxx,hh,xxxx,x,x,x,c--c,xxxxxxxx,a,\*hh<CR><LF>**

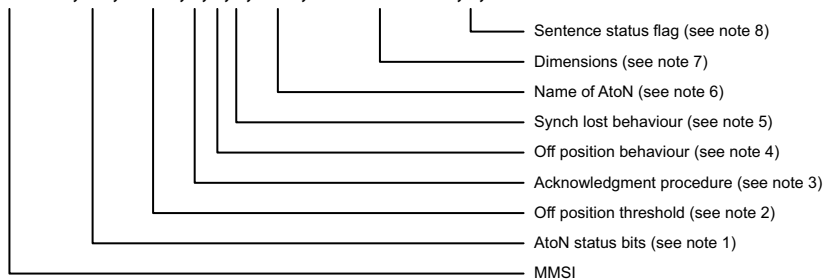

- Note 1 AtoN status bits, indication of the AtoN status, default "00hex": for a Virtual AtoN, this field should be 00hex. The three most significant bits represent the page ID.
- Note 2 The off-position indicator is generated when this threshold is exceeded (distance in metres).
- Note 3 Determines the behaviour of AtoN for message acknowledgement (Message 7 and 13):  
0 will provide acknowledgement as defined by manufacturer,  
1 will not provide acknowledgement.
- Note 4 Off-position behaviour:  
0 – maintain current transmission schedule,  
1 – use new reporting interval configured by AAR using message ID index.
- Note 5 Synch lost behaviour:  
0 – silent,  
1 – continue as before.
- Note 6 Name of the AtoN: maximum 34 characters.
- Note 7 Reference point of reported position; should be given as dimension (aaabbbccdd) of the buoy.  
(See IALA A-126)

Note 8 This field is used to indicate a sentence that is a status report of current settings or a configuration command changing settings. This field should not be null.  
 "R" = sentence is a query response,  
 "C" = sentence is a configuration command to change settings.

### 10.2.3 ACF - General AtoN Station configuration

This sentence and the ACE sentence are used to configure Message 21 content for the AtoN Station and all of the Synthetic/Virtual AtoN Stations associated with the AtoN Station.

**\$--ACF,xxxxxxxx,x,IIII.IIII,a,yyyyy.yyyy,a,x,xxxx,xxxx,xxxx,xxxx,x,xx,x,a\*hh<CR><LF>**

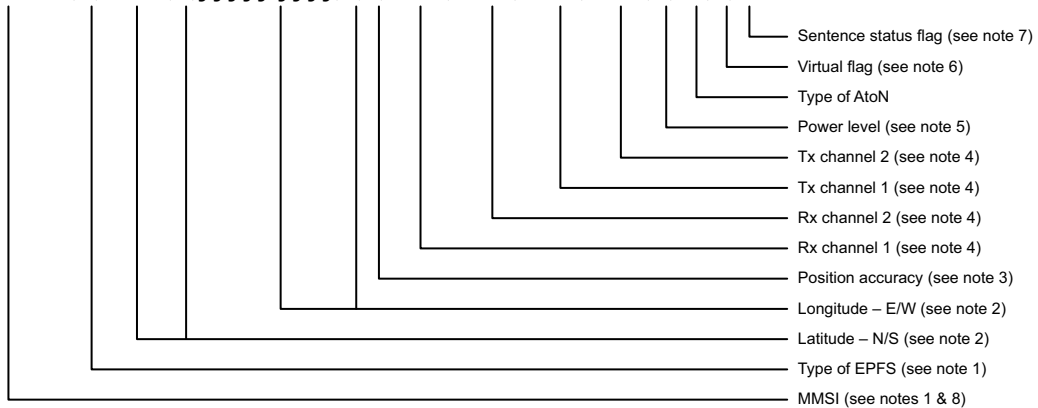

- Note 1 Identifies the source of the position, see ITU-R M.1371 Message 21 parameter (type of electronic position fixing device).
- Note 2 Nominal or charted position.
- Note 3 0 = low > 10 m,  
1 = high < 10 m; differential mode of DGNSS. VHF channel number, see ITU-R M.1084.
- Note 4 VHF channel number, see ITU-R M.1084.
- Note 5 0 = default manufacturer power level (nominally 12,5 W),  
1 to 9 as defined by the manufacturer.
- Note 6 Virtual AtoN flag  
0 = Real AtoN at indicated position (default),  
1 = Virtual AtoN,  
2 = Synthetic AtoN (flag remains 0 in message 21 but the repeat indicator must be > than 0).
- Note 7 This field is used to indicate a sentence that is a status report of current settings or a configuration command changing settings. This field should not be null.  
"R" = sentence is a query response,  
"C" = sentence is a configuration command to change settings.
- Note 8 The MMSI/Message ID/Message ID Index are used to reference a table of messages loaded using MPR/ACF/ACE. This sentence defines the broadcast schedule for each message. Each message in this table is referenced by the combination of MMSI, Message ID and Message ID Index.

### 10.2.4 AFB - Forced broadcast

This sentence is used to force a transmission of the indicated VDL message, this message is already known to the AIS AtoN Station through AAR/MPR or ACE/ACF/AAR configuration commands.

**\$--AFB,xxxxxxxx,xx,xx,xx,xx,xxxx,x,a\*hh<CR><LF>**

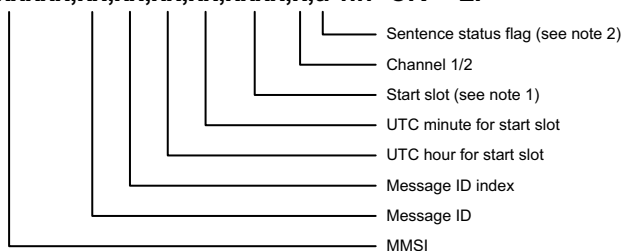

Note 1 If the start slot is null, the AtoN Station will use RATDMA for transmission.

Note 2 This field is used to indicate a sentence that is a status report of current settings or a configuration command changing settings. This field should not be null.  
 "R" = sentence is a query response  
 "C" = sentence is a configuration command to change settings.

### 10.2.5 AFC - AtoN function ID capability

This sentence is used to provide the capability information of implemented function ID by the EUT. This sentence is initiated with a QAFC and the response is the AFC.

**\$--AFC,xxxxxxxx, hhhhhhhhhhhhhhh\*hh<CR><LF>**

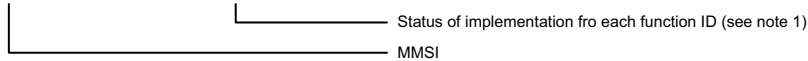

Note 1 Each bit corresponds to the function ID number and the bit value "0" indicates the function ID number is not supported and "1" indicates supported. The most significant bit is function ID "0".

### 10.2.6 AID - MMSI configuration

This sentence is used to load, for an AtoN Station, its Real, Virtual and chained MMSI(s). The MMSI from the factory shall be as defined by the manufacturer. Each AtoN Station will maintain a table of its MMSI(s) and the messages associated with these MMSI(s). This sentence is also user to load the destination MMSI for addressed messages. To set the destination MMSI using this sentence set the 'Virtual, Real or Chained' field to 0. Note that only one destination MMSI can be configured

**\$--AID,xxxxxxxx,x,xxxxxxxx,a,a\*hh<CR><LF>**

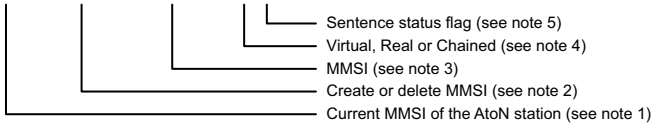

Note 1 The MMSI of the station being addressed. The initial factory setting should be defined by the manufacturer, for example 000000000.

Note 2 The indicator to define if the MMSI is being created/changed (1) or deleted (0). If own station MMSI is deleted it should revert to the factory setting. If a Virtual AtoN is deleted, then all associated messages for that Virtual AtoN are also deleted.

Note 3 The current MMSI to be created/changed/or deleted.

Note 4 Real AtoN, chained, or Virtual AtoN – Real is own station, chained indicates an MMSI that this station is responsible for relaying messages to and from, a Virtual AtoN indicates an MMSI that this station is responsible for generating at least a Message 21.  
 "R" – Real AtoN;  
 "V" = Virtual/Synthetic AtoN;  
 "P" = parent AtoN in the chain;  
 "C" = child AtoN in the chain.  
 "0" = Set destination MMSI for addressed messages.

Note 5 This field is used to indicate a sentence that is a status report of current settings or a configuration command changing settings. This field should not be null.  
 "R" = sentence is a query response,  
 "C" = sentence is a configuration command to change settings.

### 10.2.7 AKE - Configure encryption key

This sentence assigns the encryption key that will be used by the AES algorithm to communicate configuration and status information via the VDL. This sentence allows for the entire 128 bit encryption key to be entered, the user must know the current encryption key. The initial encryption key, when shipped from the manufacturer, will be all 0's.

**\$--AKE,xxxxxxxx,c--c, c--c,a\*hh<CR><LF>**

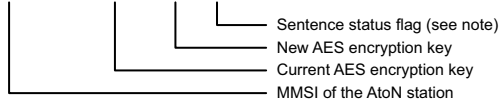

- Note 1 This field is used to indicate a sentence that is a status report of current settings or a configuration command changing settings. This field should not be null.  
 "R" = sentence is a query response,  
 "C" = sentence is a configuration command to change settings.

### 10.2.8 ARW -Configure the receiver turn-on times

This sentence defines the operational period for the receivers. When chaining the duration of receiver wake up time must be sufficient to allow correct operation of a chain.

**\$--ARW,xxxxxxxx,x,xx,xx,xxx,xxxx,a\*hh<CR><LF>**

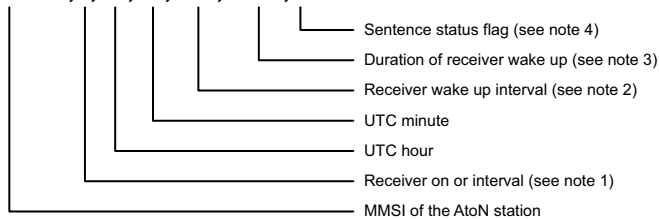

- Note 1 0 = use interval setting as defined below;  
 1 = turn receiver on.
- Note 2 Interval between receiver activation:  
 1 – 60 min if UTC hour is set to 24;  
 1 – 256 h if UTC hour is 0- 23;  
 (Note: 168 h is once per week).
- Note 3 Maximum awake time (1 440 min is 24 h).
- Note 4 This field is used to indicate a sentence that is a status report of current settings or a configuration command changing settings. This field should not be null.  
 "R" = sentence is a query response,  
 "C" = sentence is a configuration command to change settings.

### 10.2.9 MCR - Configure proprietary AtoN control

The payload of this sentence will be proprietary information used to control the AtoN Station.

**\$--MCR,xxxxxxxx,c--c,a\*hh<CR><LF>**

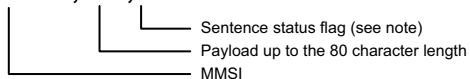

- Note 1 This field is used to indicate a sentence that is a status report of current settings or a configuration command changing settings. This field should not be null.  
 "R" = sentence is a query response,  
 "C" = sentence is a configuration command to change settings.

### 10.2.10 MPR - Message configuration of payload re-broadcast

This message will be used to command the AIS AtoN Station to rebroadcast the payload or to define a new message for autonomous, continuous transmission. The AAR configuration with message ID/message ID index for a specific MPR must precede the MPR to identify it as autonomous continuous transmission. If it is a single transmission, this payload will be broadcast using the slots reserved by the AAR with message ID/message ID Index = 0, or it will use the next available slot.

**\$--MPR,xxxxxxxx,xx,xx,x,xx,xx,c--c,a\*hh<CR><LF>**

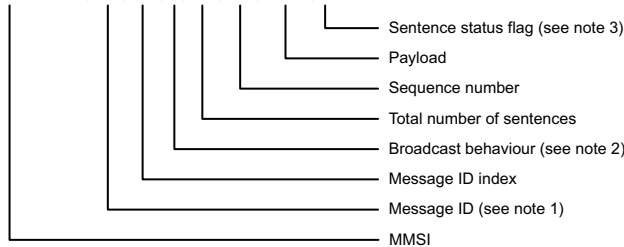

- Note 1 The following messages are supported by ITU-R M.1371 Messages 6, 8, 12, 14, 25, 26 and other appropriate messages.
- Note 2 0 = use AAR definition,  
1 = use next available slot.
- Note 3 This field is used to indicate a sentence that is a status report of current settings or a configuration command changing settings. This field should not be null.  
"R" = sentence is a query response,  
"C" = sentence is a configuration command to change settings.

### 10.2.11 TSP - Transmit slot prohibit

This sentence is used to prohibit an AIS station from transmitting in the specified slots. The AIS Station receiving this sentence should not use the next occurrence of the indicated slots. This sentence is designed to be used to protect interrogation responses from interference from Base Station transmissions and for use with AtoN Stations. For an AtoN Station the Unique Identifier is the AtoN Station Real MMSI.

**\$--TSP,c--c,x.x,x,HHMMSS.SS,x.x,x.x,x.x,x.x,x.x,x.x,x.x,x.x,a\*hh<CR><LF>**

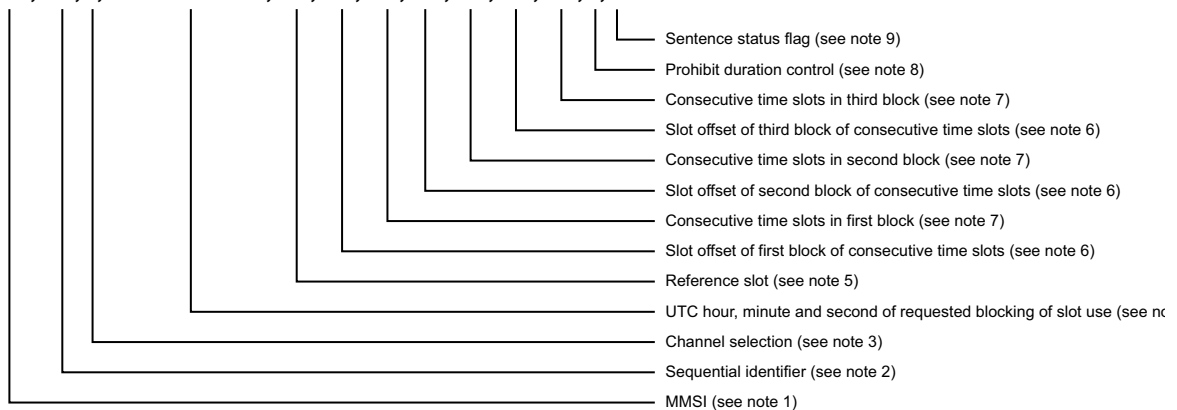

- Note 1 The MMSI is defined in the AID sentence and is the MMSI of the Real AtoN.
- Note 2 The sequential identifier provides an identification number from 0 to 99 that is sequentially assigned and is incremented for each new TSP sentence. The count resets to 0 after 99 is used. This sequential identifier is used to identify the Base Station's response to this TSP-sentence when it replies with a slot prohibit status report (see TSR-sentence).
- Note 3 1 = Channel 1,  
2 = Channel 2.
- Note 4 This is for record keeping. It contains the hour, minute, and second of this request.
- Note 5 This is the slot from which the following slot offsets are referenced.
- Note 6 Slot offset of the first slot in the block of slots to be blocked from use by the Base Station. 0 indicates no prohibited slots.

- Note 7 Total number of consecutive slots to be blocked from use by the Base Station. The first slot of the block is also part of the count. Therefore, the minimum value is 1.  
1-5 = number of prohibited slots.
- Note 8 This field is used to control the prohibited slots. This field should not be null.  
C = immediately restore for use all slots currently prohibited from use,  
E = the slot prohibition expires for the slots identified in this sentence after their next occurrence,  
P = prohibit the use of slots identified in this sentence. Slots are restored for use using "C" or "R",  
R = restore the use of slots identified in this sentence.
- Note 9 This field is used to indicate a sentence that is a status report of current settings or a configuration command changing settings. This field should not be null.  
"R" = sentence is a query response,  
"C" = sentence is a configuration command to change settings.

## 10.2.12 VER - Version

This sentence is used to provide identification and version information about a talker device. This sentence is produced either as a reply to a query sentence. The contents of the data fields, except for the unique identifier, should be manufactured into the talker device. The unique identifier is the AtoN Station Real MMSI. In order to meet the 79-character requirement, a "multi-sentence message" may be needed to convey all the data fields.

**\$--VER,x,x,x,aa,c--c,c--c,c--c,c--c,c--c\*hh<CR><LF>**

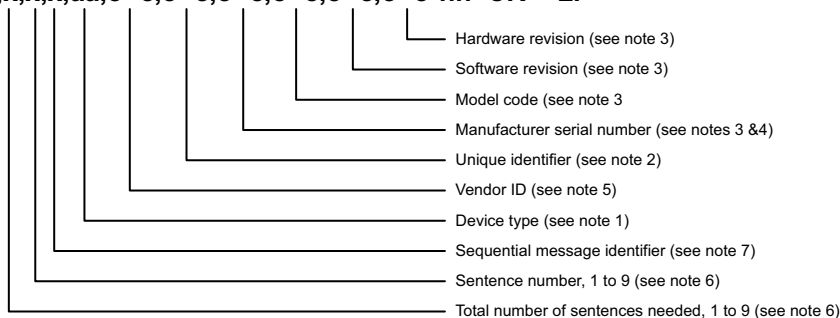

- Note 1 The device type is used to identify the manufactured purpose of the device. Choice of the device type identifier is based upon the designed purpose of the device. It is set into the equipment based upon the primary design of the device and remains constant even if the user defined talker identifier feature is used (see BCF-sentence). For AIS device types, use one of the following talker identifier mnemonics:  
AB: independent AIS Base Station;  
AD: dependent AIS Base Station;  
AI: mobile class A or B (see IEC 61993-2 and IEC 62287-1) AIS station;  
AL: limited AIS Base Station;  
AN: AIS aids to navigation station;  
AR: AIS receiving station;  
AS: AIS physical shore station;  
AT: AIS transmitting station;  
AX: AIS simplex repeater station;  
DU: duplex repeater station;  
UP: microprocessor controller;  
U#: (0 ≤ # ≤ 9) user configured talker identifier.
- Note 2 The unique identifier is used for system level identification of a station, 15 alphanumeric character maximum. For an AtoN Station, this is the Real AtoN MMSI number.
- Note 3 The data field length may be 32 characters maximum. The length of 32 characters is chosen in order to be consistent with similar data field lengths in the IEC 61162 standard. When large character lengths are used and the 80 character sentence limit would be exceeded for a single sentence, a series of successive VER sentences should be used to avoid the problem (using data fields 1 and 2 to ensure the multiple VER sentences are properly associated by the listener). Null fields can be used for data fields contained in other sentences of the series. Every VER sentence shall contain the unique identifier.
- Note 4 The manufacturer's serial number for the unit. Note, this "internal" manufacturer's serial number may or may not match the physical serial number of the device.
- Note 5 Vendor identification.
- Note 6 Depending on the number of characters in each data field, it may be necessary to use a "multi-sentence message" to convey a "VER reply." The first data field specifies the total number of sentences needed, minimum value 1. The second data field identifies the sentence number, minimum value 1.

Note 7 The third data field provides the sequential message identifier. The sequential message identifier provides a message identification number from 0 to 9 that is sequentially assigned and is incremented for each new multi-sentence message. The count resets to 0 after 9 is used. For a VER reply requiring multiple sentences, each sentence of the message contains the same sequential message identification number. It is used to identify the sentences containing portions of the same VER reply. This allows for the possibility that other sentences might be interleaved with the VER reply that, taken collectively, contain a single VER reply. This data field may be a null field for VER replies that fit into one sentence.

### 10.3 Proprietary configuration sentences

The following section documents the proprietary NMEA0183/IEC61162 sentences used for AIS AtoN configuration and control. These sentence relate mainly to configuration of data capture and integration with external equipment.

#### 10.3.1 Status Bit Source

The MCR SBS command is used to set the source for the AtoN status bits which are transmitted in AIS AtoN position reports (message #21). Refer to sections 6.1.1 and 6.1.3 for further information on the available interfaces for status information.

**\$--MCR,xxxxxxxx,SBS,x,a\*hh<CR><LF>**

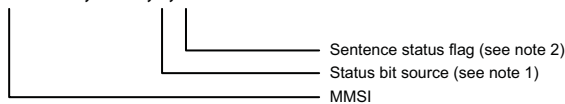

- Note 1 Status bit source is either:  
 0 = ACE sentence provides status bits  
 1 = Transceiver basic IO connections provide status bits  
 2 = Extended sensor interface provides status bits (applies only to variants including the extended

Note 2 This field is used to indicate a sentence that is a status report of current settings or a configuration command changing settings. This field should not be null.  
 "R" = sentence is a query response,  
 "C" = sentence is a configuration command to change settings.

#### 10.3.2 Status Bit Source Query

This command issued to query the transceiver for the current Status Bit Source configuration. The response will be in the format described in 10.3.1.

**\$--MCR,xxxxxxxx,Q,SBS,a\*hh<CR><LF>**

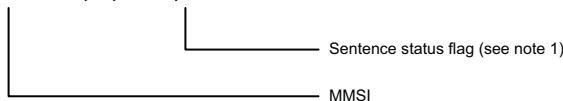

Note 1 This field is used to indicate a sentence that is a status report of current settings or a configuration command changing settings. This field should not be null.  
 "R" = sentence is a query response,  
 "C" = sentence is a configuration command to change settings.

#### 10.3.3 Lamp / RACON configuration

The MCR LRC command is used to configure the fixed status of a connected Lamp and / or RACON. This affects the setting of the related status bits transmitted in message #21.

**\$--MCR,xxxxxxxx,LRC,x,x,x,a\*hh<CR><LF>**

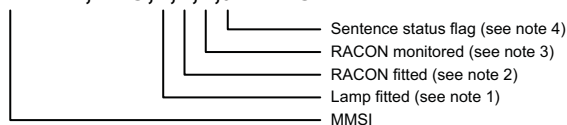

- Note 1 Set the lamp fitted status, 1 = lamp fitted, 0 = lamp not fitted  
 Note 2 Set the RACON fitted status, 1 = RACON fitted, 0 = RACON not fitted  
 Note 3 Set the RACON monitored status, 1 = RACON monitored, 0 = RACON not monitored

Note 4 This field is used to indicate a sentence that is a status report of current settings or a configuration command changing settings. This field should not be null.  
 "R" = sentence is a query response,  
 "C" = sentence is a configuration command to change settings.

### 10.3.4 Lamp / RACON configuration query

This command issued to query the transceiver for the current Lamp / RACON configuration. The response will be in the format described in 10.3.3.

**\$--MCR,xxxxxxxx,Q,LRC,a\*hh<CR><LF>**

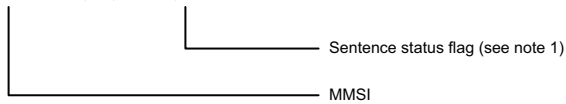

Note 1 This field is used to indicate a sentence that is a status report of current settings or a configuration command changing settings. This field should not be null.  
 "R" = sentence is a query response,  
 "C" = sentence is a configuration command to change settings.

### 10.3.5 General MCR query

**\$---Q,MCR\*hh**

This query command will return all the MCR commands as used for direct transceiver configuration.

A general query for MCR using **\$--Q,MCR** will also return ACQ (Acquisition Configuration) information for all messages. This is used as part of the configuration of a complete AtoN that includes a sensor module; the information within the ACQ details the acquisition time the sensor module needs from the transceiver before a transmission is going to take place, thus allowing the sensor module sufficient time to collect and average data as required for a transmission.

When the AIS Transceiver is not configured with a sensor module the ACQ data is not required but will still get displayed when queried.



## 11 Technical specification

---

### 11.1 Applicable equipment standards

IEC62320-2 Edition 1.0, 2008	Maritime navigation and radiocommunication equipment and systems – Automatic identification system (AIS) – Part 2: AIS AtoN Stations – Operational and performance requirements, methods of testing and required test results
ITU-R M.1371-4 April 2010	Technical characteristics for an automatic identification system using time-division multiple access in the VHF maritime mobile band
IEC61162-1 Edition 4.0, 2010	Maritime navigation and radiocommunication equipment and systems – Digital interfaces – Part 1: Single talker and multiple listeners
IEC61162-2 Edition 1.0, 1998	Maritime navigation and radiocommunication equipment and systems – Digital interfaces – Part 2: Single talker and multiple listeners, high-speed transmission
IEC61108-1 Edition 1.0, 2002	Global Navigation Satellite Systems (GNSS) –Part 1: Global positioning system (GPS) - Receiver equipment - Performance standards, methods of testing and required test results
IEC60945 2002	Maritime navigation and radiocommunication equipment and systems – General requirements – Methods of testing and required test results
SDI-12 Version 1.3, 2009	A Serial-Digital Interface Standard for Microprocessor-Based Sensors

### 11.2 AIS Transceiver specification

#### 11.2.1 Physical

Transceiver dimensions	288mm (height) x 180mm (maximum diameter), excluding bird deterrent. See also section 11.4.
Transceiver weight	1.3Kg excluding mounting bracket, cables and accessories.

#### 11.2.2 Environmental

Operating temperature range	-25°C to +55°C
Water ingress rating (enclosure)	IPx6 and IPx7
Water ingress rating (power and data connectors)	IP68 mated or unmated
Water ingress rating (RF connectors)	IPx6

### 11.2.3 Electrical

Nominal supply voltage	12 to 24VDC
Absolute min and max supply voltages	10 to 32VDC
Power consumption at 12VDC supply	Type 1 (FATDMA) with message #21 transmission every 3 minutes, 0.1Ah/day Type 3 (RATDMA) with message #21 transmission every 3 minutes, 1.0AH/day

### 11.2.4 Internal GPS

Receiver channels	50
Time to first fix (cold start)	<36 seconds
Frequency	L1 band, 1575.42MHz
Accuracy	2.5m CEP / 5.0m SEP without differential correction 2.0m CEP / 3.0m SEP with SBAS or RTCM DGPS correction
Antenna requirement	Internal antenna or active external antenna (3.3V bias) with gain >20dB

### 11.2.5 TDMA transmitter

Frequency range	156.025MHz to 162.025MHz
Channel bandwidth	25kHz
Output power	Configurable 1W, 2W, 5W or 12.5W
Data transmission rate	9600 bits/s
Modulation mode	25kHz GMSK

### 11.2.6 TDMA receivers

Number of receivers	2
Frequency range	156.025MHz to 162.025MHz
Channel bandwidth	25kHz
Sensitivity	<-107dBm for 20% PER
Modulation mode	25kHz GMSK
Adjacent channel sensitivity	70dB
Spurious response rejection	70dB

### 11.2.7 Supported AIS messages (transmission)

Message #6	Binary data for addressed communication
Message #8	Binary data for broadcast communication
Message #12	Safety related data for addressed communication
Message #14	Safety related data for broadcast communication

Message #21	Position and status report for aids-to-navigation
Message #25	Short unscheduled binary data transmission (Broadcast or addressed)
Message #26	Scheduled binary data transmission (Broadcast or addressed)

### 11.2.8 Connector types

Power and basic transceiver interfaces	Souriau UTS714D19PW32 with type W keying. Mating half UTS6JC14E19SW.
USB configuration	Souriau UTS78D4P32 Mating half is UTS6JC8E4S.
Extended sensor interfaces A	Souriau UTS714D19PW32 with type X keying. Mating half is UTS6JC14E19SX.
Extended sensor interfaces B	Souriau UTS714D19PW32 with type Y keying. Mating half is UTS6JC14E19SY.
VHF antenna	Female 'N' type co-axial connector.
External GPS antenna	Female TNC type co-axial connector.
Ground stud	M4 threaded stud

### 11.2.9 Transceiver data interfaces

USB	USB interface for configuration and diagnostics
NMEA0183 / IEC61162 / RS422	1x bi-directional RS422 level interface carrying IEC61162 sentences for configuration, diagnostics and sensor data interface (receiver optically isolated) 1x input only RS422 level interface configuration and sensor data interface (optically isolated)
Non-isolated digital I/O	6x 3.3V logic level I/O signals, Inputs 0 – 3 mapped to AtoN status bits in message #21.

### 11.2.10 Extended sensor interface specification **T1+S** **T3+S**

USB	USB interface for configuration and diagnostics
RS232	Two RS232 level interfaces for connection of external equipment*
NMEA0183 / IEC61162 / RS422	One fully optically isolated RS422 level interface for connection of external equipment
SDI-12	One SDI-12 compliant interface for connection of external sensors supporting the SDI-12 protocol*
Non-isolated digital I/O	5x non-isolated logic level I/O signals (3.3V logic levels)
Isolated digital inputs	5x optically isolated digital inputs, sensitivity 2.5V, max input voltage $\pm 15V$ .
Isolated analogue inputs	Two isolated analogue inputs. Range $\pm 13.75V$ , 16 bit resolution.
Non-isolated analogue inputs	Three non-isolated analogue inputs. Range $\pm 37.2V$ , 12 bit resolution.
Current sense loop	Lamp current sense loop, max 5A. Measurement of currents up to 0.5A with 12bit resolution.
Relay drive	2x relay driver outputs, max load 200mA at 60VDC.

\*Only one RS232 port is available when the SDI-12 interface is enabled.

### 11.3 Configuration interface specification

The transceiver is configured via a USB interface and compatible Virtual COM Port (VCP) driver. One VCP is created for the transceiver configuration interface and a second VCP for the extended sensor interface configuration port (if the extended sensor interface is present). A USB configuration cable is supplied with the transceiver.

All configuration is performed via the USB VCP using the standardised and proprietary IEC61162 sentences defined in section 10.2.

### 11.4 Drawings and dimensions

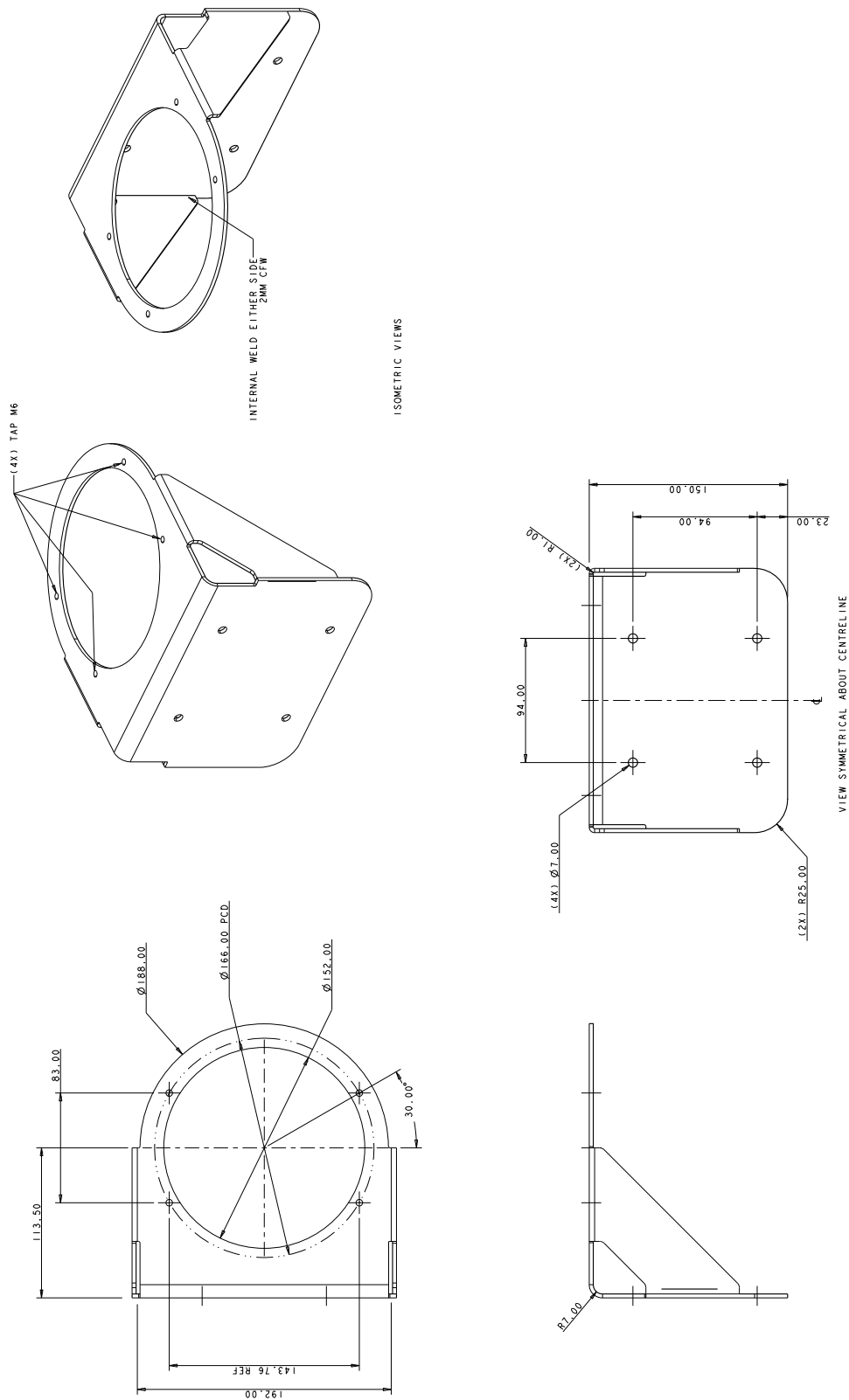

Figure 24 Transceiver mounting bracket dimensions

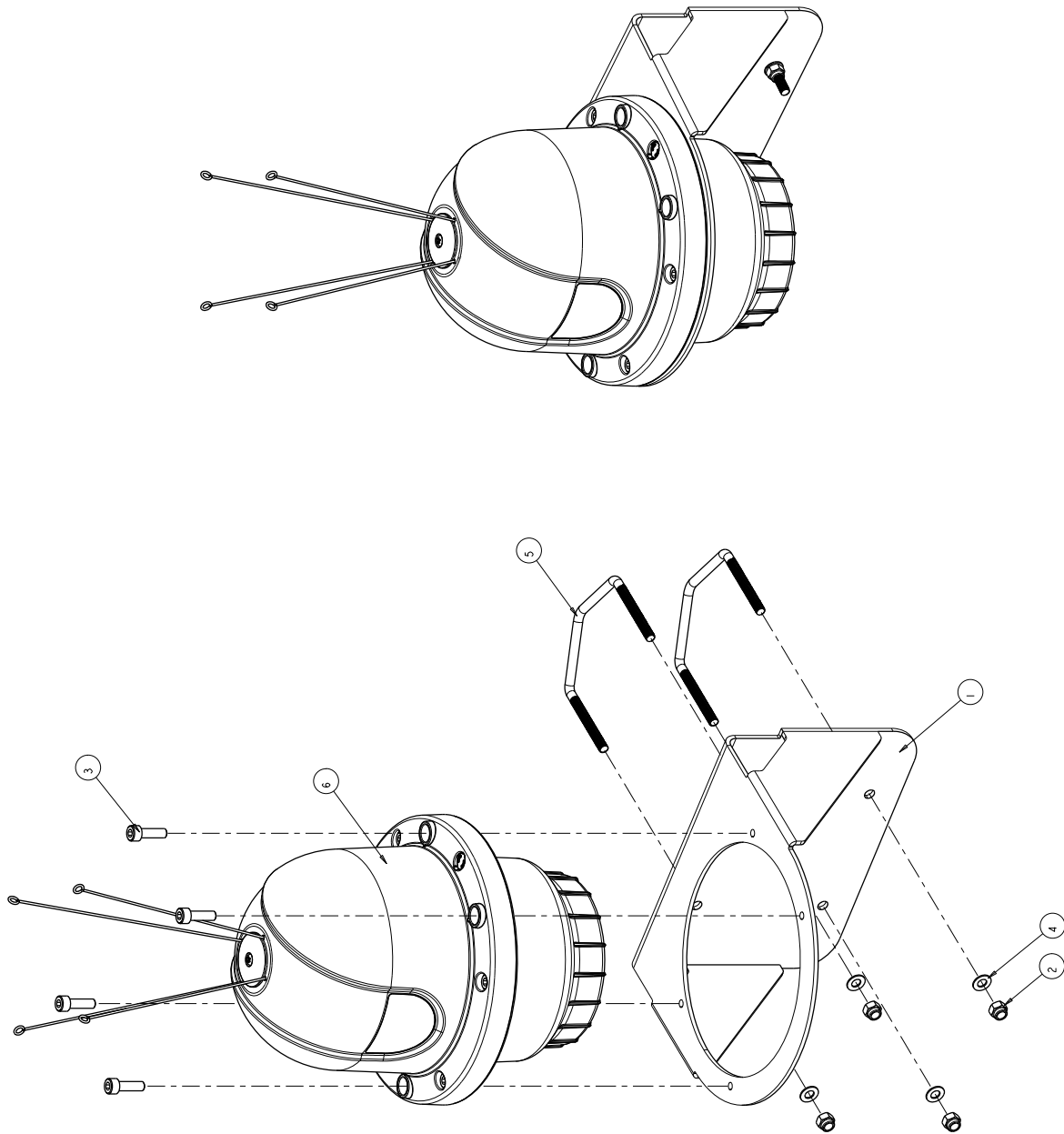

Figure 25 Transceiver general assembly

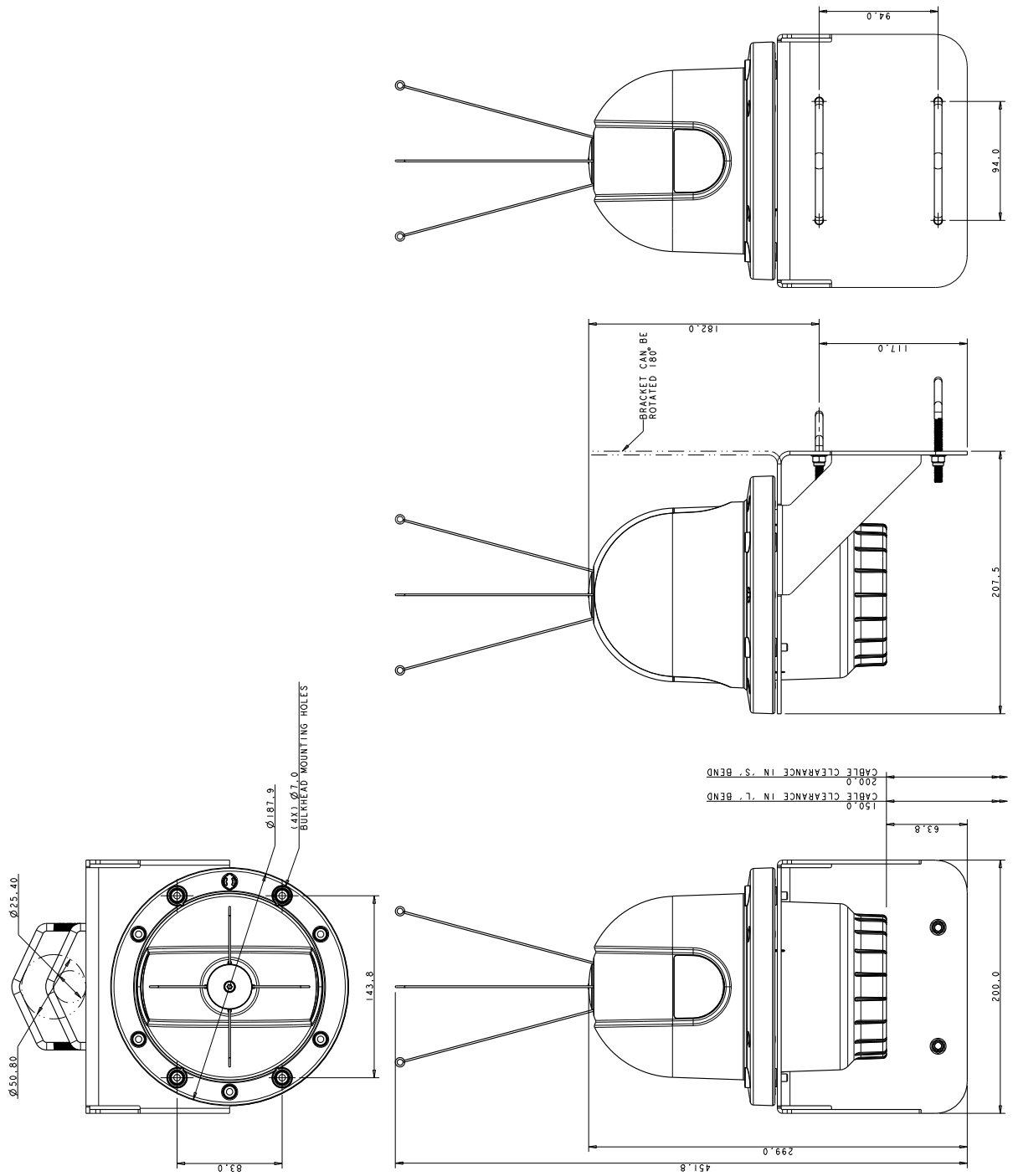

Figure 26 Transceiver dimensions

## 12 Firmware upgrade procedure **T1** **T1+S** **T3** **T3+S**

The transceiver firmware can be updated should a new version be made available. The firmware update is transferred to the transceiver using the USB interface. The pre-requisites for carrying out a firmware update are:

- AIS AtoN Transceiver, connected to a 12 or 24V power supply. The power supply must not be interrupted during the software update.
- The USB configuration cable supplied with the AIS AtoN transceiver
- A PC running Windows (XP, Vista, Windows 7) with a spare USB port
- Prior installation of the USB driver for the AIS AtoN transceiver.
- A software update file for the AIS AtoN transceiver (available from your supplier)
- The 'vxsend' PC software update utility (available from your supplier)

To update the firmware carry out the following steps:

1. Apply power to the transceiver and connect the USB configuration cable to the transceiver and PC
2. Install and run the 'vxsend' utility (screenshot shown in Figure 27)
3. Click the Browse (...) button for the Image file, then navigate to and select the appropriate update file.
4. Select the 'AIS NMEA Port' option and the virtual COM port associated with the transceiver. **Do not select the 'AIS USB Port' option.**
5. Select the 115200 baud rate option
6. Click 'Start' and wait for the update to complete. Notification is given when the update has completed successfully.
7. Power cycle the transceiver and confirm normal operation before it is deployed.

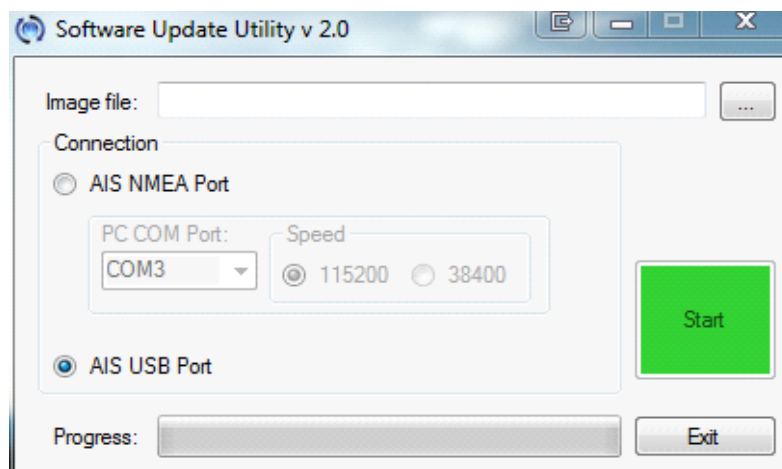

Figure 27 vxsend utility screenshot





