

# CRIMESTOPPER

## *SP-500 Alarm Combo System*

### INSTALLATION HANDBOOK:

#### INTRODUCTION

Congratulations on your choice of a Crimestopper combination alarm & remote engine starter with Data Port Technology

*This installation book is designed for the installer or individual with an existing understanding of automotive electrical systems, along with the ability to test and connect wires for proper operation. To ease installation, we suggest that you READ THIS MANUAL before beginning your installation. This book is provided as a GENERAL GUIDELINE and the information contained herein may differ from your vehicle.*

#### **DISCLAIMER:**

*Crimestopper Security Products, Inc. and its vendors shall not be liable for any accident resulting from the use of this product. This system is designed to be professionally installed into a vehicle in which all systems and associated components are in perfect working condition.*

TECHNICAL SUPPORT (800)-998-6880  
Monday - Friday 8:00am - 4:30pm Pacific Time

Website: [www.crimestopper.com](http://www.crimestopper.com)

CRIMESTOPPER SECURITY PRODUCTS, INC.  
1770 S. TAPO STREET  
SIMI VALLEY, CA. 93063

REV 12.2008

This device complies with FCC Rules part 15. Operation is subject to the following two conditions: 1) This device may not cause interference, and (2) this device must accept any interference that may be received, including interference that may cause undesired operation. The manufacturer is not responsible for any radio or TV interference caused by unauthorized modification to this equipment. Such modification could void the user's authority to operate the equipment.

# TABLE OF CONTENTS

|   |       |
|---|-------|
| <i>Cautions &amp; Warnings and Component Mounting</i> .....           | 3     |
| <i>Antenna Diagram</i> .....  | 4     |
| <i>Wiring Information</i> .....                                       | 5-11  |
| <i>Shock Sensor</i> .....   | 12    |
| <i>Power Door Lock Wiring, Systems &amp; Diagrams</i> .....           | 13-15 |
| <i>Tachless, Tach Reference, Tach Finder, Timed Crank Modes</i> ..... | 16-18 |
| <i>Diesel Glow Plug Delay</i> .....                                   | 19    |
| <i>Programmable Options, Options Reset</i> .....                      | 19-25 |
| <i>Remote Transmitter / Transceiver Programming</i> .....             | 26    |
| <i>2-Vehicle Operation</i> .....                                      | 27    |
| <i>Alarm Trigger Diagnostics</i> .....                                | 28    |
| <i>Remote Start Diagnostics</i> .....                                 | 28    |
| <i>Jumper Pin Diagram</i> .....                                       | 29    |
| <i>System Wiring Diagram, DATA Port Diagram</i> .....                 | 30-32 |

## PRE-INSTALLATION CONSIDERATIONS

**BEFORE BEGINNING**, check all vehicle manufacturer cautions and warnings regarding electrical service (AIR BAGS, ABS BRAKES, ENGINE / BODY COMPUTER AND BATTERY).

**PLAN OUT YOUR INSTALLATION.** You should pre-determine the location of the Control Module (Brain), Valet button, LED, and Siren locations. This will save time and ease the installation process.

**USE VOLT/OHM METER** to test and locate all connections. Test Lights or Lighted Probes could possibly damage a vehicle's computer system or cause an airbag to deploy.

**ADDITIONAL PARTS**, that are not included with this unit, may be needed for your particular vehicle. These items may include extra relays, Door Lock Interface Modules, or Transponder Override modules.

## CAUTIONS & WARNINGS

***DAMAGE RESULTING FROM IMPROPER INSTALLATION IS NOT COVERED UNDER WARRANTY!!***

**DO NOT** remote start your vehicle in a closed garage. Make sure that the garage door is open or there is adequate ventilation. Failure to observe this rule could result in injury or death from poisonous Carbon Monoxide fumes.

**DO NOT ROUTE ANY WIRING THAT MAY BECOME ENTANGLED** with the brake/gas pedals, steering column, or any other moving parts in the vehicle.

**REMOVE MAIN SYSTEM FUSE(S)** before jump-starting the vehicle or charging the battery at high boost. **DAMAGE MAY OCCUR TO SYSTEM IF PROPER PRECAUTIONS ARE NOT OBSERVED.**

**DO NOT** exceed the rated output current of any circuit on the Remote start module. Failure to observe this warning will result in damage to the unit. Output currents are listed where applicable throughout this manual.

**DO NOT** extend the Remote start ignition harness length. Mount the module so that main harness reaches all ignition switch wiring. Extending these wires could result in poor performance.

## COMPONENT MOUNTING

**CONTROL MODULE:** The alarm control module should be mounted in a concealed location. **DO NOT** mount the control unit in the engine compartment. Fasten the module to a bracket or wire harness using the cable ties provided.

**SIREN MOUNTING:** Mount the siren under the hood to fender-well or other body surface with the open end facing downward. Run the red siren wire through the firewall using a rubber grommet. Ground the black wire to the body metal near the siren.

**LED:** Mount the Blue LED in a visible location on the dashboard or console.

**SHOCK SENSOR:** Mount the included shock sensor with wire ties to an under dash wire harness or fasten with screws to firewall or side paneling.

**OVERRIDE/PROGRAM/VALET BUTTON:** Mount the Override/Program push-button in a hidden but accessible location. This button is required for emergency disarm, programming, and valet mode.

# ANTENNA DIAGRAM

**ANTENNA MODULE:** For optimum range and performance, the antenna/receiver module should be located high up on the front windshield glass. For example: behind the rearview mirror. Note: Window tints or Films may decrease the range of the system. The mounting surface for the antenna should be clean and dry.

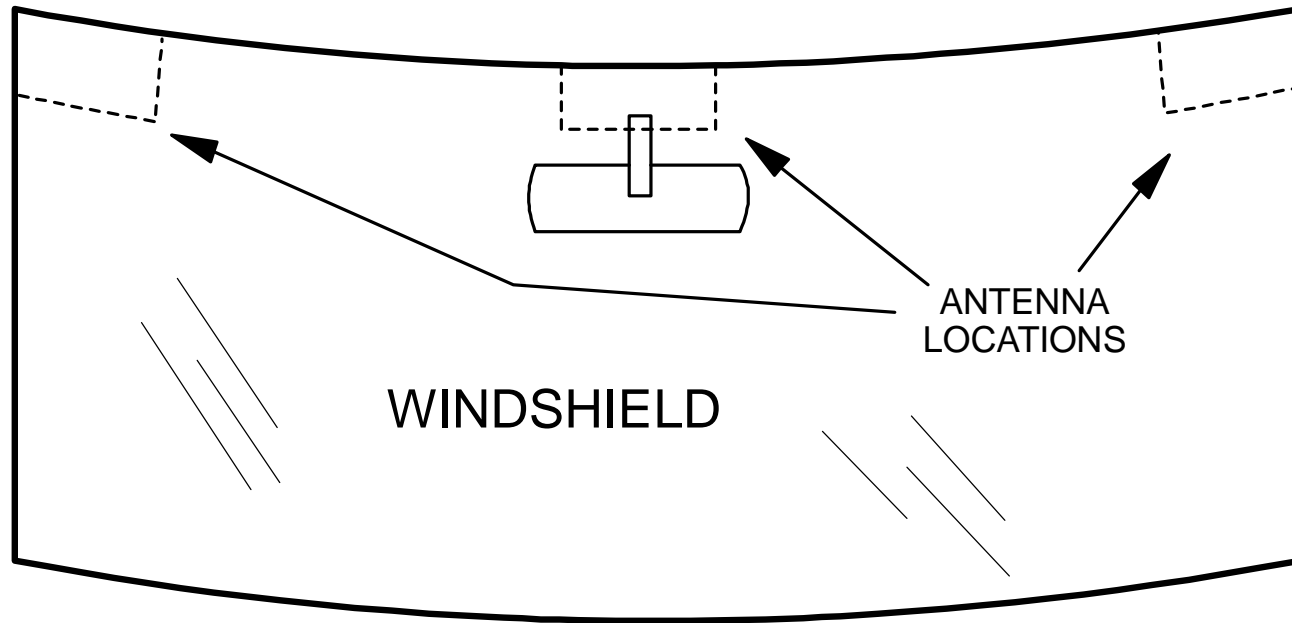

## WIRING: 9-PIN Connector

### Green: MODE A: (-) Start Activation Input

This wire allows an outside source or accessory to activate a Remote Start. A 1-second Ground pulse on this wire will trigger a remote start. This wire can be used with an RS-400 temperature module.

### Green: MODE B (-) Optional Turbo Timer Input

(3 Modes, Option #30) This wire allows the system to keep a vehicle running for 1-5 minutes [selectively] after removing the key. This mode

requires the use of a momentary switch that is not included with the kit. Connect a 2-pole momentary switch with one side to chassis Ground and the other side to the Green input wire. If you own a turbo or turbo diesel vehicle, you can now allow the system to keep your engine running for 1-5 minutes after exiting/locking your vehicle to cool-down without the need for an external "Turbo Timer". See operator's manual for more information.

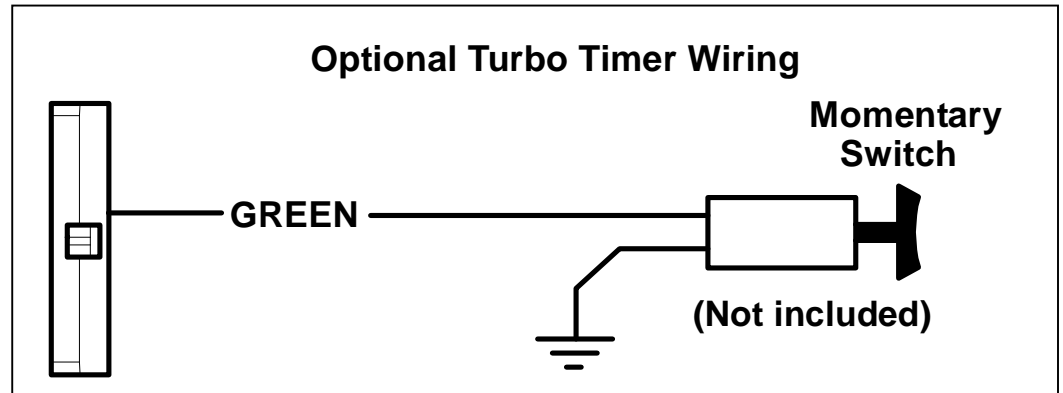

### Brown: (+) Siren Output

Connect brown wire to siren red wire. Connect black wire of siren to chassis ground (body metal).

### Brown/White: (-) 500mA Horn Honk Output (Optional, may require a relay)

Connect to the Negative Horn Trigger wire usually located near the steering column. If the vehicle horn circuit requires +12V, a relay is required. RELAY WIRING: Connect the Brown/White wire to terminal 85, connect relay terminals 86 and 87 to +12V constant power. Connect terminal 30 of the relay to the +12V positive device/circuit to be activated.

### Black/White: (-) 500mA Dome Light Illumination Output (Optional, Requires relay)

**Negative Dome Light System:** Connects to terminal 85 of a relay. Connect terminal 86 to +12V Constant. Connect terminal 87 to Chassis Ground. Connect Terminal 30 to the Negative dome light activation circuit.

**Positive Dome Light System:** Connects to terminal 85 of a relay. Connect terminals 86 & 87 to +12V Constant. Connect terminal 30 to the Positive dome light activation circuit.

## WIRING: 9-PIN Connector Cont.

### Green/Red: (-) 500mA Remote Aux. Output 1 (Programmable Option #10, requires relay)

This is a programmable output that can operate two different ways: 1 - (DEFAULT) Disarm with Remote Auxiliary Output that provides a ½ second (-) Negative pulse when Button #3 is pressed to open a Factory power trunk or hatch release. 2 - Remote Auxiliary Output without disarm

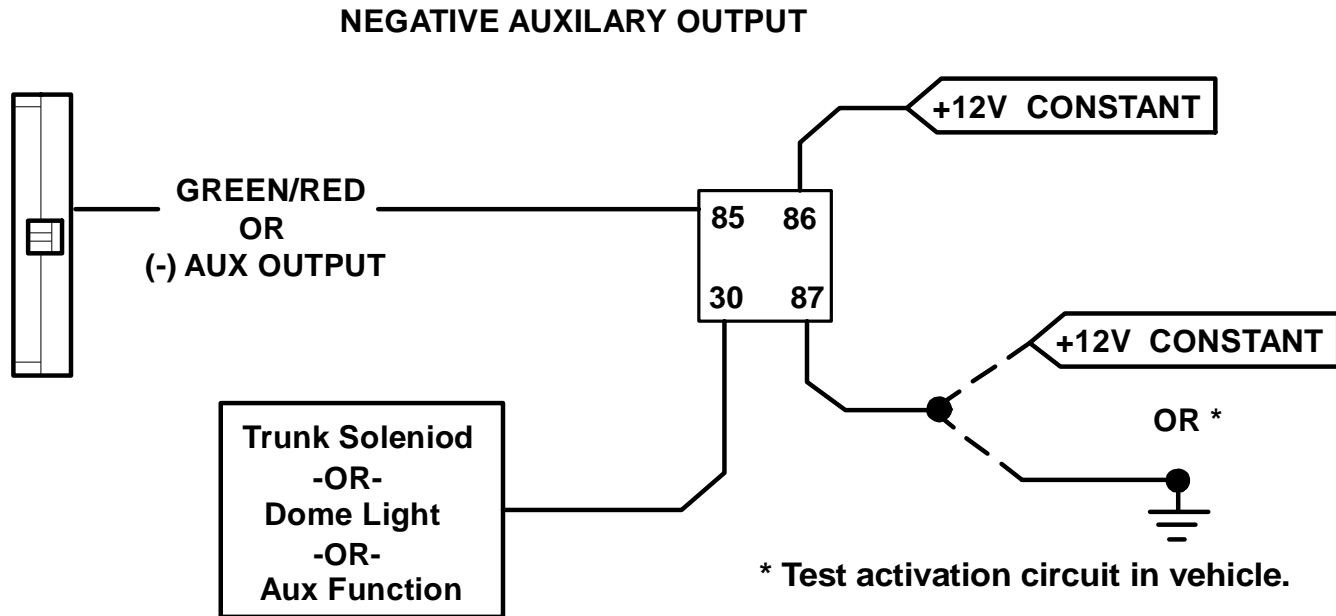

\* Test activation circuit in vehicle.

Connect to +12V for Positive circuits  
or Ground for Negative circuits. Relay  
not included.

### Blue/Black: (-) 500mA IGNITION OUT or REMOTE AUX. Output #2 (Programmable Option #17)

This wire functions as a Negative IGNITION OUTPUT (Ground while Remote Starting) for use when connecting factory Security Bypass modules or when an additional external Ignition Relay is required for your installation. This wire can be programmed to function as an AUXILIARY OUTPUT #2 providing a momentary (-) Negative output when Button #5 then #1 is pressed and held for more than 2 seconds. The Aux Channel #2 output stays on as long as the button is held down. Connect to the Negative activation circuit of an auxiliary module or device.

## WIRING: 9-PIN Connector Cont.

### Blue/White: (-) Passenger Door Unlock Output (Optional, requires relay)

This wire activates when the unlock button on the remote is pressed a second time within 15 seconds upon disarming. This wire is used for the Optional Separate Driver's/Passenger Unlock feature. Connects to unlock circuit for passenger door or doors. See DOOR LOCK WIRING for special configuration options (pages 13-15).

### Orange: (-) Negative Starter Disable/Anti-Grind Output

This wire should be connected to the Yellow wire of the pre-wired relay socket for the starter disable. Connect the blue wire of the relay socket to the Ignition switched wire on the vehicle. Cut the vehicle starter wire and connect each half to an Orange wire on the relay socket. This output also turns on with remote start to function as an "Anti Grind" wire to prevent the starter from grinding if you get in your car and turn the key too far after it was remote started. See starter disable diagram on next page.

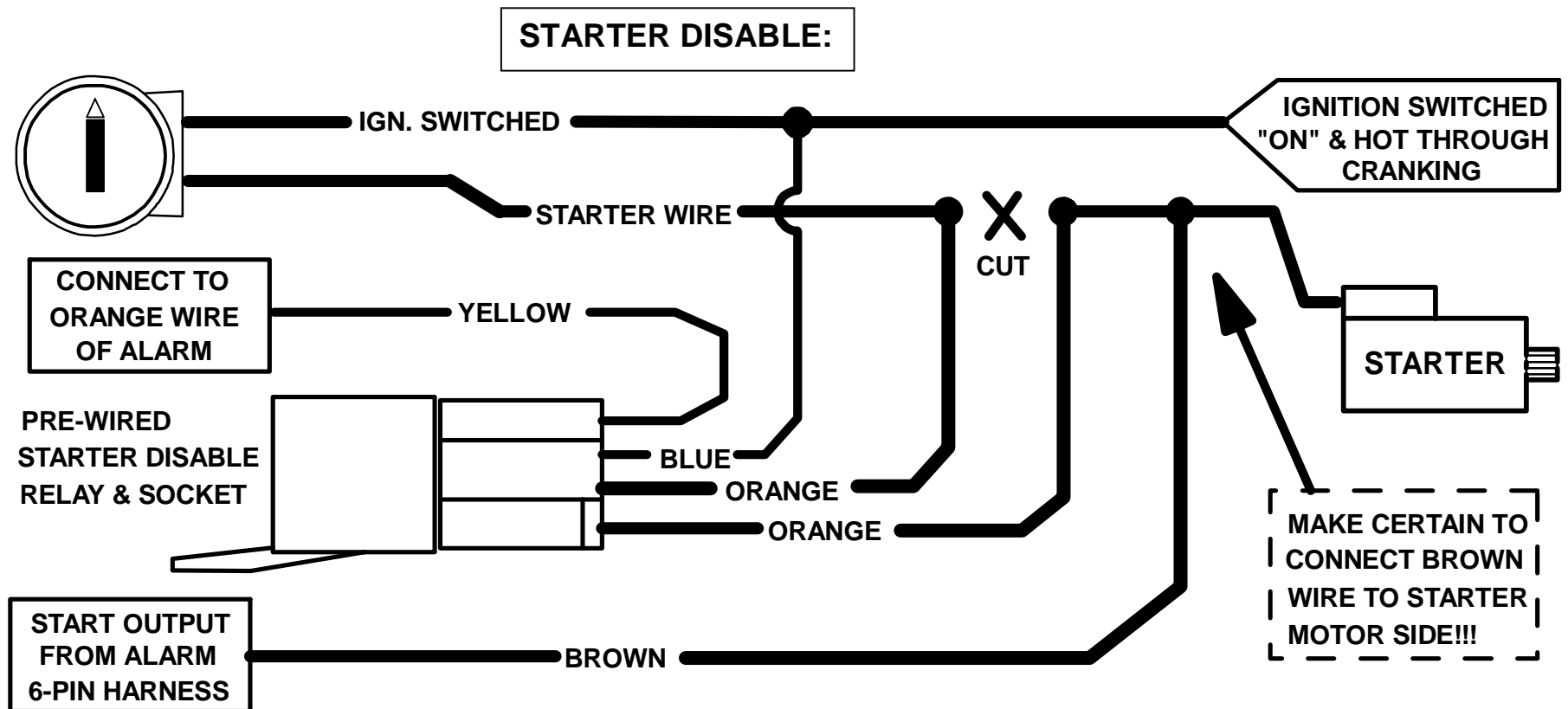

## WIRING: 9-PIN Connector Cont.

### Orange/Black: (-) OEM Disarm Output

This wire provides a Ground pulse to disarm the vehicles Factory Anti-Theft System prior to a Remote Start. Connect this wire to the vehicles' anti-theft disarm wire. This wire is sometimes found coming off the Driver's door key switch or at the Factory Anti-theft control module.

## WIRING: 3-PIN Connector

### White/Red: Tachometer Input

When installing this system in TACH REFERENCE mode, this wire must be connected to a valid source of AC voltage. This wire allows the unit to sense the engine running. See Tach Section on Page 16-18 for more information.

### Black: Chassis Ground

Connect to body metal of the vehicle using a sheet metal screw and a star washer to ensure a good ground. Keep the Ground wire short. Scrape away paint or debris from ground location.

### WHITE: 10 Amps +12 Volts or (-) 500mA NEGATIVE PARKING LIGHT OUTPUT:

Connect to vehicle parking light circuit at the back of light switch or if this is not possible, connect directly to one of the parking lights at the front of the vehicle. If your vehicle has a multiplex lighting system that requires a (-) Negative parking light output, then move the jumper from (+) to (-). See Jumper Pin Diagram (Pg. 29). Some European vehicles require separate left and right circuits. Use a dual relay or diodes to isolate the output.

**NOTES: (1) Default parking light output is +12 volts. (2) Use an external relay for vehicles that draw excess current from extra running lights, light bars, or trailers. Parking light output is limited to +10 or (-)0.5 AMPS.**

## WIRING: 6-PIN High Current Connector

|                    |  |
|--------------------|--|
| PIN 1: BROWN:      | STARTER OUTPUT (30A Max.)              |
| PIN 2: GRAY:       | ACCESSORY (HEAT/AC) (30A)              |
| PIN 3: RED:        | +12V POWER INPUT (BATTERY) FUSED (30A) |
| PIN 4: RED:        | +12V POWER INPUT (BATTERY) FUSED (30A) |
| PIN 5: PINK:       | IGNITION 1 (30A Max.)                  |
| PIN 6: PINK/WHITE: | START 2, IGN 2, ACC 2 OUTPUT (30 Max.) |

**NOTE! Use External Relays for High Current Ignition and/or Accessory circuits greater than 30A. Failure to do so could result in damage to the unit that is not covered under warranty.**



## WIRING: 5-PIN Connector (Trigger Inputs)

### **Violet: (+) Door Pin Switch Input**

Same as the GREEN wire below except this wire is used for vehicles that show a positive voltage (+12 volts) when the door is open and a ground when doors are closed as in many Ford, Lincoln, and Mercury vehicles.

### **Green: (-) Door Pin Switch Input**

Identify the wire that reads ground when any door is open and 12 volts when all doors are closed. Some vehicles may have isolated door triggers. In this case you may need to run additional wires from other doors or go directly to the wire that triggers the vehicle's interior dome light. Sometimes newer vehicles contain a separate body control module (BCM) where the door trigger circuit can be located. Most vehicles will NOT require the use of BOTH Green and Violet door trigger wires.

### **Blue: (-) Hood/Trunk Pin Switch Input**

Input trigger for a grounding hood or trunk pin switch. Connect to existing hood and trunk pin switches that read ground when open. If no existing switches are available, install new pin switches if desired. Note: DO NOT mount new pin switches in water pathways.

### **Pink: (+12V) +/- Diesel Glow Plug Input or Passive Carjack Input (Programmable Input Wire)**

**+/- Trigger:** See diagram (Pg. 29) for Jumper Pin Configuration.

#### **+/- Glow Plug Input (Diesel Vehicles Only)**

Connect Pink wire to indicator circuit that shows a (- or +) Signal while the "WAIT TO START LAMP" is on. When this wire is used, the system will wait until light turns off before attempting a remote start.

#### **Passive Carjack Trigger**

When using Carjack protection, connect this Pink wire to a (+ or -) toggle switch, or +12V ignition source depending on your level of Carjack protection. When +12V is applied to this wire *with the IGN on, then Carjack is armed*. If a door is opened then closed with ignition on, the Carjack countdown will begin. See Diagram Below for wiring configurations. DO NOT connect the Pink Carjack wire to Ignition unless there is extreme danger of a Carjack. When using the Ignition, Carjack is armed all the time and must be reset each time a door is opened and closed.

## WIRING: 5-PIN Connector

### OPTIONAL CAR JACK WIRING:

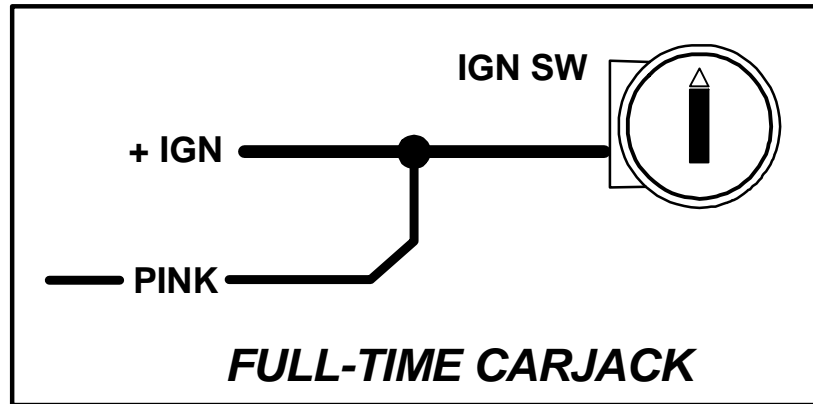
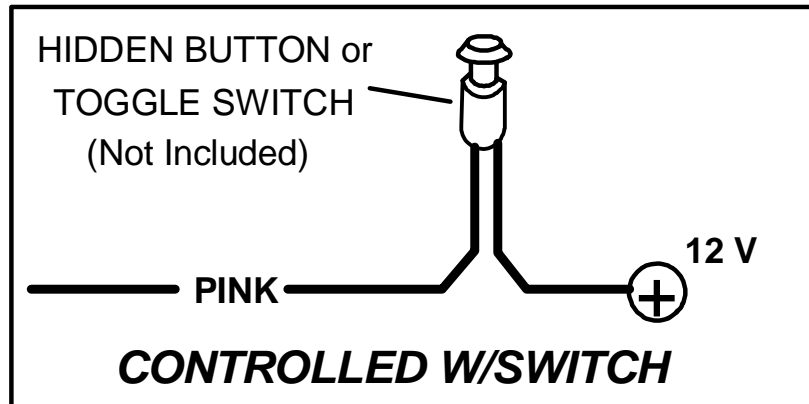

#### White: (+12V) Brake Reset

Connect the White wire to the side of brake pedal switch that shows +12 volts ONLY when pedal is depressed. This will turn off the remote start if someone attempts to drive the car without the keys or if the Ignition key is not turned on all the way.

## WIRING: 2-PIN LED / 2-PIN Program-Valet Button (22 gauge wires)

Mount LED in a visible location on the Dash or Console. Connect the small 2-pin plug from the LED to the control module. Note: Connectors are designed so that they will only plug into their appropriate slots.

Mount the Valet/Program/Override button in a suitable location. Connect the 2-pin plug from the Switch to the control module. Note: Connectors are designed so that they will only plug into their appropriate slots.

## WIRE: 4 PIN OUTPUT CONNECTOR

### YELLOW/BLACK: (-) OEM REARM OUTPUT

This wire provides a ground pulse to rearm the vehicles' FACTORY anti-theft system after a timed-out or aborted remote start. Connect this wire to the vehicles' anti-theft rearm wire or to the door pin circuit depending on your requirements. This wire may be needed to pulse the door pin circuit on vehicles with retained accessory power.

### BLUE/ORANGE: (-) STARTER #3

This wire provides a ground output for vehicle that requires a third starter wire to remote start.

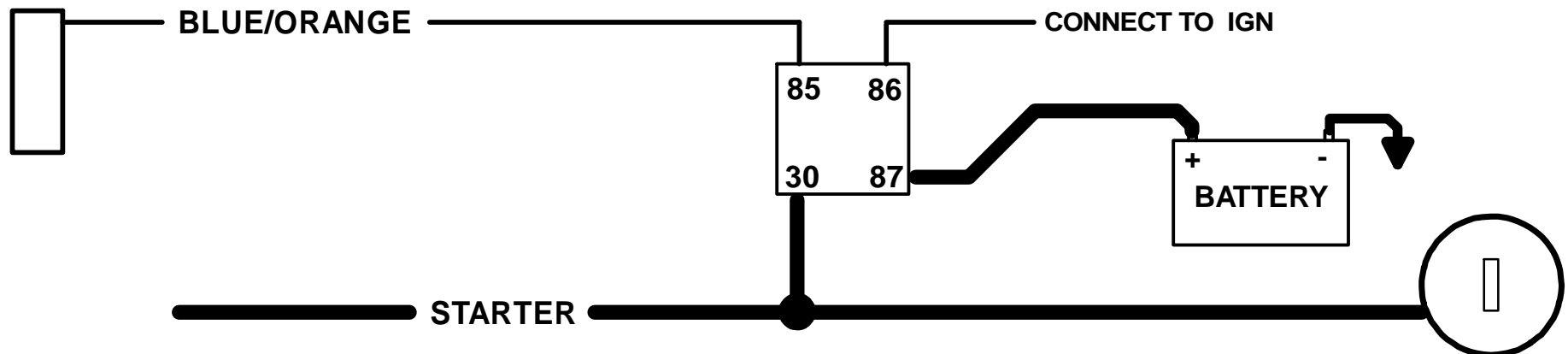

### VIOLET/WHITE: (-) AUX. 3

The Violet/White wire for a negative output for a Momentary, Pulse, Timed or Latched output, depending on option used. Option #26 and 27 controls these functions.

### GREEN/WHITE: (-) AUX. 4

The Green/White wire for a negative output for a Momentary, Pulse, Timed or Latched output, depending on option used. Option #28 and 29 controls these functions.

## WIRING: 4-PIN Shock Sensor (22 Gauge wires)

**SHOCK SENSOR:** The sensor supplied with this system does not require any additional wiring. Simply mount the sensor in a suitable location, plug it in, and adjust the sensitivity. There are 2 LED's on the shock sensor to assist you in adjusting sensitivity. The Blue LED indicates the "Warn Away" level and the Red LED indicates a full alarm shock sensor violation.

Use the adjustment knob to set the sensitivity of the sensor. The adjustment knob adjusts both Pre-Warn and alarm trigger.

# SHOCK SENSOR

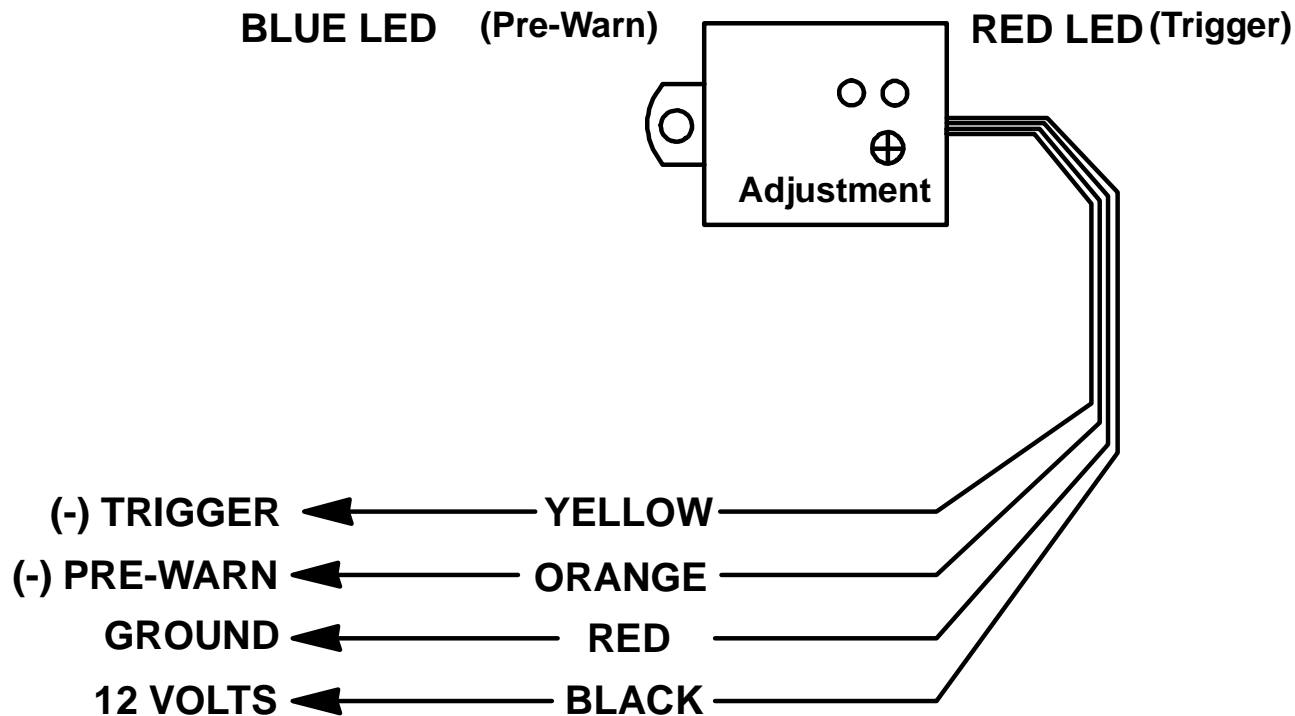

# POWER DOOR LOCKS: WIRING & SYSTEM TYPES

**PIN 1: BLUE:** (-) Negative pulse for UNLOCK

**PIN 2: RED:** 12V When using external relays (TERM 86)

**PIN 3: GREEN:** (-) Negative pulse for LOCK

**DETERMINING DOOR LOCK TYPE:** We recommend determining the type of locking system the vehicle has before connecting any wires. Incorrect connection may result in damage to the alarm and/or vehicle locking system.

Door lock information is provided as a guide. Your vehicle may be different.

## **Negative Trigger (-): Many Imports; Late model Ford & General Motors**

Negative trigger door lock systems send a Negative (Ground) pulse to existing factory relays to lock and unlock the vehicle doors.

## **Positive Trigger (+): Many General Motors; Chrysler / Dodge / Plymouth**

Positive trigger door lock systems send a Positive (12V) pulse to existing factory relays to lock and unlock the vehicle doors.

## **Reverse Polarity: Many Ford/Lincoln/Mercury/Dodge/Chrysler/Plymouth and early 90's GM Trucks**

Reverse Polarity systems use no relays, but instead the door lock/unlock motors are controlled directly from the lock and unlock switches in the door. The lock and unlock wires rest at Negative Ground when not in use. When the lock or unlock button is pressed, one of the circuits is "Lifted" and replaced with +12V causing a lock or unlock to occur.

## **Single Wire (Dual Voltage): Late model Chrysler/Dodge/Plymouth Vehicles, some 2000-UP GM**

Dual Voltage systems have lock/unlock switches that send varying levels of Positive voltage OR Negative ground current to the SAME wire for both lock and unlock. When the vehicle's Body Computer Module (BCM) or door lock module senses different voltages on this wire, the system will either lock or unlock. Single wire door lock systems require relays and resistors.

## **Databus Systems 2003-UP GM Trucks & SUV's, '96-04 Jeep Grand Cherokee**

Databus systems send low current "Data messages" to the door lock controllers on a network in order to lock and unlock the vehicle. To install aftermarket systems in these vehicles, an interface module is required that converts the regular lock/unlock pulses into "Data messages" to allow locking & unlocking. Interface modules are sold separately.

### **Crimestopper Door Lock Accessories:**

**CS-6600DLM:** Dual-relay plug-in module for Reverse Polarity, Positive, or Aftermarket Motors.

**CS-6500DLI:** Plug-in pulse inverter that converts the Negative outputs of the system to Positive type for Positive Door Lock systems.

**CS-610S1:** Aftermarket door lock actuator (motor).

# DOOR LOCK WIRING

## NEGATIVE TRIGGER DOORLOCK WIRING

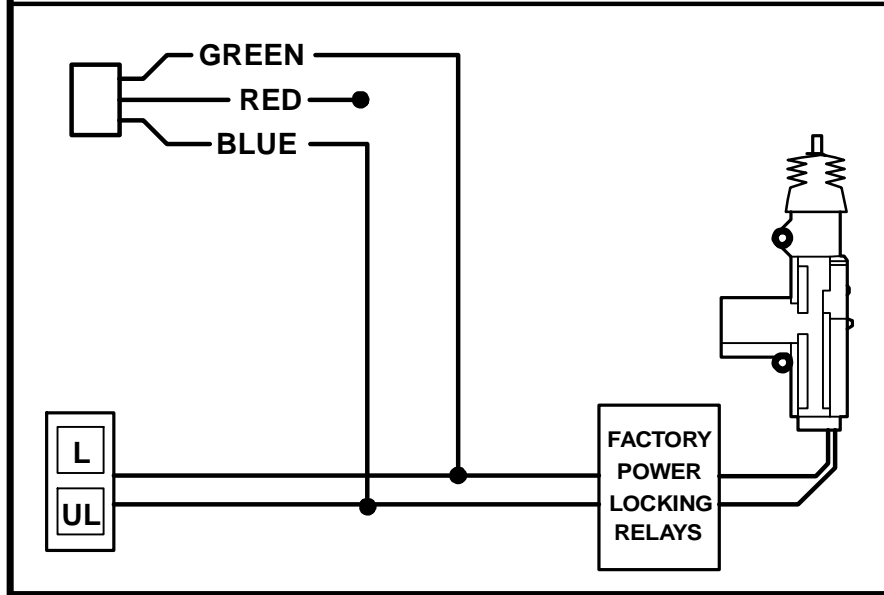

## POSITIVE TRIGGER DOORLOCK WIRING

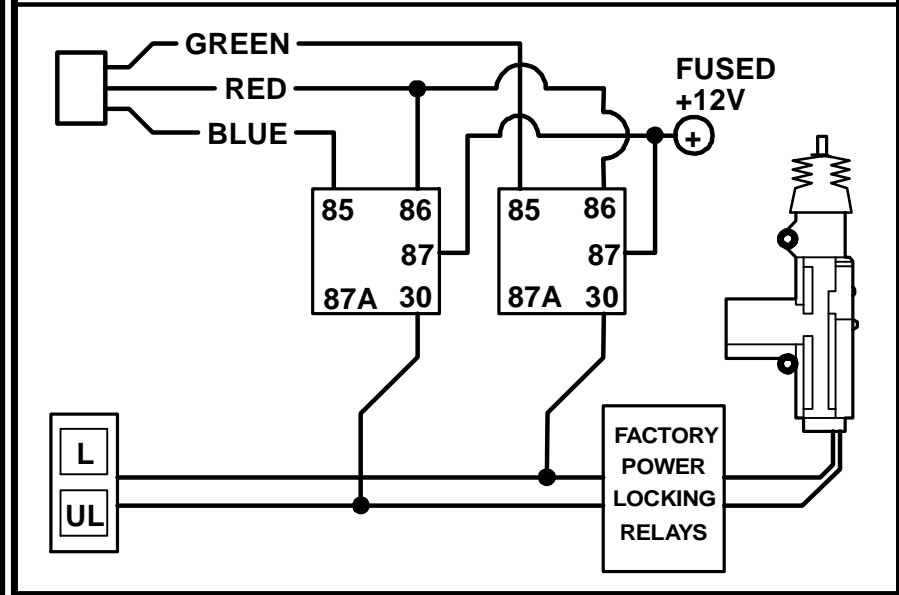

## REVERSE POLARITY DOOR LOCK WIRING

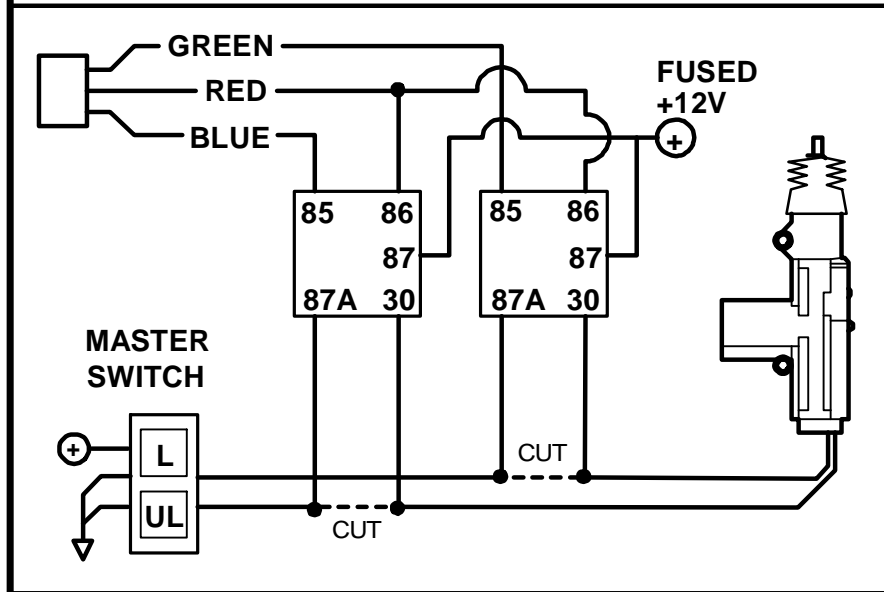

## AFTERMARKET MOTOR/DOOR LOCK WIRING

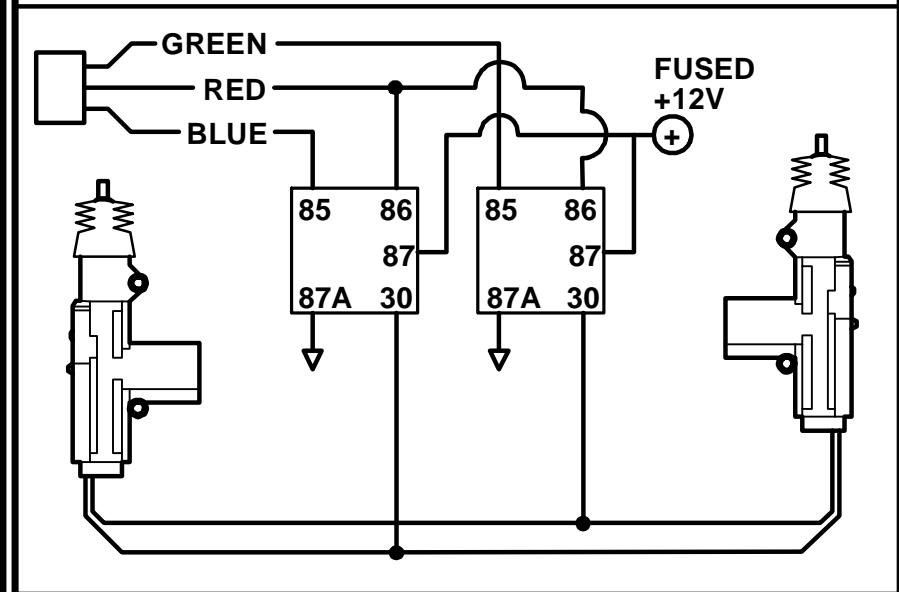

# SEPARATE DRIVER'S DOOR UNLOCK WIRING

## NEGATIVE TRIGGER DOOR LOCKS

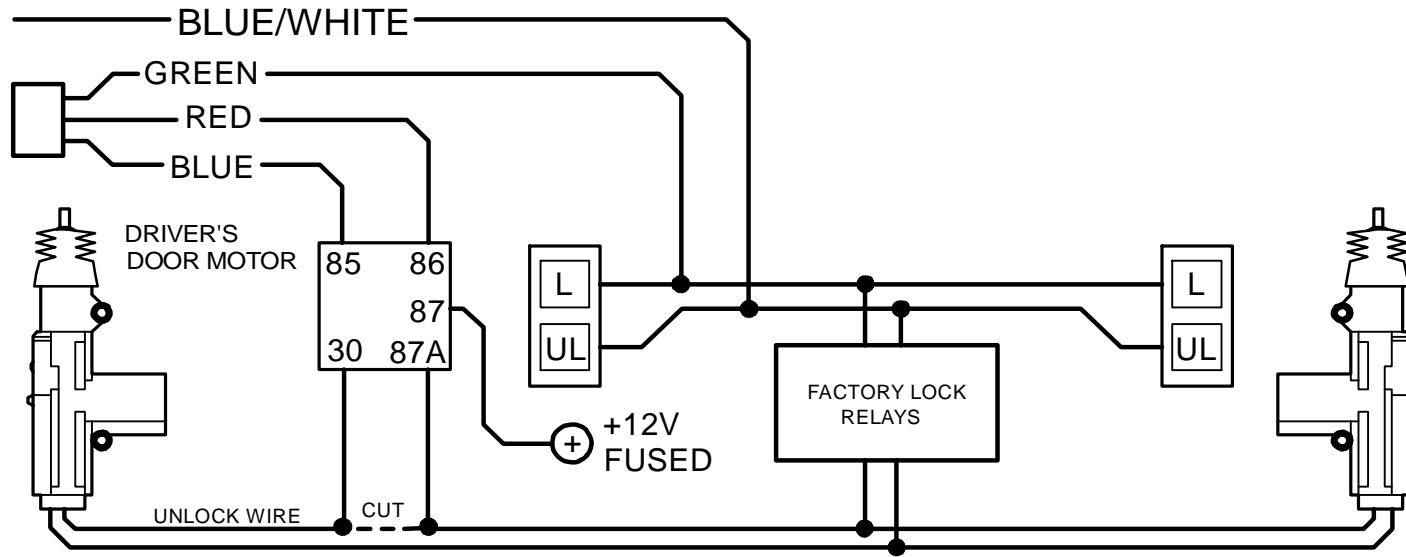

## WIRING FOR REVERSE POLARITY DOOR LOCKS

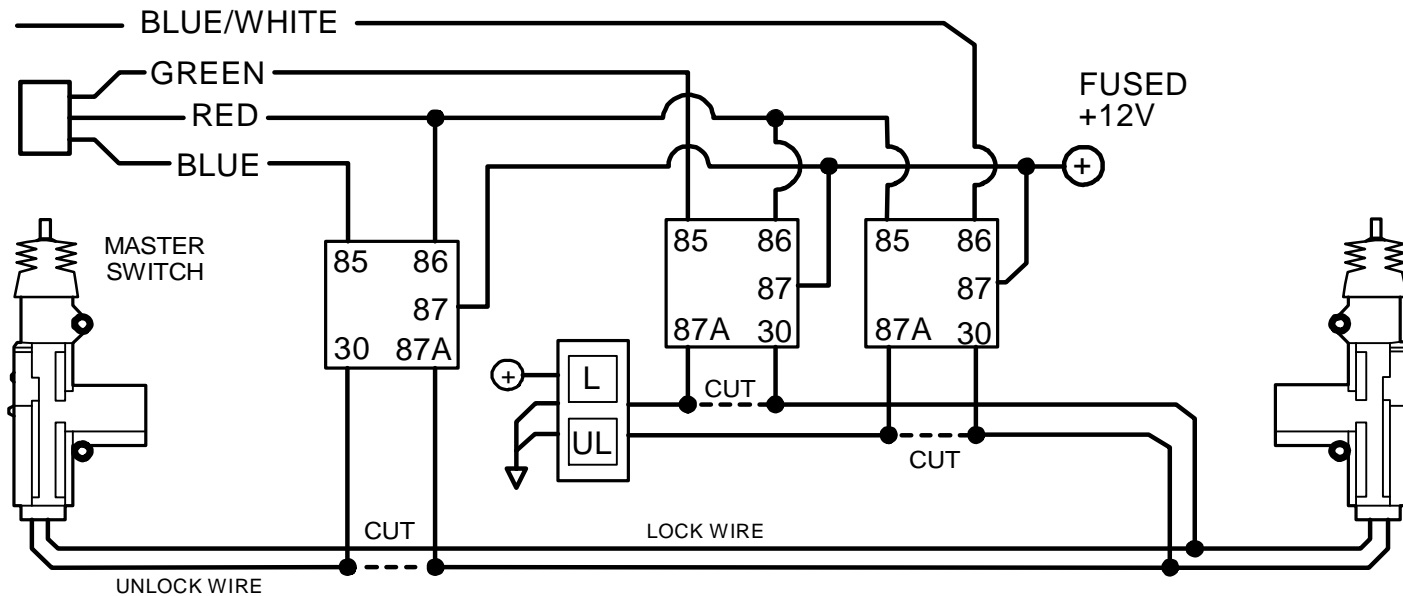

## TACHLESS MODE

Your system includes a Tach-less mode that actively monitors and compares the vehicle's resting voltage versus its running voltage each time a remote start is performed; [instead of the conventional tach-pulse method]. Smart Tachless mode adjusts automatically to maintain optimum efficiency over the life of the installation.

### **IMPORTANT NOTES:**

- (1) SETUP may be required for the Tachless Mode. If your vehicle has NOT been at rest for a period of time (Hot engine), then you must drain the surface charge from the battery. Unplug main power harness from system, turn HEADLIGHTS ON for 4 minutes to drain off excess surface charge on vehicle's battery then reconnect.
- (2) On the rare occasion that Tachless mode does not operate satisfactorily, change the voltage reference level as described below, or use a different mode such as "Tach Reference" mode, or "Timed Crank" mode.

### **TACHLESS ADJUSTMENT:**

In the event Tachless over-cranks or under-cranks your starter, the settings can be changed. The purpose of adjusting the "Smart Tachless" Mode is to raise or lower the voltage reference threshold from the 93% default point. Raising or lowering this 93% point should increase or decrease your cranking time respectively. You can adjust the range from 79% to 100% in one percent increments. Factory default setting [starting point] is in the middle at 93% which should work for most vehicles. If you feel you need to fine tune the Tachless mode, then follow the steps below to adjust its reference level.

1. Open hood (or ground the Blue hood pin wire if no hood pin is installed)
2. Turn the key to the ON position (do not start vehicle).
3. Press program button 5 times, after a few seconds the unit will flash the lights 5 times.
4. Carefully press the program button 24 times to get to option # 24. You must get a light flash after each press. If the lights didn't flash, then the unit did not register your button press. Only count the light flash.
5. Press the Lock Button #1 on the remote to decrease by 1% (lights will flash 1X for each press); Press the Unlock Button #2 to increase by 1% (lights will flash 2X for each press); Press the Trunk Button #3 to reset to 93% (lights will flash 3X). The unit will stop providing light flashes when you reach the bottom (79%) or the top (100%) of the adjustment range. If you lost track, then just press Button #3 to reset back to 93% and begin again.
6. Turn Ignition OFF, Close hood (or un-ground the Blue wire) and check operation.



## TACH MODE & TACH FINDER FEATURE

**Tach Reference Mode** provides reliable remote starting performance through engine speed sensing. When using Tach Reference Mode, the WHITE/RED wire is used for Tach signal [Engine RPM] input. Most modern engines include various points where the Engine Speed [Tach] or A/C signal may be obtained. Tach Signal examples: Negative (-) side of ignition coil, at the Distributor or Ignition Control Module, Coil Pack, Engine Computer, or Crankshaft Sensor. Sometimes Fuel injection solenoids and Alternator stator pins can be used. *These Tach Signal locations mentioned are provided as a guide, your vehicle may differ. Some locations will NOT be a good location for Tach source due to RF noise or Computer Data. Use the TACH FINDER feature if needed.*

### **TACH FINDER FEATURE:**

The Tach Finder mode can assist you in locating or verifying a Tach source for your installation. Follow the Tach Finder steps below to locate signal. The unit will begin to flash the parking lights if you have the White/Red wire connected to a valid tach source. If lights do not flash, then try another wire until you locate a tach signal that will cause the Parking lights to flash. **NOTE:** On vehicles equipped with daytime running lights, it may be difficult to see any flashing parking lights. In this case your only notification will be the slight “ticking” sound coming out of the module from the on-board flashing light relay.

### **TACH FINDER:**

1. Open hood (Ground the Blue hood pin wire if no hood pin is installed)
2. Start Engine with the key. (Pink ignition wire must be connected)
3. Press the Program button for 2 seconds
4. Lights will begin flashing if the White/Red wire is connected to a valid tach
5. Once Tach is located then turn off engine and close hood to abort.
6. See Tach Reference programming below.

### **TACH PROGRAMMING:**

1. Open hood (Ground Blue hood pin wire if no hood pin is installed).
2. Connect WHITE/RED wire to a valid Tach source.
3. Start engine with the key (Pink ignition wire must be connected).
4. Press program button 5 times, then wait for 5 light flashes.
5. Wait at least one second then push program button again (1) time, you should get a light flash with the button press. This unit is now at option #1 for Tach Learning.
6. Press the #1 Lock Button on remote transmitter to program Tach. **NOTE:** Pressing the Brake Pedal also programs Tach. *One Light Flash = Tach Mode. Two Light Flashes = Tachless Mode.*
7. If lights do not flash for confirmation, then try another tach source or try the tach finder feature above.

## TIMED CRANK MODE

As an alternative to Tach or Tachless mode, “Timed Crank” provides an additional method of starting the vehicle without locating an exact tach wire. It uses a timed cranking output combined with the use of the Red/White tach wire as an engine ON/OFF monitor. The Red/White Tach wire **MUST STILL** be used with this mode. **THIS FEATURE MUST BE PROGRAMMED BEFORE USE!** THERE ARE 2 LEVELS of programming required: First, set the system for “Timed Crank” operation, and secondly you may need to adjust the amount of cranking time. There are 4 different crank times available for use. SEE OPTION PROGRAMMING CHART FOR SETTINGS.

### HOW TO USE THIS FEATURE:

1. Go to the “Programmable Options” section, and set Option #16 to “Pre-Set”. (It is normally set to “Tach Monitor”)
2. With “Pre-Set” Cranking time turned ON, you will **STILL** have to connect the Red/White Tach wire to a tach source on the engine. The Red/White Tach wire becomes a simple “Engine Monitor”. Although the unit will not be using the Red/White wire to start the motor, it will be using this wire to determine whether the motor is running or not. This is a mandatory connection. A “crude” or “less exact” tach source can be used only when in “Time Crank” mode.
3. Using the vehicle key, start the engine to get a “feel” of how long the cranking time is. Once the “Timed Crank” mode is turned on, the default cranking time is set to a Default of 0.50 seconds. We recommend beginning with this setting. Try a remote start and see if the cranking is appropriate for your vehicle
4. If 0.50 seconds is not an appropriate starter cranking time, then go to Programming Option #21 and change the crank time setting to a longer value. The values are as follows: 0.5, 0.75, 1.0, and 1.5 seconds.

**WARNING:** This method of starting the vehicle is not as reliable as using regular “Tach” or “Ultra-Smart” Tachless modes. This method should be used only in the event that a tach wire cannot be located using the normal tach programming and tach finder. When using this method, there may be certain operating anomalies requiring seasonal adjustments. These are, but not limited to:

- Starter may under-crank in extreme cold weather. Vehicle may not start on 1<sup>st</sup> attempt and may require a 2<sup>nd</sup> try, 3<sup>rd</sup> try, or may not start at all if unsuccessful after 3 attempts.
- In warm weather when your vehicle may start very quickly, “Timed Crank” mode may tend to over-crank the starter.
- The only way to possibly correct the above issues is to go to the Option #21 and adjust the cranking time. When in “Timed Crank” mode, the cranking time can only be adjusted manually through option #21. When using Ultra-Smart Tachless or Regular Tach modes, cranking time is adjusted automatically.

## DIESEL GLOW PLUG DELAY

This feature provides a solution for diesel vehicles without having to connect to the Glow Plug-“Wait to Start Circuit” input. This may be due to a variety of reasons for example: If your vehicle does not have a viable “Wait to Start Circuit” or you cannot locate and identify the circuit. You can choose from a selection of “pre-cranking” delay times. Once this mode is activated, the system will NO LONGER monitor the PINK glow plug input wire and will use a delay setting chosen by the installer in the option chart.

NOTES: This feature is OFF by default and must be programmed before use. Once this feature is turned ON, the Pink Glow plug input wire is not used. The Remote start unit will always wait the programmed time before cranking EVEN IF the glow plugs warm up first. There are 3 different Delay times available for use: 10, 20, or 30 seconds. SEE PROGRAMMING OPTION CHART, next section.

### HOW TO USE THIS FEATURE:

1. See the “Programmable Options” next section and change Option #22 from "Monitor Glow Plug Light" to one of the delayed time values. (Default setting is to always monitor the PINK Glow Plug input wire.)
2. Once this option has changed the system will wait for the selected time before cranking the engine.

## PROGRAMMABLE OPTIONS

*You can program multiple options in one session if you start with the lowest option and continue on to higher options [if needed] without repeating steps #1-3 below. For example, you can follow the programming steps to change Option #2 to “OFF” by pressing the lock button on the remote, then you can continue pressing the program button additional times to get to a high number option and change the setting without having to repeat Steps 1-5. You can only go from low to higher option numbers in one session.*

### To Engage Option Programming:

1. Open Hood (ground blue hood pin wire if no hood pin switch is installed)
2. Turn Key to the ON position
3. Press program / valet button 5 times, after a few seconds the unit will flash the lights 5 times.
4. Push the valet/program button [again] the number of times that corresponds to the option number desired (1 thru 30). You must get a light flash after each button press. See chart on next page for option list.
5. When you reach the desired programming level, Press button #1, #2 #3 or #4 to change the option.
6. Turn Ignition OFF, Close hood (or unground blue hood pin wire) and check for changed features. Change each option individually repeating #1-5.

## OPTION PROGRAMMING TABLE

| Option # | Option Description  | TX Button #1                 | TX Button #2         | TX Button #3   | TX Button #4   |
|----------|---|------------------------------|----------------------|----------------|----------------|
| 1        | Engine Monitoring   | Learn Tach                   | *Tachless*           |                |                |
| 2        | Auto lock with Ignition                                   | OFF                          | *ON*                 |                |                |
| 3        | Passive Arming<br>With Ignition or Last Door              | Ignition and last door<br>ON | *OFF*                | Ignition only  | Last Door only |
| 4        | Active Re-Arm   | ON                           | *OFF*                |                |                |
| 5        | Passive Locks   | ON                           | *OFF*                |                |                |
| 6        | Parking Lights on w/Disarm                                | OFF                          | *ON*                 |                |                |
| 7        | Data Port Protocol<br>OFA Series or SL Series             | OFA Series                   | *SL Series*          |                |                |
| 8        | Remote Start & Auxiliary Output<br>Button Press Selection | Double Button Press          | *½ Second Press*     | Press and Hold |                |
| 9        | Siren Chirps on Remote Start                              | OFF                          | *ON*                 |                |                |
| 10       | Disarm on Trunk pop                                       | OFF                          | *ON*                 |                |                |
| 11       | Open Door Warning   | 5 Sec.                       | *60 Sec.*            |                |                |
| 12       | Door Lock Pulse Time                                      | 3 Sec.                       | *0.5 Sec.*           |                |                |
| 13       | Double Unlock Pulse                                       | 2 Pulses                     | *1 Pulse*            |                |                |
| 14       | Lock After Remote<br>Start/Abort                          | OFF                          | *ON*                 |                |                |
| 15       | Manual Transmission Mode                                  | ON                           | *OFF*                |                |                |
| 16       | Timed Crank or Tach Monitor                               | Pre-Set                      | *Tach Monitor*       |                |                |
| 17       | Blue/Black Wire Function                                  | AUX #2                       | *(-) Run / Ignition* |                |                |
| 18       | Siren Chirps with Arm/Disarm                              | OFF                          | *ON*                 |                |                |
| 19       | "Wake Up" pulse on Unlock<br>(1-sec. +12V to IGN)         | ON                           | *OFF*                |                |                |

## OPTION PROGRAMMING TABLE

|    |  |                                |                     |                          |                           |
|----|--|--------------------------------|---------------------|--------------------------|---------------------------|
| 20 | PINK Wire function                                       | Passive Carjack                | *Glow Plug*         |                          |                           |
| 21 | Starter Cranking Time (Option #16 is set to Timed Crank) | 0.75 Sec.                      | *0.5 Sec.*          | 1.0 Sec.                 | 1.5 Sec.                  |
| 22 | Diesel Glow Plug Delay                                   | 10 Seconds                     | *Monitor Glow Plug  | 20 Seconds               | 30 Seconds                |
| 23 | Remote Start Engine Run Time                             | 12 Minutes                     | *24 Minutes*        | 36 Minutes               | 48 Minutes                |
| 24 | Smart Tachless Voltage Adjustment 79-100%                | -1%                            | 1%                  | *Set to 93% for default* |                           |
| 25 | Horn Pulse   | Pulse With Trigger (No Chirps) | No Warn-A-Way       | *All Functions*          | All Functions Short Chirp |
| 26 | Aux # 3  | Steady Momentary               | *Momentary*         | Timed                    | Latch On/Off              |
| 27 | Aux # 3 Time : 1 to 255 sec.                             | -1 Second                      | +1 Second           | *Default 12 Sec.*        |                           |
| 28 | Aux # 4  | Steady Momentary               | *Momentary*         | Timed                    | Latch On/Off              |
| 29 | Aux # 4 Time : 1 to 255 sec.                             | -1 Second                      | +1 Second           | *Default 12 Sec.*        |                           |
| 30 | Turbo Timer Mode 1 to 5 Minutes                          | Brake Pedal Set Mode           | *Always Set Mode*   | Idle Down Mode           |                           |
| 31 | Reset Options to default (*)                             |                                | *Reset All Options* |                          |                           |

### PROGRAMMABLE OPTION DESCRIPTIONS:

#### 1. ENGINE MONITORING:

This option sets how the unit monitors your engine. You can program either for Tach mode in which the unit uses a Tach signal (RPM) or for “Ultra-Smart” Tachless mode that monitors voltage level. See pages 16-18 for more information and additional steps for actual Tach learning and Tach finder modes.

#### 2. AUTOLOCK/UNLOCK W/IGNITION:

Controls whether the doors will automatically lock when the ignition is turned on and unlock when the ignition is turned off. *Doors will not lock if they are open to prevent locking the keys in.*

## PROGRAMMABLE OPTIONS Cont.

### **3. PASSIVE ARMING Passive Arming With Ignition or Last Door:**

With this option ON, the unit will arm itself 30 Seconds after the ignition is turned off and/or the last door has been closed. Lights will flash twice when last door is closed indicating passive countdown. If a door is reopened, the system will wait and begin countdown again when closed. The LED will flash rapidly during 30 second count down.

**4. ACTIVE RE-ARM:** Active Re-arming allows the system to re-arm itself 30 seconds after disarmed with the transmitter if a door has not been opened. The status LED flashes rapidly during 30 second re-arm countdown. This is handy if the vehicle is accidentally disarmed without your knowledge.

### **5. PASSIVE LOCKS:**

This option controls whether the doors will lock when Passive Arming occurs. Note: This may increase the risk of locking keys in the vehicle.

### **6. PARKING LIGHTS ON WITH DISARM:**

Keeps parking lights on when system is disarmed to assist in locating and providing illumination near your vehicle when approaching at night for safety.

### **7. Data Port Protocol:**

This option controls the Data Port Protocol for OFA Series modules or SL Series modules. The default is set for SL Series Protocol. This option has no effect on conventional wiring of Bypass modules. Both OFA series and SL series are now 2-Way Protocol.

### **8. Double Button Press for Remote start and Trunk release:**

This option will allow you to change whether the Remote starter and Trunk release activate by a single ½ second press or a double button ½ second press.

### **9. SIREN CHIRPS WITH REMOTE START ACTIVATION:**

This option controls whether the system gives 3 short siren chirps when engaging a remote start.

### **10. DISARM WITH TRUNK POP (AUX. OUTPUT 1):**

Controls whether the system will or will not DISARM when the trunk pop or AUX. feature is used. When the feature is turned on the unit will DISARM when opening trunk or using an auxiliary device controlled by the Green/Red wire.

### **11. 5/60 Sec. OPEN DOOR WARNING:**

This setting changes the delay time in which the alarm system begins to monitor the Door circuit. This option can prevent the alarm from giving warning chirps on vehicles with a delayed dome light.

## PROGRAMMABLE OPTIONS Cont.

### **12. DOOR LOCK/UNLOCK PULSE TIME:**

This option controls the amount of time (0.5 sec. or 3 sec.) for the lock/unlock pulse. The standard pulse time for most vehicles is 0.5 Sec. The 3 sec. setting may be required for Mid 1980's through Mid 1990's European Vehicles that require a long lock and unlock pulse to operate Vacuum door lock systems.

### **13. DOUBLE UNLOCK PULSE:**

With this option ON, the unit will send 2 unlock pulses when the system is disarmed. This feature may be required for interfacing a Factory alarm or keyless entry system.

### **14. LOCK DURING/AFTER REMOTE START:**

This option controls whether the unit will automatically lock during and after a remote Start abort or time-out.

### **15. Manual Transmission Mode: Authorized Crimestopper Dealers Only. Call Tech Support for Instructions.**

### **16. TIMED CRANK or TACH MONITOR MODE:**

This option controls whether the system uses a tach wire to control the starter or uses a pre-set cranking time.

### **17. BLUE/BLACK WIRE PROGRAMMING: (NEG.) IGNITION OUTPUT or AUX #2 OUTPUT:**

This option controls the function of the Blue/Black wire as either a Ground with Remote Start or a 2<sup>nd</sup> Aux. Channel

### **18. SIREN CHIRPS WITH ARM/DISARM:**

With this feature, siren chirps with Arm/Disarm can be programmed either ON or OFF when using the regular Lock/Unlock Buttons. When chirps are OFF, the Flashing parking lights will be the only Arm/Disarm confirmation.

### **19. +12V "WAKE UP" PULSE:**

This option allows the unit to provide a 1-second pulse on the Pink main ignition output when unlocking. The Ignition pulse serves to "Wake up" vehicle control modules or body computers that "time out" or go into power saving mode. This is required on many late model Ford vehicles with a "Slam" lock system in order to actually unlock the vehicle after it has been at rest for a short period of time.

### **20. PINK WIRE PROGRAMMING: PASSIVE CAR JACK TRIGGER or GLOW PLUG INPUT:**

This option controls whether the system's PINK input wire functions as a Glow Plug input wire for Diesel Engines or a +12V input for tripping a Carjack countdown. For Glow plug, this wire should be connected to the wait to start light circuit. For Carjack this wire can be connected to a hidden push button, or a +12V Ignition circuit for Passive Car Jack operation (see operations manual).

## PROGRAMMABLE OPTIONS Cont.

### **21. PRE-SET STARTER CRANKING TIME: (Requires Option #16 in “Pre-Set” Setting)**

This option controls the starter cranking time when in “Timed Crank” Mode. Choices are 0.5, 0.75, 1.0, or 1.5 sec.

### **22. DIESEL GLOW PLUG DELAY**

This option controls the system’s Diesel vehicle interface. Using this option you can control whether the unit monitors the vehicle’s glow plug circuit using the Pink input wire (Default), or you may select a specific delay time Before cranking. This option is helpful if you are unable to locate a glow plug signal. Just select a delay time and do not connect the Pink Glow Plug wire. Selections: 10, 20, 30 seconds, or Monitor Pink Wire (Default).

**23. REMOTE START ENGINE RUN TIME:** Set engine run time for 12, 24, 36 or 48 minutes as desired.

### **24. ULTRA-SMART TACHLESS VOLTAGE ADJUSTMENT:**

This option controls the voltage reference point when using smart Tachless mode. Pressing the Lock or Unlock buttons on the remote raises or lowers the reference level in 1% increments from 80%-100%. Button #3 resets the unit to the factory default reference point of 93%. The default 93% setting works for most vehicles. See page 16 for additional Ultra-Smart Tachless mode information.

### **25. FACTORY HORN CHIRPS / PULSES:**

This option controls the system’s horn honk output. There are 3 selections:

- 4 Button 1 (Lock): Pulse horn when alarm is triggered.
- 4 Button 2 (Unlock): Pulse horn when alarm is triggered and Honk when Alarm is Armed and Disarmed.
- 4 Button 3 (Trunk Pop): Pulse horn when alarm is Triggered, Honk when Alarm is Armed and Disarmed and Pulse when Shock pre-warning is set off. (default)
- 4 Button 4 (Start): Short Arm/Disarm Chips. Reduces the pulse from 0.04 to 0.02 seconds.

### **26. Aux #3: (Violet/White wire)**

This option controls the function of the Violet/White wire for a negative output for a Momentary, Pulse, Timed or Latched output, depending on option used. Option #27 controls the length of time output.

### **27. Aux #3 Time control: (1 sec. to 255 sec.) Default = 12 seconds**

This option determines the length of time that is outputted from Aux #3 (Violet/White wire). Pressing the Lock or Unlock buttons on the remote raises or lowers the time by one second.

### **28. Aux #4: (Green/White wire)**

This option controls the function of the Green/White wire for a negative output for a Momentary, Pulse, Timed or Latched output, depending on option used. Option #29 controls the length of time output.



## PROGRAMMABLE OPTIONS Cont.

### **29. Aux #4 Time control: (1 sec. to 255 sec.) Default = 12 seconds**

This option determines the length of time that is outputted from Aux #4 (Green/White wire). Pressing the Lock or Unlock buttons on the remote raises or lowers the time by one second.

### **30. Turbo Timer Mode:**

The optional Turbo Timer mode allows the CoolStart system to keep a Turbo or Turbo Diesel vehicle running for 1 to 5 minutes [selectively] after you remove the key and exit the vehicle. This is handy for turbo cool-down without the need for expensive turbo timers. This mode requires the use of an extra part called a momentary switch/button that is not included with the kit. There are (3) modes of operation for the Turbo Timer Mode. See operation manual.

### **31. Option Reset: RESTORE TO DEFAULT**

This option allows you to restore all programmable options to factory default values. Go to the option 31 and press the Unlock Button #2 on the remote. The lights flash 2 times and all values will be reset to factory original settings. Default values are marked with asterisks in the chart on pages 20 and 21.

## PROGRAMMABLE OPTION RESET

This system provides a reset method to restore all options to FACTORY DEFAULT VALUES as listed in the “Button #2” column of the programmable option chart on pages 20-21. This can be helpful if you have lost track of the option settings on your system, or when you are moving the system from car to car and want a “clean slate”.

1. Open hood (ground the Blue wire if no hood pin is installed)
2. Turn Key to the ON position (Pink ignition wire must be connected)
3. Press program / valet button 5 times, after a few seconds the unit will flash the lights 5 times.
4. Push the valet/program button 31 times. Press carefully, do not lose count! You must get a light flash each time you press the button. If the unit didn't flash the lights, then the system did not register your press.
5. Press button #2 (Unlock) to reset the options. (Lights should flash twice)
6. Turn Ignition OFF, Close hood (un-ground Blue wire). All features should be set at \*DEFAULT values.

# REMOTE PROGRAMMING DIAGRAM

**Note: All transmitter codes must be learned at time of programming!! The system learns up to 4 different transmitter codes.**

1. Turn key to the ON position. (Pink wire must be connected.)
2. Press Programming button 4 times, then after a few seconds the unit flashes the parking lights 4 times.
3. Press button #1 of the transmitter to be coded. You should get 2 light flashes indicating the unit is waiting for a 2<sup>nd</sup> code, then press button #1 of a second transmitter, the unit will flash 3 times indicating its waiting for the 3<sup>rd</sup> code and so on. If all 4 codes are learned, the unit will automatically exit code learning mode, otherwise turn key off. See diagram below.

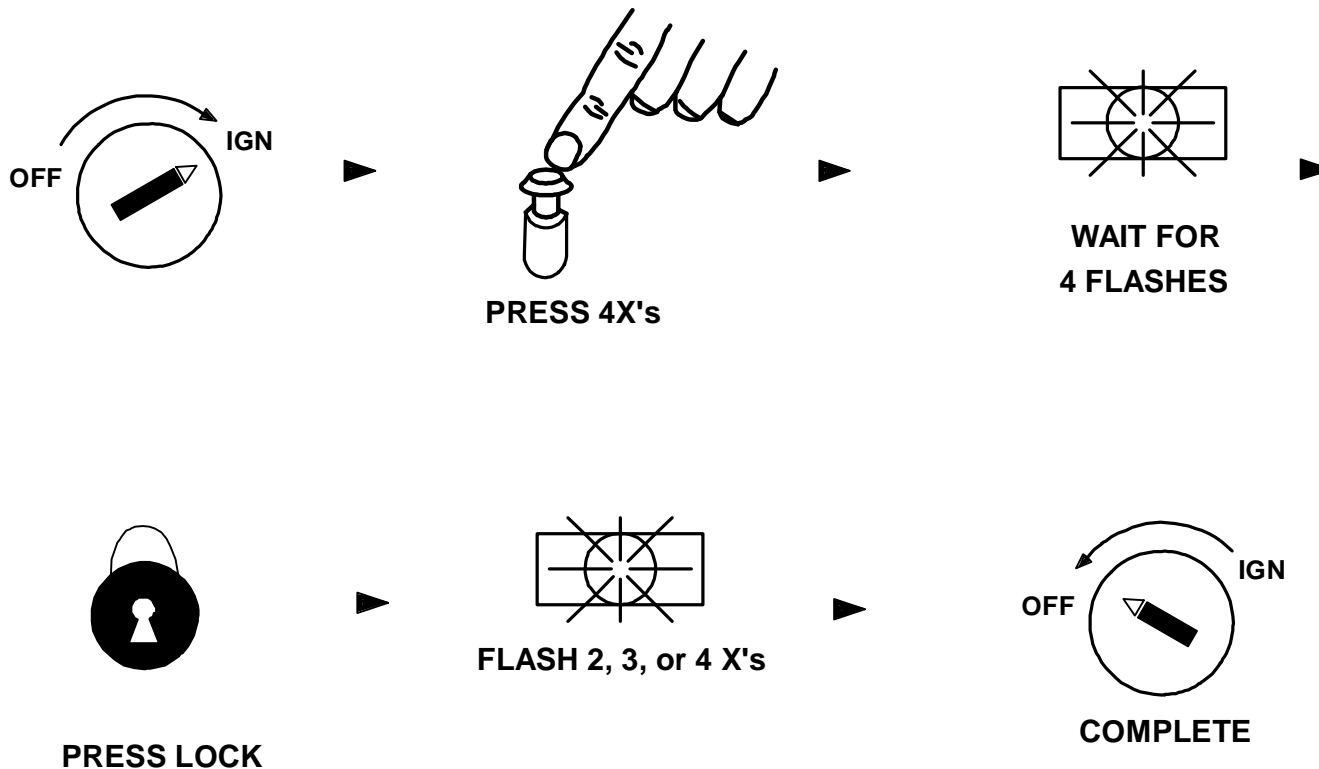

# 2-VEHICLE OPERATION

## 2 VEHICLE CONTROL

Your remotes have the ability to control a second vehicle with a Crimestopper system installed.

To set up the 2-Vehicle operation you must first program your remotes to Vehicle #2. Follow the “Transmitter Programming” steps (Pg. 26) at the second vehicle and learn YOUR remote, along with vehicle #2’s existing remotes.

### 2-VEHICLE NOTES:

(1) You do not have to switch between Vehicle “1” and “2” to get pages from each vehicle. Your remote pager will receive pages from both cars regardless of which vehicle the pager is set to. The “1” or “2” icon will always display with each page indicate which vehicle the page originated from.

(2) When, all remote/pagers and sidekick remotes for that vehicle must be learned at the time of programming. When you program your remote at the second vehicle, that vehicle’s original remote must also be programmed. Your remote should be set in Vehicle “2” and the vehicle’s original remote should be set in Vehicle “1”.

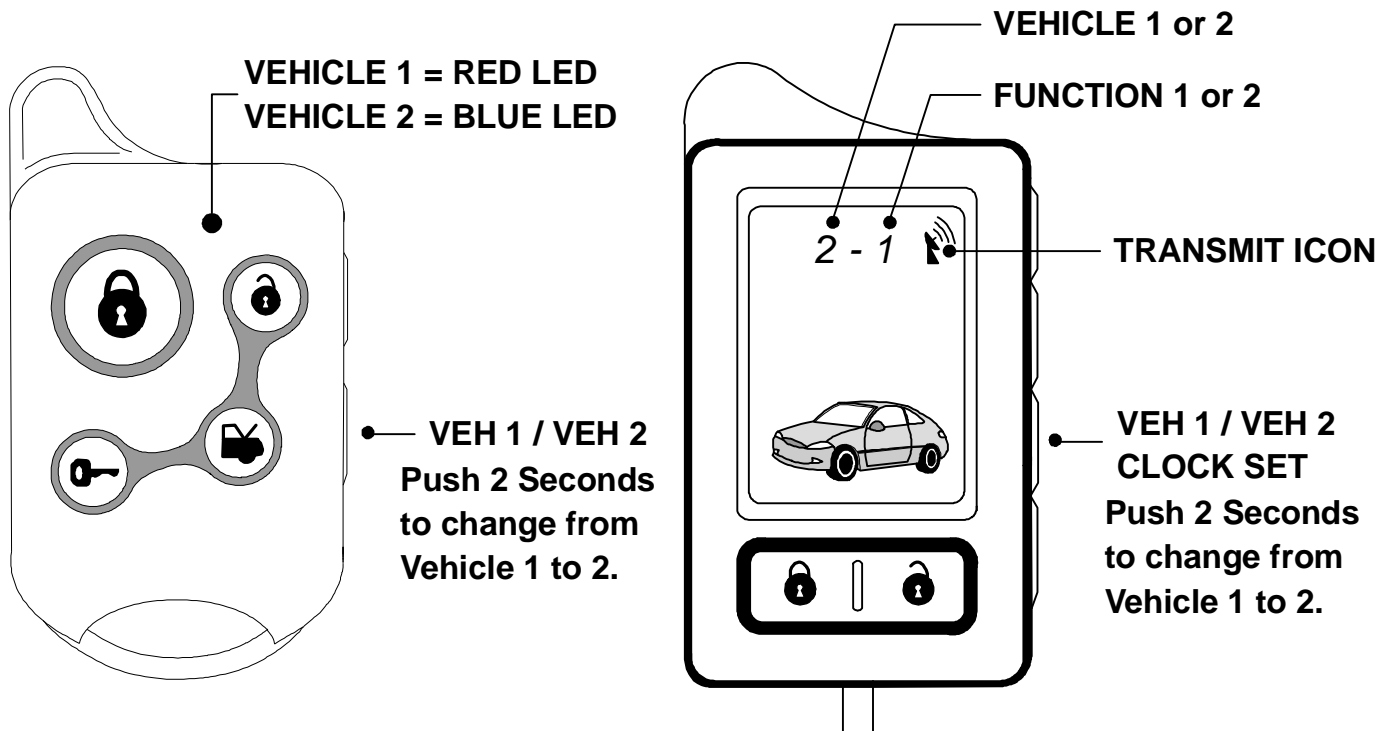

## ALARM TRIGGER DIAGNOSTICS

This systems includes disarm diagnostics, through the LED light, that will help in determining what caused the last trigger of the alarm system. This is a valuable tool in determining how the vehicle was tampered with or if there is a false alarm problem in which case you can make the necessary adjustments to correct the problem.

When the system is disarmed with the remote you will hear the normal 2 chirps, then 4 quick chirps that indicate the alarm was triggered while you were away. Check the LED light for a sequence of flashes:

**Shock Sensor Violation = 1 Flash**

**Door Violation = 2 Flashes**

**Hood/Trunk = 3 Flashes**

**Ignition Violation = 4 Flashes**

Diagnostics will reset when the Ignition is turned on or when the system is re-armed.

## REMOTE START DIAGNOSTICS

If the system flashes the parking lights one to three times and doesn't attempt remote, it means the following:

**1 Parking Light Flash = Problem with Brake Switch.** There could be a problem with a bad brake light. Many dual filament light bulbs connect the brake and park lights together when bulb goes bad. Check all brake lights work properly.

**2 Parking Light Flashes = Problem with Hood Switch.** Make sure hood is closed or that the Blue hood pin wire is not shorted to Ground.

**3 Parking Light Flashes = Valet Service Mode.** Check the systems LED light and if it is on solid Red LED (with doors closed) then the system is in Valet Mode. To exit Valet Mode, turn the Ignition on, press and hold Valet Button for about 5 seconds until LED goes out. Unit is now out of Valet Mode and should perform a remote start.

**7 Parking Light Flashes = Manual Transmission Mode Error.**

# JUMPER PIN DIAGRAM

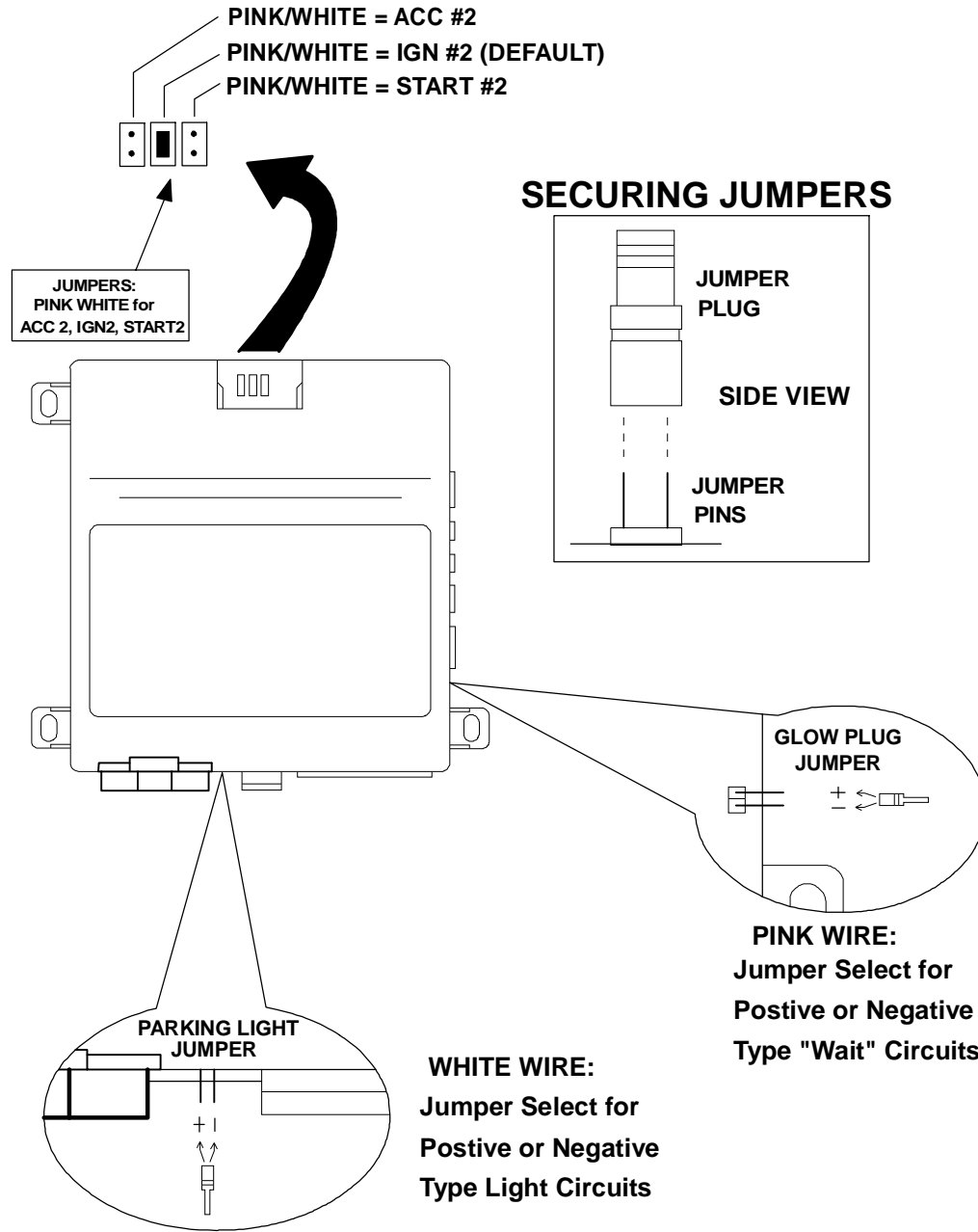

# WIRING: 6-PIN High Current Connector

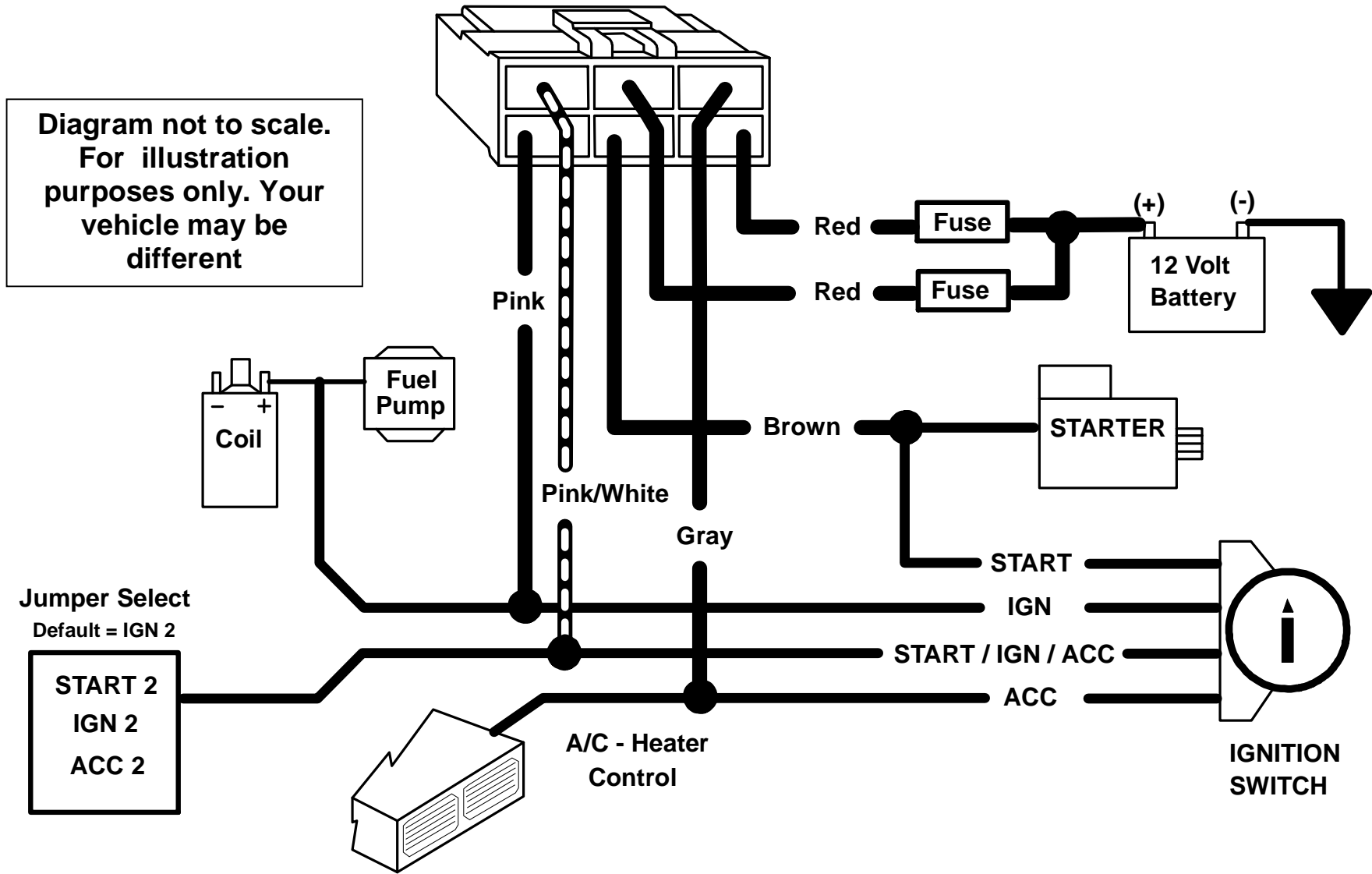

**NOTE!** Use External Relays for High Current Ignition and/or Accessory circuits greater than 30A. Failure to do so could result in damage to the unit that is not covered under warranty. \*\*\*\* Fuse Holders Wire Connections should NOT GET HOT \*\*\*\*

# WIRING DIAGRAM

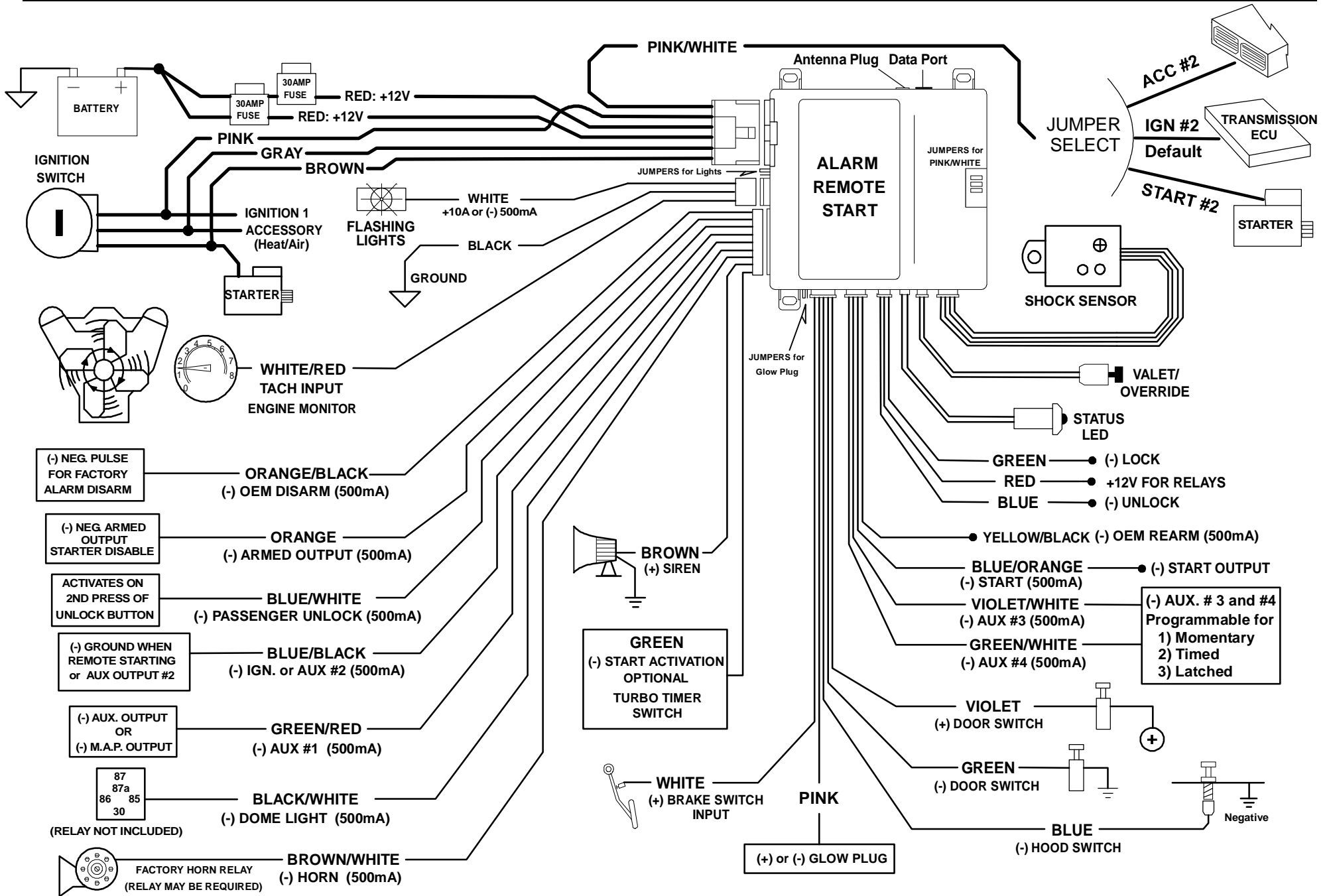

# DATA PORT DIAGRAM

This unit includes DP Technology that will allow you to directly Plug-In our Data Port Bypass Modules. There are 2 types of Protocol, OFA series and SL series modules. The default is set for SL series Protocol. Please refer to Databus module manual for detail instructions. The Data Port Protocol must be programmed for the correct module.

**See Option # 7 on page 20**

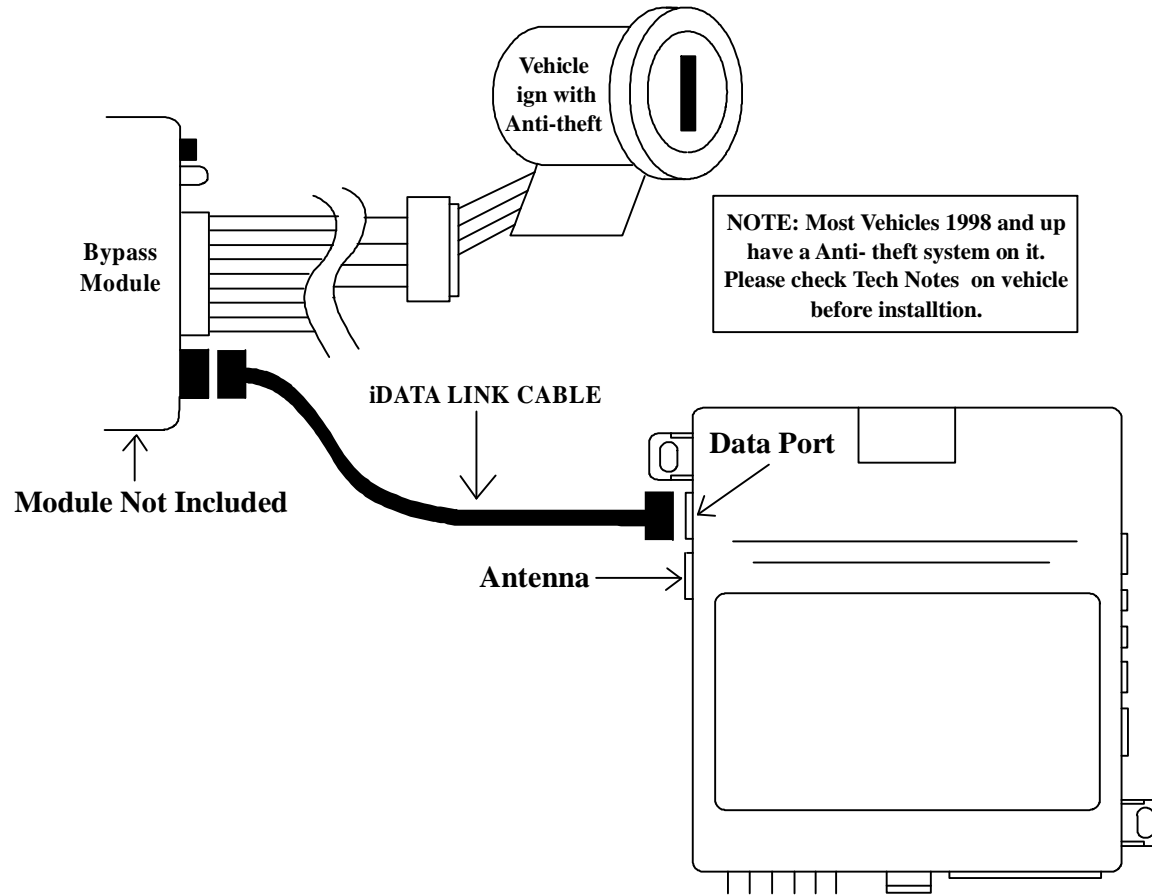

## CRIMESTOPPER

[www.crimestopper.com](http://www.crimestopper.com)  
Phone (800) 998-6880  
FAX (805) 581-9500

© 2008Crimestopper Security Products

## TechWeb

ONLINE TECHNICAL SUPPORT  
[www.crimestopper.com](http://www.crimestopper.com)



# CRIMESTOPPER

## SP-500

### 2-Way LCD Paging Alarm & Remote Engine Starting System

## OPERATING INSTRUCTIONS

### INTRODUCTION

*CONGRATULATIONS* on your choice of the SP-500 by *Crimestopper Security Products Inc.* This booklet contains the information necessary for operating your system. If any questions arise, contact your installation dealer or Crimestopper Security Products Inc.

**\*IMPORTANT INFORMATION: Primary and Optional Features**

**-PRIMARY:** These features must be connected in order for the system to operate properly i.e. Power, Ground, LED, etc.

**-OPTIONAL:** Optional features are connected only if desired or agreed upon by the installing dealer i.e. Horn Honk, Dome light illumination, Door Locks, Trunk Pop, etc. These features may require additional parts and labor charges. Consult with your installer about these features **BEFORE** installation!

**CONTACT INFORMATION:**

**TECHNICAL SUPPORT (800)-998-6880**  
**Monday - Friday 8:00am - 4:30pm Pacific**

**Website: [www.crimestopper.com](http://www.crimestopper.com)**

**CRIMESTOPPER**  
**SECURITY PRODUCTS, INC.**  
**1770 S. TAPO STREET**

**SIMI VALLEY, CA. 93063 REV 12.2008**

This device complies with FCC Rules part 15. Operation is subject to the following two conditions: 1) This device may not cause interference, and (2) this device must accept any interference that may be received, including interference that may cause undesired operation. The manufacturer is not responsible for any radio or TV interference caused by unauthorized modification to this equipment. Such modification could void the user's authority to operate the equipment.

# TABLE OF CONTENTS

|  |              |
|--|--------------|
| <b>Operation Cautions &amp; Warnings.....</b>        | <b>2</b>     |
| <b>The Remote Controls.....</b>                      | <b>3-4</b>   |
| <b>Setting the Clock.....</b>                        | <b>4</b>     |
| <b>Quick Chart Button Functions.....</b>             | <b>5</b>     |
| <b>Operating Instructions - Alarm.....</b>           | <b>6-9</b>   |
| <b>Remote Engine Control.....</b>                    | <b>10-13</b> |
| <b>Anti-Carjack Protection.....</b>                  | <b>14</b>    |
| <b>LED and Remote Start Diagnostics.....</b>         | <b>15</b>    |
| <b>Transceiver / Remote Control Programming.....</b> | <b>16</b>    |
| <b>2 Vehicle Operation.....</b>                      | <b>17</b>    |
| <b>TURBO Timer Mode.....</b>                         | <b>18-19</b> |
| <b>Battery Replacement.....</b>                      | <b>20</b>    |

## OPERATION CAUTIONS & WARNINGS

**CRIMESTOPPER SECURITY PRODUCTS, INC.** and its **VENDORS** shall not be liable for any accident resulting from the use of this equipment. This system is designed to be professionally installed into a car or vehicle in good running order. Items, such as parking brake, door switches, and all engine safety features, must be in perfect working condition.

**DAMAGE** resulting from misuse or negligence is **NOT** covered under warranty and will be subject to repair and / or replacement charges.

**IT IS ABSOLUTELY THE OWNER'S SOLE RESPONSIBILITY TO:** A) Understand the operation of this system and its safety features. B) Check for proper operation of these safety features prior to accepting delivery of the vehicle from the installation facility. C) Check and maintain the condition of the vehicle and all items relative to the proper operation of this system and its safety features.

**DO NOT remote start the vehicle in a closed garage.** Make sure that the vehicle is outdoors, a garage door is open, or there is adequate exhaust ventilation. Failure to observe this rule could result in **injury or death** from poisonous Carbon Monoxide fumes. This is especially important when using the Timed Self-Start feature of the unit

# THE REMOTE CONTROLS

## 2-WAY - PAGER / REMOTE TRANSCEIVER:

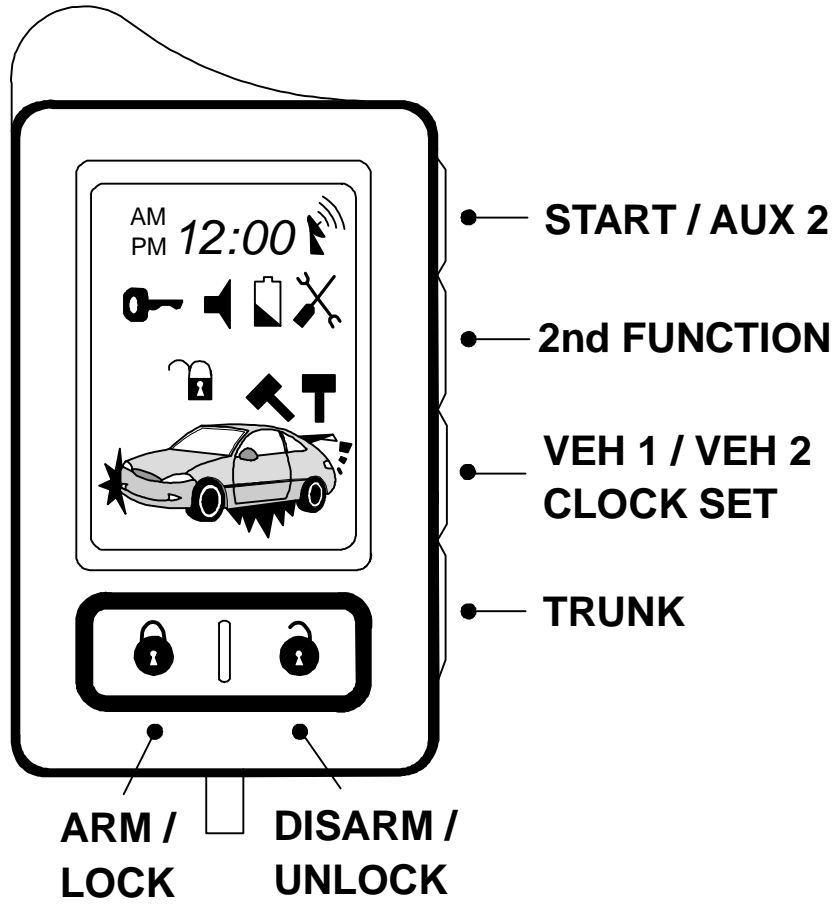

## 1-WAY - SIDEKICK REMOTE:

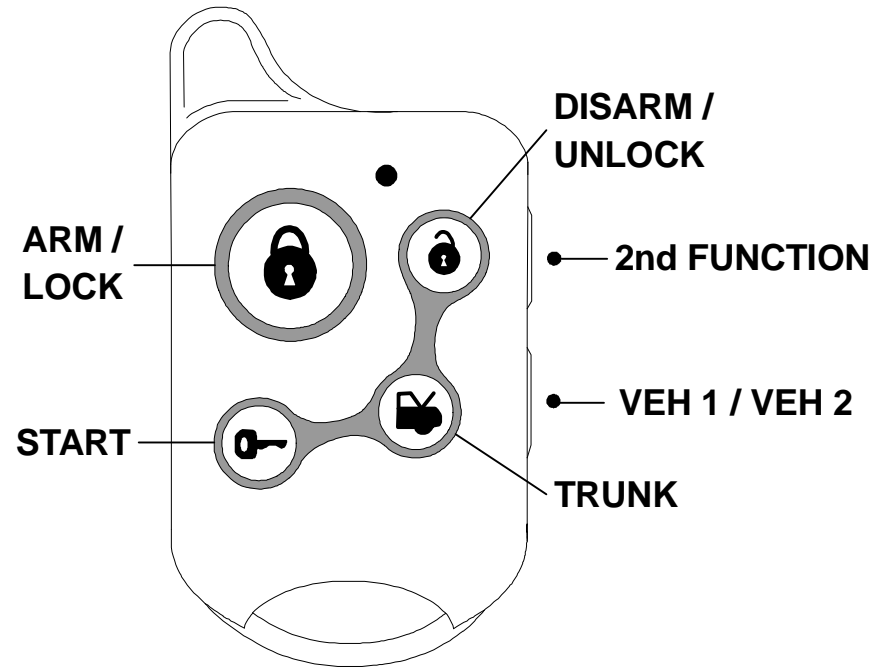

# THE REMOTE CONTROLS

## 1-WAY - SIDEKICK REMOTE:

The 1-Way sidekick remote adds flexibility to your system. You can have the convenience of operating your system without needing to carry the larger pager remote. The Sidekick remote has less range and offers all of the same operation features except for page-back confirmation. The 1-Way Sidekick Remote uses two CR-2016 Lithium 3 Volt Batteries.

























## 2-WAY - PAGER / REMOTE TRANSCEIVER:

The 2-Way hand-held remote transceiver is used to send and receive information from the vehicle. The Control Module transmits High Frequency FM signals from the vehicle to your pager over long distances. Your range will vary depending on location, terrain, and local RF noise/interference. This system is not guaranteed to page you if you are behind concrete walls, underground, in a large structure, or in an area with high levels of electronic interference. Handle the pager/remote with care. The LCD display and/or the electronics may be damaged if subjected to abuse. The AAA Cell 1.5V alkaline battery can easily be replaced by sliding open the battery access door on the back of the remote. Battery life will vary depending on usage. The LCD screen will display a low battery icon when the battery is low.

## SETTING THE CLOCK (2-WAY- LCD REMOTE)

1. Press VEH Button on the side of the remote control 5 times.
2. The remote will beep and the **AM or PM** display will begin flashing.
3. Press the Trunk Button to go to the next item – **AM - PM - Hour- Minutes.**
4. Press the Lock Button to **increase** time.
5. Press the Unlock Button to **decrease** time.
6. Press the Start Button to **Disable or Enable Beep.**
7. Press the VEH Button to **Exit Setup** or wait 7 seconds, the LCD light will turn off.

# QUICK CHART BUTTON FUNCTIONS

| Button   | Button Functions             | Button Options                                  | Button   | Button Functions                          | Button Options                                     |
|--|------------------------------|---|--|---|--|
|   | Lock Doors & Arm System      | Press and Hold 2 Seconds for Panic Mode         |   | 2nd Function                              | Press and Hold for 2 seconds                       |
|   | Unlock Doors & Disarm System | Press twice for second door unlock              | <b>VEH</b>   | Selects between Vehicle #1 and Vehicle #2 | Press and Hold for 2 seconds                       |
|   | Trunk Pop <b>Aux # 1</b>     | Press and Release for Trunk Pop Aux #1          |  Plus      | Valet Service / Park Sensor ON / Off      | Valet Mode when Disarmed. Sensor On/Off when Armed |
|   | Start or Stop engine         | Press for Remote Start. Three options available |  Plus      | Activates CarJack with Ignition On        | Press and Hold 2 Seconds for CarJack Mode          |
|  Then      | Activates <b>Aux #2</b>      | Steady Momentary Output                         |  Plus      | Activates <b>Aux #2</b>                   | Steady Momentary Output                            |
|  Then      | Activates <b>Aux #3</b>      | Momentary, Timed or Latched Output              |  Plus      | Activates <b>Aux #3</b>                   | Momentary, Timed or Latched Output                 |
|  Then  | No Function                  | No Function                                     |  Plus  | Silent Arm / Disarm                       | No Arm / Disarm Chrip from Siren or Horn           |
|  Then  | Activates <b>Aux #4</b>      | Momentary, Timed or Latched Output              |  Plus  | Activates <b>Aux #4</b>                   | Momentary, Timed or Latched Output                 |

**CLOCK SETUP:** Lock = Increase, Unlock = Decrease, Trunk = Next, Start = Beep with button press, VEH = Exit

# OPERATING INSTRUCTIONS - ALARM

## **Arming / Locking:**

Press the Lock Button on the remote control. The System will arm emit one siren chirp, one light flash, and the LED will begin to flash. Power locks will lock (if equipped). Starter disable circuit will turn on. The 2-Way LCD Pager will beep once while displaying a Locking symbol. After a short delay to allow the vehicle and electronics to settle, the system will be completely armed.

## **Disarming: / Unlocking**

Press the Unlock Button on the remote control. The System will disarm and confirm with two siren chirps, two light flashes, and the LED will turn off. Power locks will unlock and Interior Dome light will turn on (if installed with these optional features). The 2-Way LCD Pager will beep twice while displaying an Unlock symbol.

## **Alarm Triggers:**

If there is an intrusion into the vehicle, a hard impact to the body or the ignition is turned on, the alarm will sound and flash the lights for 1 minute. After 1 minute, the trigger cycle will automatically stop and alarm will remain armed to continue protecting the vehicle. If a door is left open after an intrusion then the unit will cycle a maximum of 2 minutes and continue to protect the other un-tampered or unopened zones.

## **LCD Remote Paging / Zone Violations:**

When the system is triggered, the alarm sends a paging signal to the remote. If you are within range, you will receive a paging signal that will light up the LCD Screen Red. The display will show an icon of what caused the violation. The paging remote will also vibrate and beep to notify you the vehicle has been tampered with.

## **Disarming While Tripped (Triggered):**

Disarming the System while it is triggering requires TWO presses of the Unlock Button. The first press Resets the alarm cycle only (system still armed) while a second press will disarm/unlock the system.

## **Selective Silent Arming / Disarming:**

To Arm or Disarm the system without siren chirps, press and release both the Unlock and Start Button at the same time. The System will Arm or Disarm without siren chirps. Flashing lights and LED will be the only indicators of Arm/Disarm status. The LCD will Display a musical note with an "Ø" when the system is armed or disarmed without a chirp

# OPERATING INSTRUCTIONS - ALARM

## **Prior intrusion Alert**

This system will notify you if the alarm was triggered while you were away. Upon disarming, there will be four additional siren chirps after the two normal disarm chirps. Check your vehicle for any signs of a break in or tampering. Also, see LED Diagnostics (page 15) to determine the cause of the trigger.

## **Remote Panic Protection**

To sound the alarm in an emergency situation or to draw attention to your vehicle, press and hold the Lock button for at least 3 seconds until the siren / horn sounds. Press the Unlock button to reset panic mode. The LCD display will flash most of the icons and emit 10 beeps when the Panic Mode is triggered.

## **Selective Shock Sensor Disable**

To arm the alarm and bypass shock sensor protection, press the Lock Button as normal then press and release the Lock & Unlock Button together within 2 seconds. You will hear 3 extra siren chirps indicating the shock sensor bypass for this arming cycle only. This is feature useful when parking near railroad tracks, airports, or areas with excessive loud machinery or noise to prevent the nuisance of unnecessary false alarms.

## **Open Door Alert / Bypass**

Upon arming, this system will warn you 60 seconds later if a door is left open. The LCD pager will vibrate and beep (5X's) along with displaying the open zone on your LCD screen. This zone will be bypassed until the door is closed; otherwise, the alarm will continue to protect all other zones.

## **Pre-Warning Shock Protection**

The Pre-Warning (Warn-A-Way) feature will activate when a low-level shock or vibration is detected by the system's shock sensor. The alarm will chirp the siren 5 times and flash the lights once to help deter any further tampering with the vehicle. The pager / remote will beep and show a Hammer Icon.

## **Passive Arming Mode: (Programmable)**

Passive (automatic) Arming occurs 30 seconds after the ignition is turned off and the last door is closed. Upon closing the last door, the unit will flash the lights twice and LED will be flashing rapidly to confirm passive countdown. If a door is reopened within the 30-second period, the countdown stops and begins again when the door is closed. Passive arming provides failsafe protection in case you forget to arm the system.

# OPERATING INSTRUCTIONS - ALARM

## **Passive Locking: (Programmable)**

The system can be programmed to passively lock the doors when the system passively arms. The default setting is OFF because passive locking increases the risk of locking the keys in the vehicle when the system arms/locks passively, without you pressing the remote.

## **Trunk/Hatch Pop (Optional, Remote AUX. Output 1)**

This feature is designed to interface with existing Factory power trunk or power hatch release systems and may require additional parts and/or labor charges. To eliminate the possibility of accidentally opening the trunk, there are (3) options for button press selection. This option will allow you to change whether the Remote starter and Trunk release activate by a:

1. Double button ½ second presses.
2. Single ½ second press.
3. Press and Hold 2 seconds.

***\*Default = Single ½ second press\****

## **Remote AUX. Output 2 (Optional, Requires special programming)**

This system contains a 2<sup>nd</sup> Auxiliary output to activate other accessories or devices. To activate the 2<sup>nd</sup> Auxiliary output, press the Unlock and Trunk button for more than 2 seconds. This momentary output will stay active as long as the remote button is held down. There is no LCD / Pager confirmation for Aux. 2 output.

## **Remote AUX. Output 3 (Optional, Requires special programming)**

This system contains a 3<sup>rd</sup> Auxiliary output to activate other accessories or devices. This output is programmable for a momentary, timed or Latch output. There are 2 ways to control this output. To activate the Third Auxiliary Output:

1. Press the 2<sup>nd</sup> Function button, than press the Trunk button on the transmitter.
2. Press the Lock and Key Button at the same time.

## **Remote AUX. Output 4 (Optional, Requires special programming)**

This system contains a 4<sup>th</sup> Auxiliary output to activate other accessories or devices. This output is programmable for a momentary, timed or Latch output. There are 2 ways to control this output. To activate the Forth Auxiliary Output:

1. Press the 2<sup>nd</sup> Function button, than press the Lock button on the transmitter.
2. Press the Trunk and Start Button at the same time.



# OPERATING INSTRUCTIONS - ALARM

## **Dome Light Illumination (Optional)**

This feature will turn on the vehicle's dome light upon disarming for 30 seconds or until the key is inserted and turned on. This will provide illuminated entry to your vehicle in dimly lit areas for safety and security.

## **Emergency Override (Disarm)**

If you have lost the transmitter or it stops working for any reason and the Alarm is armed, you will have to disarm the system manually. Open the door with the key [alarm will sound], turn the ignition on, and press the override/program button for about 5 seconds. The Alarm will disarm and allow you to use the vehicle until you can repair/replace the remote. Valet mode also prevents Passive Arming.

## **Valet Mode (Enter manually or using the remote)**

To disable Alarm and Remote Engine Starting for vehicle servicing the alarm system must be disarmed. **To Activate Valet Mode:** Turn the ignition on and press the override/program button [about 5-6 seconds] until you hear (3) siren chirps and the LED turns on solid. Repeat the process to exit VALET mode. To enter / exit Valet via the remote, press and hold both the Lock and Unlock Button together for about 3 seconds until 3 chirps are heard. Repeat this step to exit via the remote transmitter. Lock / Unlock and AUX features will still operate in VALET Mode however, Remote Start and Alarm functions are inhibited.

## **Valet Park Mode (Using the remote transmitter only)**

Valet Park Mode allows you to turn over the vehicle to a Valet allowing access to drive/lock/unlock your vehicle, but alarm will trigger if the trunk is opened. **To Activate Valet Park:** The alarm system must be disarmed. Press and hold both the Lock and Unlock buttons together for about 3 seconds, 3 chirps will be heard first when unit goes into regular Valet. Release, press and hold both buttons again, you will hear 2 more chirps. The LED will always flash slowly when in Valet Park even when the Ignition is turned on (or driving vehicle). Repeat step above to exit Valet Park Mode.

Note: Valet Park mode is only accessible when using the remote transmitter

# REMOTE ENGINE CONTROL

## Remote Start & Auxiliary Output – Button Press Selection (Option # 8):

To eliminate the possibility of accidentally opening the trunk or starting the vehicle, there are (3) options for button press selection. This option will allow you to change whether the Remote starter and Trunk release activate by a:

4. Double button ½ second presses.
5. Single ½ second press.
6. Press and Hold 2 seconds.

**\*Default = Single ½ second press\***

## REMOTE ENGINE STARTING - SUCCESSFUL START

- 1) Press remote start button on the remote transmitter. System will chirp 3 times for audible confirmation. (Chirps can be programmed on or off-See installation manual.)
- 2) Parking lights flash once, then turn on solid, Ignition/Accessory circuits turn on.
- 3) After a few seconds, Starter Motor engages, Parking lights and Accessory circuits turn off while cranking.
- 4) Engine Starts and Runs. Parking Lights and Accessory turn back on, Doors Lock.
- 5) Engine will remain running for programmed run time until reset with Brake pedal. If needed, the engine can be turned off with remote transmitter.

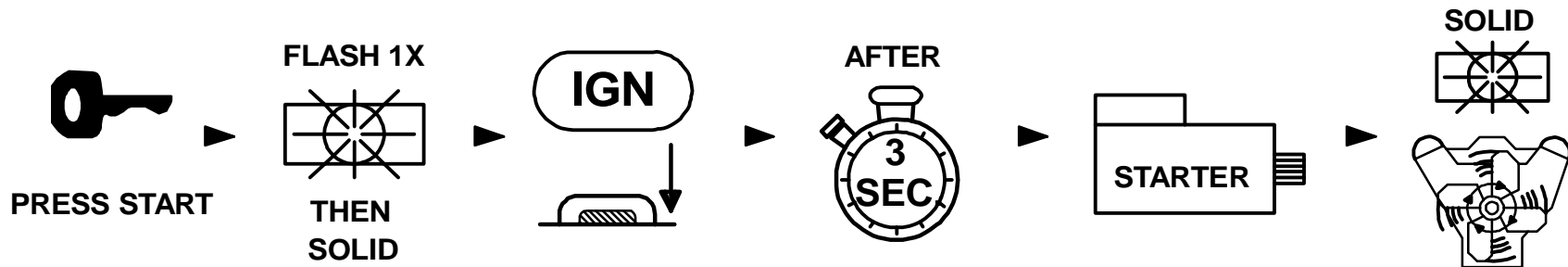

## REMOTE ENGINE STARTING – LCD PAGER-REMOTE:

When requesting a remote start the LCD pager remote will confirm with an Ignition Icon along with 3 beeps. Once the vehicle has successfully started the remote will confirm back with 1 vibration, a moving vehicle icon, and 6 beeps.

# REMOTE ENGINE CONTROL

## UNSUCCESSFUL REMOTE START

In the event that the engine does not start on the first attempt, the system shuts down for a few seconds, then attempts to restart the engine a 2<sup>nd</sup> and 3<sup>rd</sup> time. For hard starting engines, the unit will allow a starter crank time of up to 13 seconds maximum. This should provide ample cranking time for difficult starts, but is limited to 13 seconds to help prevent damage to the starter from over cranking.

- 1) If engine starts on 2<sup>nd</sup> or 3<sup>rd</sup> attempt, see steps 4 & 5 (on last page) under "Successful Start".
- 2) If Third attempt fails to start engine, the system will turn off and doors will remain locked. *NO FURTHER ATTEMPTS WILL BE MADE AUTOMATICALLY UNLESS YOU PRESS THE REMOTE START BUTTON AGAIN.*

## TURNING OFF YOUR REMOTE STARTED ENGINE (VIA REMOTE CONTROL):

- 1) Engine is running in Remote Start (Parking lights ON).
- 2) Press Remote Start button on remote transmitter.
- 3) Engine & parking lights turn OFF, Doors remain locked or will re-lock if applicable.



## ENTERING YOUR REMOTE STARTED VEHICLE:

- 1) With engine running, Remote Unlock/Disarm system (If armed) or open door with key.
- 2) Enter vehicle and be careful not to step on brake pedal! (Remote Start Reset)
- 3) Turn Ignition to ON/RUN position, then press brake pedal to reset the Remote Starter & Shift out of park.
- 4) Remote starter will reset instantly when the brake is pressed. Parking lights will turn off and the ignition key is now controlling your vehicle.

# REMOTE ENGINE CONTROL

## **IDLE DOWN MODE (TAKE-OVER OPERATION)**

This mode allows the unit to take over operation of your idling, parked vehicle while the ignition key is removed and you exit the vehicle. The vehicle is put into a remote running condition before you exit and it will remain running for the programmed run time, until you return, or until the remote start button is pressed.

Example:

*You pull up to a convenience store for a quick stop, "Idle Down" mode keeps engine running when you exit the vehicle, (with keys in hand) remote lock/arm alarm. When you return, unlock/disarm alarm, turn ignition ON and drive away. This mode can also be used on Turbo vehicles that need idle for cool-down.*

## **IDLE DOWN MODE - EXITING THE VEHICLE:**

- 1) With engine running, press Remote Start button on remote transmitter. Siren will chirp 3 times for confirmation.
- 2) Parking Lights will turn ON.
- 3) Doors will unlock, or if brake pedal is being depressed then doors will unlock when it is released.
- 4) Turn OFF Ignition and remove key. Engine should remain running.
- 5) Exit vehicle, then remote lock doors if desired.
- 6) Engine will remain running for programmed run time, until you return, or press the remote start button.

## **INFINITY RUN MODE**

This mode allows the vehicle's engine to remain running *INDEFINITELY*. This mode can be beneficial to law enforcement vehicles or commercial vehicles that need to remain running unattended for long periods of time.

## **INFINITY RUN MODE – EXITING THE VEHICLE:**

- 1) Follow steps for "IDLE DOWN MODE - EXITING THE VEHICLE" (above), except press the remote start button a second time within 10 seconds at STEP #1.
- 2) Parking Lights will start flashing instead of coming on solid, and doors will unlock.
- 3) Turn Ignition switch OFF, remove key and exit the vehicle. Engine should remain running.
- 4) The vehicle's parking lights will flash for the programmed run time of 12, 24, or 36, or 48 minutes and then switch to solid while motor runs indefinitely or until fuel supply runs out.

# REMOTE ENGINE CONTROL

## TIMED SELF START MODE

This mode allows the vehicle to be programmed to self-start every 4 hours and run for the programmed run time. This can be helpful during extremely cold conditions where engine or fluid freeze-up is a concern. !!THE VEHICLE MUST BE OUTDOORS OR IN A WELL VENILATED AREA!!

## TIMED SELF-START MODE – EXITING THE VEHICLE:

- 1) Have engine running with the Key, then press the Start button on the transmitter.
- 2) Within 10 seconds press the valet/program button once.
- 3) Parking Lights will turn OFF for about 5 seconds, and doors will unlock.
- 4) Turn Ignition switch OFF, remove key and exit the vehicle. Engine should remain running.
- 5) Press the remote start button again to turn off the engine. The parking lights will flash 4 TIMES as a confirmation that the unit is in Timed Self-Start Mode.
- 6) The Vehicle will Start by itself every 4 hours, or until driven with key or started via remote control.

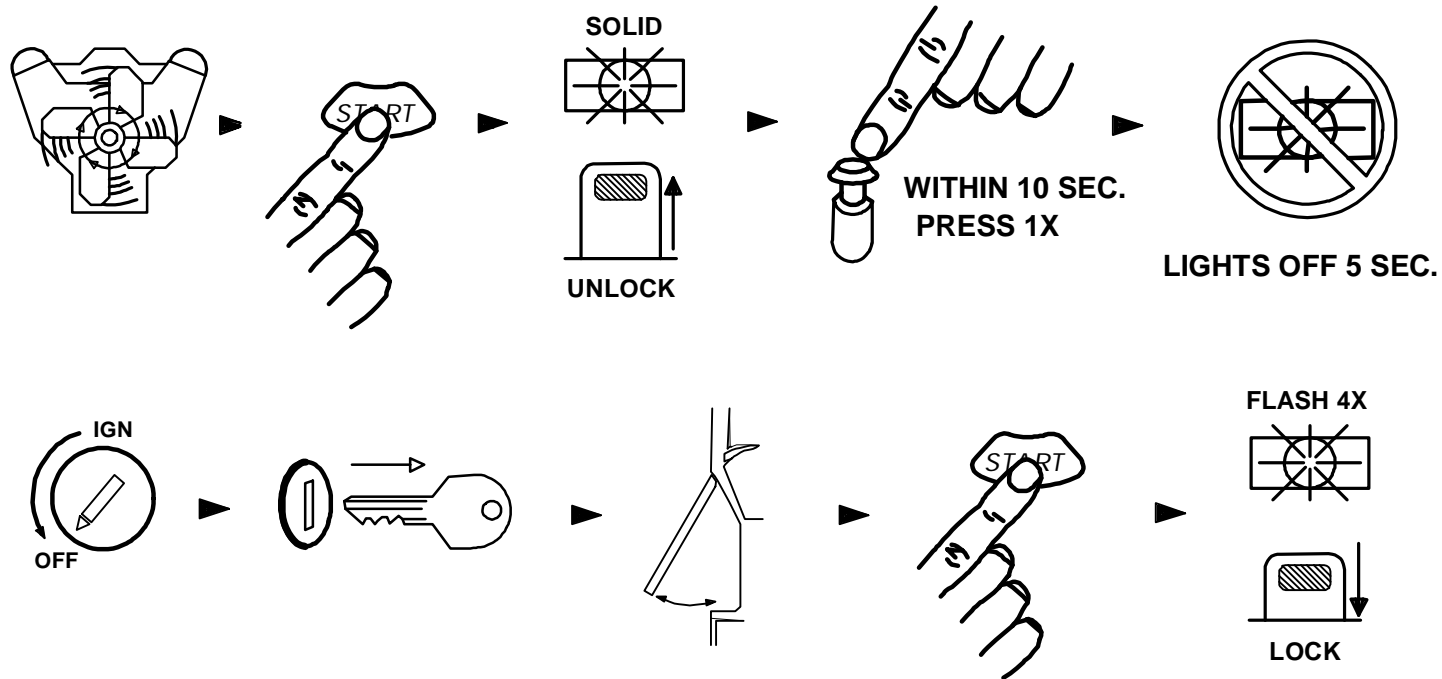

## RESETTING TIMED SELF START MODE

To reset the timed self-start mode, start vehicle using the ignition key or the remote control.

# ANTI CARJACK PROTECTION

## REMOTE OPERATED CARJACK PROTECTION

This feature provides Active Carjack protection through the remote control. When the Ignition is on (vehicle is running), press and hold the #1 LOCK Button and #3 TRUNK Button for 2 seconds. The parking lights will flash 2 times and the LED will begin to flash rapidly to confirm the beginning of a Carjack countdown. 30 Seconds later, the unit will begin a Carjack Cycle consisting of 20 seconds of pre-warning chirps turning into a full system activation with siren / flashing light pulses for up to 5 min. If the Ignition is turned off during a Carjack trigger the siren and lights stop but Carjack protection is still active. The Siren and Lights will resume if the Carjacker tries to turn the Ignition back ON. TO RESET: Press Button #2 (UNLOCK) on the remote and the siren will chirp once, or turn the key on and press and hold the override button for at least 5 seconds.

## SWITCH-CONTROLLED & FULL TIME CARJACK (PINK WIRE CONFIGURATION)

This feature can provide Passive or Manual control Carjack protection depending on the configuration of the Pink Carjack wire of the alarm system. The system must be programmed for the Pink wire to be used as a Carjack trigger with programming option #20. Once programmed for the Pink wire for use as a Carjack trigger, it can be configured in different ways to provide different levels of protection. It can be connected to a hidden +12V toggle/momentary switch or to +12V Ignition Power. Read following sections for further descriptions.

## HIDDEN SWITCH-CONTROLLED CARJACK:

This configuration will enable the vehicle owner to activate a Carjack countdown by pressing a hidden push-button (not included with kit) during a Carjack situation. A Carjack countdown will begin under the following conditions: Ignition is ON (vehicle is running), the push-button is pressed, and the door opens/closes. Upon these 3 events, in that order, the alarm will start a Carjack countdown. After a delay of one minute, the system will begin chirping for 20 seconds then trigger into a full cycle for up to 5 minutes. To reset this Carjack mode, Ignition must be ON then press and hold the override/valet button for 5 seconds (until LED goes out.)

## FULL-TIME [Permanent] CARJACK:

We recommend that this configuration only be used if a serious threat of Carjack exists during everyday situations. When the Ignition is on (vehicle is running), anytime a door is opened, the Carjack countdown sequence will be initiated. There will be 2 light flashes and the LED will change from solid to quick pulsing as confirmation of a countdown sequence. To reset FULL TIME Carjack, the Ignition has to be ON, then press and hold the override/program button 5 seconds until LED stops pulsing. The LED will be on SOLID when in this mode anytime the Ignition is ON (or while driving) as a reminder that Carjack is waiting for a door to open.

## LED DIAGNOSTICS

The SP-500 system includes disarm diagnostics, through the BLUE LED light, that will help in determining what caused the last trigger of the alarm system. This is a valuable tool in determining how the vehicle was tampered with or if there is a false alarm problem in which case you can make the necessary adjustments to correct the problem. When the system is disarmed with the remote you will hear the normal 2 chirps, then 4 quick chirps that indicate the alarm was triggered while you were away. Check the LED light for a sequence of flashes:

**Shock Sensor = 1 Flash    Door = 2 Flashes    Hood/Trunk = 3 Flashes    Ignition = 4 Flashes**

Diagnostics will reset when the Ignition is turned on or when the system is re-armed.

## REMOTE START DIAGNOSTICS

If the system flashes the parking lights one to three times and doesn't attempt remote, it means the following:

**1 Parking Light Flash = Problem with Brake Switch.**

**2 Parking Light Flashes = Problem with Hood Switch.**

**3 Parking Light Flashes = Valet Service Mode.**

**7 Parking Light Flashes = Manual Transmission Mode Error.**

# TRANSCEIVER / REMOTE CONTROL PROGRAMMING

**Note: All transmitter codes must be learned at time of programming!! The SP-500 learns up to 4 different transmitter codes.**

1. Turn key to the ON position. (Pink wire must be connected.)
2. Press Programming button 4 times, then after a few seconds the unit flashes the parking lights 4 times.
3. Press button #1 of the transmitter to be coded. You should get 2 light flashes indicating the unit is waiting for a 2<sup>nd</sup> code, then press button #1 of a second transmitter, the unit will flash 3 times indicating its waiting for the 3<sup>rd</sup> code and so on. If all 4 codes are learned, the unit will automatically exit code learning mode, otherwise turn key off. See diagram below.

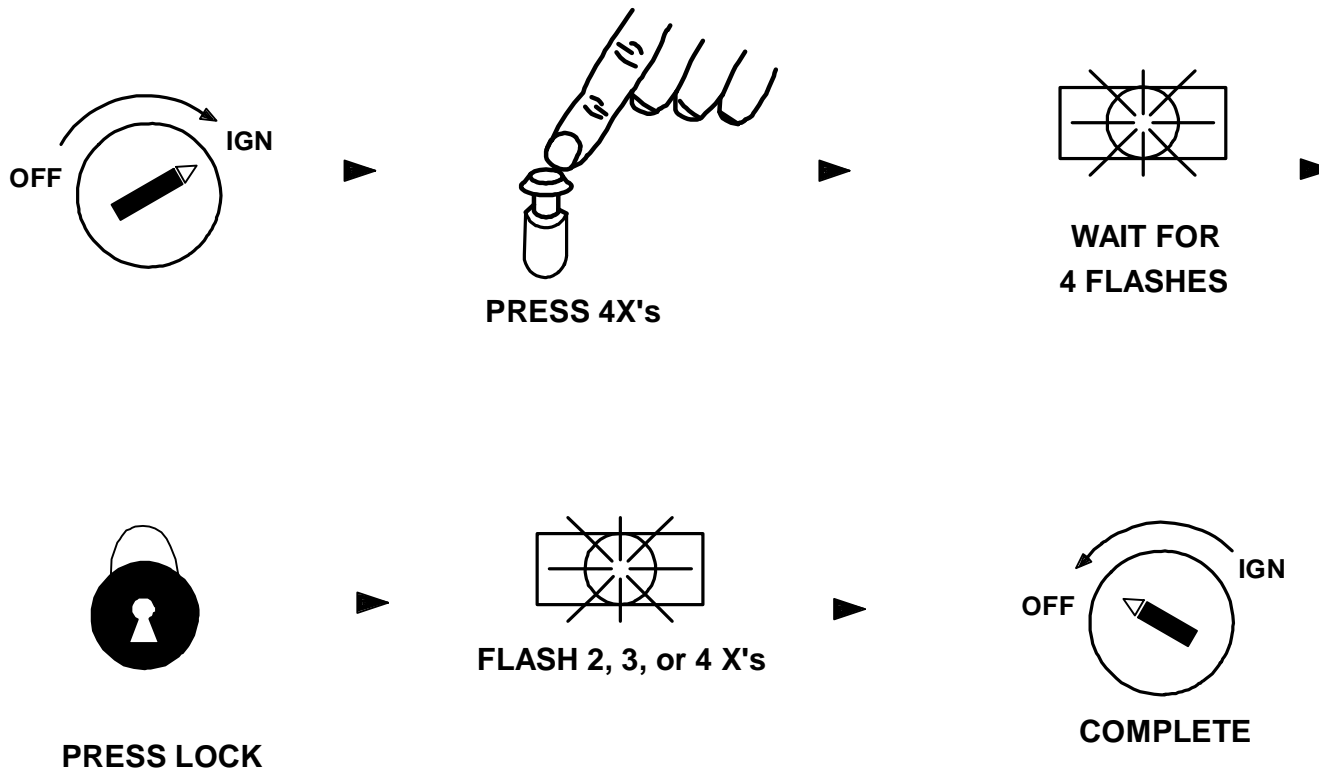



## 2 VEHICLE OPERATION

### 2 VEHICLE CONTROL

Your remotes have the ability to control a second vehicle with a Crimestopper system installed.

To set up the 2-Vehicle operation you must first program your remotes to Vehicle #2. Follow the “Transmitter Programming” steps (Pg. 16) at the second vehicle and learn YOUR remote, along with vehicle #2’s existing remotes.

### 2-VEHICLE NOTES:

(1) You do not have to switch between Vehicle “1” and “2” to get pages from each vehicle. Your remote pager will receive pages from both cars regardless of which vehicle the pager is set to. The “1” or “2” icon will always display with each page indicate which vehicle the page originated from.

(2) When, all remote/pagers and sidekick remotes for that vehicle must be learned at the time of programming. When you program your remote at the second vehicle, that vehicle’s original remote must also be programmed. Your remote should be set in Vehicle “2” and the vehicle’s original remote should be set in Vehicle “1”.

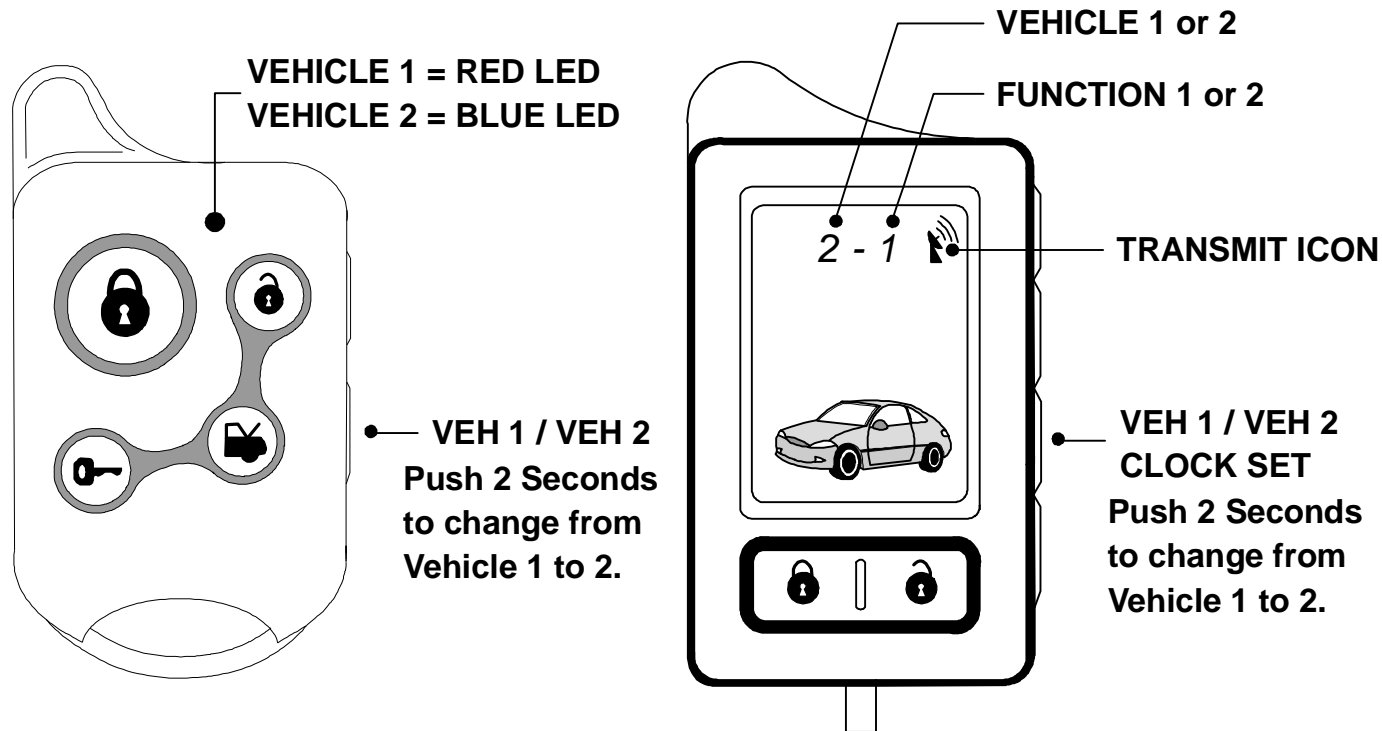

## OPTIONAL TURBO TIMER MODE

The optional Turbo Timer mode allows the CoolStart system to keep a Turbo or Turbo Diesel vehicle running for 1 to 5 minutes [selectively] after you remove the key and exit the vehicle. This is handy for turbo cool-down without the need for expensive turbo timers. This mode requires the use of an extra part called a momentary switch/button that is not included with the kit. There are (3) modes of operation for the Turbo Timer Mode

1. **Brake Pedal Set Mode.** With the engine running by key, **press Remote Start Button with brake pedal depressed.** As you release the brake pedal, the Parking Lights and Status LED will blink the number of minutes for the Turbo Timer setting. The doors unlock after confirmation. The run time can be changed by using the push button switch attached to the green start activation wire (see Always Set Mode).
2. **Always Set Mode (default).** The Turbo Timer Run Time must always be set. With brake pedal depressed and engine running by key, Press the "Turbo Timer" button 1 to 5 times for each minute of run time you desire. (1 press = 1 min.) As you release the brake pedal, your system will confirm by flashing the lights the same number of times the button was pressed. The doors unlock after confirmation. Turn Ignition switch OFF, remove key and exit the vehicle.
3. **Idle Down Mode.** This replaces the normal Idle Down Mode. Can't use Infinity Run or Manual Transmission Mode with this option. **With the engine running by key, press the Remote Start Button.** The Parking Lights and Status LED will blink the number of minutes for the Turbo Timer setting. The doors unlock after confirmation. The run time can be changed by using the push button switch attached to the green start activation wire (see Always Set Mode).

**Note:** Mode 1 and 3, the run timer (1 to 5 min.) is set one time. The system always remembers the Turbo Timer setting even with battery disconnection.

## SETTING THE TURBO TIMER RUN TIME

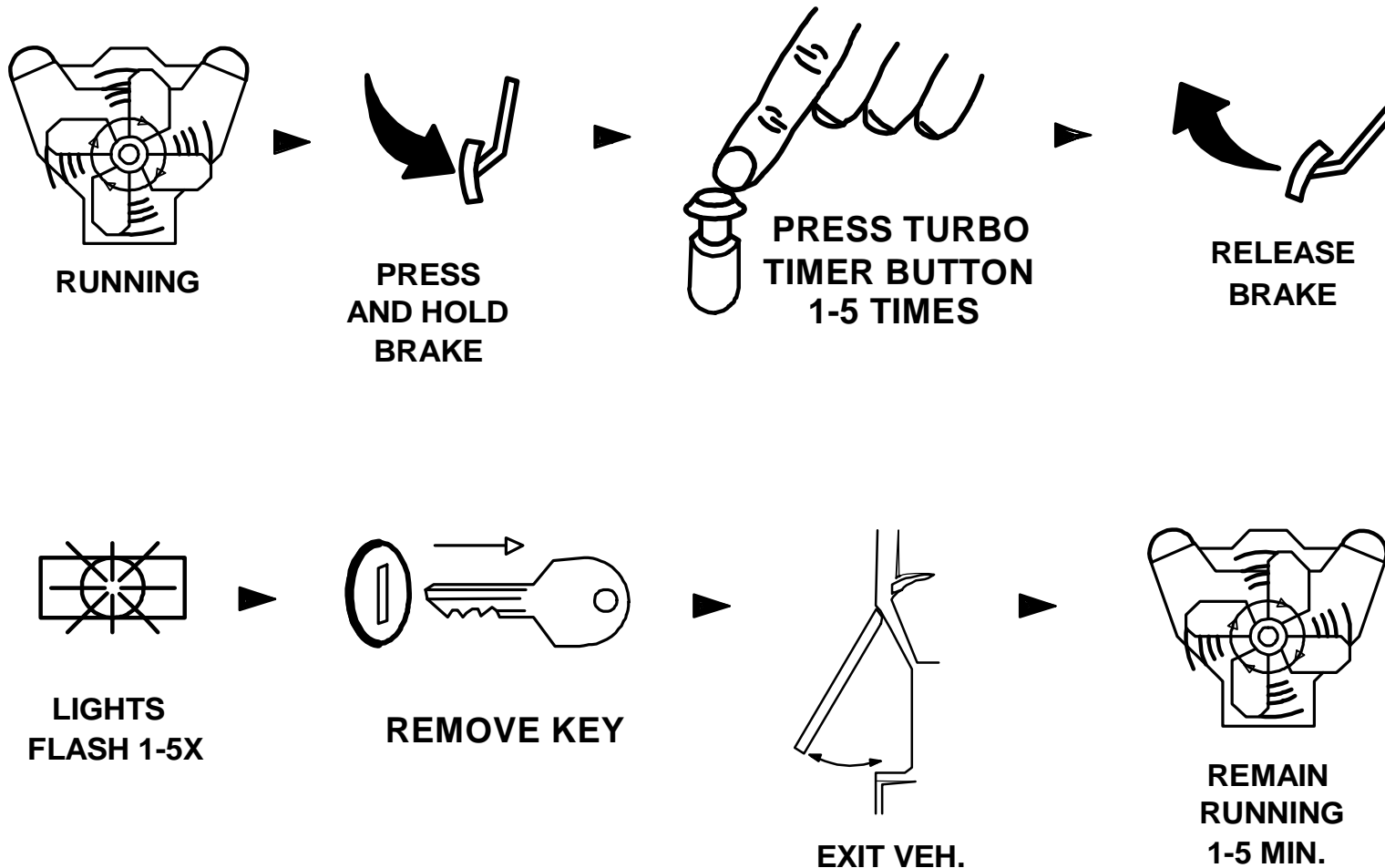

**CAUTION!! IF YOU PRESS THE TURBO TIMER BUTTON WHEN ENGINE IS NOT RUNNING IT WILL TRIGGER A REMOTE START! MAKE A NOTE OF THIS IF YOU HAVE CHILDREN. CONSIDER THIS WHEN CHOOSING A LOCATION FOR YOUR TURBO TIMER BUTTON.**

# BATTERY REPLACEMENT

## LOW BATTERY WARNING

The 2-Way LCD remote has a low battery warning system. When the battery voltage is low, the LCD Pager Remote will show a low voltage icon. We recommend replacing the battery for proper operation. **To replace the battery:** Simply unlatch and slide open the battery door on the back of the remote. Carefully insert a new 1½ Volt AAA using the outline on the bottom of the battery compartment as a guide. Your remote will beep 3 times & vibrate if the battery was inserted correctly. Otherwise, remove the battery and insert again.

## To replace the battery on Sidekick:

The 1-Way Sidekick Remote uses Two CR-2016 Lithium 3 Volt Batteries. Simply remove the two Phillips screws holding the back cover in place. Insert the new batteries with the (+) end toward the circuit board.

## LOW BATTERY

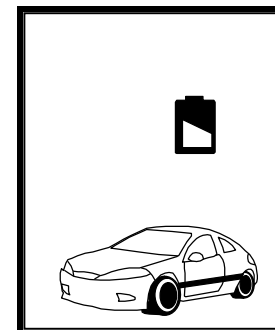

## LOW BATTERY

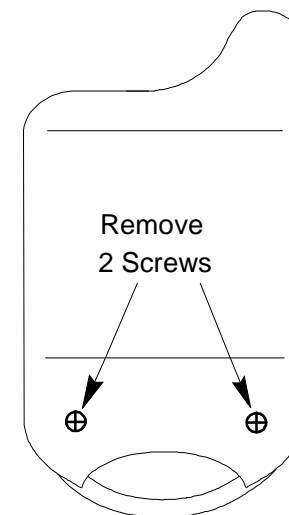

# CRIMESTOPPER

Crimestopper Security Products Inc.  
1770 So. Tapo Street  
Simi Valley, CA 93063  
(800) 998-6880  
[www.crimestopper.com](http://www.crimestopper.com)

©2008 Crimestopper Security Products

# TechWeb

ONLINE TECHNICAL SUPPORT  
[www.crimestopper.com](http://www.crimestopper.com)