

Owner's Manual

Please read before using this unit.

DVD/CD Player with Video Cassette Recorder DV220SL8

SYLVANIA

INSTRUCCIONES EN
ESPAÑOL INCLUIDAS.

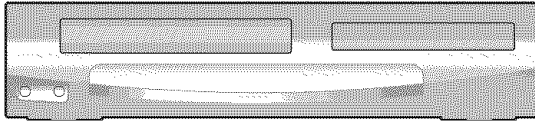

If you need additional operating assistance after reading this owner's manual, please call
TOLL FREE : 1-800-968-3429
or visit our web site at
<http://www.SylvaniaConsumerElectronics.com>

Supplied Accessories

remote control unit
(NB606UD / NB656UD)



RCA audio/video cables
(WPZ0102TM015 / WPZ0102LTE01)

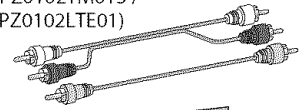

batteries
(AA x 2)



owner's manual
(1VMN23384)

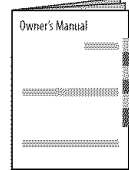

Contents

PRECAUTIONS

Laser Safety.....	2
IMPORTANT SAFEGUARDS	3
Location and Handling.....	4
Avoid the Hazards of Electrical Shock and Fire.....	4
Moisture Condensation Warning.....	4
About Copyright.....	4
Notice for Progressive Scan Outputs.....	4
Symbols Used in This Manual.....	4
Maintenance.....	4
About Cassette Tapes and Discs	5
Playable Media.....	5
Unplayable Discs.....	5

SETUP

Connections	6
Connection to a TV.....	6
Connection to an Audio System.....	7
Connection to a Cable/Satellite Box.....	7
Preparation for Use	8
Turning on Unit for the First Time.....	8
Clock Setting.....	8
Function Overview	9
Front Panel Indicator Lights.....	9
Selecting DVD or VCR Operation.....	9
Front & Rear Terminals.....	9
Remote Control.....	10
Installing the Batteries for the Remote Control.....	10

VCR FUNCTIONS

Playback	11
Other Operations	11
Index Search.....	11
Time Search.....	11
Auto Repeat.....	12
Recording	12
Recording & One-touch Timer Recording (OTR).....	12
Timer Recording.....	12
Notes for Timer Recording & One-touch Timer Recording (OTR).....	13
Satellite Link.....	14

Copying a Cassette Tape.....	14
------------------------------	----

DVD FUNCTIONS

Playback	15
MP3 Playback	16
On-Screen Display	16
Search Functions	17
Using Track Search.....	17
Using Title / Chapter Search.....	17
Using Time Search.....	17
Marker Setting.....	17
Repeat / Random / Programmed Playback	18
Repeat Playback.....	18
Repeat A-B Playback.....	18
Random Playback.....	18
Programmed Playback.....	18
Special Settings	19
Subtitle Language.....	19
Audio Language.....	19
Camera Angles.....	19
Black Level Setting.....	19
Stereo Sound Mode.....	19
Virtual Surround.....	19
DVD Setting	20
LANGUAGE Setting.....	20
DISPLAY Setting.....	21
AUDIO Setting.....	21
PARENTAL Setting.....	22
OTHERS Setting.....	22
Reset to the Default Setting (Except for PARENTAL Setting).....	23

INFORMATION

Troubleshooting Guide	23
Specifications	24
Language Code List	24
LIMITED WARRANTY	24
Español	25
Quick Use Guide	27

Basic TV Connection

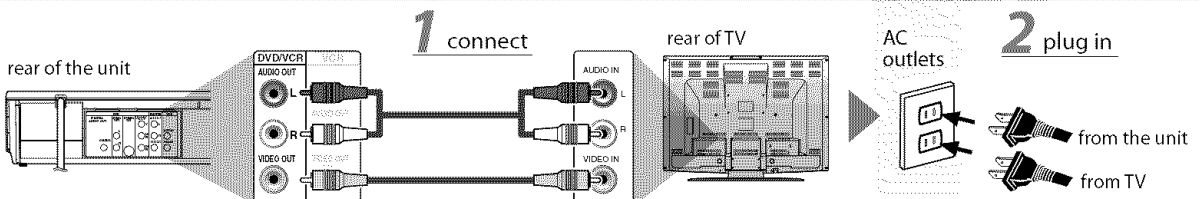

3 Please refer to "Connections" on page 6.

PRECAUTIONS

WARNING: TO REDUCE THE RISK OF FIRE OR ELECTRIC SHOCK, DO NOT EXPOSE THIS APPLIANCE TO RAIN OR MOISTURE.



CAUTION

RISK OF ELECTRIC SHOCK

DO NOT OPEN



CAUTION:
TO REDUCE THE RISK OF ELECTRIC SHOCK, DO NOT REMOVE COVER (OR BACK). NO USER SERVICEABLE PARTS INSIDE. REFER SERVICING TO QUALIFIED SERVICE PERSONNEL.



The lightning flash with arrowhead symbol, within an equilateral triangle, is intended to alert the user to the presence of uninsulated "dangerous voltage" within the product's enclosure that may be of sufficient magnitude to constitute a risk of electric shock to persons.



The exclamation point within an equilateral triangle is intended to alert the user to the presence of important operating and maintenance (servicing) instructions in the literature accompanying the appliance.

The caution marking is located on the rear of the cabinet.

Laser Safety

This unit employs a laser. Only a qualified service person should remove the cover or attempt to service this device, due to possible eye injury.

CAUTION: USE OF CONTROLS OR ADJUSTMENTS OR PERFORMANCE OF PROCEDURES OTHER THAN THOSE SPECIFIED HEREIN MAY RESULT IN HAZARDOUS RADIATION EXPOSURE.

CAUTION: VISIBLE AND INVISIBLE LASER RADIATION WHEN OPEN AND INTERLOCK DEFEATED. DO NOT STARE INTO BEAM.

LOCATION: INSIDE, NEAR THE DECK MECHANISM.

FCC WARNING - This equipment may generate or use radio frequency energy. Changes or modifications to this equipment may cause harmful interference unless the modifications are expressly approved in the manual. The user could lose the authority to operate this equipment if an unauthorized change or modification is made.

RADIO-TV INTERFERENCE

This equipment has been tested and found to comply with the limits for a Class B digital device, pursuant to Part 15 of the FCC Rules. These limits are designed to provide reasonable protection against harmful interference in a residential installation. This equipment generates, uses, and can radiate radio frequency energy and, if not installed and used in accordance with the instructions, may cause harmful interference to radio communications. However, there is no guarantee that interference will not occur in a particular installation. If this equipment does cause harmful interference to radio or television reception, which can be determined by turning the equipment off and on, the user is encouraged to try to correct the interference by one or more of the following measures:

- 1) Reorient or relocate the receiving antenna.
- 2) Increase the separation between the equipment and receiver.
- 3) Connect the equipment into an outlet on a circuit different from that to which the receiver is connected.
- 4) Consult the dealer or an experienced radio/TV technician for help.

This Class B digital apparatus complies with Canadian ICES-003.

Cet appareil numérique de la classe B est conforme à la norme NMB-003 du Canada.

CAUTION: TO PREVENT ELECTRIC SHOCK, MATCH WIDE BLADE OF PLUG TO WIDE SLOT, FULLY INSERT.

ATTENTION: POUR ÉVITER LES CHOCS ÉLECTRIQUES, INTRODUIRE LA LAME LA PLUS LARGE DE LA FICHE DANS LA BORNE CORRESPONDANTE DE LA PRISE ET POUSSER JUSQU'AU FOND.

A NOTE ABOUT RECYCLING

This product's packaging materials are recyclable and can be reused. Please dispose of any materials in accordance with your local recycling regulations.

Batteries should never be thrown away or incinerated but disposed of in accordance with your local regulations concerning chemical wastes.

Make your contribution to the environment!!!

- Used up batteries do not belong in the dust bin.
- You can dispose of them at a collection point for used up batteries or special wastes. Contact your council for details.



For Customer Use:
Read carefully the information located at the back of this unit and enter below the Model No. and the Serial No. Retain this information for future reference.

Model No. _____

Serial No. _____

IMPORTANT SAFEGUARDS

1. Read Instructions - All the safety and operating instructions should be read before the appliance is operated.
2. Retain Instructions- The safety and operating instructions should be retained for future reference.
3. Heed Warnings - All warnings on the appliance and in the operating instructions should be adhered to.
4. Follow Instructions - All operating and use instructions should be followed.
5. Cleaning - Unplug this video product from the wall outlet before cleaning. Do not use liquid cleaners or aerosol cleaners. Use a damp cloth for cleaning.
EXCEPTION: A product that is meant for uninterrupted service and, that for some specific reason, such as the possibility of the loss of an authorization code for a CATV converter, is not intended to be unplugged by the user for cleaning or any other purpose, may exclude the reference to unplugging the appliance in the cleaning description otherwise required in item 5.
6. Attachments - Do not use attachments not recommended by the video product manufacturer as they may cause hazards.
7. Water and Moisture- Do not use this video product near water, for example, near a bath tub, wash bowl, kitchen sink, or laundry tub, in a wet basement, or near a swimming pool, and the like.
8. Accessories - Do not place this video product on an unstable cart, stand, tripod, bracket, or table. The video product may fall, causing serious injury to a child or adult, and serious damage to the appliance. Use only with a cart, stand, tripod, bracket, or table recommended by the manufacturer, or sold with the video product. Any mounting of the appliance should follow the manufacturer's instructions and should use a mounting accessory recommended by the manufacturer. An appliance and cart combination should be moved with care. Quick stops, excessive force, and uneven surfaces may cause the appliance and cart combination to overturn.
9. Ventilation - Slots and openings in the cabinet are provided for ventilation and to ensure reliable operation of the video product and to protect it from overheating, and these openings must not be blocked or covered. The openings should never be blocked by placing the video product on a bed, sofa, rug, or other similar surface. This video product should not be placed in a built-in installation such as a bookcase or rack unless proper ventilation is provided or the manufacturer's instructions have been adhered to.
10. Power Sources - This video product should be operated only from the type of power source indicated on the marking label. If you are not sure of the type of power supply to your home, consult your appliance dealer or local power company. For products intended to operate from battery power, or other sources, refer to the operating instructions.
11. Grounding or Polarization - This video product is equipped with a polarized alternating-current line plug (a plug having one blade wider than the other). This plug will fit into the power outlet only one way. This is a safety feature. If you are unable to insert the plug fully into the outlet, try reversing the plug. If the plug should still fail to fit, contact your electrician to replace your obsolete outlet. Do not defeat the safety purpose of the polarized plug.

PORTABLE CART WARNING
(Symbol provided by RETAC)



12. Power Cord Protection - Power supply cords should be routed so that they are not likely to be walked on or pinched by items placed upon or against them, paying particular attention to cords at plugs, convenience receptacles, and the point where they exit from the appliance.
13. Lightning - For added protection for this video product during a lightning storm, or when it is left unattended and unused for long periods of time, unplug it from the wall outlet. This will prevent damage to the video product due to lightning and power-line surges.
14. Power Lines - An outside antenna system should not be located in the vicinity of overhead power lines or other electric light or power circuits, or where it can fall into such power lines or circuits. When installing an outside antenna system, extreme care should be taken to keep from touching such power lines or circuits as contact with them might be fatal.
15. Overloading - Do not overload wall outlets and extension cords as this can result in a risk of fire or electric shock.
16. Object and Liquid Entry - Never push objects of any kind into this video product through any openings as they may touch dangerous voltage points or short-out parts that could result in a fire or electric shock. Never spill liquid of any kind on the video product.
17. Servicing - Do not attempt to service this video product yourself as opening or removing covers may expose you to dangerous voltage or other hazards. Refer all servicing to qualified service personnel.
18. Damage Requiring Service - Unplug this video product from the wall outlet and refer servicing to qualified service personnel under the following conditions:
 - a. When the power-supply cord or plug is damaged.
 - b. If liquid has been spilled, or objects have fallen into the video product.
 - c. If the video product has been exposed to rain or water.
 - d. If the video product does not operate normally by following the operating instructions. Adjust only those controls that are covered by the operating instructions as an improper adjustment of other controls may result in damage and will often require extensive work by a qualified technician to restore the video product to its normal operation.
 - e. If the video product has been dropped or damaged in any way.
 - f. When the video product exhibits a distinct change in performance this indicates a need for service.
19. Replacement Parts - When replacement parts are required, be sure the service technician has used replacement parts specified by the manufacturer or have the same characteristics as the original part. Unauthorized substitutions may result in fire, electric shock or other hazards.
20. Safety Check - Upon completion of any service or repairs to this video product, ask the service technician to perform safety checks to determine that the video product is in proper operating condition.
21. Heat - This video product should be situated away from heat sources such as radiators, heat registers, stoves, or other products (including amplifiers) that produce heat.

Location and Handling

- Do not stand this unit up vertically. Install this unit in a horizontal and stable position. Do not place anything directly on top of this unit. Do not place this unit directly on top of the TV.
- Depending on the TV, noise or disturbance of the picture and/or sound may be generated if this unit is placed too close to your TV. In this case, please ensure enough space between your TV and this unit.
- Do not cover or place this unit in enclosed spaces to prevent excessive temperature build up.
- Do not place this unit in direct sunlight, or near heat sources.
- Depending on the environment, the temperature of this unit may increase slightly. This is not a malfunction.
- Keep this unit away from strong magnetic objects.
- Do not place any object containing water or other liquids on this unit. In the event that liquid should enter the cabinet, unplug this unit immediately and contact the retailer or an authorized service center immediately.
- Do not remove this unit cabinet. Touching parts inside the cabinet could result in electric shock and/or damage to this unit. For service and adjustment inside the cabinet, call a qualified dealer or an authorized service center.
- Be sure to remove disc and cassette tape and unplug the AC power cord from the output before carrying this unit.

Avoid the Hazards of Electrical Shock and Fire

- Do not handle the power cord with wet hands.
- Do not pull on the power cord when disconnecting it from AC outlet. Grasp it by the plug.
- If, by accident, water is spilled on this unit, unplug the power cord immediately and take the unit to our authorized service center for servicing.
- Do not put your fingers or objects into the unit cassette holder.

Moisture Condensation Warning

Moisture may form inside this unit under the following conditions:

- Immediately after a heater is turned on.
 - In a steamy or humid room.
 - When this unit is suddenly moved from a cold to warm environment.
- If moisture forms inside this unit, it may not operate properly or damage the cassette tape. In such case, do not use this unit at least for 2 hours until its inside gets dry.

About Copyright

Unauthorized copying, broadcasting, public performance and lending of discs are prohibited.

This product incorporates copyright protection technology that is protected by U.S. patents and other intellectual property rights. Use of this copyright protection technology must be authorized by Macrovision, and is intended for home and other limited viewing uses only unless otherwise authorized by Macrovision. Reverse engineering or disassembly is prohibited.

Notice for Progressive Scan Outputs

Consumers should note that not all high definition television sets are fully compatible with this product and may cause artifacts to be displayed in the picture. In case of picture problems with 525 progressive scan output, it is recommended that the user switch the connection to the 'standard definition' output. If there are questions regarding your TV set compatibility with this 525p DVD player, please contact our customer service center.

Symbols Used in This Manual

The following symbols appear in some headings in this manual.

 : Description refers to video cassette tapes.

 : Description refers to DVD-video.

 : Description refers to audio CD.

 : Description refers to CD-RW/-R with MP3 files.

Note to CATV system installer:

- This reminder is provided to call the CATV system installer's attention to Article 820-40 of the NEC that provides guidelines for proper grounding and, in particular, specifies that the cable ground should be connected to the grounding system of the building, as close to the point of cable entry as practical.

Maintenance

Servicing

- Please refer to relevant topics on the "Troubleshooting Guide" on page 23 before returning the product.
- If this unit becomes inoperative, do not try to correct the problem by yourself. There are no user-serviceable parts inside. Turn off, unplug the power plug, and please call our toll free customer support line found on the cover of this manual to locate an authorized service center.

Cleaning the Cabinet

- Use a soft cloth slightly moistened with a mild detergent solution. Do not use a solution containing alcohol, spirits, ammonia or abrasive.

Cleaning Discs

- When a disc becomes dirty, clean it with a cleaning cloth. Wipe the disc from the center to out. Do not wipe in a circular motion.
- Do not use solvents such as benzene, thinner, commercially available cleaners, detergent, abrasive cleaning agents or antistatic spray intended for analog records.

Cleaning the Disc Lens

- If this unit continues to perform improperly even after you have referred to the relevant sections and to the "Troubleshooting Guide" in this manual, the laser optical pickup unit may be dirty. Consult your dealer or an authorized service center for inspection and cleaning of the laser optical pickup unit.

Disc Handling

- When you handle a disc, hold it by its edge and try not to touch the surface of the disc.
- Always store the disc in its protective case when not in use.

Auto Head Cleaning

- Automatically cleans video heads as you insert or remove a cassette tape, so you can see a clear picture.
- Playback picture may become blurred or interrupted while the TV program reception is clear. Dirt accumulated on the video heads after a long period of use, or the usage of rental or worn cassette tapes can cause this problem. If a streaky or snowy picture appears during playback, the video heads in your unit may need to be cleaned.
 1. Please visit your local audio/video store and purchase a good quality VHS video head cleaner.
 2. If a Video head cleaner does not solve the problem, please call our toll free customer support line found on the cover of this manual to locate an authorized service center.

Note:

- Remember to read the instructions along with the video head cleaner before use.
- Clean video heads only when problems occur.

© 2007 Funai Electric Co., Ltd.

All rights reserved. No part of this manual may be reproduced, copied, transmitted, disseminated, transcribed, downloaded or stored in any storage medium, in any form or for any purpose without the express prior or written consent of Funai. Furthermore, any unauthorized commercial distribution of this manual or any revision hereto is strictly prohibited.

Information in this document is subject to change without notice. Funai reserves the right to change the content herein without the obligation to notify any person or organization of such changes.

FUNAI with the  design is a registered trademark of Funai Electric Co., Ltd and may not be used in any way without the express written consent of Funai. All other trademarks used herein remain the exclusive property of their respective owners. Nothing contained in this manual should be construed as granting, by implication or otherwise, any license or right to use any of the trademarks displayed herein. Misuse of any trademarks or any other content in this manual is strictly prohibited. Funai shall aggressively enforce its intellectual property rights to the fullest extent of the law.



Manufactured under license from Dolby Laboratories. "Dolby" and the double-D symbol are trademarks of Dolby Laboratories.

About Cassette Tapes and Discs

Playable Media

Type of media	Mark (logo)	Region code	Recorded signals	Media size	Tape speed and disc types
cassette tape		—	analog video	tape width 1/2 inches (12.65 mm)	SP: 1-5/16 inch/sec. (33.40 mm/sec.) SLP: 7/16 inch/sec. (11.12 mm/sec.)
DVD-video *1, 2, 3, 5, 9		or	digital video (MPEG2)	5 inches (12 cm) or 3 inches (8 cm)	<p>e.g.) title 1 title 2 chapter 1 chapter 2 chapter 3 chapter 4 chapter 1 chapter 2</p>
DVD-RW DVD-R *1, 3, 4, 5, 6, 8, 9, 10	 	—			
DVD+RW DVD+R *1, 3, 4, 5, 7, 8, 9, 10	 	—			
audio CD *3, 5, 9		—	digital audio or MP3	5 inches (12 cm) or 3 inches (8 cm)	<p>e.g.) track 1 track 2 track 3 track 4 track 5 track 6</p> <p>e.g.) folder 1 folder 2 file 1 file 2 file 3 file 4 file 5 file 6</p>
CD-RW CD-R *3, 4, 5, 8, 9	 	—			

is a trademark of DVD Format/Logo Licensing Corporation.

If you cannot play back a disc which bears one of the marks above, check the following.

- *1: This unit conforms to the NTSC color system. Discs recorded in other color systems such as PAL cannot be played back.
- *2: Certain DVD-video does not operate as described in this manual due to the intentions of the disc's producers.
- *3: Scratched or stained discs may not be played back.
- *4: Some discs cannot be played back because of incompatible recording conditions, characteristics of the recorder or special properties of discs.
- *5: You can play back discs which bear the marks above. If you use nonstandardized discs, this unit may not play them back. Even if they are played back, the sound or video quality will be compromised.
- *6: You may play back the unfinalized DVD-RW/-R recorded in the video format on our brand's DVD recorder. However, depending on the recording status of a disc, the disc may not be played back at all or normally (the picture or sound may not be smooth, etc.). In this case, you need to finalize the disc with the DVD recorder. Refer to the manual accompanying the DVD recorder.
- *7: Only discs recorded in the video format and finalized can be played back.
Unfinalized discs cannot be played back. Depending on the recording status of a disc, the disc may not be played back at all (the picture or sound may not be smooth, etc.).
- *8: If the recorded portion of the disc is too small (less than 2-3/16 inches (55 mm) across), it may not play back properly.
- *9: Do not glue paper or put stickers on to the disc. These may damage the disc, and the unit may not read it correctly.
- *10: Discs recorded in the VR (video recording) format cannot be played back.

Unplayable Discs

NEVER play the following discs as malfunction may result!

DVD-RAM, DVD-audio, CD-i, photo CD, video CD, DVD with region codes other than 1 or ALL, DTS-CD, DVD-ROM for personal computers, CD-ROM for personal computers

On the following disc, the sound MAY NOT be heard.

super audio CD

Note:

- Only the sound recorded on the normal CD layer can be delivered. The sound recorded on the high density super audio CD layer cannot be delivered.

Any other discs without compatibility indications

SETUP

Connections

Connection to a TV

Please refer to "Basic TV Connection" on the front page before you use this unit.

VCR and Basic DVD Connection

Available for DVD only

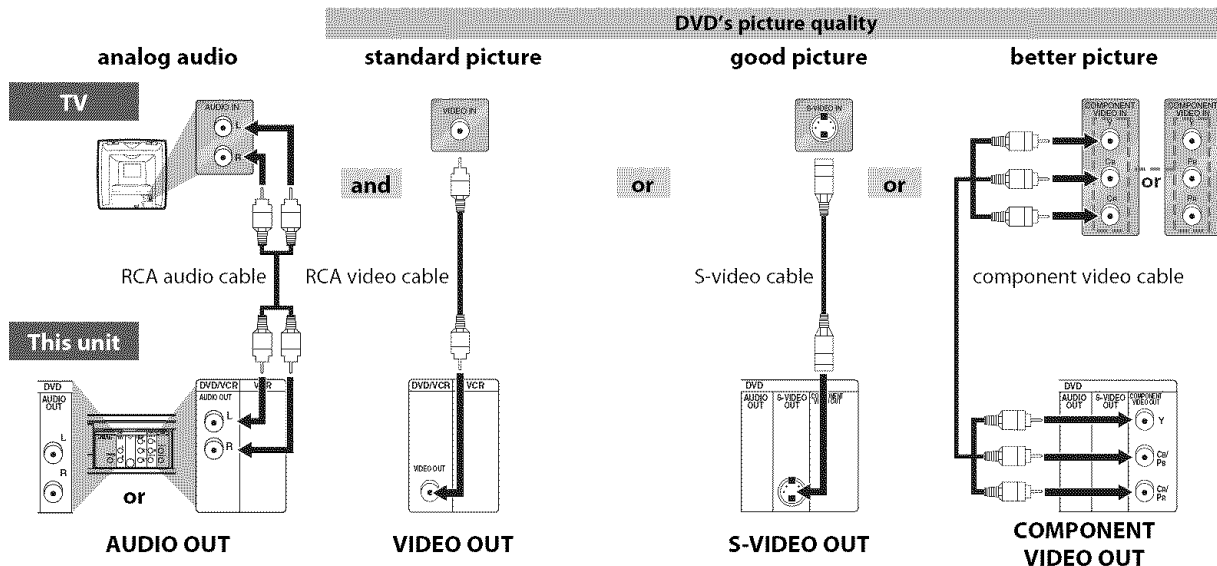

Supplied cables used in this connection are as follows:

- RCA audio cable (L/R) x 1
- RCA video cable x 1

Please purchase the rest of the necessary cables at your local store.

Note:

- Connect this unit directly to your TV. If an RCA audio/video cables are connected to a VCR, pictures may be distorted due to the copy protection system.
- DIGITAL AUDIO OUT (COAXIAL), DVD AUDIO OUT, S-VIDEO OUT and COMPONENT VIDEO OUT jacks are only useful in DVD mode.

If your TV is compatible with 525 (480) progressive scanning, and you want to enjoy that high quality picture for DVD playing:

You must select the connection COMPONENT VIDEO OUT above and progressive scanning mode. To set the mode, set "PROGRESSIVE" to "ON" in "DISPLAY" menu, so that the PROGRESSIVE SCAN indicator on this unit lights up. Refer to pages 20-21 for more details.

- When "PROGRESSIVE" is "ON", video signals from the unit's VIDEO OUT and S-VIDEO OUT jacks will be distorted or not be output at all for DVD playing. The picture will be OK for VCR use from the VIDEO OUT jack.

If your TV is not compatible with progressive scanning:

Use this unit in interlace mode and set "PROGRESSIVE" to "OFF" either in "DISPLAY" menu or by pressing and holding [PLAY ►] on the front of the unit on the DVD side for more than 5 seconds, so that the PROGRESSIVE SCAN indicator on this unit turns off.

After connecting to your TV:

You will need to switch to video input on your TV. This is usually marked TV/VIDEO, INPUT or AUX. Please refer to your TV's owner's manual for details.

Input modes for common TV brands:

Listed below are inputs for common brand name TV's.

Admiral:	AUX	Panasonic:	TV/VIDEO
Curtis Mathis:	LINE1, LINE2, 00, 90, 91, 92, 93	RCA:	INPUT, TV/VCR, 00, 90, 91, 92, 93
GE:	INPUT, TV/VCR, 00, 90, 91, 92, 93	Samsung:	TV/VIDEO
Hitachi:	INPUT, AUX	Sanyo:	VIDEO
JVC:	VIDEO, VIDEO1, VIDEO2, VIDEO3	Sharp:	00
Kenwood:	AUX	Sony:	VIDEO1, VIDEO2, VIDEO3
LXI-Series:	00	Toshiba:	TV/GAME
Magnavox:	AUX CHANNEL	Zenith:	00

Connection to an Audio System

Playing 2 Channel Analog Audio

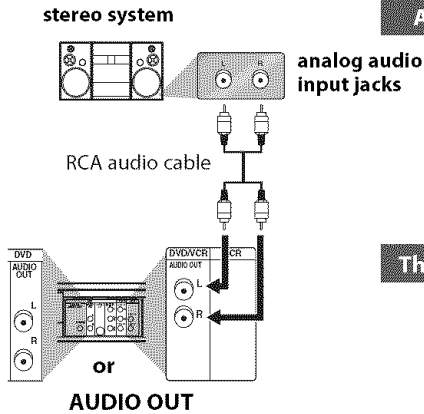

Audio

Playing Multi Channel Digital Audio

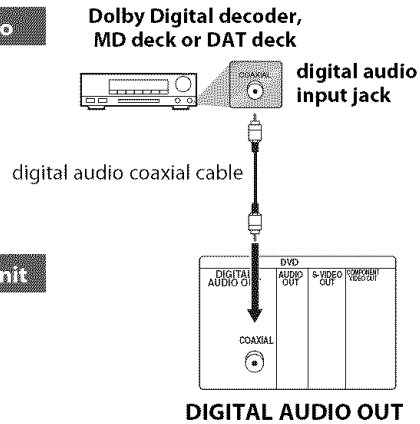

This unit

DIGITAL AUDIO OUT

Supplied cables used in this connection are as follows:

- RCA audio cable (L/R) x 1
- Please purchase the rest of the necessary cables at your local store.

Connection	Setting	SETUP > QUICK > DOLBY DIGITAL
Connecting to a Dolby Digital decoder for Dolby Digital audio output.		BITSTREAM
Connecting to other device (an MD deck or DAT deck etc.) without Dolby Digital decoder.		PCM

* To complete these settings, refer to pages 20-21.

Note:

- The audio source on a disc in a Dolby Digital multi channel surround format cannot be recorded as digital sound by an MD or DAT deck.
- By hooking this unit up to a Dolby Digital decoder, you can enjoy high-quality Dolby Digital multi channel surround sound as heard in the movie theaters.
- Playing back a DVD using incorrect settings may generate noise distortion and may also damage the speakers.

Connection to a Cable/Satellite Box

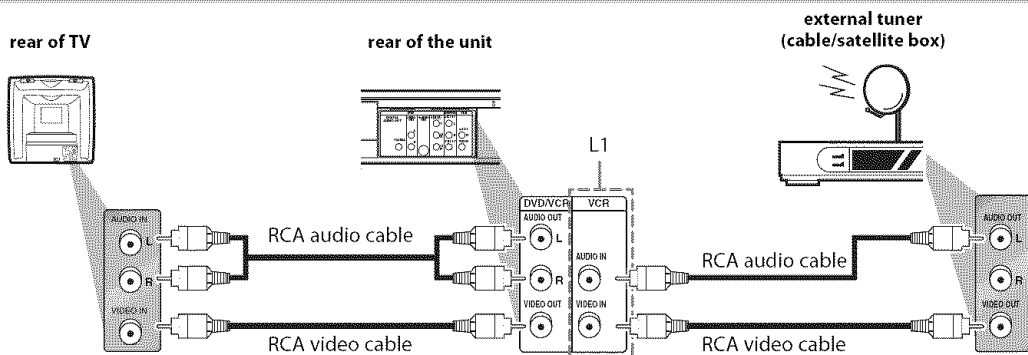

Using the unit with a cable/satellite box

1. Connect an RCA audio and video cables to the audio and video output jacks of your cable/satellite box and to the audio and video input jacks at the rear of the unit.
2. Press [INPUT SELECT] on your remote control until "L1" is displayed on your TV.

Note:

- Your cable/satellite box can be accessed only by connecting it to L1 (rear panel jacks) of the unit. Even if the unit is turned off, the signal from the external tuner is output to the TV through the unit.

L1: Rear panel terminals
L2: Front panel terminals

Refer to "Front & Rear Terminals" on page 9 for more information.

Supplied cables used in this connection are as follows:

- RCA audio cable (L/R) x 1
 - RCA video cable x 1
- Please purchase the rest of the necessary cables at your local store.

Special note when connected to a cable/satellite box:

- Only the active channel on your cable/satellite box may be viewed or recorded when connected to this unit. Do not change channels during a recording. You cannot record on channel while viewing another.
- Always use the LEFT (white) audio output jack from the external tuner to ensure that the audio is mixed down correctly to mono for this unit. If you use the RIGHT (red) jack, you will record the right audio only.

Preparation for Use

Turning on Unit for the First Time



Please note: most instructions in this manual refer to remote control use.

1 Be sure your TV's input is set to VIDEO. (Name may vary with TV manufacturer. See your TV manual for details.)



2 Select your on-screen language. Then press **[▶]** to continue.

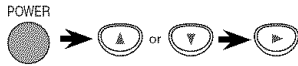

3 When "CLOCK SET" menu appears, go to step 2 in "Clock Setting" on this page.

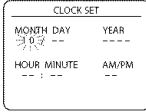

To Change the Selected On-screen Language

1 Press **[SETUP]** until the main menu appears.

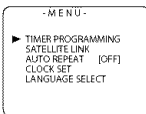

2 Select "LANGUAGE SELECT". Then press **[▶]** to go to next step.

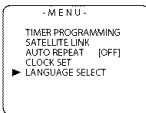

3 Select "ENGLISH", "FRANCAIS" or "ESPAÑOL". Then press **[CLEAR/C.RESET]**.

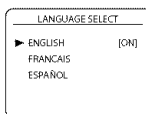

Note:

- If you accidentally select Spanish or French and need English: Press **[SETUP]** and choose "SELEC. IDIOMA" or "SELECTION LANGUE". Press **[▶]** and select "ENGLISH". Finally, press **[CLEAR/C.RESET]**.

Clock Setting



1 Press **[SETUP]** and select "CLOCK SET". Then press **[▶]** to go to next step.

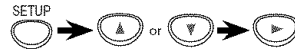

- If the clock is not set, the "CLOCK SET" menu appears when you press **[SETUP]**. In this case, go to step 2.

2 Select the current month. Then press **[▶]** to go to next step.

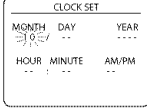

3 Select the current day. Then press **[▶]** to go to next step.

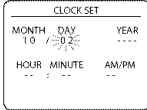

4 Select the current year. Then press **[▶]** to go to next step.

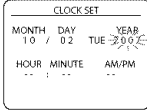

5 Select the current hour. Then press **[▶]** to go to next step.

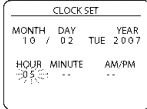

6 Select the current minute. Then press **[▶]** to go to next step.

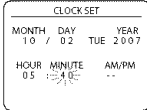

7 Select "AM" or "PM".

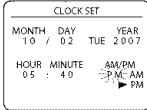
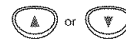

8 Press **[SETUP]** to exit the "CLOCK SET" menu.



Note:

- To go back, press **[◀]** during steps 2 to 7.
- Clock setting will be lost after a power failure, or this unit has been unplugged for more than 30 seconds.

Function Overview

Front Panel Indicator Lights

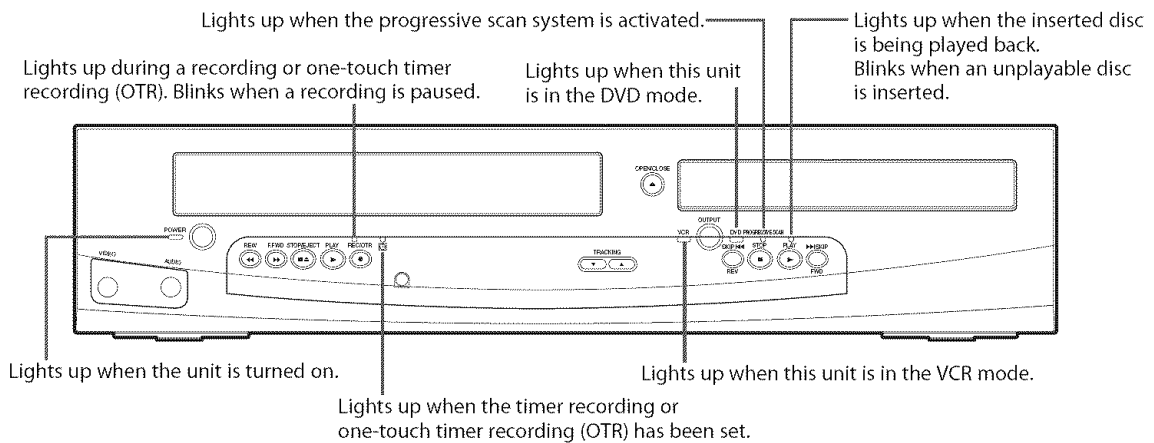

Selecting DVD or VCR Operation

You must first select either DVD or VCR operation.

VCR MODE

Press **[VCR ∞]** on the remote control.
(The VCR OUTPUT light will illuminate.)

DVD MODE

Press **[DVD ⊙]** on the remote control.
(The DVD OUTPUT light will illuminate.)

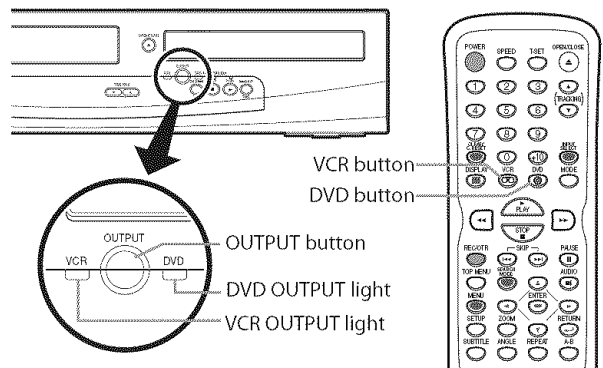

Front & Rear Terminals

rear panel

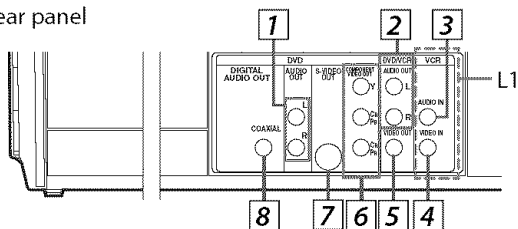

1: DVD AUDIO OUT* (analog) jacks

Connect an audio cable from here to the audio input jack of your television or audio device.

2: DVD/VCR AUDIO OUT jacks

Connect an audio cable from here to the audio input jack of your television or audio device. Standard connection for DVD/VCR use.

3: VCR AUDIO IN jack

Connect a monaural audio cable from the audio output jack of your camcorder, VCR, etc. to here. After making the connection, press **[INPUT SELECT]** on the remote control. Select "L1" to activate the rear AUDIO IN jack, or "L2" to activate the front.

4: VCR VIDEO IN jack

Connect a video cable from the video output jack of your camcorder, VCR, etc. to here. After making the connection, press **[INPUT SELECT]** on the remote control. Select "L1" to activate the rear VIDEO IN jack, or "L2" to activate the front.

front panel

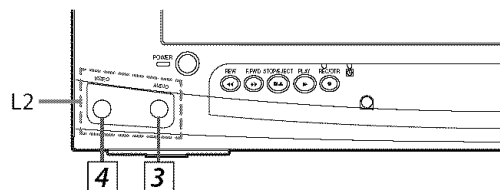

5: DVD/VCR VIDEO OUT jack

Connect a video cable from here to the VIDEO input jack of your television or audio device. Standard connection for DVD/VCR use.

6: COMPONENT VIDEO OUT* jacks

Connect component video cables from here to the component video input jacks of your television.

7: S-VIDEO OUT* jack

Connect an S-video cable from here to the S-video input jack of your television.

8: DIGITAL AUDIO OUT COAXIAL* jack

Connect a digital audio coaxial cable from here to the digital audio input jack of your digital audio receiver.

* For enhanced DVD viewing. DVD/VCR video and audio connection required to view cassette tapes.

Note:

• Audio and video cables are included for both VCR and DVD viewing. You can enhance your DVD picture and sound quality with an S-video cable, component video cables, or a digital audio coaxial cable. **Please purchase the necessary cables at your local store.** (Refer to pages 6-7.)

Remote Control

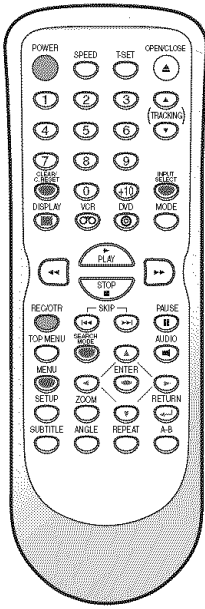

Installing the Batteries for the Remote Control

Install the batteries (AA x 2) matching the polarity indicated inside battery compartment of the remote control.

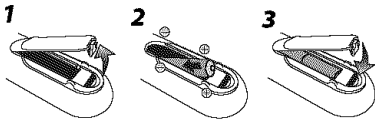

Keep in mind the following when using the remote control:

- Make sure that there are no obstacles between the remote control and the infra-red sensor window on the unit.
- The maximum operable ranges from the unit are as follows.
 - **Line of sight:** approx. 23 feet (7m)
 - **Either side of center:** approx. 16 feet (5m) within 30°
 - **Above:** approx. 16 feet (5m) within 15°
 - **Below:** approx. 10 feet (3m) within 30°

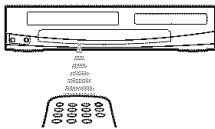

Note:

- Do not mix alkaline and manganese batteries.
- Do not mix old and new batteries.
- Always remove batteries from remote control if they are dead or if the remote control is not to be used for an extended period of time. This will prevent battery acid from leaking into the battery compartment.
- If you turn off this unit, [OPEN/CLOSE ▲] on the remote control is not available. Be sure to use [OPEN/CLOSE ▲] or [STOP/EJECT ■] on the unit.

Button (Alphabetical order)	DVD mode		VCR mode
	DVD	CD MP3	VHS
1 2 3 4 5 6 7 8 9 0	• To select chapter or title directly.	• To select track or file directly.	—
◀ ▶	• To search forward/backward through a disc. • To begin slow forward/reverse playback in the pause mode.	• To search forward/backward through a disc.	• To forward/backward a tape. • To begin slow forward playback in the pause mode.
A-B	• To repeat between your chosen point of A and B.	• To repeat between your chosen point of A and B. (CD)	—
ANGLE	• To select camera angles on a disc.	—	—
AUDIO	• To select audio languages on a disc.	• To select "STEREO", "L-ch" or "R-ch". (CD)	—
CLEAR/RESET	• To clear the markers. • To clear numbers entered incorrectly. • To cancel the point for A-B repeat.	• To clear the markers. (CD) • To remove status number in program input. • To clear numbers entered incorrectly. • To cancel the point for A-B repeat. (CD)	• To exit the VCR menu. • To reset the tape counter.
DISPLAY	• To display the current disc mode.	• To display the current disc mode.	• To display the current time, tape counter, and L1 or L2.
DVD	• To select DVD output mode. • To activate DVD mode.	• To select the DVD output mode. • To activate DVD mode.	—
◀ ENTER ▶ Y	• To move the cursor and determine its position.	• To move the cursor and determine its position.	• To select an item on the VCR menu. • To advance to the next VCR menu. • To go back one step during clock and timer programming.
INPUT SELECT	—	—	• To select input "L1" or "L2".
MENU	• To call up the disc menu on a disc.	• To call up the file list. (MP3)	—
MODE	• To set black level on/off. • To set virtual surround on/off.	• To arrange the playing order or play randomly. • To set virtual surround on/off.	—
OPEN/CLOSE ▲	• To open or close the disc tray.	• To open or close the disc tray.	• To eject the cassette tape from the cassette compartment.
PAUSE	• To pause disc playback. • To advance playback one frame at a time.	• To pause disc playback.	• To pause tape playback or recording. • To advance playback one frame at a time.
▶ PLAY	• To begin disc playback.	• To begin disc playback.	• To begin tape playback.
POWER	• To turn the unit on/off.	• To turn the unit on/off.	• To turn the unit on/off.
REC/OTR	—	—	• To start recording or one-touch timer recording (OTR).
REPEAT	• To play back a chapter or title repeatedly.	• To play back a track or disc repeatedly. (CD) • To play back a file, folder or disc repeatedly. (MP3)	• To select the repeat mode on/off.
RETURN	• To return to the previous operation in menu.	• To return to the previous operation in menu.	—
SEARCH	• To search chapter, title or time. • To set or search the markers.	• To search track. • To search time. (CD) • To set or search the markers. (CD)	• To call up the index or time search menu.
SETUP	• To call up the DVD menu.	• To call up the DVD menu.	• To call up the VCR menu.
◀ SKIP ▶	• To skip chapters or titles.	• To skip tracks or files.	—
SPEED	—	—	• To select the recording speed.
STOP	• To stop playback.	• To stop playback.	• To stop playback or recording.
SUBTITLE	• To select subtitles on a disc.	—	—
TOP MENU	• To call up the top menu on a disc.	• To return to the top file of the highest hierarchy in the program and file list. (MP3)	—
TRACKING	—	—	• To adjust the tracking manually during playback.
T-SET	—	—	• To put the VCR into standby mode for a timer recording.
VCR	—	—	• To select the VCR output mode. • To activate VCR mode.
ZOOM	• To magnify part of a picture. (2x/4x)	—	—

VCR FUNCTIONS

Playback

Before: Turn on the TV.



1 Insert a cassette tape into this unit. 	2 To start playback
3 To stop playback 	4 To eject the cassette tape

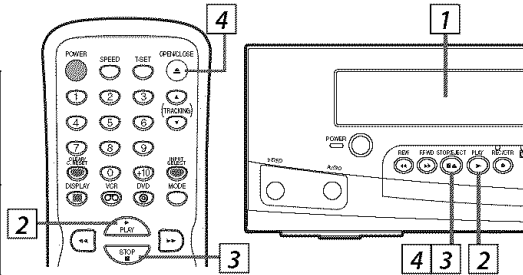

Note:

- When a cassette tape without a record tab is inserted, the unit will start playback automatically.
- Tracking will be automatically adjusted upon playback. To adjust the tracking manually, press [TRACKING ▲ / ▼] during playback.

Other Operations

To cue or review picture during playback (picture search)

Use [▶▶] or [◀◀] ([F.FWD ▶▶] or [REW ◀◀] on this unit).

- Press it again and the unit will search in super high speed. (in the SLP mode only)

To freeze the picture on TV screen during playback (still mode)

Press [PAUSE ||]. Each time you press the button, the picture will be forwarded by one frame.

- If the picture begins to vibrate vertically in the still mode, stabilize the picture by using [TRACKING ▲ / ▼].
- If the picture is distorted or rolling vertically, adjust the vertical hold control on your TV if equipped.

To Reset the Cassette Tape Counter (counter reset)

Press [DISPLAY] to display the cassette tape counter on the TV. Press [CLEAR/C.RESET] to reset the counter to "0:00:00".

To play back in slow motion (slow mode)

Press [PAUSE ||] during playback, then press [▶▶] ([F.FWD ▶▶] on this unit).

- If you want to change speed in slow mode, press [▶▶] or [◀◀] ([F.FWD ▶▶] or [REW ◀◀] on this unit), slow speed will be more fast and slow mode.
- If the noise bars appear on the TV screen, you can reduce it by using [TRACKING ▲ / ▼].

To rewind the cassette tape automatically (auto rewind)

When a cassette tape reaches its end during playback, fast-forward or recording (except timer recording and one-touch timer recording), the cassette tape will automatically rewind to the beginning. After rewinding finishes, the unit will eject the cassette tape.

Note:

- To prevent damage to the cassette tape, still or slow mode will automatically stop after 5 minutes.
- To return to playback from the picture search, still or slow mode, press [PLAY ▶].

Index Search

To search by index mark. The index mark will be made automatically at the beginning of each recording.



• Insert a cassette tape into this unit.

- Press [SEARCH MODE] once.
- To select index mark

beginning of the contents current program end of the contents
- To rewind

To fast forward
- When index mark is reached, playback automatically begins.

Note:

- The time gap between index marks should be more than 1 minute for SP mode, 2 minutes for LP mode and 3 minutes for SLP mode.

Time Search

To search by length of time.



• Insert a cassette tape into this unit.

- Press [SEARCH MODE] twice.
- Select the desired length of time for fast forwarding or rewinding.

(1 minute~9 hours and 59 minutes)
- To rewind

To fast forward
- When selected length of time is reached, playback will start automatically.

Note for Index Search & Time Search:

- These functions are not available during recording.
- Press [STOP ■] to stop the search.
- If a cassette tape ends during a search, your search will be canceled and the cassette tape will rewind to the beginning.

Auto Repeat

When "AUTO REPEAT" is set to "ON", the cassette tape will automatically rewind and start over when it reaches the end. This will continue until auto repeat function is turned off.



1 Press [SETUP], and choose "AUTO REPEAT".

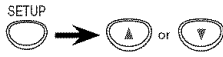

-MENU-
TIMER PROGRAMMING
SATELLITE LINK
▶ AUTO REPEAT [OFF]
CLOCK SET
LANGUAGE SELECT

2 Press [▶] to "AUTO REPEAT" to set "ON" or "OFF".



Press [SETUP] to exit.

-MENU-
TIMER PROGRAMMING
SATELLITE LINK
▶ AUTO REPEAT [ON]
CLOCK SET
LANGUAGE SELECT

Note:

- The auto repeat function can also be set "ON" or "OFF" by pressing [REPEAT] on the remote control.
- To cancel auto repeat function, follow step 1 above. Then, press [▶] so that "OFF" appears beside "AUTO REPEAT". Press [SETUP] to exit.
- The auto repeat playback will start automatically if you select "AUTO REPEAT" to "ON" in the stop mode.

Recording

This unit has no tuner system so it cannot receive TV broadcasts without external tuner or such devices.

Note:

- You can also set to external tuner. Refer to "Satellite Link" on page 14.

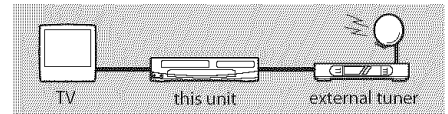

Recording & One-touch Timer Recording (OTR)



1 Insert a recordable cassette tape.

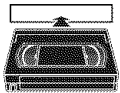

2 Press [INPUT SELECT] until "L1" or "L2" is displayed on the TV screen. Select "L1" to activate rear input jacks. Select "L2" to activate front input jacks.



See note on the right.

3 Press [SPEED] to select the desired tape speed.



Type of tape	Recording / playback time		
	T60	T120	T160
SP mode	1hour	2hours	2-2/3hours
SLP mode	3hours	6hours	8hours

4 Press [REC/OTR] until desired recording time is selected.

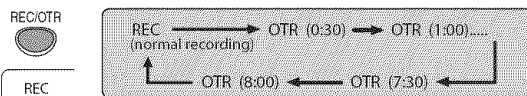

5 Press [STOP ■] to stop recording.



6 Press [OPEN/CLOSE ▲] to eject the recorded cassette tape.

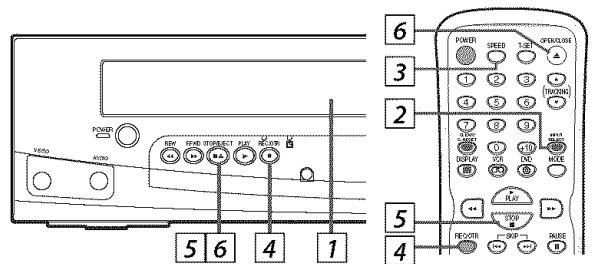

To stop recording temporarily (Pause mode)

Press [PAUSE ■].

- During the recording in pause mode, 5 ■ marks appear on the TV screen. Each ■ mark represents 1 minute.
- Press it again to resume recording.
- Pause mode will be automatically canceled after 5 minutes to prevent damage to the cassette tape and the video head.

Note:

- Do not change the external tuner's channel while you are recording. You CANNOT watch one channel and record another at the same time.
- Connect your external tuner to the L1 (rear panel) jacks of the unit. Connect camcorders and other such devices to the L2 (front panel) jacks. Refer to page 7, 9.

Accidental Erasure Prevention

To prevent accidental recording, remove erase-protection tab of the cassette tape. To record on it later, cover the hole with adhesive tape.



Timer Recording



- Insert a recordable cassette tape.
- Make sure to turn on the external tuner.

1 Press [SETUP]. Select "TIMER PROGRAMMING".

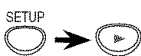

-MENU-
▶ TIMER PROGRAMMING
SATELLITE LINK
AUTO REPEAT [OFF]
CLOCK SET
LANGUAGE SELECT

TIMER PROGRAMMING
PROG 2345678
DATE
START TIME
END TIME
L1/L2
REC SPEED

Available program number flashes.

2 Select an empty program number. Then press [▶] to go to next step.



PROGRAM NUMBER
DATE --:--:--
START TIME --:--:--
END TIME --:--:--
L1/L2
REC SPEED --

- 3 Select "ONCE", "DAILY" (Mon-Fri), or "WEEKLY". Then press [▶] to go to next step.



PROGRAM NUMBER 1
▶ ONCE
DAILY
WEEKLY

- 4 Select the desired date. Then press [▶] to go to next step.

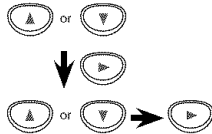

ONE TIME PROGRAM
PROGRAM NUMBER 1
DATE 10/23 TUE
START TIME ---:--:--
END TIME ---:--:--
L1/L2 ---
REC SPEED --

• You can program the unit to record up to 8 programs, for up to a year in advance.

- 5 Select the desired starting time (hour). Then press [▶] to go to next step.

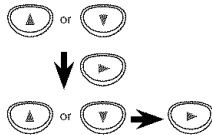

ONE TIME PROGRAM
PROGRAM NUMBER 1
DATE 10/23 TUE
START TIME 07:30
END TIME ---:--:--
L1/L2 ---
REC SPEED --

- 6 Select "AM" or "PM". Then press [▶] to go to next step.



ONE TIME PROGRAM
PROGRAM NUMBER 1
DATE 10/23 TUE
START TIME 07:30 PM
END TIME ---:--:--
L1/L2 ---
REC SPEED --
AM PM

- 7 Repeat the procedure in steps 5 and 6 to set the ending time.



- 8 Select "L1" or "L2". Then press [▶] to go to next step.



ONE TIME PROGRAM
PROGRAM NUMBER 1
DATE 10/23 TUE
START TIME 07:30 PM
END TIME 08:30 PM
L1/L2 >=1
REC SPEED >=1

- 9 Select recording speed. Then press [CLEAR/C.RESET].



ONE TIME PROGRAM
PROGRAM NUMBER 1
DATE 10/23 TUE
START TIME 07:30 PM
END TIME 08:30 PM
L1
L2
REC SPEED SP
▶ SP
SEP

• To set another program after step 9, press [▶]. Then continue with step 2.

- 10 Press [T-SET] to set the timer standby mode.



• [] indicator on this unit lights up and the unit goes to the DVD mode.

Note:

- To go back one step, press [◀] during steps 3 to 9.
- Select "L1" to activate rear input jacks. Select "L2" to activate front input jacks.

To check, correct or cancel a timer program

- 1) Press [T-SET] then, [VCR ∞] on the remote control.
- 2) Press [SETUP] to call up the main menu.
- 3) Select "TIMER PROGRAMMING" by using [▲ / ▼], then press [▶].
- 4) Select the program number which you want to check by using [▲ / ▼]. The details of the program you selected will appear on the TV screen.
 - Go to the digit you want to change by using [◀ / ▶]. Then, enter correct numbers by using [▲ / ▼].
 - You may cancel the entire program by pressing [◀] while the program number blinks.
- 5) Press [CLEAR/C.RESET] to exit.
- 6) Press [T-SET] to return to the timer standby mode.

To cancel a timer recording in progress

Press [STOP/EJECT ■ ▲] on the unit.

Notes for Timer Recording & One-touch Timer Recording (OTR)

- If a cassette tape is not in the unit or does not have the erase-protection tab, [] indicator on this unit blinks and timer recording cannot be performed. Please insert a recordable cassette tape.
- When timer recordings are set, [] indicator on this unit lights up. To use the VCR as usual until the time for the recording, press [T-SET] so that [] indicator lights off.

After an one-touch timer recording or a timer recording has been set, this unit operates as follows:

- If a cassette tape runs out before an one-touch timer recording or a timer recording is finished, the unit ejects the cassette tape. Press [T-SET] on the remote control or [STOP/EJECT ■ ▲] on the unit, then press [VCR ∞] to activate the VCR function again.
- Once the unit turns to the timer standby mode, no VCR functions are available until [T-SET] is pressed.
- To cancel the timer standby mode, press [T-SET] on the remote control or [STOP/EJECT ■ ▲] on the unit, then press [VCR ∞] to activate the VCR function again.

When an one-touch timer recording or a timer recording is completed...

- If auto power off for DVD has been activated and there are timer recordings on standby, the unit turns off automatically, and [] indicator on this unit lights to indicate the unit is in the timer standby mode.
- [] indicator on this unit flashes if there are no more timer recordings on standby.
- If auto power off for DVD has NOT been activated, the unit goes to the DVD mode and all the VCR functions will be unavailable. All the DVD functions are available during one-touch timer recording, timer standby mode and timer recording.
- Press [STOP/EJECT ■ ▲] on this unit or [T-SET] on the remote control to use the VCR when the unit is turned off.
- Press [OUTPUT] on this unit or [VCR ∞] on the remote control to use the VCR when the unit is turned on. In case timer recording is in standby mode, press [STOP/EJECT ■ ▲] on this unit or [T-SET] on the remote control, and then press [OUTPUT] on this unit or [VCR ∞] on the remote control.

If you want to use the DVD player during a timer recording or while [] indicator on this unit is on or blinking.

- Press [POWER] to turn on the unit. Press [DVD ⊙] on the remote control to choose DVD mode, then continue with the other DVD features as described in this manual.

Note for timer recording:

- If there is a power failure or the unit is unplugged for more than 30 seconds, clock setting and all timer programs will be lost.

Satellite Link

You can set the unit to start recording whenever it detects a video signal from the external tuner.

Preparing for the Satellite Link Timer Recording:

Preparation on the tuner

- Satellite link accepts only the connection from L1 (rear) with the external tuner. (The connection from L2 cannot read any signals from the cable/satellite box.)
- The external tuner should be equipped with some kind of timer function. Using timer function of the tuner, set it to output audio/video signals when it comes to the time you want to start recording, and stop output audio/video signals when it comes to the time you want to finish recording. Refer to the tuner's manual on how to set the timer.
- Make sure to turn off the tuner when you finish setting.

Preparation on this unit

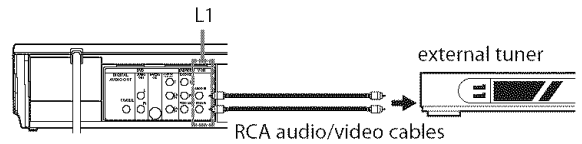

- 1 Press **[SPEED]** to select the desired tape speed.

SPEED	Tape speed		Recording / playback time		
SP	Type of tape	T60	T120	T160	
	SP mode	1hour	2hours	2-2/3hours	
	SLP mode	3hours	6hours	8hours	

- 2 In stop mode, press **[SETUP]**.



- 3 Select "SATELLITE LINK". Then press **[▶]** to go to next step.

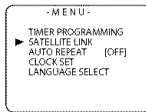

- 4 Set the desired start hour. Then press **[▶]** to go to next step.

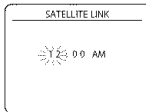

- The hour can be selected from 1-12 with AM or PM.
- When the external tuner signal is stopped, recording will be stopped.

- 5 Set the desired start minutes. If you wish to go back to the left, press **[◀]**.

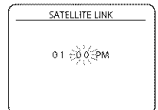
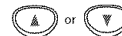

- 6 Press **[▶]** to set satellite link standby mode.

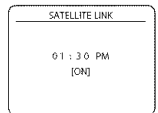

- indicator on this unit lights up and the unit goes to the DVD mode. If you do not use DVD function, turn off the unit.
- Satellite unit must be turned on for VCR satellite link to start. If cable/satellite box is not set to output signals, satellite link will remain in standby mode.

To cancel the satellite link function in standby mode:

Press **[T-SET]** on the remote control or **[STOP/EJECT ■ ▲]** on this unit.

To cancel the satellite link function while the satellite link recording is in progress:

Press **[STOP/EJECT ■ ▲]** on this unit.

Note:

- If you have not set the clock, "CLOCK SET" menu will appear at step 2. Refer to "Clock Setting" on page 8.
- You cannot set the ending time for the satellite link timer recording on this unit.
- Recording picture will be distorted if the copy protection signal is being detected during satellite link timer recording.
- When a regular timer recording and the satellite link timer recording are overlapped, those recordings are recorded as illustrated below.

e.g.) In case of the satellite link timer recording is overlapped on the existing timer recording.

timer recording	
satellite link	
recording result	

e.g.) In case of the timer recording is programmed in the middle of the satellite link timer recording.

timer recording	
satellite link	
recording result	

e.g.) In case of the timer recording is overlapped on the existing satellite link timer recording.

timer recording	
satellite link	
recording result	

Copying a Cassette Tape

Warning: Unauthorized recordings of copyrighted cassette tapes may be an infringement of copyright laws.

- 1 Insert a pre-recorded cassette tape into another external device for playback.
- 2 Insert a recordable cassette tape into this unit for recording.
- 3 Press **[SPEED]** on the remote control to select recording speed (SP or SLP).
- 4 Press **[INPUT SELECT]** on the remote control to select L1 or L2. Choose L1 if device is connected to rear input jacks, or L2 if connected to the front. Refer to "Front & Rear Terminals" on page 9 for more details.
- 5 Press **[REC/OTR]** on the unit.
- 6 Press "PLAY" button on the external device.
- 7 To stop recording, press **[STOP/EJECT ■ ▲]** on this unit, then stop playback of the external device.

output jacks of external device

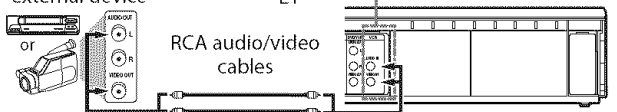

You can use a video disc player, cable/satellite box or other audio/video component with audio/video output jacks.

Note:

- For best results during dubbing, use buttons on this unit whenever possible. The remote control might affect another device's operation.
- Always use video-quality shielded cables with RCA-type connectors. Standard audio cables are not recommended.
- L2 input jacks are on the front of this unit.

DVD FUNCTIONS

Playback

Before:

Turn on the TV, amplifier and any other components which are connected to this unit. Make sure the TV and audio receiver are set to the correct channel.



<p>1</p> <p>POWER → OPEN/CLOSE</p>	<p>2 Insert a disc with label facing up.</p>
<p>3 To start playback</p>	<p>4 To stop playback</p>

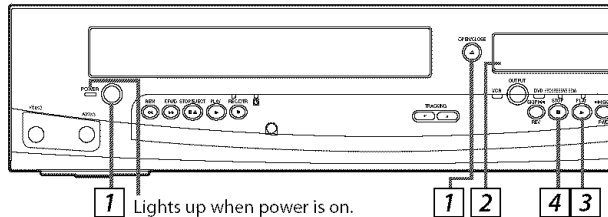
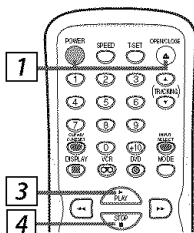

Note:

- When you play a CD-RW/-R with MP3 files, details on page 16.
- "⊘" may appear at the top-right on the TV screen when the operation is prohibited by the disc or this unit.
- Some DVD may be played from title 2 or 3 due to specific programs.
- During the playback of a 2-layered disc, pictures may stop for a moment. This happens while the 1st layer is being switched to the 2nd layer. This is not a malfunction.
- You can change the on-screen language for DVD function in "PLAYER MENU" menu. Refer to page 20.

Disc Menu



Some discs contain menus which allow you to customize DVD playback. Use [▲] / [▼] / [◀] / [▶] to select an item, then press [ENTER] (or [PLAY ▶]).

Calling Up a Menu Screen during Playback



- Press [MENU] to call up the disc menu.
- Press [TOP MENU] to call up the title menu.

Note:

- Menu operations may vary depending on the disc. Refer to the manual accompanying the disc for details.

Resume Playback



Press [STOP ■] during playback. Resume message will appear on the TV screen.

Press [PLAY ▶], playback will resume from the point at which playback was stopped.

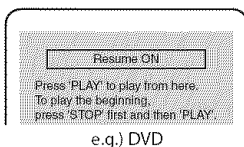

Note:

- To cancel resume, press [STOP ■] one more time in the stop mode.
- For MP3, playback will resume from the beginning of the track at which playback was stopped.
- The resume playback information stays on even when the power is turned off, as long as the disc stays in the unit.

Paused and Step-by-Step Playback



Press [PAUSE ||] during playback. To continue playback, press [PLAY ▶].



The disc goes forward by one frame each time [PAUSE ||] is pressed in the pause mode.

To continue playback, press [PLAY ▶].

Note:

- For DVD, set "STILL MODE" to "FIELD" in "DISPLAY" menu if pictures in the pause mode are blurred. Refer to pages 20-21.

To use [SKIP ◀◀ / REV], [▶▶ SKIP / FWD] on this unit



Press once to skip chapters, tracks or titles to a desired point.

Fast Forward / Reverse Search



Press [▶▶] or [◀◀] repeatedly during playback to select the required forward or reverse speed.

To use [SKIP ◀◀ / REV], [▶▶ SKIP / FWD] on this unit

Pressing and holding [SKIP ◀◀ / REV] or [▶▶ SKIP / FWD] on this unit will also change forward or reverse playback speed.

To continue playback, press [PLAY ▶].

Note:

- For DVD, fast forward or reverse search speed is different depending on the disc. Approximate speed is 1(2x), 2(8x), 3(20x), 4(50x), 5(100x).
- For audio CD and MP3, approximate speed is 1(2x), 2(8x), 3(30x).

Slow Forward / Reverse Search



Press [▶▶] or [◀◀] repeatedly in the pause mode to select the required forward or reverse speed.

To use [SKIP ◀◀ / REV], [▶▶ SKIP / FWD] on this unit

Pressing and holding [SKIP ◀◀ / REV] or [▶▶ SKIP / FWD] on this unit in the pause mode will also change forward or reverse playback speed.

To continue playback, press [PLAY ▶].

Note:

- Slow forward or reverse speed is different depending on the disc. Approximate speed is 1(1/16x), 2(1/8x), 3(1/2x).
- Set "STILL MODE" to "FIELD" in "DISPLAY" menu if pictures in the slow playback mode are blurred. Refer to pages 20-21.

Zoom



- 1) Press [ZOOM] during playback.
- 2) Press [ZOOM] repeatedly to select the required zoom factor: 2x, 4x or off.



- 3) Press [▲] / [▼] / [◀] / [▶] to slide the zoomed picture across the TV screen.

- 4) To exit zoom mode, press [ZOOM] to select OFF.

Note:

- Zoom function does not work while the disc menu is displayed.
- 4x zoom is not available on some discs.
- The picture may be distorted when you press [PAUSE ||] or [◀◀] repeatedly in the zoom mode.
- In the zoom mode, it automatically changes [2x] (4x) to the zoomed position guide.

MP3 Playback

MP3 is a method of compressing files. You can copy MP3 files on CD-RW/-R from the computer and play back the files on this unit.



Insert a CD-RW/-R with MP3 files, the file list will automatically appear on the TV screen. Press **[MENU]** when you want to call up the file list again while CD-RW/-R with MP3 files is already inserted.

1 When selecting the folder:

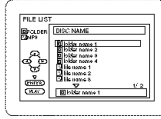

- Press **[▶]** when you want to go to the next hierarchy.
- Press **[◀]** when you want to go back to the previous hierarchy (except for the top hierarchy).

2 Press **[STOP ■]** once to stop MP3 playback temporarily.



Refer to "Resume Playback" on page 15.

Note:

- Depending on some sections, it may take a while to be recognized.
- Press **[TOP MENU]** to return to the first item.
- Folders and MP3 files are displayed respectively as **[■]** and **[■]**.
- A maximum of 255 folders or 999 files may be recognized on one disc.
- Up to 8 hierarchies can be recognized in one folder. File in the 9th or deeper hierarchies cannot be played back.

This unit recommends files recorded under the following circumstances:

- Sampling frequency: 44.1kHz or 48kHz
- Constant bit rate: 32kbps ~ 320kbps
- For MP3 file recorded in VBR (variable bit rate), the unit may not display the actual elapsed time.

On-Screen Display

You can check the information about the current disc by pressing **[DISPLAY]** on the remote control.

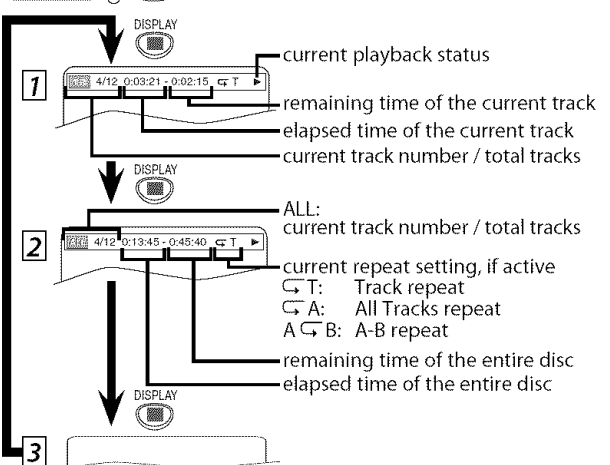
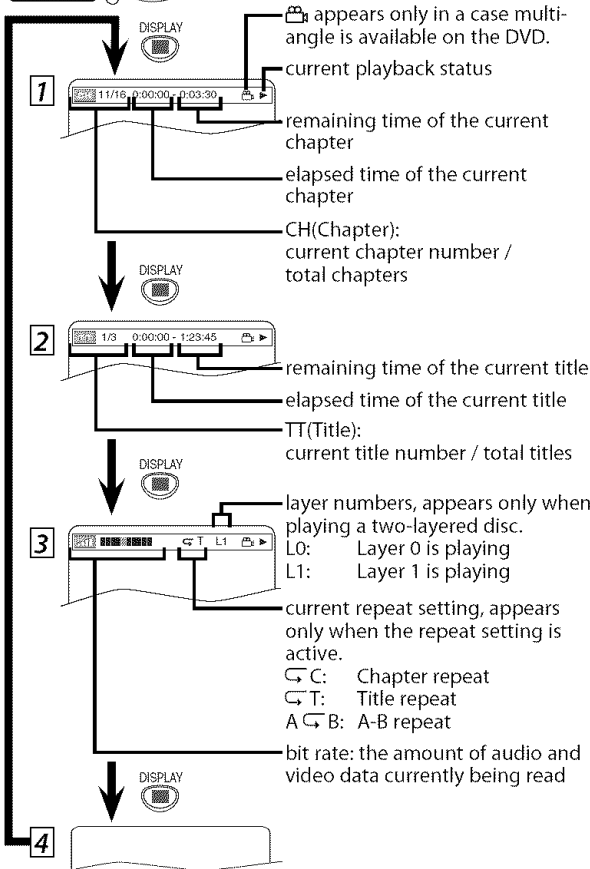

Note:

- When you are playing a disc in program or random mode, **[PROGRAM]** (or **[RANDOM]**) will be displayed instead of 2.

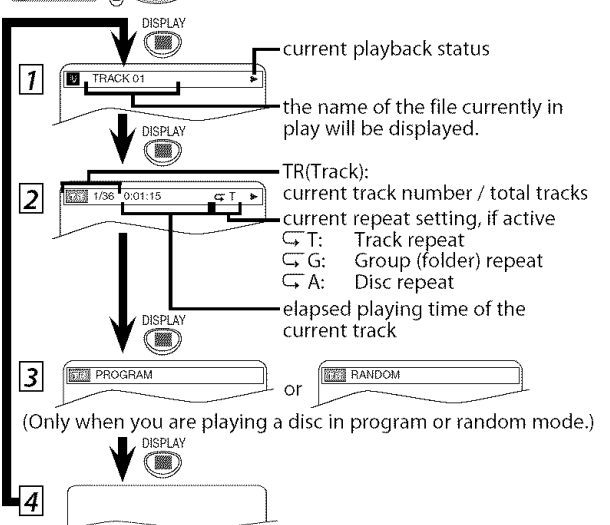

Search Functions

Search function does not work during programmed or random playback.

Using Track Search



1 Press [SEARCH MODE].

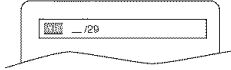

2 Select track number by using [the Number buttons] within 30 seconds.

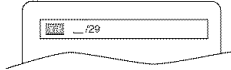

- For the disc with less than 10 tracks, press the track number directly.
- For discs with more than 10 but less than 99 tracks, to play back single-digit track, press [0] first, then the track number (e.g., for track 3, press [0], [3]). To play back a double-digit track, press the track number.
- For discs with more than 100 tracks, to play back a single or a double-digit track, press [0] first, then the track number (e.g., for track 3, press [0], [0], [3], and for track 26, press [0], [2], [6]). To play back a triple-digit track, press the track number.

Using [SKIP] [LEFT], [RIGHT]]

1 Press [SKIP] [LEFT], [RIGHT]] during playback.

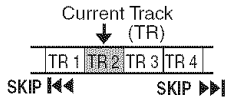
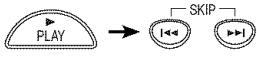

Note:

- [+10] can also bring the track search display, except for the disc with less than 10 tracks. For such a disc, track search can be performed by just pressing the track number.
- For audio CD and MP3, track search is not available for programmed and random playback.

Using Title / Chapter Search



1 Press [SEARCH MODE] once for the chapter search. Press [SEARCH MODE] twice for the title search.

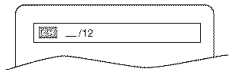
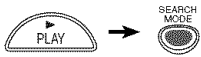

2 Select title/chapter number by using [the Number buttons] within 30 seconds.

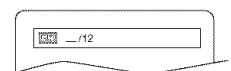

Using [SKIP] [LEFT], [RIGHT]]

1 Press [SKIP] [LEFT], [RIGHT]] during playback.

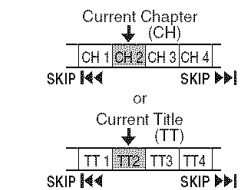
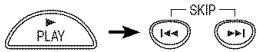

Note:

- Depending on the disc being played back, this function can also be performed by directly entering the desired chapter number with [the Number buttons]. Refer to the manual accompanying the disc.

Using Time Search



1 Press [SEARCH MODE] repeatedly until the time search display appears.

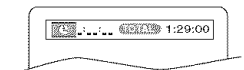
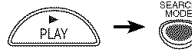

2 Select a desired disc time by using [the Number buttons] within 30 seconds.

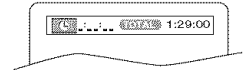

Note:

- When there is no need to enter a number, "0" appears automatically. For example, "0:0:_" appears in the time search display if the total time of the title or track is less than 10 minutes.
- Press [CLEAR/C.RESET] to erase the incorrect input at step 2.
- For audio CD, time search is not available for programmed and random playback.

Marker Setting



This function allows you to assign a specific point on a disc to be called back later.

To set a marker

1 Press [SEARCH MODE] repeatedly until the marker display appears.

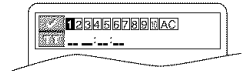
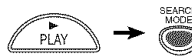

2 Select a marker.

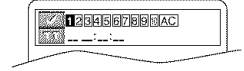
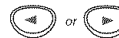

3 Press [ENTER].

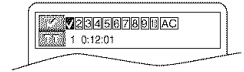

To return to the marker later

1 Press [SEARCH MODE] repeatedly until the marker display appears.

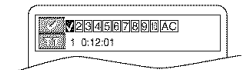

2 Select the marker.

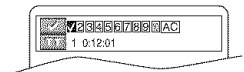
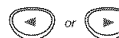

3 Press [ENTER] at the desired marker.

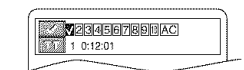

To exit the marker screen

1 Press [RETURN].



Note:

- The marker display will disappear in about 30 seconds when there is no output.
- To clear a marker, select the marker to be cleared at step 2 in the section "To set a marker" or "To return to the marker later" and then press [CLEAR/C.RESET].
- Opening the disc tray or turning off the power will erase all markers.
- Selecting "AC" at step 2 in the section "To set a marker" or "To return to the marker later" will also erase all markers.

Repeat / Random / Programmed Playback

Repeat Playback



Repeat function is available only during playback.

1 Press **[REPEAT]** during playback.



Each time you press **[REPEAT]**, repeat function changes as example below.

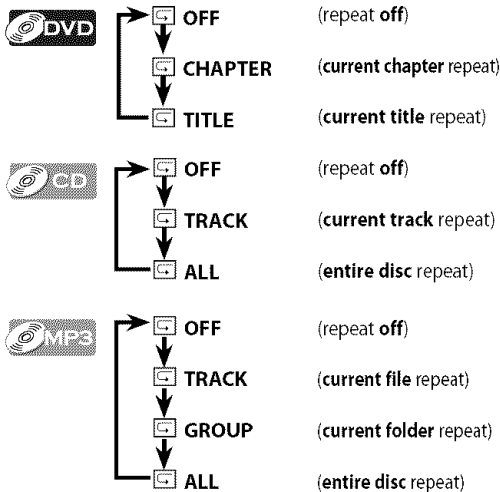

Note:

- Repeat setting (except "ALL") will be cleared when moving to another title, chapter, track/file or folder.
- This function is not available with some discs or during repeat A-B playback.

Repeat A-B Playback



Repeat function is available only during playback.

1 Press **[A-B]** at your desired starting point (A).

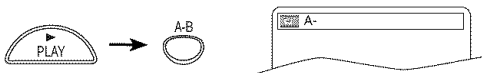

2 Press **[A-B]** at your desired ending point (B).

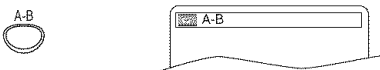

- Point B should be in the same title or track as point A.

Note:

- To exit the sequence, press **[A-B]** so that "OFF" appears.
- To cancel point A, press **[CLEAR/C.RESET]** at step 1.
- This function is not available in the other repeat modes.

Random Playback



This function shuffles the playing order of tracks instead of playback in sequence.

1 Press **[MODE]** twice.

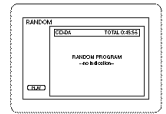
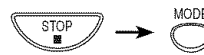

e.g.) CD

2 Press **[PLAY ▶]** to start random playback.

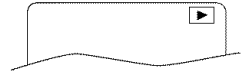

Note:

- To repeat the current track in the random mode, press **[REPEAT]** repeatedly until "TRACK" appears during playback.
- To repeat the entire random selections, press **[REPEAT]** repeatedly until "ALL" appears during playback.
- During random playback, you cannot go back to the previous track.

Programmed Playback



You may determine the order in which tracks will play back.

1 Press **[MODE]** once.

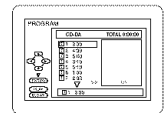
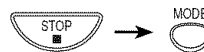

e.g.) CD

2 Using **[▲ / ▼]** to select desired track. Press **[ENTER]**.

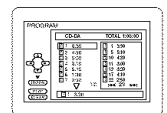

- Up to 99 tracks can be programmed.
- If eight or more tracks were in a program, use **[SKIP ◀▶]** to see all the tracks.
- While an MP3 folder is open:
 - Press **[▶]** when you want to go to the next hierarchy.
 - Press **[◀]** when you want to go back to the previous hierarchy (except for the top hierarchy).

3 Press **[PLAY ▶]** to start programmed playback.

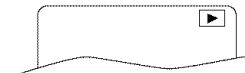

Note:

- Press **[CLEAR/C.RESET]** at step 2 to erase the most recently entered track.
- To erase all programmed tracks at once, select "ALL CLEAR" and press **[ENTER]** at step 2.
- While a program is being played back, **[STOP ■]** works as follows:
 - Press **[STOP ■]** and **[PLAY ▶]** next, so that the programmed playback restarts. (CD playback restarts from the current point. MP3 playback restarts from the beginning of the current file.)
 - Press **[STOP ■]** twice and **[PLAY ▶]** next, so that playback restarts from the first track in the original order. However, your programmed playback can be restarted when you follow the above steps. (Your programs are still stored until either the disc tray is open or power is turned off.)
- To repeat the current track in the program, press **[REPEAT]** repeatedly until "TRACK" appears during playback.
- To repeat the entire program, press **[REPEAT]** repeatedly until "ALL" appears during playback.

Special Settings

Subtitle Language



This unit allows you to select a subtitle language (if available) during DVD playback.

- 1 Press [SUBTITLE] during playback.



Each time you press [SUBTITLE], subtitle language changes as example below.

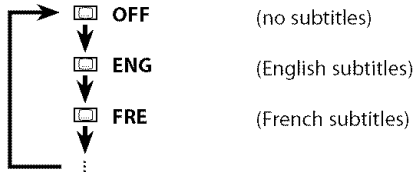

To cancel subtitle

- 1 Press [SUBTITLE] during playback.



- 2 Press [◀/▶] to set subtitle to "OFF".

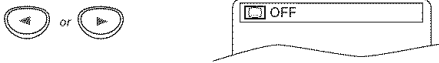

Note:

- If your language is not shown after pressing [SUBTITLE] several times, the disc may not have that language. However, some discs have the subtitle language setting on the disc menu. (Operation varies depending on the discs, so refer to the manual along with the disc.)
- When "NOT AVAILABLE" appears on the TV screen, it means no subtitle is recorded on the scene.
- If you choose a language that has a 3-letter language code, the code will be displayed every time you change the subtitle language setting. If you choose any other languages, "--" will be displayed instead. Refer to page 24.
- Some discs will only allow you to change the subtitle from the disc menu. Refer to the manual accompanying the discs for details.

Audio Language



This unit allows you to select an audio language (if multiple languages are available) during DVD playback.

- 1 Press [AUDIO] to change audio language.



Each time you press [AUDIO], the audio language changes as example below.





Note:

- If your language is not shown after pressing [AUDIO] several times, the disc may not have that language. However, some discs allow audio language setting on the disc menu. (Operation varies depending on the disc, so refer to the manual along with the disc.)
- When "OFF" appears on the TV screen, it means audio language is not available.
- Some discs will only allow you to change the audio setting from the disc menu. Refer to the manual accompanying the discs for details.

Camera Angles



Some DVD may contain scenes which have been shot simultaneously from various angles. You can change the camera angle if  appears on the TV screen. If the "ANGLE ICON" is set to "OFF" in "OTHERS" menu,  will not appear. Refer to pages 20-22.

- 1 Press [ANGLE] during playback.



Each time you press [ANGLE] or [◀/▶], camera angle changes.

Black Level Setting



Adjust the black level to make the dark areas of the TV picture brighter.

- 1 Press [MODE] during playback.



- 2 Press [ENTER] to adjust the black level.



ON: makes the dark areas brighter.
OFF: shows the original picture as recorded.

- 3 Press [RETURN] to exit.



Stereo Sound Mode



This unit allows you to select a sound mode during CD playback.

- 1 Press [AUDIO] during CD playback.



Each time you press [AUDIO], sound mode changes as example below.

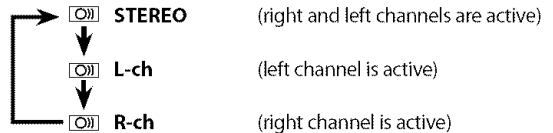

Virtual Surround



You can enjoy stereophonic virtual world on your existing 2 channel stereo system.

- 1 Press [MODE] twice (once for CD and MP3) during playback.



- 2 Press [ENTER] for the desired effect.

1: natural effect
2: emphasized effect
OFF: no effects (original sound)

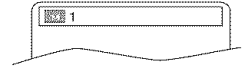

- 3 Press [RETURN] to exit.



Note:

- For audio CD, virtual surround will not be effective if the sound mode is set to something other than "STEREO". Refer to "Stereo Sound Mode".
- For DVD when playing back 96kHz with virtual surround function, the sound will be down sampled to 48kHz.

QUICK Menu

You can select the "PLAYER MENU", "TV ASPECT", "PROGRESSIVE" or "DOLBY DIGITAL" from "QUICK" menu quickly.

1 Press [SETUP] in the stop mode.

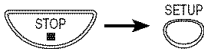

SETUP menu
Confirm that "QUICK" is selected.

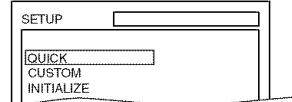

2 Select the desired item.

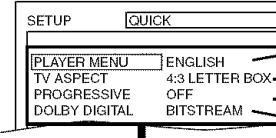
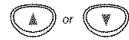

P20 **A** Step 5
P21 **B** Step 5
P21 **C** Step 5

• Refer to the sections "PLAYER MENU", "TV ASPECT", "PROGRESSIVE" or "DOLBY DIGITAL" section on page 20 or 21.

CUSTOM Menu

You can change the settings of the unit.

• **QUICK** on pages 20-21 indicates DVD setting menus also accessible from "QUICK" menu.

1 Press [SETUP] in the stop mode.

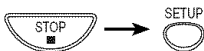

SETUP menu



2 Select "CUSTOM".

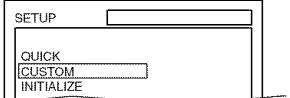
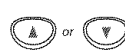

3 Select the desired item.

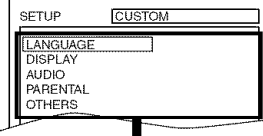
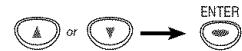

LANGUAGE menu

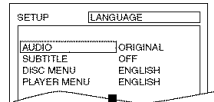

page 20 **A**

DISPLAY menu

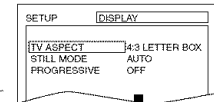

page 21 **B**

AUDIO menu

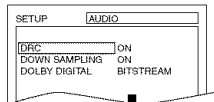

page 21 **C**

PARENTAL menu

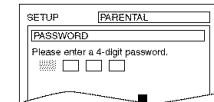

page 22 **D**

OTHERS menu

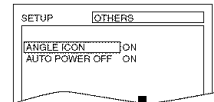

page 22 **E**

A LANGUAGE Setting

Follow steps 1 to 3 in the "CUSTOM Menu" section above.

4 Select the desired item.

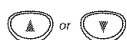

LANGUAGE menu

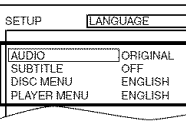

Note:

• In "QUICK" menu, "PLAYER MENU", "TV ASPECT", "PROGRESSIVE" or "DOLBY DIGITAL" are available. "QUICK" menu consists of the setting menu frequently used, and they are accompanied with **QUICK**. You can make all settings in "CUSTOM" menu.

5 Select the desired language.

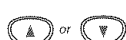

AUDIO: *1 *2 (Default: ORIGINAL)
Sets the audio language.

SUBTITLE: *1 *2 (Default: OFF)
Sets the subtitle language.

DISC MENU: *1 (Default: ENGLISH)
Sets the language for DVD menu.

PLAYER MENU: QUICK (Default: ENGLISH)
Sets the language for the on-screen display.

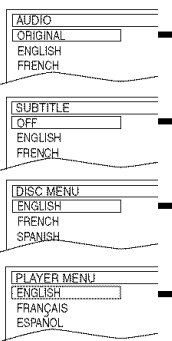

6 To exit the menu



Note:

***1**

- Language options are not available with some discs.
- If "OTHER" is selected on "AUDIO", "SUBTITLE" or "DISC MENU" screen, press 4-digit number to enter the code for the desired language. Refer to the "Language Code List" on page 24.
- Only the languages supported by the disc can be selected.

***2**

- "LANGUAGE" setting for "AUDIO" and "SUBTITLE" are not available with some discs. Then use [AUDIO] and [SUBTITLE]. Refer to page 19.

B DISPLAY Setting

You can change the display functions. Follow steps 1 to 3 in the "CUSTOM Menu" section on page 20.

4 Select the desired item.

DISPLAY menu

Note:
PROGRESSIVE:
 • You can set "PROGRESSIVE" to "OFF" in "DISPLAY" menu or press and hold [PLAY] on this unit for more than 5 seconds during playback until the PROGRESSIVE SCAN indicator on this unit turns off.
 • When "PROGRESSIVE" is "ON", video signals from the unit's VIDEO OUT and S-VIDEO OUT jacks will be distorted or not be output at all.

Note:
 • In "QUICK" menu, "PLAYER MENU", "TV ASPECT", "PROGRESSIVE" or "DOLBY DIGITAL" are available. "QUICK" menu consists of the setting menu frequently used, and they are accompanied with **QUICK**. You can make all settings in "CUSTOM" menu.

5

TV ASPECT: QUICK (Default: 4:3 LETTER BOX)
 See note on the right.

STILL MODE: (Default: AUTO)
 See note on the right.

PROGRESSIVE: QUICK (Default: OFF)
 See note on the left.

If there is no picture or you do not press any buttons for 15 seconds, "PROGRESSIVE" will switch to "OFF" and it will exit the "SETUP" menu.

6 To exit "TV ASPECT" or "STILL MODE" menu

To complete "PROGRESSIVE" setting

Note:
TV ASPECT:
 • Select "4:3 LETTER BOX", so that black bars may appear on the top and bottom of the TV screen.
 • Select "4:3 PAN & SCAN" for a full height picture with both sides adjusted.
 • Select "16:9 WIDE" if a wide-screen TV is connected to this unit.
STILL MODE:
 • Select "AUTO" usually.
 • If you select "AUTO", it automatically selects the best resolution setting ("FRAME" or "FIELD") based on the data characteristics of the pictures. (default)
 • If you select "FIELD", the picture in the still mode will be stabilized.
 • If you select "FRAME", the picture in the still mode will be highly defined.
 • An individual picture on the TV screen is called a "frame", which consists of two separate images called as "field".
 • Some pictures may be blurred if you select "AUTO" in the still mode due to their data characteristics.

C AUDIO Setting

Choose the appropriate audio setting for your device. It only affects during the playback of DVD discs. Follow steps 1 to 3 in the "CUSTOM Menu" section on page 20.

4 Select the desired item.

AUDIO menu

Note:
 • In "QUICK" menu, "PLAYER MENU", "TV ASPECT", "PROGRESSIVE" or "DOLBY DIGITAL" are available. "QUICK" menu consists of the setting menu frequently used, and they are accompanied with **QUICK**. You can make all settings in "CUSTOM" menu.

5

DRC (Dynamic Range Control): (Default: ON)
 Set to "ON" to compress the range between soft and loud sounds.

DOWN SAMPLING: (Default: ON)
 Set to "ON" when outputting in 48kHz.
 Set to "OFF" when outputting the original sound.

DOLBY DIGITAL: QUICK (Default: BITSTREAM)
 Set to "BITSTREAM" when the unit is connected to a Dolby Digital decoder.

- BITSTREAM: outputs Dolby Digital signals.
- PCM: converts the Dolby Digital into PCM (2 channel).

6 To exit the menu

Note:
DRC:
 • This function is available only on the discs which are recorded in the Dolby Digital format.
DOWN SAMPLING:
 • When playing back a 96kHz disc with the copyright protection, or when virtual surround is set to "1" or "2", the sound will be down sampled at 48kHz even if the "DOWN SAMPLING" is set to "OFF".
 • This function is available only on digital outputting of a disc recorded in 96kHz.

DVD FUNCTIONS

D PARENTAL Setting

This function prevents unit from playing material inappropriate for children.

Parental Levels

Parental level allows you to set the rating levels of your DVD software. Playback will stop if the ratings exceed the levels you set. Follow steps 1 to 3 in the "CUSTOM Menu" section on page 20.

4 Enter your desired 4-digit password (expect for 4737).

PARENTAL menu

SETUP PARENTAL
PASSWORD
Please enter a 4-digit password.
[] [] [] []

..... Or

If you have set a password already, enter the current 4-digit password.

SETUP PARENTAL
PASSWORD
Enter current password.
[] [] [] []

5 Select "PARENTAL LEVEL".

CONTROL LEVELS

- ALL: all parental locks are canceled.
- Level 8: DVD software of any grades (adult/general/children) can be played back.
- Levels 7 to 2: only DVD software intended for general use and children can be played back.
- Level 1: only DVD software intended for children can be played back, with those intended for adult and general use prohibited.

TIPS FOR LEVELS

- 8 [ADULT]: DVD software of any grades (adult/general/children) can be played back.
- 7 [NC-17]: no one under 17 admitted
- 6 [R]: restricted; under 17 requires accompanying parent or adult guardian
- 5 [PGR]: parental guidance recommended
- 4 [PG13]: unsuitable for children under 13
- 3 [PG]: parental guidance suggested
- 2 [G]: general audience
- 1 [KID SAFE]: suitable for children

Note:

- Some DVD-video may not respond to "PARENTAL" setting. Make sure this function works with your DVD-video.

6 Select the desired level.

7 To exit the menu

To Change the Password for Parental Controls

You can change your password for parental controls. Follow steps 1 to 3 in the "CUSTOM Menu" section on page 20.

4 Enter current 4-digit password.

PARENTAL menu

SETUP PARENTAL
PASSWORD
Enter current password.
[] [] [] []

5 Select "PASSWORD CHANGE".

6 Enter your new 4-digit password (except for 4737).

7 To exit the menu

Note:

- Record the password in case you forget it.
- If you forget the password, press [4], [7], [3], [7] at step 4, then enter your new password. Password will be cleared and parental levels will be set to "ALL".

E OTHERS Setting

You can change the other functions. Follow steps 1 to 3 in the "CUSTOM Menu" section on page 20.

4 Select the desired item.

OTHERS menu

SETUP OTHERS
ANGLE ICON ON
AUTO POWER OFF ON

5

ANGLE ICON:
(Default: ON)
Set to "ON" to display when multiple camera angles are available during DVD playback.

AUTO POWER OFF:
(Default: ON)
Set to "ON" to turn this unit off automatically after 30 minutes of no use.

6 To exit the menu

Reset to the Default Setting (Except for PARENTAL Setting)

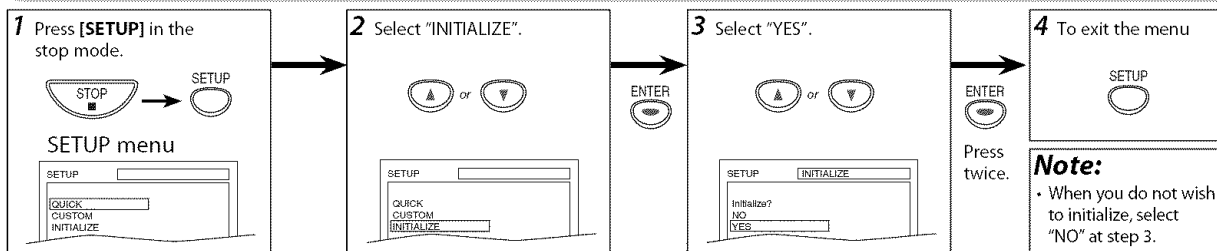

INFORMATION

Troubleshooting Guide

If this unit does not perform properly when operated as instructed in this manual. Refer to the following:

	Problem	Corrective action
DVD / VCR	No power.	<ul style="list-style-type: none"> • Make sure the power plug is connected to an AC outlet. • Make sure the power is turned on.
	This unit does not respond to the remote control.	<ul style="list-style-type: none"> • Check if the power plug is connected to an AC outlet. • Check the batteries in the remote control. • Aim the remote control directly at the infrared sensor window. If necessary, remove all the obstacles between the sensor and the remote control. • You have to be within 23 feet (7m) of this unit. • Check if a cassette tape is in this unit. • Tune your radio to an empty AM station so that you hear a lot of static. Turn up the volume, then if you hear some signal sound from the radio in response to your pressing buttons on the remote control, the remote control is working. • Press and hold any button on remote control toward a digital camera. The remote control is working if you confirm infrared light through the digital camera.
	Poor picture or noise.	<ul style="list-style-type: none"> • Interference signal may be received. Change the position and direction of the unit.
VCR	Cannot record a TV program.	<ul style="list-style-type: none"> • This unit does not have a tuner to receive TV broadcasting. • You must connect this unit to TV with audio/video output jacks or an external tuner to record TV programs. Refer to "Recording & One-touch Timer Recording (OTR)" on page 12 and "Satellite Link" on page 14.
	Timer recording is impossible.	<ul style="list-style-type: none"> • Make sure the timer program is set correctly. • Make sure indicator on this unit lights up. If not, press [T-SET]. • Make sure the VCR clock is set correctly.
	Cannot go into record mode.	<ul style="list-style-type: none"> • Make sure the cassette tape has a record tab. If needed, cover the hole with adhesive tape. • Activate this unit in VCR mode. Press [VCR] on the remote control so that the VCR OUTPUT light will illuminate.
	Playback picture is partially noisy.	<ul style="list-style-type: none"> • Adjust tracking control for a better picture by pressing [TRACKING /] on the unit or [TRACKING /] on the remote control.
	Cannot view a picture but the audio is OK.	<ul style="list-style-type: none"> • Head cleaning may be necessary. Refer to "Auto Head Cleaning". • Make sure the VCR is not in the VCR menu mode.
	No or poor, playback picture.	<ul style="list-style-type: none"> • Fine tune your TV.
	Video or color fades in and out when making a copy of a cassette tape.	<ul style="list-style-type: none"> • You cannot copy a copyrighted cassette tape.
	Cannot remove the cassette tape.	<ul style="list-style-type: none"> • Check if this unit is in the VCR mode. If not, press [VCR] on the remote control to switch the mode.
DVD	No picture.	<ul style="list-style-type: none"> • Connect the video cable firmly. • Insert a correct video disc that can be played back on this unit. • Press [DVD] on the remote control. Check if the DVD OUTPUT light will illuminate. Then try other DVD features. • Set "PROGRESSIVE" correctly in "DISPLAY" menu. Turn it on only if your TV has progressive scan and you are using the component video connections between the unit and the TV. Disable progressive scan for all other connections. Refer to page 6.
	Disc cannot be played back.	<ul style="list-style-type: none"> • Insert the disc. • Clean the disc. • Place the disc correctly with the label side up. • Cancel the parental lock or change the control levels. • Handle a disc with special care so that it does not have fingerprints, scratches, or dusts on its surface.
	No sound.	<ul style="list-style-type: none"> • Connect the audio cables firmly. • Turn on the power of the audio component. • Correct the audio output settings. • Correct the input settings on the audio component.
	No DTS audio is output.	<ul style="list-style-type: none"> • This unit does not support DTS audio. -This is not a malfunction.
	Distorted picture.	<ul style="list-style-type: none"> • Connect this unit directly to the TV. • There are some cases where pictures may be slightly distorted, and those are not a sign of a malfunction. • Although pictures may stop for a moment, this is not a malfunction. Refer to page 15. • Check if the progressive mode is set correctly according to your TV. Refer to pages 20-21.
	Audio or subtitle language does not match the setting.	<ul style="list-style-type: none"> • The selected language is not available for audio or subtitles on the DVD. -This is not a malfunction.
	The camera angle cannot be changed.	<ul style="list-style-type: none"> • The DVD does not contain sequences recorded from different camera angles. -This is not a malfunction.
	Audio or subtitle language cannot be changed.	<ul style="list-style-type: none"> • The DVD does not contain audio source or subtitles in the selected language. -This is not a malfunction.
	"" appears on the TV screen, prohibiting an operation.	<ul style="list-style-type: none"> • That operation is prohibited by this unit or the disc. -This is not a malfunction.

- Some functions are not available in specific modes, but this is not a malfunction. Read the description in this manual for details on correct operations.
- Playback from a desired track and random playback are not available during programmed playback.
- Some functions are prohibited on some discs.

Specifications

Video heads : 4-heads	Operating temperature : 41 °F (5°C) to 104°F (40°C)	<ul style="list-style-type: none"> • Designs and specifications are subject to change without notice. • If there is a discrepancy between languages, the default language will be English.
Output signal format : NTSC color	Dimensions : W : 17 3/16" (435mm) H : 3 3/4" (94mm) D : 9 3/16" (233mm)	
Power source : 120 V AC +/- 10%, 60 Hz +/- 0.5%	Weight : Approx 5.8lbs (2.6kg)	
Power consumption : 21W (standby : 3.8W)		

Language Code List

Language	Code	Language	Code	Language	Code	Language	Code
Abkhazian	A-B	French [FRE]	5264	Macedonian	5957	Siswat	6565
Afar	4748	Frisian	5271	Malagasy	5953	Slovak	6557
Afrikaans	4752	Galician	5358	Malay	5965	Slovenian [SLO]	6558
Albanian	6563	Georgian	5747	Malayalam	5958	Somali	6561
Amharic	4759	German [GER]	5051	Maltese	5966	Spanish [SPA]	5165
Arabic	4764	Greek [GRE]	5158	Maori	5955	Sundanese	6567
Armenian	5471	Greenlandic	5758	Marathi	5964	Swahili	6569
Assamese	4765	Guarani	5360	Moldavian	5961	Swedish [SWE]	6568
Aymara	4771	Gujarati	5367	Mongolian	5960		
Azerbaijani	4772	Hausa	5447	Nauru	6047	T	6658
Bashkir	4847	Hebrew	5569	Nepali	6051	Tagalog	6653
Basque	5167	Hindi	5455	Norwegian [NOR]	6061	Tajik	6647
Bengali; Bangla	4860	Hungarian [HUN]	5467			Tamil	6666
Bhutani	5072			O-R		Tatar	6651
Bihari	4854	Icelandic [ICE]	I-K	Occitan	6149	Telugu	6654
Bislama	4855	Indonesian	5560	Oriya	6164	Thai	6654
Breton	4864	Interlingua	5547	Oromo(Afan)	6159	Tibetan	4861
Bulgarian [BUL]	4853	Interlingue	5551	Panjabi	6247	Tigrinya	6655
Burmese	5971	Inupiak	5557	Pashto; Pushto	6265	Tonga	6661
Byelorussian	4851	Irish [IRI]	5347	Persian	5247	Tsonga	6665
		Italian [ITA]	5566	Polish [POL]	6258	Turkish [TUR]	6664
		Japanese [JPN]	5647	Portuguese [POR]	6266	Turkmen	6657
Cambodian	C-E	Javanese [JPN]	5669	Quechua	6367	Twi	6669
Catalan	4947	Kannada	5760	Rhaeto-Romance	6459		
Chinese [CHI]	7254	Kashmiri	5765	Romanian [RUM]	6461	Ukrainian	6757
Corsican	4961	Kazakh	5757	Russian [RUS]	6467	Urdu	6764
Croatian	5464	Kinyarwanda	6469			Uzbek	6772
Czech [CZE]	4965	Kirghiz	5771	S	6559	Vietnamese	6855
Danish [DAN]	5047	Kirundi	6460	Sango	6553	Volapuk	6861
Dutch [DUT]	6058	Korean [KOR]	5761	Sanskrit	6547	Welsh	4971
English [ENG]	5160	Kurdish	5767	Scots Gaelic	5350	Wolof	6961
Esperanto	5161			Serbian	6564	Xhosa	7054
Estonian	5166			Serbo-Croatian	6554	Yiddish	5655
		Laothian	L-N	Sesotho	6566	Yoruba	7161
Faroese	F-H	Latin	5847	Setswana	6660	Zulu	7267
Fiji	5256	Latvian; Lettish	5868	Shona	6560		
Finnish [FIN]	5255	Lingala	5860	Sindhi	6550		
		Lithuanian	5866	Singhalese	6555		

If you choose a Language that has a 3-letter language code, the code will be displayed every time you change the audio or subtitle language setting on page 19. If you choose any other languages, "--" will be displayed instead. (3-letter language code is written in bracket.)

SYLVANIA LIMITED WARRANTY

INFORMATION

FUNAI CORP. will repair this product, free of charge in the USA in the event of defect in materials or workmanship as follows:

DURATION:

PARTS: FUNAI CORP. will provide parts to replace defective parts without charge for one (1) year from the date of original retail purchase. Certain parts are excluded from this warranty.

LABOR: FUNAI CORP. will provide the labor without charge for a period of ninety (90) days from the date of original retail purchase.

LIMITS AND EXCLUSIONS:

This warranty is extended only to the original retail purchaser. A purchase receipt or other proof of original retail purchase will be required together with the product to obtain service under this warranty.

This warranty shall not be extended to any other person or transferee.

This warranty is void and of no effect if any serial numbers on the product are altered, replaced, defaced, missing or if service was attempted by an unauthorized service center. This limited warranty does not apply to any product not purchased and used in the United States.

This product is produced for home use and this warranty only covers failures due to defects in material or workmanship which occurs during normal use. It does not cover damage which occurs in shipment, or failures which are caused by repairs, alterations or product not supplied by FUNAI CORP., or damage which results from accident, misuse, abuse, mishandling, misapplication, alteration, faulty installation, improper maintenance, commercial use such as hotel, rental or office use of this product or damage which results from fire, flood, lightning or other acts of God.

THIS WARRANTY DOES NOT COVER PACKING MATERIALS, ANY ACCESSORIES (EXCEPT REMOTE CONTROL), ANY COSMETIC PARTS, COMPLETE ASSEMBLY PARTS, DEMO OR FLOOR MODELS.

FUNAI CORP. AND ITS REPRESENTATIVES OR AGENTS SHALL IN NO EVENT BE LIABLE FOR ANY GENERAL, INDIRECT OR CONSEQUENTIAL DAMAGES ARISING OUT OF OR OCCASIONED BY THE USE OF OR THE INABILITY TO USE THIS PRODUCT. THIS WARRANTY IS MADE IN LIEU OF ALL OTHER WARRANTIES, EXPRESS OR IMPLIED, AND OF ALL OTHER LIABILITIES ON THE PART OF FUNAI,

ALL OTHER WARRANTIES INCLUDING THE WARRANTY OF MERCHANTABILITY, AND FITNESS FOR A PARTICULAR PURPOSE, ARE HEREBY DISCLAIMED BY FUNAI AND ITS REPRESENTATIVES IN THE UNITED STATES. ALL WARRANTY INSPECTIONS AND REPAIRS MUST BE PERFORMED BY AN AUTHORIZED SERVICE CENTER. THIS WARRANTY IS VALID WHEN THE UNIT IS CARRIED-IN TO AN AUTHORIZED SERVICE CENTER.

IMPORTANT:

THIS LIMITED WARRANTY GIVES YOU SPECIFIC LEGAL RIGHTS. YOU MAY HAVE OTHER RIGHTS THAT VARY FROM STATE TO STATE. IF, AT ANY TIME DURING THE WARRANTY PERIOD, YOU ARE UNABLE TO OBTAIN SATISFACTION WITH THE REPAIR OF THIS PRODUCT, PLEASE CONTACT FUNAI CORP.

ATTENTION:

FUNAI CORP. RESERVES THE RIGHT TO MODIFY ANY DESIGN OF THIS PRODUCT WITHOUT PRIOR NOTICE.

WARRANTY STATEMENT REGARDING NON AUTHORIZED REPAIRS:

To obtain warranty service, you must take the product, or deliver the product freight prepaid, in either its original packaging or packaging affording an equal degree of protection, to any AUTHORIZED SERVICE CENTER. FUNAI CORP. will not reimburse you for any service done by unauthorized service providers without prior written approval.

To locate your nearest AUTHORIZED SERVICE CENTER or for general service inquiries, please contact us at:

FUNAI CORPORATION
Customer Service

Tel: 1-800-968-3429

<http://www.SylvaniaConsumerElectronics.com>

19900 Van Ness Avenue, Torrance, CA 90501

1 Conexiones

Consulte la "Basic TV Connection" en la página delantera antes de utilizar esta unidad.

2 Instalación de las pilas del control remoto

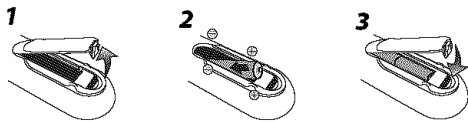

3 Conmutación VCR/DVD

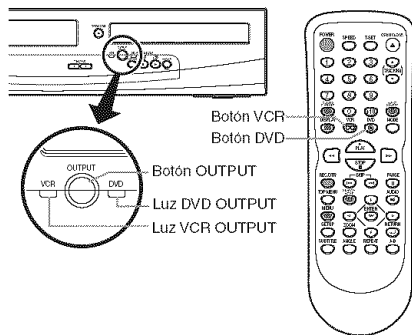

MODO VCR

Pulse [VCR] en el control remoto. (Compruebe que está encendida la luz VCR OUTPUT.)

MODO DVD

Pulse [DVD] en el control remoto. (Compruebe que está encendida la luz DVD OUTPUT.)

4 Activación de la unidad por primera vez



1 Asegúrese de que la entrada de su TV esté en VIDEO (El nombre puede cambiar según el fabricante del TV. Consulte el manual de su TV para conocer más detalles.)

2 Seleccione su idioma la primera vez que encienda esta unidad. A continuación, pulse [▶] para ir al siguiente paso.

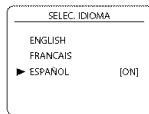

3 Cuando "AJUSTE DE RELOJ" aparezca, avance al segundo paso de "Ajuste del reloj" en esta página.



5 Ajuste del reloj



1 Pulse [SETUP] para seleccionar "AJUSTE DE RELOJ". A continuación, pulse [▶] para ir al siguiente paso.

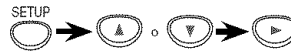

• Si no se ha ajustado el reloj, aparece la pantalla "AJUSTE DE RELOJ" cuando pulse [SETUP]. En este caso, vaya al paso 2.

2 Seleccione el mes actual. A continuación, pulse [▶] para ir al siguiente paso.



3 Seleccione el día actual. A continuación, pulse [▶] para ir al siguiente paso.



4 Seleccione el año actual. A continuación, pulse [▶] para ir al siguiente paso.



5 Seleccione la hora actual. A continuación, pulse [▶] para ir al siguiente paso.

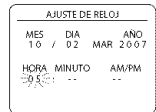

6 Seleccione los minutos actuales. A continuación, pulse [▶] para ir al siguiente paso.



7 Seleccione "AM" o "PM".



8 Presione [SETUP] para salir del menú "AJUSTE DE RELOJ".



6 Reproducción de la grabadora de vídeo

Antes:
Encienda el televisor.



<p>1 Inserte un casete de vídeo en esta unidad.</p>	<p>2 Para empezar la reproducción</p>
<p>3 Para parar la reproducción</p>	<p>4 Para expulsar</p>

7 Reproducción de DVD/CD

Antes:
Encienda el televisor, amplificador y otros equipos que puedan estar conectados a esta unidad. Asegúrese que el televisor y el sintonizador de audio están en el canal correcto.



<p>1</p> →	<p>2 Ponga un disco con la etiqueta hacia arriba.</p>
<p>3 Para empezar la reproducción</p>	<p>4 Para parar la reproducción</p>

8 Control remoto

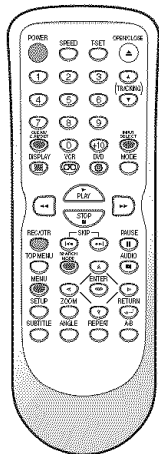

Botón (Orden alfabético)	Soporte	Modo DVD		Modo de grabadora de vídeo
1 2 3 4 5 6 7 8 9 0		• Para seleccionar directamente el capítulo o el título.	• Para seleccionar directamente la canción.	—
◀ ▶		• Para buscar en avance/retroceso en un disco. • Para empezar la reproducción en avance/retroceso lento durante el modo de pausa.	• Para buscar en avance/retroceso en un disco.	• Para el avance/retroceso de una cinta. • Para empezar la reproducción en avance lento durante el modo de pausa.
A-B ANGLE AUDIO		• Para repetir entre los puntos A y B elegidos. • Para seleccionar los ángulos de la cámara en un disco. • Para seleccionar el idioma de audio en un disco.	• Para repetir entre los puntos A y B elegidos. (CD)	—
CLEAR C RESET		• Para borrar los marcadores. • Para borrar los números mal entrados. • Para borrar el punto para la repetición A-B.	• Para borrar los marcadores. (CD) • Para eliminar el N° de estado en la entrada de programa. • Para borrar los números mal entrados. • Para borrar el punto para la repetición A-B. (CD)	• Para salir del menú de la grabadora de vídeo. • Para reponer el contador de cinta.
DISPLAY		• Para indicar el modo de disco actual.	• Para indicar el modo de disco actual.	• Para indicar la hora actual, contador de cinta y L1 o L2.
DVD		• Para seleccionar el modo de salida de DVD. • Para activar el modo DVD.	• Para seleccionar el modo de salida de DVD. • Para activar el mando a distancia en el modo DVD.	—
ENTER ◀ ▶		• Para mover el cursor y determinar su posición.	• Para mover el cursor y determinar su posición.	• Para seleccionar un ítem en el menú de la grabadora de vídeo. • Para avanzar al siguiente menú de la grabadora de vídeo. • Para volver un paso durante el ajuste del reloj y temporizador.
INPUT SELECT		—	—	• Para seleccionar L1 o L2.
MENU		• Para llamar el menú en un disco.	• Para llamar la lista de archivo. (MP3)	—
MODE		• Para activar/desactivar el nivel del negro. • Para activar/desactivar el ambiental virtual.	• Para disponer el orden de reproducción o la reproducción aleatoria. • Para activar/desactivar el envolvente virtual.	—
OPEN/CLOSE		• Para abrir o cerrar la bandeja del disco.	• Para abrir o cerrar la bandeja del disco.	• Para expulsar la cinta de casete del compartimiento del casete.
PAUSE		• Para hacer una pausa de reproducción del disco. • Para avanzar la reproducción un cuadro a la vez.	• Para hacer una pausa en la reproducción del disco.	• Para hacer una pausa de la reproducción o grabación de la cinta. • Para avanzar la reproducción un cuadro a la vez.
▶		• Para empezar la reproducción del disco.	• Para empezar la reproducción del disco.	• Para empezar la reproducción de la cinta.
POWER		• Para encender o apagar la unidad.	• Para encender o apagar la unidad.	• Para encender o apagar la unidad.
REC/OTR		—	—	• Para empezar una grabación o una grabación de un toque.
REPEAT		• Para reproducir repetidamente un capítulo o título.	• Para reproducir repetidamente una canción o disco. (CD) • Para reproducir repetidamente una canción, grupo o disco. (MP3)	• Para activar/desactivar el modo de repetición.
RETURN		• Para volver a la operación previa en el menú.	• Para volver a la operación previa en el menú.	—
SEARCH W/CE		• Para buscar un capítulo, título u hora. • Para colocar o buscar los marcadores.	• Para buscar una canción. • Para buscar el tiempo. (CD) • Para colocar o buscar los marcadores. (CD)	• Para llamar el menú de búsqueda de índice u hora.
SETUP		• Para llamar el menú de programación de DVD.	• Para llamar el menú de programación de DVD.	• Para llamar el menú de la grabadora de vídeo.
SKIP ▶▶▶ ▶▶▶		• Para saltar capítulos o título.	• Para saltar canciones.	—
SPEED		—	—	• Para seleccionar la velocidad de grabación.
STOP		• Para parar la reproducción.	• Para parar la reproducción.	• Para parar la reproducción o grabación.
SUBTITLE		• Para seleccionar subtítulos en un disco.	—	—
TOP MENU		• Para llamar el menú superior en un disco.	• Para volver al archivo superior de la jerarquía más alta en el programa y en la lista de archivo. (MP3)	—
TRACKING ▶▶▶ ▶▶▶		—	—	• Para ajustar manualmente el seguimiento durante la reproducción.
T-SET		—	—	• Para poner la grabadora de vídeo en el modo de espera para una grabación con temporizador.
VCR OC		—	—	• Para seleccionar el modo de salida de la grabadora de vídeo. • Para activar el modo de la grabadora de vídeo.
ZOOM		• Para ampliar parte de la imagen. (2x/4x)	—	—

corte aquí

Quick Use Guide

1 Connections

Please refer to "Basic TV Connection" on the front page before you use this unit.

2 Installing the Batteries for the Remote Control

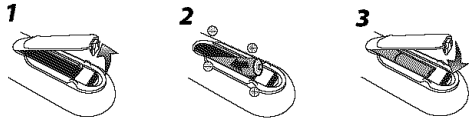

3 VCR/DVD Switching

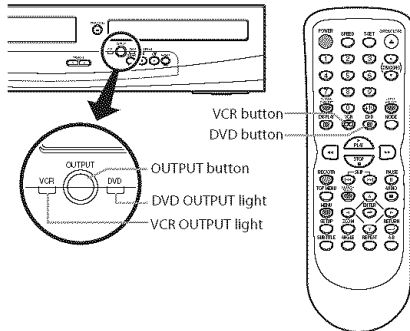

VCR MODE

Press [VCR] on the remote control.
(The VCR OUTPUT light illuminates.)

DVD MODE

Press [DVD] on the remote control.
(The DVD OUTPUT light illuminates.)

4 Turning on Unit for the First Time



- Be sure your TV's input is set to VIDEO. (Name may vary with TV manufacturer. See your TV manual for details.)



- Press [▲ / ▼] to select your on-screen language. Then press [▶] to continue.

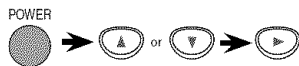

- When "CLOCK SET" menu appears, go to step 2 in "Clock Setting" on this page.

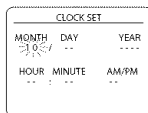

5 Clock Setting



- Press [SETUP] and select "CLOCK SET". Then press [▶] to go to next step.

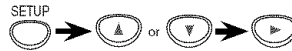

• If the clock is not set, "CLOCK SET" menu appears when you press [SETUP]. In this case, go to step 2.

- Select the current month. Then press [▶] to go to next step.

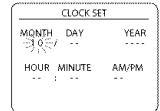

- Select the current day. Then press [▶] to go to next step.

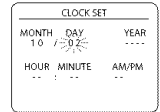

- Select the current year. Then press [▶] to go to next step.



- Select the current hour. Then press [▶] to go to next step.



- Select the current minute. Then press [▶] to go to next step.



- Select "AM" or "PM".

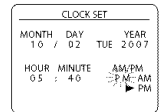
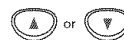

- Press [SETUP] to exit the "CLOCK SET" menu.



Quick Use Guide

6 VCR Playback

Before:

Turn on the TV.



1 Insert a cassette tape into this unit.	2 To start playback
3 To stop playback	4 To eject the cassette tape

7 DVD/CD Playback

Before:

Turn on the TV, amplifier and any other components which are connected to this unit. Make sure the TV and audio receiver are set to the correct channel.



1	2 Insert a disc with label facing up.
3 To start playback	4 To stop playback

8 Remote Control

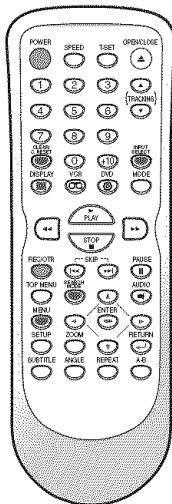

Button (Alphabetical order)	DVD mode		VCR mode
	DVD	CD MP3	VHS
1-9, 0	To select chapter or title directly.	To select track or file directly.	—
◀ ▶	To search forward/backward through a disc. To begin slow forward/reverse playback in the pause mode.	To search forward/backward through a disc.	To forward/backward a tape. To begin slow forward playback in the pause mode.
A-B	To repeat between your chosen point of A and B.	To repeat between your chosen point of A and B. (CD)	—
ANGLE	To select camera angles on a disc.	—	—
AUDIO	To select audio languages on a disc.	To select "STEREO", "L-ch" or "R-ch". (CD)	—
CLEAR/C RESET	To clear the markers. To clear numbers entered incorrectly. To cancel the point for A-B repeat.	To clear the markers. (CD) To remove status number in program input. To clear numbers entered incorrectly. To cancel the point for A-B repeat. (CD)	To exit the VCR menu. To reset the tape counter.
DISPLAY	To display the current disc mode.	To display the current disc mode.	To display the current time, tape counter, and L1 or L2.
DVD	To select DVD output mode. To activate DVD mode.	To select the DVD output mode. To activate DVD mode.	—
▲ ENTER ▼	To move the cursor and determine its position.	To move the cursor and determine its position.	To select an item on the VCR menu. To advance to the next VCR menu. To go back one step during clock and timer programming.
INPUT SELECT	—	—	To select input L1 or L2.
MENU	To call up the disc menu on a disc.	To call up the file list. (MP3)	—
MODE	To set black level on/off. To set virtual surround on/off.	To arrange the playing order or play randomly. To set virtual surround on/off.	—
OPEN/CLOSE	To open or close the disc tray.	To open or close the disc tray.	To eject the cassette tape from the cassette compartment.
PAUSE	To pause disc playback. To advance playback one frame at a time.	To pause disc playback.	To pause tape playback or recording. To advance playback one frame at a time.
▶ PLAY	To begin disc playback.	To begin disc playback.	To begin tape playback.
POWER	To turn the unit on/off.	To turn the unit on/off.	To turn the unit on/off.
REC/OTR	—	—	To start recording or one-touch timer recording.
REPEAT	To play back a chapter or title repeatedly.	To play back a track or disc repeatedly. (CD) To play back a file, folder or disc repeatedly. (MP3)	To select the repeat mode on/off.
RETURN	To return to the previous operation in menu.	To return to the previous operation in menu.	—
SEARCH MODE	To search chapter, title or time. To set or search the markers.	To search track or file. To search time. (CD) To set or search the markers. (CD)	To call up the index or time search menu.
SETUP	To call up the DVD menu.	To call up the DVD menu.	To call up the VCR menu.
SKIP	To skip chapters or titles.	To skip tracks or files.	—
SPEED	—	—	To select the recording speed.
STOP	To stop playback.	To stop playback.	To stop playback or recording.
SUBTITLE	To select subtitles on a disc.	—	—
TOP MENU	To call up the top menu on a disc.	To return to the top file of the highest hierarchy in the program and file list. (MP3)	—
TRACKING	—	—	To adjust the tracking manually during playback.
TSET	—	—	To put the VCR into standby mode for a timer recording.
VCR	—	—	To select the VCR output mode. To activate VCR mode.
ZOOM	To magnify part of a picture. (2x/4x)	—	—

cut here