

PROTOCOL®

KAPTUR™

WI-FI DRONE WITH HD CAMERA

INSTRUCTION MANUAL



THANK YOU.

Thank you for your purchase of Protocol's **Kaptur Wi-Fi Drone with HD Camera**. You are about to experience the best of what remote control flight has to offer. We strongly recommend that you take the time to read this manual thoroughly. It contains many tips and instructions on how to get the most out of this aircraft and maintain it for a long life.

As with any aircraft, this is a precision flying machine. Treat it well and enjoy all the fun it has to offer, flight after flight.

TABLE OF CONTENTS

01	Safety & Precautions
02	Parts
04	Remote Battery, Blade Guard, & Phone Installation
05	Charging the Drone
06	Start-Up Procedure
07	Operation
09	Tips on 360° Flips
11	Speed Modes
12	Trim Adjustment
13	Troubleshooting
14	Flying Outdoors
15	Shooting Photo/Video
16	Replacement Parts & Limited Warranty

SAFETY WARNINGS

PRECAUTIONARY SAFETY WARNINGS

- Read and follow instructions on how to synchronize electronics before each flight.
- To prevent damage to people or property, always avoid contact with other objects while in flight.
- Focus on flight. Do not participate in other activities such as texting that would distract from flight.
- Do not fly under the influence of alcohol or drugs.
- Inspect aircraft prior to each flight and do not fly if damaged.
- Never expose product or any of its electronic parts to moisture, water, or heat sources.
- Charge device in a cool, dry place and under adult supervision. Never leave the device unattended while charging.
- To prevent overheating, allow battery a cool-down period before recharging.
- To prolong engine life, allow a cool-down period between flights.
- Use only the charger and/or charging cable that is supplied with this item.
- Do not strike, cut, or pierce the internal battery or subject it to hard impacts.
- Do not mix old and new batteries or mix different types of batteries.
- Never attempt to modify function of vehicle or controller or attempt repairs using parts other than those supplied by Protocol. Spare parts are available at www.protocolny.com.
- Do not travel or bring on an airplane with the battery over 5% charged.

**THIS DEVICE USES COMPONENTS THAT OPERATE AT HIGH SPEEDS.
AS WITH ANY SUCH DEVICE, USE CAUTION TO OPERATE SAFELY.**

**FAILURE TO FOLLOW ANY OF THESE GUIDELINES MAY RESULT IN
BODILY INJURY OR DAMAGE TO PERSONAL OR PUBLIC PROPERTY.**

WARNINGS

FAA FLIGHT REGULATIONS

- Observe local FAA rules and regulations for flight.
- Do not fly in unpermitted locations.
- Go to www.faa.gov/uas to learn more about FAA drone regulations.
- This drone weighs under .55lbs and does not require registration.

PARTS

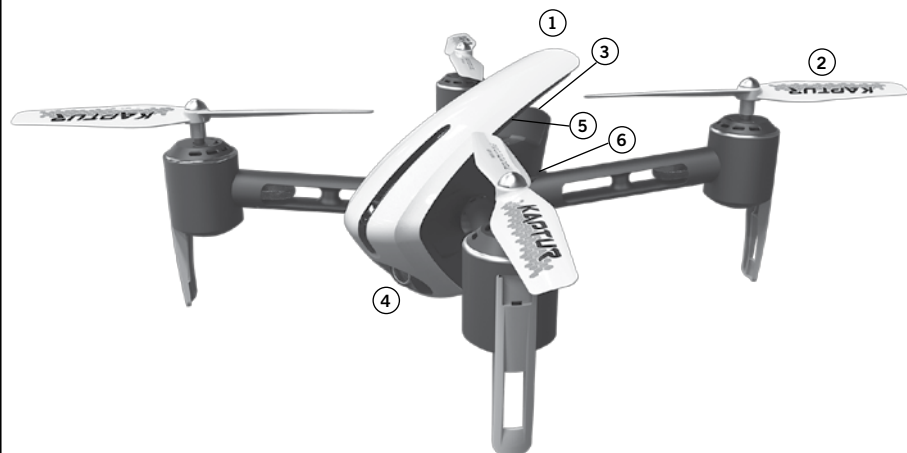

DRONE

1. Canopy
2. Blade
3. Battery Compartment
4. Camera
5. ON/OFF Switch
6. Memory Card Slot

ON/OFF SWITCH



BATTERY COMPARTMENT



PARTS

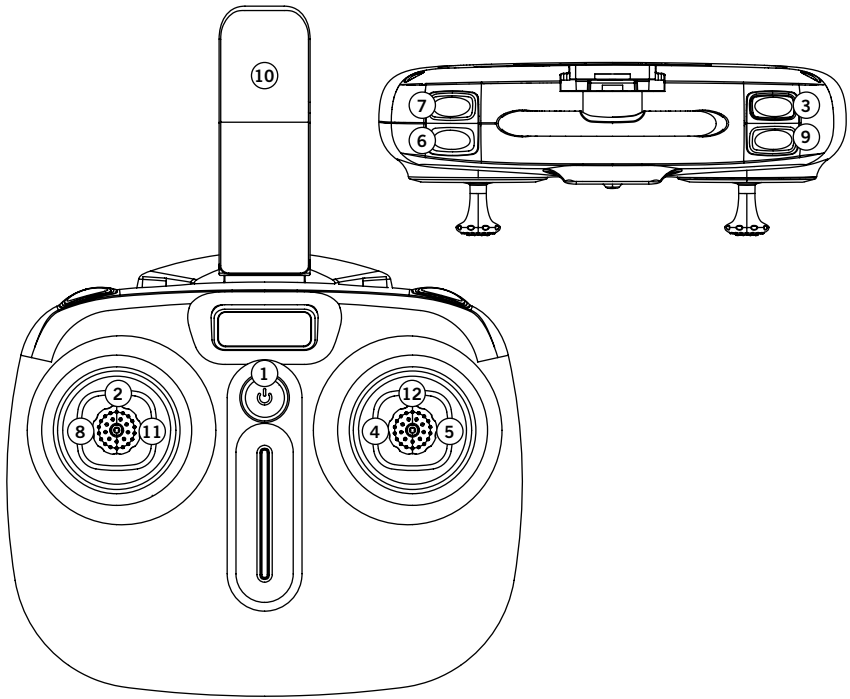

REMOTE

1. Power Switch
2. Trim (press in)
3. Flip 360°
4. Forward/Backward
5. Bank Left/Right
6. Video
7. Photo
8. Throttle
9. Auto Take Off/Land
10. Phone Clamp (not installed)
11. Turn Left/Right
12. Speed Mode Selector
(press in)

SPARE PARTS INCLUDED

- Replacement Blades
- Screwdriver

REMOTE BATTERY, BLADE GUARD & PHONE INSTALLATION

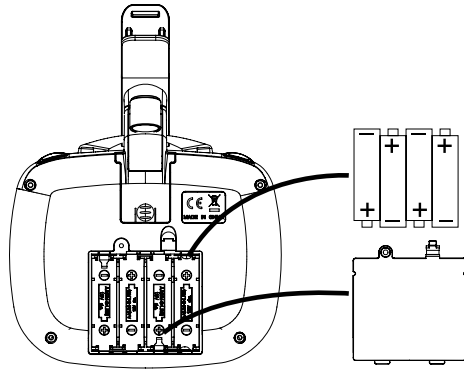

Unscrew and remove battery cover from controller. Insert 4 x 'AA' batteries according to indicated polarities. Replace and screw back in battery cover.

1. Install batteries carefully.
2. Do not mix old and new batteries.
3. Do not mix different types of batteries.

INSTALLING THE BLADE GUARD

If not already installed, install the included blade guards by snapping them in. Make sure the blade guards are secure and snug.

NOTE:

Loose blade guards may interfere with propeller movement and cause a crash. If the drone crashes, double check to make sure the blade guard is not loose. If it is, re-tighten before flying.

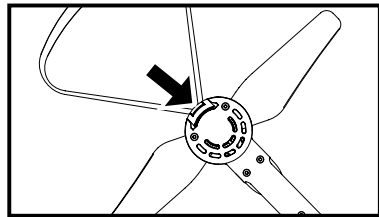

INSTALLING THE PHONE CLAMP

1. Remove the clip cover from the remote control.
2. Insert the phone clamp into the now empty slot on the remote.
3. Open the clamp to fit the phone.

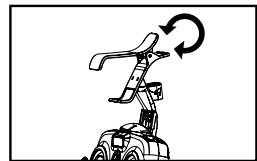
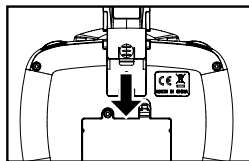
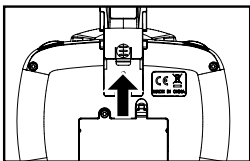

CHARGING THE DRONE BATTERY

1. Make sure the drone is turned off.
2. Press in on the two tabs and pull out the cartridge battery from the drone.
3. Connect the USB charging cable to the battery.
4. Plug the charger into a USB port. The USB light will flash green while charging and will turn steady once fully charged.
5. Plug the battery back into the drone.
Charging time: 140 minutes --- Flying time: approximately 12 minutes.

DO NOT CHARGE OVERNIGHT OR BEYOND THE CHARGING TIME STATED. DO NOT LEAVE BATTERY UNATTENDED.

*Battery: Li-Po, 7.4V, 700mAh

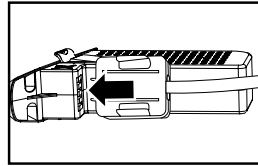

BATTERY SIGNALS

Lights are steady	Power is over 20% - will perform flips
Lights quickly flash twice every second	Power is under 20% - approximately 2 minutes left of flight time. Drone will no longer perform flips.

If you purchased extra batteries, allow the engines to cool between flights in order to prolong engine life.

CAUTION WHEN CHARGING

1. When charging, place product on a dry, well-ventilated surface and keep away from heat sources.
2. Always use adult supervision while charging.
3. In order to increase battery longevity, avoid repeat charging and excessive discharging.
4. As battery temperature is high immediately after flight, charge after cooling down for higher efficiency.
5. Do not strike or subject battery to hard impacts or sharp surfaces.
6. Do not use any other charger than that which is supplied with this item.
7. Do not use or leave battery near a heat source such as fire or space heater; exposure to heat may result in reduced performance or in some cases dangerous conditions.
8. If battery is left in charging state for an extended period of time after being fully charged, the battery may automatically discharge.
9. Never leave the battery unattended during charging.
10. Do not disassemble battery.
11. Do not submerge battery in water.

START-UP PROCEDURE

Before flying, the drone and transmitter must be turned on in sequence and synchronized.

1. Turn on the drone and place it on an even surface. The white lights on the drone are at the front and the red are at the back.
2. Turn on the remote control.
3. Both indicators on the drone and the remote will flash while they are syncing.
4. Push the throttle up and then down to sync. You will hear two beeps and the lights will go steady.

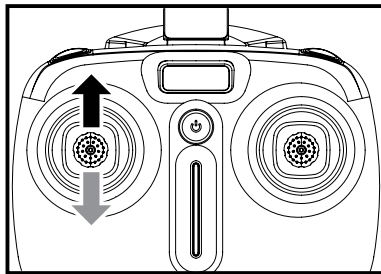

NOTE:

1. While the drone is in process of synchronizing, the lights will flash quickly. When the process is completed, the lights will go steady. This is your indication that the process is completed.
2. If after 30 seconds, it has not recognized the drone, turn off the controller and repeat Start-Up procedure.
3. If the Kaptur is unsteady in flight, it may not have been able to calibrate properly. Power down both drone and remote and restart pre-flight procedure, including re-calibration of the altitude sensor.

OPERATION: FLYING THE DRONE

*The lights on the drone may flash occasionally while the optical position sensor automatically locks into place. Once it is locked, the lights will remain steady while it has over 20% battery power.

STARTING THE ENGINE:

After synchronizing the drone, move the throttle up and release to go into Idle mode. The blades will rotate but the drone will not lift.

OR

After synchronizing the drone, pull the throttle and direction stick to the center at the same time and release. The blades will rotate but the drone will not lift.

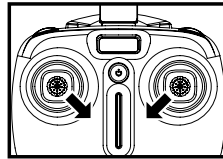
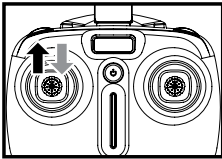

TAKE-OFF:

1. Press the take off button. The remote will beep and the drone will hover a few feet off the ground. Then gently advance the throttle to a desired height and release. The drone will hover at that height.*

OR

2. From Idle mode, gently advance the throttle up to a desired height and release. The drone will hover at that height.*

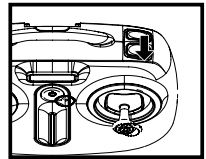

LANDING:

1. Press the landing button to lower the drone to the ground.

OR

2. Push down on the throttle until the drone is on the ground.

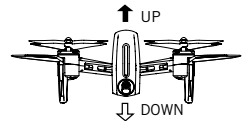
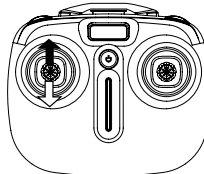

NOTE:

- The engine will shut off if you choose to hold the throttle down for 3 seconds.

- **Emergency Shut Off: When in flight, pull the throttle and direction stick to the center at the same time and the drone will shut off. Emergency Shut Off only works at altitudes under 10 feet.**

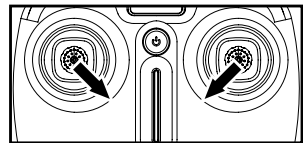

* The drone may drift a bit, especially in the first 30 seconds until the altitude sensor gets a good fix on the position. Some drift is normal.

OPERATION: FLYING THE DRONE

FIRST TIME FLYERS!!! TAKE YOUR TIME! GO SLOW!

Practice hovering until you are comfortable with flight before attempting any other maneuvers. Make small movements letting the stick return to the center. If you start to lose control, don't panic. Just press land.

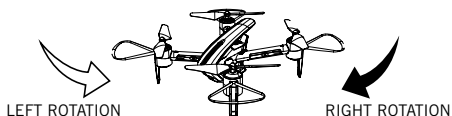
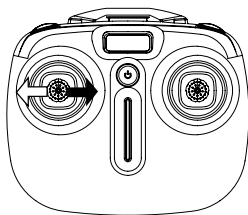

Pull the throttle left or right,
the drone turns to the left or right.

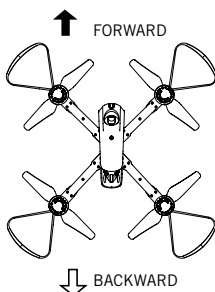
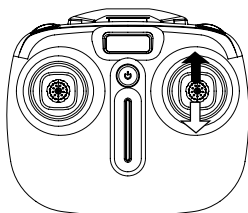

Push the direction lever up or down,
the drone flies forward or backward.

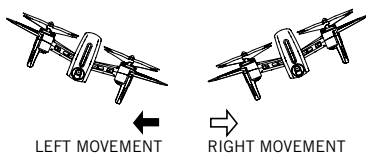
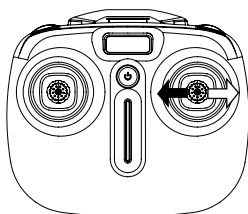

Pull the direction lever to the left or right,
the drone banks to the left or right.

TIPS ON 360° FLIPS

Once you have become skilled with the basics of drone flight, you can try some advanced maneuvers. At a height of at least 10 feet, press and hold the 360° Flip button and move the direction lever in any desired direction to execute the flip.

*Make sure to execute the flip outdoors in a space that's free of obstacles.

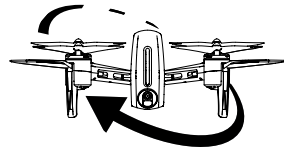
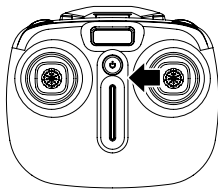
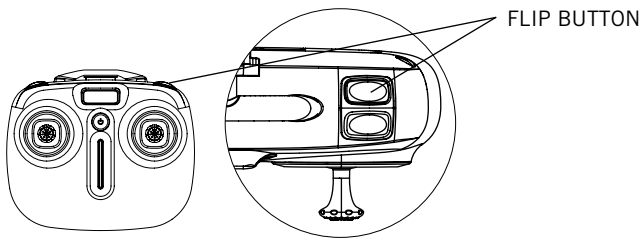

LEFT 360° FLIP

Push the direction stick to the left and the drone will perform a 360° flip in that direction.

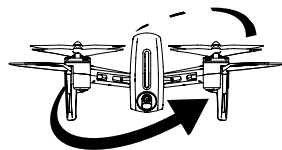
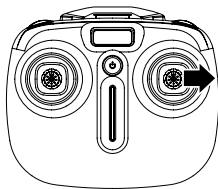

RIGHT 360° FLIP

Push the direction stick to the right and the drone will perform a 360° flip in that direction.

TIPS ON 360° FLIPS

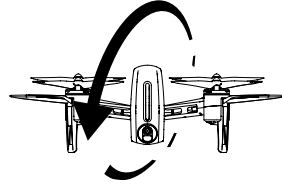
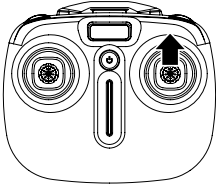

FORWARD 360° FLIP

Push the direction stick forward and the drone will perform a 360° flip in that direction.

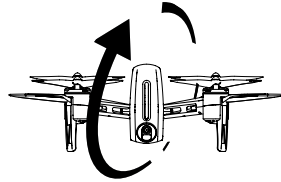
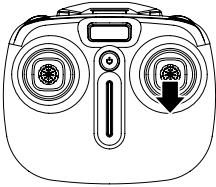

BACKWARD 360° FLIP

Push the direction stick backward and the drone will perform a 360° flip in that direction.

SPEED MODES

The Kaptur features two speed modes. Choose the speed based on flight experience and level of comfort. At high speed the drone will pitch more than at low speed. Kaptur is quite fast at its high speed and requires more piloting skills to fly competently. For safety take time to develop advanced skills by practicing at low speed first. The drone is preset to low speed. Press the direction stick in to change the speed mode. The remote will beep once for low speed and twice for high speed.

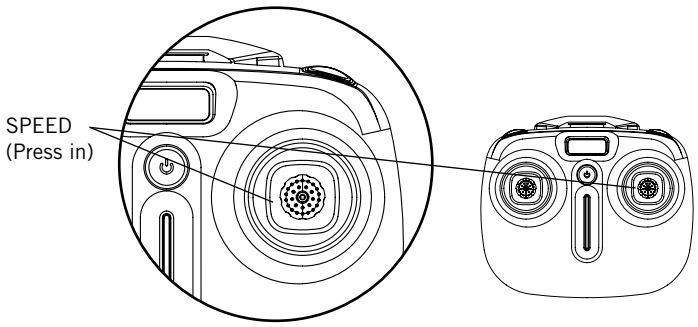

TRIM ADJUSTMENT

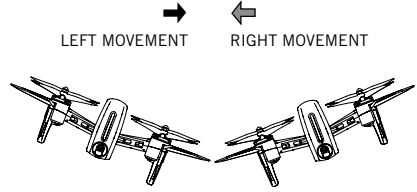
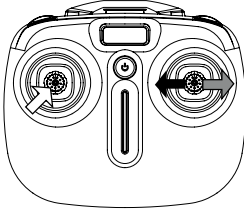

SIDEWAYS TRIM

When the drone drifts to the left or right side unintentionally, you can correct it by pressing in the throttle and holding while moving the direction stick in the opposite direction until it evens out.

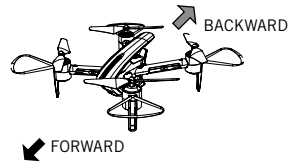
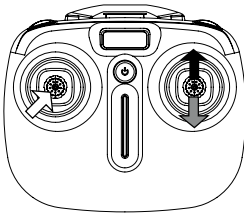

FORWARD/BACKWARD TRIM

When the drone drifts forward/backward unintentionally, you can correct it by pressing in the throttle and holding while moving the direction stick in the opposite direction until it evens out.

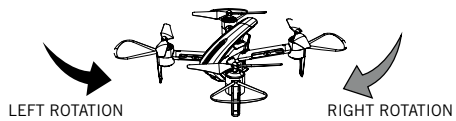
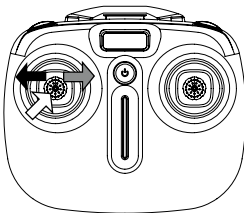

LEFT/RIGHT TRIM

When the drone drifts left/right unintentionally, you can correct it by pressing in the throttle and holding while moving it in the opposite direction until it evens out.

*NOTE: Trim adjustments are designed to counter drifts not caused by wind.

TROUBLESHOOTING

RE-CALIBRATING THE DRONE

If the drone crashes and after re-starting and trimming, it still is unstable, you have the option to re-calibrate the drone.

1. Turn on the drone and then the remote and sync.
2. Push and hold the both the throttle and direction stick to the lower right corners for 2-3 seconds.
3. The lights will flash to indicate that the drone has re-calibrated.

*Allow 15 minutes to pass between full flights as this will give the motors a chance to cool down. Failure to do so could wear out and shorten the life of the motors.

SYMPTOM	POSSIBLE CAUSE	POTENTIAL SOLUTION
Kaptur does not respond	<ol style="list-style-type: none">1. Communication between controller and aircraft was not synchronized during set up2. Battery power depleted on aircraft, controller or both.	<ol style="list-style-type: none">1. To synchronize, turn on aircraft first, place it on level ground, and then turn on controller.2. Charge aircraft and/or replace batteries in controller.
Response to control inputs intermittent or erratic	<ol style="list-style-type: none">1. Controller battery power nearly depleted.	<ol style="list-style-type: none">1. Replace batteries in controller.
Kaptur will not hover or strafe correctly	<ol style="list-style-type: none">1. The aircraft was not on level ground during synchronization.2. Trim settings are incorrect.	<ol style="list-style-type: none">1. Re-synchronize aircraft and controller.2. Recalibrate the Altitude Sensor.

HOW TO CHANGE THE BLADES

- All drones have two rotors that spin clockwise and two rotors that spin counter-clockwise.
- Make sure to place the blades on the correct axis or they will not spin correctly and the drone will not lift.
- Each blade is marked on its top with A or B. There may be a number after the letter but you can ignore the number.
- Make sure to follow the graphic below to see where to place the blades.

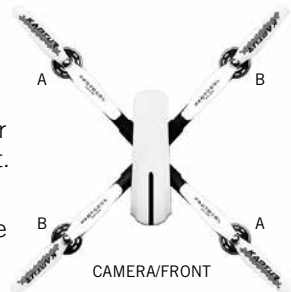

FLYING OUTDOORS

HOW TO PREVENT FLY AWAYS

To prevent “fly-away” situations (where drones seem to fly away out of control) it is important to first test and practice within close range before letting the drone fly too far away.

Each drone is designed to turn off the engines if the radio signal is lost. It is important to know and test the range of your drone before flying. We recommend turning on and syncing the drone and walking away while testing the engines. Keep walking and testing until it is obvious when you reach the point where the signal is not controlling the drone. This will be the control limit for the conditions in which you are flying. Distance does vary somewhat based on environmental and weather conditions, so testing the limit is advised. Fly in a range that is good for easy visual operation of the drone.

IF YOU CAN'T SEE YOUR DRONE, THEN YOU CAN'T CONTROL YOUR DRONE.

* Fly-aways are not covered by warranty as they are overwhelmingly caused by pilot error.

SHOOTING PHOTO/VIDEO

1. The memory card comes pre-inserted into the camera.
2. Set the camera in a desired position by pushing it up or down. Touch only the outer rim of the camera. Do not touch the lens.

SHOOTING PHOTOS AND VIDEO

1. Turn on the drone and sync.
2. Photo: Push the Photo button and the camera will take a photo. The lights on the drone will flash once as it's taking the picture.
3. Video: Push the Video and the camera will begin to record. The lights on the drone will flash continuously while recording. Push the Video button again and the camera will stop recording.
4. Press the memory card to unlock and remove. Plug it into the USB card reader. Then plug the card reader into the USB port of your computer. If you are using Windows, the USB will come up on the removable drive. If you are using OS, then the USB will come up as "Untitled".
5. Open the drive and then open the Video or Photo folders to access the .AVI or JPEG files.
6. .AVI movies can be played in several different formats including Quicktime, Windows Media Player, and RealPlayer.

WARNING: Never remove the card from the video camera while the drone is turned on.

REPLACEMENT PARTS

Thank you for your purchase of Protocol's **Kaptur Wi-Fi Drone with HD Camera**. We know that accidents can sometimes happen and that is why we offer spare parts kits on our website: **www.ProtocolNY.com**.

LIMITED WARRANTY

At Protocol, we're dedicated to bringing you innovative and well-designed products that make living fun and easy. We stand behind all of our products and warrant this to be free from defects in workmanship and materials for 30 days from the date of purchase. The warranty does not cover transportation damage, misuse, accident, or similar events. Specific legal rights pertaining to this warranty may vary by state.

For service claims or questions please consult our website **www.ProtocolNY.com**.

R/C DRONE NO.6182-7X

R/C DRONE WIFI NO.6182-7

Wifi Camera FCC ID:QV7-GC88752-22

Wifi Camera RSS IC:10196A-61827XBA

FCC, RSS STATEMENT

Changes or modifications not expressly approved by the party responsible for compliance could void the user's authority to operate the equipment.

This equipment has been tested and found to comply with the limits for a Class B digital device, pursuant to Part 15 of the FCC Rules. These limits are designed to provide reasonable protection against harmful interference in a residential installation.

This equipment generates, uses and can radiate radio frequency energy and, if not installed and used in accordance with the instructions, may cause harmful interference to radio communications. However, there is no guarantee that interference will not occur in a particular installation.

If this equipment does cause harmful interference to radio or television reception, which can be determined by turning the equipment off and on, the user is encouraged to try to correct the interference by one or more of the following measures:

- Reorient or relocate the receiving antenna.
- Increase the separation between the equipment and receiver.
- Connect the equipment into an outlet on a circuit different from that to which the receiver is connected.
- Consult the dealer or an experienced radio/TV technician for help.

This device complies with Part 15 of the FCC Rules. Operation is subject to the following two conditions:

- (1) this device may not cause harmful interference,
- (2) this device must accept any interference received, including interference that may cause undesired operation.

This device complies with Industry Canada license-exempt RSS standard(s).

Operation is subject to the following two conditions:

- (1) this device may not cause interference,
- and (2) this device must accept any interference, including interference that may cause undesired operation of the device.

Le présent appareil est conforme aux CNR d'Industrie Canada applicables aux appareils radio exempts de licence. L'exploitation est autorisée aux deux conditions suivantes :

- (1) l'appareil ne doit pas produire de brouillage,
- et (2) l'utilisateur de l'appareil doit accepter tout brouillage radioélectrique subi, même si le brouillage est susceptible d'en compromettre le fonctionnement.

FCC RF exposure statements

This Transmitter must not be co - located or operating in conjunction with any other antenna or transmitter.

This equipment complies with FCC RF radiation exposure limits set forth for an uncontrolled environment.

This equipment should be installed and operated with a minimum distance of 20 centimeters between the radiator and your body or nearby persons.

IC Radiation Exposure Statement:

This equipment complies with IC radiation exposure limits set forth for an uncontrolled environment. This equipment should be installed and operated with minimum distance 20cm between the radiator & your body.

Déclaration d'exposition aux radiations:

Cet équipement est conforme aux limites d'exposition aux rayonnements IC établies pour un environnement non contrôlé. Cet équipement doit être installé et utilisé avec un minimum de 20 cm de distance entre la source de rayonnement et votre corps.

