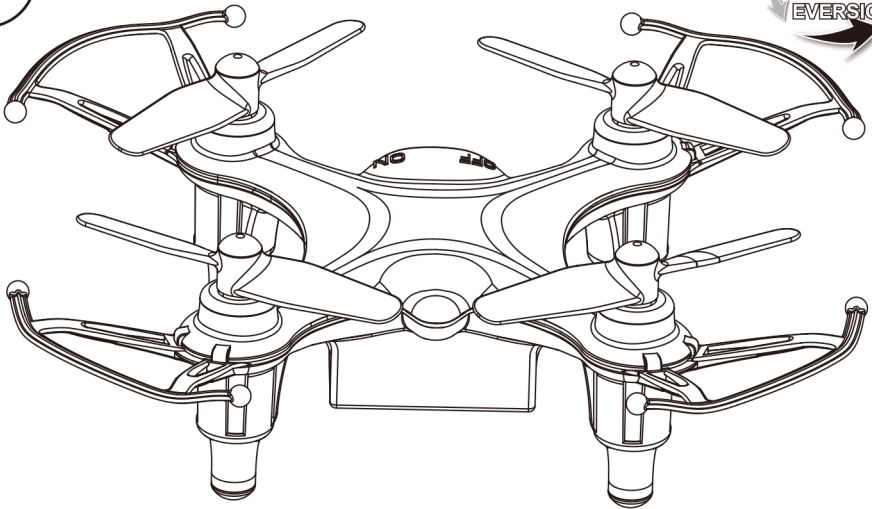


D2 *GYROSCOPE 2.4G* *EXPLORERS*

4CH 2.4G REMOTE CONTROL QUADCOPTER



INSTRUCTION MANUAL

1

IMPLEMENT STANDARD: GB/T26701-2011

Main characteristics

- Four-axis structure is applied, which makes the quadcopter more flexible and rapid when flying. It has the characteristics of wind-resistant and can be flown indoors or outdoors.
- Built-in 6 axis gyroscope for precise hovering in the sky.
- Modular design structure is applied, more simple for assembly and convenient for maintenance.
- With 360° 3D eversion function and throwing flight function.

The materials and specification mentioned in this instruction manual or the parts inside this package are for reference only. Our company won't be responsible for any adaptation of the outer package. Nor shall we keep our customers informed in advance. Any information updates or changes, please be subject to our website.

Instructions for use

- 1) Age classification: not suitable for children under 8 years of age
- 2) Before first use: read the user's information together with your child.
- 3) Flying the quadcopter requires skill and children must be trained under the direct supervision of an adult.
- 4) For toys intended to be assembled by the child: Check if the toy is assembled as instructed. The assembly shall be performed under the supervision of an adult.
- 5) Hands, hair and loose clothes shall be kept away from the propeller (rotor).
- 6) Do not change or modify anything on the quadcopter!
- 7) Caution! The quadcopter should not be started when persons, animals or any objects are within the flying range of the quadcopter.
- 8) Do not throw or hold any objects in the rotating rotor

Safety regulations

1. Please put smaller parts of the aircraft in the place where children can't reach, avoiding from accidents.
2. Power of this aircraft is adequate. Therefore, when flying for the first time, it should push remote control's right/left variable-speed joystick slowly, avoiding from collisions caused by rising aircraft rapidly.
3. After flying, it should turn off remote control's power supply and come close to the aircraft to turn off its power supply.
4. Please don't put battery in high-temperature and heated places(such as fire or nearby electric heating devices).
5. When the aircraft flies, it should maintain 2-3 meters from the user or others, avoiding from crashing into others' head, face or body when it lands.
6. When children operate the aircraft, they should be accompanied with the adult and guided by the adult. Ensure that the aircraft is controlled within the range of operator's (or instructor's) visibility. It is convenient for controlling.
7. Non-rechargeable battery can't charge. As installing or changing battery, please pay attention to the polarity. Don't use a mixture of old and new battery or battery with different types.
8. When it isn't used, it should turn off remote power supply of remote control and aircraft, respectively, and take out the battery in remote control.
9. Power supply terminal can't be short circuit.

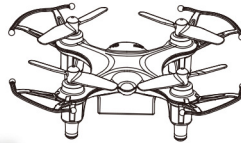
Maintenance

1. Use clean soft cloth to clean this product frequently.
2. Avoid from exposure or heating in the sun.
3. Don't put the toy in the water. Otherwise, it'll damage electronic parts.
4. Please check the plug and other accessories at regular intervals. If there is any damage, please stop using it immediately until it is repaired completely.

About contents

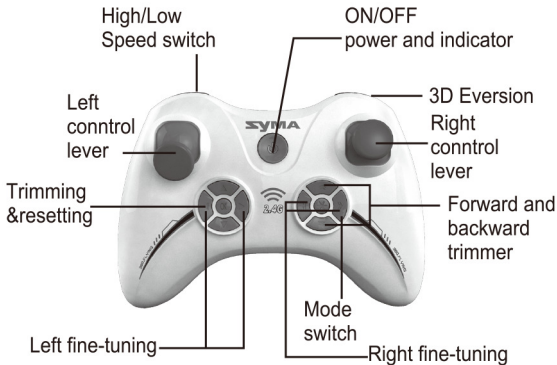
Product included following contents:

- Quadcopter
- 2.4G Remote controller
- USB charging wire
- Instruction manual
- Blade(4 pieces)

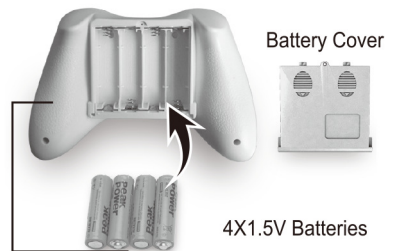


Get to know your transmitter

Introduction of transmitter



Remote control Installing the battery



Open the back cover at the back of the transmitter. Load 4PCS "AA"alkaline batteries correctly into the battery compartment as per the correct polarity shown on the battery compartment.



1. Install batteries with correct polarity.
2. Do not mix old and new batteries.
3. Do not mix different types of batteries.

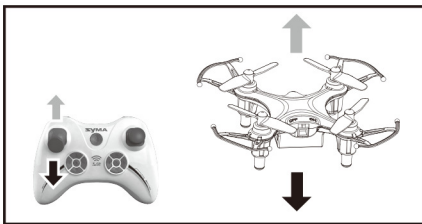
Controller modes & instructions

With the purpose of satisfying operational habits of different consumers, this remote control sets up two kind of different operation modes: Mode 1 and Mode 2. When starting, press on the Key A and switch Mode 1 and Mode 2, while turning on remote control's power supply simultaneously.

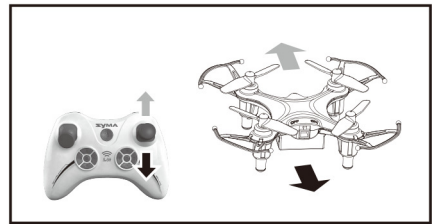


Illustration on controlling the QUAD COPTER (Mode 1, Defaulted mode when starting)

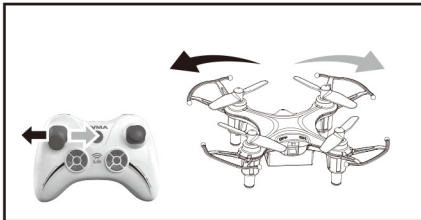
Operating direction



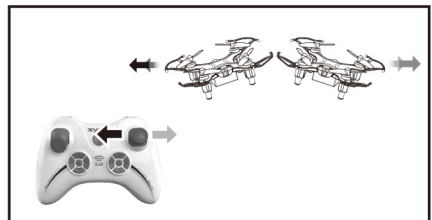
Push the throttle up or down, the quadcopter flies upward or downward.



Push the direction lever up or down, the quadcopter flies forward or backward.

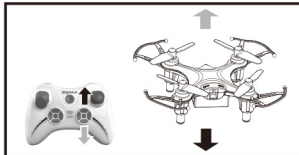


Pull the throttle left or right, the quadcopter turns to left or right.

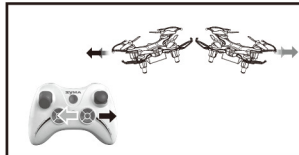


Pull the direction lever left or right, the quadcopter flies to left side or right side.

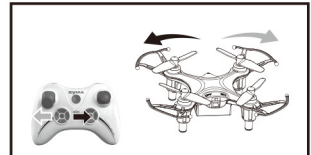
Fine-tuning operation



When the quadcopter keeps flying forward / backward, you can correct it by pressing fine-tuning button down / up.



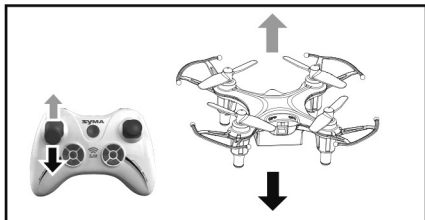
When the quadcopter keeps flying to left / right side, you can correct it by pressing the fine-tuning button right / left.



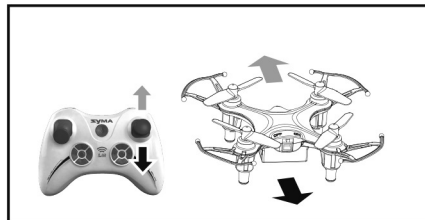
When the quadcopter keeps rotating to left / right, you can correct it by pressing the fine-tuning button right / left.

Illustration on how to control the QUAD COPTER (Mode 2)

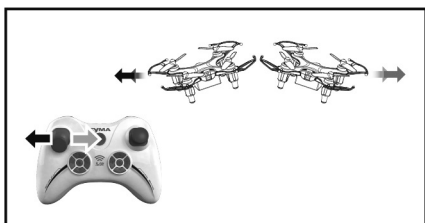
Operating direction



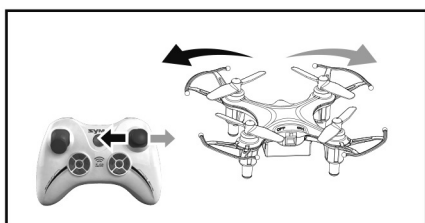
Push the throttle up or down, the quadcopter flies upward or downward.



Push the direction lever up or down, the quadcopter flies forward or backward.

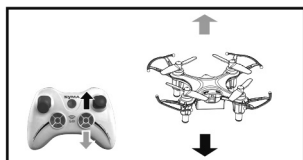


Pull the direction lever left or right, the quadcopter turns to left or right.

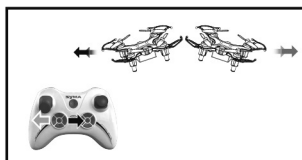


Pull the throttle left or right, the quadcopter flies to left side or right side.

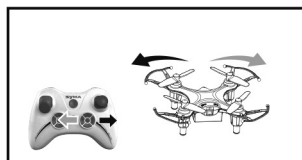
Fine-tuning operation



When the quadcopter keeps flying forward / backward, you can correct it by pressing the fine-tuning button down / up.



When the quadcopter keeps flying to left / right side, you can correct it by pressing the fine-tuning button right / left.

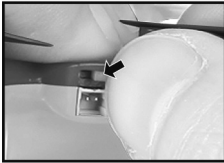


When the quadcopter keeps rotating to left / right, you can correct it by pressing the fine-tuning button right / left.

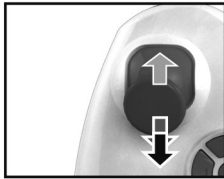
Ready to fly your quadcopter



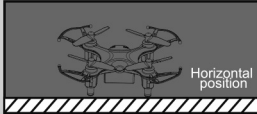
1: First of all, press the ON/OFF power switch.



2: Turn on the quadcopter button, and place the quadcopter on horizontal position .



3: Push the throttle lever to the highest position and then pull it back to the lowest position, this time there will be one clear sound sending out from the transmitter, this shows that the quadcopter has entered into the pre-fly state.



TIPS: When matching signal, keep the quad copter on horizontal position to fast matching and start a stable flight.

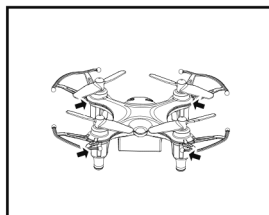
CAUTIONS:

1. When the indicator of the transmitter appears eternal bright, however, the indicator of the helicopter appears slow flashing, this means that decoding is not successful. This time please disconnect the power both of the quad copter and transmitter, then repeat the pre-flying steps.
2. If the quadcopter is tilting to one side abruptly or spinning while hovering, please switch off the power both of the quad copter and transmitter and then repeat the pre-flying steps.
3. When the indicator of the quad copter keeps flashing slowly, it means that the quad copter has entered into the low voltage protection state. This time you need to charge the quadcopter.

Function introduction

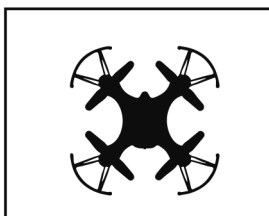
1.Low-voltage protection:

When four indicator lights on the bottom of aircraft start to flicker, it means electric quantity of the aircraft is insufficient. Please control the aircraft to make a return voyage.



2.Low-voltage protection:

When four indicator lights on the bottom of aircraft start to flicker, it means electric quantity of the aircraft is insufficient. Please control the aircraft to make a return voyage.



3.Horizontal correcting function:

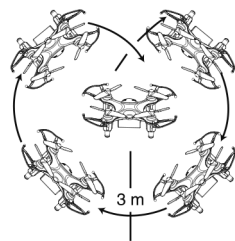
Place the quadcopter on a horizontal position, then push transmitter both left and right lever to lowest right corner for about 2-3 second , indicator on the quadcopter changed from normal lights up to quickly flashing ;After 2-3 second ,the indicator changed to normal lights, it means the quadcopter restarted /reset successfully.



4.3D eversion:

When you are familiar with the basic operation, you can do some awesome& exciting tricks and stunts! First of all,fly the aircraft to a height of more than 3 meters, press the 3D Eversion switch on the rear right side of the transmitter, then push the right rudder(in any direction) to make 360 degree flip.

Tips:3D eversion goes better when battery power is enough.



5.Throwing flight instructions:

Using 6 axis gyroscope, quadcopter bring you more fun. Throw out the quadcopter or push up throttle lever when it rolling, the quad-copter could hover smoothly in the sky.



6.Speed gear's switch function:

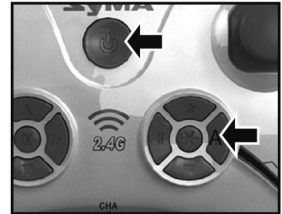
Low Speed: Press the High/Low speed switch for one time, the buzz will send out one sound.

High Speed: Please press High/Low speed switch once again, the buzz will send out two sounds.



7.Mode switch function:

Keep pressing the button A, then switch on power of the transmitter, you can select Mode 1 or Mode 2.



8.Resetting function:

Keep pressing the button B, then switch on the power of the transmitter. Enter into the Trimming & Resetting Mode (It is highly suggested that the freshman should reset the trimmer first before starting the first flight.)



Battery charging

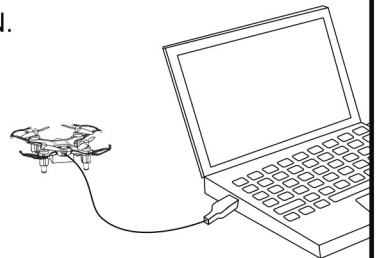
Battery charging

Take out the USB charging wire, connect one end to the quad copter, then insert the USB port of the USB charging wire to the USB port of the computer (or the USB port of the power adapter) to charge the battery. During the time of charging, the red indicator of the USB will be OFF.

When it is fully charged, the red indicator will be ON.

Caution:

1. When using the computer for charging, please remember to pull out the charging line before shutting down the computer.
2. Please pay attention to aim correctly to the correct polarity when connecting the USB wire with the battery. Please make sure the polarity should not be upside down.



Charging time: about 60 minutes ; Flying time: about 4 minutes!

CAUTIONS WHEN CHARGING

1. When charging, please put this product on the dried or ventilated area and keep it far away from heat source or explosive product.
2. When charging, please remove the batteries from the quad copter. All the charging process should be under the guidance of the adult so as not to cause accident.
3. When finish flying, please do not charge the battery which surface temperature is still not cooled down. Otherwise it may cause swollen battery or even cause fire disaster.
4. During the process of battery charging, falling down or striking by the outer force should be avoided. Otherwise it may cause short-circuited within the battery and thus may cause danger.
5. In order to make sure safety, please make sure that you need to use the original USB charging wire that made from our factory. When the battery is used for a long time or appears aging or swollen, please replace them timely.
6. When the batteries are fully charged, if you do not remove it from the charger for a long time, the battery may discharge automatically, which may cause battery exhaustion. When the battery voltage that the charger has tested is lower than the rated voltage, the charger will re-charge the battery until it is fully charged. Charging or discharging too often or repeated charging or discharging may reduce the using life of the batteries.

BATTERY REPAIR & MAINTENANCE

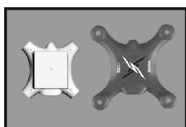
1. Battery should be put in the dried or ventilated place with environment temperature about 18-25 ℃.
2. In order to enhance the using life of the battery, please avoid repeat charging or excessive discharging.
3. When the battery needs to be stored for a long time, please charge the battery first. That is to say, charge the battery for about 50-60% of the volume and then well store it.
4. If you do not use it for more than 1 months, it's highly recommended that you need to check the battery voltage every month so as to make sure the voltage no less than 3V. Otherwise please do by following No.(3) mentioned.

Maintenance procedure

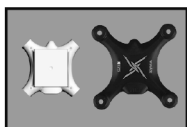
Problems	Causes	Solutions
Aircraft has no response	<ol style="list-style-type: none"> 1. Aircraft enters into low-voltage protection. 2. Electric quantity of remote control is insufficient, power indicator light will flicker. 3. Channel selection of remote control is inconsistent with aircraft's match codes. 	<ol style="list-style-type: none"> 1. Charge the aircraft. 2. Change remote control's battery. 3. Adjust channels of remote control and aircraft, and make them become consistent.
Aircraft's flying response is insensitive	<ol style="list-style-type: none"> 1. Insufficient remote control's electric quantity. 2. Remote control with the same frequency is transmitting interference. 	<ol style="list-style-type: none"> 1. Battery replacement. 2. Change the place where has no transmitting interference of the same frequency.
When hovering, side flight is formed	<ol style="list-style-type: none"> 1. Have no horizontal correction. 	<ol style="list-style-type: none"> 1. Conduct horizontal correction, as shown in p. 6(3)(correcting function)

Spare parts

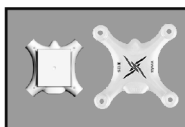
Here are alternative accessories. In order to provide convenience for customer purchasing, every component are marked. Accessories can be purchased from local dealer. Please specify the color when purchasing.



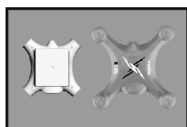
D2-01A
Fuselage-red



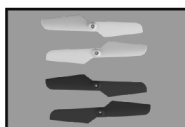
D2-01B
Fuselage-black



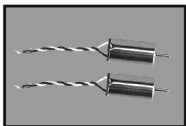
D2-01C
Fuselage-white



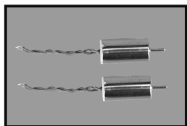
D2-01D
Fuselage-green



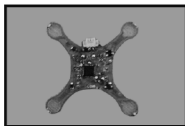
D2-02
Blades



D2-03
Motor A



D2-04
Motor B



D2-05
Circuit board



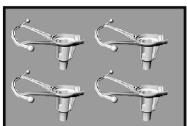
D2-06
Battery



D2-07
Soft mat



D2-08
USB



D2-09
Landing skids



D2-10
Transm