

# USER'S MANUAL M901DB



## Contents

### Safety Notices

#### Getting ready to use the device

- What's inside box
- Product Appearance
- Control buttons and connections

- Technical Specifications

Quick Guide

- Power on / Power off
- Standby and Lock screen
- The desktop status bar and shortcut menu and the definition of the icons
- Orientation Sensor Setting
- Battery management and recharging
- WIFI network settings
- Mobile network settings
- To install an APK file
- To uninstall an APK file
- Camera
- Voice recording
- Use the device a multi media player
  - Music playback
  - Video playback
  - Photo browsing
- File Management
- Set OSD Language
- Set Keyboard
- Set Date and time
- About the Device
- Trouble Shootings

Safety notices

- 1 ) Keep this device away from strong magnetic field to avoid any damages
- 2 ) Do not rub this device with any hard objects and never clean this device with any chemicals or detergents or acids or it could cause damages on surfaces.
- 3 ) Humidity or liquid may enter this device and causes permanent damages to the hardware inside. Do not place this device in any humid environment or under the rain.

- 4 ) It is recommended that volume level of the earphones should be adjusted to an appropriate level to avoid damages to your hearings due to high volume.
- 5 ) Do not cut off the power abruptly during software update, software download, or during this device is under any kind of operation or it may cause data lost and system error.
- 6 ) Over-voltage, power cable strain, bending or squeezing by heavy objects must be avoided to prevent this device from overheating or fire disaster.
- 7 ) To eliminate the risk of electric shock, do not connect the power plug with wet hands.
- 8 ) Some movies, music and pictures are under protections of copyrights, any unauthorized usages are deemed as infringements to the laws of copyrights.
- 9 ) The performance of the WIFI reception of this device could be influenced by the wireless equipments and networks in the surrounding areas.
- 10 ) Any wireless equipment will influence the flight of an airplane, please consult the airline company if you want to use this device on the airplane.
- 11 ) Do not use this device anywhere near any blasting operations.
- 12 ) Only qualified maintenance personnel is allowed to dismantle this device.
- 13 ) Please comply with any related restrictions and rules when using this device.
- 14 ) Only use this device with its original accessories and battery.
- 15 ) Do not use any incompatible accessories on this device.
- 16 ) This device is not waterproof, please keep it dry all the time.
- 17 ) For the sake of data safety, please back up the important data anytime on a timely basis.
- 18 ) When connecting this device with other equipments, please follow instructions on this user's manual.
- 19 ) Never connect this device with any incompatible equipment.
- 20 ) Please consult the after-sales service in your area for any technical problems.

Getting ready to use the device







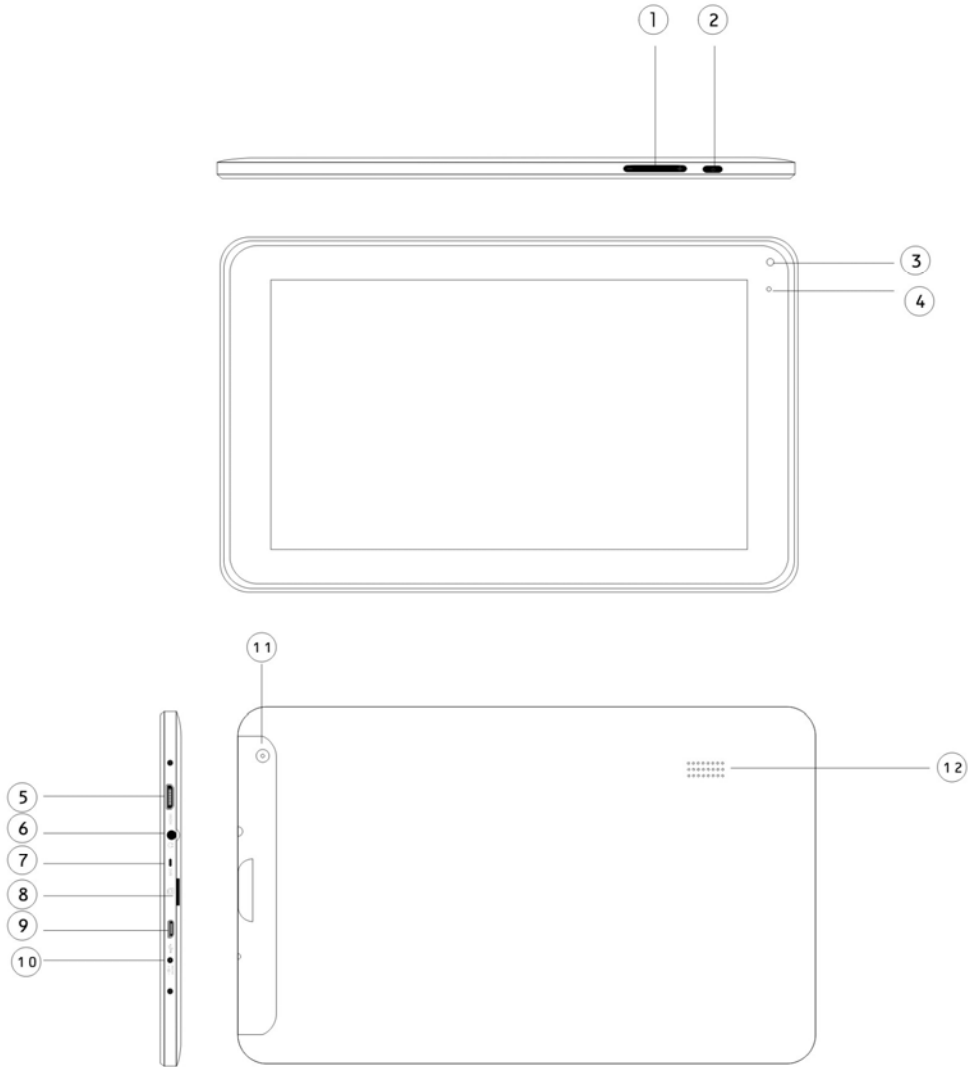





What's inside box

Components	Quantity
Tablet PC	1
Power Charger	1
Earphone	1
USB Cable	1
User Manual	1

# Product Appearance



Control buttons and connections

View	Button	Function
Top	① 	Volume up / Volume down
	② 	Power on / off
Front	③ 	0.3MPiXEL camera
	③ 	Indicator of light
Side	④ 	HDMI output
	⑤ 	Earphone jack
	⑥ 	Microphone
	⑦ 	Micro SD card slot
	⑧ 	USB slot
	⑨ 	DC 5V power jack
Back	⑪ 	2.0MPiXEL camera
	⑫ 	Loudspeaker

## Technical Specifications

LCD Display	Size	9" TFT display
	Resolution	800*480
Operation System	Android 4.2	
PC interface	High speed USB2.0 HOST for external U-disk, Mouse, etc	
Built-in Flash	Flash Memory: 8GB	
Built-in RAM	1GB DDRIII	
Capacity Expansion	Support Micro SD Card up to 32GB (not included)	
Battery	Built-in 3.7V Lithium rechargeable battery	
Power Supply	Input: AC100V~240V 50/ 60Hz Output: DC 5V-2A	
Music Function	Format	WMA、MP3、OGG、APE、FLAC、AAC、WAV
	Headset max. output	(L)5mW+(R)5mW(32Ohm)
	Bit rate	8Kbps ~ 320Kbps
	WMA、WMV、Bit rate supported	5Kbps ~ 320 Kbps
	Frequency response	20Hz to 20KHz
	SN ratio	90dB
	Distortion	<0.05%
Video Function	Play format	MKV、AVI、RM、RMVB、MP4、MOV、VOB、DAT、FLV、3GP, etc
	Max. resolution supported	2160p
	Ratio	4:3、wide screen for optional

Photo browse	JPG、JPEG、BMP、GIF supported	
E-book Function	Format Supported	TXT、LRC、PDF、Html、Htm、EPUB, etc
	Max. capacity	20M
Recording function	Format supported	3gpp Format
WI-FI Function	Spec	802.11b/g/n
	Transmission rate	Max150Mbps
	Transmission Distance	Max100m
	Work Frequency	2.4GHz
Bluetooth Function	Spec	V2.1+EDR
	Work Frequency	2.4GHz
HDMI	HDMI up to 1080p	
3G	Support only external 3G USB-DONGLE wireless network card (3G card and USB-Dongle are not included)	
Auto Screen Rotation	Selectable from Setting menu	
Loudspeaker	Built-in 1W@8ohm*2	
Working temperature	-10 ~ 45°C	
OSD Languages	Default language: English Other options: Catala, Cestina, Dansk, Deutsch, Romanian, Espanol, Francais, Hebrew, Hrvatski, Indonesian, Italiano, Latviesu, Leituviu, Magyar, Nederlands, Norsk Bokmal, Polski, Portugues, Romana, Romansh, Slovencina, Suomi, Svenska, Tagalog, Tieng Viet, Turkce, Russian, Korean, Chinese, Japanese	
Operation systems supported	Compatible with Windows 98 se / 2000 / XP / Vista / 7, Mac 9.1 or above, Linux 2.4	



## Quick Guide

### Power on / Power off

Long press  button for 3 seconds to power on the device.

It will take about a minute and half to boot the system.

Unlock the screen by sliding  to the right.

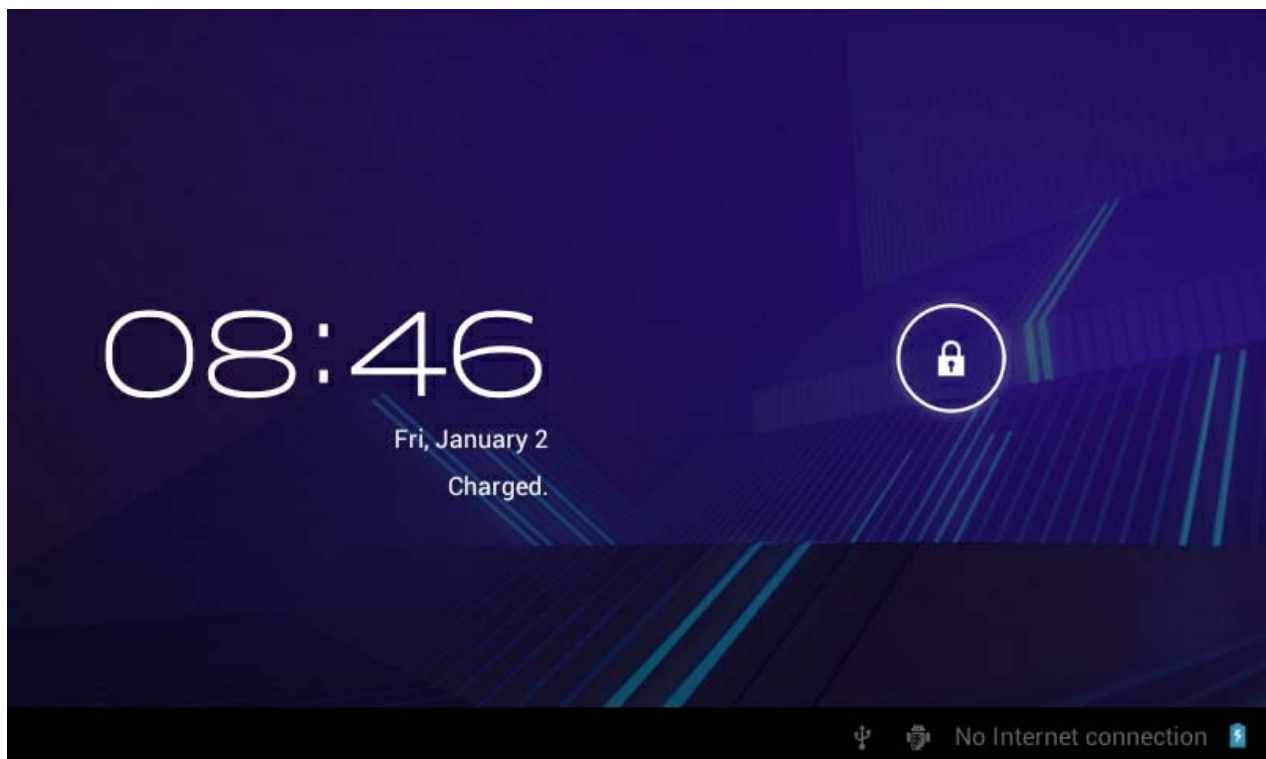

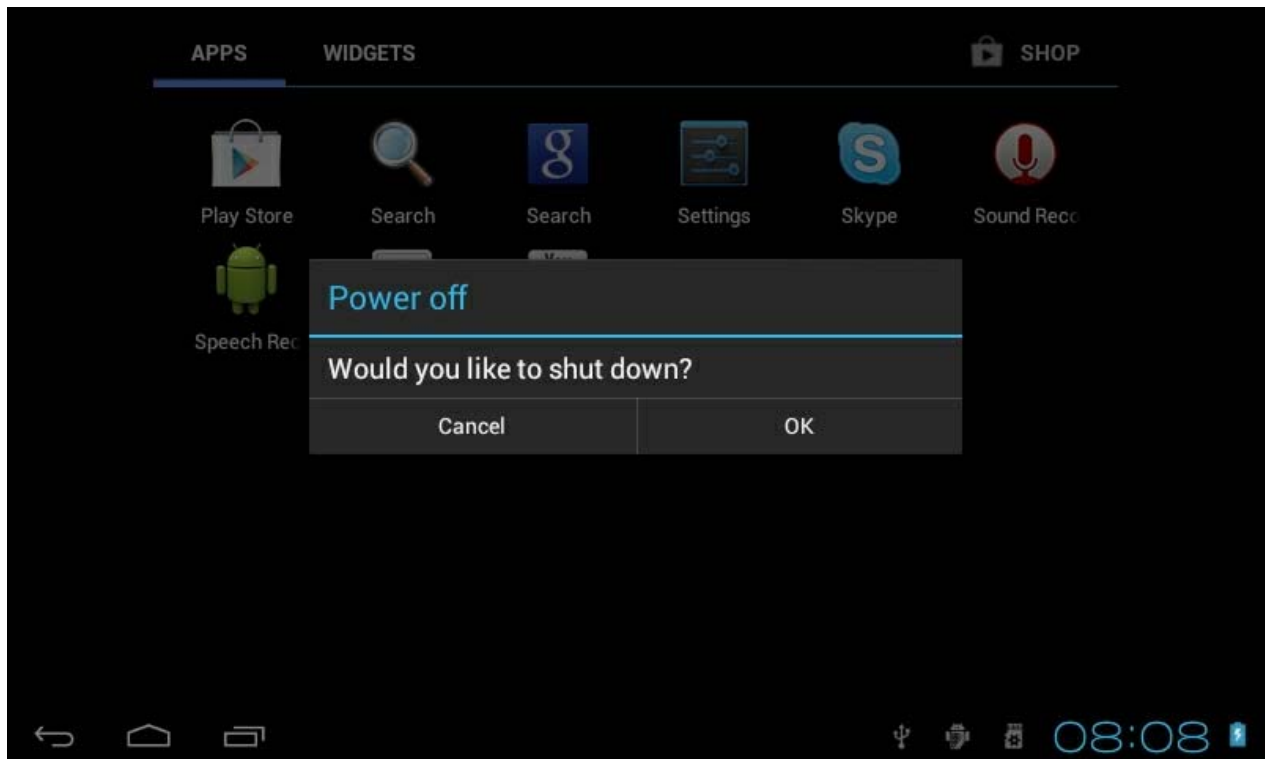

To power off the device, long press  button for 3 seconds, the screen will show the power off options:

Cancel or OK. Tap "OK" to power off the unit or tap "Cancel" to exit to previous operation.



【Note】When the device is low battery, it will alert continuously and will shut down automatically when battery has completely run out. The device cannot be powered on if the battery is empty, please recharge the battery at least one minute before restart the device.

### Standby and Lock screen



Press  button shortly to turn the device to standby mode. Under standby mode, the screen is blackout and volume is muted. Press  button shortly again to reactivate the device. The device will then turn to Lock screen while the primary operation of the device will continue.





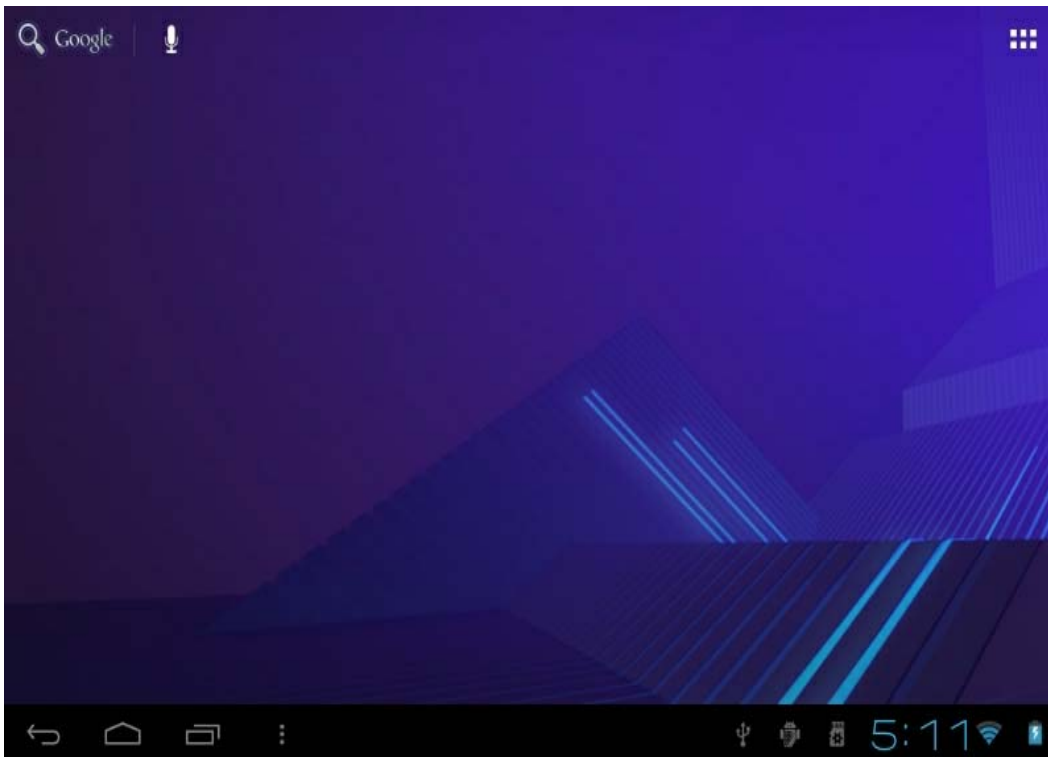





Unlock the screen by sliding  to the right to resume to status before power saving.

**【Note】** The primary operation of the device under standby mode will pause and the primary operation of the device under Lock screen mode will continue, only the screen is locked.

The desktop status bar and shortcut menu and the definition of the icons



Icon	Function
	Back – Tap it to go to the previous screen
	Home page - Tap it to return to the desktop

	Tap it to check the latest files that you browsed
	Tap it to adjust the volume
	Tap it to go to a shortcut menu for: "Wallpaper" - select wallpaper for the home screen. "Manage apps" - go a list of installed applications. "System Setting" - go to Setting menu directly.
	The USB icon appears only when the device is connected to a USB device successfully.
	The Android logo appears only when the device is connected to a computer.
	The micro SD card icon appears only when a micro SD is inserted into the device.
	The current system time
	The WIFI signal indicator appears only when the device is connected to a WIFI network.
	The 3G signal indicator appears only when the device is connected to an external 3G dongle.
	The battery icon shows the remaining battery level or to indicate battery recharging status.
	Applications – Tap it go to Application menu

### Orientation Sensor Setting

The device contains a sensor that will automatically change the orientation of screen by 90 degree as you rotate the tablet. The sensor works the best when the tablet is rotated perpendicular to the ground (i.e., when the tablet is held

upright and not flat on its back).

The Orientation sensor can be activated or deactivated in the Setting menu: Setting → Display → Auto-rotate screen. Tick the box if you want to activate the sensor or un-tick the box to deactivate this function.

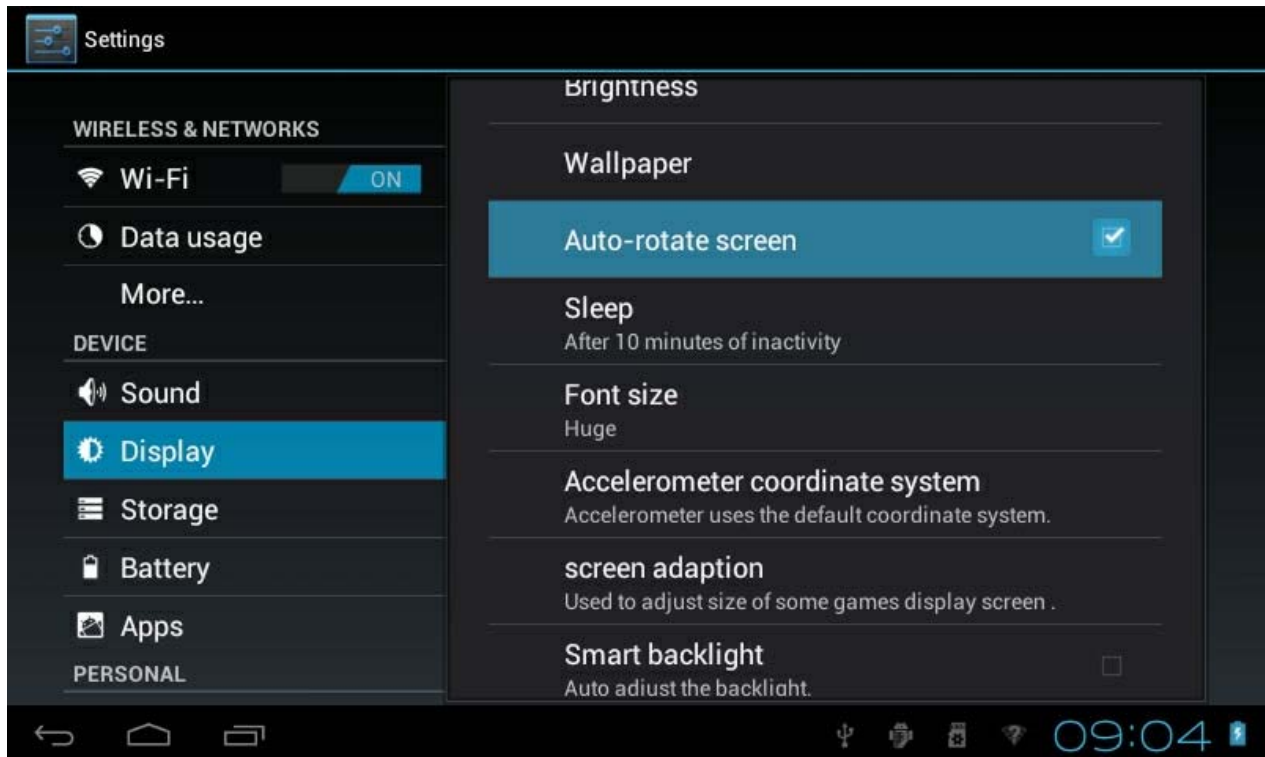

### Battery management and recharging

- a. Recharge the battery about 3 to 5 hours to make sure the battery is fully charged at the first time.
- b. Plug in the power charger provided in the accessory pack to the DC-5V slot located on the lower right side of the device and connect the power charger to a proper power socket. Once the power is connected, the battery recharging icon will appear  on the status bar which indicating that the device is under recharging. When the power recharging icon will turn to blue entirely when the

battery is fully recharged and you can disconnect the power charger from the device.

**【Note】** In order to keep the battery in the best condition, please pay attention to the below:

- Don't recharge the device under high temperature.
- Don't release the power of the battery, you can charge the battery when there is still power in the battery. It is not necessary to wait the battery to completely run out before recharging.
- To maintain the battery with a long life span, keep recharging the battery once every two weeks in the case if you don't use the device for a long time.

### WIFI network settings

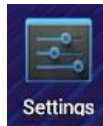

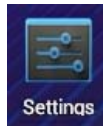
From desktop, Tap  to enter setting menu and slide WI-FI function to ON and tap the desired WIFI network and enter the wireless network setting page.



Enter the password and tap "Connect" or tap "Cancel" to exit to previous screen.

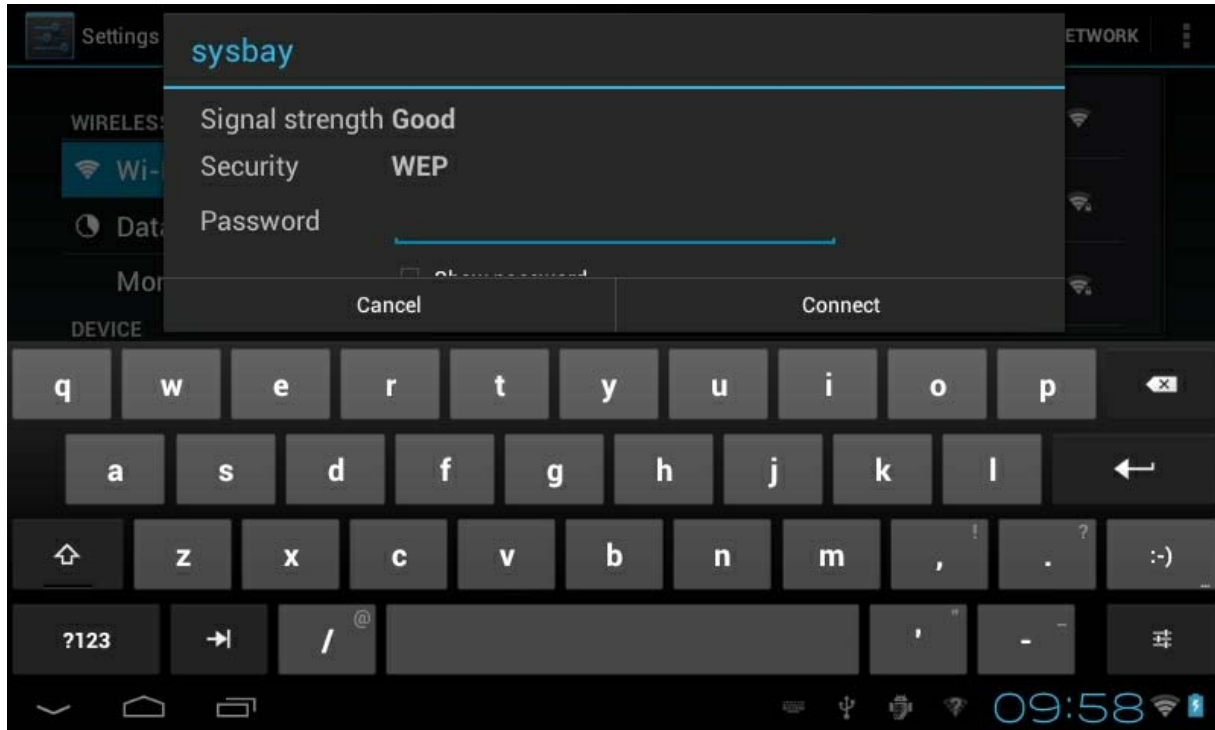

### Mobile network settings

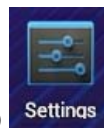

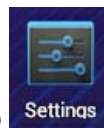
From desktop, Tap  to enter setting menu and tap "More..." to enter the sub-menu and tap "Mobile networks" to enter Mobile network setting.

Insert a 3G dongle with 3G network card and follow the instruction to select and enter the appropriate data required by the 3G network provider.

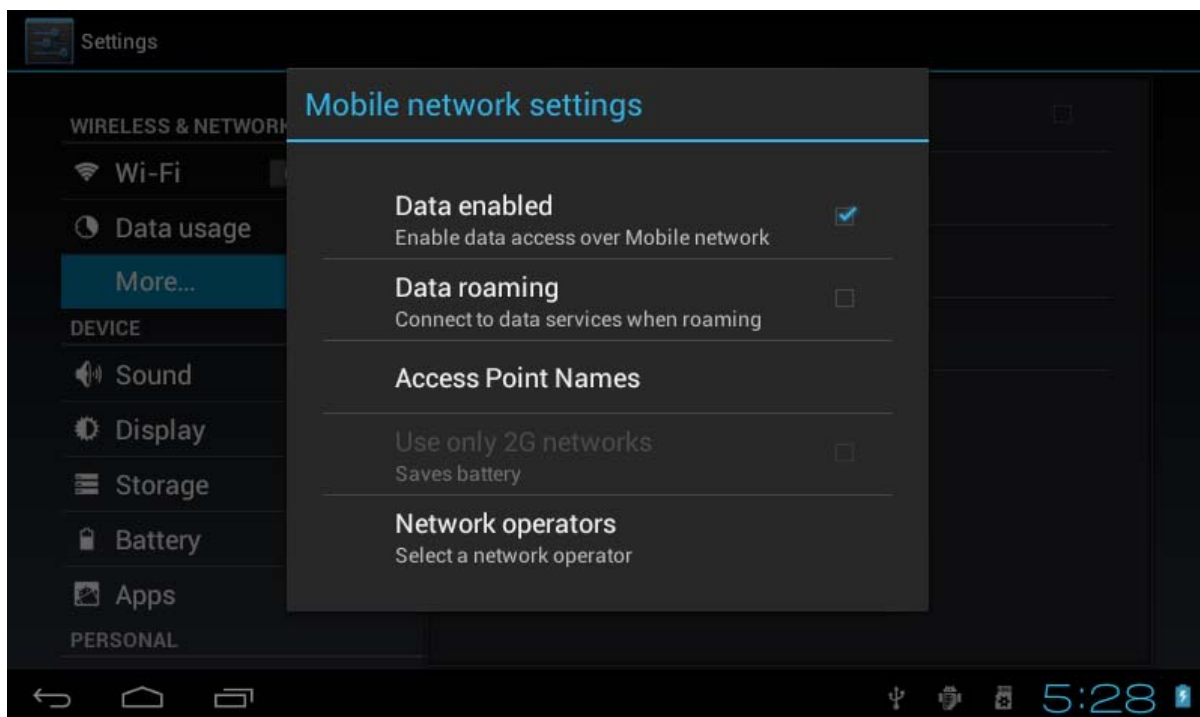
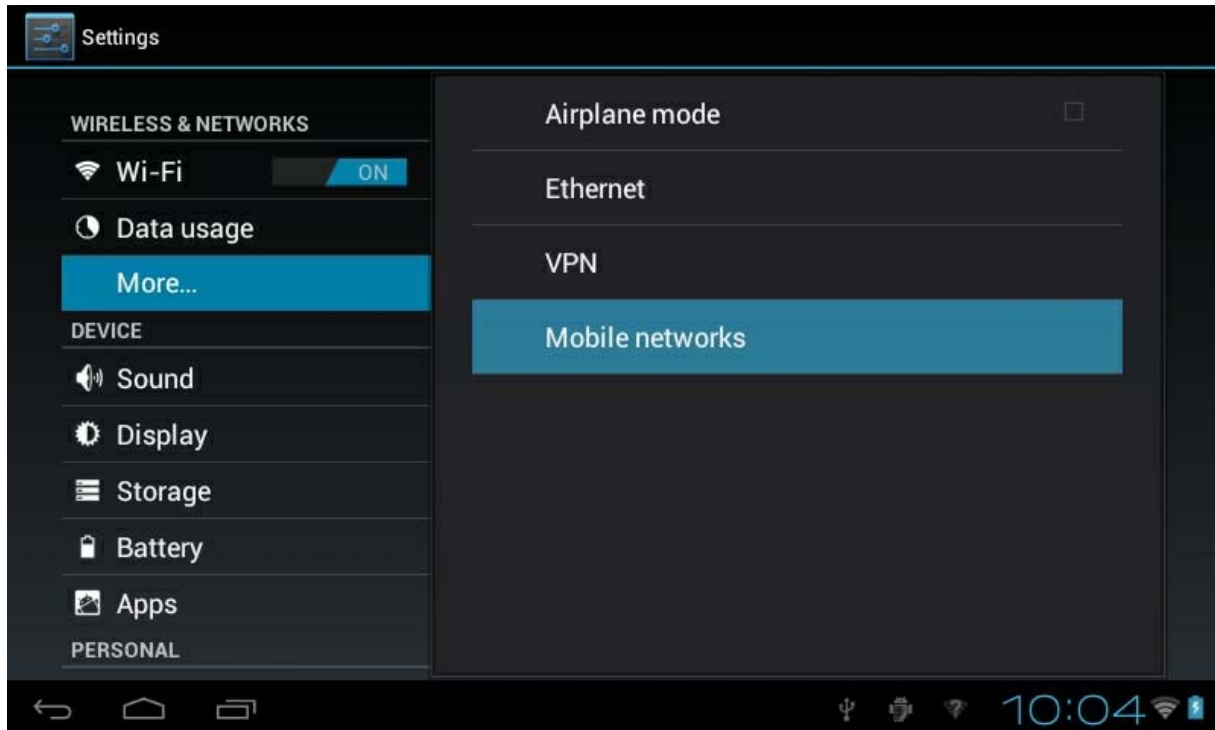



## To install an APK file

This device supports third part Application Program .APK files.

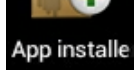
From desktop, Tap  to enter application menu and tap  to enter APK installer tool or;

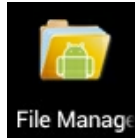
From desktop, Tap  to enter application menu and tap  to enter a list of file and tap on the desire APK file to install the APK directly.

## To uninstall an APK file

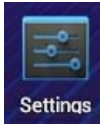
From desktop, Tap  to enter setting menu and tap “Apps” to enter a list of installed application. Tap the desired APK file and tap “Uninstall” to confirm.

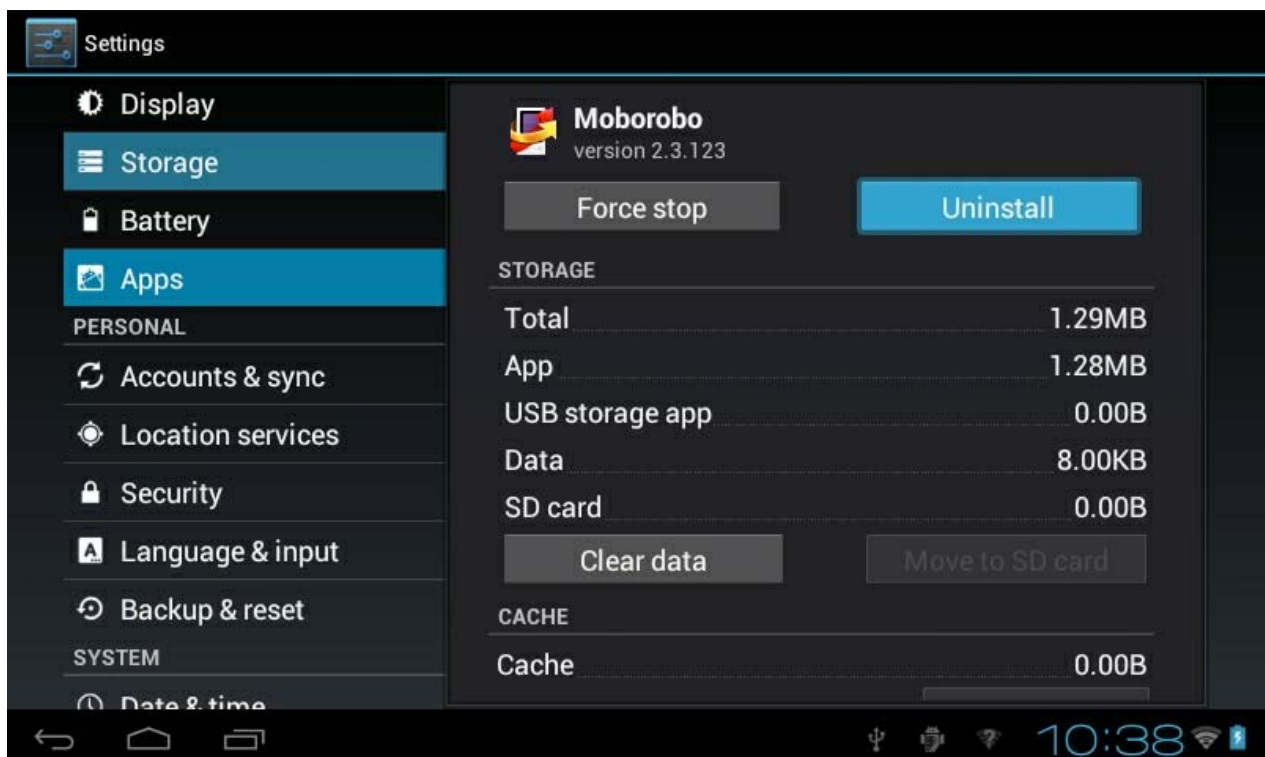





## Camera

This device has a built-in 0.3MPIXEL front camera and a built-in 2.0MPIXEL rear camera for photo, video and web cam.

From desktop, Tap  to enter application menu and tap  to enter camera mode.

Tap  to switch between front camera and rear camera.

Tap  to enter photo mode or tap  to enter video mode.  
Slide  between  and  to zoom in and out.

Taking a photo:

In photo mode, tap  to take a photo.

Tap  to enter a sub-menu.

 - White balance: select among Auto, Incandescent, Daylight, Fluorescent, Cloudy



 - Exposure: set exposure between +4 to -4

 - Exit sub-menu

 - Camera settings: set store location, picture size, picture quality and restore defaults

You can find the photo files from Application menu → File Manger → DCIM → Camera

Taking a video:

In video mode, tap  to start the video recording and tap  to stop.

Tap  to enter a sub-menu.

 - White balance: select among Auto, Incandescent, Daylight, Fluorescent, Cloudy

 - Time lapse interval: set time lapse interval between 1 second and 10 seconds or off.

 - Exit sub-menu

 - Camera settings: Set store location and restore defaults

You can find the video files from Application menu → File Manger → DCIM → Camera



Here shows the preview of previous taken photo or video.

hone for voice recording and web cam.

er application menu and tap



to

Tap  to start recording.

Tap  to stop recording.

Tap  to review the section just recorded.

To save the recording, tap "DONE" and exit to Application menu or;

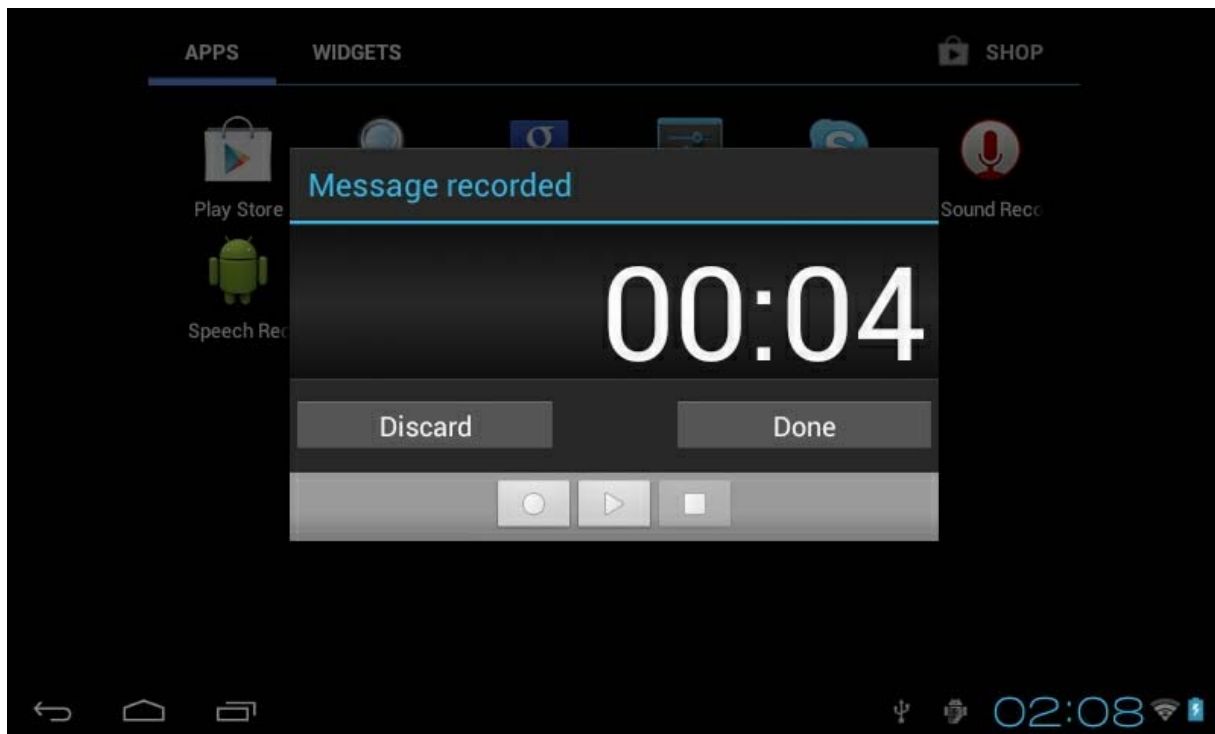

Tap "Discard" to erase the recording and exit to Application menu

You can find the saved file from Application menu → File Manger.



Use the device a multi media player

Audio playback:

From desktop, tap  to enter Application menu. Tap  to enter audio playback mode.

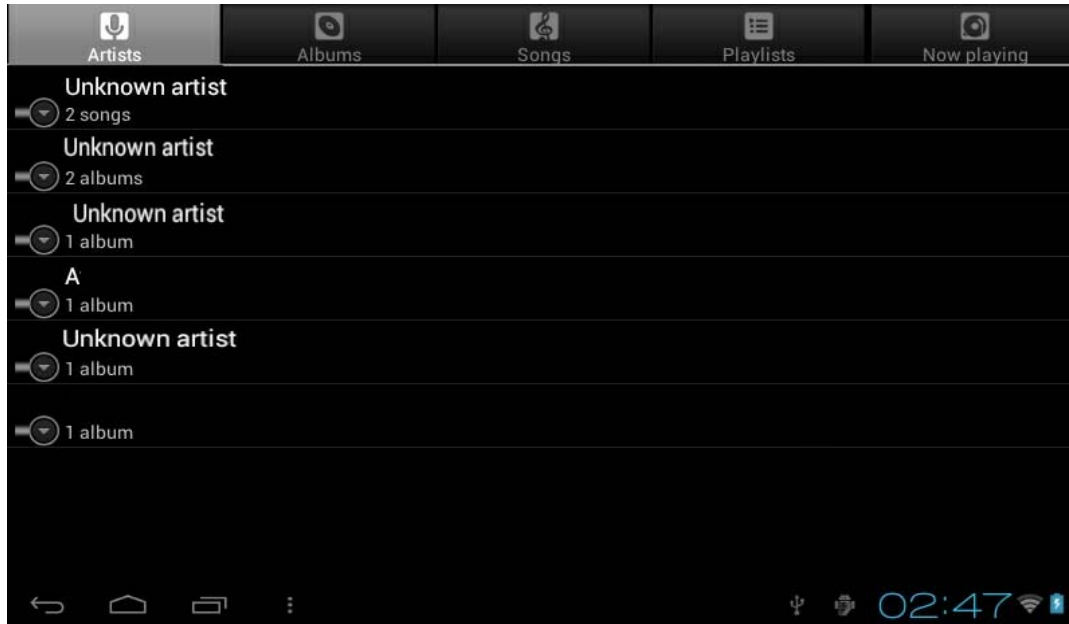

Only music files stored in the device will be shown in the file list. You can classify the music file list by: ARTISTS, ALBUMS, SONGS, PLAYLISTS and NOW PLAYING by selecting the appropriate option.

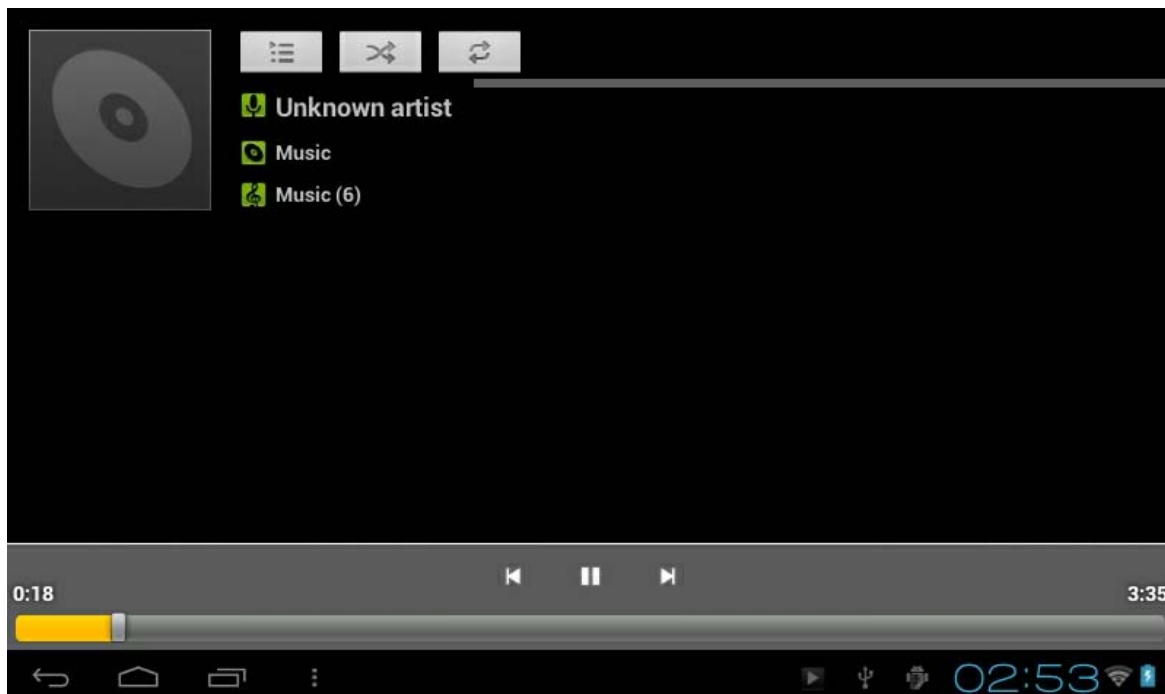

Tap a song to start playback. On playback interface, you can tap on the function bar to adjust the playback time, backward/previous, forward/next, play, pause, shuffle, repeat setting, etc.



Video playback:

From desktop, tap  to enter Application menu. Tap  to enter video / photo mode.

Only videos files, photo files stored in the device and videos/photos taken from the built-in camera will be shown in the file list.

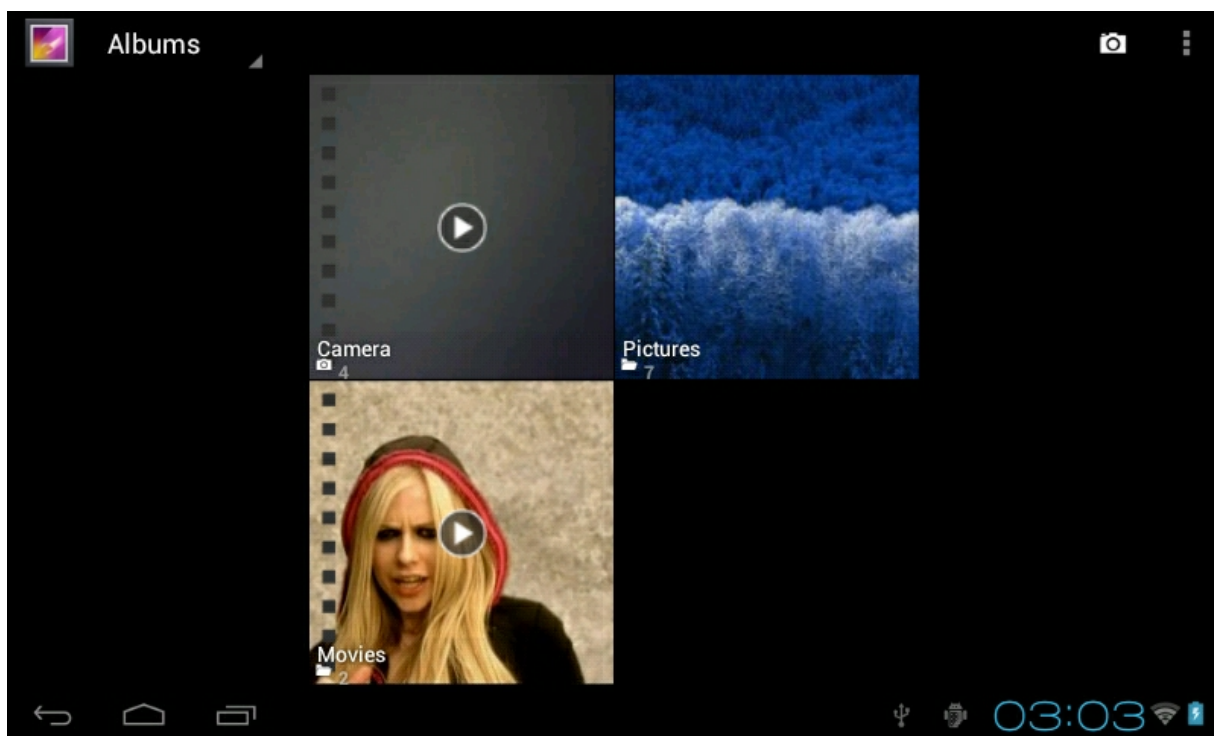

Tap on "MOVIES" to enter a list of preview videos. Tap any video file to enter the playback screen and tap on the play icon to start playback.









You can adjust the playback time by sliding the time bar, or adjust the volume by tapping  or . Tap    for previous, play, next. Tap  to go to the previous screen. Tap  to enter the sub-menu for subtitles, audio and screen ratio settings for the videos or movies.

Photo browsing:

From desktop, tap  to enter Application menu. Tap  to enter video / photo mode.



Only videos files, photo files stored in the device and videos/photos taken from the built-in camera will be shown in the file list.

Tap on "PICTURES" to enter a thumbnail of photos.

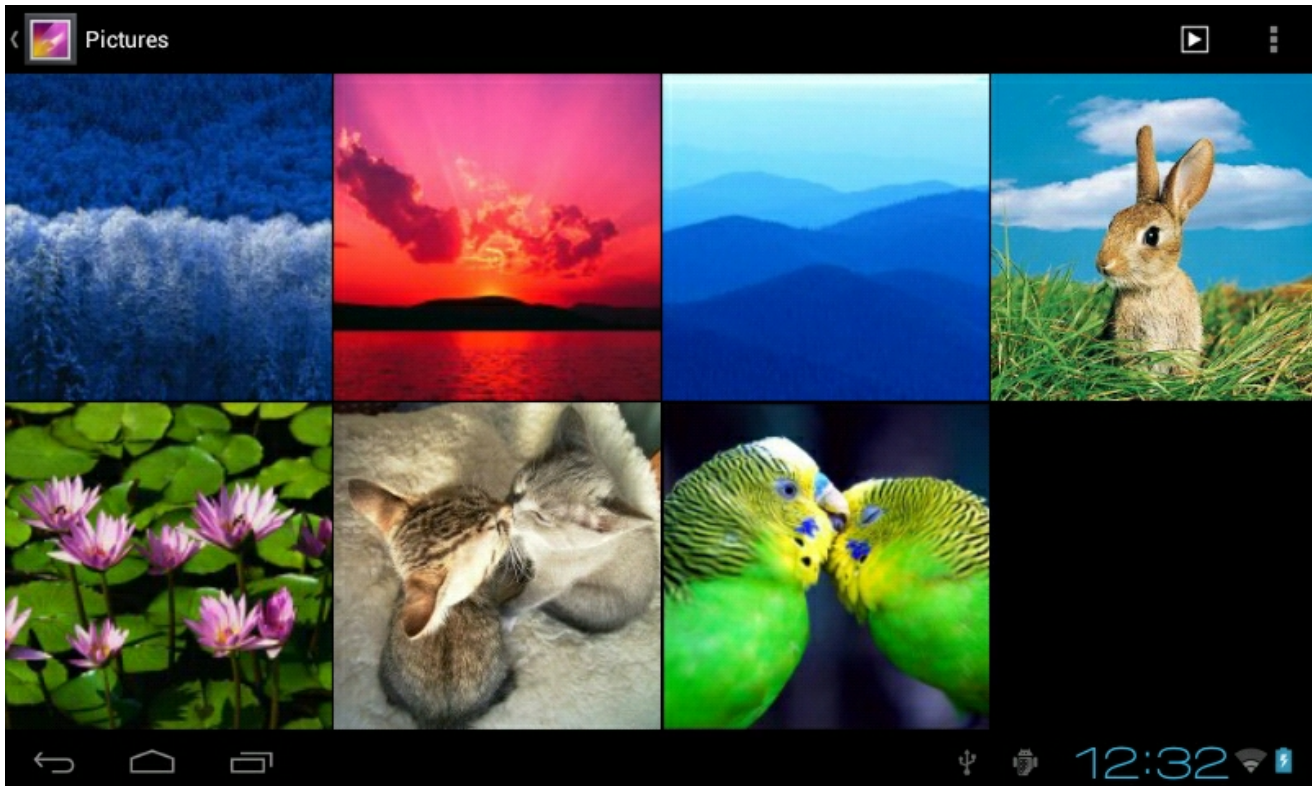

- Press on the thumbnail of a photo to access a full-sized version.
- Get a closer look at a photo by double tapping the screen. Two taps will magnify the image. Another two taps will return to the original view.
- A tap on the screen, a thumbnail of photos will appear and you can tap on any photo to move from one photo to another.
- Enlarge an image by touching the image with two fingers and spreading them toward the edges of the screen. Pinch the image back to original size by bringing your index finger and thumb together.
- See an image in widescreen perspective by turning the device on its side. The device automatically rotates a photo as you move the device and spreads the edges to comply with the view screen's orientation (this







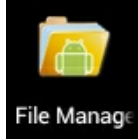

function is only valid after Auto-rotate screen is activated from Setting → Display → Auto-rotate screen).

## File Management

From desktop, Tap  to enter application menu and tap  to view a list of files in the device.

Tap on the icon on the top screen: to view a list of folders and files by category:

-  to view a list of folders and files from device
-  to view a list of folders and files micro SD card
-  to view a list of folders and files from external USB storage
-  to view all photo files
-  to view all video files
-  to view a list of installed application
-  to Paste, Delete, Copy or Move a file

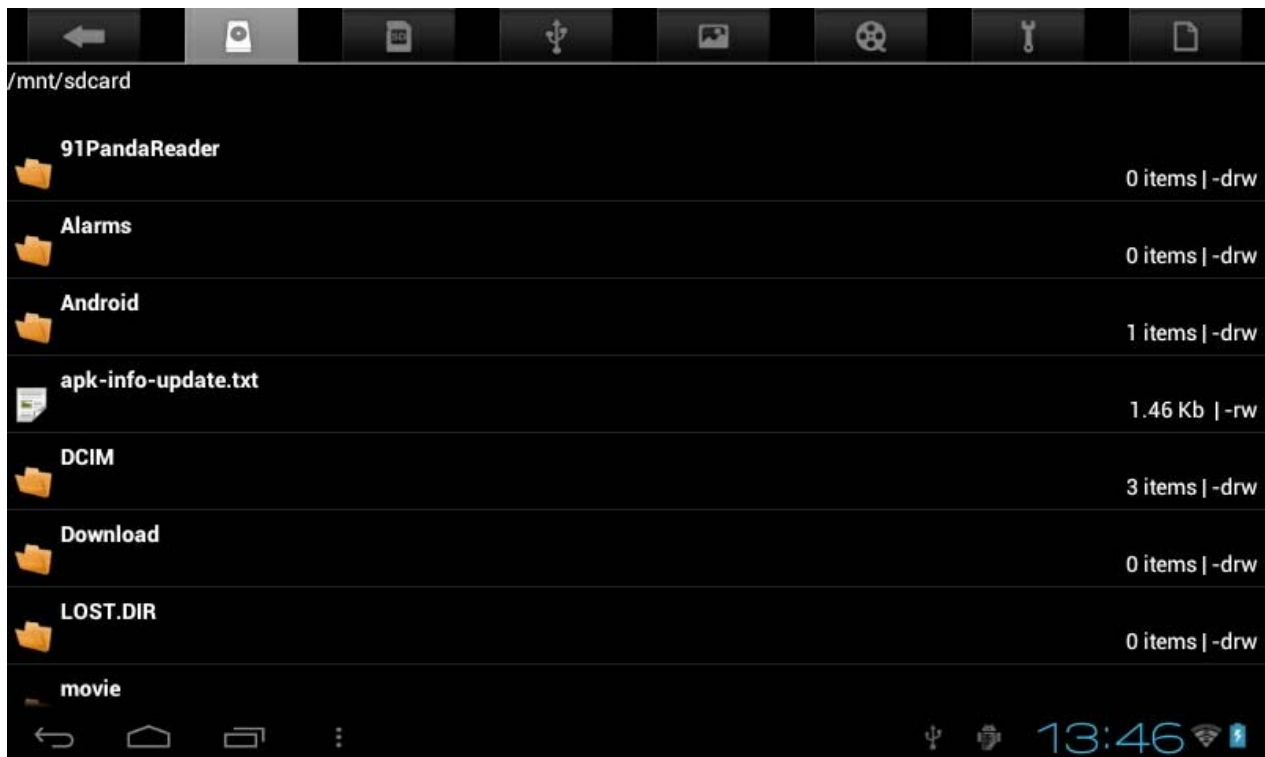

You can also delete, rename, copy, move or email a file by pressing on the file for 1 second, a pop up menu will appears:

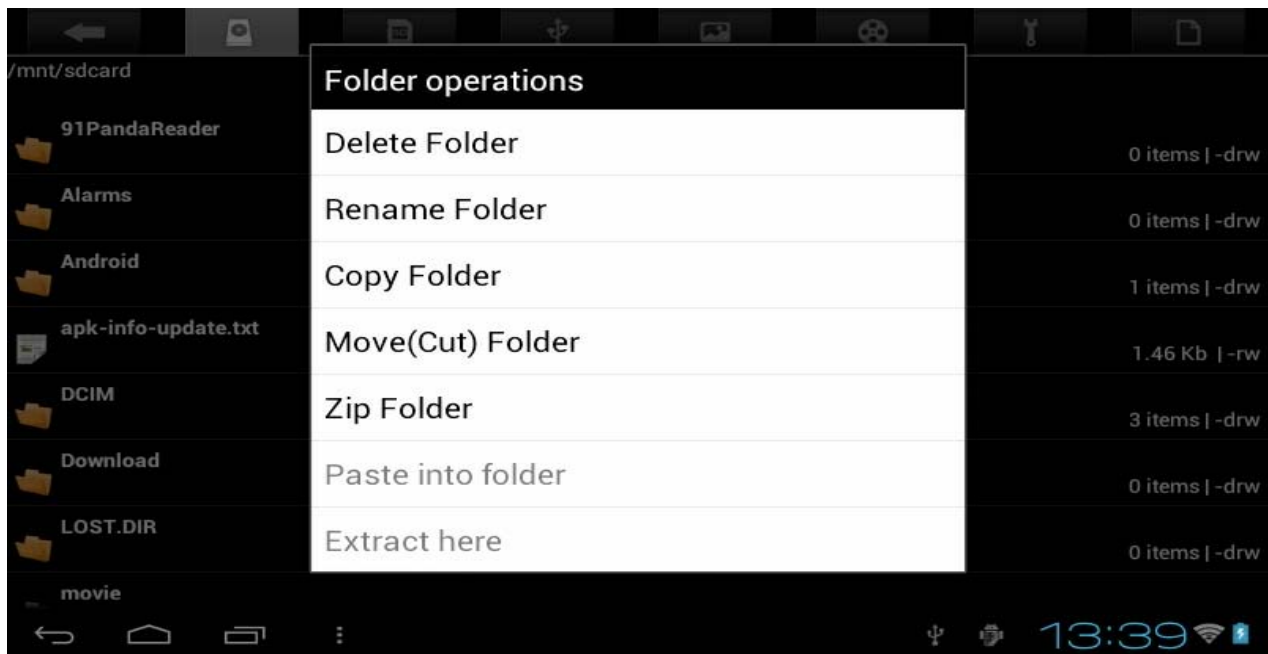

### Set OSD Language

You can set the display language of the device from the list of available language provided in the device.

Go to desktop → Setting → Language & Input → Language & input

Tap on "Language" to enter a list of OSD language options and tap on the desired language and it will be set instantly.



## Set Keyboard

You can select a keyboard input method from Setting.

Go to desktop → Setting → Language & Input → Language & input

Select from the list of Keyboard & Input methods.

Any keyboard input method APKS installed in the device can be also find from this list of Keyboard & Input methods.

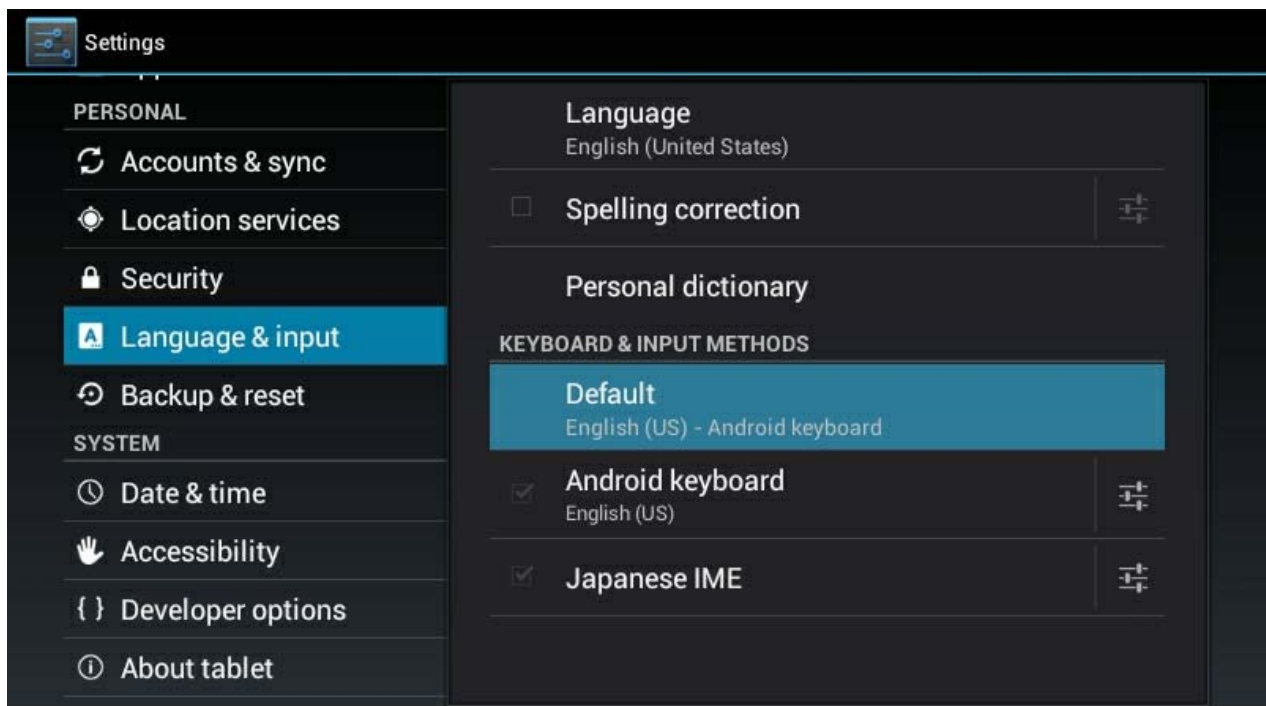

Tap on  to enter Android keyboard settings menu:

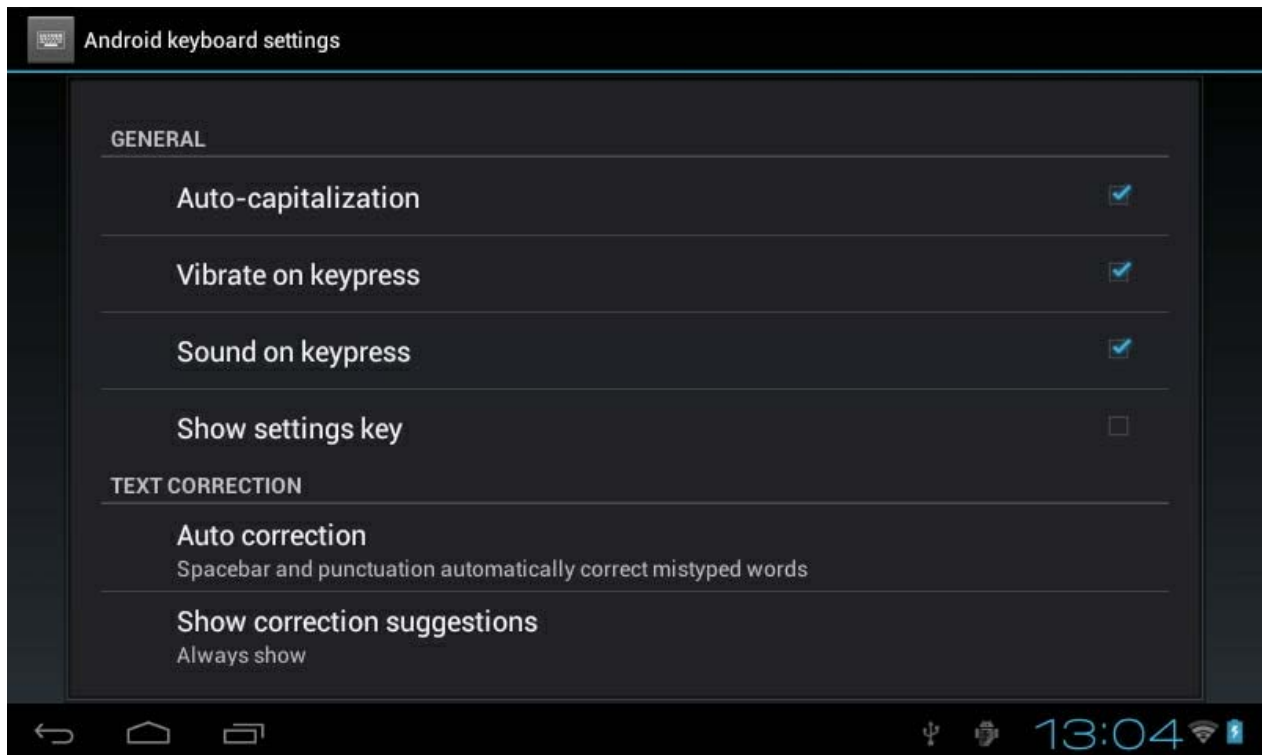

From the Android keyboard settings menu, you can setup:

- Auto-capitalization
- Vibrate on keypress (not available in this device)
- Sound on keypress
- Show settings key
- Auto correction
- Show correction suggestions
- Advance settings for the above features

## Set Date and Time

You can set system date and time from Setting.

Go to desktop → Setting → Date & time

You can setup Automatic date & time, Automatic time zone, Set date, Set time, Select time zone, Use 24-hour format, and Select date format.

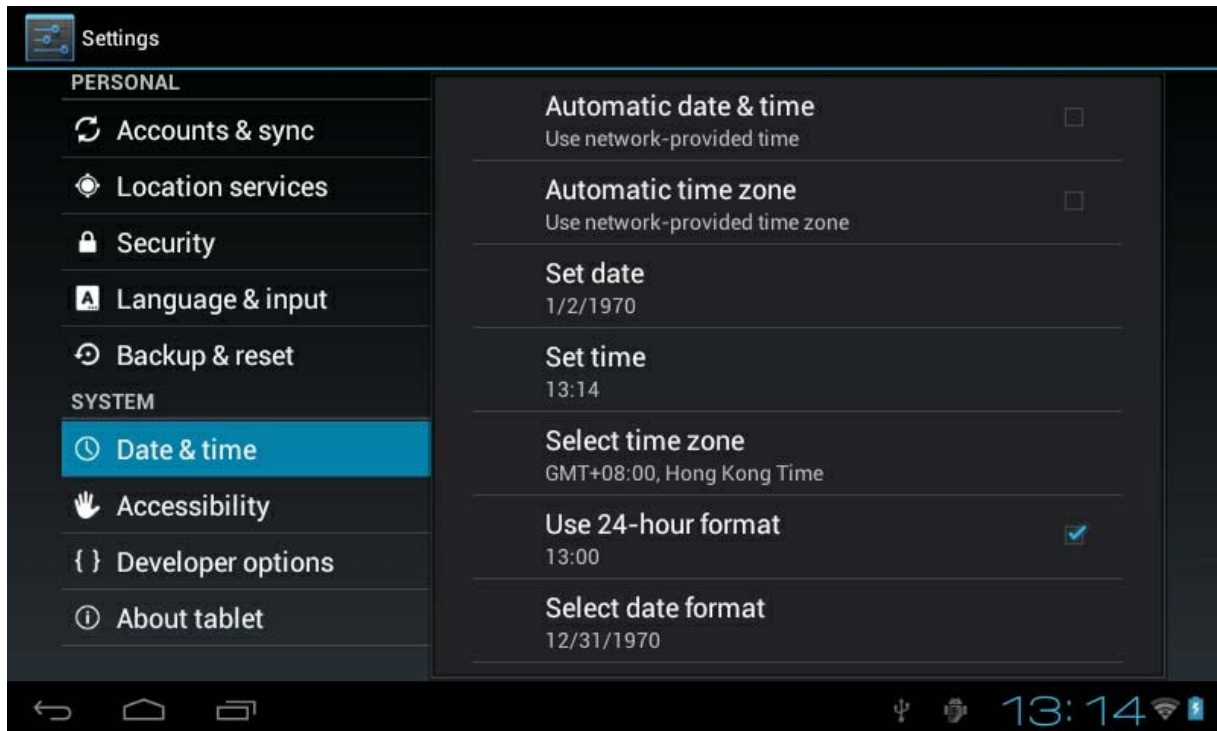

## About the Device

You can get a quick view on the device status such as firmware version, battery consumption status, battery level, model no., Android OS version, Network, Signal strength, etc from:

Setting → About tablet

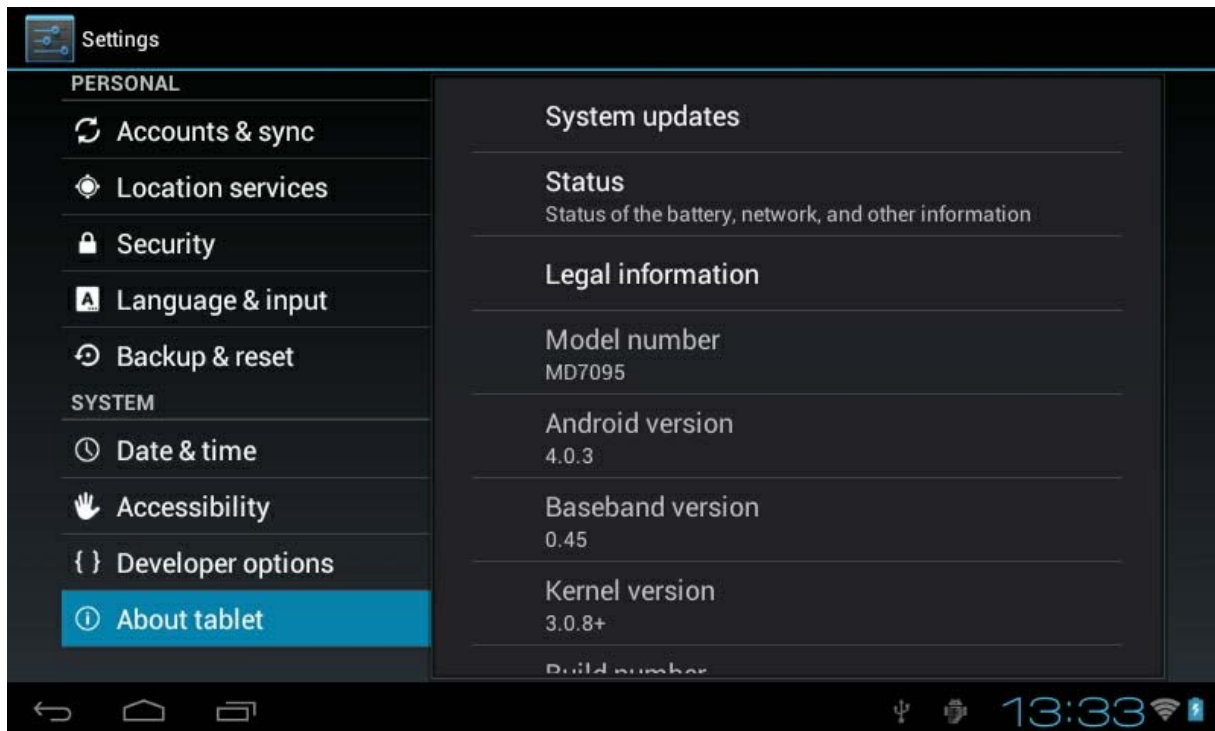

## Troubleshooting

Can not turn on the device?

- You may not be able to turn on the device when the battery is below the critical level. Recharge the battery for a few minutes and try to turn it on again.
- Check if the power charger is connected properly and firmly.

The battery working time is too short?

- The duration of the lithium battery varies with environmental temperature changes and the service conditions. If the environment temperature is too low or too high, the duration of the battery will be affected. It is recommended to use this device at normal temperature.
- Battery consumption varies depending on if the brightness and on time of the screen, the volume level of the loudspeaker as well as the operation status of the central processor (CPU). To save battery, please refer to Power saving mode section of this menu.

No sound from earphone?

- Check if the volume setting is adjusted to 0.
- Check whether the audio file is damaged and try to play other audio files to confirm. In the case if the audio file is damaged, it may cause severe noise or staccato.

Can not copy files?

- Check if the device is connected to the computer properly.
- Check if the USB cable is working.
- Check whether the memory capacity available is enough for storage of the copying files.



## **FCC Statement:**

This equipment has been tested and found to comply with the limits for a Class B digital device, pursuant to Part 15 of the FCC Rules. These limits are designed to provide reasonable protection against harmful interference in a residential installation. This equipment generates uses and can radiate radio frequency energy and, if not installed and used in accordance with the instructions, may cause harmful interference to radio communications. However, there is no guarantee that interference will not occur in a particular installation. If this equipment does cause harmful interference to radio or television reception, which can be determined by turning the equipment off and on, the user is encouraged to try to correct the interference by one or more of the following measures:

- Reorient or relocate the receiving antenna.
- Increase the separation between the equipment and receiver.
- Connect the equipment into an outlet on a circuit different from that to which the receiver is connected.
- Consult the dealer or an experienced radio/TV technician for help.

This device complies with part 15 of the FCC Rules. Operation is subject to the following two conditions:

(1) This device may not cause harmful interference, and (2) this device must accept any interference received, including interference that may cause undesired operation.

Changes or modifications not expressly approved by the party responsible for compliance could void the user's authority to operate the equipment.



Specifications are subject to change without prior notice.

No part of this document may be reproduced or transmitted in any form or by any mean including photocopying and recording or translating to another languages for any purposes without the prior written consent of the manufacturer.

All brand names, logos and registered trademarks mentioned are property of their respective owners.

All rights reserved.