

AGRAS MG-1S

User Manual

V1.0 2017.01

Contents

| | |
|---|----|
| Overview | 3 |
| Aircraft | 3 |
| Remote Controller | 4 |
| Remote Controller | 5 |
| Using the Remote Controller | 5 |
| Remote Controller LEDs | 7 |
| Aircraft | 9 |
| Flight Modes | 9 |
| Operation Modes..... | 9 |
| Terrain Follow System..... | 13 |
| System Data Protection | 15 |
| Manual Obstacle Avoidance..... | 15 |
| Empty Tank Warning | 17 |
| Flight | 18 |
| Starting and Stopping the Motors | 18 |
| Appendix..... | 19 |
| Specifications..... | 19 |
| Aircraft Status Indicator Description | 21 |

Overview

Aircraft

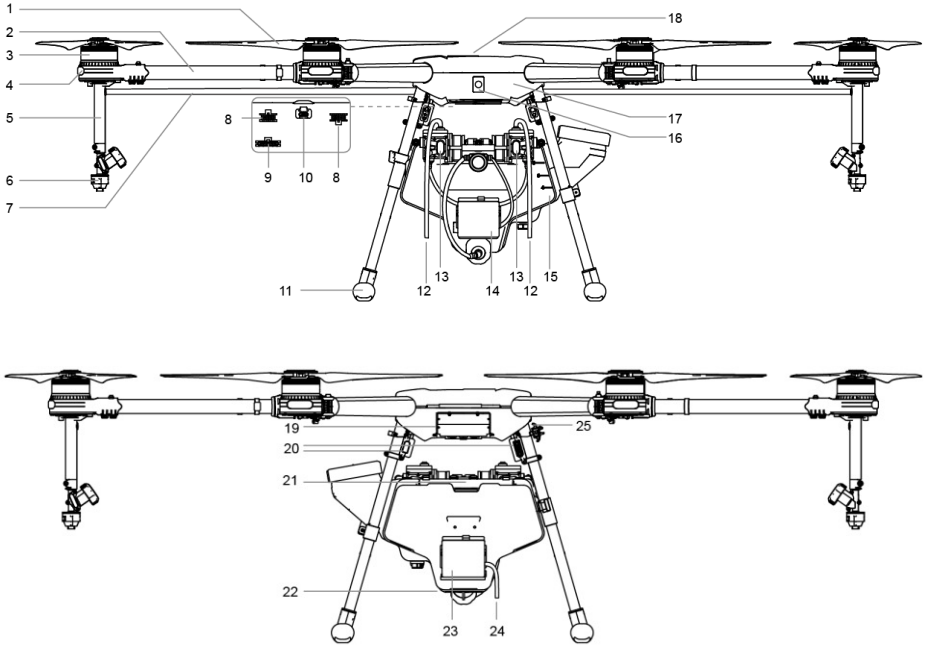

- 1 Propellers
- 2 Frame Arms
- 3 Motors
- 4 Orientation LEDs
- 5 Sprinklers
- 6 Nozzles
- 7 Hoses
- 8 Pump Motor Port
- 9 Radar Port
- 10 Micro USB Port
- 11 Landing Gear
- 12 Pump Motor Cable
- 13 Delivery Pump
- 14 Rear Radar Module (Terrain Follow System)
- 15 Spray Tank
- 16 Aircraft Status Indicator (Aircraft's Rear)
- 17 Aircraft Body
- 18 GPS Module
- 19 Intake Vent (Aircraft's Front)
- 20 Power Ports
- 21 Battery Compartment
- 22 Downward Radar Module (Terrain Follow System)
- 23 Forward Radar Module (Terrain Follow System)
- 24 Radar Cable
- 25 Remote Controller Holder

Remote Controller

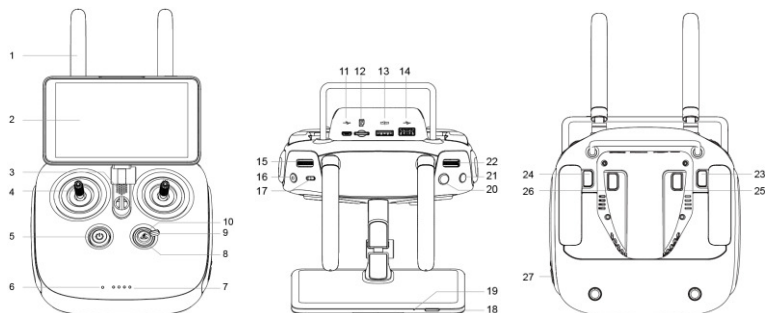

1 Antennas

Relays the aircraft control signals.

2 Display Device

With Android system to run DJI MG-1S app.

3 Speaker

Audio output.

4 Control Sticks

Controls the aircraft movement. Can be set to Mode 1 or Mode 2, or to a custom mode.

5 Power Button

Used to turn the remote controller on and off.

6 Status LED

Indicates whether the remote controller is linked to the aircraft.

7 Battery Level LEDs

Display the current battery level.

8 RTH Status LED

Circular LED around the RTH button which displays the RTH status.

9 Operation Mode Switch

Used to switch between Smart, Manual and Manual Plus Operation Mode.

10 RTH Button

Press and hold this button to initiate Return-to-Home (RTH).

11 Micro USB Port

Reserved.

12 Micro SD Card Slot

Provide extra storage space for the display device, maximum supporting 128 GB.

13 CAN Port

Used to connect other accessories, such as a GPS module.

14 USB Port

USB device support.

15 Spray Rate Dial

In Manual Operation Mode, turn the dial to adjust the spray rate.

16 Spray Button

In Manual Operation Mode, press to start/stop spraying.

17 Flight Mode Switch

Used to switch between P-mode (Positioning), A-mode (Attitude) and M-mode (Manual).

18 Sleep/Wake Button

Press to sleep/wake the screen, press and hold to restart.

19 Microphone

Reserved.

20 Button A

Records Point A of the operation route.

21 Button B

Records Point B of the operation route.

22 Flying Speed Dial

In Smart Operation Mode, turn and press the dial to adjust the flying speed.

23 Button C1

Press to choose operation route L for Smart Operation Mode.

In Manual Plus Operation Mode, press to fly the aircraft left for one operation gap.

24 Button C2

Press to choose operation route R for Smart Operation Mode.

In Manual Plus Operation Mode, press to fly the aircraft right for one operation gap.

25 Button C3

In Manual Operation Mode, press to use only the front two sprinklers.

26 Button C4

In Manual Operation Mode, press to use only the rear two sprinklers.

27 Power Port

Connects to a power source to charge the remote controller's internal battery.

Remote Controller

Using the Remote Controller

Turning the Remote Controller On and Off

The remote controller is powered by a 2S rechargeable battery that has a capacity of 6000 mAh. The battery level is indicated via the Battery Level LEDs on the front panel. Follow the steps below to turn on your remote controller:

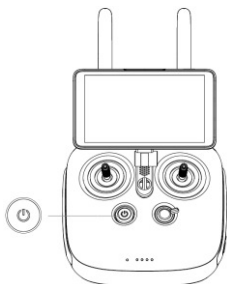





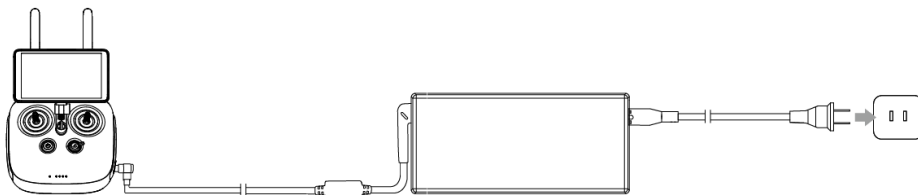

1. When the remote controller is turned off, press the Power Button once. The Battery Level LEDs will display the current battery level. Charge the battery if the battery level is low.
2. Press the Power Button once. Then press again and hold the Power Button to turn on the remote controller.
3. The remote controller will beep when it is turned on. The Status LED will rapidly blink green, indicating that the remote controller is linking to the aircraft. The Status LEDs will glow solid green when linking is complete.
4. Repeat Step 2 to turn off the remote controller.

Charging the Remote Controller

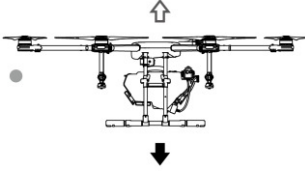
Charge the remote controller using the included charger. Refer to the figure below for more details.

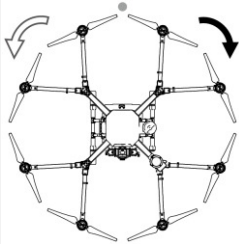

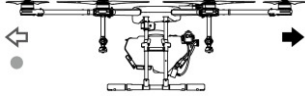
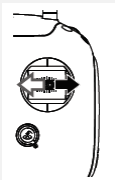

Controlling the Aircraft

| Remote Controller (Mode 2) | Aircraft (● Indicates Nose Direction) | Remarks |
|---|---|---|
|  |  | <p>Throttle Stick: Vertical movement of the left stick controls the aircraft's elevation. Push up to ascend and press down to descend. Use the left stick to take off when the motors are spinning at idle speed. The aircraft will hover in place if the stick is in the central position.</p> <p>The more the stick is pushed away from the central position, the faster the aircraft will change elevation.</p> |
|  |  | <p>Yaw Stick: Horizontal movement of the left stick controls the aircraft's heading. Move left to rotate the aircraft anticlockwise and move right to rotate the aircraft clockwise. The aircraft will hover in place if the stick is in the central position.</p> <p>The more the stick is pushed away from the central position, the faster the aircraft will rotate.</p> |
|  |  | <p>Pitch Stick: Vertical movement of the right stick controls the aircraft's pitch. Push up to fly forwards and press down to fly backwards. The aircraft will hover in place if the stick is in the central position.</p> <p>Move the stick further for a larger pitch angle and faster flight.</p> |
|  |  | <p>Roll Stick: Horizontal movement of the right stick controls the aircraft's roll. Move the stick left to fly left and right to fly right.</p> <p>The aircraft will hover in place if the stick is in the central position.</p> <p>Move the stick further for a larger roll angle and faster flight.</p> |

Flight Mode Switch

Toggle the Flight Mode Switch on the remote controller to one of the three modes.

| Figure | Flight Mode |
|---|----------------------|
|  P | P-mode (Positioning) |
|  A | A-mode (Attitude) |
|  F | F-mode (Function) |

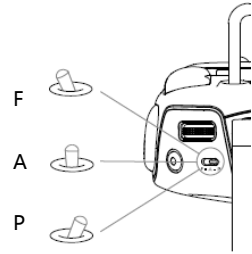

P-mode (Positioning): The aircraft uses GPS for positioning. In P-mode, when the GPS signal is strong, users can start the motors.

A-mode (Attitude): GPS is NOT used for positioning and aircraft can only maintain altitude using the barometer. Aircraft can still record its position and return to the Home Point if a GPS signal is present.

F-mode (Function): Users can plan operation mission in the DJI MG-1S app and then the aircraft will operate automatically.

Operation Mode Switch

Toggle the Operation Mode Switch on the remote controller to one of the three modes.



S

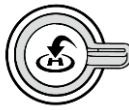

M



M+

Smart Operation Mode (S) Manual Operation Mode (M) Manual Plus Operation Mode (M+)

1. **Smart Operation Mode:** When the aircraft is in P-mode and the GPS signal is strong, toggle the switch to this mode after Points A and B are recorded. The aircraft will fly and spray liquid along the specified route.

2. **Manual Operation Mode:** In Manual Operation Mode, users can control all the movements of the aircraft and spray liquid via the Spray Button and Button C3 and C4.

3. **Manual Plus Operation Mode:** In Manual Plus Operation Mode, the flying speed is restricted and the aircraft's heading is locked. Users can control the movement of the aircraft except for the heading. Press Button C1 or C2 and the aircraft will fly one operation width to the left or right.

Remote Controller LEDs

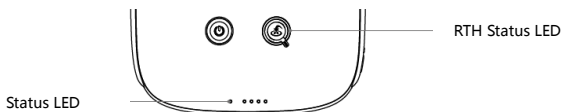

The Status LED indicates the connection status between the remote controller and the aircraft. The RTH Status LED indicates the Return-to-Home status of the aircraft. See the table below for details on these indicators.

| Status LED | Sound | Remote Controller Status |
|-----------------------|---|---|
| Solid Red | | The remote controller is not connected to the aircraft. |
| Solid Green | | The remote controller is connected to the aircraft. |
| Blinks Red | 1 slow beep repeating | Remote controller error. |
| RTH Status LED | Sound | Aircraft Status |
| Solid White |  chime | Return-to-Home procedure is initiated. |
| Blinks White | 1 beep repeating | Sending Return-to-Home command to the aircraft. |
| Blinks White | 2 beeps repeating | The aircraft is returning to the Home Point. |

Aircraft

Flight Modes

The MG-1S provides P-mode, A-mode and F-mode. Switch to one of the three modes via the Flight Mode Switch on the remote controller.

P-mode (Positioning)

The aircraft uses GPS for positioning. In P-mode, toggle the Operation Mode Switch to select from the three operation modes. When the GPS signal is strong, users can start the motors.

A-mode (Attitude)

GPS is NOT used for positioning and aircraft can only maintain altitude using the barometer. Aircraft can still record its position and return to the Home Point if a GPS signal is present.

F-mode (Function)

Enter Course Plan Mode to plan operation mission in the DJI MG-1S app and then the aircraft will operate automatically.

Operation Modes

The MG-1S provides Smart Operation Mode, Manual Operation Mode and Manual Plus Operation Mode. Switch to one of the three modes via the Operation Mode Switch on the remote controller.

Smart Operation Mode

In Smart Operation Mode, the aircraft will travel along a pre-planned route. Operation resumption, data protection, and terrain follow system are available in this mode. Use the Flying Speed Dial on the remote controller to adjust flying speed, spray rates will automatically adjust accordingly. Smart Operation Mode is recommended for large, rectangular spray areas.

Operation Route

The aircraft will travel along pre-designated square zig zag route after the turning points A and B have been recorded. The altitude difference between the aircraft and vegetation is maintained under optimal working conditions. The aircraft will spray liquid automatically while flying along the route and stop spraying liquid while hovering at the turning points. The length of the dotted lines, which are called Operation Gaps, can be adjusted in the app.

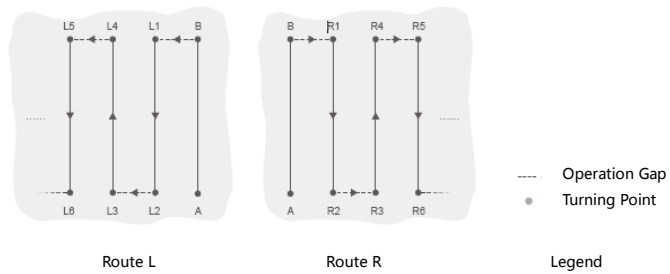

Operation Procedure

| | |
|--|--|
| | <p>Maintain line of sight of the aircraft at all times.</p> <p>Ensure that the Flight Mode Switch is toggled to the “P” position and the GPS signal is strong. Otherwise, Smart Operation may be unreliable.</p> |
| | <p>Always inspect operating environments before flying.</p> |

Ensure that Flight Mode Switch on the remote controller is toggled to the “P” position and a strong GPS signal is present. In addition, ensure that the Operation Mode Switch on the remote controller is toggled to the “M” position.

1. Record Points A and B in Order

Users cannot toggle the Operation Mode Switch to Smart Operation Mode unless points A and B are recorded.

Fly the aircraft to the starting point, depicted as Point A (B), hover, and then press Button A (B) on the remote controller. The Aircraft Status Indicator will blink red (green) after the starting points have been recorded.

| | |
|--|---|
| | <p>Points A and B cannot be recorded if the spray tank is empty.</p> <p>Update Point B by flying the aircraft to a new position and record this position. Note that if a Point A has been updated, then Point B is also required to be updated accordingly.</p> <p>It' s recommended to keep the direction of Point A to B parallel to one side of the rectangular spray area for optimal effect.</p> |
|--|---|

2. Select the Route

Press Button C1 or Button C2 on the remote controller to select the operating pattern. Press Button C1 for Route L and Button C2 for Route R. The default route pattern is Route R, if no selection has been made.

| | |
|--|--|
| | <p>The route can be selected only in Manual Operation Mode. If the aircraft is in Smart Operation Mode, select the route after switching to Manual Operation Mode.</p> |
|--|--|

3. Configure the Aircraft Altitude

Configure the desired altitude in the app and adjust the aircraft altitude to a value within the working range of the Terrain Follow System (1.5 - 4.5 m) by using the throttle stick before entering Smart Operation Mode, and the Terrain Follow System will start working automatically and maintain the spraying distance between the aircraft and the vegetation. Refer to Terrain Follow System for details.

4. Using Smart Operation Mode

Ensure that the Flight Mode Switch on the remote controller is toggled to the “P” position and a strong GPS signal is present, then toggle the Operation Mode Switch to the “S” position to enable Smart Operation Mode. The aircraft will align with the line between Point A and Point B with its heading pointing toward Point B.





| | |
|---|---|
|  | <p>Aircraft nose will always point from Point A to Point B regardless of the flight direction. Heading cannot be adjusted.</p> <p>In Smart Operation Mode, if using the control sticks to control the aircraft flying forward, backward, left or right, the aircraft will switch to Manual Operation Mode automatically, complete corresponding flight behavior and then hover. Toggle the Operation Mode Switch back-and-forth to “S” position, and the aircraft will be back to Smart Operation Mode then fly back to the operation route. Refer to Manual Obstacle Avoidance for details.</p> <p>Flying speed, altitude, spray rate and other parameters can be adjusted in the app.</p> |
|---|---|

5. Starting the Operation

- a. Press the Button C1 and Button C2 on the remote controller simultaneously to have the aircraft traverse from Point B to L1 (R1). The aircraft will then hover at Point L1 (R1) and wait for further commands.
- b. Repeat ‘a’ and the aircraft will fly to the next turning point along Route L (R) and hover.
- c. Enable Continuous Smart Operation Mode by pressing and holding the Button C1 and Button C2 on the remote controller for 2 to 4 seconds when the aircraft is hovering at any given turning point. The Aircraft Status Indicator will turn solid purple for one second. The aircraft will then fly along Route L (R) continuously.
- d. To exit Continuous Smart Operation Mode, press the Button C1 and Button C2 and hold for 2

to 4 seconds. The aircraft will fly to the next turning point and hover.

| | |
|---|--|
|  | <p>You will only be able to press and hold the C1 and C2 buttons for steps 'a' to 'c' when the aircraft is hovering at a turning point.</p> <p>If the GPS signal is weak during operation, the aircraft will switch to Attitude Flight Mode automatically. Exit Smart Operation Mode and control the aircraft manually. When the MG-1S regains GPS signal, it will fly to the next turning point automatically. If you press Button A or Button B during operation, data for Point A and B of the current route will be erased and the aircraft will hover in place.</p> |
|  | <p>The Operation Gap is set to 5m by default. Customize it from 3m to 10m in the app. Use the control sticks to control the aircraft to avoid obstacles when it is in operation, even though the heading of the aircraft cannot be adjusted. Refer to Manual Obstacle Avoidance for details.</p> <p>The aircraft sprays liquid automatically when flying, and does not spray when hovering.</p> |

Manual Operation Mode

Toggle the Operation Mode Switch to enter Manual Operation Mode. You can control all the movements of the aircraft, spray liquid via the spray button on the remote controller, and adjust the spray rate via the dial on the remote controller. Manual Operation Mode is ideal when the operating area is small.

Manual Plus Operation Mode

Toggle the Operation Mode Switch to enter Manual Plus Operation Mode. The maximum flying speed is 8 m/s and the aircraft's heading is locked in Manual Plus Operation Mode. Press the Button C1 or Button C2 on the remote controller to steer the aircraft to fly to the left or right. The aircraft sprays liquid automatically when flying forward and backward, and does not spray when flying left and right or hovering. Manual Plus Operation is ideal for irregularly shaped operating areas.

1. Elevate the aircraft to a desired altitude within the working range of the Terrain Follow System (1.5 - 4.5 m) before entering Manual Plus Operation Mode. The Terrain Follow System starts working automatically by maintaining the spraying distance between the aircraft and the vegetation below. Refer to Terrain Follow System for details.
2. Ensure that the aircraft is in P-mode and ensure that GPS signal is strong. Then toggle the Operation Mode Switch to the "M+" position to activate Manual Plus Operation Mode.

Terrain Follow System

Profile

The Terrain Follow System is consist of forward, rear and downward radar modules and uses microwave technology for terrain following. Under optimal operating environment, the system can predict the distance between the aircraft and the crops or other surfaces in forward, rear and downward directions, so that the aircraft can fly at a constant spraying distance from them to ensure even spraying. The radar module is enabled by default, and can be disabled in the app. If it is enabled, the aircraft will fly above the crops at a constant spraying distance in Smart Operation Mode and Manual Plus Operation Mode and F-mode. The system can also measure the spraying distance above the crops or other surfaces, but the aircraft will not be able to fly at a constant spraying distance when performing this function in Manual Operation Mode.

How to Use

1. Ensure that the Terrain Follow System is enabled in the app.
2. Configure the desired spraying distance (between 1.5 and 4.5 m) in the app.
3. If using Smart Operation Mode or Manual Plus Operation Mode, ensure that the Flight Mode Switch is toggled to "P" position and the Operation Mode Switch is toggled to "M" position. If using F-mode, ensure that the Flight Mode Switch is toggled to "F" position. Fly the aircraft above the vegetation and adjust the distance between the aircraft and the vegetation to a value within the working range (1.5 - 4.5 m).
4. Toggle the Flight Mode Switch and Operation Mode Switch to the desired position to enter the corresponding mode. If operating environment is ideal, the aircraft will fly above the vegetation at the pre-set height.

| | |
|---|--|
|  | <p>The Altitude Stabilization System will only maintain a fixed distance from vegetation within its working range (1.5 - 4.5 m).</p> <p>Observe the aircraft' s distance from the vegetation at all times.</p> <p>Operate with extra caution when flying over inclined surface.</p> <p>Obey local radio transmission laws and regulations.</p> |
|---|--|

Radar Status Display

The Radar Status Indicator shows the current status of the Terrain Follow System. See the table below:

| Blinking Pattern | Description |
|--|-------------|
| Solid (Forward Radar: Blue, Rear Radar: Green, | Warming up. |

| | |
|--|---------------|
| Downward Radar: Yellow) | |
| Blinking (Forward Radar: Blue, Rear Radar: Green, Downward Radar: Yellow) | Working. |
| Off | Disconnected. |

Operation Resumption

The operation resumption function allows you to temporarily pause an operation (e.g. to refill the spray, change the battery, etc.) and then resume operation. Exit Smart Operation Mode or Course Plan Mode through one of the following methods and the aircraft will record its location as a stopping point if the GPS signal is strong enough.

1. Toggle the Operation Mode Switch to exit Smart Operation Mode.
2. Toggle the Flight Mode Switch to exit P-mode or F-mode.
3. Move the Pitch Stick or Roll Stick on the remote controller.
4. Initialize the RTH procedure.

| | |
|---|---|
|  | <p>Ensure that the GPS signal is strong when using the operation resumption function. Otherwise, the aircraft cannot record and return to the stopping point.</p> <p>The stopping point will be updated as long as the Operation Mode Switch is toggled from Smart Operation Mode to any other mode, the Flight Mode Switch is toggled from P-mode or F-mode to any other mode, or RTH (Smart RTH, Failsafe RTH or Low Battery RTH) is triggered during Smart Operation Mode or Course Plan Mode.</p> |
|---|---|

Follow the instructions below to use this function:

1. Exit Smart Operation Mode or Course Plan Mode through one of the 4 methods above. The current location of the aircraft will be recorded as the stopping point.
2. Fly the aircraft to a safe location before resuming the operation. If the Terrain Follow System is enabled, adjust the spraying distance between the aircraft and the vegetation to be within the working range (1.5 – 4.5 m).
3. Back to the corresponding mode

Enter the corresponding mode as shown below and then follow the prompts in the app.

Smart Operation Mode:

- a. If the Flight Mode Switch is in “P” position, toggle the Operation Mode Switch to “S” position.
- b. If the Flight Mode Switch is in “A” or “F” position, the operation mode will be Manual Operation Mode by default after the Flight Mode Switch is toggled to “P” position. Users should

toggle the Operation Mode Switch back-and-forth to “S” position to enter Smart Operation Mode.

Course Plan Mode:

Toggle the Flight Mode Switch to the “F” position.

4. Return route

If the aircraft is in the operating area, there will be prompt in the app. Users can select from returning to the stopping point or returning to the operating route along a path vertical to the operating route. If the aircraft is out of the operating area, it will return to the stopping point directly and resume the operation.

5. Users can control the aircraft flying forward, backward, left and right, if obstacle avoidance is required during returning procedure. Refer to Manual Obstacle Avoidance for details.

System Data Protection

The System Data Protection feature enables the aircraft to retain vital system data (e.g. the positions of Point A, Point B and the stopping point) for about 1 minute after the aircraft is powered off. Retaining vital system data allows the aircraft to resume operation after a short, temporary pause. Follow the instructions below to use this feature:

1. Exit Smart Operation Mode or Course Plan Mode through any method. The current location of the aircraft will be recorded as the stopping point.
2. Land the aircraft and stop the motors.
3. System Data Protection is triggered automatically once the aircraft is powered off. The Aircraft Status Indicator will glow solid green to show that System Data Protection is successfully triggered.
4. Replace the battery within the 1 minute window
5. Restart the aircraft and enter Manual Operation Mode.
6. Ensure that the GPS signal is strong enough. Then start the motors.
7. Follow the instructions in Operation Resumption to resume the operation.



The system data can only be retained for 1 minute. DO NOT power off the aircraft for more than 1 minute if you want to resume operation because the system data will be lost.

Manual Obstacle Avoidance

In Smart Operation Mode, users can control the aircraft flying forward, backward, left and right to avoid obstacles on the operation route or when there are emergency cases (e.g. abnormal aircraft

behavior exists).

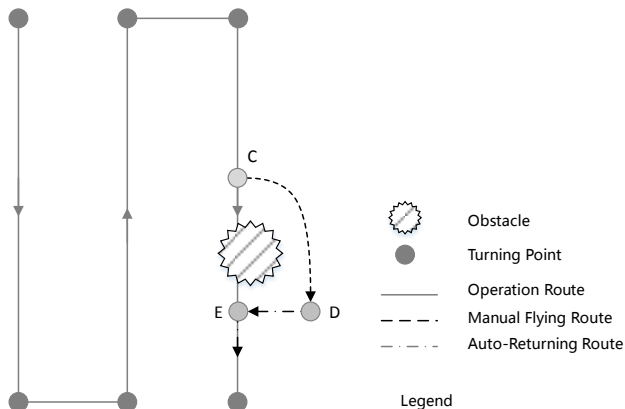

1. Exit Smart Operation Mode

In Smart Operation Mode, if using the control sticks to control the aircraft flying forward, backward, left or right (i.e. move the pitch or roll stick), the aircraft will switch to Manual Operation Mode automatically, record the current position as a stopping point, then complete corresponding flight behavior and hover.

| | |
|--|---|
| | When moving the control stick to exit Smart Operation Mode, the aircraft will have a braking distance. Ensure that there is a safe distance between the aircraft and the obstacles. |
|--|---|

2. Avoid the Obstacle

After switching to Manual Operation Mode, users can control the aircraft to avoid the obstacle from Point C to D.

3. Resume Operation

Toggle the Operation Mode Switch back-and-forth to “S” position. If the aircraft is in the operating area, there will be prompt in the app. Users can select from returning to the stopping point or returning to the operating route along a path vertical to the operating route. If the aircraft is out of the operating area, it will return to the stopping point directly and resume the operation.

| | |
|--|--|
| | Ensure that the aircraft has absolutely avoided the obstacle before operation resumption to avoid risk. After handling emergency cases, ensure that the aircraft is in normal status and then fly the aircraft manually to a safe area to resume operation. |
|--|--|

| | |
|--|---|
| | Step 1 to 3 can also be used to exit and resume operation if there is emergency case (e.g. obstacle avoidance is required) during returning procedure. |
|--|---|

Empty Tank Warning

Profile

When the spray tank is empty, there will be a prompt in the app and the aircraft will move depending on the operation mode - ascend 3 meters and hover (Smart Operation Mode or F-mode) or hover in place (Manual Operation Mode or Manual Plus Operation Mode).

How to Use

1. Press the Spray Button on the remote controller to turn off the sprinklers when the empty tank warning is triggered in Manual Operation Mode. Failure to do so may cause the idling of the pump of the motor and subsequently damage the parts. The sprinklers will automatically turn off in F-mode, Smart Operation Mode or Manual Plus Operation Mode when there is only 300ml liquid left in the spray tank.
2. Ensure the aircraft is in Manual Operation Mode, and then land the aircraft and stop the motors. Refill the liquid tank and tighten the lid.
3. Press the Spray Button on the remote controller to discharge the remaining air in the pump until the empty tank warning in the app disappears. Press the Spray Button again to stop discharging.
4. Ensure the aircraft is in Manual Operation Mode, and then take off.
5. Elevate the aircraft to a desired altitude in F-mode, Smart Operation Mode or Manual Plus Operation Mode. Adjust the spraying distance between the aircraft and the vegetation to be within the working range (1.5 - 4.5 m). Refer to the Terrain Follow System for details. Then toggle the Operation Mode Switch or Flight Mode Switch to enter the desired mode.

Flight

Starting and Stopping the Motors

Starting the Motors

The Combination Stick Command (CSC) listed below is used to start/stop the motors. Ensure you perform the CSC in one continuous motion. The motors will begin to speed at an idle speed. Release both sticks simultaneously. Take off immediately after the motors are spinning, or else the aircraft may lose balance, drift or even takeoff by itself and injure nearby people.

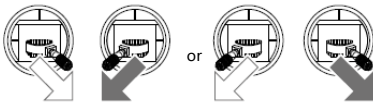

Stopping the Motors

There are two methods to stop the motors.

1. When the aircraft has landed, push the throttle down and hold. The motors will stop after 3 seconds.



Throttle Stick

2. When the aircraft has landed, push the throttle stick down, then perform the CSC command to stop the motors. Release both sticks once the motors have stopped.



Throttle Stick

Appendix

Specifications

| Airframe | |
|------------------------------------|--|
| Diagonal Wheelbase | 1520 mm |
| Frame Arm Length | 625 mm |
| Dimensions | 1471 mm×1471 mm×482 mm (Frame arms unfolded, propellers removed) 780 mm×780 mm×482 mm (Frame arms folded) |
| Propulsion System | |
| Motors | |
| Stator Size | 60×10 mm |
| KV | 130 rpm/V |
| Max Thrust | 5.1 kg/rotor |
| Max Power | 770 W |
| Weight (With cooling fan) | 280 g |
| ESCs | |
| Max Allowable Current (Continuous) | 25 A |
| Operating Voltage | 50.4 V (12S LiPo) |
| Signal Frequency | 30 Hz to 450 Hz |
| Drive PWM Frequency | 12 kHz |
| Foldable Propeller | |
| Material | High-performance engineered plastics |
| Diameter × Pitch | 21×7 inch |
| Weight | 58 g |
| Spraying System | |
| Liquid Tank | |
| Volume | 10 L |
| Standard Operating Payload | 10 kg |
| Max Battery Size | 151 mm×195 mm×70 mm |
| Sprinklers | |
| Model | XR11001VS |
| Quantity | 4 |
| Max Spray Rate | 0.45 L/min (Single nozzle, using water) |
| Spray Width | 4 - 6 m (4 nozzles, 1.5 – 3 m above the crops) |
| Droplet Size | XR11001VS: 130 - 250 μm (Depending on operating environment and spraying speed) |

| Terrain Follow System | |
|--|---|
| Detection Range | 1 - 5 m |
| Working Range | 1.5 - 4.5 m |
| Detection Accuracy | < 10 cm |
| Flight Parameters | |
| Total Weight (Excluding battery) | 9.5 kg |
| Standard Takeoff Weight | 23.5 kg |
| Max Takeoff Weight | 24.5 kg (At sea level) |
| Max Thrust-Weight Ratio | 1.73 (Takeoff weight of 23.5 kg) |
| Battery | DJI approved battery pack (Model: MG-12000S) |
| Max Power Consumption | 6400 W |
| Hovering Power Consumption | 3250 W(Takeoff weight of 23.5 kg) |
| Hovering Time* | 24 min(Takeoff weight of 13.5 kg) 10 min(Takeoff weight of 23.5 kg) |
| *At sea level and in wind speeds under 3 m/s | |
| Max Operating Speed | 8 m/s |
| Max Flying Speed | 12 m/s |
| Max Service Ceiling Above Sea Level | 2000 m |
| Operating Temperature | 0° to 40° C |
| Remote Controller | |
| Model | DLG60A |
| Operating Frequency | LB:2408 ~2475.5 MHz WIFI:2412 ~2462,5180~5240MHz,5745~5825 MHz |
| Max Transmission Range | 1 km (Unobstructed and free of interference) |
| Built-in Battery | 2S LiPo |
| Display Device | 5.5 inch screen, 1920×1080, 1000 cd/m ² , Android system, 4G RAM + 16G ROM |
| Operating Temperature | -10° to 40° C |
| Charging Temperature | 5° to 40° C |
| Remote Controller Charger | |
| Model | A14-057N1A |
| Voltage | 17.4 V |
| Rated Power | 57 W |

Aircraft Status Indicator Description

| Blinking Patterns | Description |
|--------------------------------------|---|
| Blinking Red, Green and Yellow | Self-testing |
| Blinking Yellow for 4 times | Warming up |
| Blinking Purple Slowly | P-mode (GPS) |
| Blinking Yellow Slowly | A-mode or P-mode/F-mode (no GPS) |
| Blinking Green Slowly | F-mode (GPS) |
| Solid Red | System error. Restart the aircraft, if not work, contact DJI Support. |
| Blinking Red and Yellow Alternately | Abnormal compass data, compass calibration required |
| Blinking Red Several Times Rapidly | Point A recorded |
| Blinking Green Several Times Rapidly | Point B recorded |
| Blinking Blue Several Times Rapidly | The aircraft flies to the next turning point in Smart Operation Mode. |
| Solid Purple for one second | Enters Continuous Smart Operation Mode |
| Blinking Yellow Slowly | Remote controller signal lost |
| Blinking Red Slowly | Low battery level |
| Blinking Red Rapidly | Critically low battery level |
| Solid Green | System Data Protection function working |

FCC Compliance Notice

This device complies with Part 15 of the FCC Rules. Operation is subject to the following two conditions: (1) This device may not cause harmful interference, and (2) This device must accept any interference received, including interference that may cause undesired operation.

Any changes or modifications not expressly approved by the party responsible for compliance could void the user's authority to operate the equipment.

This equipment has been tested and found to comply with the limits for a Class B digital device, pursuant to part 15 of the FCC Rules. These limits are designed to provide reasonable protection against harmful interference in a residential installation. This equipment generates, uses and can radiate radio frequency energy and, if not installed and used in accordance with the instructions, may cause harmful interference to radio communications. However, there is no guarantee that interference will not occur in a particular installation. If this equipment does cause harmful interference to radio or television reception, which can be determined by turning the equipment off and on, the user is encouraged to try to correct the interference by one or more of the following measures:

- Reorient or relocate the receiving antenna.
- Increase the separation between the equipment and receiver.
- Connect the equipment into an outlet on a circuit different from that to which the receiver is connected.
- Consult the dealer or an experienced radio/TV technician for help.

RF Exposure Information

3W-DJI-8-10-015 complies with FCC radiation exposure limits set forth for an uncontrolled environment. In order to avoid the possibility of exceeding the FCC radio frequency exposure limits, human proximity to the antenna shall not be less than 20cm during normal operation.

For model DLG60A, SAR tests are conducted using standard operating positions accepted by the FCC with the device transmitting at its highest certified power level in all tested frequency bands, although the SAR is determined at the highest certified power level, the actual SAR level of the device while operating can be well below the maximum value. Before a new model is available for sale to the public, it must be tested and certified to the FCC that it does not exceed the exposure limit established by the FCC, Tests for each product are performed in positions and locations as required by the FCC. For Handheld operation, this device has been tested and meets the FCC RF exposure guidelines when used with an accessory designated for this product or when used with an accessory that contains no metal.

KCC Warning Message

“해당무선설비는 운용 중 전파혼신 가능성이 있으므로 인명안전과 관련된 서비스는 할 수 없습니다.”

“해당 무선설비는 운용 중 전파혼신 가능성이 있음”



인증받은자의 상호 : SZ DJI TECHNOLOGY CO., LTD

제품명 / 모델명 : AGRAS MG-1S / 3W-DJI-8-10-015

제조사 및 제조국가 : SZ DJI TECHNOLOGY CO., LTD

제조년월 : 2017.01

인증번호 : MSIP-CRM-dji-AG405

해당 무선설비는 전파혼신 가능 성이 있으므로 인명안전과 관련된 서비스는 할 수 없음

EU Compliance Statement: SZ DJI TECHNOLOGY CO., LTD. hereby declares that this device is in compliance with the essential requirements and other relevant provisions of the R&TTE Directive.

A copy of the EU Declaration of Conformity is available online at www.dji.com/euro-compliance

