

DJI Goggles

User Guide

2017.01

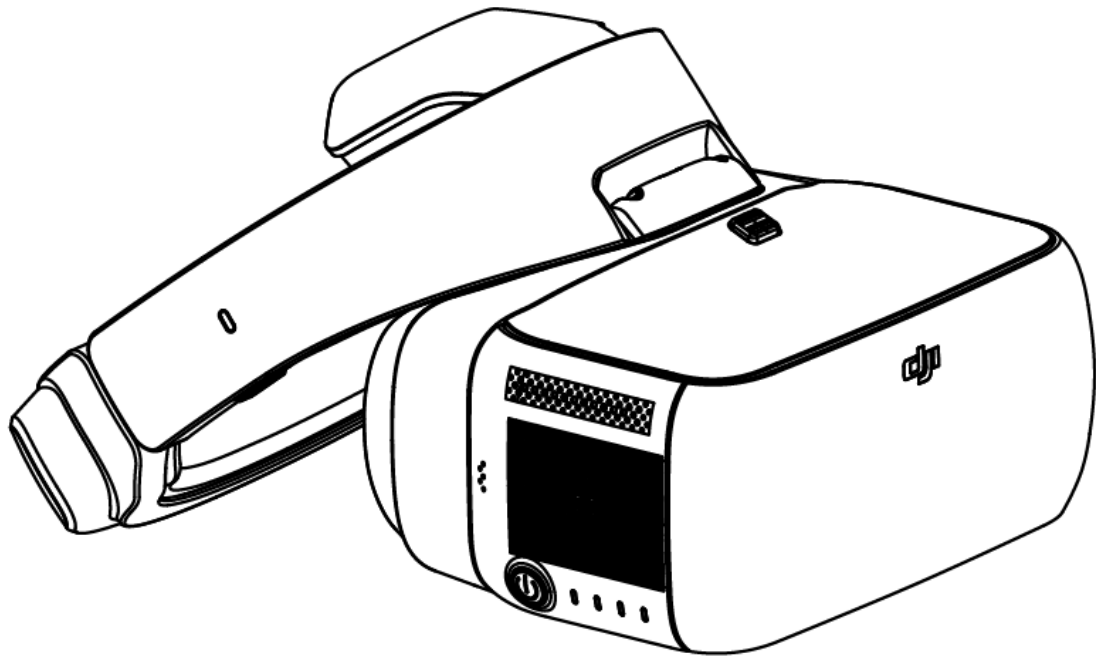

Product Profile

Introduction

DJI Goggles (abbreviated as "Goggles") is equipped with high-performance displays and an ultra-low latency video downlink for use with DJI aircraft, giving you a real-time aerial FPV (First Person View) experience. Goggles can also be used to play HD videos, bringing you an immersive high-definition viewing experience.

Their intuitively functional design makes them easy to operate using only the right hand. Goggles support head tracking, allowing aircraft and/or gimbal to be controlled using head movements. Used with Intelligent Flight Modes, this introduces a new style of flying.

At a Glance

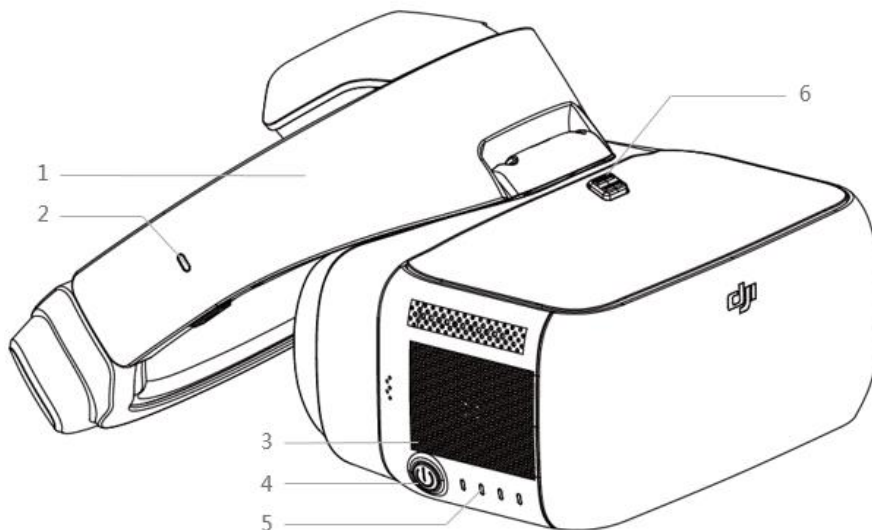

1. Strap
2. Charging Status Indicator
3. Touch Panel
4. Power Button
5. Battery Level Indicators
6. Strap Buckle

7. Heat Vent

8. Micro SD

Card Slot

9. Audio Port

10. HDMI Port

11. Speaker

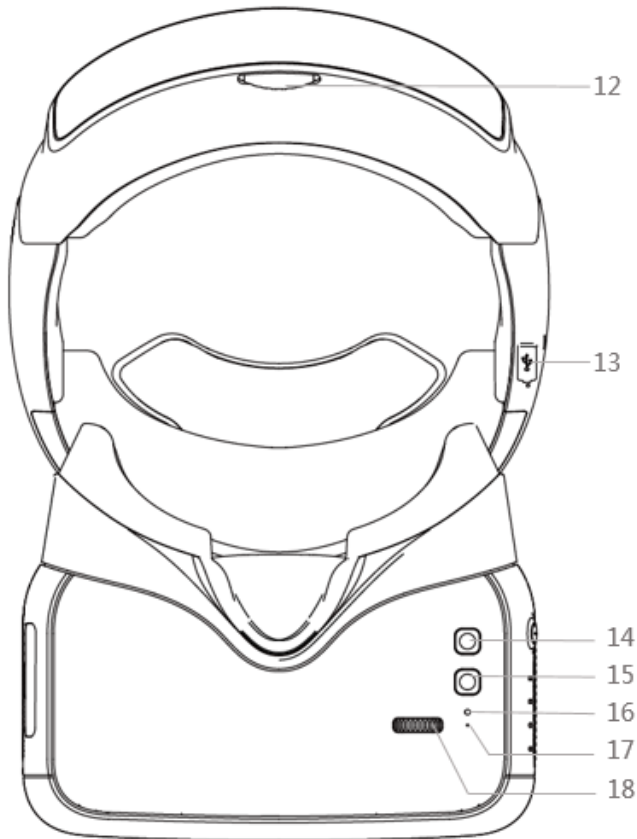
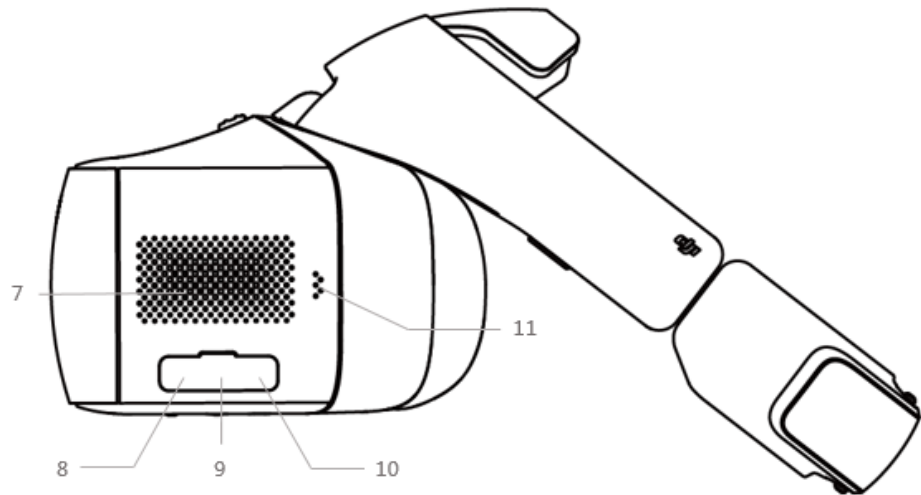

12. Strap Knob

13. Charging/Upgrade Port

(Micro USB)

14. Back Button

15. Focus Button

16. Link Button

17. Linking Status Indicator

18. IPD (Interpupillary Distance)

Knob

Installation and Wearing

1. Insert the Strap Buckle into the slot above the lenses until you hear a click. Check that it has been securely fastened.

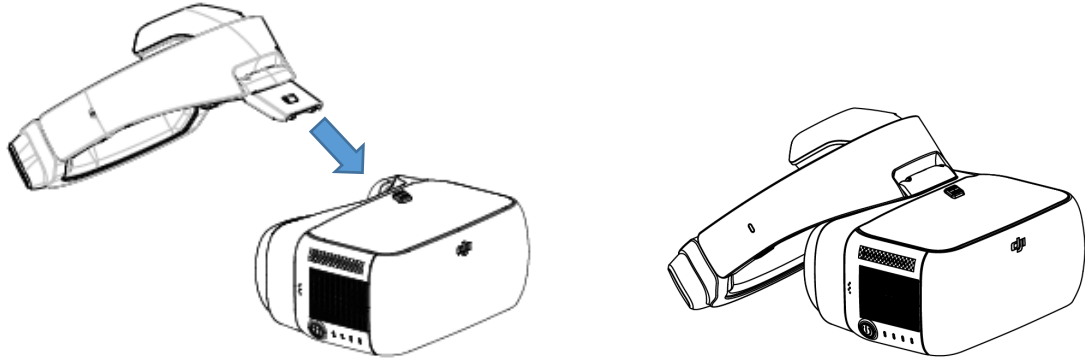

2. Align the lenses over your eyes and pull the strap down. Adjust the Strap Knob to fit the Goggles snugly and comfortably.

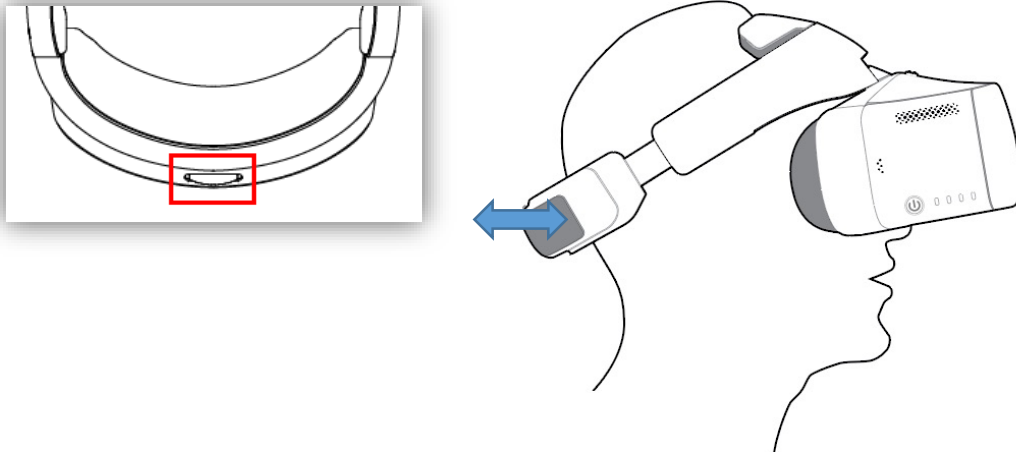

3. Turn the IPD Knob to adjust the distance between the lenses until images are aligned.

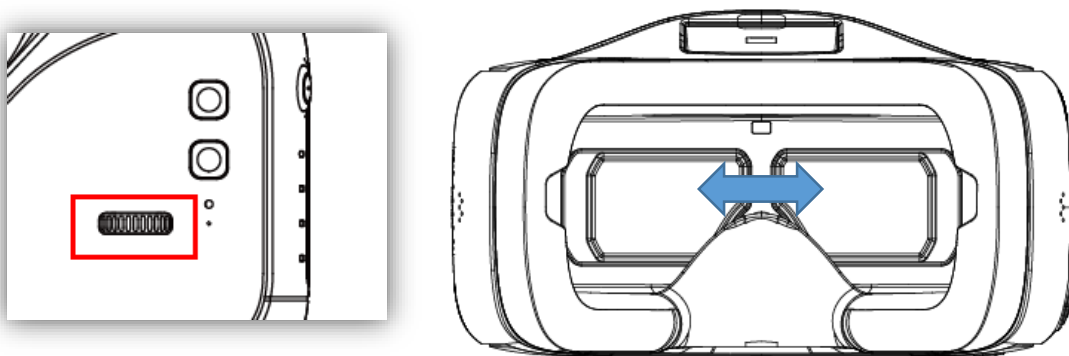



- Goggles can be worn over glasses.
 - When putting the Goggles on, flip the lens portion to see outside the goggles. Flip it back down for immersion.
-

Usage

Controls and Operations

[1] Power Button

Press the Power Button once, the press again and hold for 2 seconds to turn the Goggles on/off. Battery Level Indicators will display the current battery level.

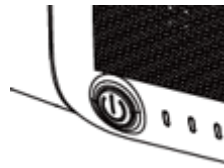

[2] Battery Level Indicators





































When the battery is off, press the Power Button once to light up Battery Level Indicators to display the current battery level.

 The Battery Level Indicators will also show the current battery level during charging and discharging. The indicators are defined below.

 LED on

 LED flashing

 LED off

Battery Level Indicators				
LED1	LED2	LED3	LED4	Battery Level
				87.5%~100%
				75%~87.5%
				62.5%~75%
				50%~62.5%
				37.5%~50%
				25%~37.5%
				12.5%~25%
				0%~12.5%
				=0%

[3] Touch Panel

Use the touch panel with your right hand to control on-screen operations.

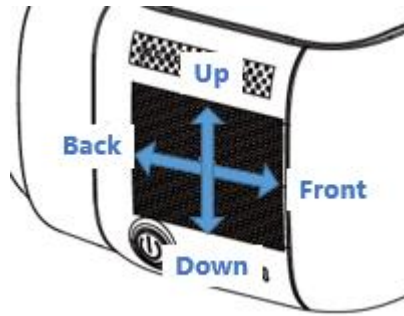

Action	Description
Swipe forward/backward with one finger	Browse the menu and scroll right/left
Swipe upward/downward with one finger	Browse the menu and scroll up/down
	In the Main view, swipe upward to hide warnings
Swipe backward with two fingers	Lock the touch panel. It will become non-functional
Swipe forward with two fingers	Unlock the touch panel
Swipe downward with two fingers	Enter the shortcut menu
Swipe upward with two fingers	Exit the shortcut menu
Tap with one finger	Confirm

[4] Charging Status Indicator

Indicates the current charging status, the LED be solid red, yellow, green to reflect low, medium and high power levels respectively.

[5] Back Button

Press to return to the previous menu.

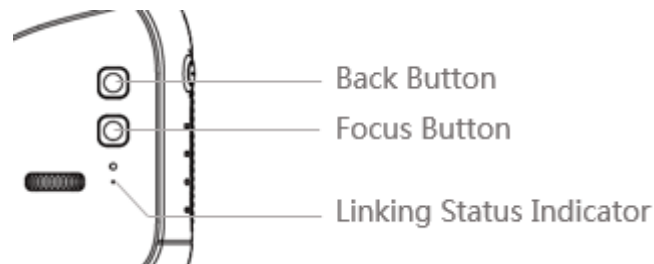

[6] Focus Button

Press to show the focus cursor on the display screen, and move your head to define the focus point. Tap the touch panel then swipe forward/backward with one finger to zoom in or zoom out.

-
- Only supported on the Mavic Pro, Phantom 4 Pro/Pro+ and Inspire 2.
-

[7] Linking Status Indicator

Indicates the linking status of the Goggles and the Mavic Pro. The indicator will be solid red while linking, and it will go solid green when linked.

Connection

Goggles supports a wide range of DJI aircraft and different uses. Follow the steps below to connect.

Mavic Pro

Goggles connect wirelessly to the Mavic Pro using OcuSync.

This connection is suitable for both single and dual operator aircraft control. In this setup, the pilot using the remote controller can focus on flight, while the Goggles

operator can view the environment in real-time FPV for more intuitive control. By moving their head, the Goggles wearer can control aircraft orientation or gimbal movement.

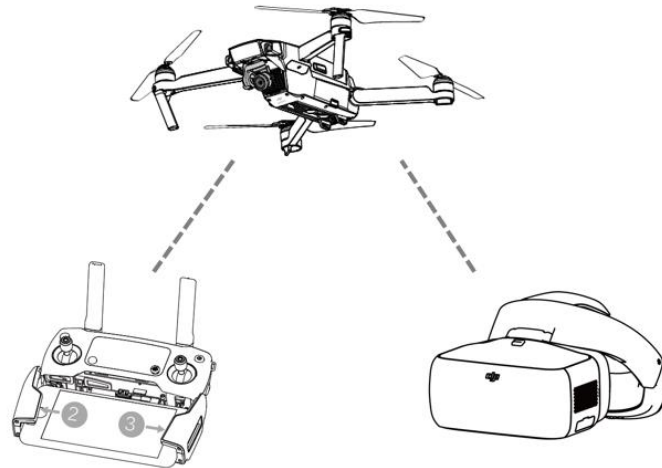

- If the Remote Controller and Goggles are operated by the same user, a spotter able to instruction and warnings is required to ensure safe flying.
- In Motion-controlled-controlled Flight mode, aircraft yaw can be controlled by both the Goggles and the Remote Controller. In Motion-controlled-controlled Gimbal mode, only the gimbal will move with the Goggles.
- When linked to the Mavic Pro, the remote controller can be used to control the Goggles. 5D Button = Touch Panel, C1 Button = Focus Button, C2 Button = Back Button. These buttons will no longer control the aircraft. Fly with caution.

Linking Method

1. Ensure both the aircraft and the remote controller are powered on and linked.
2. Put on Goggles and power on.
3. Use the touch panel to enter Tools > Settings > Pairing.

4. Choose "Normal" and confirm. The Goggles' linking status indicator will go solid red to wait for linking.
5. Press the Linking Button on the Mavic Pro. Once linked, the Goggles' linking status indicator will turn solid green.

-
- ⚠ • Toggle the control mode switch of the Remote Controller to RC mode before linking.
-

Other DJI Aircraft

Goggles also supports other DJI aircraft. Connect Goggles to the either the Micro USB port or the HDMI port of the Remote Controller.

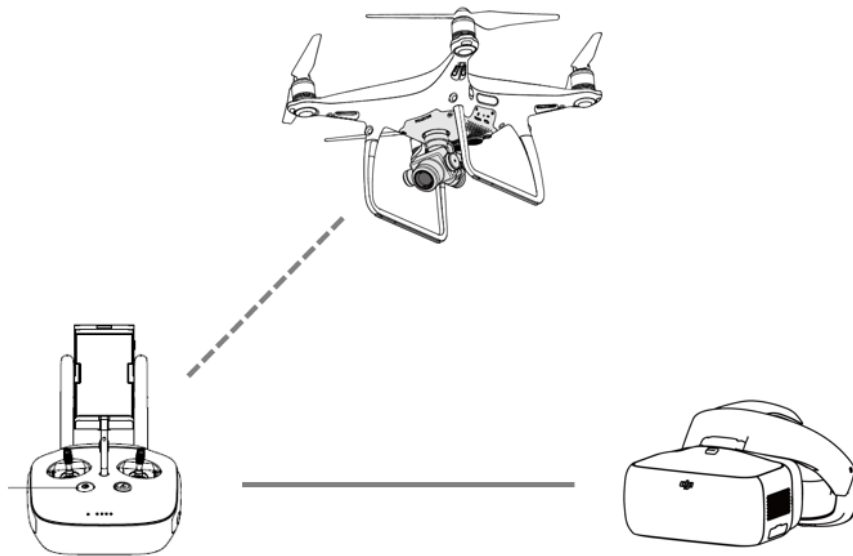

Main Screen

The main screen of Goggles and functions are described as follows:

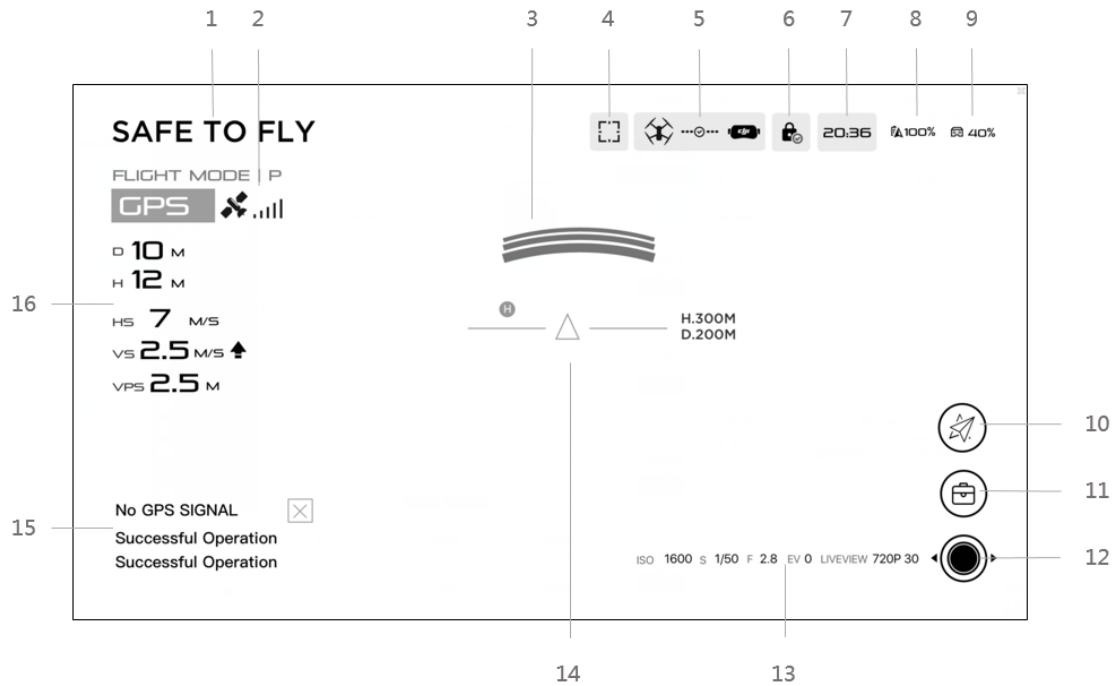

1. Aircraft Status

Indicates the aircraft's flight status.

2. Flight Mode and GPS status

Indicates the current flight mode and GPS signal strength.

3. Obstacle Detection Status

Red bars are displayed when obstacles are close to the aircraft. Orange bars are displayed when obstacles are in detection range.

4. Motion-controlled Mode

Shows the current Motion-controlled Mode, including motion-controlled flight, motion-controlled gimbal, TapFly, ActiveTrack and focus.

5. Connection Status

Indicates the connection status of the aircraft and Goggles. Green indicates that the connection is good, yellow indicates that the connection signal is weak or unstable, and red indicates disconnected. Goggles will attempt to reconnect if

disconnected.

6. Touch Panel Lock Status

Indicates the lock status of the touch panel. A locked touch panel will be unresponsive to touch to avoid accidental control. Swipe forward with two fingers to unlock it.

7. Remaining Flight Time

Shows the remaining flight time of the aircraft.

8. Aircraft Battery Level

Shows the current battery level of the Intelligent Flight Battery.

9. Goggles Battery Level

Shows the current battery level of the Goggles.

10. Intelligent Flight Mode

Tap to select TapFly, ActiveTrack, Terrain Follow and Tripod Modes.

11. Tools

Tap to set the Goggles' settings, select Auto Takeoff/Landing, HDMI video playback or flight photos/videos playback.

12. Camera Settings/Shoot/Record Button

Tap to set ISO, shutter, aperture and auto exposure values of the camera.

Swipe left or right to switch to Shoot or Record mode, tap to start shooting photos or recording video.

13. Camera Parameters and Video Downlink Resolution

Shows the setting parameters of the camera and Video Downlink Resolution.

14. Flight Attitude

The triangle indicates the direction the aircraft is facing.

The horizontal level indicates the aircraft' s roll angle.

The scale indicates the tilt angle of the gimbal.

15. Prompt Message

Shows warning messages. Swipe up or down to select and tap to delete prompts.

16. Flight Telemetry

The horizontal/vertical distance between the aircraft and the Home Point, and the movement speed across horizontal/vertical distance of the aircraft.

When the aircraft is close to the ground, the altitude will be displayed.

Controlling the Aircraft

Intelligent Flight Mode

Goggles support Intelligent Flight Modes including TapFly, ActiveTrack, Terrain Follow and Tripod. Refer to the aircraft' s user manual for more details.

Shortcut Menu

Swipe downward with two fingers on the touch panel to enter the shortcut menu.

Move the cursor and tap the touch panel to turn functions on/off. Goggles supports head tracking control, allows the aircraft follow head movements.

- **Motion-controlled flight**

Move your head to control the aircraft and the gimbal. Turn left and right to

control the yaw of the aircraft, turn up and down to control the pitch of the gimbal (-90° to 30°).

- Motion-controlled gimbal

Move your head to control the gimbal. Turn left and right to control the yaw of the gimbal (-30° to 30°), and turn up and down to control the pitch of the gimbal (-90° to 30°).

Video Play

Watch flight videos or HD video content through the Goggles for an immersive viewing experience.

Flight Photo/Video

Select Tools > Replay to enter the playback page for flight photos and videos.

- Local Storage

Remove the Micro SD card from the aircraft and insert it into the Micro SD card slot on the Goggles then select Local Storage.

- Aircraft Storage

Select Aircraft Storage to preview images stored on the aircraft.



- While browsing photos or videos, swipe upward/downward to download or delete files.
-

Video Play

Connect a video source to the Goggles with an HDMI cable, and select Tools > HDMI Input to view in HD. Set the brightness, volume and input source. Charging the Goggles

Charging the Goggles

1. Connect the battery charger to a power outlet (100-240V, 50/60Hz).
2. With the Goggles powered off, connect the charging port on the strap to the charger with the Micro USB cable included.

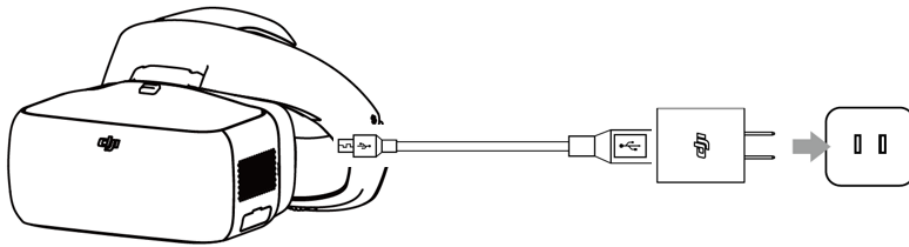

3. The Charging Status Indicator will go solid red, yellow and green in order when charging. Battery Level Indicators will blink green to indicate the current battery level.
4. The Battery is fully charged when the Charging Status Indicator or the Battery Level Indicators turn off. Disconnect the Goggles from the charger.

Battery Level Indicators While Charging				
LED1	LED2	LED3	LED4	Battery Level
■	□	□	□	0%~25%
■	■	□	□	25%~50%
■	■	■	□	50%~75%
■	■	■	■	75%~100%
□	□	□	□	Fully Charged



- The Goggles' battery is located on the strap. Connect the strap to the charger for charging. The battery is fully charged when the Charging Status Indicator turns off.
 - A standard charger is recommended for charging. It takes approximately 4 hours to fully charge the battery. Other chargers may take longer.
-

Upgrading the Firmware

Use DJI Assistant 2 to upgrade the Goggles.

1. Power on the Goggles and connect it to a computer with a Micro USB cable.
2. Launch DJI Assistant 2 and login with a DJI account.
3. Select "Goggles" and click "Firmware Upgrade" on the left.
4. Select the firmware version required.
5. DJI Assistant 2 will download and upgrade the firmware automatically.
6. Restart Goggles after the firmware upgrade is complete.

Specifications

Weight	Lenses: 490 g Strap: 520 g
Dimensions	Lenses: 195×155×110 mm Strap (Folded): 255×205×92 mm
FOV	85° (single screen)
Screen Size	5 inch×2
Interpupillary Distance Range	58 – 70 mm
Screen Resolution	3840×1080 (single screen: 1920×1080)
Operating Frequency	2.4 GHz
Max. Transmission Distance	Same as the aircraft connected
Video Downlink Resolution	1080p30, 720p60, 720p30
Min. Video Downlink Latency (Near field and free of interference)	120 ms (Mavic Pro, 720p60, video format: 720p120) 150 ms (Phantom 4, 720p60, video format: 720p60) 150 ms (Phantom 4 Pro, 720p60, video format: 720p60/720p120) 140 ms (Inspire 2+X5S, 720p60, video format: 16:9 120p) 190 ms (Inspire 2+X4S, 720p60, video format: 1080p60)

Battery Capacity	9440 mAh
Battery Energy	35.44 Wh
Max Operating Time	6 hrs
Operating Temperature Range	32°F (0°C) - 104°F (40°C)
I/O Interface	Micro USB, audio jack, HDMI type D, Micro SD card slot
HDMI Supported	HDMI 1.4b, HDCP 1.4
Sensors	Gyroscope, Accelerometer, Proximity sensor

Compliance Information

FCC Regulatory Statement

This device complies with Part 15 of the FCC Rules. Operation is subject to the following two conditions: (1) This device may not cause harmful interference, and (2) This device must accept any interference received, including interference that may cause undesired operation.

Any changes or modifications not expressly approved by the party responsible for compliance could void the user's authority to operate the equipment.

Notice:

This equipment has been tested and found to comply with the limits for a Class B digital device, pursuant to Part 15 of the FCC Rules. These limits are designed to provide reasonable protection against harmful interference in a residential installation. This equipment generates, uses and can radiate radio frequency energy and, if not installed and used in accordance with the instructions, may cause harmful interference to radio communications. However, there is no guarantee that interference will not occur in a particular installation.

If this equipment does cause harmful interference to radio or television reception, which can be determined by turning the equipment off and on, the user is encouraged to try to correct the interference by one or more of the following measures:

- Reorient or relocate the receiving antenna.
- Increase the separation between the equipment and receiver.
- Connect the equipment into an outlet on a circuit different from that to which the receiver is connected.
- Consult the dealer or an experienced radio/TV technician for help.

FCC Radiation Exposure Statement

This equipment complies with FCC radiation exposure limits set forth for an uncontrolled environment. This transmitter must not be co-located or operate in conjunction with any other antenna or transmitter.

This equipment has been tested and meets the FCC RF exposure guidelines. During testing, Goggles radios were set to their highest transmission levels and placed in positions that simulate normal use. Operate the Goggles according to the manual to keep compliance.

ISED RSS Regulatory Statement

This device complies with ISED license-exempt RSS standard(s). Operation is subject to the following two conditions:

- (1) this device may not cause interference, and
- (2) this device must accept any interference, including interference that may cause undesired operation of the device.

Le présent appareil est conforme aux CNR d'ISED applicables aux appareils radio exempts de licence. L'exploitation est autorisée aux deux conditions suivantes :

- (1) l'appareil ne doit pas produire de brouillage, et

(2) l'utilisateur de l'appareil doit accepter tout brouillage radioélectrique subi, même si le brouillage est susceptible d'en compromettre le fonctionnement.

ISED Radiation Exposure Statement

This equipment complies with ISED radiation exposure limits set forth for an uncontrolled environment. This transmitter must not be co-located or operating in conjunction with any other antenna or transmitter.

Cet appareil est

conforme aux limites d'exposition de rayonnement RF ISED établies pour un environnement non contrôlé. Cet émetteur ne doit pas être co-implanté ou fonctionner en conjonction avec toute autre antenne ou transmetteur.

CAN ICES-3 (B)/NMB-3(B)

EU Compliance Statement

SZ DJI TECHNOLOGY CO., LTD. hereby declares that this device is in compliance with the essential requirements and other relevant provisions of the RED Directive.

A copy of the EU Declaration of Conformity is available online at www.dji.com/euro-compliance

CE 1313

EU contact address: DJI GmbH, Industrie Strasse. 12, 97618, Niederlauer, Germany.

Environmentally friendly disposal



Old electrical appliance must not be disposed of together with the residual waste, but have to be deposited separately. The disposal at the communal collection point  via private person is for free. The owner of old appliance is responsible to bring the appliances to these collecting point or to similar collection points. With this little personal effort, you contribute to recycle valuable raw materials and the treatment of toxic substances.

KCC Warning Statement

(1) 이 기기는 가정용으로 전자파적합등록을 한 기기로서 주거지역에서는 물론 모든 지역에서 사용할 수 있습니다.

(2) 당해 무선설비는 전파혼신 가능성이 있으므로 인명안전과 관련된 서비스는 할 수 없음.

NCC Warning Statement

根據 NCC 低功率電波輻射性電機管理辦法 規定:

(1) 第十二條經型式認證合格之低功率射頻電機，非經許可，公司、商號或使用者均不得擅自變更頻率、加大功率或變更原設計之特性及功能。

(2) 第十四條低功率射頻電機之使用不得影響飛航安全及干擾合法通信；經發現有干擾現象

時，應立即停用，並改善至無干擾時方得繼續使用。
前項合法通信，指依電信法規定作業之無線電通信。
低功率射頻電機須忍受合法通信或工業、科學及醫療用電波輻射性電機設備之干擾。

NBTC Warning Statement

เครื่องโทรคมนาคมและ อุปกรณ์นี้ มีความสอดคล้องตามข้อกำหนดของ กทช.

IFETEL Warning Statement

“La operación de este equipo está sujeta a las siguientes dos condiciones: (1) es posible que este equipo o dispositivo no cause interferencia perjudicial y (2) este equipo o dispositivo debe aceptar cualquier interferencia, incluyendo la que pueda causar su operación no deseada.”