

# SPARK

User Manual V1.0

2017.03

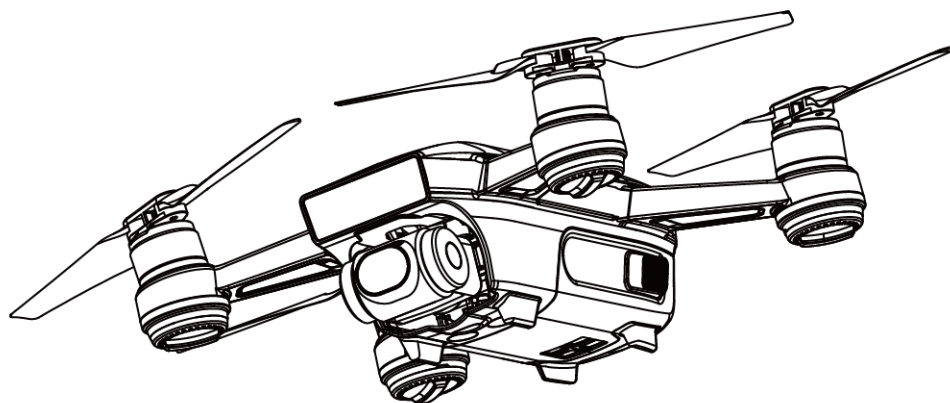

# Using this manual

## Legends



Warning



Important



Hints and Tips



Reference

## Read Before the First Flight

Read the following documents before using the SPARK™:

1. Spark In the Box
2. Spark User Manual
3. Spark Quick Start Guide
4. Spark Disclaimer and Safety Guidelines
5. Spark Intelligent Flight Battery Safety Guidelines

We recommend that you watch all tutorial videos on the official DJI™ website and read the Disclaimer before you fly. Prepare for your first flight by reviewing the Spark Quick Start Guide and refer to the User Manual for more details.

## Video Tutorials

Please watch the tutorial videos at the link below, which demonstrates how to use Spark safely:

<http://www.dji.com/Spark/info#video>



## Download the DJI GO 4 App

Ensure to use the DJI GO™ 4 app during flight. Scan the QR code on the right to download the latest version.

The Android version of the DJI GO 4 app is compatible with Android 4.4 or later.

The iOS version of the DJI GO 4 app is compatible with iOS 9.0 or later.



# Contents

Using this manual.....	2
Lengends .....	2
Read Before the First Flight.....	2
Video Tutorials .....	2
Download the DJI GO 4 App.....	2
Product Profile .....	4
Introduction .....	4
Aircraft Diagram .....	4
Aircraft .....	5
Gimbal and Camera.....	5
Attaching and Detaching the Propellers.....	6
Intelligent Flight Battery.....	7
Vision System and Infrared Sensing System.....	9
Flight Mode .....	10
Using Mobile Device to Control Aircraft.....	10
DJI GO 4 App .....	12
Flight.....	15
Appendix .....	18
Specifications .....	18
Compliance Information .....	20

# Product Profile

## Introduction

The DJI Spark is DJI's smallest flying camera, featuring a fully stabilized camera, Intelligent Flight Modes and Obstacle Avoidance inside a revolutionary design. It captures 1080p videos and 12 megapixel photos, and is capable of both ActiveTrack™ and TapFly™ making complex shots effortless.

Spark boasts a maximum flight speed of 29 mph (46.8 kph) and a maximum flight time of 16.5 minutes\*.

## Aircraft Diagram

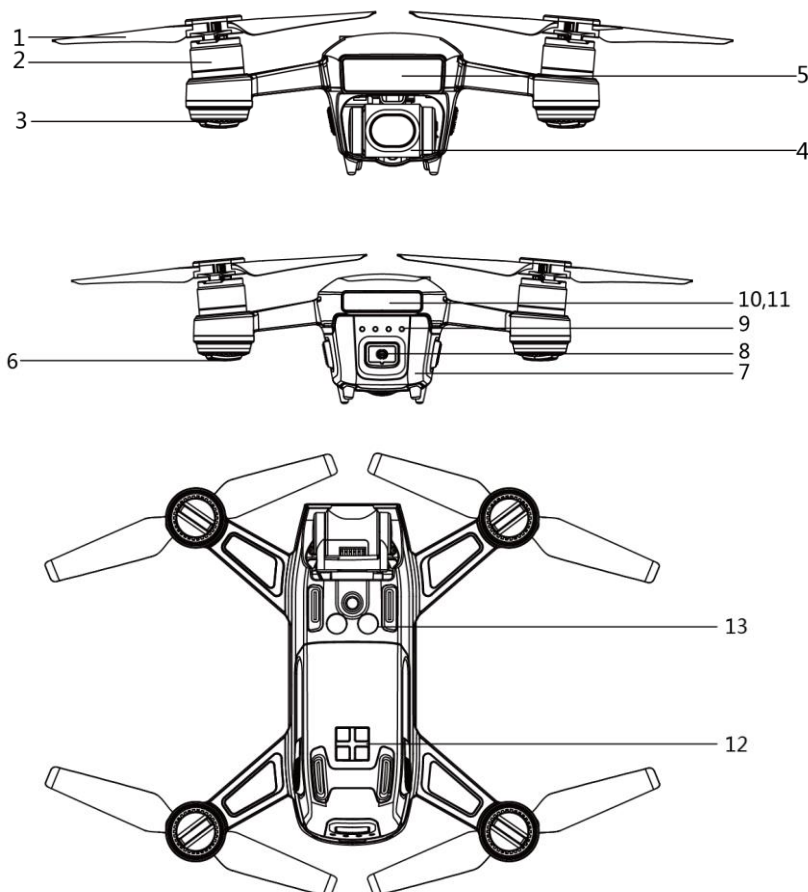

1. Propeller
2. Motor
3. Front LED Indicator
4. Gimbal and Camera

5. Infrared Sensing System
6. Aircraft Status Indicator
7. Intelligent Flight Battery
8. Power Button
9. Battery Level Indicators
10. Micro USB Port
11. microSD Card Slot
12. Charging Port
13. Downward Vision System

## Aircraft

### Gimbal and Camera

#### Gimbal

##### Profile

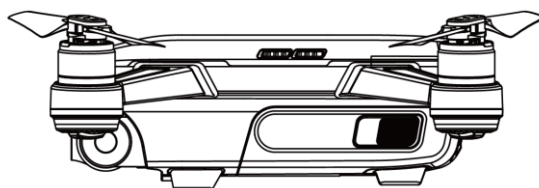

The 2-axis gimbal provides a steady platform for the attached camera, allowing you to capture clear, stable images and video. The gimbal can tilt the camera within a 85° range.

Go to Camera View in the DJI GO 4 app, tap and hold on the screen until a blue circle appears, then drag the circle to control the camera's tilt.



##### Gimbal Operation Modes

Two gimbal operation modes are available. Switch between the different operation modes on the camera settings page of the DJI GO 4 app.

	 Follow Mode	The angle between the gimbal's orientation and aircraft's nose remains constant at all times.
	 FPV Mode	The gimbal will synchronize with the movement of the aircraft to provide a first-person perspective flying experience.

## Camera

### Profile

The on-board camera uses the 1/2.3 inch CMOS sensor to capture video up to 1080p at 30 fps with the Spark and 12 megapixel stills. You may choose to record video in either MOV or MP4 formats. Available picture shooting modes include burst, continuous, and interval mode. A live preview of what the camera sees can be monitored on the connected mobile device via the DJI GO 4 app.

### Camera Micro SD Card Slot

To store your photos and videos, insert the Micro SD card into the slot, as shown below, before turning on the Spark. The Spark supports Micro SD cards up to 64 GB. A UHS-1 Micro SD card is recommended due to their fast read and write speeds allowing you to save high-resolution video data.

---

 Do not remove the Micro SD card from the Spark when it is turned on.

---

 To ensure the stability of the camera system, single video recordings are capped at 30 minutes.

---

### Camera Data Port

Turn on the Spark and connect a USB cable to the Micro USB Port to download photos and videos to your computer.





---

 The aircraft must be turned on before attempting to access the files on the Micro SD card.

---

## Attaching and Detaching the Propellers

White ring and unmarked propellers indicate where they should be attached and in which direction they should spin.

Propellers	White Ring	Unmarked
Figure		
Attach On	Motors with white marks	Motors without white marks
Legends	 Lock: Turn the propellers in the indicated direction to mount and tighten.  Unlock: Turn the propellers in the indicated direction to loosen and remove.	

## Attaching the Propellers

Attach the white ringed propellers to the mounting base with white marks. Press the propeller down onto the mounting plate and rotate in the lock direction until it is secured. Attach the other propellers to the mounting bases without marks. Unfold all the propellers blades.

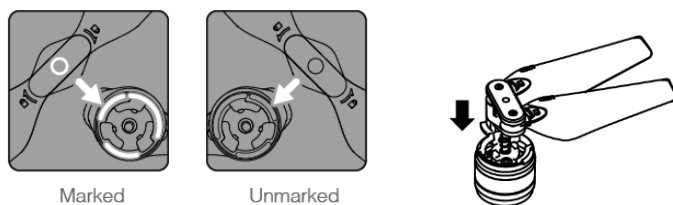

## Detaching the Propellers

Press the propellers down into the motor mount and rotate in the unlock direction.



- Be aware of the sharp edges of the propellers. Handle with care.
- Use only the DJI approved propellers. Do not mix propeller types.
- Stand clear of the motors and **DO NOT** touch the propellers when they are spinning.
- Check that the propellers and motors are installed correctly and firmly before every flight.
- Ensure that all propellers are in good condition before each flight. **DO NOT** use aged, chipped, or broken propellers.
- To avoid injury, **STAND CLEAR** of and **DO NOT** touch propellers or motors when they are spinning.

## Intelligent Flight Battery

### Introduction

The DJI Intelligent Flight Battery has a capacity of 1480 mAh, a voltage of 11.4 V, and a smart charge/ discharge functionality. It should only be charged using an appropriate DJI approved charger.



The Intelligent Flight Battery must be fully charged before using it for the first time.

## Using the Battery

### Turning ON/OFF

Turning On: Press the Power Button once, then press again and hold for 2 seconds to turn on. The remote controller system status screen will display the current battery level.

Turning Off: Press the Power Button once, then press again and hold for 2 seconds to turn off.





































### Checking the Battery Level

The Battery Level Indicators display how much power remains. When the battery is turned off, press the Power Button once, the Battery Level Indicators will light up to display the current battery level. See below for details.



The Battery Level Indicators will also show the current battery level during charging and discharging. The indicators are defined below.

 LED is on.  : LED is flashing.  : LED is off.

Battery Level Indicators				
LED1	LED2	LED3	LED4	Battery Level
				87.5%~100%
				75%~87.5%
				62.5%~75%
				50%~62.5%
				37.5%~50%
				25%~37.5%
				12.5%~25%
				0%~12.5%
				=0%

## Charging the Intelligent Flight Battery

1. Connect the Battery Charger to a power source (100-240V, 50/60Hz).
2. Connect the Micro USB port on the Spark to the Charger to start charging.
3. The Battery Level Indicator will display the current battery level as it is charging.
4. The Intelligent Flight Battery is fully charged when the Battery Level Indicators are all off.



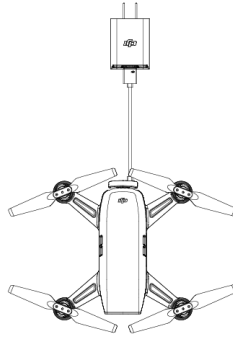

- 
- ⚠
- Never insert or remove a battery when it is turned on.
  - Allow battery temperature to drop to room temperature before storing for an extended period.
  - The charger will stop charging the battery if the battery cell's temperature is not within the operating range (5°C to 40°C).
- 

Battery Level Indicators While Charging				
LED1	LED2	LED3	LED4	Battery Level
☀	○	○	○	0%~25%
☀	☀	○	○	25%~50%
☀	☀	☀	○	50%~75%
☀	☀	☀	☀	75%~100%
○	○	○	○	Fully Charged

## Vision System and Infrared Sensing System

The Infrared Sensing System consists [1] of two 3D infrared modules on front of the aircraft. The downward Vision System uses 3D infrared modules and image data to help the aircraft maintain its current position. With the help of the Downward Vision System, your Spark can hover in place more precisely and fly indoors or in other environments where a GPS signal is not available. The main components of the Downward Vision System is located on the bottom of the aircraft; they include [2] monocular sensors and [3] 3D infrared modules.



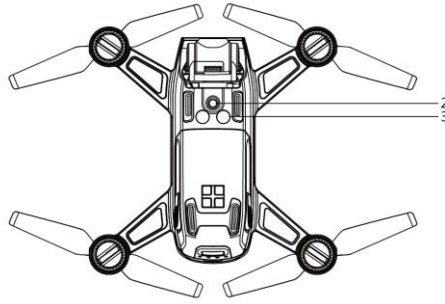

## Using the Downward Vision System

The Downward Vision System is activated automatically when the aircraft is turned on. No further action is required. The Downward Vision System is typically used in indoor environments where GPS is unavailable. Using the Downward Vision System, the aircraft can hover precisely even without GPS.



- The Downward Vision System may not be able to recognize patterns on the ground in low light (less than 100lux).
  - Downward Vision Systems may not function properly when the aircraft is flying over water.
- 

## Flight Mode

P-mode (Positioning): P-mode works best when the GPS signal is strong. The aircraft utilizes the GPS and Downward Vision Systems to locate itself, automatically stabilize, and navigate between obstacles. Advanced features such as TapFly and ActiveTrack are enabled in this mode.

S-mode (Sport): The handling of the aircraft is adjusted in to enhance maneuverability and speed. Infrared Sensing System is disabled in this mode.

## Using Mobile Device to Control Aircraft

You may use the Wi-Fi connection on the mobile device to control the aircraft. Follow the instructions below to learn how to control the aircraft over Wi-Fi.

1. Power on the aircraft.
2. Turn on your mobile device's Wi-Fi and enter the Wi-Fi password.
3. Launch DJI GO 4.

4. Tap  icon to take off the aircraft automatically. Tap on the screen and use the Virtual Joysticks to navigate the aircraft.

## Using Virtual Joysticks

Ensure the mobile device has been connected to the aircraft before using the Virtual Joysticks. The illustrations below are based on Mode 2 (left stick as throttle).

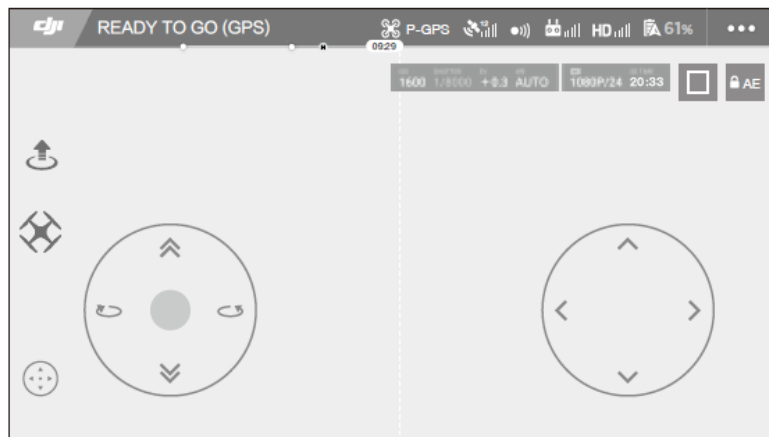

Virtual Joysticks GUI

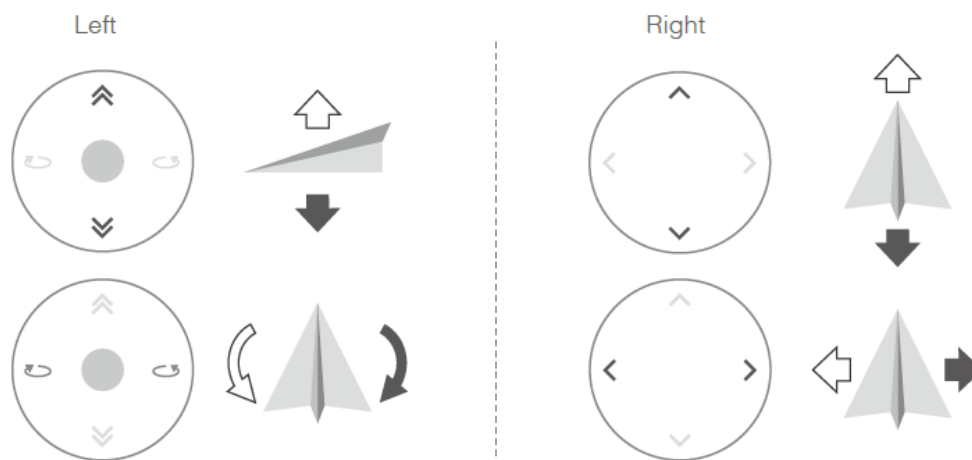

Move the aircraft upwards, downwards or rotate to the left or right by pressing on the left half of the screen. Move the aircraft forwards, backwards or rotate to the left or right by pressing on the right half of the screen.

Tap on the "  " button to enable or disable Virtual Joysticks.



The area beyond the white cycle is also responsive to control commands.

# DJI GO 4 App

Use this app to control the gimbal, camera, and other aircraft functions. The app features Equipment, Editor, SkyPixel and Me sections, which are used for configuring your aircraft, editing and sharing your photos and videos with others.

## Equipment

Enter Camera View by tapping Camera on the DJI GO 4 welcome screen.

## Camera View

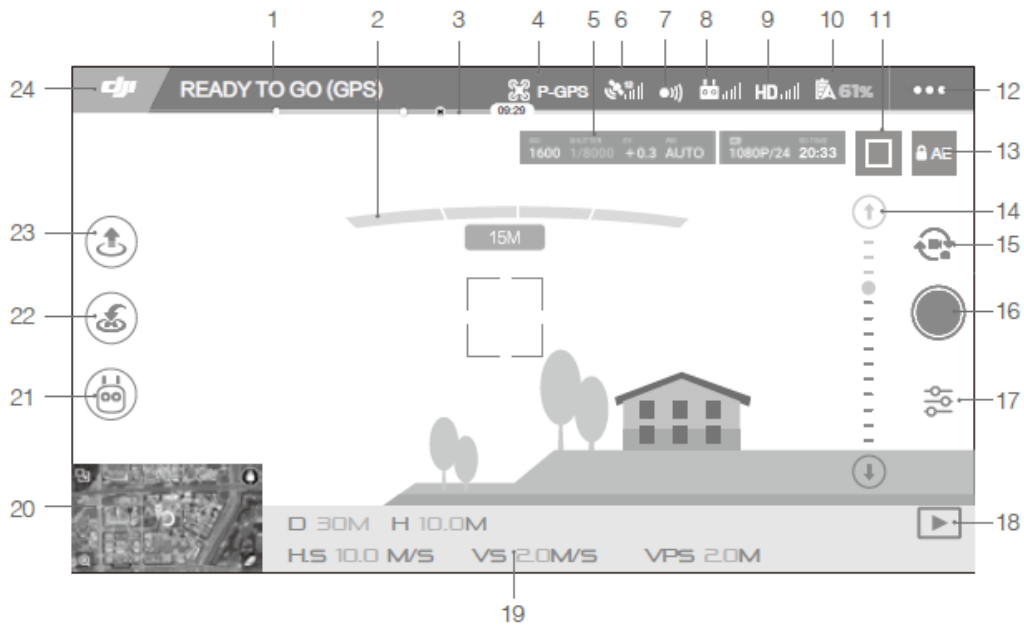

### 1. System Status

 : This icon indicates aircraft flight status and various warning messages.

### 2. Obstacles Detection Status

 : Red bars are displayed when obstacles are close to the aircraft. Orange bars are displayed when obstacles are in detection range.

### 3. Battery Level Indicator

 : The battery level indicator provides a dynamic display of the battery level. The colored zones on the battery level indicator represent the power levels needed to carry out

different functions.

#### 4. Flight Mode



: The text next to this icon indicates the current flight mode.

Tap to configure the MC (Main Controller) Settings. These settings allow you to modify flight limits and set gain values.

#### 5. Camera Parameters



Displays camera settings parameters and capacity of the Micro SD card.

#### 6. GPS Signal Strength



: Shows the current GPS signal strength. White bars indicate adequate GPS strength.

#### 7. Forward Vision System Status



: Tap into this button to enable or disable features provided by the Forward Vision System.

#### 8. Remote Controller Signal



: This icon shows the strength of the remote controller signal.

#### 9. HD Video Link Signal Strength



: This icon shows the strength of the HD video downlink connection between the aircraft and the remote controller.

#### 10. Battery Level



: This icon shows the current battery level.

Tap to view the battery information menu, set the various battery warning thresholds, and view the battery warning history.

#### 11. Focus/Metering Button



: Tap to switch between focus and metering mode. Tap to select object for focusing or metering

#### 12. General Settings



: Tap to enter general setting menu for setting metrics, enabling livestream, display flight routes and so on.

### 13. Auto Exposure Lock

 : Tap to lock the exposure value.

### 14. Gimbal Slider

 : Displays the pitch of the gimbal.

### 15. Photo/Video Button

 : Tap to switch between photo and video recording modes.

### 16. Shoot / Record Button

 : Tap to start shooting photos or recording video.

### 17. Camera Settings

 : Tap to set ISO, shutter and auto exposure values of the camera.

### 18. Playback

 : Tap to enter the playback page and preview photos and videos as soon as they are captured.

### 19. Flight Telemetry

**D 30M** : Distance between the aircraft and the Home Point.

**H 10.0M** : Height from the ground.

**HS 10.0M/S** : Aircraft horizontal speed.

**VS 2.0M/S** : Aircraft vertical speed.

### 20. Map



Tap to view map.

### 21. Intelligent Flight Mode

 : Tap to select Intelligent Flight Mode.

### 22. Smart RTH

 : Initiate RTH home procedure. Tap to have the aircraft return to the last recorded home

point.

### 23. Auto Takeoff/Landing

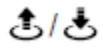
 : Tap to initiate auto takeoff or landing.

### 24. Back

 : Tap this icon to return to the main menu.

## Flight

### Takeoff/Landing Procedures

1. Place the aircraft in an open, flat area with the battery level indicators facing towards you.
2. Turn on the Intelligent Flight Battery.
3. Launch the DJI GO 4 app and enter the Camera page.
4. Wait until the Aircraft Indicator blinks green. This means the Home Point is recorded and it is now safe to fly. Use Auto Takeoff.
5. Use Auto Landing to land the aircraft.
6. Turn off the Intelligent Flight Battery















- When the Aircraft Status Indicator blinks yellow rapidly during flight, the aircraft has entered Failsafe mode.
  - A low battery level warning is indicated by the Aircraft Status Indicators blinking red slowly or rapidly during flight.
  - Watch our video tutorials for more flight information.
- 

### Flight Status Indicator

The Spark has Front LEDs and Aircraft Status Indicators. The Front LEDs show the orientation of the aircraft. The Front LEDs glow solid red when the aircraft is turned on to indicate the front (or nose) of the aircraft (the Front LED can be turned off in the DJI GO 4 app). The Aircraft Status Indicator communicates the system status of the flight controller. Refer to the table below for more information about the Aircraft Status Indicator.

## Aircraft Status Indicator Description

Normal	
 Alternating red, green and yellow flashes	Turning On and Self Diagnostic Testing
 Alternate yellow and green flashing	Warming Up
 Slow green flashing	P-mode with GPS
 Two green flashes	P-mode with Forward and Downward Vision Systems
 Slow yellow flashing	No GPS and Forward and Downward Vision Systems
 Fast green flashing	Braking
Warning	
 Fast yellow flashing	Remote Controller Signal Lost
 Slow red flashing	Low Battery Warning
 Fast red flashing	Critical Low Battery Warning
 Red flashing	IMU Error
 Solid Red	Critical Error
 Fast alternating red and yellow flashing	Compass Calibration Required

## Calibrating the Compass

Only calibrate the compass when the DJI GO 4 app or the status indicator prompt you to do so. Observe the following rules when calibrating your compass:



- DO NOT calibrate your compass where there is a chance of strong magnetic interference, such as magnetite, parking structures, and steel reinforcements underground.
- DO NOT carry ferromagnetic materials with you during calibration such as cellular phones.
- The DJI GO 4 app will prompt you to resolve the compass issue if the compass is affected by strong interference after calibration is complete. Follow the prompted instructions to resolve the compass issue.

## Calibration Procedures

Choose an open area to carry out the following procedures.

1. Tap the Aircraft Status Bar in the app and select “Calibrate”, then follow the on-screen instructions.
2. Hold the aircraft horizontally and rotate 360 degrees. The Aircraft Status Indicators will display a solid green light.



3. Hold the aircraft vertically, with nose pointing downward, and rotate it 360 degrees around the center axis.
4. Re-calibrate the aircraft if the aircraft status indicators blink red.



If the Aircraft Status Indicator blinks red and yellow after the calibration procedure, move your aircraft to a different location and try again.



- DO NOT calibrate the compass near metal objects such as a metal bridge, cars, and scaffolding.
  - If the aircraft status indicator is blinking red and yellow alternately after placing the aircraft on the ground, the compass has detected magnetic interference. Change your location.
-

# Appendix

## Specifications

<b>Aircraft</b>	
Weight	296 g
Dimensions	143x143x53 mm
Diagonal Length (propellers excluded)	172 mm
Max Ascent Speed	9.8 ft/s (3 m/s) in Sport Mode
Max Descent Speed	9.8 ft/s (3 m/s)
Max Speed	29 mph (46.8 kph) in Sport Mode without wind
Max Service Ceiling Above Sea Level	9843 feet (3000 m)
Max Flight Time	16.5 minutes (0 wind at a consistent 15.5 mph (25 kph))
Max Hovering Time	15 minutes (0 wind)
Avg. Flight Time	13 minutes (general flight, 15% battery left)
Max Flight Distance	3.7 mi (6 km, 0 wind)
Operating Temperature	32° to 104° F (0° to 40° C)
Satellite Positioning Systems	GPS/GLONASS
GPS Hover Accuracy Range	Vertical: ±0.1 m (With Vision Positioning); ±0.5 m (With GPS Positioning) Horizontal: ±0.3 m (With Vision Positioning); ±1.5 m (With GPS Positioning)
Operation Frequency	2412-2462MHz, 5745-5825MHz;
<b>Gimbal</b>	
Controllable Range	Pitch: -85° to 0°
Stabilization	2-axis (pitch, roll)
<b>Infrared Sensing System</b>	
Sensing Range	0.6 - 16 ft (0.2 - 5 m)
Operating Environment	Surface with diffuse reflection material, and reflectivity > 8% (such as wall, trees, humans, etc.)
<b>Downward Vision System</b>	

Velocity Range	≤ 22.4 mph (36 kph) at 6.6 ft (2 m) above ground
Altitude Range	0 - 33 feet (0 -10 m)
Operating Range	0 - 33 feet (0 -10 m)
Sensing Range	1 - 43 feet (0.3 - 13 m)
Operating Environment	Surfaces with a clear patterns and adequate lighting (lux > 15)
<b>Camera</b>	
Sensor	1/2.3" CMOS Effective pixels:12 Megapixels
Lens	83.6° FOV, 25.2 mm (35 mm format equivalent) f/2.8 Focus from 1 m to ∞
ISO Range	100-3200 (video); 100-1600 (photo)
Electronic Shutter Speed	0.5 - 1/8000 s
Max Image Size	4000 x 2944
Still Photography Modes	Single shot Burst shooting: 3/5 frames Auto Exposure Bracketing (AEB):: 3 bracketed frames at 0.7EV Bias Interval (2/3/5/7/10/15/30/60 s)
Video Recording Modes	FHD: 1920 × 1080P30
Video Storage Bitrate	24 Mbps
Supported File Systems	FAT32 (≤ 32 GB); exFAT (> 32 GB)
Photo	JPEG
Video	MP4 (MPEG-4 AVC/H.264)
Supported SD Cards	microSD™. Max capacity: 64GB Class 10 or UHS-1 rating required.
<b>Charger</b>	
Input	100-240V, 50/60Hz, 0.5A
Output	5V/3A, 9V/2A, 12V/1.5A
<b>Intelligent Flight Battery</b>	
Capacity	1480 mAh
Voltage	11.4V
Max Charging Voltage	13.05 V
Battery Type	LiPo 3S
Energy	16.87 Wh
Net Weight	Approx. 95 g
Operating Temperature	41° to 104° F (5° to 40° C)

### **FCC Compliance Notice**

This device complies with Part 15 of the FCC Rules. Operation is subject to the following two conditions: (1) This device may not cause harmful interference, and (2) This device must accept any interference received, including interference that may cause undesired operation.

Any changes or modifications not expressly approved by the party responsible for compliance could void the user's authority to operate the equipment.

This equipment has been tested and found to comply with the limits for a Class B digital device, pursuant to part 15 of the FCC Rules. These limits are designed to provide reasonable protection against harmful interference in a residential installation. This equipment generates, uses and can radiate radio frequency energy and, if not installed and used in accordance with the instructions, may cause harmful interference to radio communications. However, there is no guarantee that interference will not occur in a particular installation. If this equipment does cause harmful interference to radio or television reception, which can be determined by turning the equipment off and on, the user is encouraged to try to correct the interference by one or more of the following measures:

- Reorient or relocate the receiving antenna.
- Increase the separation between the equipment and receiver.
- Connect the equipment into an outlet on a circuit different from that to which the receiver is connected.
- Consult the dealer or an experienced radio/TV technician for help.

### **RF Exposure Information**

This MM1A complies with FCC radiation exposure limits set forth for an uncontrolled environment. In order to avoid the possibility of exceeding the FCC radio frequency exposure limits, human proximity to the antenna shall not be less than 20cm during normal operation.

### **ISED RSS Warning**

This device complies with ISED licence-exempt RSS standard (s). Operation is subject to the following two conditions: (1) this device may not cause interference, and (2) this device must accept any interference, including interference that may cause undesired operation of the device. Le présent appareil est conforme aux CNR d'ISED applicables aux appareils radio exempts de licence.

L'exploitation est autorisée aux deux conditions suivantes:

- (1) l'appareil ne doit pas produire de brouillage, et
- (2) l'utilisateur de l'appareil doit accepter tout brouillage radioélectrique subi, même si le brouillage est susceptible d'en compromettre le fonctionnement.

### **ISED Radiation Exposure Statement:**

This equipment complies with ISED RF radiation exposure limits set forth for an uncontrolled environment. This transmitter must not be co-located or operating in conjunction with any other antenna or transmitter.

This MM1A should be installed and operated with minimum distance 20cm between the radiator & your body.

Cet appareil est

conforme aux limites d'exposition de rayonnement RF ISED établies pour un environnement non contrôlé.

Cet émetteur ne doit pas être co-implanté ou fonctionner en conjonction avec toute autre antenne ou transmetteur.

MM1A doit être installé et utilisé avec une distance minimale de 20cm entre le radiateur & votre corps.

#### **KCC Warning Message**

“ 해당 무선설비는 운용 중 전파혼신 가능성이 있으므로 인명안전과 관련된 서비스는 할 수 없습니다.”

“ 해당 무선설비는 운용 중 전파혼신 가능성이 있음”

#### **NCC Warning Message**

低功率電波輻射性電機管理辦法

第十二條 經型式認證合格之低功率射頻電機，非經許可，公司、商號或使用者均不得擅自變更頻率、加大功率或變更原設計之特性及功能。

第十四條 低功率射頻電機之使用不得影響飛航安全及干擾合法通信；經發現有干擾現象時，應改善至無干擾時方得繼續使用。前項合法通信，指依電信法規定作業之無線電通信。低功率射頻電機須忍受合法通信或工業、科學及醫療用電波輻射性電機設備之干擾。

EU Compliance Statement: SZ DJI TECHNOLOGY CO., LTD. hereby declares that this device is in compliance with the essential requirements and other relevant provisions of the Directive 2014/53/EU.

A copy of the EU Declaration of Conformity is available online at [www.dji.com/euro-compliance](http://www.dji.com/euro-compliance)

Declaración de cumplimiento UE: SZ DJI TECHNOLOGY CO., LTD. por la presente declara que este dispositivo cumple los requisitos básicos y el resto de provisiones relevantes de la Directiva 2014/53/EU.

Hay disponible online una copia de la Declaración de conformidad UE en [www.dji.com/euro-compliance](http://www.dji.com/euro-compliance)

EU-verklaring van overeenstemming: SZ DJI TECHNOLOGY CO., LTD. verklaart hierbij dat dit apparaat voldoet aan de essentiële vereisten en andere relevante bepalingen van Richtlijn 2014/53/EU.

De EU-verklaring van overeenstemming is online beschikbaar op [www.dji.com/euro-compliance](http://www.dji.com/euro-compliance)

Declaração de conformidade da UE: A SZ DJI TECHNOLOGY CO., LTD. declara, através deste documento, que este dispositivo está em conformidade com os requisitos essenciais e outras disposições relevantes da Diretiva 2014/53/EU.

Existe uma cópia da Declaração de conformidade da UE disponível online em [www.dji.com/eurocompliance](http://www.dji.com/eurocompliance)

Dichiarazione di conformità UE: SZ DJI TECHNOLOGY CO., LTD. dichiara che il presente dispositivo è conforme ai requisiti essenziali e alle altre disposizioni rilevanti della direttiva 2014/53/EU.

Una copia della dichiarazione di conformità UE è disponibile online all'indirizzo Web [www.dji.com/eurocompliance](http://www.dji.com/eurocompliance)

Déclaration de conformité UE: Par la présente, SZ DJI TECHNOLOGY CO., LTD déclare que cet appareil est conforme aux principales exigences et autres clauses pertinentes de la directive européenne 2014/53/EU.

Une copie de la déclaration de conformité UE est disponible sur le site [www.dji.com/euro-compliance](http://www.dji.com/euro-compliance)

EU-Compliance: Hiermit erklärt SZ DJI TECHNOLOGY CO., LTD., dass dieses Gerät den wesentlichen Anforderungen und anderen einschlägigen Bestimmungen der EU-Richtlinie 2014/53/EU entspricht. Eine Kopie der EU-Konformitätserklärung finden Sie online auf [www.dji.com/euro-compliance](http://www.dji.com/euro-compliance).



EU contact address: DJI GmbH, Industrie Strasse. 12, 97618, Niederlauer, Germany

CAUTION: RISK OF EXPLOSION IF BATTERY IS REPLACED BY AN INCORRECT TYPE. DISPOSE OF USED BATTERIES ACCORDING TO THE INSTRUCTIONS

#### Environmentally friendly disposal



Old electrical appliances must not be disposed of together with the residual waste, but have to be disposed of separately. The disposal at the communal collecting point via private persons is for free. The owner of old appliances is responsible to bring the appliances to these collecting points or to similar collection points. With this little personal effort, you contribute to recycle valuable raw materials and the treatment of toxic substances.

#### Thailand Warning Message

เครื่องโทรคมนาคมและอุปกรณ์นี้ มีความสอดคล้องตามข้อกำหนดของ กทช.