

DJI GOGGLES

Racing Edition

Quick Start Guide

V1.0

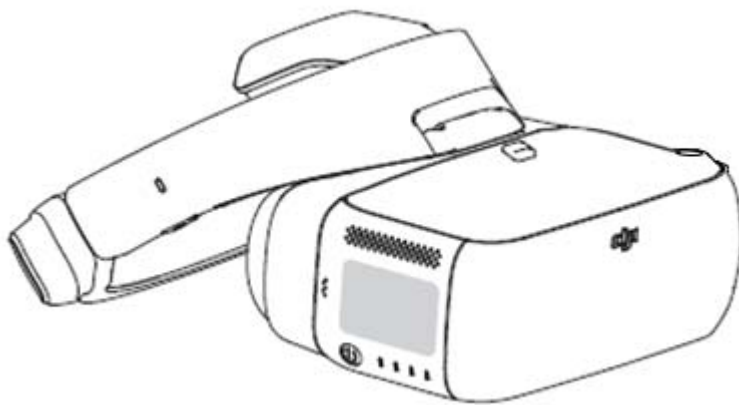

DJI Goggles Racing Edition

DJI Goggles Racing Edition (hereafter abbreviated as “DJI Goggles”)are equipped with high-performance displays and an ultra-low latency video downlink for use with DJI™ aircraft, giving you a real-time aerial First Person View (FPV) experience. DJI Goggles can also be used to display HD videos, bringing you an immersive high-definition viewing experience. DJI Goggles support head tracking, allowing aircraft and gimbal to be controlled using head movements, introducing a new style of flying.*

The DJI Goggles Racing Edition features the advanced OCUSYNC™ video transmission, supporting both the Analog Video Downlink and 2.4 / 5.8GHz dual-band Digital Video Downlink, providing a high video downlink performance with as low as 50ms latency and up to 2km transmission distance, a variety of Antennas can be used for more application scenarios. For third-party racing aircraft, DJI OcuSync Air Unit can be used directly with DJI Goggles to provide you with a camera, video transmission, controls and displays integrated, high-quality racing flight experience.

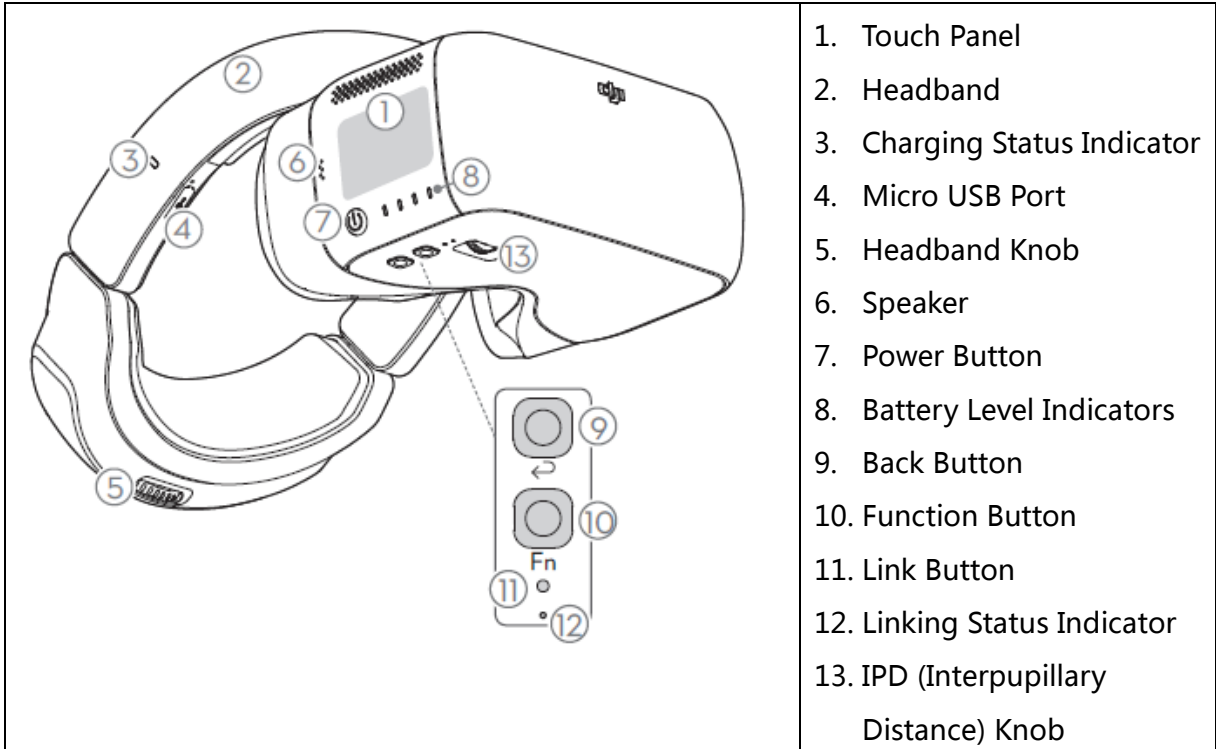

1. Touch Panel
2. Headband
3. Charging Status Indicator
4. Micro USB Port
5. Headband Knob
6. Speaker
7. Power Button
8. Battery Level Indicators
9. Back Button
10. Function Button
11. Link Button
12. Linking Status Indicator
13. IPD (Interpupillary Distance) Knob

14. Lens
15. Proximity Sensor
16. Headband Buckle
17. Heat Vent
18. Micro SD Card Slot
19. 3.5 mm Audio Port
20. HDMI Type-D Port
21. Speaker
22. SMA Antenna Port

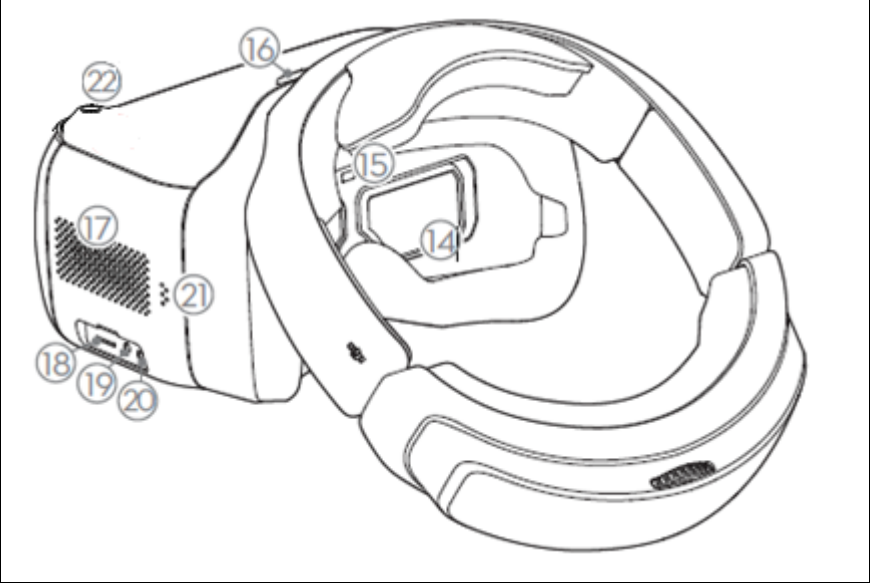



1. Camera Port
Connect with the DJI OcuSync Camera. Note that both this port and the camera connector plug are customize Type-C interface and they are not compatible with third-party equipment.
2. SBUS Port
Connect with the 3 in 1 Cable(power, S.Bus, UART), and connect to power, flight controller and the OSD port based on the sequence below.
RED: Power
BLACK: Power GND
GRAY: UART RX(Connects toOSD)
WHITE: UART TX (Connects toOSD)
BROWN: GND
YELLOW: SBUS(Connects toFlight Controller RX)
3. Micro SDCard Slot
Insert Micro SD Card to store the video recorded.

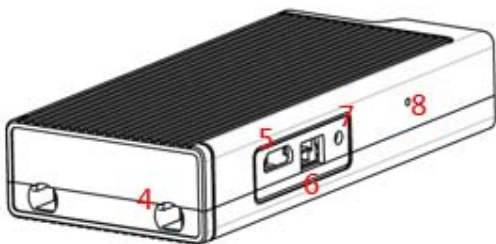

4. Antenna Ports
Used to attach the Air Unit antennas.
5. Micro USB Port
Connects to your PC for firmware upgradesthrough the DJI Assistant 2.
6. PPM Port
Connects to the aircraft' s gimbal with the PPM Cable to control the aircraft or gimbal by DJI Goggles. (supported later)
7. Link Button
Press this button to link the DJI OcuSync Air Unit with the DJI Goggles.
8. Linking Status Indicator
Indicate the linking status of the DJI OcuSync Air Unit and the DJI Goggles.

Module Connections

Analog Video Downlink

Install the pagoda antenna (SMA interface) to the SMA Port of DJI Goggles directly.

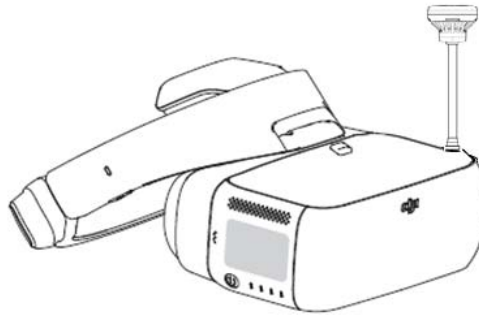

The provided pagoda antenna (SMA interface) also support two-way digital transmission. A directional antenna with higher gain can be used for better analogue transmission performance,.

Digital Video Downlink

When using the Digital Video Downlink, In addition to install the pagoda antenna (SMA interface) to the SMA Port of DJI Goggles, you will also need to install the DJI OcuSync Air System on a third-party racing aircraft to work with DJI Goggles. Refer to the below connection illustration and then mount the modules onto the aircraft.

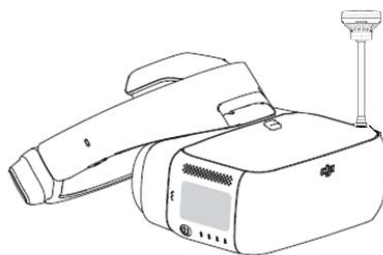

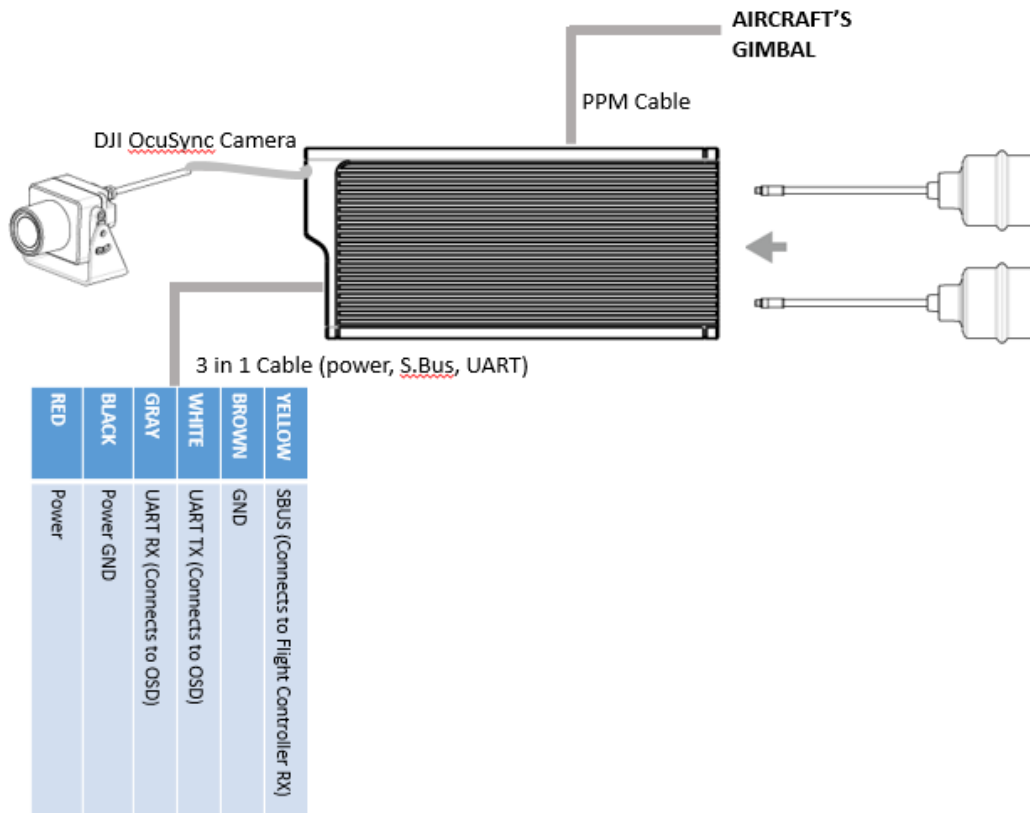

- It is recommended to use a lighter dipole antenna within a short distance flight, while a pagoda antenna (SMA interface) or a cylindrical antenna is recommended when the flight distance is 100 m or more.
- It is recommended to mount the DJI OcuSync Air Unit with its screw side facing down.
- The SBUS Port and the PPM Port on the Air Unit are only used when transmitting the remote control signal, these ports are not need to be connected if only video downlink is used.



- Place the two antennas on the Air Unit in a mutually vertical manner and with at least 30mm apart. Note that avoiding good conductor

	block at the antenna level, and keep the bottom of the antenna from the good conductor (cable, carbon fiber frame, battery and metal, etc.) at least 25mm.
--	--

You can connect the coach port of a third-party remote controller and the audio port on DJI Goggles through the coach cable to transmit the control signal to the racing aircraft when using the Digital Video Downlink

Installation and Wearing

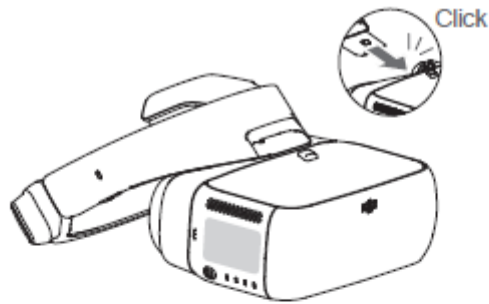

Insert the Headband Buckle into the slot above the DJI Goggles body.

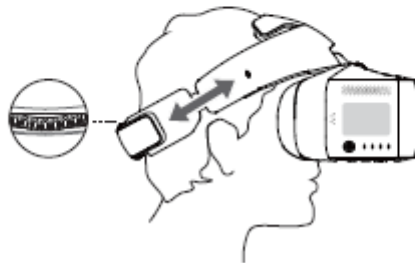

Wear the DJI Goggles and adjust the Headband.



Adjust interpupillary distance.

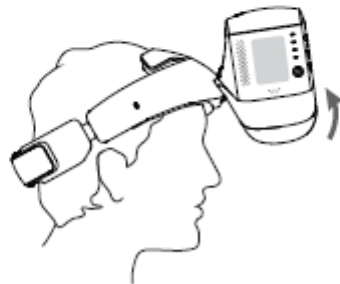

Flip the DJI Goggles body to see outside.

Check the Battery Level and Charging

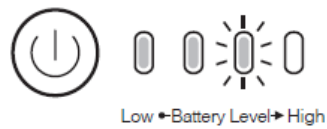

Press once to check the battery level.

Press once, then again and hold to turn on/off.

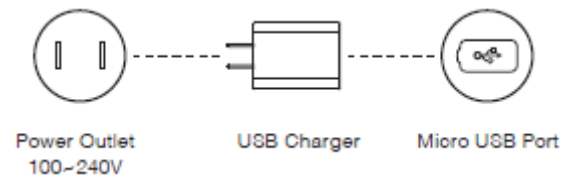







The Battery is fully charged when the Charging Status Indicator or the BatteryLevel Indicators turn off.

Charge time: ~ 4 hours Maximum run-time: ~ 6 hours

Activation and Connection

First-time activation is required before using your new DJI Goggles.

Ensure all devices are powered on and that the Aircraft is linked with the Remote Controller. Make sure both are updated to the latest firmware versions.

MAVIC™Series 	INSPIRE™ 2 PHANTOM™ 4 Series SPARK™**	INSPIRESeries PHANTOM 4 PRO+ PHANTOM 4 ADVANCED+	Video Play Device 
			
OCUSYNC™	Micro USB cable	HDMI cable	HDMI cable
Press the Link Buttons on the Mavic Pro and DJI Goggles, or enter Tools > Setting > Linking Setting to connect.	* Prepare an OTG cable and connect it to the Micro USB port of the remote controller.	Live view only.	

Activate with
DJI GO™ 4 App

Please update the app first. DJI Assistant 2 can also be used for activation.

Activate with
DJI ASSISTANT™ 2

Download: www.dji.com/dji-goggles

DJI Assistant 2 supports Windows 7 (or later) or OS X 10.11 (or later).







Connect DJI Goggles to your PC with Micro USB cable, then run DJI Assistant 2 to activate.

Follow the steps below to link with the third-party racing aircraft.

1. Power on the DJI OcuSync Air Unit, press the link button on the air unit with an appropriate tool when the linking status indicator is solid green, the indicator will turn solid red when the air unit is waiting for linking.
2. Power on the DJI Goggles, directly press the link button with an appropriate tool in the main menu, or swipe downward with two fingers on the touch panel to enter the shortcut menu and select RacingDrone (Digital)> Linking Settings.

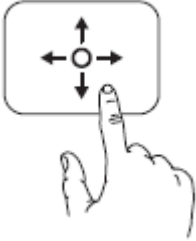
- Make sure the distance between DJI Goggles and the Air Unit is within 2m, both the two linking status indicators will turn solid green when successfully linked, and the video will be normally displayed.

Controls

		
<p>Single Finger Touch / 5D Button*</p> <ul style="list-style-type: none"> Swipe to scroll on the menu Tap to confirm 	<p>Two Fingers Touch</p> <ul style="list-style-type: none"> Swipe forward/backward to unlock/ lock the touch panel Swipe upward/downward to exit/enter the shortcut menu 	<p>Somatic Control</p> <p>DJI Goggles support head tracking, allowing aircraft and gimbal to be controlled using head movements. Multi Intelligent Flight Modes are also supported.</p>
		
<p>Back Button / C2 Button*</p> <p>Press to return to the previous menu, or exit the current Intelligent Flight Mode.</p>	<p>Function Button / C1 Button*</p> <p>Press to show the focus cursor, swipe forward/backward with one finger to zoom in or zoom out. Move your head then tap the touch panel to define the focus point.</p>	<p>Only support:</p> <p>MAVIC Series</p> <p>Spark</p> <p>Phantom 4 Series</p> <p>Inspire 2</p>
<p>* When connected with Mavic series aircraft, the 5D, C1, and C2</p>		
<p>buttons on the remote controller will be used to control the DJI Goggles and their original function is disabled.</p>		

Specifications

Model	DJI Goggles:G1P ; DJI OcuSync Air Unit:OAS1
Weight (Typical)	DJI Goggles Body: 495 g Headband: 500 g
Dimensions	Lenses: 195×155×110 mm Strap(Folded): 255×205×92 mm
Screen Size	5 inch×2
Screen Resolution	3840 × 1080 (single screen: 1920 × 1080)
Communication Frequency	2.4GHz/ 5.8GHz
Transmitter Power (EIRP)	<p>DJI Goggles</p> <p>2.4 GHz: 31 dBm (FCC); 19 dBm (SRRC)</p> <p>5.8 GHz: 26 dBm (FCC); 19 dBm (SRRC)</p> <p>DJI OcuSync Air Unit</p> <p>2.4 GHz: 26 dBm (FCC); 19 dBm (SRRC)</p> <p>5.8 GHz: 26 dBm (FCC); 23 dBm (SRRC)</p>
Live View Modes	1080p30 , 960p50 , 720p60 , 480p50
Battery Capacity	9440 mAh
Operating Temperature Range	32° to 104° F (0° to 40° C)
Charger	Input: 100-240 VAC, 50 / 60 Hz, 0.5 A Output: 5 V ■ 3 A / 9V ■ 2A / 12 V ■ 1.5 A

DJI OcuSync Air Unit CE frequency band:

Operating Frequency Band (RF) :	2.4G
	10M: 2405.5-2477.5MHz(TX/RX)
	20M: 2410.5-2472.5MHz(TX/RX)
	5.8G
	10M: 5730.5-5844.5MHz(TX/RX)
	20M: 5735.5-5839.5MHz(TX/RX)
Max. Of Transmit power:	2.4G
	10M: 18.72dBm
	20M: 18.88dBm
	5.8G
	10M: 12.71dBm 20M:12.80dBm

Compliance Information

SAR tests are conducted using standard operating positions accepted by the FCC/ISED with the goggles transmitting at its highest certified power level in all tested frequency bands, although the SAR is determined at the highest certified power level, the actual SAR level of the goggles while operating can be well below the maximum value.

Before a new model goggles is available for sale to the public, it must be tested and certified to the FCC/ISED that it does not exceed the exposure limit established by the FCC/ISED. Tests for each goggles are performed in positions and locations (e.g. at the ear and worn on the body) as required by the FCC/ISED.

For body worn operation, this model goggles has been tested and meets the FCC/ISED RF exposure guidelines when used with an accessory designated for this product or when used with an accessory that contains no metal.

Non-compliance with the above restrictions may result in violation of RF exposure guidelines.

This equipment has been tested and found to comply with the limits for a Class B digital device, pursuant to Part 15 of the FCC Rules. These limits are designed to provide reasonable protection against harmful interference in a residential installation. This equipment generates, uses and can radiate radio frequency energy and, if not installed and used in accordance with the instructions, may cause harmful interference to radio communications. However, there is no guarantee that interference will not occur in a particular installation.

If this equipment does cause harmful interference to radio or television reception, which can be determined by turning the equipment off and on, the user is encouraged to try to correct the interference by one or more of the following measures:

- Reorient or relocate the receiving antenna.
- Increase the separation between the equipment and receiver.
- Connect the equipment into an outlet on a circuit different from that to which the receiver is connected.
- Consult the dealer or an experienced radio/TV technician for help.

For OcuSync Air Unit, the equipment complies with FCC radiation exposure limits set forth for an uncontrolled environment. This equipment should be installed and operated with minimum distance 20cm between the radiator & your body.

RSS Regulatory Statement

This device complies with ISED license-exempt RSS standard(s). Operation is subject to the following two conditions:

- (1) this device may not cause interference, and
- (2) this device must accept any interference, including interference that may cause undesired operation of the device.

Le présent appareil est conforme aux CNR d'Industrie Canada applicables aux appareils radio exempts de licence. L'exploitation est autorisée aux deux conditions suivantes :

- (1) l'appareil ne doit pas produire de brouillage, et
- (2) l'utilisateur de l'appareil doit accepter tout brouillage radioélectrique subi, même si le brouillage est susceptible d'en compromettre le fonctionnement.

EU Compliance Statement: SZ DJI TECHNOLOGY CO., LTD. hereby declares that this device is in compliance with the essential requirements and other relevant provisions of the RED Directive.

A copy of the EU Declaration of Conformity is available online at www.dji.com/euro-compliance

Declaración de conformidad: SZ DJI TECHNOLOGY CO., LTD. por la presente declara que este dispositivo cumple los requisitos básicos y el resto de provisiones relevantes de la Directiva.

Hay disponible online una copia de la Declaración de conformidad UE en www.dji.com/euro-compliance

EU-verklaring van overeenstemming: SZ DJI TECHNOLOGY CO., LTD. verklaart hierbij dat dit apparaat voldoet aan de essentiële vereisten en andere relevante bepalingen van Richtlijn.

Een kopie van de EU-Verklaring van Overeenstemming is beschikbaar op www.dji.com/euro-compliance

Declaração de conformidade da UE: A SZ DJI TECHNOLOGY CO., LTD. declara, através deste documento, que este dispositivo está em conformidade com os requisitos essenciais e outras disposições relevantes da Diretiva.

Existe uma cópia da Declaração de Conformidade da UE disponível online em www.dji.com/euro-compliance

Dichiarazione di conformità UE: SZ DJI TECHNOLOGY CO., LTD. dichiara che il presente dispositivo è conforme ai requisiti essenziali e alle altre disposizioni rilevanti della direttiva.

Una copia della Dichiarazione di Conformità UE è disponibile online su www.dji.com/euro-compliance

Déclaration de conformité UE: Par la présente, SZ DJI TECHNOLOGY CO., LTD. déclare que cet appareil est conforme aux principales exigences et autres clauses pertinentes de la directive européenne.

Une  est placé sur cet appareil. Pour plus d'informations, visitez www.dji.com/euro-compliance

EU-Compliance: Hiermit erklärt SZ DJI TECHNOLOGY CO., LTD., dass dieses Gerät den wesentlichen Anforderungen der EU-Richtlinie entspricht. Eine WEEE-Symbol ist auf dem Gerät angebracht. Weitere Informationen sind auf www.dji.com/euro-compliance.

EU contact address: DJI GmbH, Industriestrasse. 12, 97618, Niederlauer, Germany.

Environmentally friendly disposal



Old electrical appliance must not be disposed of together with the residual waste, but have to be disposed of separately. The disposal at the communal collection point via private person is for free. The owner of old appliance is responsible to bring the appliances to these collecting point or to similar collection points. With this little personal effort, you contribute to recycle valuable raw materials and the treatment of toxic substances.

KCC Warning Statement

(1)

이 기기는 가정용으로 전자파 적합 등록을 한 기기로서 주거지역에서는 물론 모든 지역에서 사용할 수 있습니다.

(2) 당해 무선설비는 전파 혼신 가능성이 있으므로 인명 안전과 관련된 서비스는 할 수 없음.

NCC Warning Statement

根據 NCC 低功率電波輻射性電機管理辦法規定:

(1) 第十二條經型式認證合格之低功率射頻電機，非經許可，公司、商號或使用者均不得擅自變更頻率、加大功率或變更原設計之特性及功能。

(2) 第十四條低功率射頻電機之使用不得影響飛航安全及干擾合法通信；經發現有干擾現象時，應立即停用，並改善至無干擾時方得繼續使用。

前項合法通信，指依電信法規定作業之無線電通信。

低功率射頻電機須忍受合法通信或工業、科學及醫療用電波輻射性電機設備之干擾。

NBTC Warning Statement

เครื่องโทรคมนาคมและอุปกรณ์นี้มีความสอดคล้องตามข้อกำหนดของกทช.

IFETEL Warning Statement

“La operación de este equipo está sujeta a las siguientes dos condiciones: (1) es posible que este equipo o dispositivo no cause interferencia perjudicial y (2) este equipo o dispositivo debe aceptar cualquier interferencia, incluyendo la que pueda causar su operación no deseada.”

