

DJI CINESSD STATION(USB Port)

Quick Start Guide

V1.0 2016.10

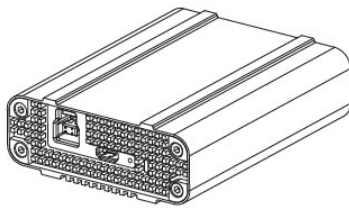

Disclaimer

Congratulations on purchasing your new DJI™ product. The information in this document affects your safety and your legal rights and responsibilities. Read this entire document carefully to ensure proper configuration before use. Failure to read and follow instructions and warnings in this document may result in serious injury to yourself or others, damage to your DJI product, or damage to other objects in the vicinity. This document and all other collateral documents are subject to change at the sole discretion of DJI.

By using this product, you hereby signify that you have read this disclaimer and warning carefully and that you understand and agree to abide by the terms and conditions herein. You agree that you are solely responsible for your own conduct while using this product, and for any consequences thereof. You agree to use this product only for purposes that are proper and in accordance with all applicable laws, rules, and regulations, and all terms, precautions, practices, policies and guidelines DJI has made and may make available.

DJI accepts no liability for damage, injury or any legal responsibility incurred directly or indirectly from the use of this product. The user shall observe safe and lawful practices including, but not limited to, those set forth in this document. Notwithstanding above, your statutory rights under applicable national legislation are not affected by this disclaimer.

DJI is a trademark of SZ DJI TECHNOLOGY CO., LTD. (abbreviated as “DJI”) and its affiliated companies. Names of products, brands, etc., appearing in this document are trademarks or registered trademarks of their respective owner companies. This product and document are copyrighted by DJI with all rights reserved. No part of this product or document shall be reproduced in any form without prior written consent of or authorization from DJI.

Warning

1. Only use regulated cables specified in this guide.
2. Only use genuine DJI parts or parts certified by DJI. Unauthorized parts or parts from non-DJI-certified manufacturers may cause system malfunctions and compromise safety.
3. Ensure the DJI CINESSD STATION and its components are free from contamination (e.g. water, oil, soil and sand).

Introduction

The DJI CINESSD STATION is used to export data from the DMAG.

Usage

Insert the DMAG into the DMAG Reader, then connect the DJI CINESSD STATION to a computer via a USB 3.0 cable. DJI CINESSD STATION supports external power supply and firmware update.

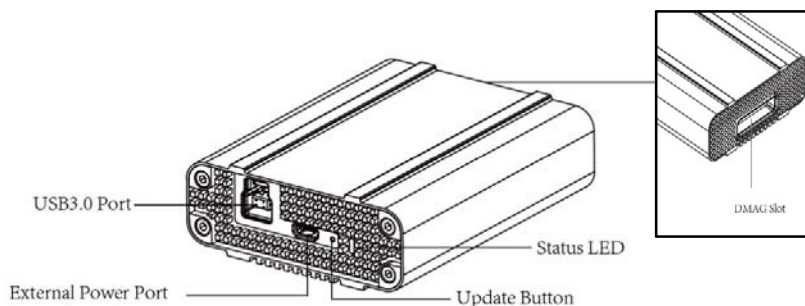

No other software is needed when exporting data from the DMAG. You may install the corresponding DJI software according to your operation preference:

- For Windows: Install DJI Camera Exporter.
- For Mac: Install DJI CineLight.

	<ol style="list-style-type: none"> 1. DJI CINESSD STATION supports USB 2.0. However, the DJI CINESSD STATION may not be able to work normally when connecting it to the computer via USB 2.0 cable without external power supply. 2. Ensure to insert the DMAG before connecting the DJI CINESSD STATION to the computer. 3. Ensure to uninstall the DJI CINESSD STATION before unplugging the cable after exporting data.
---	---

External Power Supply

Use external power supply when the capacity of the DMAG exceeds 480GB or the power supply capacity of computer is weak. Connect the DJI CINESSD STATION to the external power supply as shown below.

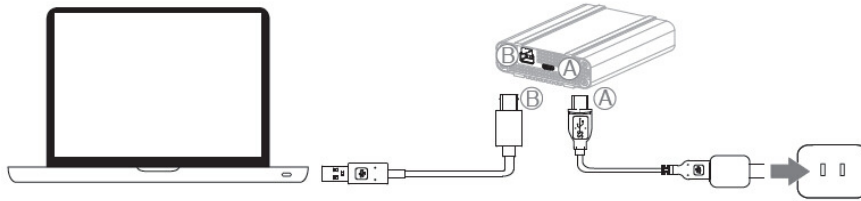

	<ol style="list-style-type: none"> 1. Ensure to connect the DJI CINESSD STATION to the external power supply before connecting it to the computer via a USB 3.0 cable, or the external power supply may not work. 2. The AC adapter should have a voltage higher than 5 V, and a current higher than 1 A.
---	---

Firmware Update

Connect the DJI CINESSD STATION to the computer to update its firmware.

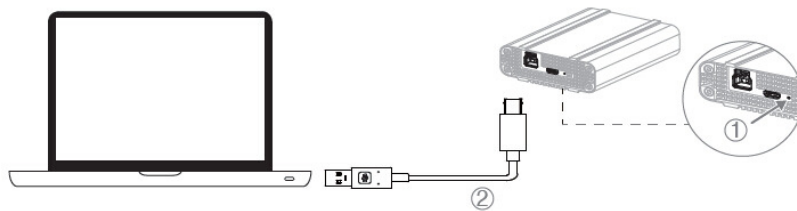

	<p>To activate firmware update, please press the update button down when connecting the DJI CINESSD STATION to the computer via a USB 3.0 cable.</p>
---	--

LED Description

LED Status	Description
Solid Green	Connecting to the computer
Solid Yellow	Ready to update firmware
Blinking Green	Exporting data

Specifications

Size	90 mm×71.2 mm×27.5 mm
Weight	246 g
Operation Temperature Range	0° to 40° C

Compliance Information

FCC Warning

This device complies with Part 15 of the FCC Rules. Operation is subject to the following two conditions: (1) This device may not cause harmful interference, and (2) This device must accept any interference received, including interference that may cause undesired operation.

Any changes or modifications not expressly approved by the party responsible for compliance could void the user's authority to operate the equipment.

NOTE: This equipment has been tested and found to comply with the limits for a Class B digital device, pursuant to part 15 of the FCC Rules. These limits are designed to provide reasonable protection against harmful interference in a residential installation. This equipment generates, uses and can radiate radio frequency energy and, if not installed and used in accordance with the instructions, may cause harmful interference to radio communications. However, there is no guarantee that interference will not occur in a particular installation. If this equipment does cause harmful interference to radio or television reception, which can be determined by turning the equipment off and on, the user is encouraged to try to correct the interference by one or more of the following measures:

- Reorient or relocate the receiving antenna.
- Increase the separation between the equipment and receiver.
- Connect the equipment into an outlet on a circuit different from that to which the receiver is connected.
- Consult the dealer or an experienced radio/TV technician for help.