

CO230 specification

Type of document : SPECIFICATIONS

SAGEM SA

Conclusion or summary:

This document gives an overview of the CO230 module: a miniature, single-side, BGA board, quad-band GSM/GPRS module, ready for integration in mobile application like vehicle-mounted or vending machines ... It describes the main functionalities of this module as well as the electrical interfaces, the mechanical specification (dimension, form...) and the electrical specification of the module.

HARDWARE

CO230 specification

For mobile applications

Ref. : SCT TMO MASV3 SPEC 30 Rev : I

02/11/04

Ref. Sec. 2x xxx xxx – x
:

CO230

GSM/GPRS QUAD BAND BCE MODULE FOR MOBILE APPLICATIONS

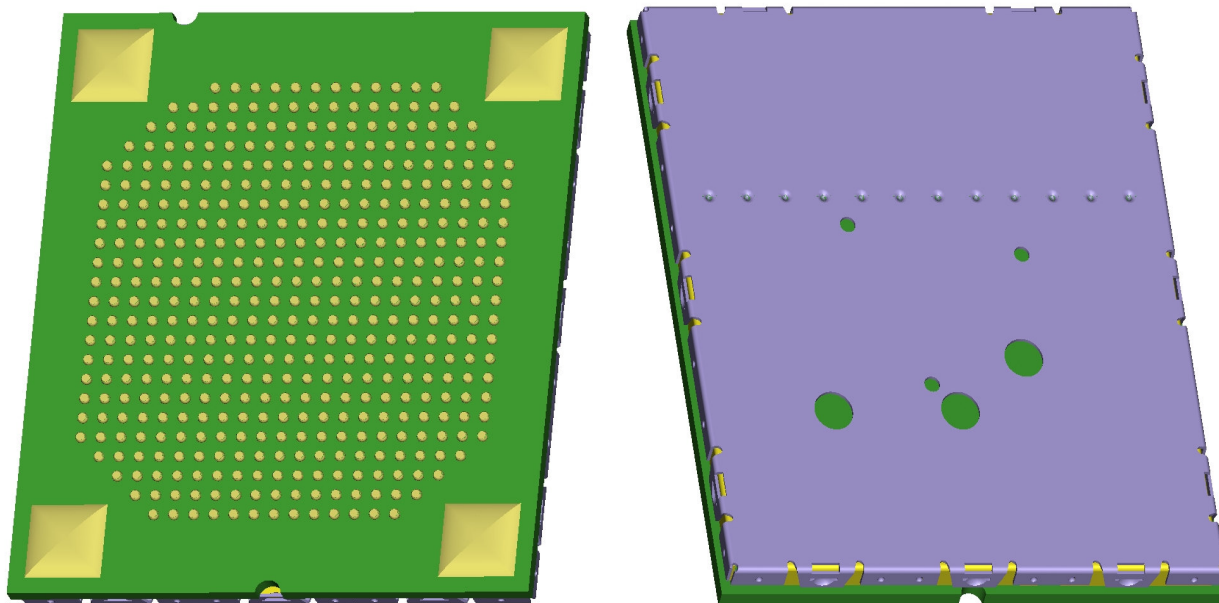

CHANGE HISTORY

Rev.	Date	Reason for change
A	12/07/03	First document
B	15/07/03	LCD addressable, electrical specification, vibrating device interface description, LED interface, audio interface, keyboard interface modification, melody chip interface description, Blue tooth interface description
C	07/10/03	Pinout modification, electrical specification, LED and backlight capability
D	14/11/03	Pinout Modification, LCD and Keyboard Backlight suppression
E	27/01/04	Charge precision, VBAT limitation, OEMEM* signal
F	06/04/04	End of preliminary specification
G	07/05/04	Power consumption
H	14/09/04	Pull up / Pull down, certification clarifications
I	02/11/04	certification clarifications

TABLE OF CONTENTS

1.	SCOPE.....	5
1.1	Introduction.....	5
1.2	Reference.....	5
1.3	Standards compliance.....	5
1.4	compliance with fcc guidelines.....	6
1.5	Terms and abbreviation.....	6
1.6	Product features.....	7
2.	BLOC DIAGRAM.....	10
3.	FUNCTIONAL DESCRIPTION.....	10
3.1	SIM.....	10
3.2	Audio.....	12
3.3	Display.....	13
3.3.1	Serial interface.....	13
3.3.2	Parallel interface to LCD.....	14
3.4	Data.....	15
3.4.1	Data services.....	15
3.4.2	IrDA.....	15
3.4.3	UART 2.....	15
3.4.4	V24.....	15
3.4.5	USB.....	16
3.5	Antenna.....	16
3.6	Keypad.....	16
3.7	Video sensor.....	16
3.7.1	I2C interface.....	17
3.7.2	Parallel interface to sensor.....	17

3.8	External companion chip interface	17
3.8.1	I2S interface	17
3.8.2	Parallel interface to companion chip	17
3.9	Blue tooth (optional)	21
3.9.1	MCSI interface.....	21
3.9.2	UART interface.....	22
3.9.3	Clock.....	22
3.10	Melody generation	22
3.11	DAI	22
3.12	Clocks	22
3.13	Power management and charge	22
3.13.1	Battery	22
3.13.2	VRIO.....	23
3.13.3	Vbackup	23
3.13.4	Charge.....	23
3.14	Accessories	23
3.14.1	Flap.....	23
3.14.2	Network LED	23
3.14.3	Vibrating device	24
4.	OPERATING MODES	25
4.1	Modes description	25
4.1.1	No supply	25
4.1.2	OFF	25
4.1.3	Active.....	25
4.1.4	Standby	25
4.2	Transitions description	25
4.2.1	Power_on	25
4.2.2	Power_off	26
4.2.3	Switch_on.....	26
4.2.4	Switch_off.....	26
4.2.5	Wake up	26
5.	BALL-OUT	27
6.	ELECTRICAL SPECIFICATION	33
6.1	VBAT	33
6.2	VRIO	34
6.3	DAI interface.....	34
6.4	Network LED	34
6.5	Serial interface for LCD.....	34
6.6	Keyboard interface	34
6.7	Vibrating device control.....	35
6.8	V24	35
6.9	IRDA and UART2	35
6.10	Reset	35
6.11	Spare IO	35
6.12	Clocks	36
6.13	Parallel interface for companion chip.....	36
6.14	Parallel interface for LCD	36
6.15	USB interface	37
6.16	MMC interface	37
6.17	Video sensor interface	37
6.18	MCSI interface	37
6.19	I2S interface.....	38
6.20	I2C interface.....	38
6.21	JTAG interface	38
6.22	ADC	38
6.23	Interrupts	38

6.24	VBACKUP	39
7.	ENVIRONMENTAL SPECIFICATION	39
7.1	Operating conditions	39
7.2	Climatic conditions	39
8.	MECHANICAL SPECIFICATION	40
9.	ANNEXE	43

DRAFT

1. SCOPE

1.1 INTRODUCTION.

This document gives an overview of the CO230 module: a miniature, single-side, BGA board, quad-band GSM/GPRS module, ready for integration in mobile application like vehicle-mounted or vending machines...

It describes the main functionalities (GPRS / GSM 850MHz / GSM 900MHz / DCS 1800MHz / PCS 1900MHz, interface to a melody chip, LCD interface, SIM interface, vibrating device interface, audio interfaces for speaker/microphone or accessories, battery interface, battery charging interface, USB interface, SD card interface, Sensor interface ...) of this module as well as the electrical interfaces, the mechanical specification (dimension, form...) and the electrical specification of the module.

1.2 REFERENCE.

1.3 STANDARDS COMPLIANCE

- GSM 02.60: "Digital cellular telecommunications system (Phase 2+); Stage 1 Service Description of the General Packet Radio Service (GPRS)". Version 6.3.0.
- GSM 03.03: "Digital cellular telecommunications system (Phase 2+); Numbering, addressing and identification". Version 6.6.0.
- GSM 03.13: "Digital cellular telecommunications system (Phase 2+); Discontinuous Reception (DRX) in the GSM system". Version 6.0.0.
- GSM 03.60: "Digital cellular telecommunications system (Phase 2+); General Packet Radio Service (GPRS); Service description; Stage 2". Version 6.7.0.
- GSM 03.64: "Digital cellular telecommunications system (Phase 2+); General Packet Radio Service (GPRS); Overall description of GPRS radio Interface; Stage 2". Version 6.4.0.
- GSM 04.02: "Digital cellular telecommunications system (Phase 2+); GSM Public Land Mobile Network (PLMN) access reference configuration". Version 6.0.0.
- GSM 04.03: "Digital cellular telecommunications system (Phase 2+); Mobile Station - Base Station System (MS - BSS) interface Channel structures and access capabilities". Version 6.0.0.
- GSM 04.04: "Digital cellular telecommunications system (Phase 2+); Layer 1 General requirements". Version 6.0.0.
- GSM 04.05: "Digital cellular telecommunications system (Phase 2+); Data Link (DL) layer General aspects". Version 6.0.1.
- GSM 04.07: "Digital cellular telecommunications system (Phase 2+); Mobile radio interface signalling layer 3 General aspects". Version 6.5.1.
- GSM 04.08: "Digital cellular telecommunications system (Phase 2+); Mobile radio interface layer 3 specification". Version 6.11.0.
- GSM 04.60: "Digital cellular telecommunications system (Phase 2+); General Packet Radio Service (GPRS); Radio Link Control/Medium Access Control (RLC/MAC) protocol". Version 6.9.0.
- GSM 04.64: "Digital cellular telecommunications system (Phase 2+); General Packet Radio Service (GPRS); Logical Link Control (LLC)". Version 6.7.0.
- GSM 04.65: "Digital cellular telecommunications system (Phase 2+); General Packet Radio Service (GPRS); Mobile Station (MS) - Serving GPRS Support Node (SGSN); Sub network Dependent Convergence Protocol (SNDTCP)". Version 6.7.0.
- GSM 05.02: "Digital cellular telecommunications system (Phase 2+); Multiplexing and multiple access on the radio path". Version 6.9.0.
- GSM 05.03: "Digital cellular telecommunications system (Phase 2+); Channel coding". Version 6.2.1.
- GSM 05.08: "Digital cellular telecommunications system (Phase 2+); Radio subsystem link control". Version 6.8.0.

DRAFT

- GSM 05.10: "Digital cellular telecommunications system (Phase 2+); Radio subsystem synchronisation". Version 6.6.0.
- GCF-CC (V.3.12.0) and GT.01.
- NAPRD.03 (V.2.10.1).

1.4 COMPLIANCE WITH FCC GUIDELINES

Fix-mount and mobile devices incorporating CO230 modules must be designed to maintain a minimum separation distance of 20 cm between the antenna and the end user to satisfy RF exposure requirements for mobile transmitting devices.

1.5 TERMS AND ABBREVIATION

ADC	Analog to Digital Converter
ADPCM	Adaptive Delta Pulse Code Modulation
AFC	Application Frequency Correction
ASIC	Application Specific Integrated Circuit
BMP	Bitmap
CODEC	Coder-Decoder
CTS	Clear To Send
DAC	Digital to Analog Converter
DAI	Digital Analog Interface
DCS	Digital
DSP	Data Signal Processor
DSR	Data Set Ready
DTR	Data Terminal Ready
EGSM	Enhanced GSM
EMS	Enhanced Messaging Services
ESD	Electrostatic Discharge
ETS	European Telecommunication Standard
GSM	Global Standard for Mobile communication
GPRS	Global Packet Radio Services
IC	Integrated Circuit
IEEE	Institute of Electrical and Electronics Engineers
I/O	Input / Output
IRDA	Infra Red
ISO	International Standards Organisation
ITU	International Telecommunication Union
JPEG	Joint Picture Expert Group
JTAG	Joint Test Action Group
KBPS	Kbit per second
LCD	Liquid Crystal Display
LED	Diode
LNA	Low Noise Amplifier
MBPS	Mbit per second
MIDI	Musical Instrument Digital Interface
MMI	Man Machine interface
PA	Power Amplifier
PBCCH	Packet Broadcast Channel
PCB	Printed Circuit Board
PCS	Personal Communication System
PLL	Phase Locked Loop
PNG	Portable Network Graphics
RAM	Random Access Memory
RF	Radio Frequency
RI	Ring Indication

DRAFT	
RMS	Root Mean Square
RTS	Ready To Send
RX	Receive direction
SIM	Subscriber Identification Module
SMS	Short Message Service
SRAM	Static Random Access Memory
TBC	To Be Confirmed
TBD	To Be Defined
TX	Transmit direction
UART	Universal Asynchronous Receiver and Transmitter
USB	Universal Serial Bus
USSD	Unstructured Supplementary Service Data
VCO	Voltage Controlled Oscillator
WAP	Wireless Application Protocol
WBMP	Wide Bitmap

1.6 PRODUCT FEATURES

Temperature range	Normal range: -10 °C to +55 °C (fully compliant) Extended range: -20 °C to -10 °C and +55 °C to +70 °C (functional without any risk for the network) Storage: -40 °C to +85 °C
Weight (in g)	10g
ESD	ESD protected, < 1kv or 2kv (see application note)
Physical dimensions	33x38x3.3 mm (typical)
Connection	BGA type connection (including antenna and battery connection)
Power supply	3.45V to 4.5V range, 3.8V nominal.
Power consumption	Off mode: 80uA (typ) Standby mode: 2mA (typ) Communication mode: 260mA (GSM/DCS à Pmax) 2.2A (GSM peak during TX slot)
Battery charge management and interface	Battery charge management is included for regulated charger to 600mA maximum charge current. Specific un-regulated charger qualified by SAGEM could be used (see application note).
Antenna connection	No antenna included in the module. Antenna connection is included in the BGA ball-out. See recommendations for connection.
Frequency bands	GSM 850MHz + EGSM900 + DCS1800 + PCS1900
Voice codecs	Half Rate, Full Rate, Enhanced Full Rate
GSM class	Small MS
Transmit power	Class 4 (2W) for GSM 850MHz EGSM900 Class 1 (1W) for DCS1800 / PCS1900
Supported SIM card	3V SIM cards. To prevent SIM card's damages, the power supply of the module has to be turned off before any manipulation of the SIM card.
SIM slot	Not included on the module. Signals for the management of the SIM card are provided on ball-out.
Vibrating device	Not included in the module. Control is provided on ball-out.

DRAFT

Keyboard / LCD backlight / network LED (GB)	GB LED management. Interface to external backlight and RGB component.
Audio up-link	2x2 differential inputs are provided for microphone (accessories and handset).
Audio down-link non stereo	3x2 differential outputs are provided for non stereo earphone (accessories and 6 ohms and 32 ohms).
Audio down-link stereo	3 outputs are provided for stereo earphone (accessories and handset).
Flap open/closed detection	IO5 dedicated for Flap.
Keyboard interface	6x6 keyboard interface is provided on ball-out.
UART1 interface with flow control	Up to 115.2 Kbaud with auto bauding. Full flow control signals (+2.8V) are provided on ball-out. <u>If a full compliant RS232 (+/-5V) serial interface is needed:</u> The drivers (like MAX3232, ST3237CD, ...) are not included in the module and have to be added on the main PCB. A proven schematic to build the RS232 interface is provided in application note.
IrDA interface or UART2 interface	Up to 115.2 Kbaud. UART2 and IrDA are not multiplexed but could not be used at the same time.
Data services	GPRS, CSD, Fax
Supplementary services	Line identification, Call Waiting, Call Hold, Call Forwarding, Multiparty, Closed User Group, Call Barring, Advice of Charge, USSD
USB interface	USB 1.1 (slave only) is provided on ball-out.
Melody chip interface	The melody chip is not integrated in the module but the interface is provided (power supply, clock, analog audio, serial link, I2S) on ball-out.
Serial Interface	A serial interface is provided on ball-out in order to manage an external LCD or a chip melody.
Companion chip Interface	A parallel interface (16 bits) is provided on ball-out (3 addresses, 1 chip select, OE and RW signals are available) to connect external companion chip for additional multimedia application.
LCD parallel interface	A parallel interface (8bits) is provided on ball-out (2 chip select, RW, RS, ESTRB, RESET) to connect LCDs up to 256K colours.
MMC interface for SD card only	MMC interface is available on ball-out (power supply not provided) for SD card only.
Video sensor interface	Video sensor interface is provided on ball-out (parallel interface with 8 bit, clock in, clock out, horizontal synchronisation, vertical synchronisation, reset, standby, I2C interface) to connect VGA sensor (power supply not provided).
Blue tooth interface (optional)	Blue tooth chipset not included in the module but the interface (MCSI, Clock 26MHz and UART) is available on ball-out. Blue tooth chipset management is optional.
Reset pin	Active high signal available (reset of all the system including backup).
Power on pin	Available

DRAFT

General purpose I/Os pin	4 I/O available on ball-out.
GPRS	SMG 31bis, Multi slot class 10, class B terminal, PBCCH support
GSM/DCS certification GCF-CC	V.3.12.0 and GT.01
PCS certification	NAPRD.03 (V.2.10.1)
Multimedia objects download	Ring tones, wallpapers, icons, games, screen savers

DRAFT

2. BLOC DIAGRAM

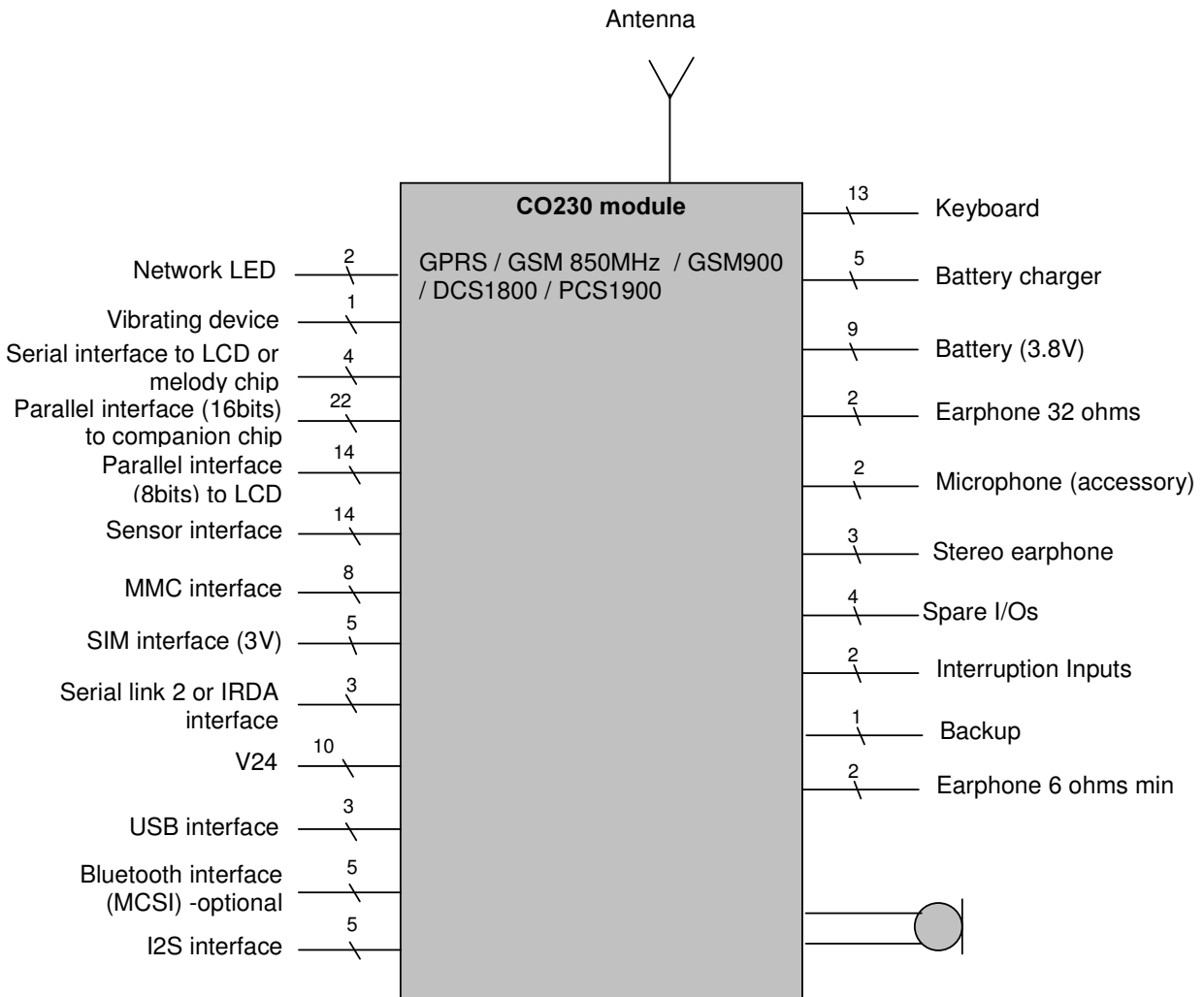

Figure 1
CO230 bloc diagram

See Ball-out chapter for more details.

3. FUNCTIONAL DESCRIPTION

3.1 SIM

The SIM Card interface is compatible with the ISO 7816-3 IC card standard on the issues required by the GSM 11.11 Phase 2+ standard. The module also supports Release 99 of the SIM Toolkit recommendation and supports a Fixed Dialling Number directory.

The SIM Card interface insures the detection (SIMCD), the power on (SIMVCC) of the SIM Card and the communication with it through a data signal (SIMIO), a clock signal (SIMCLK) and a reset signal (SIMRST).

DRAFT

Signal	Pin N°	Description
SIMRST	T8	SIM reset, provided by Base-band processor
SIMCLK	T9	SIM clock, provided by Base-band processor
SIMIO	T10	SIM serial data line, input and output
SIMVCC	T7	SIM supply voltage
SIMCD	B12	SIM insertion detection

SIM card connection:

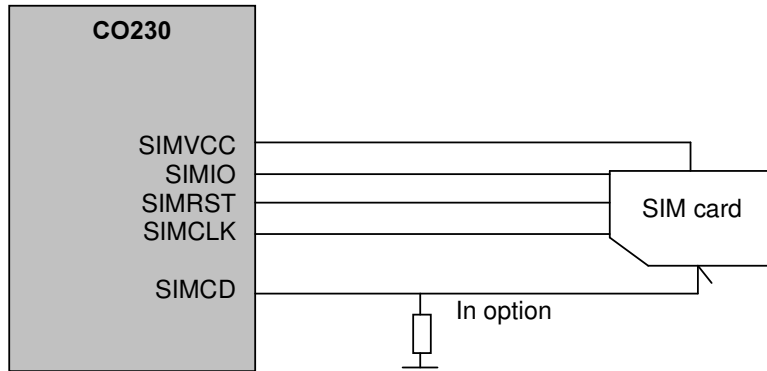

*Figure 2
SIM connection*

The SIMCD signal should be connected to the SIM card reader in order to get SIMCD at low level (GND) when no card is present and at high level (SIMVCC) when card is present (external pull down needed when SIM card connector with detection is used).

This interface includes main protections.

DRAFT

3.2 AUDIO

The module supports the following voice codecs:

- Half-Rate
- Full-Rate
- Enhanced Full Rate

It manages an external handset microphone (MICIP/MICIN) and an external handset earphone (32 ohms HPP32/HPN32 and 6 ohms HPP8/HPN8) in differential mode.

The bias voltage of the microphone is provided directly on MICIP/MICIN pins (1.5V).

There are two options for the earphone:

- Two earphones, one 32 Ohms as earpiece and one 6 Ohms minimum as Ring/melody and as hands-free loudspeaker if it is far from the microphone.
- one 32 Ohms earphone as earpiece.

The module can also manage accessories (earphone and microphone) through dedicated lines (HSMICIP/HSMICIN for microphone and HSOL/HSGND/HSOR for stereo earphone). The typical impedance for the earphone is 150ohms.

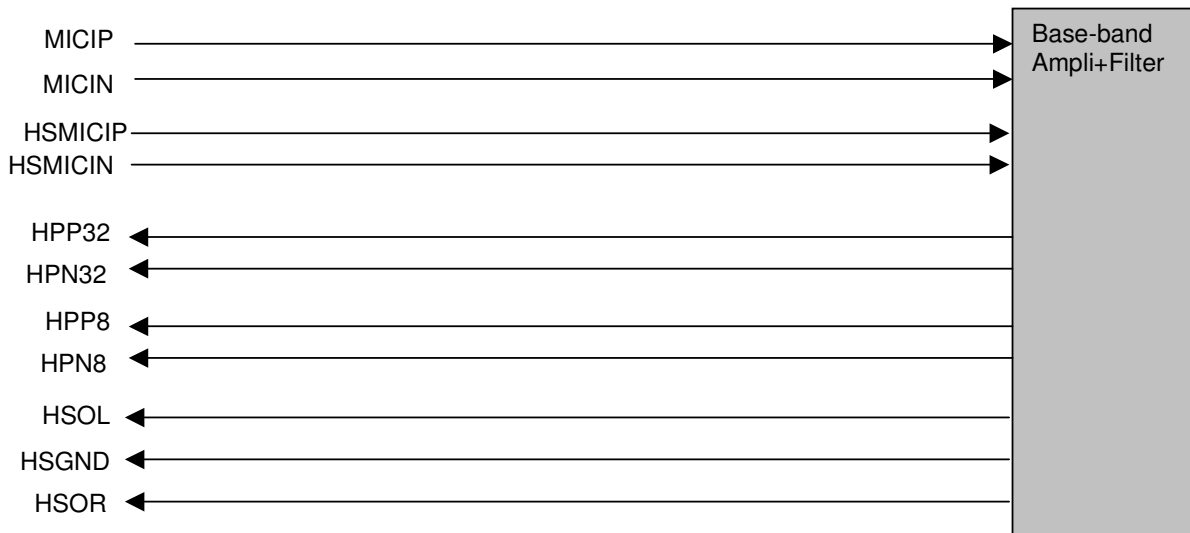

*Figure 3
Audio*

This interface includes main protections.

To ensure proper operation of such sensitive signals, they have to be isolated from the other by ground on mother board layout.

NB: To avoid destruction of module components, the HP inductance has to be 47nH +/- 5% @ 200MHz

DRAFT

3.3 DISPLAY

3.3.1 Serial interface

A serial interface is provided on the module to manage an external LCD (256 colours) through data input signal (DIMIW), data output signal (DOMIW), clock (CKMIW) and chip select (CSMIW1*). Power supply of the LCD (VRIO) is also provided through this interface.

This interface could be used to manage one serial LCD or one melody chip (or other chipset using this interface).

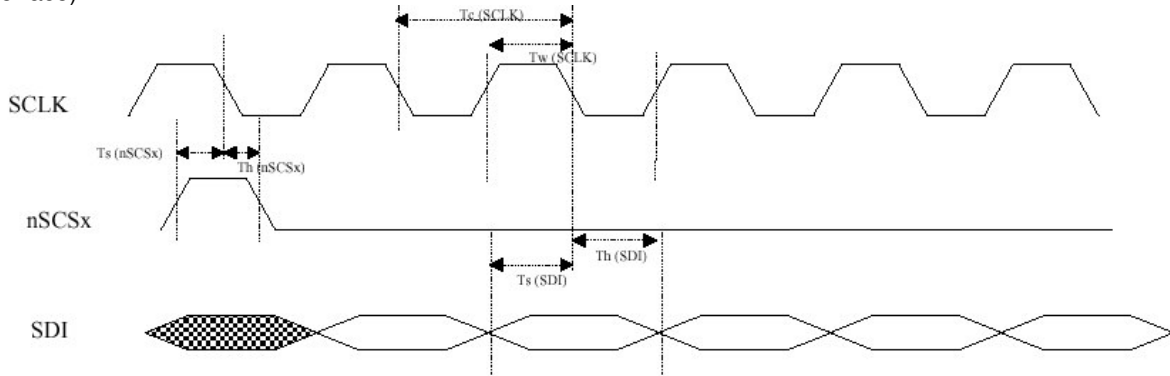

Figure 4
Serial link receive timing

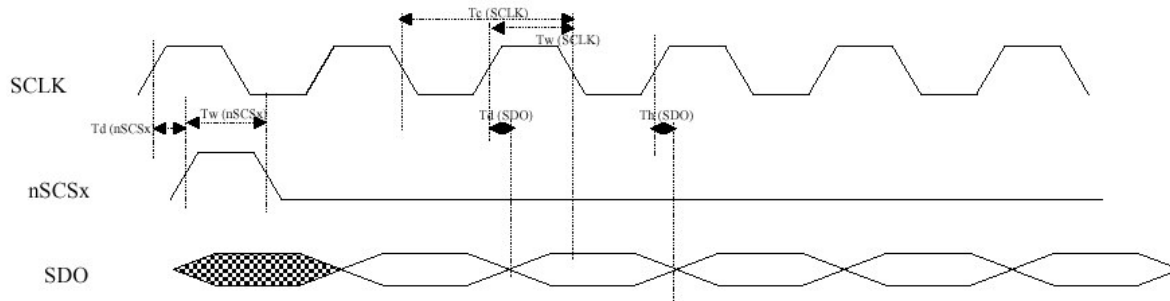

Figure 5
Serial link transmit timing

Timing	Description	Min (ns)	Max (ns)
$T_{w(SCLK)}$	Pulse duration, serial port clock	38	-
$T_{c(SCLK)}$	Cycle time, serial port clock	77	-
$T_{d(SDO)}$	Delay time, data valid after CLK falling	-	10
$T_{h(SDO)}$	Hold time, data valid after CLK falling	0	-
$T_{w(nSCSx)}$	Pulse duration, EN port	38	-
$T_{d(nSCSx)}$	Delay time, En after CLK rising	10	-
$T_{s(SDI)}$	Setup, data valid before CLK rising	15	-
$T_{h(SDI)}$	Hold time, data valid after CLK rising	15	-
$T_{s(nSCSx)}$	Setup, data valid before CLK falling	10	-
$T_{h(nSCSx)}$	Hold time, EN after CLK falling edge	10	-

This interface includes main protections.

DRAFT

If specific LCD driver is used, the software would be provided by SAGEM, or at least the specific drivers will be integrated by SAGEM. In that case a specific quotation is required.

3.3.2 Parallel interface to LCD

A parallel interface is provided on the module to manage an external LCD (up to 262K colours) with data bus (DLCD<0..7>), strobe enable (ESTRLCD), RWLCD*, RSLCD*, reset (RESETLCD*) and 2 chip select (CS1LCD*, CS0LCD*).

NB: 65K and 262K colour LCDs have to be configured in 8 bits multi access mode.

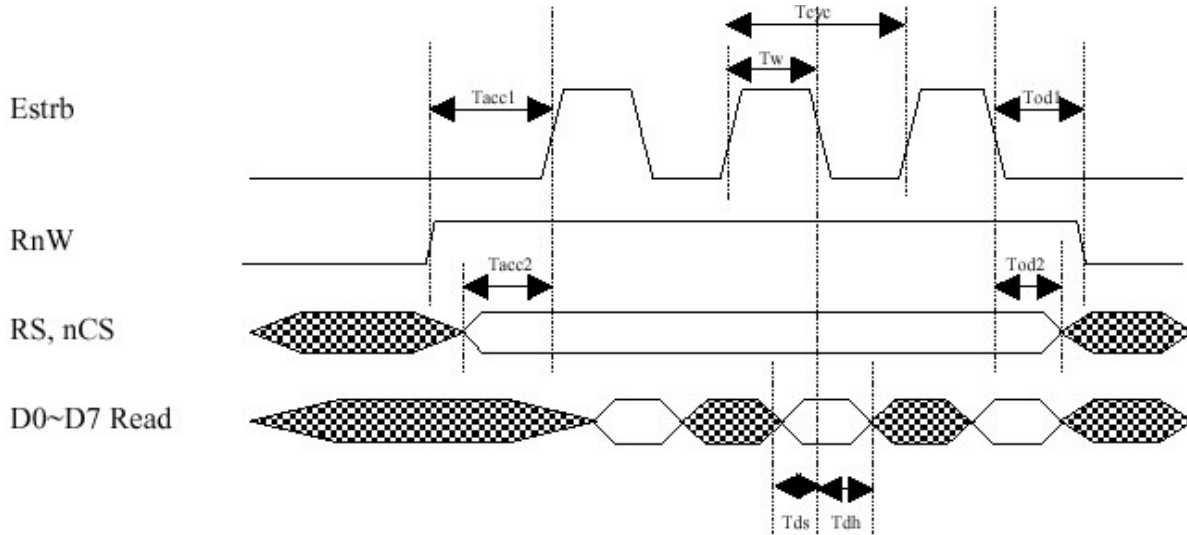

Figure 6
Read timing (in 6800 mode)

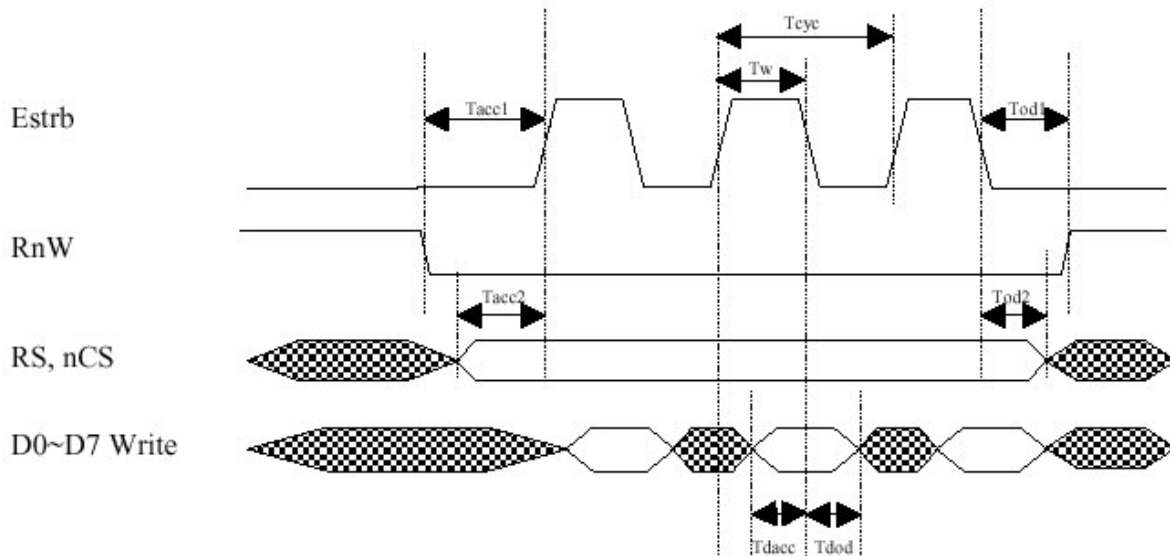

Figure 7
Write timing (in 6800 mode)

Timing	Description	Min (ns)	Max (ns)
$T_{w(LCD)}$	Pulse duration	38	-

DRAFT

T _{cvc}	Cycle time	77	-
T _{acc1}	Access time of RnW	-	10
T _{acc2}	Access time off RS, nCS	0	-
T _{od1}	Output delay of RnW	38	-
T _{od2}	Output delay of RS, nCS	10	-
T _{dacc}	Data access time	15	-
T _{dod}	Data output disable time	15	-
T _{ds}	Setup time of read data	10	-
T _{dh}	Hold time of read data	10	-

3.4 DATA

3.4.1 Data services

The module supports the following services:

- GPRS
- CSD: transparent and non-transparent up to 9600 BPS
- fax: class 1

Data sessions may be established over the main serial link, using the IrDA port (see below) or through the USB interface.

3.4.2 IrDA

This UART interface is compatible with 16C750 compliant devices. It includes the slow infra-red protocol in order to be connected with an infra-red transmitter to any external data peripherals with an IrDA compliant data interface.

This IrDA interface (TXIR, RXIR and CMDIRDA) provided by the module is compliant with the IrDA 1.0 SIR up to 115.2 Kbaud.

This interface could not be used at the same time as UART2 interface.

This interface includes main protections.

3.4.3 UART 2

It is strongly recommended to leave this interface externally accessible for Debug.

This interface could not be used at the same time as IRDA interface.

3.4.4 V24

A V24 interface is provided on external pins of the module with the following signals:

- RTS/CTS
- RX/TX
- DSR
- DTR
- DCD
- RI

It supports speeds up to 115.2 KBPS and may be used in auto bauding mode.

This interface includes main protections.

DRAFT

3.4.5 USB

CO230 provides an USB 1.1, slave only, with the following signals: differential data (USB_DP, USB_DM) and +5V input power supply (VCUSB).

3.5 ANTENNA

The antenna connexion is prived through the 'antenna' ball. This is a 50ohm RF connexion and as such must be connected to the antenna via a proper 50ohm line; the RF ground is provided by the 5 balls surrounding the antenna ball. A matching network might be required between the module antenna connexion and the actual antenna to further adapt the antenna impedance to the module. An example of connexion is provided in the application note together with some layout guidelines.

3.6 KEYPAD

A 6X6 keyboard could be managed by the module through the R1/R2/R3/R4/R5/R6 row signals and C1/C2/C3/C4/C5/C6 column signals.

OUI signal performs the ON function. OFF signals performs OFF function.

Multi-key pressing is possible with this keyboard configuration.

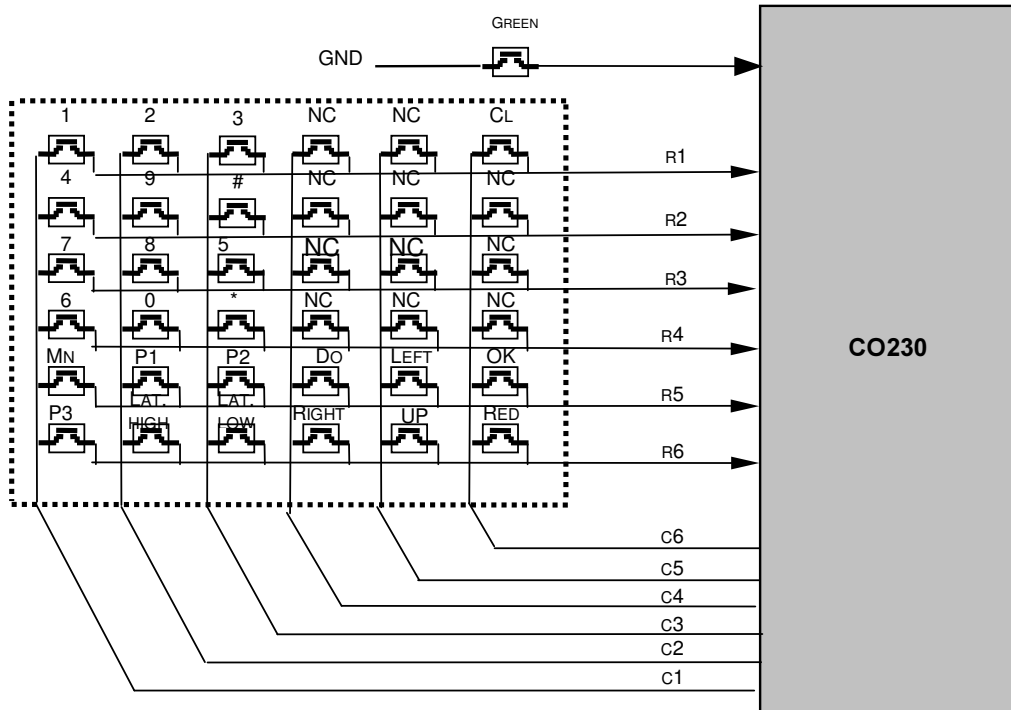

Figure 8
Keyboard connection

NC = these keys are connected internally in the CO230 module but are not managed.

The module uses the Tegic T9™ predictive input system.

3.7 VIDEO SENSOR

All the interfaces to connect a VGA video sensor are provided. Only power supply is not included.

DRAFT

3.7.1 I2C interface

A standard I2c interface is available on ball-out to send command to the video sensor.

3.7.2 Parallel interface to sensor

A dedicated parallel interface is provided on ball-out with 8 bits data bus (DCAM<0..7>), vertical synchronisation (VSCAM), horizontal synchronisation (HREF), input clock (PCLKCAM), configurable output clock (XCLKCAM), reset (RESETCAM), standby (STBYCAM).

3.8 EXTERNAL COMPANION CHIP INTERFACE

3.8.1 I2S interface

For audio transfer:

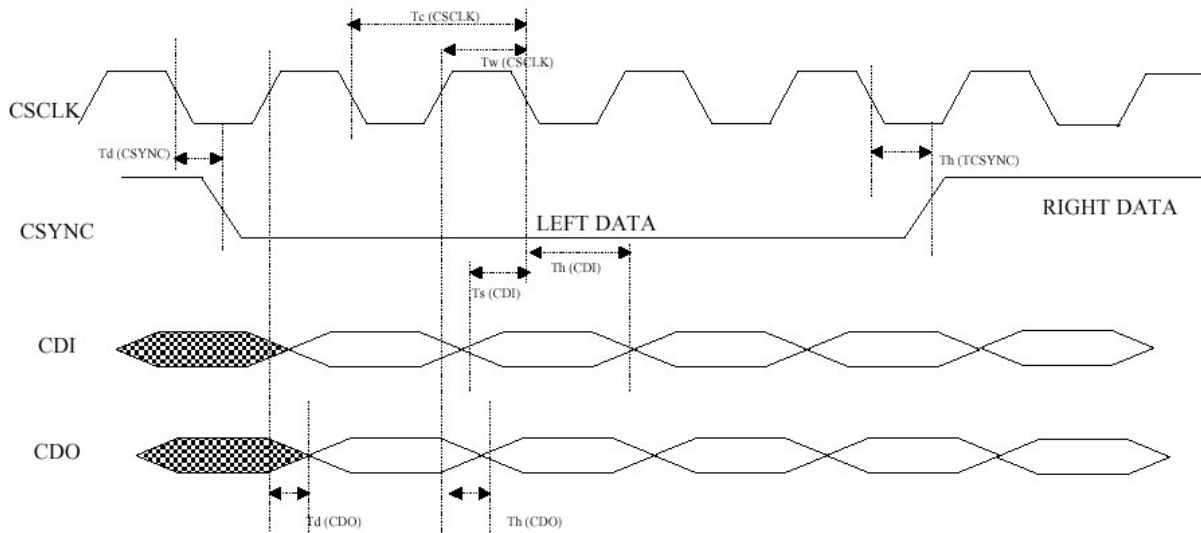

Figure 9
I2S timing

Timing	Description	Min (ns)	Max (ns)
$T_w(CSCLK)$	Pulse duration	651	-
$T_c(CSCLK)$	Cycle time	1302	-
$T_d(CDO)$	Delay time, data after CLK rising	-	15
$T_h(CDO)$	Hold time, data valid after CLK rising	5	-
$T_s(CDI)$	Setup, data valid before CLK falling	5	-
$T_h(CDI)$	Hold time, data valid after CLK falling	0	-
$T_d(CSYNC)$	Delay time, EN after CLK falling	-	3
$T_h(CSYNC)$	Hold time, EN after CLK falling	2	-

3.8.2 Parallel interface to companion chip

A parallel interface is provided on ball-out. This interface include 16 bits data lines (DPROC<0..15>), 3 address lines (APROC<1>, APROC<2>, APROC<3>), Write control signal RWPROC* (active low), Read control signal OEPROC* (active low) and one chip select CS1PROC* (active low). This interface is dedicated to external companion chip interface (as external DSP for additional multimedia applications). This interface supports page mode.

DRAFT

NB: The maximum capacitance acceptable on each signal of the parallel interface is 25pF (including copper line capacitance, connectors capacitance...).

DRAFT

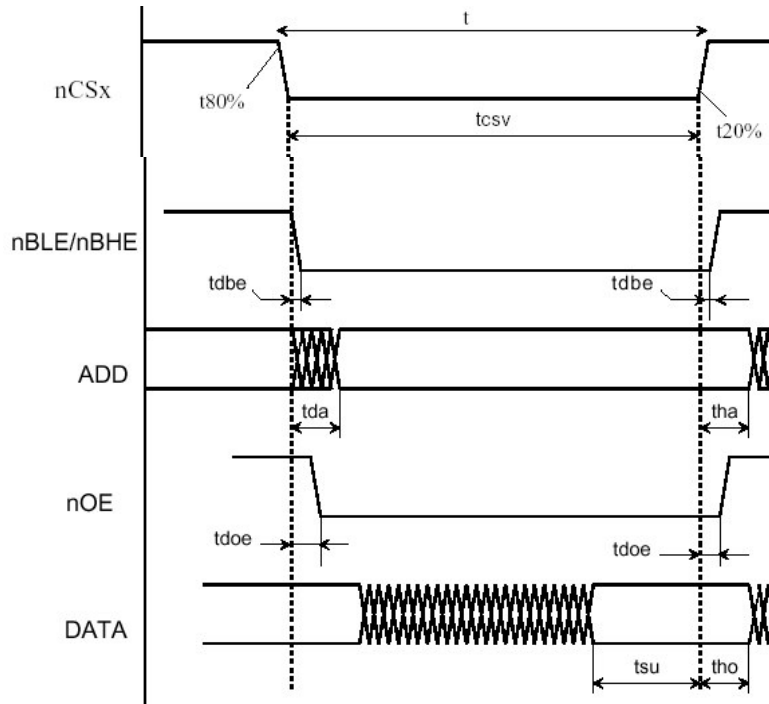

Figure 10
Parallel link read timing

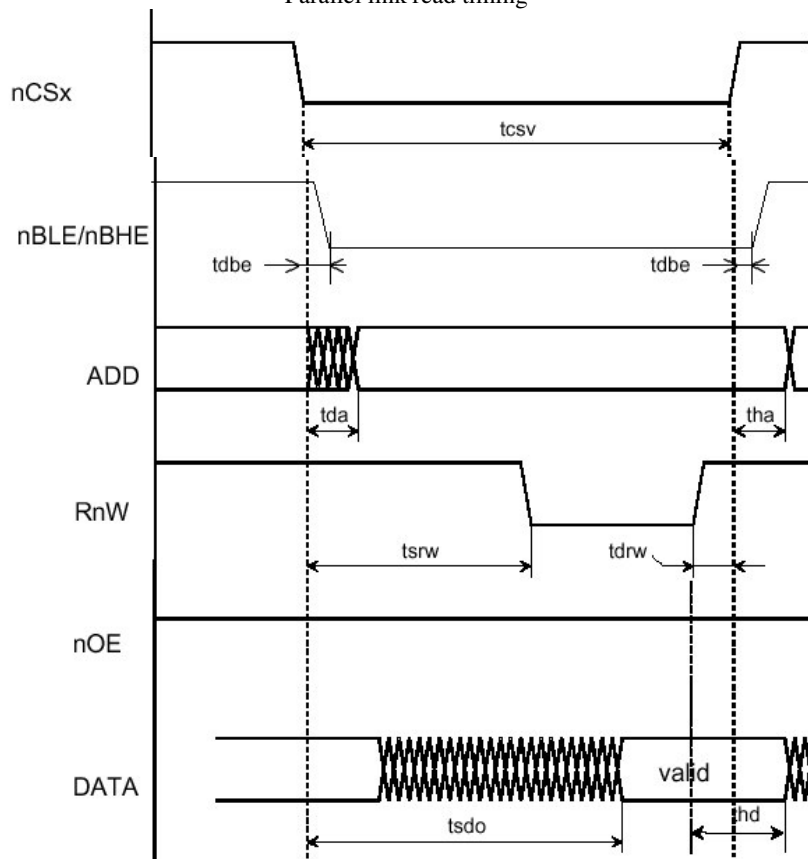

Figure 11
Parallel link write timing

DRAFT

Single access:

Timing	Description	Min (ns)	Max (ns)
t_{cvc}	CPU frequency	-	$1/F_{cpu}$
t_{csv}	Chip Select Valid	t_{cvc}	$(N+1)t_{cvc}$
t_{da}	NCS to Address valid	-	1.2
t_{ha}	Address hold from nCS	0	-
t_{dbe}	NBHE, nBLE to nCS	-	0.6
t_{doe}	NOE to nCS	-	0.6
t_{su}	Input data setup to nCS	5.5	-
t_{ho}	Input data hold from nCS	0	-
t_{srw}	NCS to RnW	$T_{cvc}/2 - t_{drw}$	-
t_{drw}	RnW to nCS	1.3	2.9
t_{dso}	NCS to output data valid	-	$T_{srw} + 7.5$
t_{hd}	Output data hold from RnW	0	-

N= Wait State number

Page mode access:

Timing	Description	Min (ns)	Max (ns)
t_{cvc}	CPU frequency	-	$1/F_{cpu}$
t_{csv}	Chip Select Valid	t_{cvc}	$(N+1)t_{cvc}$
t_{da}	NCS to Address valid	-	1.5
t_{ha}	Address hold from nCS	0	-
t_{dbe}	NBHE, nBLE to nCS	-	0.8
t_{doe}	NOE to nCS	-	1.5
t_{su1}	Input data setup to nCS	5.2	-
t_{ho1}	Input data hold from nCS	0	-
t_{su2}	Input data setup to nCS	5.6	-
t_{ho2}	Address invalid time	-	3
T_{sa1sa2}	Input data hold from nCS	0	-

Note: all timings computed for an external capacitance load of 10pF

NB: if needed, additional Wait State could be added by SAGEM.

Be careful: the maximum capacitance (components, lines, connectors,...) acceptable on each signal of the parallel bus is 25pF.

DRAFT

3.9 BLUE TOOTH (OPTIONAL)

All the interfaces to connect a blue tooth chipset are provided. Only power supply is not included. Blue tooth chipset management is optional.

3.9.1 MCSI interface

For audio transfer:

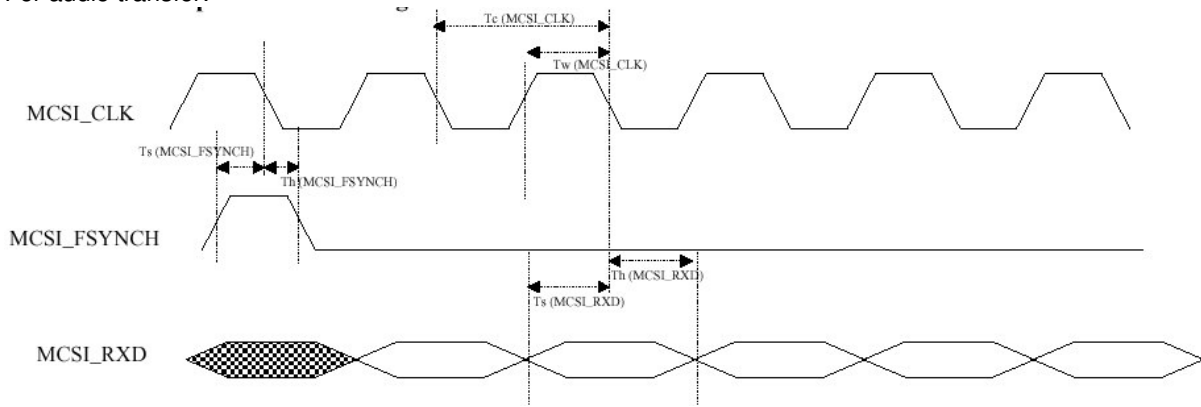

Figure 12
Blue tooth receive timing

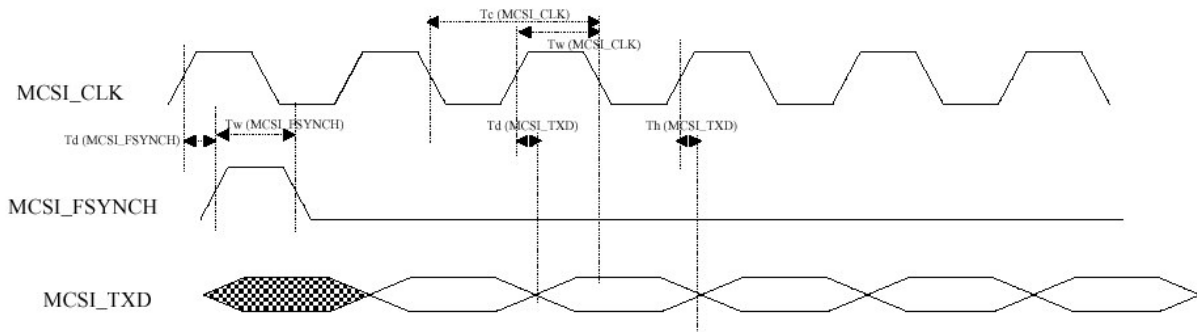

Figure 13
Blue tooth transmit timing

Timing	Description	Min (ns)	Max (ns)
$T_w(\text{MCSI_CLK})$	Pulse duration	77	-
$T_c(\text{MCSICLK})$	Cycle time	154	-
$T_d(\text{MCSI_DO})$	Delay time, data after CLK rising	-	10
$T_h(\text{MCSI_DO})$	Hold time, data valid after CLK rising	0	-
$T_d(\text{MCSI_FSYNCH})$	Delay time, EN after CLK falling	-	10
$T_w(\text{MCSI_FSYNCH})$	Pulse duration, EN after CLK falling	77	-
$T_s(\text{MCSI_DI})$	Setup, data valid before CLK falling	15	-
$T_h(\text{MCSI_DI})$	Hold time, data valid after CLK falling	15	-
$T_s(\text{MCSI_FSYNCH})$	Setup time, EN after CLK falling	10	-
$T_h(\text{MCSI_FSYNCH})$	Hold time, EN after CLK falling	10	-

DRAFT

3.9.2 UART interface

See UART interface from the V24 interface or from the IRDA interface.

3.9.3 Clock

26MHz clock could be used for clock input of blue tooth component (please note: 13MHz clock is also available on CO230 ball-out but is not compliant with blue tooth chipsets features).

3.10 MELODY GENERATION

An external melody chip could be connected to the CO230 module through the following links:

- I2S for audio transfer
- Microwire for command
- 13MHz for melody chip clocking

Please note: if the melody chip is connected to the microwire, no serial LCD could be connected.

All these interfaces are described in the previous chapters.

3.11 DAI

A DAI interface is provided on the module for type approval tests.

3.12 CLOCKS

A 32KHz frequency clock, a 13MHz frequency digital clock and a 26MHz frequency analogic clock are provided on external pins of the module.

The 13MHz clock could be used for the melody chip.

The 26MHz clock could be used for the blue tooth interface.

To ensure proper operation of such sensitive signals, they have to be isolated from the other by ground on mother board layout.

3.13 POWER MANAGEMENT AND CHARGE

3.13.1 Battery

The power supply signal VBAT is 3.45V to 4.5V range and 3.8V nominal.

Only Li-Ion battery are supported.

It has to be more than 3.2V, even during transients in order to avoid unwanted resets. The power supply dropout has to be limited to 450mV, when the current consumption goes from minimum to maximum (0.1 to 2A). The noise level of the power supply has to be limited to 50mV RMS in the 100MHz – 1MHz frequency range

SAGEM advises to use Sanyo or LG battery. If battery is used, SAGEM agreement is needed (slight qualification tests).

Only battery with 200mohms maximum internal resistor are managed by the module.

External capacitor of 47uF has to be added as near as possible from the battery connector of mother board for charge needs.

DRAFT

3.13.2 VRIO

+2.8V output is available on external pin of the module and could supply +2.8V external components (current capability 10mA in active mode).

This interface includes main protections.

3.13.3 Vbackup

External Backup could be supply through the VBACKUP input (from 2.2V to 3.2V). A internal mechanism is present to charge the backup battery.

If No external Backup is supplied, VBACKUP input has to be connected to VBAT signal.

3.13.4 Charge

This interface manages the charge for regulated charger, when a charger is connected, even in the following conditions: deeply discharged battery, short-circuited battery and unconnected battery (600mA with regulated charger).

The interface manages the charge of some un regulated chargers, that have to be qualified by SAGEM (see listing in application note).

This interface includes main protections.

3.14 ACCESSORIES

Accessories connection has to be defined more precisely.

With the CO230 module, the following accessories could be connected :

- a pedestrian stereo or non stereo hand-free kit
- a battery charger
- an automotive hand-free kit
- a data cable
- an USB cable

These interfaces includes main protections.

3.14.1 Flap

IO5 is dedicated for Flap detection.

3.14.2 Network LED

Commands for Green and Red LED are provided.

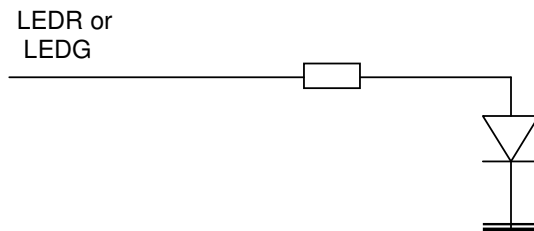

*Figure 14
 LED device connection*

DRAFT

3.14.3 Vibrating device

Vibrating device control is provided but external transistor is needed.

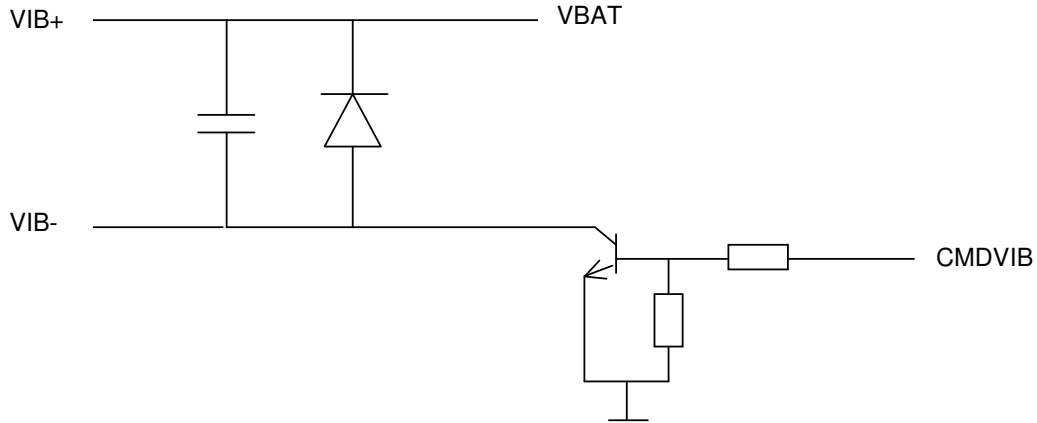

Figure 15
Vibrating device connection

DRAFT

4. OPERATING MODES

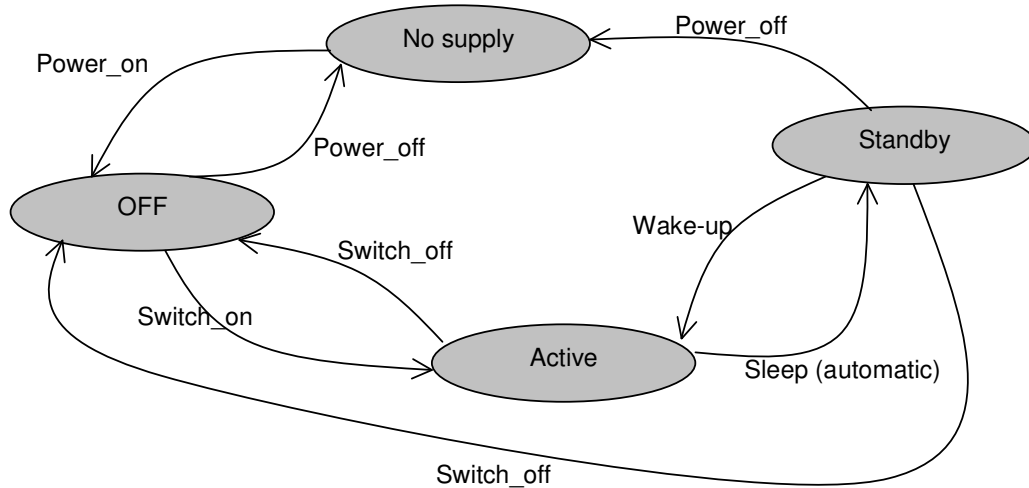

Figure 16
 Operating modes state diagram

4.1 MODES DESCRIPTION

4.1.1 No supply

VBAT < 3.2V and VBACKUP < 2.2V.
 All functions and power supplies are OFF: VRIO = 0.

4.1.2 OFF

VBAT > 3.2V or external Backup VBACKUP > 2.2V.
 The RTC only is running (32kHz). All other functions and power supplies are OFF: VRIO = 0.

4.1.3 Active

The module is active: all the functions are running and all the power supplies are ON and in full power mode (full consumption).
 VRIO = +2.8V

4.1.4 Standby

The module is in standby mode: the power supplies are ON and in low power mode.
 This mode is typically use when the module is connected to the network and checking periodically if there is an incoming call.

4.2 TRANSITIONS DESCRIPTION

4.2.1 Power_on

A battery is connected to the module with VBAT > 3.2V (and/or VBACKUP is switched ON).

DRAFT

4.2.2 Power_off

The battery is removed from the module (and/or VBACKUP is switched OFF).

4.2.3 Switch_on

The battery is already connected. The module starts when ON key is pressed or a charger is connected or when wake up occurs.

4.2.4 Switch_off

The battery is connected. The software is turning off of the module when OFF key is pressed and VBAT > 3.2V.

4.2.5 Wake up

The actions to go from standby mode to active mode are:

- Charger connection
- Key pressed
- Incoming call
- Data cable connection
- V24 activity

DRAFT

5. BALL-OUT

The following list of signals could change.

	1	2	3	4	5	6	7	8	9	10	11	12	13	14	15	16	17	18	19	20	21	22	23	
A					GND	GND	GND	GND	GND	GND	GND	GND	GND	GND	GND	GND	GND	GND	GND					
B				GND	TXD1	TXIR	RXD1	TXD2	RXD2	OUI*	SDAI2 C	SIMC D	POW MMC	CDMM C	DMMC <1>	DMMC <2>	DMMC <3>	EMU1*	GND	GND				
C			GND	DCAM <1>	CTS	DCAM <4>	CMDI RDA	DCAM <2>	DCAM <6>	PCLK CAM	SCLI2 C	CMDM MC	MCSI DI	TDIDI GIT	XCLK CAM	GND	TSPA CTEX T	EMU0*	GND	GND	GND			
D		GND	DTR	RTS	DCAM <7>	ALEN AND	RXIR	RBNA ND*	CLEN AND	DCAM <0>	CLKM MC	DMMC <0>	MCSI DO	GND	GND	BSCA N*	TDODI GIT	GND	GND	GND	GND	GND		
E	GND	DCD	DSR	RENA ND	GND	GND	GND	CE1N AND	MCSIS YNCH	GND	DCAM <3>	MCSI CLK	GND	GND	GND	GND	IO11	GND	GND	GND	GND	GND	GND	
F	GND	APRO C<3>	APRO C<2>	APRO C<1>	OEPR OC*	CSPR OC1*	GND	GND	GND	DCAM <5>	GND	GND	GND	GND	GND	GND	GND	GND	VBAT	VBAT	VBAT	VBAT	VBAT	
G	GND	DPRO C<15>	DPRO C<14>	DPRO C<13>	GND	GND	GND	GND	GND	GND	GND	CS1L CD*	GND	GND	GND	GND	DLCD <4>	GND	VBAT	VBAT	GND	GND	GND	
H	GND	DPRO C<10>	DPRO C<11>	DPRO C<12>	GND	INTI2C	GND	GND	GND	GND	GND	WP1N ANDL	CS0L CD*	GND	DLCD <6>	GND	GND	GND	VBAT	VBAT	GND	GND	GND	
I	GND	DPRO C<9>	DPRO C<8>	DPRO C<7>	RWPR OC*	GND	GND	GND	WENA ND	GND	GND	DLCD <3>	DLCD <0>	ESTR BLCD	DLCD <7>	RSLC D	GND	GND	GND	GND	GND	GND	GND	ANTE NNE
J	GND	DPRO C<4>	DPRO C<5>	DPRO C<6>	IO7	GND	GND	GND	GND	GND	GND	GND	GND	GND	GND	GND	RWLC D*	GND	GND	GND	GND	GND	GND	GND
K	GND	DPRO C<3>	DPRO C<2>	DPRO C<1>	DPRO C<0>	GND	GND	GND	GND	GND	GND	CRES ET	GND	GND	DLCD <5>	GND	GND	GND	GND	GND	GND	GND	GND	GND
L	NC	DAICL K	RESE TCAM	HREF CAM	VSCA M	LEDC	GND	GND	GND	GND	GND	CLK13 M	C5	R5	C1	DLCD <2>	GND	GND	GND	GND	GND	GND	GND	GND
M	GND	DAIIN	DAIOUT	DAIRST	STBY CAM	VCCS	GND	CDO	GND	GND	GND	C3	C4	C6	R6	C2	CMDV IB	GND	GND	GND	GND	GND	GND	GND
N	GND	RESE TLCDL	IO6	IO5	RI	ITDATA	GND	GND	GND	HPN8	HPP32	HSGN D	GND	GND	GND	GND	USB DP	USB DM	DLCD <1>	GND	GND	GND	GND	GND
O	GND	NC	CHAR GEUR	CHAR GEUR	CHAR GEUR	GND	GND	GND	GND	HPP8	HPN3 2	GND	HSOR	HSOL	HSMI CIP	CDI	R1	GND	GND	GND	GND	GND	GND	GND

DRAFT

P	GND	LEDR	NC	TEST RST	VBACKUP	GND	TDOA NALO	GND	GND	GND	GND	GND	GND	HSMICIN	GND	R3	R2	GND	GND	GND	GND	GND	GND
Q	GND	LEDG	INT1	VRIO	ADC2	NC	GND	CSYNC	CSCLK	GND	GND	GND	GND	GND	MICIN	GND	R4	GND	GND	GND	TSPCLK	GND	
R		GND	CSMIW2*	ENLED	NC	GND	CLK32K	GND	TDIANALO	GND	GND	GND	GND	GND	MICIP	GND	GND	GND	GND	TSPDI	TSPE NI*	GND	
S			GND	DOMIW	CKMIW	CSMIW1*	GND	GND	GND	GND	GND	GND	GND	GND	GND	GND	GND	GND	GND	TSPDO	GND		
T				GND	DIMIW	GND	SIMVC	SIMRST	SIMCLK	SIMIO	TCK	GND	GND	TMS	VCSUB	GND	GND	GND	GND	CLK26M	GND		
U				GND	GND	GND	GND	GND	GND	GND	GND	GND	GND	GND	GND	GND	GND	GND	GND				

DRAFT

Signal name	IO type	Function	Description	Pin N°	
DAIRST	Input	DAI interface	DAI reset	M4	
DAIOUT	Output		DAI output data	M3	
DAIIN	Input		DAI input data	M2	
DAICLK	Input		DAI clock	L2	
DIMIW	Input	Serial interface to connect LCD or chip melody (1 chip select)	LCD driver input data of the serial link	T5	
DOMIW	Output		LCD driver output data of the serial link	S4	
CKMIW	Output		LCD driver clock of the serial link	S5	
CSMIW1*	Output		LCD driver chip select of the serial link	S6	
CSMIW2*	Output	Serial interface for LED chipset	Chip select for Baklight component	R3	
ENLED	Output	LED Chipset command	Enable for Backlight component	R4	
LEDR	Output	Red LED command		P2	
LEDG	Output	Green LED comment		Q2	
R1	Input	Keyboard interface	Keyboard row 1	O17	
R2	Input		Keyboard row 2	P17	
R3	Input		Keyboard row 3	P16	
R4	Input		Keyboard row 4	Q17	
R5	Input		Keyboard row 5	L14	
R6	Input		Keyboard row 6	M15	
C6	Output		Keyboard column 6	M14	
C5	Output		Keyboard column 5	L13	
C4	Output		Keyboard column 4	M13	
C3	Output		Keyboard column 3	M12	
C2	Output		Keyboard column 2	M16	
C1	Output		Keyboard column 1	L15	
OUI*	Input		ON key	Keyboard ON key	B10
SIMVCC	Output		SIM interface	SIM power supply	T7
SIMRST	Output	SIM reset		T8	
SIMCLK	Output	SIM clock		T9	
SIMIO	In/output	SIM data		T10	
SIMCD	Input	SIM insertion detection		B12	
HSMICIP	Input	To external microphone (accessory)	Differential input from microphone	O15	
HSMICIN	Input		Differential input from microphone	P14	
HSOL	Output	To external stereo HP (accessory)		O14	
HSGND	Output			N12	
HSOR	Output			O13	
MICIP	Input	Microphone interface	Differential input to handset microphone	R15	
MICIN	Input		Differential input to handset microphone	Q15	
HPP32	Output	Earphone interface	Differential output to 32ohms earphone	N11	
HPN32	Output		Differential output to 32ohms earphone	O11	
HPP8	Output		Differential output to 8ohms earphone	O10	
HPN8	Output		Differential output to 8ohms earphone	N10	
CMDVIB	Output	Vibrating device interface	Vibrating device command	M17	
RI	Output	V24 interface with flow control	Ring Indicator	N5	
DSR	Output		Data Send Ready	E3	

DRAFT

DCD	Output		Data Carrier Detect	E2
DTR	Input		Data Terminal Ready	D3
CTS	Output		Clear To Send	C5
RTS	Input		Request To Send	D4
TXD1	Output		UART transmit 1	B5
RXD1	Input		UART receive 1	B7
TXD2	Output	UART interface	UART transmit 2	B8
RXD2	Input		UART receive 2	B9
TXIR	Output	IRDA interface	IRDA transmit	B6
RXIR	Input		IRDA receive	D7
CMDIRDA	Output		IRDA command	C7
INT1	Input	Interrupt		Q3
SCL12C	Output	I2C interface	Clock	C11
SDAI2C	In/out		Data	B11
INTI2C	Output		Interrupt	H6
CHARGEUR	Input	Load interface	Charge	O3,O4,O5
VCCS	Input			M6
LEDC	Output		LED connection for charge activity	L6
TESTRST	Input	Reset	Reset system signal	P4
ITDATA	Input	Accessories detection	Interrupt signal	N6
DPROC<0>	In/output	Parallel interface For Companion chip connection	Data bus	K5
DPROC<1>	In/output		Data bus	K4
DPROC<2>	In/output		Data bus	K3
DPROC<3>	In/output		Data bus	K2
DPROC<4>	In/output		Data bus	J2
DPROC<5>	In/output		Data bus	J3
DPROC<6>	In/output		Data bus	J4
DPROC<7>	In/output		Data bus	I4
DPROC<8>	In/output		Data bus	I3
DPROC<9>	In/output		Data bus	I2
DPROC<10>	In/output		Data bus	H2
DPROC<11>	In/output		Data bus	H3
DPROC<12>	In/output		Data bus	H4
DPROC<13>	In/output		Data bus	G4
DPROC<14>	In/output		Data bus	G3
DPROC<15>	In/output		Data bus	G2
RWPROC*	Output		Write	I5
OEPROC*	Output		Read	F5
CSPROC1*	Output		Chip select 1	F6
APROC<1>	Output		Address bus	F4
APROC<2>	Output		Address bus	F3
APROC<3>	Output		Address bus	F2
DLCD<0>	In/output	Parallel LCD interface	Data bus	I13
DLCD<1>	In/output		Data bus	N18
DLCD<2>	In/output		Data bus	L16
DLCD<3>	In/output		Data bus	I12
DLCD<4>	In/output		Data bus	G17
DLCD<5>	In/output		Data bus	K15

DRAFT

DLCD<6>	In/output		Data bus	H15
DLCD<7>	In/output		Data bus	I15
ESTRBLCD	Output		Strobe enable	I14
CS0LCD*	Output		Chip select 0	H13
CS1LCD*	Output		Chip select 1	G12
RSLCD*	Output		LCD register selection (data/control)	I16
RWLCD*	Output		Read/write	J16
RESETLCD*	Output		Reset	N2
USB_DP	In/output	USB interface	Differential data	N16
USB_DM	In/output			N17
VCUSB	Input		Power supply input	T15
TSPACTEXT	Output	Radio signal		C17
CSYNC	In/output	I2S	Synchronisation	Q8
CSCLK	In/output		Clock	Q9
CDI	Input		Data input	O16
CDO	Output		Data output	M8
CRESET	Output		Reset	K12
DCAM<0>	In/output	Sensor interface	Data bus	D10
DCAM<1>	In/output		Data bus	C4
DCAM<2>	In/output		Data bus	C8
DCAM<3>	In/output		Data bus	E11
DCAM<4>	In/output		Data bus	C6
DCAM<5>	In/output		Data bus	F10
DCAM<6>	In/output		Data bus	C9
DCAM<7>	In/output		Data bus	D5
RESETCAM	Output		Reset	L3
STBYCAM	Output		Standby	M5
PCLKCAM	Input		Clock input	C10
VSCAM	Output		Clock output	L5
HREFCAM	Output		Horizontal synchronisation	L4
XCLKCAM	Output		Vertical synchronisation	C15
WP1NAND*	Output	Specific interface		H12
WENAND	Output			I9
RENAND	Output			E4
CLENAND	Output			D9
ALENAND	Output			D6
RBNAND*	Input			D8
CE1NAND	Output			E8
DMMC<0>	In/output	MMC interface	Data bus	D12
DMMC<1>	In/output		Data bus	B15
DMMC<2>	In/output		Data bus	B16
DMMC<3>	In/output		Data bus	B17
CLKMMC	Output		Clock	D11
CMDMMC	In/output		Control	C12
POWMMC	Output		Power supply control	B13
CDMMC	Input		Card detect	B14
CLK26M	Output	Clocks	26MHz analog clock output	T19
CLK13M	Output		13MHz digital clock output	L12

DRAFT

CLK32K	Output		32KHz digital clock output	R7
ADC2	Input	ADC	Battery type detection	Q5
MCSIDI	Input	MCSI interface	Data input	C13
MCSIDO	Output		Data output	D13
MCSICLK	In/output		Clock SPI	E12
MCSISYNCH	In/output		Synchronisation	E9
IO5	In/output		With Pull down	N4
IO6	In/output		With pull down	N3
IO7	In/output		With pull down	J5
IO11	In/output		With pull up	E17
VBAT	Input	Power supply	+3.6V battery power supply	F19,F20,F21, F22,F23,G19, G20,H19,H20
VRIO	Output		+2.8V output power supply	Q4
VBACKUP	Input		Backup input	P5
GND	Ground	Ground	GND	Other
ANTENNE	Output/input	Antenna input/output	Antenna connection (50 ohms)	I23
TCK	Input	JTAG interface	JTAG	T11
TMS	Input		JTAG	T14
TDIDIGIT	Input		JTAG	C14
TDODIGIT	Output		JTAG	D17
TDI ANALOG	Input		JTAG	R9
TDO ANALOG	Output		JTAG	P7
BSCAN*	Input	Boundary scan	JTAG	D16
EMU0*	Output		For debug	C18
EMU1*	Output		For debug	B18
NC	NC	No connect		Q21,R21,R20 ,S20, L1, P3, Q6, R5, O2

DRAFT

6. ELECTRICAL SPECIFICATION

V_{OH} High level output voltage
 V_{OL} Low level output voltage
 V_{IH} High level input voltage
 V_{IL} Low level input voltage

6.1 VBAT

The module is supplied through the VBAT signal with the following characteristics:

Parameter	Name	Min	Typ	Max
VBAT period (ms)	VbatTe (*)	4.614	4.615	DC
VBAT low duration (us)	VbatTi (*)	550	-	VBAT period
VBAT rise time (us)	VbatTr (*)	0	-	-
VBAT fall time (us)	VbatTf (*)	0	-	-
VBAT maximum voltage (V)	VbatMax (*)	-	-	4.5
VBAT minimum voltage (V)	VbatMin (*)	3.45	-	-
VBAT drop voltage (mV)	DeltaVbat (*)	-	-	450 (**)
Transient voltage (V)		3	-	-
Noise level (Vrms) @100MHz-1MHz		-	-	50mV

(*): cf figure 16.

(**): for a new battery. Of course for an old battery, this value will be higher and will create a reset (without MMI message) when the battery begins to be discharged.

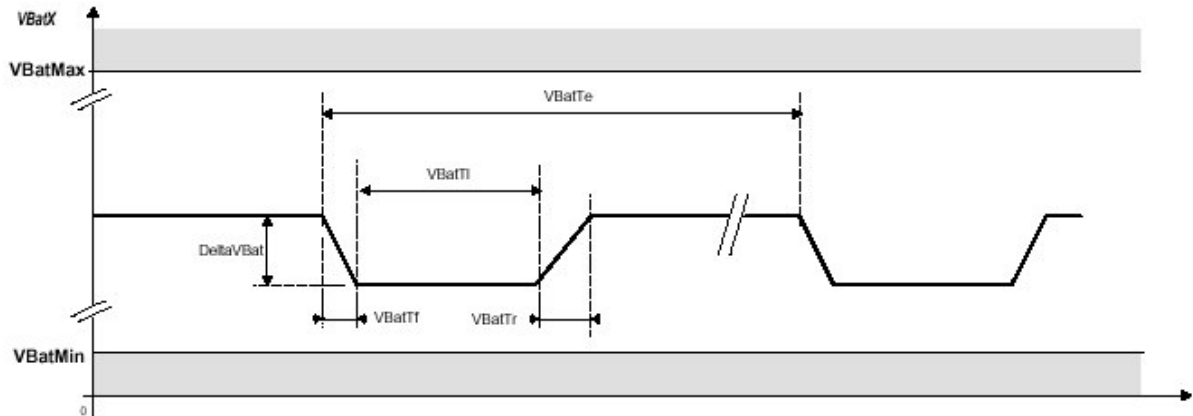

Figure 17
VBAT voltage waveform

DRAFT

6.2 VRIO

Signal	Min	Typ	Max	Remarks
Voltage level (activ mode)	2.70V	2.80V	2.90V	
Voltage level (sleep mode)	2.70V	2.80V	3.00V	
Current capability Active mode	-	-	10mA	
Current capability Sleep mode	-	-	0.5mA	
Rise time	-	10µs	-	

6.3 DAI INTERFACE

DAIRST, DAIIN, DAICLK and DAIOUT have the following characteristics:

Signal	V _L (V)		V _H (V)		Remarks
	Min	Max	Min	Max	
DAIRST	-0.5	+0.8	+2.03	+3.2	
DAICLK	-0.5	+0.8	+2.03	+3.2	PD 100K
DAIIN	-0.5	+0.8	+2.03	+3.2	PD 100K
DAIOUT	-	+0.59	+2.32	-	

6.4 NETWORK LED

Signal	V _L (V)		V _H (V)		Remarks
	Min	Max	Min	Max	
LEDR, LEDG	-	+0.59	+2.32	-	

LEDG: I_{max} = 2mALEDR: I_{max} = 4mA**6.5 SERIAL INTERFACE FOR LCD**

DIMIW, DOMIW, CKMIW, CSMIW1* have the following characteristics:

Signal	V _L (V)		V _H (V)		Remarks
	Min	Max	Min	Max	
DIMIW	-0.5	+0.8	+2.03	+3.2	PU 100K
DOMIW	-	+0.59	+2.32	-	
CKMIW	-	+0.59	+2.32	-	
CSMIW1*	-	+0.59	+2.32	-	

6.6 KEYBOARD INTERFACE

R1, R2, R3, R4, R5, R6, C1, C2, C3, C4, C5 and C6 have the following characteristics:

Signal	V _L (V)		V _H (V)		Remarks
	Min	Max	Min	Max	
Input (R1/2/3/4/5/6)	-0.5	+0.8	+2.03	+3.2	ESD protection PU
Output (C1/2/3/4/5/6)	-	+0.59	+2.32	-	ESD protection

OUI*:

DRAFT

Signal	Min	Typ	Max	Remarks
Ton (ms)	-	32,31	-	PU
V _{IL}	-	-	0.3*VBAT	
V _{IH}	0.7*VBAT	-	-	

6.7 VIBRATING DEVICE CONTROL

CMDVIB have the following characteristics:

Signal	V _L (V)		V _H (V)		Remarks
	Min	Max	Min	Max	
CMDVIB	-	+0.59	+2.32	-	PD

I_{CMDVIB} max = 2mA

6.8 V24

RXD1, TXD1, CTS, RTS, DCD, DSR, DTR and RI have the following characteristics:

Signal	V _L (V)		V _H (V)		Remarks
	Min	Max	Min	Max	
RTS	-0.5	+0.8	+2.03	+3.2	PU 100K
RI	-	+0.59	+2.32	-	
CTS	-	+0.59	+2.32	-	
DSR	-	+0.59	+2.32	-	PD
DCD	-	+0.59	+2.32	-	PU 10K
DTR	-0.5	+0.8	+2.03	+3.2	PU 100K
TXD1	-	+0.59	+2.32	-	
RXD1	-0.5	+0.8	+2.03	+3.2	PU 10K

6.9 IRDA AND UART2

RXIR, TXIR and CMDIRDA have the following characteristics:

Signal	V _L (V)		V _H (V)		Remarks
	Min	Max	Min	Max	
RXIR, RXD2	-0.5	+0.8	+2.03	+3.2	PU 100K
TXIR, TXD2, CMDIRDA	-	+0.59	+2.32	-	

6.10 RESET

TESTRST has the following characteristics:

Signal	Min	Max	Remarks
V _L (V)	-	0.2 VBAT	PD 100K
V _H (V)	0.8 VBAT	-	
Treset (ms)	65	-	

NB: The reset signal resets all the system including backup.

6.11 SPARE IO

IO5, 6,7,11 have the following characteristics:

Signal	V _L (V)	V _H (V)	Remarks
--------	--------------------	--------------------	---------

DRAFT

	Min	Max	Min	Max	
Input	-0.5	+0.8	+2.03	+3.2	IO5,6,7: programmable PD IO11: programmable PU
Output	-	+0.59	+2.32	-	

 $I_{out\ max} = 2mA$

6.12 CLOCKS

CLK26M and CLK32K have the following characteristics:

Signal	V_L (V)		V_H (V)		Remarks
	Min	Max	Min	Max	
CLK13M	-	+0.59	+2.32	-	
CLK32K	-	0,297	1,32	-	

Signal	V_{min} (V)	V_{max} (V)	Remarks
CLK26M	0.5V	2V	

6.13 PARALLEL INTERFACE FOR COMPANION CHIP

DPROC<0..15>, APROC<1..3>, RWPROC*, OEPROC*, CS1PROC* have the following characteristics:

Signal	V_L (V)		V_H (V)		Remarks
	Min	Max	Min	Max	
Input DPROC<0..15>	-0.5	+0.8	+2.03	+3.2	
Output DPROC<0..15>, APROC<1..3>, RWPROC* CS1PROC* OEPROC*	-	+0.59	+2.32	-	

NB: The maximum capacitance acceptable on each signal of the parallel interface for companion chip is 25pF (including copper line capacitance, connectors capacitance...).

6.14 PARALLEL INTERFACE FOR LCD

DLCD<0..7>, ESTRBLCD, RWLCD*, CS0LCD*, CS1LCD*, RESETLCD*, RSLCD have the following characteristics:

Signal	V_L (V)		V_H (V)		Remarks
	Min	Max	Min	Max	
Input DLCD<0..7>	-0.5	+0.8	+2.03	+3.2	
Output DLCD<0..15>, RESETLCD* RWLCD* CS0LCD* CS1LCD*, RSLCD, ESTRBLCD	-	+0.59	+2.32	-	

NB: The maximum capacitance acceptable on each signal of the parallel interface for LCD is tbd (including copper line capacitance, connectors capacitance...).

DRAFT

6.15 USB INTERFACE

USB_DM, USB_DP, VCUSB have the following characteristics:

Signal	V _L (V)		V _H (V)		Remarks
	Min	Max	Min	Max	
Input USB_DM, USB_DP	-0.5	+0.93	+2.45	+3.6	PU
Output USB_DM, USB_DP	-	+0.682	+2.8	-	PU

Signal	Min	Max
VCUSB (V)	4.0	5.5

6.16 MMC INTERFACE

DMMC<0..3>, CLKMMC, CMDMMC, POWMMC, CDMMC have the following characteristics:

Signal	V _L (V)		V _H (V)		Remarks
	Min	Max	Min	Max	
Input DMMC<0..3>, CMDMMC	-0.5	+0.8	+2.03	+3.2	PU 100K
Output DMMC<0..3>, POWMMC, CMDMMC	-	+0.59	+2.32	-	PU 100K
CLKMMC	-	+0.59	+2.32	-	

6.17 VIDEO SENSOR INTERFACE

DCAM<0..7>, RESETCAM, STBYCAM, PCLKCAM, VSCAM, HREFCAM, XCLKCAM have the following characteristics:

Signal	V _L (V)		V _H (V)		Remarks
	Min	Max	Min	Max	
Input DCAM<0..7>, PCLKCAM	-0.5	+0.8	+2.03	+3.2	
Output DCAM<0..15>, XCLKCAM, HREFCAM	-	+0.59	+2.32	-	
VSCAM, STBYCAM, RESETCAM	-	+0.59	+2.32	-	Programmable PU

NB: The maximum capacitance acceptable on each signal of the parallel interface for video sensor is tbd (including copper line capacitance, connectors capacitance...).

6.18 MCSI INTERFACE

MCSIDI, MCSIDO, MCSICLK, MCSISYNCH have the following characteristics:

Signal	V _L (V)		V _H (V)		Remarks
	Min	Max	Min	Max	
Input MCSIDI, MCSICLK, MCSISYNCH	-0.5	+0.8	+2.03	+3.2	

DRAFT

Output MCSIDO, MCSICLK, MCSISYNCH	-	+0.59	+2.32	-	
--	---	-------	-------	---	--

NB: a pull down as to be added to MCSIDI and MCSICLK

6.19 I2S INTERFACE

CSYNC, CSCLK, CDI, CDO, CRESET have the following characteristics:

Signal	V _L (V)		V _H (V)		Remarks
	Min	Max	Min	Max	
CDI	-0.5	+0.8	+2.03	+3.2	PD 100K
Input CSYNC, CSCLK	-0.5	+0.8	+2.03	+3.2	
Output CDO, CRESET, CSYNC, CSCLK	-	+0.59	+2.32	-	

6.20 I2C INTERFACE

SDAI2C, SCLI2C, INTI2C have the following characteristics:

Signal	V _L (V)		V _H (V)		Remarks
	Min	Max	Min	Max	
Input SDAI2C, INTI2C	-0.5	+0.8	+2.03	+3.2	Programmable PU on INTI2C
Output SDAI2C, SCLI2C	-	+0.59	+2.32	-	PU 1.8K

6.21 JTAG INTERFACE

TCLK, TMS, TDI, TDODIGIT, TDIANALOG, BSCAN*, EMU0*, EMU1* have the following characteristics:

Signal	V _L (V)		V _H (V)		Remarks
	Min	Max	Min	Max	
TMS, TDI, TDIANALOG, BSCAN*	-0.5	+0.8	+2.03	+3.2	PU
TCK	-0.5	+0.8	+2.03	+3.2	PD
TDODIGIT, TDOANALOG,	-	+0.59	+2.32	-	
EMU0*, EMU1*	-	+0.59	+2.32	-	PU

6.22 ADC

Parameter	Min	Typ	Max
Resolution	-	10 bits	-
Input range	0	-	1.75V
Input capacitor	-	12pF	-

6.23 INTERRUPTS

ITDATA and INT1 have the following characteristics :

Signal	V _L (V)		V _H (V)		Remarks
	Min	Max	Min	Max	

DRAFT

ITDATA	-0.5	+0.8	+2.03	+3.2	PU
INT1	-0.5	+0.8	+2.03	+3.2	PU

Pulse duration in functional mode: 77ns min.

6.24 VBACKUP

Signal	Min	Max	Remarks
VBACKUP	+2.2V	+3.2V	

If no external backup is supplied, VBACKUP has to be connected to VBAT.

With external BACKUP:

- if VBAT < VBACKUP, internal RTC is supplied by VBACKUP.
- if VBAT > VBACKUP, internal RTC is supplied by VBAT.

Without external VBACKUP (VBACKUP input connected to VBAT)

- if VBAT > 2.2V, internal RTC is supplied by VBAT.
- if VBAT < 2.2V, internal RTC is not supplied.

7. ENVIRONMENTAL SPECIFICATION

7.1 OPERATING CONDITIONS

Parameter	Min	Max
Ambient temperature	-10°C	+55°C
Supply voltage VBAT	+3.45V	+4.5V

7.2 CLIMATIC CONDITIONS

Parameter	Min	Max
Ambient temperature Normal range	-10°C	+55°C
Ambient temperature Extended range	-20°C	+70°C
Storage temperature	-40°C	+85°C
Long damp heat Operating conditions	Tested at +60°C, 95% RH during 504 hours	
Short damp heat Storage and transportation conditions	Tested at +40°C, 95% RH during 96 hours	

DRAFT

8. MECHANICAL SPECIFICATION

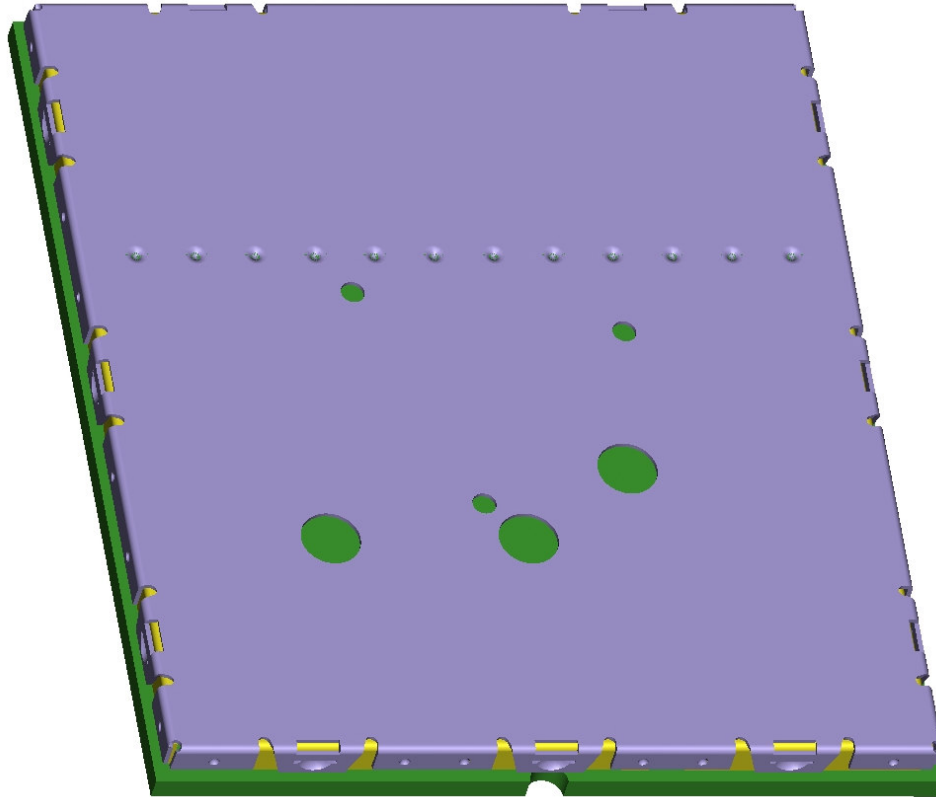

Figure 18
CO230 component side

DRAFT

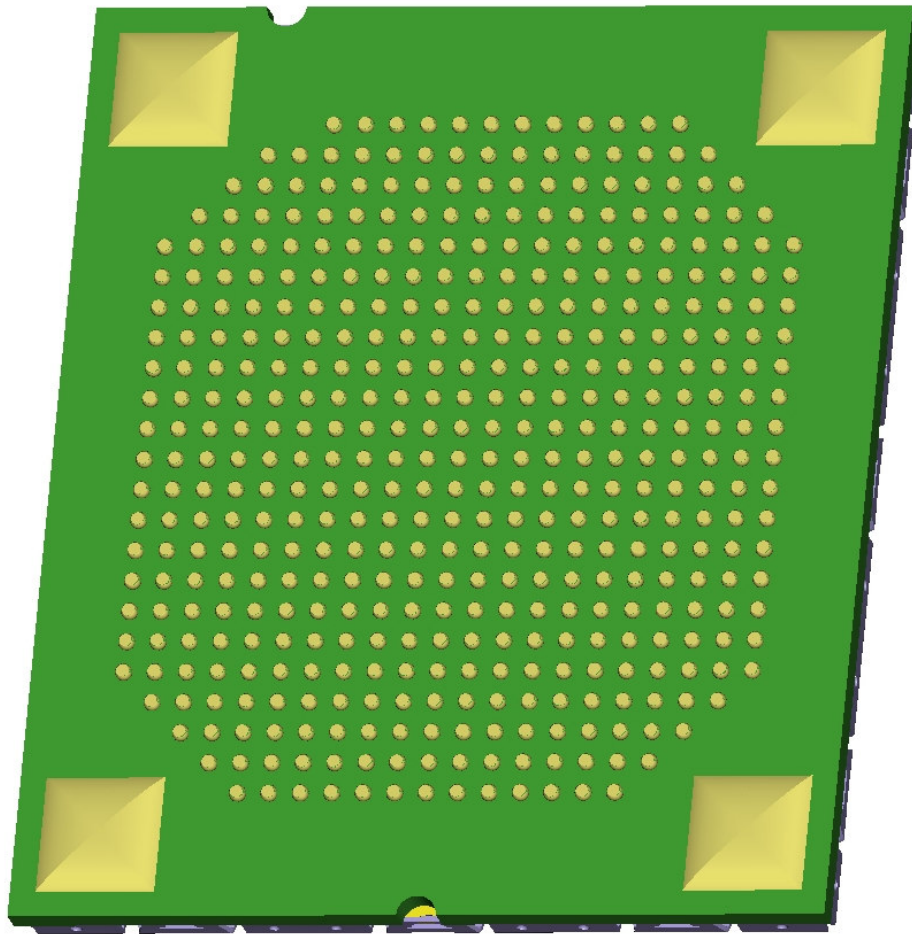

Figure 19
CO230 ballout side

DRAFT

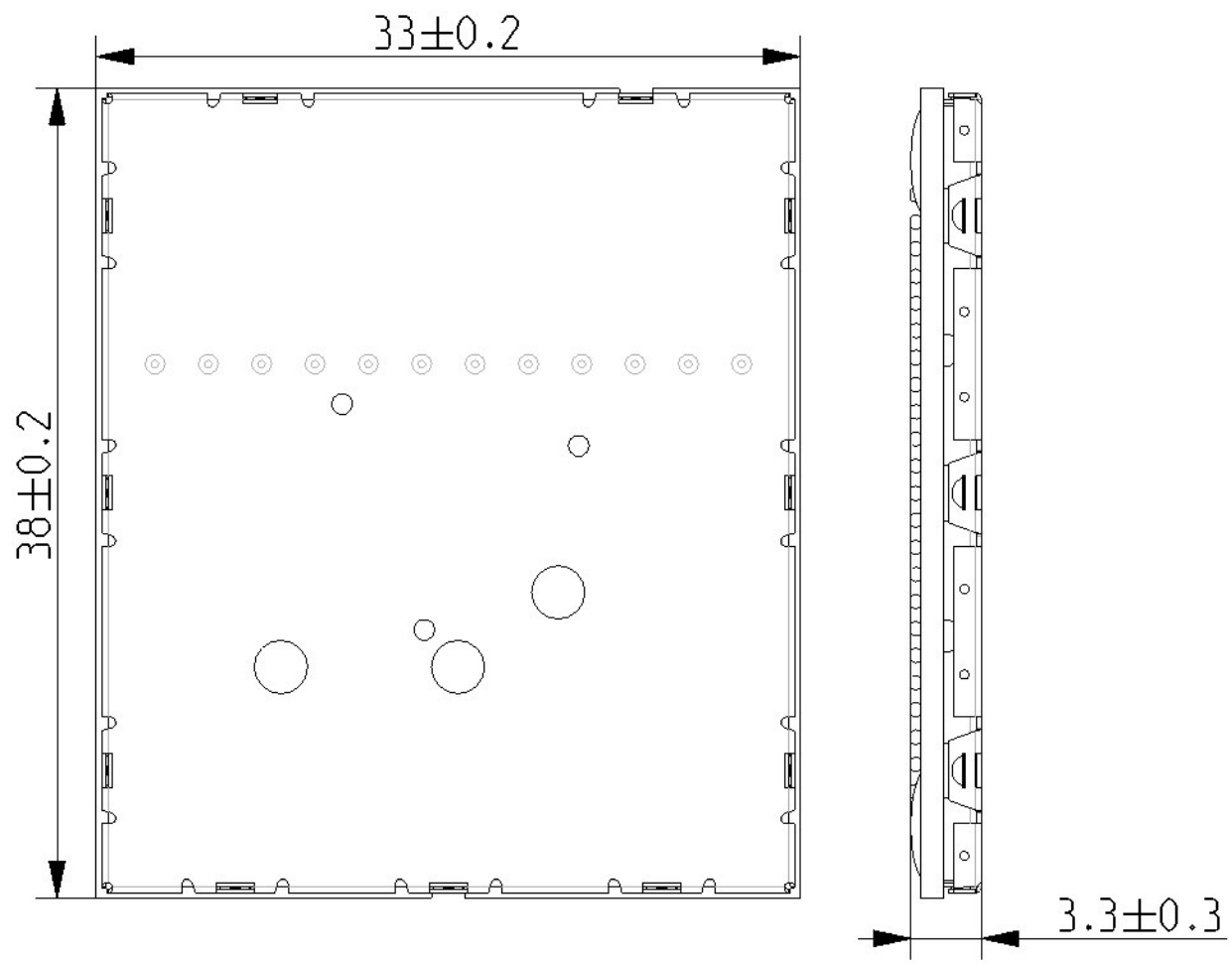

Figure 20
CO230 dimensions

DRAFT

9. ANNEXE

Signal name	IO type	Pin N°
DAIRST	Digital bi directional buffer (IDI041/OUK431)	M4
DAIOUT	Digital bi directional buffer (IDI041/OUK431)	M3
DAIIN	Digital bi directional buffer (IDI041/OUK431). Pull down	M2
DAICLK	Digital bi directional buffer (IDI041/OUI431). Pull down	L2
DIMIW	Digital input buffer (IDI041/PS0201). Pull up	T5
DOMIW	Digital output buffer (OUK431)	S4
CKMIW	Digital output buffer (OUI431)	S5
CSMIW1*	Digital output buffer (OUK431)	S6
CSMIW2*	Digital output buffer (OUK431)	R3
ENLED	Digital bi directional buffer (IDG091/OUI431/PE1001)	R4
LEDR	Digital output buffer (OUI831)	P2
LEDG	Digital output buffer (OUK431)	Q2
R1	Digital bi directional buffer (IDI041/OUI431/PS1001). Pull up	O17
R2	Digital bi directional buffer (IDI041/OUI431/PS1001). Pull up	P17
R3	Digital bi directional buffer (IDI041/OUI431/PS1001). Pull up	P16
R4	Digital bi directional buffer (IDI041/OUI431/PS1001). Pull up	Q17
R5	Digital bi directional buffer (IDI041/OUI431/PS1001). Pull up	L14
R6	Digital bi directional buffer (IDI041/OUI431/PS1001). Pull up	M15
C6	Digital output buffer (OUO431)	M14
C5	Digital output buffer (OUI431)	L13
C4	Digital output buffer (OUI431)	M13
C3	Digital output buffer (OUI431)	M12
C2	Digital output buffer (OUI431)	M16
C1	Digital output buffer (OUI431)	L15
OUI*	Digital input. Pull up	B10
SIMVCC	Power supply output	T7
SIMRST	Digital output buffer	T8
SIMCLK	Digital output buffer	T9
SIMIO	Digital bi directional buffer. Pull up	T10
SIMCD	Digital input buffer (IDI091). Pull down	B12
HSMICIP	Analog audio input	O15
HSMICIN	Analog audio input	P14
HSOL	Analog audio output	O14
HSGND	Analog audio output	N12
HSOR	Analog audio output	O13
MICIP	Analog audio input	R15
MICIN	Analog audio input	Q15
HPP32	Analog audio output	N11
HPN32	Analog audio output	O11
HPP8	Analog audio output	O10
HPN8	Analog audio output	N10
CMDVIB	Digital bi directional buffer (IDG091/OUI431/PE1001). Pull down	M17
RI	Digital bi directional buffer (IDG091/OUO431/PS1001)	N5
DSR	Digital bi directional buffer (IDG091/OUI431/PE1001). Pull down	E3
DCD	Digital output buffer (OUI831). Pull up	E2

DRAFT

DTR	Digital bi directional buffer (IDI091/OUI831). Pull up	D3
CTS	Digital output buffer (OUI831). Pull up	C5
RTS	Digital bi directional buffer (IDI091/OUO431)	D4
TXD1	Digital output buffer (OUI831)	B5
RXD1	Digital bi directional buffer (IDI091/OUI831). Pull up	B7
TXD2	Digital output buffer (OUI831)	B8
RXD2	Digital input buffer (IDI091). Pull up	B9
TXIR	Digital bi directional buffer (IDI041/OUI831)	B6
RXIR	Digital bi directional buffer (IDI091/OUK431). Pull up	D7
CMDIRDA	Digital output buffer (OUK431)	C7
INT1	Digital bi directional buffer (IDG091/OUI431/PS1001). Pull up	Q3
SCL12C	Digital bi directional buffer (IDI091/UOS205). Pull up	C11
SDA12C	Digital bi directional buffer (IDI091/UOS205). Pull up	B11
INT12C	Digital bi directional buffer (IDG091/OUI431/PS1001). Pull up	H6
CHARGEUR	Power supply input	O3,O4,O5
LEDC	Analog output	L6
TESTRST	Digital input. Pull down	P4
ITDATA	Digital bi directional buffer (IDI091/OUI431/PS1001). Pull up	N6
DPROC<0>	Digital bi directional buffer (IDI041/OUI831)	K5
DPROC<1>	Digital bi directional buffer (IDI041/OUI831)	K4
DPROC<2>	Digital bi directional buffer (IDI041/OUI831)	K3
DPROC<3>	Digital bi directional buffer (IDI041/OUI831)	K2
DPROC<4>	Digital bi directional buffer (IDI041/OUI831)	J2
DPROC<5>	Digital bi directional buffer (IDI041/OUI831)	J3
DPROC<6>	Digital bi directional buffer (IDI041/OUI831)	J4
DPROC<7>	Digital bi directional buffer (IDI041/OUI831)	I4
DPROC<8>	Digital bi directional buffer (IDI041/OUI831)	I3
DPROC<9>	Digital bi directional buffer (IDI041/OUI831)	I2
DPROC<10>	Digital bi directional buffer (IDI041/OUI831)	H2
DPROC<11>	Digital bi directional buffer (IDI041/OUI831)	H3
DPROC<12>	Digital bi directional buffer (IDI041/OUI831)	H4
DPROC<13>	Digital bi directional buffer (IDI041/OUI831)	G4
DPROC<14>	Digital bi directional buffer (IDI041/OUI831)	G3
DPROC<15>	Digital bi directional buffer (IDI041/OUI831)	G2
RWPROC*	Digital bi directional buffer (IDI041/OUI831)	I5
OEPROC*	Digital output buffer (OUI831)	F5
CSPROC1*	Digital bi directional buffer (IDI041/OUI831)	F6
APROC<1>	Digital bi directional buffer (IDI041/OUI831)	F4
APROC<2>	Digital bi directional buffer (IDI041/OUI831)	F3
APROC<3>	Digital bi directional buffer (IDI041/OUI831)	F2
DLCD<0>	Digital bi directional buffer (IDI041/OUI431)	I13
DLCD<1>	Digital bi directional buffer (IDI041/OUI431)	N18
DLCD<2>	Digital bi directional buffer (IDI041/OUI431)	L16
DLCD<3>	Digital bi directional buffer (IDI041/OUI431)	I12
DLCD<4>	Digital bi directional buffer (IDI041/OUI431)	G17
DLCD<5>	Digital bi directional buffer (IDI041/OUI431)	K15
DLCD<6>	Digital bi directional buffer (IDI041/OUI431)	H15
DLCD<7>	Digital bi directional buffer (IDI041/OUI431)	I15
ESTRBLCD	Digital output buffer (OUI431)	I14
CS0LCD*	Digital output buffer (OUI431)	H13

DRAFT

CS1LCD*	Digital output buffer (OUI431)	G12
RSLCD*	Digital output buffer (OUI431)	I16
RWLCD*	Digital output buffer (OUI431)	J16
RESETLCD*	Digital output buffer (OUI431)	N2
USB_DP	Digital bi directional buffer (UIS245/UOS181)	N16
USB_DM	Digital bi directional buffer (UIS245/UOS181)	N17
VCUSB	Power supply input	T15
TSPACTEXT	Digital output buffer (OUI831)	C17
CSYNC	Digital bi directional buffer (IDG091/OUM431/PE0201)	Q8
CCLK	Digital bi directional buffer (IDG091/OUI831)	Q9
CDI	Digital output buffer (IDG091). Pull down	O16
CDO	Digital input buffer (OUM431)	M8
CRESET	Digital output buffer (OUI431)	K12
DCAM<0>	Digital bi directional buffer (IDI041/OUI431)	D10
DCAM<1>	Digital bi directional buffer (IDI041/OUI431)	C4
DCAM<2>	Digital bi directional buffer (IDI041/OUI431)	C8
DCAM<3>	Digital bi directional buffer (IDI041/OUI431)	E11
DCAM<4>	Digital bi directional buffer (IDI041/OUI431)	C6
DCAM<5>	Digital bi directional buffer (IDI041/OUI431)	F10
DCAM<6>	Digital bi directional buffer (IDI041/OUI431)	C9
DCAM<7>	Digital bi directional buffer (IDI041/OUI431)	D5
RESETCAM	Digital bi directional buffer (IDG091/OUI431/PE1001). Pull down	L3
STBYCAM	Digital bi directional buffer (IDG091/OUI431/PS1001)	M5
PCLKCAM	Digital bi directional buffer (IDG091/OUI431/PS1001)	C10
VSCAM	Digital bi directional buffer (IDG091/OUO431/PS1001). Pull up	L5
HREFCAM	Digital bi directional buffer (IDG091/OUI431/PS1001)	L4
XCLKCAM	Digital bi directional buffer (IDI091/OUI831/PS1001)	C15
WP1NAND*	Digital output buffer (OUI431)	H12
WENAND	Digital output buffer (OUI431)	I9
RENAND	Digital output buffer (OUI431)	E4
CLENAND	Digital output buffer (OUI431)	D9
ALENAND	Digital output buffer (OUI431)	D6
RBNAND*	Digital bi directional buffer (IDI041/OUI431)	D8
CE1NAND	Digital output buffer (OUI431)	E8
DMMC<0>	Digital bi directional buffer (IDG091/OUM431/PS0201). Pull up	D12
DMMC<1>	Digital bi directional buffer (IDG091/OUM431/PS0201). Pull up	B15
DMMC<2>	Digital bi directional buffer (IDG091/OUM431/PS0201). Pull up	B16
DMMC<3>	Digital bi directional buffer (IDG091/OUM431/PS0201). Pull up	B17
CLKMMC	Digital bi directional buffer (IDG091/OUI431)	D11
CMDMMC	Digital bi directional buffer (IDG091/OUM431/PS1001). Pull up	C12
POWMMC	Digital output buffer (OUI431). Pull down	B13
CDMMC	Digital bi directional buffer (IDG091/OUI431/PS0201) Pull up	B14
CLK26M	Analog Clock output	T19
CLK13M	Digital bi directional buffer (IDI041/OUI831)	L12
CLK32K	Digital output buffer (OUK431)	R7
ADC2	Analog input	Q5
MCSIDI	Digital input buffer (IDG091)	C13
MCSIDO	Digital output buffer (OUM431)	D13
MCSICLK	Digital bi directional buffer (IDG091/OUM431)	E12
MCSISYNCH	Digital bi directional buffer (IDG091/OUM431)	E9

DRAFT

IO5	Digital bi directional buffer (IDG091/OUI431/PE1001)	N4
IO6	Digital bi directional buffer (IDG091/OUI431/PE1001)	N3
IO7	Digital bi directional buffer (IDG091/OUI431/PS1001)	J5
IO11	Digital bi directional buffer (IDG091/OUO431/PS1001)	E17
VBAT	Power supply input	F19,F20,F21,F22,F23,G19,G20,H19,H20
VRIO	Power supply output	Q4
VBACKUP	Power supply input	P5
ANTENNE	Analog bi directional HF	I23
TCK	Digital input buffer (IDI091/ PE0201). Pull down	T11
TMS	Digital input buffer (IDI091/ PS0201). Pull up	T14
TDIDIGIT	Digital input buffer (IDI091/ PS0201). Pull up	C14
TDODIGIT	Digital bi directional buffer (OUI431)	D17
TDIANALOG	Digital bi directional buffer. Pull up	R9
TDOANALOG	Digital bi directional buffer	P7
BSCAN*	Digital input buffer (IDI041/ PS0201). Pull up	D16
EMU0*	Digital bi directional buffer (IDI091/OUO431/PS1001). Pull up	C18
EMU1*	Digital bi directional buffer (IDI091/OUO431/PS1001). Pull up	B18

OUO231 : rated output current = 1mA (with Voh = Vccmin)

OUI431, OUK431, OUO431 :rated output current = 2mA (with Voh = Vccmin)

OUI831, OUK831 : rated output current = 4mA (with Voh = Vccmin)

END OF DOCUMENT
