

COSY Phone



English

You have just purchased a SAGEM WIRELESS phone, we congratulate you; it is recommended that you read this handbook carefully in order to use your phone efficiently and in the best conditions.

Your phone can be used internationally in the various networks (Either COSY Phone 2G: GSM 850/900/1800/1900MHz, EDGE 850/900/1800/1900MHz, either COSY Phone 3G: GSM 850/900/1800/1900MHz, EDGE 850/900/1800/1900MHz, UMTS/HSDPA) depending on the roaming arrangements with your operator.

This phone is approved to meet European standards.

WARNING

Depending on the model, network configuration and associated subscription cards, certain functions may not be available.

T9® Text Input is a trademark of ©Tegic Communications Inc. Java™ and all Java™ based trademarks and logos are trademarks or registered trademarks of Sun Microsystems, Inc. in the U.S. and other countries.

The WAP browser and the softwares included are the exclusive property of Openwave. For this reason, it is forbidden to modify, translate, disassemble or even decompile all or part of these softwares.

The *Bluetooth*® word mark and logos are owned by the *Bluetooth*® SIG, Inc. *Bluetooth*® QDID (Qualified Design ID): B016837.

microSD™ is a trademark of SD Card Association.

Contents

Description	6
Idle screen	9
Quick start	11
Information on the SIM card.....	11
Installing the SIM card and the battery.....	12
Charging the battery	13
Improving antenna performance.....	15
Increase the battery life of your phone	15
Inserting the memory card	16
Removing the memory card	16
Getting started.....	16
Switching ON/OFF.....	17
Network.....	17
Calls	19
Calling	19
Receiving a call	19
Call history.....	20
Call Settings	20
Messaging	24
Creating a text message	24
Receiving messages.....	26
Messaging menu	27
Contacts	30
Using the contacts.....	30
Storing a new contact	30
Contact options.....	30
Camera	34
Taking a photo	34
Recording a video	35

Music player	37
Recently played.....	37
Music	37
More sounds	38
FM Radio	39
Multimedia	41
Applications	42
NFC	42
ToDo	45
Clock	46
Sync.	46
Calculator.....	47
Torch.....	47
Local info.	47
Services	47
Recorder	47
Calendar.....	48
Help	49
Entertainment	50
Games.....	50
Applications.....	50
Running Applications	50
Settings	51
Browser	52
Logging on	53
Downloading objects.....	53
Logging off	53
Connectivity	54
<i>Bluetooth</i> [®]	54
GPS	56
USB mode	57
Sync. settings	58
Profiles	58

Networks	58
NFC	58
Settings.....	59
Phone	59
Display	62
Calls	63
Connectivity	63
Technical features	64
Declaration of conformity	65
Certification and safety information for the united states and countries using fcc standards.....	66
FCC Part 15 statement	66
FCC SAR information	67
Safety Information	69
Distance of operation	71
FDA consumer information on wireless phones	71
Driving safety tips	76
For customers in the United States	79
Limited Warranty	80
For customers outside the United States.....	85
Warranty	85
End user licence agreement (EULA)	91
Java™	99
Troubleshooting.....	104
Index	107

Description

Loudspeaker

Left key

- *In idle screen:* access to the light menus
- *In menus:* access to the selection shown on screen in the tab

Green key

- Activate/deactivate hands-free mode (long press).
WARNING: do not use the phone in hands-free mode near to your ear, or you may suffer hearing loss.
- *In call context:* call - receiving a call
- *In idle screen:* displaying the call log

Navigator

- Navigation in menus
- Confirmation of a selection

* key

When composing a message:

- Long press: switches from one input mode to another (ABC/T9)
- Short press: upper case/lower case/figures





Turn on/off key

- Long press to switch on/off

Right key

- *In idle screen*: access to NFC
- *In menus*: access to the selection shown on screen in the tab

Red key

- *In a call context*: reject a call - hang up
- *In menus*: Return to idle screen

key

- *In idle screen*: silent mode (long press)
- *In call reception mode*: stops ring tone (short press)
- *In ring tone setting mode*: activate/deactivate ring tone (short press).
- Stops sound in video or message playing, or in a game (short press).

Microphone

WARNING: Ensure that you are not obstructing the microphone in call context.

Torch lamp



- Launch to camera preview
- Adjusting the volume (ringtones, music)
- *In the idle screen:* access to the Profiles menu (short press)
- Setting zoom (photo, video)



- Connector for charger and USB cable.
- Connector for hands free kit.
- Light up torch lamp.
- light up keypad and screen

Camera lens



Loudspeaker

Idle screen

The idle screen may contain the following information:

1 - The title bar icons:



Battery (if the icon is , the battery must be charged immediately)



Silent mode (the ringtone is off)



Only emergency call is possible



Reception level of the network signal



Message received (read your message), if the icon is , memory is full (delete some messages)



NFC-radio-on (when NFC function is activated)



Bluetooth[®] (when the mode of Bluetooth[®] is on)



GPRS connection



EDGE connection



WEB connection



Connection to the 3G network (UMTS, If COSY Phone is 3G)



Connection to the 3G network (HSDPA, If COSY Phone is 3G)

2 - Date and time, in digital or analog mode

3 - Network provider

4 - Thumbnail centred on bottom line:

The main " Menu " thumbnail shows that the menus can be accessed by pressing [**OK**].

Information messages on calls, messages or network messages received may also be displayed. They can be read by pressing the **left key** or [**OK**] briefly.

Quick start

Information on the SIM card

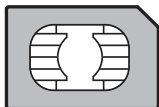

To use your phone, you need a card called SIM or USIM card. It contains personal information that you can modify:

- Secret codes (PIN(s): Personal Identification Numbers), these codes allow you to protect access to your SIM card and phone
- Phonebook
- Messages
- How special services work.

WARNING

This card must be handled and stored with care in order not to be damaged. If you should lose your SIM card, contact your network provider immediately.

Please keep your SIM card out of reach of young children.

WARNING

Your phone is identified by its IMEI number. Write this number down, and do not keep it with your phone, because you may be asked for it in the event of your phone being stolen, in order to prevent it from being used, even with a different SIM card. In order to display the IMEI on your phone's screen, type the following number on idle screen: *#06#.

Installing the SIM card and the battery

Ensure that the phone is switched off and the charger disconnected.

1. Turn the phone back. Use the notch as a lever to lift the cover.
2. Slide the SIM card, with cut corner as shown on the phone, into the card holder with gold face down.
3. Place the battery by positioning first the top of it.
4. Place the back cover, clicking in first the upper part then the lower part.

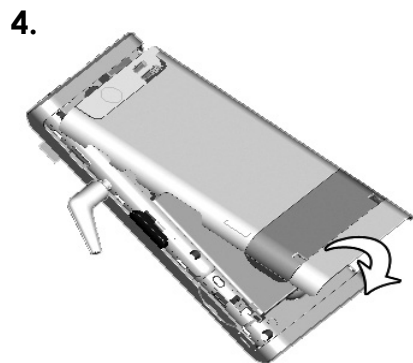
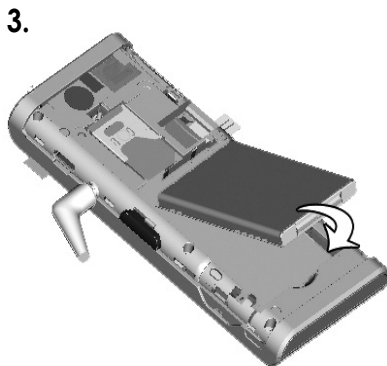
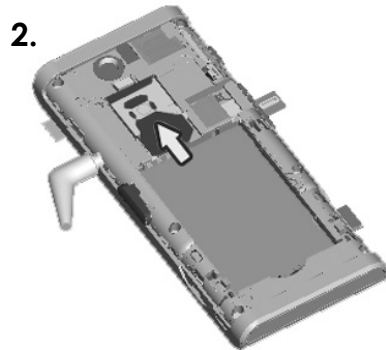
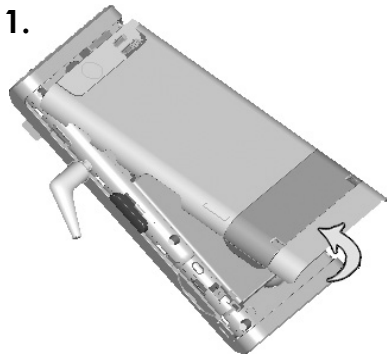

Charging the battery

Your phone is powered by a rechargeable battery. A new battery must be charged for 4 hours at least before being used for the first time. It reaches its optimum capacity after a few cycles of use.

When your battery has been discharged, the empty battery icon flashes. In this case recharge your battery for at least 15 minutes before making any calls in order not to be cut off quickly.

NOTE: Each phone has a specific charger with the appropriate connectors for the phone with which it is sold. Using any other charger or using the charger with any device other than the phone will lead to an exclusion of warranty.

To recharge the battery:

1



2

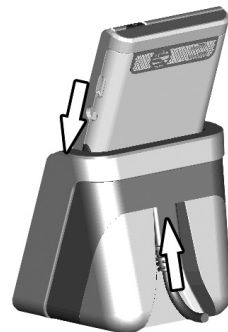

- **1. By cable:**
 - Plug the end of the cable on the side connector of the phone.
 - Connect the charger to a socket.
- **2. By cradle:**
 - Put the phone on the cradle.
 - Plug the end of the cable on the side connector of the cradle.
 - Connect the charger to a socket.

Then the phone is charging up. The battery icon scrolls left and right to indicate that it is charging. When the battery is fully charged, the charging stops on its own. Disconnect the cable.

When charging, the battery may warm up, this is normal. When charging, the socket on which the charger is plugged must be easily accessible.

WARNING

If the battery has entirely discharged, the phone cannot start. Plug the phone to the charger. The phone will switch on after a few minutes of charge. You can use the phone again when the **Start** option is displayed on the screen.

WARNING

There is danger of explosion if the battery is placed in an incorrectly way or if it is exposed to fire.

Do not short circuit it.

The battery does not have any part that you can change.

Do not try to open the battery casing.

Use only the appropriate chargers and batteries as shown in the phone manufacturer's catalogue.

The use of other types of chargers or batteries may be dangerous or invalidate the warranty.

Used batteries must be disposed of in the appropriate places.

We advise you to take the battery out if you plan not to use the phone for extended periods.

You are strongly advised not to connect your phone to the charger if it doesn't contain a battery.

The charger is a safety step-down transformer, it is forbidden to modify, alter or replace it by another component (power supply plug, etc).

Improving antenna performance

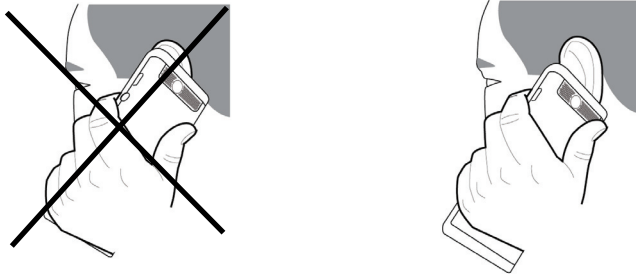

The antenna is integrated in your phone, under the back cover at the bottom.

Avoid putting your fingers on this area when the phone is switched ON.

If your fingers obstruct the antenna, the phone may have to operate with a higher power level than usual; decreasing its efficiency quickly. It could also affect the quality of your communications.

Increase the battery life of your phone

- Don't press the keys when not necessary: each key press activates the backlight, and uses much power.
- Don't obstruct the antenna with your fingers.
- Activation of *Bluetooth*[®] function reduces the phone battery life. We advise you to deactivate it when not in use.
- Activation of torch lamp function reduces the phone battery life. We advise you to deactivate it when not in use.

Inserting the memory card

- Turn the phone back and remove the back cover.
- Insert the memory card into the slot, halfway up as shown on the figure opposite (with gold face down).

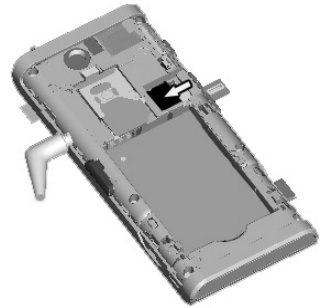

Removing the memory card

- Remove the back cover.
- Slide the memory card to extract it from its location.
- Turn your phone and shake it slightly to drop the memory card and retrieve it.

WARNING

The memory card is very fragile. Take care when you insert or remove the memory card.

The memory card can be inserted or withdrawn while the phone is in use. However, it may suffer damage if withdrawn during a read or write operation. Ensure that no application accesses the card during its withdrawal.

Getting started

When you switch on your phone for the first time, follow instructions displayed on the screen.

If access to the SIM card is protected, the device prompts you to enter the PIN number:

Enter the code between 4 and 8 digits given to you when the SIM card was issued. These digits do not appear on the screen for security reasons.

After pressing **[OK]**, the phone activates the SIM card settings and switches on again if necessary (depending on the SIM card).

If there are contacts saved in your SIM card, you are invited, if you wish, to copy them in the phone contacts memory.

WARNING

If a wrong PIN number is entered three times in succession, your SIM card is blocked. You must then:

- Enter the PUK (Personal Unblocking Key) code provided by your operator, and validate.
- Enter your PIN number and validate.
- Enter your PIN number again and validate.

After 5 or 10 failed attempts (depending on the type of SIM card), the SIM card is definitely locked. You must then contact your operator to obtain a new card.

Switching ON/OFF

When your phone is off, a long press on the Turn on/off key will turn it ON.

When the phone is ON, if you are browsing inside the menus, a short press on the  key will come back to the idle screen. When you are in the idle screen, a long press on **the Turn on/off key** will switch OFF the phone.

Network

Once ON, the phone is searching for a network on which it can make calls. If it finds one, it displays the name of the network on the screen.

NOTE: if COSY Phone is 3G and it finds a 3G/UMTS network, the 3G icon is displayed on the screen. If it finds a 3G/HSDPA network, the 3G+ icon is displayed on the screen.

You are then ready to make or receive a call.

If the network's name appears, calls are possible on your operator's network.

If the letter R and a network name are displayed, calls are possible on a roaming network provider.

If the letter E is displayed without any network name, only the emergency services are accessible (ambulance, police, fire brigade).

If the network icon flashes, the phone is in permanent search mode.

If only the  icon appears, no network is available.

The  icon is a reception level indicator of the network signal and allows to display the quality of reception.

Calls

Calling

Dial the number you want to ring. Press the  key. You can adjust the sound level (volume) using the navigator upwards or downwards.

At the end of the conversation press the  key to hang up.

International call

Press **0** (hold down) to display "+", then dial the country code without waiting for the dial tone, then the number of the called party.

Emergency services

Depending on the network you can obtain the emergency service with or without SIM card or when the keypad is locked. It is enough to be in an area served by a network. To obtain the international emergency service, dial **112** then press the  key.

Receiving a call

When you receive a call, the number of your caller is displayed when it is presented by the network.

Press the  key to answer, and speak.

To refuse the call, press the  key.

To stop the ring tone or the vibrate, without refusing the call, press the  key.

Hands-free mode

During a call:

- Make a long press on the green key and confirm
or
- Press [**Options**] and select **Loudspeaker ON** then confirm.

WARNING: in this mode do not bring the phone up to your ear.

When on a call, pressing [**Options**] allows you to have access to different functions.

Dial number and select [**Options**].

- **Call:** please refer Calling.
- **Message:** allows you to send a SMS to this number.
- **Save to contacts:** allows you to add this number into the contacts.

Call history

From the idle screen, press the  key to access the call history.

It is divided into three lists that you can display by the navigator: dialled calls, received calls and missed calls.

Various options are proposed: Details, Call, Add to contact, etc.

You can also make a call to a number by pressing the  key.

Call Settings

Settings/Calls

This menu allows you to manage all the call functions (response mode, display numbers, call divert, voicemail, call waiting, etc.).

Response mode

Auto response

This menu allows your phone to answer automatically to a call when it is connected to a car kit.

Any key

This menu allows you to answer to a call pressing any key except the right key and the red key.

Display numbers

Send my number

You can decide whether or not your phone's number will be displayed on the phone of the person you call.

- **Yes:** your phone's number will be displayed on the phone of the person you call.
- **No:** your phone's number will not be displayed on the phone of the person you call.
- **Preset:** the phone default mode (depending on the operator subscription type).

My number

- **For outgoing calls:** status of the Display numbers function.
- **For incoming calls:** status of the Display numbers function when you have forwarded the incoming calls to another number.

Caller's number

- **For outgoing calls:** status of the Display numbers function when your call is forwarded to another number.
- **For incoming calls:** status of the caller's Display numbers function.

Call divert

Depending on your subscription, this service allows you to forward incoming calls to a different number or to the voice mailbox.

Choose the type of forwarding you want from the options available.

Voicemail

This function is for storing your voicemail number.

Call waiting

(Network dependent service)

During a call, you may be informed that a caller is trying to reach you: you hear a special tone. The caller's number is displayed on the screen.

Auto redial

This menu allows you to call back a caller you have not managed to reach.

You can set the redial function as Inactive, Systematic or On Request.

If you choose **On request**, your phone will offer to redial your caller automatically if his number is busy.

Call reject list

The numbers entered in this list will automatically be rejected by the phone.

Call barring

This menu allows you to block the making or receiving of certain calls.

Before you can use this service, a password will be provided by your operator when you take out your subscription.

Access to this service depends on your subscription type.

To activate call barring:

- Select incoming or outgoing calls.
- Select the call type on which you want to activate call barring.
- Select the call origin.

- Select Activation and enter password.

Blacklist

The blacklist is used to limit failures on automatic calls (calls generated by the automatic redial function or by applications: data, fax for example).

When several automatic calls failed with a number (number busy or unknown), this number is put in the blacklist and no automatic call will be done with this number any more until you delete it from the blacklist.



NOTE: this function does not apply to the calls performed manually.

Messaging

The Messaging menu contains the following message type: text messages (SMS, MMS). MMS is a Multimedia Message Service, which allows you to enclose photos, audio files, and others rich contents to your messages; these messages can even be composed of several slides. An MMS is not charged at the same rate as an SMS. Please contact your network provider to get more information on their cost and the service availability.

Creating a text message

- Select **Messaging/New**.

There are two input modes. To switch from one mode to another (ABC mode/T9 mode), make a long press on the  key. To switch into upper case/lower case/figures make a short press on the  key.

Also you can make your choice by selecting [**Options**]/**Input mode**.

- **ABC mode**: it allows you to type letters: press on one key several times to make the letter wanted appear (for example: press twice the **2** key to display **B**).
 - Abc: first letter of the word in upper case.
 - abc: lower case text.
 - ABC: upper case text.
- **123 mode**: it allows you to type figures.

Using T9 Mode

The Easy Message T9® mode helps you to easily write your messages.

The language used is the one selected on the display of the phone (if the language selected is not compatible with the Easy Message T9®, the English language will be automatically selected).



Press once the key corresponding to the letter chosen and compose the word by continuing to press the keys corresponding to the various letters without paying attention to the display: the word is highlighted.

The same sequence of keys pressed can correspond to several words, existing on the dictionary. In this case, a list of choices is displayed. If the first word that appears is not the word you expected, press the navigator downwards or upwards to scroll through the words corresponding to this key sequence.

Once you agree on the word proposed on the screen, press the navigator rightwards to validate it or on the **0** key (which validates and inserts a space after the word), and go on writing the next word.

If the word you are expected is not proposed, please add characters until you get the message **Add a word**. Validate if the word displayed suits you or modify this word before adding it in the dictionary.

Punctuation characters

Punctuation characters are obtained by pressing the **1** key (except in **123** mode), or by briefly pressing the  key).

Accented characters

Accented characters are generated automatically in T9 mode. In ABC mode accented characters are available by pressing the key supporting the non-accented character repeatedly.

Insert items

there are two methods to insert items:

- Press [**Options**], then select **Insert Item** to add the object.
- Press the down navigator to display a line lit icons on bottom of the screen, then select the needed object.

Saving the message

- Exit the edit directly, the edited message is saved in the drafts automatically.
- Select **Save as/Draft**, if you do not want to send the message immediately or if you want to send it several times. It is saved in the **Drafts** menu.
or
- Select **Save as/Template** to use it again as a template. It is saved in the **Templates** menu.

Sending the message

Once the text is entered, press [**Options**] and select **Select recipient** or just press navigator key.

- **My contacts:** select a number in your phonebook.
- **Receiver number:** enter a number manually.
- **Email address:** enter an email address
- **Group:** select a call group.
- **Used numbers:** display the numbers of the recipient which you used before and not stored in the contacts.

Press the navigator key to send the message.

Receiving messages

When you receive a message, the phone plays the ring tone that you selected in the **Settings/Phone/Ringtones** menu, a message icon is displayed on the screen of your phone and an icon of 'MESSAGE UNREAD' will appear on the status bar at the same time.

If the new message is ignored, the icon won't disappear until the unread message is read.

Receiving icons, wallpapers or ring tones may take several seconds. The icon and the font are in italics when the download of your message is in progress.

Messaging menu

Inbox

Messages are listed in chronological order, the latest one being displayed first.

The quantity of Not Read and Not Retrieved messages is shown. Not Retrieved and Not Read messages are shown in bold.

Drafts

In this menu there are the messages created saved as drafts. When you select a message and press [**Options**], various options can be selected.

Sent

The **Sent** menu is used to store all your sent messages if you activated the option **Store sent msg** in the **Settings** menu.

Outbox

This menu displays the messages that have not been sent. You can therefore send them again.

Templates

In this menu there are the messages created saved as templates.

The same options as for the drafts are available for the templates.

Archive

This menu is used to archive your messages received. Select a received message, press [**options**] and select **Save**, then select **move to archive**.

Voicemail

This function allows you to call your voicemail.

NOTE: if your voicemail number has not been entered yet, you must enter it in the menu **Settings/Calls/Voicemail**.

Settings

This menu allows you to select various sending and receiving options and customization options to create messages.

There are three tabs that you can select by pressing the left or right navigator.

Settings

- **Signature:** to insert a text to be used as message's signature.
- **Store sent msg:** it is highly recommended that you keep this function deactivated, to avoid saturating the memory.
- **Emoticons:** it has two items (text, picture), default is picture.
- **Font size:** it has three items (small, medium, large), default is large.

SMS setting

- **Delivery report:** requests a delivery report when sending a message.
- **Expiration:** during that period, the network provider will try to send the message.
- **Message center:** taps the number of message center.
- **Connection type:** to set message connection.

MMS setting

- **Priority:** selection of a priority to send an MMS.
- **Expiration:** during that period, the network provider will try to send the MMS.

- **In-network:** to set the network connection type.
- **MMS roaming:** to set if the roaming can be used for MMS retrieval.
- **Message creation:** to launch radio button list with Free/Warm/Restricted.
- **Anonymous sender:** allows you to reject anonymous or not.
- **Read report:** to set the read report status.
- **Delivery report:** requests a delivery report when sending an MMS.
- **Slide duration:** to set the time between two slides automatic display.
- **Delayed delivery:** to set the delay to deliver the MMS.
- **Profiles:** to display the list of available MMS profiles.

Contacts

Using the contacts

Enter the **Contacts** menu, the contacts list is displayed if you already get some (otherwise, go to **Storing a new contact**).

The icon with the contact's name displays as below to show in which phonebook the contact is stored.



contact stored in the SIM card



contact stored in the phone

You can search for a contact quickly by typing the first letters. You can display it by pressing the navigator.

Storing a new contact

Display the **Contacts** menu, press [**Options**], select **Add** then **SIM** or **Mobile**.

- Enter the last name and press the navigator.
- Enter the number and press the navigator.
NOTE: you can fill other fields if you store the contact in the phone memory (first name, email, address, ringtone, photo, etc.).
- Press [**Options**] to **Validate** or press the navigator.
- Press [**Save**] to store it.

Contact options

To display the various options, select a contact and press [**Options**].

View

It allows you to display the contact's phone number.

Edit

It allows you to edit and/or modify a contact.

Add

Store a new contact into the SIM card or the phone.

Call

It allows you to call the selected contact.

Message

It allows you to send a message to the selected contact.

Send Card

It allows you to send contact details by message or *Bluetooth*[®].

Manage

- **Delete:** it allows you to delete the selected contact. The synchronisation is performed through *Bluetooth*[®] or an USB connection.
- **Copy to mobile:** allows you to copy the selected contact from the SIM card to the phone.
- **Move to mobile:** it allows you to move the selected contact stored in the SIM card to the phone memory.
- **Copy to SIM:** it allows you to copy a contact from the phone memory to the SIM card. Only the name and the first phone number will be copied.
- **Move to SIM:** it allows you to move a contact from the phone memory to the SIM card.
- **Copy all:** it allows you to copy all the contacts from one memory to the other.
- **Delete all:** it allows you to delete all the contacts.

Add to group

It allows you to add a contact to a group or to create a new group. (This menu displays when the selected contact is stored in the phone.)

View/Sort

- **View:** it allows you to select the default phonebook list (Phone, SIM, Both) when the phone switches on.
- **Sort by:** this menu allows you to select the way to sort contacts in the phonebook (by last name or first name).
NOTE: this option is available only when the contact is stored in the phone.

Advanced

Speed Dial

It allows you to assign a short number to a contact.

Show groups

A call group allows you to group contacts: this group can be used to send messages easily to all the group contacts.

By default, some groups are already created. To add contacts, select [**Options**]/**Edit** then select **Add**.

The list of contacts is displayed. Select the contacts you want and press [**Options**]/**Add**.

To create a new group:

- Select [**Options**]/**Add group**.
- Enter a name and press the navigator.
- The phone offers to add contacts either immediately (then select the contacts you want to add by pressing the navigator) or later (on a group press [**Options**]/**Edit/Add**. Select the contacts you want to add by pressing the navigator).

Memory

It shows the number of contacts stored in each memory and the available memory space.

SOS

This menu lists various emergency numbers.

Prompt to save

After an incoming or outgoing call with a number is not stored in the phonebook, this option allows you to activate or deactivate a request to store the number into the phonebook.

Allowed numbers

This menu allows you to restrict the outgoing calls. This service depends on your SIM card.

When activated this function, only the numbers stored in this phonebook can be called.

This phonebook is linked to the SIM card, and its size depends on the card's capacity.

- **Status:** allows you to activate or deactivate this service.
- **Manage FDN:** allows you to manage the numbers stored in this phonebook.

Settings as Business Card

The details of a contact stored in the phone memory can be saved as a business card.

My details

You can enter the details corresponding to your own number.

Sync. settings

You can directly enter the contacts database settings.

Sync.

You can synchronize your contacts stored in the phone memory with those of your computer electronic mails.

The synchronization is done by activating *Bluetooth*[®] or by connecting a USB cable between the phone and a computer and using **COSY Phone Suite software** (available on CD-ROM).

Camera

The **Camera** menu allows you to take photos and use them for different purposes. For instance, you can send them to another phone or an Internet address, store them and use the photos as wallpapers.

Taking a photo

Settings before taking a photo

Pressing the **left key**, various options can be selected:

- **Snap**: to take the photo.
- **Timer**: to take a photo with a 5, 10 or 15 second time delay.
- **Mode**: to select luminosity.
- **Effects**: to select an effect or you can press  key to select an effect.
- **Settings**: to select photo format, quality or click sound.
- **Pictures**: enter My files to see the taken photos, the photos stored in **Multimedia/Pictures**.

Taking a photo

- Select the **Camera** menu. Look into your phone display and position your subject. Move your phone to position your photo.
- Press the navigator, the photo is taken and automatically saved. It stays on the phone display.
- If you want to send the photo immediately, press the navigator. The creating message screen is displayed to type a text if necessary.

Options once the photo taken

Taken a photo, various options can be selected:

- **Send by**: to send the photo by Message or *Bluetooth*[®].

- **Add to contact:** to assign the photo to a contact.
- **Details:** to see the photo name, file size and date.
- **Delete:** to delete the photo.
- **Rename:** to modify the name of the photo.
- **Wallpaper:** to select the photo as a wallpaper.

NOTE: using the camera during a call may disturb the call quality.

Recording a video

Select the **Camera** menu and press the navigator rightwards or leftwards to switch between video mode and camera mode.

Settings before recording a video

Pressing [**Options**], various options can be selected:

- **Record:** to record a new video.
- **Settings:** to select the video quality, the recording time and the recording of the sound.
- **Videos:** enter My files to see the recorded videos, the videos stored in **Multimedia/Videos**.

Recording a video

- Press the navigator to record then press [**Stop**] when you want to stop recording.

The video is automatically saved and has a number. It is saved in **Multimedia/Videos**.

NOTE: the phone automatically stops recording when the maximum size available is reached.

Options once the video recorded

- **Play:** to play the video.
- **Rename:** to modify the name of the video.
- **Details:** to see the video name, file size and date.
- **Delete:** to delete the video.

- Full screen: display it with full screen.
- **Send by:** allows you to send the video by Message or *Bluetooth*[®].

NOTE: the videos are saved in the phone with a.3gp format.

Music player

This menu allows you to listen to music files in a continuous way like a portable music player.

You can download music files using WAP or connecting your phone to a computer.

You can also use a memory card in which music files are stored.

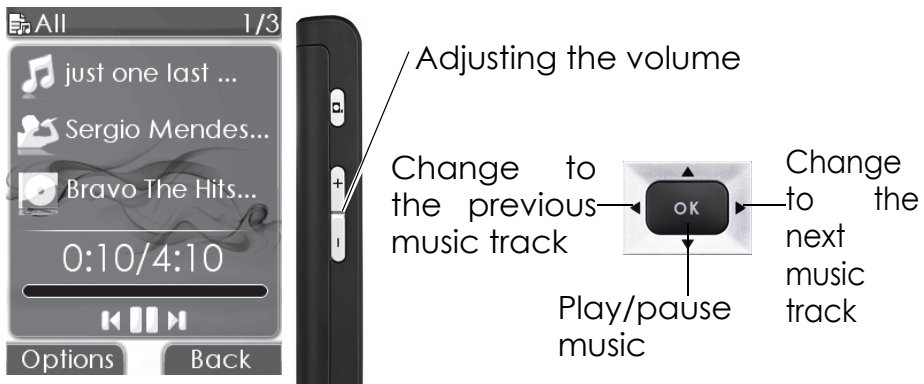

Recently played

It allows you to play a music file or several music files selected.

Music

All

It is the directory of all the music files.

To display the different options, press [**Options**]:

- Play: to play the music file or you can press [OK] key to play.
- Mode: to select the way to play the music files.
- **Playlist**: to add a music file to a playlist.

NOTE: music files stored in the memory card are automatically added to the list.

- **Send by:** to send the music file by Message or *Bluetooth*[®].
- **Details:** to display properties of the selected music file.

Playlists

New

Type a name and press [**Options**] to select [**Save**]. Then a prompt asks you if you want to insert music files now.

Recently played

The **Recently played** is an intelligent playlist, which remembers the tracks you have recently listened to.

List of the playlists

On a list press [**Options**] to display the different options:

- **Select:** to display the content of the playlist.
- **Play:** to play the playlist contents.
- **Add:** to add a music file to the playlist.
- **Delete:** to delete the playlist.
- **Rename:** to rename the playlist.

Artists

It is the directory of the music files sorted by artist.

Albums

It is the directory of the music files sorted by title.

Genres

It is the directory of the music files sorted by style.

More sounds

It allows you to download more sounds by network.

FM Radio

IMPORTANT: you must connect the hands free kit to operate the FM Radio. The radio aerial is contained in the hands free kit.

Two lists of stations are available for the FM Radio:

- **My list:** list of stations saved by the user.
- **Autoscan list:** this list is filled by the automatic search feature.

Using the FM Radio

- Start the FM Radio application from the main menu.
- To exit the FM Radio application while continuing to listen to the radio, use the [**Back**] key.
- To return to the FM Radio application, FM Radio can be found by pressing 'FM Radio' icon in main menu.
- To switch off the FM Radio, use the **Red key**.

Main screen

- To navigate through the stations saved, use the up or down directions of the navigator.
- To adjust the frequency, do short presses on the right or left directions of the navigator.
- To search for a station, do a long press on the right or left directions of the navigator.
- To adjust the sound level, use the + and - side keys.
- To mute or unmute the sound, use the  key or the central part of the navigator.



After connecting the hands free kit, select the **FM Radio** application.

[**Options**] lets you access the different functions of the radio:

- **Mute/Unmute:** sound on/off.
- **Speaker on/off:** turn on/off the loud speaker.
- **My list/Autoscan list:** select wanted channel in two lists.
- **Autoscan:** scan channels into scan list.
- **Save:** save the current used channel to my list.
- **View lists:** view the auto scan list or my list.
- **Settings:** radio can be set. It allows you to activate/deactivate RDS, activate/deactivate AF, activate Mono or activate Stereo.
- **Minimize:** make FM Radio playing in background.
- **Quit:** turn off FM Radio and quit the application.

How using the navigator while listening to the FM Radio

- **Up and down:** next/previous station (short press).
- **Left and right:** change in steps (short press) - find stations (long press).
- **Pressing central part:** mute/unmute.

NOTE: The application is started with the last used mode (preset, tuner mode, and the last used channel.)

Multimedia

The **Multimedia** menu contains the directories of all the multimedia objects recorded in your phone and the downloaded objects (photos, videos, ringtones, etc.).

To display the various options, press [**Options**] after having selected an object.

- **Browse:** displays the list of the objects.
- **Rename:** modifies the directory name (only the directories created by the user).
- **Delete:** deletes the directory, you can select delete current object or all objects (only the directories created by the user).
- **Format:** this option will delete all the internal memory of the Memory card (this menu only displays when the Memory card insert).
- **Memory:** displays the memory used and available for the multimedia objects.
- **Select:** this option is used to mark one or all objects to do delete, do copy or move operation (only the directories created by the user).
- **Quit:** Exit Multimedia module.

NOTE: you can create new folder after you enter a folder by phone.

Applications

NFC

What is NFC?

Near Field Communication or NFC, is a short-range (about a 10 centimeter, around 4 inches) wireless connectivity technology standard designed for intuitive, simple and safe communication between electronic devices. Applications of NFC technology include contactless transactions such as payment and transit ticketing, simple and fast data transfers including electronic business cards and access to online digital content.

How does NFC work?

NFC is based on contactless and Radio Frequency Identification (RFID) solutions, which consist of a TAG and a reader. The reader, when activated, emits a short-range radio signal that powers up a microchip on the TAG, and allows for reading a small amount of data that can be stored on the TAG. NFC is different from other contactless or RFID technologies in that it has a very short operating distance.

When the user shares to the TAG, his/her device reads the content of the TAG and executes it into action. The user only accepts the execution, eg opening a web page, calling a favorite number, or sending an SMS.

TAG features

NFC can support use the following TAG types:

- type1: Topaz[®].
- type2: MIFARE[®] Ultralight, Ultralight-C.
- type3: FeliCa(non-secure).

- type4: MIFARE[®] Pro, MIFARE[®] DESFire.
- type5: Picopass.

A TAG can contain a shortcut which can be an SMS-based service, an URL of an Internet-based service, or a phone number of a telephone service, etc.

NOTE: before using this function, you need activate NFC function, the menu **Settings/Connectivity/NFC** or **Connectivity/NFC** must be selected on, the details please see **NFC** on page 58.

Share to TAG

Your new COSY Phone has a special feature, known as NFC (Near Field Communication), which enables you to perform useful actions just by touching the back of your COSY Phone over a card known as a “TAG” or “Target”.

You can setup different TAGs or Targets to do different things. This includes:

- Ringing a number
- Sending a text
- Going directly to a web address
- Setting the phone to silent
- Setting an alarm

Setting Up TAGs

To set up a new TAG all you have to do is touching the back of the COSY Phone slowly over a blank TAG. You can then follow the instructions on the screen.

It will take you through the following steps:

- Select type of action you would like the TAG to perform,
- Enter the details for that action,
- Touch the phone over the TAG again to complete the set up of the TAG.

Using TAGs

To use a TAG, simply touch the back of your COSY Phone slowly across these symbols:

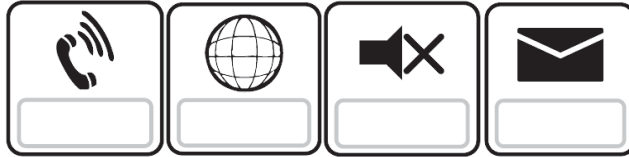

The COSY Phone will then respond and ask you to confirm the action that you want to do.

Duplicate TAG

Go in the Application menu then NFC menu, select the Duplicate option, then simply touch the back of your COSY Phone slowly across the TAG to duplicate. Once prompt by the COSY Phone simply touch the back of your COSY Phone slowly across the TAG to set.

NOTE:

- If the content in the TAG is not a normal NDEF message , it will display "Unknow TAG data".
- If the TAG is not supported by the NFC, it will display "A card detected".
- When keypad is locked and back light is off, TAG can not be read.

WARNING:

- Don't place TAGs on metal or other conductive surfaces, as it would not work on this material.
- Don't remove the NFC antenna located inside the back cover.

ToDo

This menu allows you to add ToDos, access category-based Todo management and delete one or all the ToDos.

If there is not any ToDo, you directly access to the options below.

- **Written todo/Vocal todo:** to add ToDo of the text or voice type. Fill in the different items. Save the ToDo.
- **Settings:** to select various settings for the ToDo.
- **Import:** to import a ToDo from a **Multimedia** directory.
- **Sync.:** you can synchronize a ToDo with data of your computer. The synchronization is done by activating *Bluetooth*[®] or by connecting a USB cable between the phone and a computer and using COSY Phone Suite software (available on CD-ROM).
- **Sync. settings:** you can directly enter the ToDo's database settings.

ToDo actions menu

This menu allows you to do all the actions possible on any ToDo. To display a ToDo, select it in the list and press the navigator.

To display the different options, press [**Options**].

- **Done/Undone:** mark the ToDo done or undone.
- **View:** to see the ToDo details information.
- **Edit:** to modify the ToDo properties.
- **Send by :** to send the ToDo by Message or *Bluetooth*[®].
- **Delete:** to delete the ToDo.
- **Export:** to copy the event to the **Multimedia/Others** directory.

Clock

Alarm

This menu allows you to set and activate the alarm.

- Select **OK** key or **[Edit]**.
- Enter the time selected for the alarm, setting alarm recurrence, sound, whether need vibration, alarm text.
- Select **[save]**, it prompt alarm activated.

If there is an activated alarm, press **[Options]** to display the options.

- **Edit:** Enter into alarm settings screen, modify this alarm properties.
- **Off:** Turn this alarm off.
- **Share:** share to TAG.

NOTES:

- The alarm works even when the phone is switched off.
- The alarm icon appears on the idle screen.

Stopwatch

This menu allows you to use the chronometer function and to store the lap times.

Timer

This menu allows you to use the timer function.

Sync.

This menu allows you to activate the synchronization for the Contacts, Calendar or ToDo functions.

Calculator

This menu allows you to use your phone as a calculator.

Use the following keys to make calculations:

- ▲: Add, ▼: Subtract, ◀: Multiply, ▶: Divide.

The following keys are used for:

- **Left key**: Convert or add to memory.
- **Right key**: Delete.
-  : Decimal point.

Torch

This menu is used to turn on or turn off the torch lamp.

You can assign a shortcut to one of the navigator keys (**Settings/Display/Shortcuts** menu).

Local info.

This menu is used to activate reception of local information broadcast by the network.

You can choose whether you want to receive this information or not (please contact your network provider).

Services

This item may not be present on your phone's menu, as its contents depend on your SIM.

Recorder

This menu allows you to record your voice or a sound.

Calendar

This menu gives you access to your diary and get to a day, week, month or specific date. It allows you to add events, access the global actions for all the events and manage them by event category.

Month

To access events on a month-by-month basis.

Week

To access events on a week-by-week basis.

Today

To access the events for the current day and the actions possible on any event.

Date

Allows you to access events at a specific date.

Options

- **Written event/Vocal event:** to add events of the text or voice type. Fill in the different items. Save the event.
- **Delete:** to delete events by selection of a date.
- **Memory:** to view the memory capacity used by the different functions of your phone (audio, video, picture, etc.).
- **Sync.:** you can synchronize your calendar with data of your computer. The synchronization is done by activating *Bluetooth*[®] or by connecting a USB cable between the phone and a computer and using COSY Phone Suite software (available on CD-ROM).
- **Sync. settings:** you can directly enter the calendar database settings.

Settings

To select various settings for the events.

Help

This menu allows you to display help pages for the using of your phone.

First select the language you want.

NOTE: displaying help pages is done with a free WAP connection.

Entertainment

Games



Your phone contains one or several games, either a complete or demo version according to the model. You can download more. You can download applications and games to be executed on your phone thanks to the built-in Java™ engine.

However, receiving applications from anywhere implies some basic knowledge of the possible effects of such downloading.

We recommend you to download certified games or applications from your operator sites. By default, the connection URL of your operator is configured in your phone.

Press **[OK]** to run game.

To display the various options, press **[Options]**:

- **Install**: to download games, applications and utilities in your phone. Downloading is done through the browsing function.
- **Local Files**: to select local games to install.
- **Certificates**: display the trust authentications.

Applications

This menu contains your java downloads (applets). Press **[OK]** to run applets.

Running Applications

This menu lists all the applications that are running on the phone.

Settings

To display and edit the list of available java profiles and display about Myriad Jbed information.

Browser

The Browser function allows you to log onto certain Internet sites. You can log onto sites that allow you to download ringtones, icons, animated screensavers, Java™ applications, videos to your phone.

The WAP browser is under licence.



- **Select:** to open the selected link.
- **Display mode:** to select display mode, normal screen or wide screen.
- **Open:** to type an Internet address.
- **Bookmarks:** to store bookmarks (addresses of internet sites). A bookmark stored in the list can be modified, sent or deleted.
You can receive bookmarks and add them to this list.
- **More:** allows you to more options function.
 - **Add to bookmarks:** add current URL to bookmarks.
 - **History:** backward and forward navigation of the pages displayed are kept in memory.
 - **Refresh:** again display current URL and display the latest content.
 - **Home:** logs onto the home page (carries the name of your access provider).
 - **Save this page:** save current page on Internet sites out of connection (WARNING: these pages will not be updated).

- **Save items:** save items to your phone.
 - **Set homepage:** set current URL address to home page.
 - **Details:** display Current URL tile, address, mime type and size.
 - **Send by:** send current URL address by message or *Bluetooth*[®].
 - **Privacy:** clear history, cache, or cookies etc.
 - **Settings:** various settings for the WAP connection.
 - **Alert inbox:** this menu contains information messages about sending and receiving (deliveries, failures, etc.).
 - **About:** display browser software name and version.
- **Quit:** exit the Browser module.

Logging on

The connection to a service on the GPRS/EDGE/UMTS/HSDPA network is not cut if an incoming call is received. You can answer the call.

Downloading objects

Some Internet sites allow you to download ringtones, icons, animated screensavers, games or Java™ applications. Once downloaded, they are stored in your phone's memory (**Multimedia**). You can then save them in your phone (same operation as used for downloading using messages).

Logging off

To log off, press the red key. The log off happens automatically after a few seconds of inactivity if you forget to log off. This period is defined by the linger time setting.

Connectivity

You can send files to another mobile or a computer by using Bluetooth, USB, or Sync. settings, configure network preferences and set various parameters needed for Brower connection.

Bluetooth[®]

Bluetooth[®] is a technology used to establish a wireless connection with other *Bluetooth[®]* equipped devices: for example, with a pedestrian kit or a car kit to phone or with a PC to swap data. The range is about 10 m.

The *Bluetooth[®]* menu contains the following entries:

Mode

With this menu you can, on the one hand, activate and deactivate the *Bluetooth[®]* function and, on the other, when the *Bluetooth[®]* function is activated, select whether you want other *Bluetooth[®]* devices to be able to detect your device.

- **Off:** the *Bluetooth[®]* function is not available.
- **On, hide:** the *Bluetooth[®]* function is activated and your phone is not visible. It cannot be detected by other *Bluetooth[®]* devices. In this mode, a device can only connect to your phone using *Bluetooth[®]* if you have already paired it. This mode lets you detect other devices and pair with them from your phone.
- **On, visible for 3 minutes:** the *Bluetooth[®]* function is activated and your phone is visible for 3 minutes. After 3 minutes, Bluetooth remains activated but your phone is no longer visible.

- **On, visible:** the *Bluetooth*[®] function is activated and your phone is visible, it can be detected by the other *Bluetooth*[®] devices as long as this mode is selected.

IMPORTANT:

- The **Off** option ensures the best battery life for your phone.
- *Bluetooth*[®] security is better guarded because your phone remains invisible to the other devices.

My devices

This menu is used to draw up the list of devices with which the *Bluetooth*[®] connection is secure (by authentication and encryption).

A device must be added to this list before it can be used in *Bluetooth*[®] with your phone except for exchanging objects. When you select send by *Bluetooth*[®] (photo, Todo task, contact details, etc.) the phone displays the list of devices. You do not need to select a device from this list at this time, you can start a one-off search for a device when you initiate sending.

See below for the pairing procedure.

Pairing procedure

Select **My devices/New Device**.

If the *Bluetooth*[®] function is not active, the phone prompts that "You should active your Bluetooth first. Activate it temporary?" If select Yes, the mode of *Bluetooth*[®] would be On, visible for 3 minutes.

The phone searches for visible *Bluetooth*[®] devices and displays the list. Select the device concerned and validate your choice. Your phone then prompts you to enter a code which must be the same as the code entered on the remote device. Enter and validate this code: Your phone is now paired with the remote device.

[**Options**] on the name of a device lets you access the following options:

- **Rename**: this is used to modify the name of the device.
- **Delete**: this is used to delete the device. **WARNING**: using this function needs starting the pairing over again.
- **Mark Trusted/untrusted**: this is used to trust/untrusted the device.
- **Delete all**: this is used to delete all your devices. **WARNING**: using this function needs starting the pairing over again.

NOTES:

- Refer to the user manual of the device with which you are pairing to find out how to set this device to the mode allowing this operation.
- The code of the remote device may be predefined by the device manufacturer. In this case, refer to the user manual of this device to find out this code.

Bluetooth[®] name

This is the name used to identify your phone when it is detected by another *Bluetooth[®]* device.

GPS

A-GPS On/Off

Select on/off to activate/deactivate A-GPS function.

Profiles

This menu is used to setting the profile for A-GPS. If the state of **A-GPS On/Off** is On, then you should setting the correct profile for A-GPS.

USB mode

This mode allows you to access from a computer, the files you have saved in the phone memory or on the memory card.

Memory card access

- You must first install an USB driver on your computer (available on CD-ROM).
- After connection of the USB cable between the phone and the PC, if this function is activated, you can use the Windows file explorer to consult your multimedia files on your phone and swap data between the phone and computer, etc.

IMPORTANT NOTE: when the phone is connected to the computer in USB mode:

- The memory card is not detected by the phone. This means that if you have configured your phone with a background or ringtone stored on the memory card, they will not be used during this connection.
- The camera is also not accessible, either in photo mode or video mode.
- You cannot access your files from the phone when the USB cable is connected. In the event of a specific need, select **Off** in the **Memory card access** option so you can just access your files from the phone. You will not be able to access them from the computer.

Charge

If this function is activated, the phone can charge when plugged on USB.

Sync. settings

This menu allows you to configure all the synchronization parameters. You can synchronize your contacts, your calendars or your ToDos with your archives stored in your computer. Use the COSY Phone Suite and configure your USB connection or activate *Bluetooth*[®].

Profiles

This menu allows you to set various parameters needed for all the network connection.

Networks

This menu allows you to configure network preferences.

- **Search:** to activate (automatic or manual) one of the networks accessible in the area in which you are located.
- **Preferred Networks:** to view all the pre-registered networks.
- **Settings:** to select your network Automatic, GSM, UMTS.

NFC

Select on/off to activate/deactivate NFC function.

If you want to use NFC function, this option should be selected **On**. After you activate this function, the NFC-radio-on icon  would display in the status bar.

Settings

Phone

Profiles

This menu allows you to set profiles containing selections of different volume to adapt them to various circumstances (for instance, depending on where you are (at work, at home, etc.), you will select such or such profile.

NOTES:

- From the idle screen, you can directly access to the profiles by pressing the +/- side key.
- From the idle screen, you can activate silent mode by a long press on the  key.

Ringtones

This menu allows you to display and if necessary modify the ring tones selected for calls and messages.



Date&Time

Set time/Set date

These menus are used to set the various date and time settings (format, display, time zone, daylight saving, etc).

Keypad lock

This menu allows you to lock the keyboard to avoid unwanted key presses.

- **Automatic:** once the time set in eco-mode elapsed (**Settings/Display/Backlight/Eco. mode** menu), the keypad locks.
- **Manual:** lock the keypad pressing the  key and then press [OK], or making a long press the  key from the idle screen.

Unlocking the keyboard

To unlock the keyboard, press the  key then the navigator or **[OK]**.

Languages

This menu allows you to choose your phone's display language.

Security

This menu allows you to configure your phone's security settings.

PIN protection

This menu allows you to activate or deactivate the PIN code when switching on the phone.

PIN modification

This menu allows you to modify your phone's PIN.

To modify the PIN, select **PIN modification** and **[Select]**.

Enter old PIN and validate.

Enter new PIN twice and validate.

PIN 2 modification

You have a second PIN number to allow you to access certain functions (*).

Proceed as above in order to modify PIN number 2 of your phone.

Phone lock

This menu allows you to activate a code which will be requested when the phone is switched on if a different SIM card is used. This code is automatically linked to the SIM card installed when the phone is activated. This code is a secret code to protect the phone if stolen.

() These functions may or may not be available depending on your SIM card.*

To activate or deactivate the code:

- Select **Lock mode** and [**Select**].
- Select **On** or **Off** .
- Enter 0000 (the factory code, by default) and validate.

To modify the phone code:

- Select **Change** and [**Select**].
- Enter the old code and validate.
- Enter the new code and validate.
- Enter the code again to confirm it and validate.

Confidentiality

This menu allows the activation or deactivation of automatic deletion, after power off/on, of outgoing calls, messages stored or diary.

Select **On** or **Off** and [**Save**].

Operator

This menu allows you to modify the call barring.

Access to this service depends on your type of subscription.

Camera & Voice

This menu allows you to select the camera, video and voice recorder settings.

Storage

This menu allows you to select (phone memory or memory card) where the sounds, pictures, videos or applications downloaded will be stored.

Memory

This menu displays the memory space used for the various functions.

HAC

Select on/off to activate/deactivate this function.

HAC is short for Hearing Aid Complicance, to measure the compatibility of phone working with hearing aids. The target is to ensure that hearing impaired people can use phone as ordinary people.

HAC of COSY Phone have two modes, M mode and T mode, M mode makes phone as little electromagnetic radiation interference as possible to hearing aids, T mode makes phone receiver to eradiate magnetic field as strong as possible, which this two modes improve usability with hearing devices. After activate this function, the user can select related mode basis different hearing aid to better to use this function.

Haptics

Select on/off to activate/deactivate this function.

This menu is used for launching or closing vibration effects only related to different keys and NFC actions.

Press different kinds of keys will correspond to different vibration effects. And similar keys will have the same effect from vibrator.

Display

Wallpaper

Press the navigator. You can select a wallpaper through the phone default wallpapers and the pictures downloaded (**More files**) or no wallpaper (**None**).

Select [**Save**] once your choice made.

Backlight

You can choose the backlight level, economic mode and the way to exit the economic mode (any key or red key).

Startup animation

This menu allows you to display an animation when the phone is switched on.

Operator logo

This menu allows you to display your operator's logo on the idle screen (depending on model).

Shortcuts

This menu allows you to allocate functions to the directional keys of the navigator.

Calls

Please see **Call Settings** on page 20.

Connectivity

Please see **Connectivity** on page 54.

Technical features

Weight: 103 g

Size: 111.9 x 49.9 x 12.9 mm

Original battery: Li-ion 900 mAh

Battery life (*):

- Standby: up to 240 h
- Calls: GSM up to 4 h, WCDMA up to 3.5 h
- Music mode: headset up to 15 h

Camera: 1.3 megapixels

Multimedia objects supported:

- Audio formats: Midi, SP-Midi, WAV, AMR NB, MP3, AAC, AAC+, eAAC+
- Graphic formats: bmp, jpeg, png, gif, svg Tiny
- Video formats: H.263, H.264, 3GP, MPEG4

Size of memory available for messages, the phonebook and the multimedia objects: up to 128 Mb

Maximum size of each message:

- SMS: < 640 characters
- MMS: the phone supports MMS sizes up to 300 KB both for outgoing and incoming messages (depending on the phone configuration and on the operator reservations)

Memory card type: microSHDC™

Operating temperature: - 10 °C to + 55 °C

() These values are theoretical ones and given for information only.*

Declaration of conformity



Déclaration CE de Conformité

CE Declaration of Conformity

Fabricant
Manufacturer Sagem Wireless

Adresse
Address 38 Rue de Berri, 75008 Paris

Declares under our sole responsibility that our product

Nom du produit
Product Name Quad Band GSM/GPRS/EDGE/UMTS/HSDPA/HSUPA Band 1/8 COSY Phone 3G

est conforme aux exigences des directives européennes suivantes :
conforms to the requirements of the following EEC directives:

EEC Directive 1999/5/EC

Sécurité (Safety) EN 60950-1

CEM (EMC) EN 301 489-1
EN 301 489-3
EN 301 489-7
EN 301 489-17
EN 301 489-24

Réseau (Network) ETSI EN 301 511 v 9.0.2
ETSI EN 301 908-1 v 3.2.1
ETSI EN 301 908-2 v 3.2.1
EN 300 328
EN 300 440-1
EN 300 440-2
EN 302 291-1
EN 302 291-2

Santé (Health) EN 50360, EN 62209-1, EN 62209-2

FM EEC Directive 2004/108/EC

CEM (EMC) EN 55013
EN 55020

Notified Body ID 0678

Place and date of issue Cergy, 10/09/2010

Signature

François GUERINEAU
Executive VP, R & D and Product Planning

Certification and safety information for the united states and countries using fcc standards

FCC Part 15 statement

This device complies with part 15, part 22 and part 24 of the FCC rules. Operation is subject to the following two conditions: (1) this device may not cause harmful interference, and (2) this device must accept any interference, including interference that may cause undesired operation.

This equipment has been tested and found to comply with the limits for a Class B digital device, pursuant to Part 15 of the FCC Rules. These limits are designed to provide reasonable protection against harmful interference in a residential installation. This equipment generates, uses and can radiate radio frequency energy and, if not installed and used in accordance with the instructions, may cause harmful interference to radio communications. However, there is no guarantee that interference will not occur in a particular installation. If this equipment does cause harmful interference to radio or television reception, which can be determined by turning the equipment off and on, the user is encouraged to try to correct the interference by one or more of the following measures:

- Reorient or relocate the receiving antenna.

- Increase the separation between the equipment and receiver.
- Connect the equipment into an outlet on a circuit different from that to which the receiver is connected.
- Consult the dealer or an experienced radio/TV technician for help.

WARNING

Changes or modifications made to this equipment not expressly approved by SAGEM Wireless for compliance could void the user's authority to operate the equipment.

NOTICE:

This device complies with Part 15 of the FCC Rules [and with RSS-210 of Industry Canada].

Operation is subject to the following two conditions:

1. this device may not cause harmful interference, and
2. this device must accept any interference received, including interference that may cause undesired operation.

NOTICE:

Changes or modifications made to this equipment not expressly approved by (manufacturer name) may void the FCC authorization to operate this equipment.

FCC SAR information

THIS MODEL PHONE MEETS THE FCC'S REQUIREMENTS FOR EXPOSURE TO RADIO WAVES

Your wireless phone is a radio transmitter and receiver. It is designed and manufactured not to exceed the limits for exposure to radiofrequency (RF) energy set by the United States Federal Communications Commission (FCC). These limits are part of comprehensive guidelines and establish permitted levels of RF energy for the general population. The guidelines are based on standards that were developed by

independent scientific organizations through periodic and thorough evaluation of scientific studies. The standards include a substantial safety margin designed to assure the safety of all persons, regardless of age and health.

The exposure standard for wireless mobile phones employs a unit of measurement known as the Specific Absorption Rate, or SAR. The SAR limit set by the FCC and Health Canada is 0.979 W/kg (*). Tests for SAR are conducted using standard operating positions accepted by the FCC with the phone transmitting at its highest certified power level in all tested frequency bands. Although the SAR is determined at the highest certified power level, the actual SAR level of the phone while operating can be well below the maximum value. This is because the phone is designed to operate at multiple power levels so as to use only the power required to reach the network. In general, the closer you are to a wireless base station antenna, the lower the power output.

Before a phone model is available for sale to the public, it must be tested and certified to the FCC that it does not exceed the RF limit established by the government-adopted requirement for safe exposure. The tests are performed in positions and locations (i.e., at the ear and worn on the body) as required by the FCC for each model.

The highest SAR value for these model phones as reported to the FCC when tested for use at the ear and when worn on the body are (measured at a distance of 0.59 inches (1.5 cm)):

() In the United States and Canada, the SAR limit for mobile phones used by the public is 1.6 watts/kilogram (W/kg) averaged over one gram of tissue. The standard incorporates a substantial margin of safety to give additional protection for the public and to account for any variations in measurements.*

SAR at the ear (W/kg)		SAR worn of the body (W/kg)	
GSM 850	PCS 1900	GSM 850	PCS 1900
0.976	0.993	0.786	0.333

While there may be differences between the SAR levels of various phones and at various positions, they all meet the FCC requirement. The FCC has granted an Equipment Authorization for this model phone with all reported SAR levels evaluated as in compliance with the FCC RF exposure guidelines. SAR information on this model phone is on file with the FCC and can be found under the Display Grant section of <http://www.fcc.gov/oet/fccid> after searching on FCC ID M9HCOSY2G/M9HCOSY3G (COSY Phone 2G/COSY Phone 3G). Additional Information can be found on the website of the World Health Organization (<http://www.who.int/emf>).

Safety Information

Aircraft: Switch off your wireless device whenever you are instructed to do so by airport or airline staff. If your device offers a “flight mode” or similar feature, consult airline staff as to its use in flight.

Driving: Full attention should be given to driving at all times, and regulations restricting the use of wireless devices while driving must be observed. For further driving safety tips, please refer to Driving safety tips at page 70.

Hospitals: Mobile phones should be switched off whenever you are requested to do so in hospitals, clinics or health care facilities. These requests are designed to prevent possible interference with sensitive medical instruments.

Gas stations: Obey all posted signs with respect to the use of wireless devices or other radio equipment in locations with flammable material and chemicals. Switch of your wireless

device whenever you are instructed to do so by authorized staff.

Interference with personal medical devices: You should always consult your physician and review the device manufacturer's instructions to determine if operation of your phone may interfere with the operation of your medical device.

As a general rule:

For pacemakers: Pacemaker manufacturers recommend that a minimum separation of 6 inches (15 cm) be maintained between a mobile phone and a pacemaker to avoid potential interference with the pacemaker. To achieve this, use the phone on the opposite ear to your pace maker and do not carry it in a breast pocket.

For hearing aids: Some digital wireless phones may interfere with some hearing aids. In the event of such interference, you may want to consult your hearing aid manufacturer to discuss alternatives.

The ring tone, info tones, and handsfree talking are reproduced through the loudspeaker. Do not hold the phone to your ear when it rings or when you have switched on the handsfree function (at least 3.9 inches (10 cm)).

Use only batteries and charging devices designed for your phone. Otherwise you risk serious damage to health and property and may void any warranty.

CAUTION! Small parts like the SIM card could be swallowed by young children.

Do NOT open the phone. Only the battery and the SIM card may be removed. Do NOT open the battery.

Keep the battery out of children's reach. Do not allow the battery to be put into the mouth.

Distance of operation

This phone is designed to comply with the FCC radio frequency (RF) exposure guidelines when used as follows:

- **Against the ear:** Place or receive a phone call and hold the phone as you would a wireline telephone.
- **Body worn:** When transmitting, place the phone in a carrying accessory that contains no metal and positions the phone a minimum of 0.59 inches (1.5 cm) from your body. Use of other accessories may not ensure compliance with exposure guidelines. If you do not use a body worn accessory and are not holding the phone at the ear, position the phone a minimum of 0.59 inches (1.5 cm) from your body.
- **Data operation:** When using a data feature, position the phone a minimum of 0.59 inches (1.5 cm) from your body for the whole duration of the data transmission.

FDA consumer information on wireless phones

The US Food and Drug Administration (FDA) provides consumer information on wireless phones at: <http://www.fda.gov/cellphones/qa.html>.

Following are safety related questions and answers discussed at this web site:

Do wireless phones pose a health hazard?

The available scientific evidence does not show that any health problems are associated with using wireless phones. There is no proof, however, that wireless phones are absolutely safe. Wireless phones emit low levels of radiofrequency energy (RF) in the microwave range while being used. They also emit very low levels of RF when in the stand-by mode. Whereas high levels of RF can produce

health effects (by heating tissue), exposure to low level RF that does not produce heating effects causes no known adverse health effects. Many studies of low level RF exposures have not found any biological effects. Some studies have suggested that some biological effects may occur, but such findings have not been confirmed by additional research. In some cases, other researchers have had difficulty in reproducing those studies, or in determining the reasons for inconsistent results.

What is FDA's role concerning the safety of wireless phones?

Under the law, FDA does not review the safety of radiation-emitting consumer products such as wireless phones before they can be sold, as it does with new drugs or medical devices. However, the agency has authority to take action if wireless phones are shown to emit radiofrequency energy (RF) at a level that is hazardous to the user. In such a case, FDA could require the manufacturers of wireless phones to notify users of the health hazard and to repair, replace or recall the phones so that the hazard no longer exists.

Although the existing scientific data do not justify FDA regulatory actions, FDA has urged the wireless phone industry to take a number of steps, including the following:

- Support needed research into possible biological effects of RF of the type emitted by wireless phones;
- Design wireless phones in a way that minimizes any RF exposure to the user that is not necessary for device function; and
- Cooperate in providing users of wireless phones with the best possible information on possible effects of wireless phone use on human health.

FDA belongs to an interagency working group of the federal agencies that have responsibility for different aspects of RF

safety to ensure coordinated efforts at the federal level. The following agencies belong to this working group:

- National Institute for Occupational Safety and Health
- Environmental Protection Agency
- Federal Communications Commission
- Occupational Safety and Health Administration
- National Telecommunications and Information Administration

The National Institutes of Health participates in some interagency working group activities, as well.

FDA shares regulatory responsibilities for wireless phones with the Federal Communications Commission (FCC). All phones that are sold in the United States must comply with FCC safety guidelines that limit RF exposure. FCC relies on FDA and other health agencies for safety questions about wireless phones.

FCC also regulates the base stations that the wireless phone networks rely upon. While these base stations operate at higher power than do the wireless phones themselves, the RF exposures that people get from these base stations are typically thousands of times lower than those they can get from wireless phones. Base stations are thus not the primary subject of the safety questions discussed in this document.

What is FDA doing to find out more about the possible health effects of wireless phone RF?

FDA is working with the U.S. National Toxicology Program and with groups of investigators around the world to ensure that high priority animal studies are conducted to address important questions about the effects of exposure to radiofrequency energy (RF).

FDA has been a leading participant in the World Health Organization International Electromagnetic Fields (EMF) Project since its inception in 1996. An influential result of this

work has been the development of a detailed agenda of research needs that has driven the establishment of new research programs around the world. The Project has also helped develop a series of public information documents on EMF issues.

FDA and the Cellular Telecommunications & Internet Association (CTIA) have a formal Cooperative Research and Development Agreement (CRADA) to do research on wireless phone safety. FDA provides the scientific oversight, obtaining input from experts in government, industry, and academic organizations. CTIA-funded research is conducted through contracts to independent investigators. The initial research will include both laboratory studies and studies of wireless phone users. The CRADA will also include a broad assessment of additional research needs in the context of the latest research developments around the world.

What steps can I take to reduce my exposure to radiofrequency energy from my wireless phone?

If there is a risk from these products--and at this point we do not know that there is--it is probably very small. But if you are concerned about avoiding even potential risks, you can take a few simple steps to minimize your exposure to radiofrequency energy (RF). Since time is a key factor in how much exposure a person receives, reducing the amount of time spent using a wireless phone will reduce RF exposure.

If you must conduct extended conversations by wireless phone every day, you could place more distance between your body and the source of the RF, since the exposure level drops off dramatically with distance. For example, you could use a headset and carry the wireless phone away from your body or use a wireless phone connected to a remote antenna.

Again, the scientific data do not demonstrate that wireless phones are harmful. But if you are concerned about the RF exposure from these products, you can use measures like those described above to reduce your RF exposure from wireless phone use.

What about children using wireless phones?

The scientific evidence does not show a danger to users of wireless phones, including children and teenagers. If you want to take steps to lower exposure to radiofrequency energy (RF), the measures described above would apply to children and teenagers using wireless phones. Reducing the time of wireless phone use and increasing the distance between the user and the RF source will reduce RF exposure. Some groups sponsored by other national governments have advised that children be discouraged from using wireless phones at all.

Do hands-free kits for wireless phones reduce risks from exposure to RF emissions?

Since there are no known risks from exposure to RF emissions from wireless phones, there is no reason to believe that handsfree kits reduce risks. Hands-free kits can be used with wireless phones for convenience and comfort. These systems reduce the absorption of RF energy in the head because the phone, which is the source of the RF emissions, will not be placed against the head. On the other hand, if the phone is mounted against the waist or other part of the body during use, then that part of the body will absorb more RF energy. Wireless phones marketed in the U.S. are required to meet safety requirements regardless of whether they are used against the head or against the body. Either configuration should result in compliance with the safety limit.

Do wireless phone accessories that claim to shield the head from RF radiation work?

Since there are no known risks from exposure to RF emissions from wireless phones, there is no reason to believe that accessories that claim to shield the head from those emissions reduce risks. Some products that claim to shield the user from RF absorption use special phone cases, while others involve nothing more than a metallic accessory attached to the phone. Studies have shown that these products generally do not work as advertised. Unlike "hand-free" kits, these so-called "shields" may interfere with proper operation of the phone. The phone may be forced to boost its power to compensate, leading to an increase in RF absorption.

Driving safety tips

Wireless phones give people the ability to communicate almost anywhere, anytime. But an important responsibility accompanies those benefits, one that every wireless phone user must uphold. When driving a car, driving is your first responsibility.

Below are safety tips to follow while driving and using a wireless phone that should be easy to remember.

Get to know your wireless phone and its features such as speed dial and redial.

When available, use a hands free device.

Position your wireless phone within easy reach and where you can grab it without removing your eyes from the road. If you get an incoming call at an inconvenient time, if possible, let your voice mail answer it for you.

Let the person you are speaking with know you are driving; if necessary, suspend the call in heavy traffic or hazardous weather conditions.

Do not take notes or look up phone numbers while driving.

Dial sensibly and assess the traffic; if possible, place calls when you are not moving or before pulling into traffic. Try to plan your calls before you begin your trip. But if you need to dial while driving, follow this simple tip--dial only a few numbers, check the road and your mirrors, then continue.

Do not engage in stressful or emotional conversations that may be distracting.

Use your wireless phone to call for help. Dial 9-1-1 or other local emergency number in the case of fire, traffic accident, road hazard or medical emergency.

Use your wireless phone to help others in emergencies. If you see an auto accident, crime in progress or other serious emergency where lives are in danger, call 9-1-1 or other local emergency number.

Call roadside assistance or a special wireless non-emergency assistance number when necessary. If you see a broken-down vehicle posing no serious hazard, a broken traffic signal, a minor traffic accident where no one appears injured or a vehicle you know to be stolen, call roadside assistance or other special non-emergency wireless number.

CAUTION
RISK OF EXPLOSION IF BATTERY IS REPLACED
BY AN INCORRECT TYPE.
DISPOSE OF USED BATTERIES ACCORDING
TO THE INSTRUCTIONS

use only the appropriate adaptors and batteries as shown in the phone manufacturer's catalogue.

For customers in the United States

LIMITED WARRANTY

Brightstar US, Inc. (Brightstar) warrants this product including any accessories sold for use with the products against defects in materials or workmanship under normal usage for the periods outlined in the warranty provided with the product, as follows:

DEAD ON ARRIVAL / OUT OF BOX FAILURE (DOA):

This product is for standard consumer use only and is guaranteed to be in proper working order as is determined upon initial removal from the package and subsequent power up and test call. If this product is determined to be defective, Brightstar will repair or replace the product, at its option, at no charge.

OUT OF WARRANTY REPAIR

Any unit requiring repair not covered by the warranty requires authorization from your service provider and Brightstar. Contact your service provider to obtain this authorization. This warranty is valid only in the United States.

OTHER CONDITIONS

If Brightstar chooses to replace the equipment, Brightstar may replace it with reconditioned equipment. Parts used in repairing or replacing the equipment will be warranted for 90 days from the date the equipment is returned to you. This warranty is not transferable.

LIMITATIONS AND EXCLUSIONS

TO THE EXTENT PERMITTED BY APPLICABLE LAW, BRIGHTSTAR WILL NOT BE RESPONSIBLE FOR ANY IMPLIED WARRANTIES,

INCLUDING WITHOUT LIMITATION, THE IMPLIED WARRANTIES OF MERCHANTABILITY OR FITNESS FOR A PARTICULAR PURPOSE. BRIGHTSTAR WILL NOT, IN ANY EVENT, BE LIABLE IN CONTRACT OR TORT FOR DAMAGES IN EXCESS OF THE PURCHASE PRICE OF THE PRODUCT OR ACCESSORY, OR FOR ANY INCIDENTAL, INDIRECT, SPECIAL OR CONSEQUENTIAL DAMAGES OF ANY KIND, INCLUDING TRAVEL EXPENSE, TELEPHONE CHARGES, LOSS OF REVENUE, LOSS OF TIME, INCONVENIENCE LOSS OF USE OF EQUIPMENT, LOSS OF INFORMATION OR DATA, OR OTHER DAMAGE OR LOSS CAUSED BY OR IN CONNECTION WITH THE PRODUCTS, ACCESSORIES, SOFTWARE OR EQUIPMENT FAILING TO FUNCTION PROPERLY. THIS WARRANTY SETS FORTH ALL OF BRIGHTSTAR'S RESPONSIBILITIES REGARDING THIS PRODUCT AND ITS ACCESSORIES.

Some states and jurisdictions do not allow the exclusion or limitation of incidental or consequential damages, or allow limitations on how long an implied warranty lasts, so the above limitations or exclusions may not apply to you.

Limited Warranty

The mobile phone and software program developed by SAGEM Wireless (SAGEM) remains the exclusive property of SAGEM.

YOU ARE STRICTLY PROHIBITED FROM MODIFYING, TRANSLATING, DE-COMPILING OR DISASSEMBLING THIS SOFTWARE PROGRAM OR ANY PART THEREOF.

Brightstar US, Inc. (Brightstar) is the exclusive distributor for SAGEM in the United States and is responsible for all warranties for SAGEM phones and accessories sold in the United States. Please DO NOT contact SAGEM directly regarding any warranty claims; doing so will only delay the processing of your claim.

THE LIMITED WARRANTY AND REMEDIES SET FORTH IN THIS WARRANTY CARD ARE THE EXCLUSIVE WARRANTIES AND REMEDIES PROVIDED BY BRIGHTSTAR AND ARE IN LIEU OF ALL OTHER WARRANTIES, TERMS, OR CONDITIONS, EXPRESS OR IMPLIED, EITHER IN FACT OR BY OPERATION OF LAW. BRIGHTSTAR OR SAGEM MAKES NO OTHER WARRANTY, EXPRESS OR IMPLIED, AND EXPRESSLY DISCLAIMS ALL IMPLIED WARRANTIES, INCLUDING ALL WARRANTIES OF MERCHANTABILITY OR FITNESS FOR A PARTICULAR PURPOSE. THE REMEDIES SET FORTH HEREIN ARE YOUR EXCLUSIVE REMEDIES FOR BREACH OF WARRANTY.

Usage precautions

Your phone allows you to download ring tones, icons and animated screensavers. Some of these items may contain data that may cause malfunction of your phone or data losses (a computer virus, for example). For this reason, Brightstar disclaims all responsibility concerning (1) the reception of downloaded data or losses of such data, (2) such data's impact on the operation of the phone, and (3) damages resulting from receiving any downloaded data or loss of such data. In addition, any failure caused by receiving downloaded data that do not comply with the phone's specifications is excluded from the warranty. The diagnosis and repair of a phone infected by downloaded data will be at the expense of the customer.

Warranty conditions

Whenever you wish to make a warranty claim, please contact Brightstar at the address given below and present the purchasing paperwork that was given to you.

1. Brightstar warrants that the new phone (excluding consumables but including new accessories bundled with the phone), is free from defects in materials and workmanship under normal usage for a period of twelve (12) months

effective from the date you purchased the phone, to be evidenced by presentation of the paperwork stating the purchase date of the phone. Phones that have been repaired or replaced as standard during the warranty period stated above are warranted (parts and labor) until the later of these two dates: Expiry of the original warranty period of twelve (12) months stated above; or three (3) months from the repair or replacement under warranty.

2. All faulty phones under warranty will be replaced or repaired free of charge at Brightstar's option.

3. You are responsible for sending the phone to the repair center. In order to repair or replace a phone under warranty, Brightstar also requires that a legible and unmodified purchase document, stating vendor's name and address, date and place of purchase, type of phone and IMEI (to display the IMEI on your phone's screen, type: *#06#), be attached to the warranty, and that the information on the phone identification label be legible and that such label or any other seal have not been tampered with. The warranty applies under normal usage for the period outlined above. Prior to sending the phone for repair, it is your responsibility to backup at your expense any customized data stored in the phone (such as phonebook, settings, wallpapers, and previously downloaded data). BRIGHTSTAR IS NOT RESPONSIBLE FOR DAMAGE TO CUSTOMER FILES, PROGRAMS OR DATA. The information or operating elements and the contents of files will not be re-installed in any case in the event of loss. Brightstar may decide, at its option, to repair the phone with new or reconditioned parts, or replace the phone with a new phone or with a phone in good working condition. During its repair work Brightstar may make, where necessary, any technical modifications to the phone where these modifications do not adversely affect functionality.

Faulty parts to be replaced during a repair under warranty become the property of Brightstar. The application of the warranty is subject to the full payment of the sums due for the phone when the request for support is made.

4. Breakdowns, damage or malfunctions due to the following are excluded from the limited warranty: (i) non-compliance with the installation and use instructions, (ii) an external cause (such as shock, lightning, fire, vandalism, malice, water damage of any type, contact with various liquids or any harmful agent, unsuitable electric current, extreme humidity or heat, improper storage, etc.), (iii) modifications of the phone made without the written consent of Brightstar, (iv) a servicing fault, as described in the documentation supplied with the phone, (v) lack of supervision or care, (vi) poor environmental conditions of the phone (including temperature and hygrometry, effects of variations in electric voltage, interference from the mains network or earth), (vii) repair, including opening or trying to open the phone or servicing done by personnel not approved by Brightstar, (viii) inadequate packaging and/or poor packing of the phone that is sent back to Brightstar, (ix) the use of products or accessories not sold by Brightstar as compatible with the phone, or (x) the opening or closing of a SIM Lock done without the agreement of the original operator.

5. In addition, the warranty does not cover: (i) normal wear and tear of the phone and accessories, (ii) change of parameters of the cellular network made after the phone was sold, (iii) supply of new software versions, (iv) delivery of consumables and installation or replacement of these consumables, (v) phone or software modified or added without the written consent of Brightstar, (vi) phones returned to Brightstar without having complied with the return procedure specific to the phone covered by this warranty, or

(vii) communication problems linked with a poor environment, including problems accessing and/or logging onto the Internet, breakdowns of the access network, the failure of the subscriber's or his correspondent's line, transmission fault (such as poor geographic coverage by radio transmitters, interference, disturbance, failure or poor quality of phone lines, etc.), a fault inherent to the local network (such as cabling, file server, user phone) and/or transmission network fault (such as interference, disturbance, failure or poor quality of the network, etc.).

6. In the event a customer submits a product for repair or replacement and such product is excluded from warranty coverage or the warranty period has expired, Brightstar will draw up an estimate to be given to the customer for acceptance before any repair commences. The repair and freight costs (to and from the repair center) given in an estimate accepted by the customer will be charged to the customer.

7. Any questions or correspondence regarding this limited warranty should be addressed to:

Brightstar US, Inc.

Attn: SAGEM Warranty & Repair Services

1001 Technology Way

Libertyville, IL 60048

These provisions are valid unless Brightstar has made a special written agreement with the customer. If one of the provisions turns out to infringe a requirement under applicable law that consumers could have the benefit of under the national legislation, such provision will not be applied, but all other provisions will remain valid.

For customers outside the United States

Warranty

You must always use your phone for the purpose for which it was designed, under normal operating conditions. SAGEM Wireless declines all responsibility for any use outside of the scope of its designed purpose and for any consequences of this use.

The software program developed by SAGEM remains the exclusive property of SAGEM Wireless. It is therefore highly prohibited to modify, translate, de-compile or disassemble this software program or any part thereof.

Usage precautions

Your phone allows you to download ring tones, icons and animated screensavers. Some of these items may contain data that may cause malfunctions of your phone or data losses (virus for example).

For this reason, SAGEM Wireless rejects all responsibility concerning (1) the reception of downloaded data or losses of the said data, (2) the impact on the operation of the phone and (3) damages resulting from receiving the said downloaded data or loss of said data. In addition, SAGEM Wireless states that a failure caused by receiving downloaded data that do not comply with the specifications set by SAGEM Wireless is excluded from the warranty. Consequently, the diagnosis and repair of a phone infected by the said downloaded data will be at the expense of the customer.

Any content that you download to your phone may be protected by copyright belonging to third parties and consequently you may not have the right to use this content or its use may be restricted. Consequently it is up to you to ensure that you have permission, such as under the terms of a license agreement, to use any content that you download. Furthermore, SAGEM Wireless does not guarantee the accuracy nor the quality of any content that you download. You alone are responsible for the content that you download to your mobile phone and how you use it. SAGEM Wireless cannot be held responsible for this content nor for its use. It is your responsibility to ensure compliance, at your own expense, with the laws and regulations applicable in the country where you use your phone.

Warranty conditions

Whenever you wish to make use of the warranty, please contact your vendor and present him with the purchasing paperwork that he gave you.

If a fault occurs, he will advise you.

1. The new phone (excluding consumables), excluding accessories bundled with the phone, are guaranteed by SAGEM Wireless, parts and labour (apart from travel) against any manufacturing fault for a period of: twenty four (24) months for EU members countries and twelve (12) months for the other countries; and with effect from the sale of the phone to the customer, on presentation of the paperwork indicating the purchase date of the phone. The bundled accessories are guaranteed by SAGEM Wireless for a period of twelve (12) months worldwide.

NOTE: If the telephone is supplied with a warranty card, the period of the warranty applicable is the period indicated on the warranty card.

Phones that have been repaired or replaced as standard during the warranty period stated above are guaranteed (parts and labour) until the later of these two dates:

Expiry of the guarantee period stated above or three (3) months with effect from the date of support provided by SAGEM Wireless.

Your legal rights under the terms of applicable national law as well as your rights in relation to your retailer, as set out in the sales contract, remain applicable and are not in any way affected by this guarantee.

In any disputes, the phone is covered by the legal warranty against the consequences of faults or hidden defects in compliance with articles 1641 and subsequent of the French civil code.

2. All faulty phones under warranty will be replaced or repaired free of charge at SAGEM Wireless's option (with the exclusion of repair of any other damage), once it has been specified that the work required for the application of the warranty will be done in a workshop and that the return costs (transport and insurance) of the phone to the address to be indicated to it by the SAGEM Wireless after-sales service, whose phone number will appear on the delivery note, will be charged to the customer.

Subject to essential legal provisions, SAGEM Wireless does not accept any warranty, explicit or implicit, other than the warranty provided expressly in this chapter, nor shall SAGEM Wireless accept responsibility for any immaterial and/or indirect damages (such as loss of orders, loss of profit or any other financial or commercial damage) under the warranty or not

3. The acceptance of a phone under warranty demands that a purchase document that is legible and without modification, stating vendor's name and address, date and

place of purchase, type of phone and IMEI, are attached to the warranty, and that the information on the phone identification label is legible and that this label or any other seal has not been tampered with.

The warranty applies in normal conditions of use.

Prior to sending the phone for repair, it is the customer's responsibility to backup at his expense the customized data stored in the phone (phonebook, settings, wallpapers). A list of backup facilities can be provided by SAGEM Wireless on request. The responsibility of SAGEM Wireless cannot be invoked if damage occurs to customer files, programs or data. The information or operating elements and the contents of files will not be re-installed in any case in the event of loss.

SAGEM Wireless may decide, at its option, to repair the phone with new or reconditioned parts, replace the phone with a new phone or, in any dispute, a phone in good working condition. During its work SAGEM Wireless reserves the facility to make, where necessary, any technical modifications to the phone where these modifications do not adversely affect its initial purpose.

Faulty parts to be replaced during a repair under warranty will become the property of SAGEM Wireless.

The phone repair and standstill time during the warranty period may not lead to an extension of the warranty period as stated in article 1 above, provided no other vital provisions have been agreed.

The application of the warranty is subject to the full payment of the sums due for the phone when the request for support is made.

4. The following are excluded from the warranty:

Breakdowns or malfunctions due to non-compliance with the

installation and use instructions, to an external cause of the phone (shock, lightning, fire, vandalism, malice, water damage of any type, contact with various liquids or any harmful agent, unsuitable electric current...), to modifications of the phone made without the written consent of SAGEM Wireless, to a servicing fault, as described in the documentation supplied with the phone, to lack of supervision or care, to poor environmental conditions of the phone (especially temperature and hygrometry, effects of variations in electric voltage, interference from the mains network or earth) or even due to a repair, a call-out (opening or trying to open the phone) or to servicing done by personnel not approved by SAGEM Wireless.

Damage resulting from inadequate packaging and/or poor packing of the phone sent back to SAGEM Wireless.

Normal wear and tear of the phone and accessories.

Communication problems linked with a poor environment, especially:

Problems accessing and/or logging onto the Internet, such as breakdowns of the access network, the failure of the subscriber's or his correspondent's line, transmission fault (poor geographic coverage by radio transmitters, interference, disturbance, failure or poor quality of phone lines...), a fault inherent to the local network (cabling, file server, user phone) and/or transmission network fault (interference, disturbance, failure or poor quality of the network...).

Change of parameters of the cellular network made after the phone was sold.

Supply of new software versions.

Current servicing work: delivery of consumables, installation or replacement of these consumables...

Call-outs for phone or software modified or added without the written consent of SAGEM Wireless.

Faults or disruptions resulting from the use of products or accessories not compatible with the phone.

Phones returned to SAGEM Wireless without having complied with the return procedure specific to the phone covered by this warranty.

The opening or closing of a SIM operator key and call-outs resulting in the non-operation of the phone resulting from the opening or closing of SIM operator key done without the agreement of the original operator.

5. In the cases of warranty exclusion and of expiry of the warranty period, SAGEM Wireless shall draw up an estimate to be given to the customer for acceptance before any call-out. The repair and carriage costs (there and back) given in the accepted estimate will be charged to the customer.

These provisions are valid unless a special written agreement has been made with the customer. If one of the provisions turns out to infringe a legally essential rule that consumers could have the benefit of under the national legislation, this provision will not be applied, but all other provisions will remain valid.

6. Any questions or correspondence regarding this limited warranty should be addressed to: <http://www.sagemwireless.com>.

End user licence agreement (EULA)

CONTEXT AND ACCEPTANCE OF THE AGREEMENT

You have acquired a Mobile Phone device ("DEVICE"), manufactured by SAGEM Wireless (MANUFACTURER), that includes software either developed by the manufacturer itself or licensed third party Software suppliers ("SOFTWARE COMPANIES") to the manufacturer with the rights to sub-license it to the purchaser of the device. These installed software products, regardless of their company of origin, and whether the name of the company of origin is indicated or not in the DEVICE documentation, as well as associated media, printed materials, and "online" or electronic documentation ("SOFTWARE") are protected by international intellectual property laws and treaties. The SOFTWARE is licensed, not sold. All rights reserved.

IF YOU DO NOT AGREE WITH THIS END USER LICENCE AGREEMENT ("EULA"), DO NOT USE THE DEVICE OR COPY THE SOFTWARE. INSTEAD, PROMPTLY CONTACT THE MANUFACTURER FOR INSTRUCTIONS ON RETURN OF THE UNUSED DEVICE(S) FOR A REFUND. **ANY USE OF THE SOFTWARE, INCLUDING BUT NOT LIMITED TO USE ON THE DEVICE, WILL CONSTITUTE YOUR AGREEMENT TO THIS EULA (OR RATIFICATION OF ANY PREVIOUS CONSENT).**

SOFTWARE includes software already installed on the DEVICE ("DEVICE Software") and Software contained on the CD-ROM disk ("Companion CD"), if any is supplied with the product.

GRANTING OF SOFTWARE LICENCE RIGHTS

This EULA grants you the following licence:

DEVICE Software. You may use the DEVICE Software as installed on the DEVICE. All or certain portions of the DEVICE Software may be inoperable if you do not have and maintain a service account with an appropriate Mobile Operator, or if the Mobile Operator's network facilities are not operating or configured to operate with the DEVICE software.

COMPANION CD. If any is supplied, additional software for your personal computer is included with your DEVICE. You may install and use the software component(s) contained in the Companion CD only in accordance with the terms of the printed or online end user licence agreement(s) provided with such component(s). In the absence of an end user licence agreement for particular component(s) of the Companion CD, you may install and use only one (1) copy of such component(s) on the DEVICE or a single computer with which you use the DEVICE.

Security Updates. The SOFTWARE may include digital rights management technology. If SOFTWARE does contain digital rights management technology, content providers are using the digital rights management technology ("DRM") contained in the SOFTWARE to protect the integrity of their content ("Secure Content") so that their intellectual property, including copyright, in such content is not misappropriated. Owners of such Secure Content ("Secure Content Owners") may, from time to time, request manufacturers or SOFTWARE SUPPLIERS to provide security related updates to the DRM components of the SOFTWARE ("Security Updates") that may affect your ability to copy, display and/or play Secure Content through the SOFTWARE or third party applications that utilise the DRM.

You therefore agree that, if you elect to download a licence from the Internet which enables your use of Secure Content, Suppliers may, in conjunction with such licence, also download onto your DEVICE such Security Updates that a Secure Content Owner has requested that SOFTWARE SUPPLIERS distribute. The manufacturer and SOFTWARE SUPPLIERS will not retrieve any personally identifiable information, or any other information, from your DEVICE by downloading such Security Updates.

DESCRIPTION OF OTHER RIGHTS AND LIMITATIONS

COPYRIGHT. All title and intellectual property rights in and to the SOFTWARE (including but not limited to any images, photographs, animations, video, audio, music, text and "applets," incorporated into the SOFTWARE), the accompanying printed materials, and any copies of the SOFTWARE, are owned by the manufacturer or the SOFTWARE SUPPLIERS. You may not copy the printed materials accompanying the SOFTWARE. All title and intellectual property rights in and to the content which may be accessed through use of the SOFTWARE is the property of the respective content owner and may be protected by applicable copyright or other intellectual property laws and treaties. This EULA grants you no rights to use such content. All rights not specifically granted under this EULA are reserved by the manufacturer and the SOFTWARE SUPPLIERS.

Limitations on Reverse Engineering, Decompilation and Disassembly. You may not reverse engineer, decompile, or disassemble the SOFTWARE, except and only to the extent that such activity is expressly permitted by applicable law notwithstanding this limitation.

Single DEVICE. The DEVICE Software is licensed with the DEVICE as a single integrated product. The DEVICE Software installed in the memory of the DEVICE may only be used as part of the DEVICE.

Single EULA. The package for the DEVICE may contain multiple versions of this EULA, such as multiple translations and/or multiple media versions (e.g., in the user documentation and in the software). Even if you receive multiple versions of the EULA, you are licensed to use only one (1) copy of the DEVICE Software.

Software Transfer. You may not permanently transfer any of your rights under this EULA with regard to the DEVICE Software or Companion CD, except as permitted by the applicable Mobile Operator. In the event that the Mobile Operator permits such transfer, you may permanently transfer all of your rights under this EULA only as part of a sale or transfer of the DEVICE, provided you retain no copies, you transfer all of the SOFTWARE (including all component parts, the media and printed materials, any upgrades, this EULA and, if applicable, the Certificate(s) of Authenticity), and the recipient agrees to the terms of this EULA. If the SOFTWARE is an upgrade, any transfer must include all prior versions of the SOFTWARE.

Software Rental. You may not rent or lease the SOFTWARE.

Speech/Handwriting Recognition. If the SOFTWARE includes speech and/or handwriting recognition component(s), you should understand that speech and handwriting recognition are inherently statistical processes; that recognition errors are inherent in the processes; and that errors can occur in the component's recognition of your handwriting or speech, and the final conversion into text. Neither the manufacturer nor its suppliers shall be liable for any damages arising out of errors in the speech and handwriting recognition processes.

NOTICE REGARDING THE MPEG-4 VISUAL STANDARD. The SOFTWARE may include MPEG-4 visual decoding technology. MPEG LA, L.L.C. requires the following notice:

USE OF THIS SOFTWARE IN ANY MANNER THAT COMPLIES WITH THE MPEG-4 VISUAL STANDARD IS PROHIBITED, EXCEPT FOR USE DIRECTLY RELATED TO (A) DATA OR INFORMATION (i) GENERATED BY AND OBTAINED WITHOUT CHARGE FROM A CONSUMER NOT THEREBY ENGAGED IN A BUSINESS ENTERPRISE, AND (ii) FOR PERSONAL USE ONLY; AND (B) OTHER USES SPECIFICALLY AND SEPARATELY LICENSED BY MPEG LA, L.L.C.

If you have questions regarding this Notice, please contact MPEG LA, L.L.C., 250 Steele Street, Suite 300, Denver, Colorado 80206; Telephone 303 331.1880; FAX 303 331.1879

Termination. Without prejudice to any other rights, the manufacturer may terminate this EULA if you fail to comply with the terms and conditions of this EULA. In such event, you must destroy all copies of the SOFTWARE and all of its component parts.

Consent to Use of Data. You agree that SOFTWARE SUPPLIERS may collect and use technical information gathered in any manner as part of product support services related to the SOFTWARE. SOFTWARE SUPPLIERS may use this information solely to improve their products or to provide customised services or technologies to you. SOFTWARE SUPPLIERS may disclose this information to others, but not in a form that personally identifies you.

Internet Gaming/Update Features. If the SOFTWARE provides, and you choose to utilise, the Internet gaming or update features within the SOFTWARE, it is necessary to use certain computer system, hardware, and software information to implement the features. By using these features, you explicitly authorise SOFTWARE SUPPLIERS to use this information solely to improve their products or to provide customised services or technologies to you. SOFTWARE SUPPLIERS may disclose this information to others, but not in a form that personally identifies you.

Internet-Based Services Components. The SOFTWARE may contain components that enable and facilitate the use of certain Internet-based services. You acknowledge and agree that SOFTWARE SUPPLIERS may automatically check the version of the SOFTWARE and/or its components that you are utilising and may provide upgrades or supplements to the SOFTWARE that may be automatically downloaded to your Device.

Links to Third Party Sites. The SOFTWARE may provide you with the ability to link to third party sites through the use of the SOFTWARE. The third party sites are not under the control of the manufacturer. Neither the manufacturer nor its affiliates are responsible for (i) the contents of any third party sites, any links contained in third party sites, or any changes or updates to third party sites, or (ii) webcasting or any other form of transmission received from any third party sites. If the SOFTWARE provides links to third party sites, those links are provided to you only as a convenience, and the inclusion of any link does not imply an endorsement of the third party site by the manufacturer or its affiliates.

Additional Software/Services. The SOFTWARE may permit the manufacturer to provide or make available to you SOFTWARE updates, supplements, add-on components, or Internet-based services components of the SOFTWARE after the date you obtain your initial copy of the SOFTWARE ("Supplemental Components").

If the manufacturer provides or makes available to you Supplemental Components and no other EULA terms are provided along with the Supplemental Components, then the terms of this EULA shall apply.

The manufacturer reserves the right to discontinue any Internet-based services provided to you or made available to you through the use of the SOFTWARE.

EXPORT RESTRICTIONS. You acknowledge that SOFTWARE is subject to U.S. export jurisdiction. You agree to comply with all applicable international and national laws that apply to the SOFTWARE, including the U.S. Export Administration Regulations, as well as end-user, end-use and destination restrictions issued by U.S. and other governments.

UPGRADES AND RECOVERY MEDIA

- **DEVICE Software.** If the DEVICE Software is provided by the manufacturer separate from the DEVICE on media such as a ROM chip, CD ROM disk(s) or via web download or other means, and is labelled "For Upgrade Purposes Only", you may install one copy of such DEVICE Software onto the DEVICE as a replacement copy for the existing DEVICE Software and use it in accordance with this EULA, including any additional EULA terms accompanying the upgrade DEVICE Software.
- **COMPANION CD.** If any Companion CD component(s) is provided by the manufacturer separate from the DEVICE on CD ROM disk(s) or via web download or other means, and labelled "For Upgrade Purposes Only" , you may (i) install and use one copy of such component(s) on the computer(s) you use to exchange data with the DEVICE as a replacement copy for the existing Companion CD component(s).

RESPONSIBILITIES

SUPPORT AND INFORMATION. Should you have any questions concerning this EULA, or if you desire to contact the manufacturer for any other reason, please refer to the address provided in the documentation for the DEVICE.

NO LIABILITY FOR CERTAIN DAMAGES. EXCEPT AS PROHIBITED BY LAW, THE MANUFACTURER SHALL HAVE NO LIABILITY FOR ANY INDIRECT, SPECIAL, CONSEQUENTIAL OR INCIDENTAL DAMAGES ARISING FROM OR IN CONNECTION WITH THE USE

OR PERFORMANCE OF THE SOFTWARE. THIS LIMITATION SHALL APPLY EVEN IF ANY REMEDY FAILS OF ITS ESSENTIAL PURPOSE. FOR APPLICABLE LIMITED WARRANTIES AND SPECIAL PROVISIONS PERTAINING TO YOUR PARTICULAR JURISDICTION, PLEASE REFER TO YOUR WARRANTY BOOKLET INCLUDED WITH THIS PACKAGE OR PROVIDED WITH THE SOFTWARE PRINTED MATERIALS.

Java™

When running a Java™ application, you may be prompted to grant access to protected features. These features are protected because using them could incur a cost, or involve your personal data. In case of doubt, don't hesitate to refuse access by selecting the "No" button!

The security configuration menu is an expert feature! You must know exactly what you are doing before attempting to change the security parameters of a MIDlet. Misunderstanding changes may render MIDlet non functional and/or lead to higher risks for your private data or impact your airtime consumption. Any changes in the security configuration are done under your responsibility. In no case shall the manufacturer and/or your network provider be liable for any damages deriving from or arising out of such changes in the security configuration.

You must be aware that applications downloaded to your phone could cause the phone to perform actions for which you will be billed, such as making calls and sending SMS. Depending on your operator's billing policy, you may also be charged to download the application because of airtime consumption.

Security considerations

Java™ MIDP technology is an efficient way to provide powerful applications in mobile phones.

All these MIDP 2.0 features cannot be displayed on MIDlet installed in the handset: an advanced access control system is implemented in the device to protect your private data and airtime consumption.

Access controls are collected in 9 security groups:

- Network access

- Auto invocation
- Phone call
- Local connectivity
- Messaging receive
- Messaging sending
- Read User data
- Write User data
- Multimedia recording

Each of these security groups has one of 5 possible authorizations levels (listed from the more restrictive to the more permissive):

- Never: The security group completely prevents access to the protected features.
- Per use: Each time MIDlet tries to use protected feature, user is prompted to grant access.
- Per session: First time a MIDlet uses a protected function, user is prompted to grant access like in "Per use" authorization but access is granted until the MIDlet terminates.
- Single confirmation: The first time in the whole MIDlet life a MIDlet uses a protected feature, user is prompted to grant access. It remains valid until the MIDlet is removed from the handset.
- Always: The security group unconditionally grants access to protected features.

A MIDlet has a security status which is either "uncertified", or else "certified".

An "uncertified" status means that the source of the MIDlet could not be verified by the mobile phone at installation time. As far as the phone knows, the MIDlet could have been written by anyone.

A "certified" status means that the MIDlet was digitally signed by a known party, whose name is displayed by the mobile phone.

Security permissions are different for "uncertified" or "certified" MIDlets.

Security configuration menu

When a MIDlet is installed in the mobile phone, default security authorizations are applied.

This default security configuration may be altered through the "Settings/Security" menu of an installed MIDlet.

Once in the "Security" menu, the security status of the MIDlet is displayed.

If you do not want to enter the security menu, simply select the "Back" button. You can proceed by selecting "**OK**" button.

The menu displayed allows you to increase or decrease the permissions currently applied to the current MIDlet for each of the security groups.

When you set a more permissive authorization to a security group than the current value, the mobile phone asks you to confirm your increased risk exposure.

The maximum risk exposure increase is limited by the security status.

What is Java™?

Business applications and games are easily downloadable by the end-user on a Java™ featured handset.

Your mobile phone is a MIDP 2.0 compliant Java™ platform which implements WMA (SMS support) and MMAPI (Multimedia support) options, providing an exciting environment to run highly graphical, networked and intuitive MIDP applications.

What is a MIDlet?

A Java™ application or a game designed to run in a mobile phone is named a MIDlet (MIDP applet).

A MIDlet is usually made up of 2 files:

- The JAD file
- The JAR file

JAD file stands for **Java™ Application Descriptor**. It is a small file describing the content of a JAR file.

JAR file stands for **Java™ Archive**. It refers to the application data themselves (program, images, sound). A JAR file can have a size of up to 200 KB.

Note: In rare circumstances, MIDlet vendors may provide no JAD file and the MIDlet is just the JAR file. In such a case it is your sole responsibility to assess the risk of downloading the JAR file without any possibility of consulting the JAD file.

Downloading a MIDlet (Java™ game or application)

MIDlets are easily downloaded to the mobile phone through the Games or Applications menus or through the WAP browser. In almost all cases, you will first receive a JAD file which will be displayed on the screen.

When you select a JAD file, your mobile phone downloads it, displays the data contained and prompts you to acknowledge the JAR file download.

The popup displays information below:

- Name of the MIDlet, Version, Size, Name, Security status, URL.

If you do not want to download the main data (JAR file), you can refuse to acknowledge further airtime consumption by selecting "Cancel".

If you agree on the MIDlet installation, just select **OK**. The MIDlet is installed with security levels set to the default values associated with its security status.

Before downloading an application, a message similar to this one may be displayed: "Your handset cannot identify the application, please be sure of the source of the application before installing the application".

Trademarks

Java™ and all other Java-based marks are trademarks or registered trademarks of Sun Microsystems, Inc. in the U.S. and other countries.

Disclaimer

Some downloaded items may contain data or may induce actions which may cause malfunctioning of your mobile phone or loss or corruption of data or abnormal increase of your airtime consumption.

You expressly acknowledge that the download of any applications including Java™ applications or games is done under your exclusive responsibility. In no event shall the manufacturer, your network service provider or their affiliates be liable for any lost profits or costs of procurement of substitute goods or services, loss of profits, interruptions of business, loss of data or for any special, indirect, incidental, economic, or consequential damages arising under contract, tort, negligence, or other theory of liability relating to the download of any application by any means, including Java™ applications or games in SAGEM devices. You expressly acknowledge that any applications including Java™ applications or games are provided strictly "as is". The manufacturer and/or your network service provider extend no warranty whatsoever thereto. The manufacturer and/or your network service provider disclaim any express, implied or statutory warranty of merchantability, fitness of any applications including Java™ applications or games for a specific purpose, satisfactory quality, security or otherwise.

Troubleshooting

The phone won't start and/or won't take a charge

The battery has completely lost its charge.

Connect the phone to the charger for between 5 and 30 minutes. The phone will only switch on after it has been charging for a few minutes.

You may use the phone again when the Start option is displayed on the screen.

If the phone still won't start after 30 minutes' charging, contact customer service.

SIM not present

Check if the SIM card is present and properly positioned / inserted.

Check the condition of the SIM card. If damaged, please go back to the operator's shop for advice. Contact your after-sales service if the message persists.

Incorrect PIN code

An incorrect PIN code has been entered. Be careful! Three incorrect PIN codes will block the SIM Card.

PIN BLOCKED

If a wrong PIN number is entered three times in succession, your SIM card is blocked. You must then:

- Enter the PUK (Personal Unblocking Key) code provided by your operator, and validate.
- Enter your PIN number and validate.
- Enter your PIN number again and validate.

After 5 or 10 failed attempts (depending on the type of SIM card), the SIM card is definitely locked. You must then contact your operator to obtain a new card.

SIM LOCKED

In certain cases, the handset can only be used with some types of SIM cards. This message means that the SIM card you are using does not fit with the phone. Take the SIM card out, and switch it back on. If the message **SIM not present** appears on the screen, you will need to check its compatibility next to the place where you bought it. If not, please contact your after-sales service.

No call connection

Check that the number you have dialled is correct. Check the presence of at least one white circle of the network signal reception level indicator.

If the letter E is displayed on the top right corner of the screen, without any network name displayed, only emergency services can be called.

Check the status of your credit.

Check that the SIM Card you are using offers the service you are requesting; check if its validity has not expired.

Check and deactivate the outgoing calls restriction when necessary.

The network could be saturated. Try later.

If the problem persists, please contact your Technical Helpdesk.

No receiving calls

Try to make a call in order to check that the phone and the network are operational.

Check and deactivate the permanent call forwarding (permanent call forwarding icon displayed on the screen).

Check and deactivate the incoming calls restriction when necessary.

If the problem persists, please contact your Technical Helpdesk.

Quality reception when calling

Avoid placing your fingers at the bottom of the phone, where the aerial is integrated: the phone will have to use full strength to establish a quality transmission.

Cannot send message

Check that the message centre number is correctly entered. To do so, please select **Messaging/Settings** then the **SMS settings** tab/**Message center** and check the number entered. Please contact your network provider to get this number.

No voicemail

Check that your subscription does offer this service. Program the call to be forwarded to voicemail using the information provided by the operator.

Operator name does not appear on screen

Select the **Settings** menu, then **Connectivity/Networks/Search/Manual**. Wait until the operator appears, select it and validate.

If the **Operator logo** menu is present (depending on model), activate the display (**Settings/Display/Operator logo**).

Index

A

- Activating your phone 11
- Alarm 46

B

- Backlight 62
- Battery
 - Charging the battery 13
 - Installing the battery 12
- Bluetooth® 15, 34, 36, 38, 45, 48, 54
- Business Card 33

C

- Calculator 47
- Calendar 48
- Calls
 - Auto redial 22
 - Auto response 21
 - Blacklist 23
 - Call barring 22
 - Call diver 21
 - Call history 20
 - Call reject list 22
 - Call waiting 22
 - Receiving a call 19
 - call Settings 20
 - calling 19
- Camera

- Recording a Video 35
- Taking a photo 34
- Confidentiality 61
- Connectivity 54, 63
- Contacts 20
 - Add 31
 - Call 31
 - Call group 32
 - Copy 31
 - Edit 31
 - Memory 32
 - New contact 30
 - Send 31
 - Speed Dial 32

D

- Date and Time 59
- Display 62
- Downloading objects 41, 53

F

- FM Radio 39

G

- Getting started 16

H

- HAC 62
- Hands-free mode 20
- Help 49

I		
Icon	9	
Input modes	25	
K		
Keypad lock	59	
L		
Languages	60	
Local info.	47	
M		
Memory	61	
Messaging		
Creating a text message	24	
Drafts	27	
Inbox	27	
Outbox	27	
Receiving messages	26	
Sent messages	27	
Templates	27	
Multimedia	41	
Multimedia objects	41	
Music player	37	
N		
NFC	42, 58	
Network	17	
O		
Operator	61	
Operator logo	63	
P		
PIN	60	
Phone lock	60	
Playlists	38	
Profiles	59	
R		
Recorder	47	
Ringtones	59	
S		
SIM card	11, 12	
SMS	24	
Security	60	
Shortcuts	63	
Stop Watch	46	
T		
T9	25	
Timer	46	
ToDo	45	
Torch	47	
U		
USB mode	57	
V		
Voicemail	28	
W		
Wallpaper	62	



* 2 8 7 3 1 2 2 5 3 * a

www.sagemwireless.com
Sagem Wireless
38 Rue de Berri, 75008 Paris
Capital 1 590 652, 10 € - 508 671 401 R.C.S Paris

09/2010