

CONCERT UHF

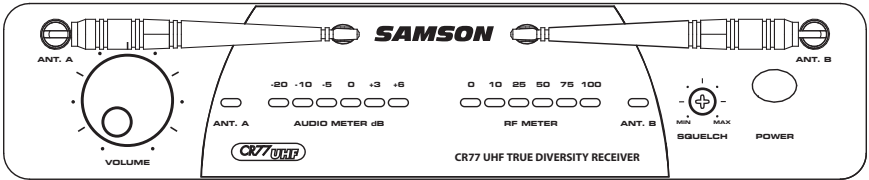

Owners Manual

SAMSON[®]
W I R E L E S S

Table of Contents

Introduction / System Features	1
Guided Tour - CR77 Receiver Front Panel	3
Guided Tour - CR77 Receiver Rear Panel and Frequency Conversion Chart	4
Guided Tour - CT7L / CT7G Beltpack Transmitter	5
Guided Tour - HT7 Handheld Microphone Transmitter	7
Setting Up and Using the Concert Series System	8
Appendix A: CT7L Multipin Wiring Guide and Chart	11
Specifications	12

Copyright 2005, Samson Technologies Corp.
First Printed March 2005

Samson Technologies Corp.
575 Underhill Blvd.
P.O. Box 9031
Syosset, NY 11791-9031
Phone: 1-800-3-SAMSON (1-800-372-6766)
Fax: 516-364-3888
www.samsontech.com

Introduction / System Features

Congratulations on purchasing the Samson Concert Series UHF Wireless System! Although this product is designed for easy operation, we suggest you first take some time to go through these pages so you can fully understand how we've implemented a number of unique features.

Every wireless system consists of at least two components—a transmitter and a receiver, both of which must be tuned to the same channel (that is, the same radio frequency) in order to operate correctly.* The Samson Concert Series system you have purchased operates in the 801 - 805 MHz frequency range and contains a CR77 receiver and either our CT7 belt-pack transmitter (for lavalier, wind instrument, headset microphone applications and instrument applications) or the HT7 hand-held microphone transmitter (available with the Samson Q7 dynamic or C05 condenser capsules).

In this manual, you'll find a detailed description of the features of the Concert Series Wireless system, as well as a guided tour through all components, step-by-step instructions for setting up your system, wiring diagrams and tables, and full specifications. If your Concert Series system was purchased in the United States, you'll also find a warranty card enclosed—don't forget to fill it out and mail it! This will enable you to receive online technical support and will allow us to send you updated information about this and other Samson products in the future. If your Concert Series Wireless system was purchased outside of the U. S., contact your local distributor for warranty details.

SPECIAL NOTE for U.S. purchasers: Should your Concert Series Wireless system ever require servicing, a Return Authorization number (RA) is necessary. Without this number, the unit will not be accepted. If your Concert Series Wireless system was purchased in the United States, please call Samson at 1-800-372-6766 for a Return Authorization number prior to shipping your unit. If possible, return the unit in its original carton and packing materials. If your Concert Series Wireless system was purchased outside of the U. S., contact your local distributor for servicing information.

* Your receiver and transmitter have been factory preset to utilize the same channel. A listing of the six available channels and their corresponding UHF frequencies can be found on page 4 of this manual.

System Features

Designed for use in both live sound and sound contracting applications, the Samson Concert Series Wireless System provides a high performance, cost effective solution, utilizing state-of-the-art technology in wireless communications. Main features include:

- Six different available channels, all operating in the less crowded UHF bandwidth, and all designed for simultaneous use. This means that you can use multiple Concert Series systems (each tuned to a different channel) in the same location without interference.
- Technological breakthrough usage of Dielectric filters for extremely precise and stable tuning.
- Diversity technology maximizes active range (up to 300 feet) and reduces potential interference problems.

System Features

- The CR77 receiver is a half-rack unit that can be used freestanding or can be mounted in any standard 19" rack,* making it easy to integrate into any traveling or fixed installation audio system. It includes a pair of tuned antennas and provides both balanced and unbalanced outputs, line/mic output level switch and continuously adjustable Volume and Squelch controls, as well as an audio peak LED, dual antenna indicators, a six-segment Audio level meter and a six-segment RF level meter.
- Built-in companding noise reduction in all components for crystal-clear sound with minimized background noise and hiss.
- Transmitters provide "popless" muting (which turns off the audio signal while leaving the carrier signal on) and use standard 9-volt batteries, with battery life of more than 12 hours. The Concert transmitters also provide a convenient Battery Strength LED meter, allowing you to monitor the remaining power in the installed battery.
- The CT7 provides a mini-XLR jack for connection to the Samson GC5P3 cable with standard 1/4" jack (for use with instruments such as electric guitar or bass), or for connecting to a variety of popular headsets and lavalier microphones, including:

Samson QE headset**

Samson QV headset

Samson HS5P3 headset

Samson HM40P Wind Instrument Mic

Samson LM5P3 lavalier

Samson QL1 lavalier

Audio-Technica **ATM-75** headset

Audio-Technica **MT-350** lavalier

Applied Microphone Technology **Roaming One** wind instrument microphone

Audio-Technica **AT-831** lavalier

Countryman **IsoMax** headset

Sony **ECM-40** lavalier

Sony **ECM-44** lavalier

- The HT7 hand-held microphone transmitter is available with either the Samson **Q7** Neodymium dynamic microphone capsule, or the Samson **C05** Condenser microphone capsule.
- All components have rugged construction that ensures reliable operation in even the most demanding performance environments.

* Using an optional Samson RK55 rack adapter kit

** Optimized for aerobics workouts, this headset is recommended for usage in high-humidity environments such as physical fitness centers.

Guided Tour - CR77 Front Panel

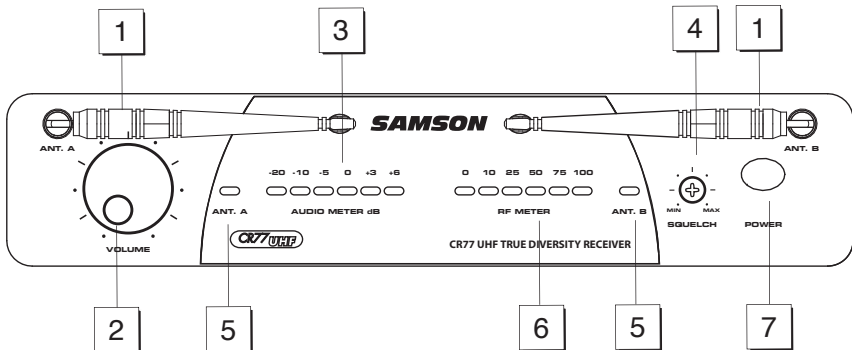

1: Antennas (A and B) - The antenna mountings allow full rotation for optimum placement. In normal operation, both Antenna A (the antenna on the left) and Antenna B (the antenna on the right) should be placed in a vertical position. Both antennas can be folded inward for convenience when transporting the CR77. See the "Setting Up and Using the AirLine System" section on page 17 in this manual for information about antenna installation and positioning.

2: Volume control - This knob sets the level of the audio signal being output through both the balanced and unbalanced output jacks on the rear panel (see #2 and #4 on page 8 in this manual). Reference level is obtained when the knob is turned fully clockwise (to its "10" setting).

3: Audio Meter - This "ladder" display (similar to the VU bar meter used on audio devices) indicates the strength of the incoming audio signal. When the "0" segment is lit, the incoming signal is optimized at unity gain; when the "+6" segment is lit, the signal is overloading. When only the left-most "-20" segment is lit, the incoming signal is at just 10% of optimum strength. If no segments are lit, little or no signal is being received. See the "Setting Up and the Concert Series System" section on page 16 in this manual for more information.

4: Squelch control - This control determines the maximum range of the CR77 before audio signal dropout. Although it can be adjusted using the supplied plastic screwdriver, it should normally be left at its factory setting. See the "Setting Up and Using the Concert Series System" section on page 17 in this manual for more information.

5: A/B Antenna LEDs - When signal is being received, one of these will be lit green, showing you whether the (left "A" or right "B" antenna is currently being used. The CR77 constantly scans its two antennas and automatically selects whichever is receiving the strongest, clearest signal. This **True Diversity** switching is completely inaudible, but it effectively increases overall range while virtually eliminating potential interference and phase cancellation problems.

6: RF (Radio Frequency) Level meter - This "ladder" display (similar to the VU bar meter used on audio devices) indicates the strength of the incoming radio signal. When the "100%" segment is lit, the incoming RF signal is fully modulated and at optimum strength. When only the second most left-most "10%" segment is lit, the incoming signal is at just 10% of optimum strength. If no segments are lit, little or no signal is being received. See the "Setting Up and Using the Concert Series System" section on page 17 in this manual for more information.

8: Power switch - Use this to turn the CR77 power on and off. When the receiver is on, the internal Power LED is lit.

Guided Tour - CR77 Rear Panel

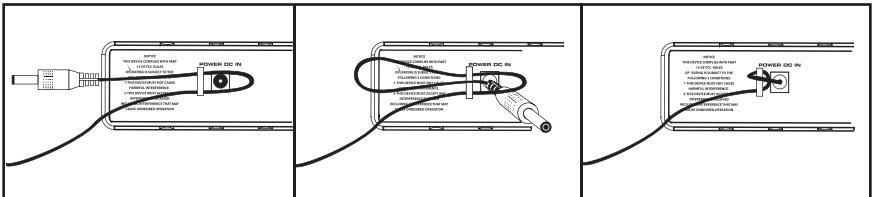
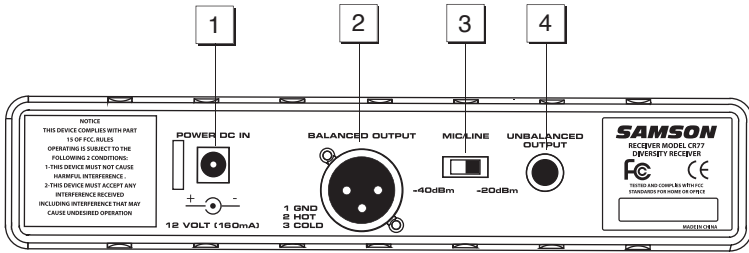

Using the strain relief: Gather up a loop of wire and pass it through the strain relief, then pass the adapter plug through the loop in order to create a knot.

- 1: DC input** - Connect the supplied 12 volt 160 mA power adapter here, using the strain relief as shown in the illustration below. **WARNING:** Do not substitute any other kind of power adapter; doing so can cause severe damage to the CR77 and will void your warranty.
- 2: Balanced output*** - Use this electronically balanced low impedance (600 Ohm) XLR jack when connecting the CR77 to professional (+4) audio equipment. Pin wiring is as follows: Pin 1 ground, Pin 2 high (hot), and Pin 3 low (cold).
- 3: Audio Output Level switch** - Sets the audio output level attenuation of the balanced output (see #4 below) to -20 dBm (line level) or -40 dBm (mic level). See the "Setting Up and Using the Concert Series System" section on page 8 in this manual for more information.
- 4: Unbalanced output*** - Use this unbalanced high impedance (5K Ohm) 1/4" jack when connecting the CR77 to consumer (-10) audio equipment. Wiring is as follows: tip hot, sleeve ground.

* If required, both the unbalanced and balanced outputs can be used simultaneously

Concert Series Frequency Conversion Chart

Channel	Frequencies	Channel	Frequencies
U1	801.375 MHz	E1	863.125 MHz
U2	801.875 MHz	E2	863.625 MHz
U3	803.125 MHz	E3	864.500 MHz
U4	803.750 MHz	E4	864.875 MHz
U5	804.500 MHz		
U6	804.750 MHz		

Guided Tour - CT7L /CT1G

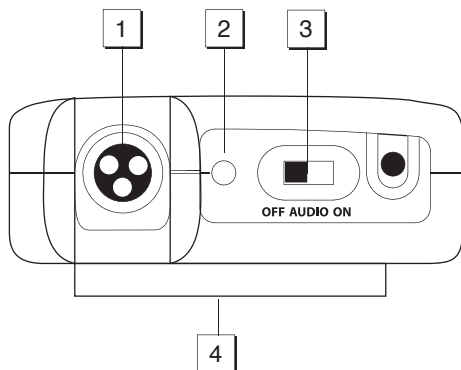

1: Input connector - The input device is connected here. The CT7 is supplied with either a lavalier or headset microphone or 1/4" jack cable (connected via a mini-XLR jack).

2: Power / Battery LED - This LED flashes once when the CT7 is first turned on and lights steadily red when there are less than 2 hours of battery power remaining, indicating that the battery needs to be changed. In order to avoid compromising audio fidelity (or having the CT7 stop working completely), you should always replace the battery with a fresh one immediately whenever this LED lights red.

3: Audio on-off switch - When set to the "on" position, audio signal is transmitted. When set to the "off" position, the audio signal is muted. Because the carrier signal remains during muting, no "pop" or "thud" will be heard. Note that turning this off does not turn off the transmitter power—it is simply a way to temporarily mute the transmission of audio signal. If you don't plan on using the transmitter for extended periods, turn off the transmitter power by using the power on-off switch (see #8 on the next page).

4: Belt clip - Use this clip to fasten the CT7 to a belt.

5: Battery cover release - Push in both sides of the battery cover and pull back to open the CT7 battery cover.

6: Antenna - This permanently attached transmitter "stiff" antenna should be fully extended for normal operations. See the "Setting Up and Using the Concert Series System" section on page 8 in this manual for more information about antenna positioning.

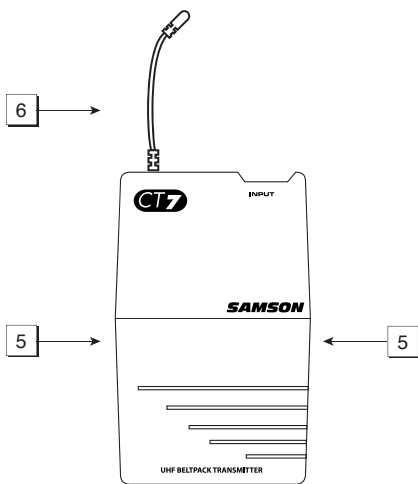

Guided Tour - CT7L / CT7G

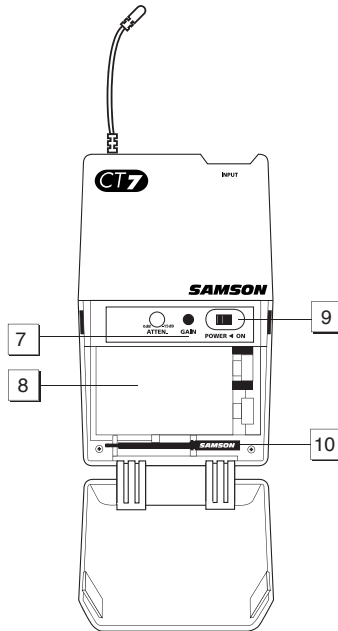

7: Audio Input Level control (trimpot) - This input sensitivity control has been factory preset to provide optimum level for the particular lavalier, headset or for optimum instrument level, so we recommend that this not be adjusted manually. If necessary, however, you can use the supplied plastic screwdriver (see #10 below) to raise or lower the CT7 input level. See the "Setting Up and Using the Concert Series System" section on page 8 in this manual for more information.

8: Battery holder - Insert a standard 9-volt alkaline battery here, being sure to observe the plus and minus polarity markings shown. We recommend the Duracell MN 1604 type battery. Although rechargeable Ni-Cad batteries can be used, they do not supply adequate current for more than four hours. **WARNING:** Do not insert the battery backwards; doing so can cause severe damage to the CT7 and will void your warranty.

9: Power on-off switch* - Use this to turn the CT7 on or off (to conserve battery power, be sure to leave it off when not in use).

10: Plastic screwdriver - Specially designed for use in adjusting the CT7 Audio Input Level control (see #8 above) and/or CR77 Squelch control (see #7 on page 3). See the "Setting Up and Using the Concert Series System" section on page 8 in this manual for more information.

* Be sure to mute the audio signal at your external mixer or amplifier before turning transmitter power on or off, or an audible pop may result.

Guided Tour - HT7

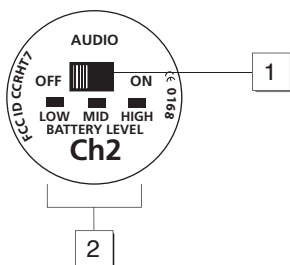

1: Audio on-off switch - When set to the “on” position, audio signal is transmitted. When set to the “off” position, the audio signal is muted. Because the carrier signal remains during muting, no “pop” or “thud” will be heard. Note that turning this off does not turn off the transmitter power—it is simply a way to temporarily mute the transmission of audio signal. If you don’t plan on using the transmitter for extended periods, turn off the transmitter power by using the power on-off switch (see #3 below).

2: Battery level meter - This set of three multicolor LEDs indicates relative battery power, indicating whether the installed battery is at low (red), mid (yellow) or high (green) strength. One of these will light whenever the HT7 is powered on (see #3 below). When the red “low” indicator lights, RF performance is degraded and the battery needs to be replaced.

3: Power on-off switch* - Use this to turn the HT7 on or off (to conserve battery power, be sure to leave it off when not in use).

4: Microphone Input Level control (trimpot) - This input sensitivity control has been factory preset to provide optimum level for the particular microphone capsule provided with your Concert 77 system and so we recommend that this not be adjusted manually. If necessary, however, you can use the supplied plastic screwdriver to raise or lower the input level. See the “Setting Up and Using the Concert Series System” section on page 8 in this manual for more information.

5: Battery holder - Insert a standard 9-volt alkaline battery here, being sure to observe the plus and minus polarity markings shown. We recommend the Duracell MN 1604 type battery. Although rechargeable Ni-Cad batteries can be used, they do not supply adequate current for more than four hours. **WARNING:** Do not insert the battery backwards; doing so can cause severe damage to the HT7 and will void your warranty.

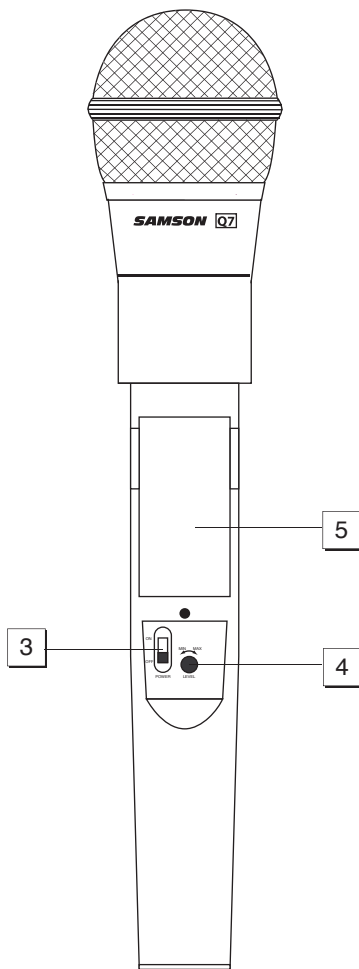

* Be sure to mute the audio signal at your external mixer or amplifier before turning transmitter power on or off, or an audible pop may result.

Setting Up and Using the Concert Series System

The basic procedure for setting up and using your Concert Series Wireless System takes only a few minutes:

1. For the Concert Series system to work correctly, both the receiver and transmitter must be set to the same channel. Remove all packing materials (save them in case of need for future service) and check to make sure that the supplied CR77 receiver and CT7 or HT7 transmitter are set to the same channel. If these channels do not match, contact your distributor or, if purchased in the United States, Samson Technical Support at 1-800-372-6766.
2. Physically place the CR77 receiver where it will be used (the general rule of thumb is to maintain "line of sight" between the receiver and transmitter so that the person using or wearing the transmitter can see the receiver). An optional rack-mount kit (available from your Samson dealer) allows the CR77 to be mounted in a standard 19" rack if desired. Extend both "A" and "B" antennas and place both in a vertical position.
3. Make sure the Power on-off switch in your CT7 belt-pack or HT7 handheld transmitter is set to "Off."
- 4a. If your system contains a CT7 belt-pack transmitter, push in both sides of the battery cover and pull back to open the battery door, which is hinged and not intended to be removed from the transmitter case. Please use care when opening this door as undue force will destroy the hinge.
- 4b. If your system contains a HT7 handheld transmitter, unscrew the bottom section of the microphone by turning it counterclockwise and then slide it off.
5. Place a fresh 9-volt alkaline battery in the transmitter battery holder, taking care to observe the polarity markings. If you are using a CT7 belt-pack transmitter, gently replace the battery door by swinging it up and pressing until it clicks. If you are using a HT7 handheld transmitter, replace the bottom section of the microphone by sliding it on and then screwing it back on. Whichever transmitter you are using, leave it off for the moment.
6. Make the physical cable connection between the CR77 output jack and the line or mic level audio input of your amplifier or mixer. If you are using the balanced XLR jack (preferable, since it will deliver an electromagnetically cleaner signal), be sure to set the CR77 rear panel Audio Output Level switch correctly. If required, both the balanced and unbalanced outputs can be used simultaneously. Leave your amplifier (and/or mixer) off at this time.
7. Turn the Volume knob on the CR77 completely counterclockwise. Using the strain relief, connect the supplied AC adapter to the DC Input on the rear panel of the CR77, then plug the adapter into any standard AC outlet. Press the front panel Power switch to turn on the CR77; the red "Power" LED will light up, but all other front panel LEDs will remain unlit.
8. Turn on the power to the CT7 or HT7 transmitter (using its Power on-off switch); the green "HIGH" Battery strength LED will light if the battery is sufficiently strong. At this point, either the "A" or "B" green LED on the front panel of the CR77 will light (depending upon which antenna is receiving the stronger signal). Also, one or more segments in the CR77 front panel RF Level meter should light; the more are lit, the stronger the RF signal. If only one or two segments light (indicating a relatively weak signal), try relocating the CR77 or changing the position of one or both of its antennas. If all six segments light, the CR77 is receiving an optimally strong RF signal and is placed and positioned correctly.
9. Now it's time to set the audio levels. Turn on your connected amplifier and/or mixer but keep its volume all the way down. Next, make sure that your transmitter is unmuted by setting its Audio switch to "On." Then set the Volume knob on the CR77 fully clockwise (to its "10" setting);

Setting Up and Using the Concert Series System

this is unity gain. If you are using the HT7 transmitter or if you are using the CT7 transmitter with a connected lavalier microphone or headset, speak or sing into the mic at a normal performance level while slowly raising the volume of your amplifier/mixer until the desired level is reached. If you are using the CT7 transmitter with a connected instrument, play the instrument at normal performance level while slowly raising the volume of your amplifier/mixer until the desired level is reached. If you are using a CT7 beltpack transmitter equipped with a lavalier microphone, note that correct lavalier placement is critical to sound quality. We recommend that you place it as shown in the illustration on the right—as close to your mouth as possible but off to one side (to minimize nasality) and unobstructed by clothing. Bear in mind also that omni microphones (mics which pick up signal from all directions) are more prone to feedback problems than unidirectional (cardioid or supercardioid) ones; in general, you can avoid feedback by taking care not to use any microphone directly in front of a PA speaker (if this is unavoidable, try using an equalizer to attenuate those high- or mid-range frequencies which are causing the feedback “squealing”).



10. If you hear distortion at the desired volume level, first check to see whether the yellow “Peak” LED on the CR77 is lit. If it is not, make sure that the gain structure of your audio system is correctly set (consult the owners manual of your mixer and/or amplifier for details). If the yellow “Peak” LED is lit, do the following:

- If you are using a HT7 transmitter, use the supplied plastic screwdriver to turn its Microphone Input Level control (trimpot) slowly counterclockwise (towards the “Min” position) until the distortion disappears.
- If you are using a CT7 transmitter with connected lavalier microphone or headset, its Audio Input Level control has been factory preset to provide optimum level for the particular lavalier or headset model being used and so no adjustment should be necessary. Any distortion present should therefore simply be a matter of the microphone being too close to the mouth; try moving it further away. If this does not solve the problem, use the supplied plastic screwdriver to turn the Audio Input Level control (trimpot) on the CT7 slowly counterclockwise until the distortion disappears.
- If you are using a CT7 transmitter with an instrument such as electric guitar or bass, lower the output level of the instrument until the distortion disappears. Alternatively, you can use the supplied plastic screwdriver to turn the Level control (trimpot) on the CT7 slowly counterclockwise until the distortion disappears.

Note that, following this setup procedure, you can always lower the Volume knob of the CR77 in order to attenuate the output signal if necessary.

Setting Up and Using the Concert Series System

11. Conversely, if you hear a weak, noisy signal at the desired volume level, again make sure that the gain structure of your audio system is correctly set (consult the owners manual of your mixer and/or amplifier for details) and that the Volume control of the CR77 is fully clockwise (at its “10” setting). If it is and the signal coming from the CR77 is still weak and/or noisy, do the following:

- If you are using a HT7 transmitter, use the supplied plastic screwdriver to turn the Level control (trimpot) on the transmitter slowly clockwise (towards the “Max” position) until the signal reaches an acceptable level.
- If you are using a CT7 transmitter with connected lavalier microphone or headset, its Level control has been factory preset to provide optimum level for the particular lavalier or headset model being used and so no adjustment should be necessary. Any weakness of signal should therefore simply be a matter of the microphone being too far from the mouth; try moving it closer. If this does not solve the problem, use the supplied plastic screwdriver to turn the Level control (trimpot) on the CT7 slowly clockwise until the signal reaches an acceptable level.
- If you are using a CT7 transmitter with an instrument such as electric guitar or bass, raise the output level of the instrument until a good signal is achieved. Alternatively, you can use the supplied plastic screwdriver to turn the Level control (trimpot) on the CT7 slowly clockwise until the signal reaches an acceptable level.

12. Temporarily turn down the level of your mixer/amplifier system and turn off the power to your transmitter, leaving the CR77 on. Then restore the previously set level of your mixer/amplifier. With the transmitter off, the receiver output should be totally silent—if it is, skip ahead to the next step. If it isn’t (that is, if you hear some noise), you may need to adjust the CR77 front panel Squelch control. When the Squelch control is at its minimum setting, the Concert Series system always provides maximum range without dropout; however, depending upon the particular environment your system is used in, you may need to reduce that range somewhat in order to eliminate band noise when the transmitter is turned off. To do so, use the provided screwdriver to rotate the Squelch control completely counterclockwise (to the “Min” position), then slowly turn it clockwise until the noise disappears. If no noise is present at any position, leave it at its fully counterclockwise “Min” position (so as to have the greatest overall range available).

13. When first setting up the Concert Series system in a new environment, it’s always a good idea to do a walkaround in order to make sure that coverage is provided for your entire performance area. Accordingly, turn down the level of your audio system and turn on both the transmitter and receiver. Then, with the transmitter unmuted, restore the level of your audio system and while speaking, singing, or playing your instrument, walk through the entire area that will need to be covered. As you do so, you will find that the green “A” and “B” LEDs on the CR77 receiver occasionally switch on or off, always showing you which antenna is receiving the stronger signal. Always try to minimize the distance between transmitter and receiver as much as possible so that the strongest possible signal is received from all planned transmission points. In fixed installations such as A/V or corporate conference rooms or for extended range applications (where the transmitter and receiver are more than 150 feet apart), it may be desirable to angle the antennas differently from their vertical position or to install the receiver in the same room as the transmitters (and, if necessary, to extend the wiring to remote audio equipment).

If you have followed all the steps above and are experiencing difficulties, contact your local distributor or, if purchased in the United States, call Samson Technical Support (1-800-372-6766) between 9 AM and 5 PM EST.

Appendix A: CT1L Multipin Wiring Guide and Chart

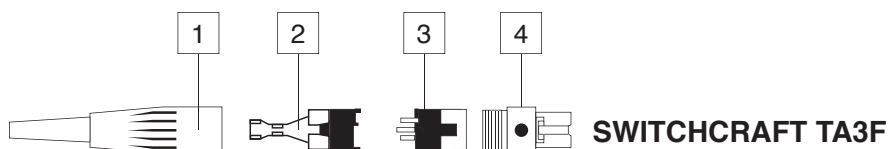

MANUFACTURER	MODEL	PIN 1	PIN 2	PIN 3
AUDIO TECHNICA	AT831	YELLOW x 2 SHIELD	RED x 2	JUMP TO PIN 2
AUDIO TECHNICA	ATM75	YELLOW x 2 SHIELD	RED x 2	JUMP TO PIN 2
AUDIO TECHNICA	ATPRO8HE	YELLOW x 2 SHIELD	N/C	RED x 2
AUDIO TECHNICA	MT350	SHIELD	WHITE	JUMP TO PIN 2
SONY	ECM44	SHIELD WHITE	RED	JUMP TO PIN 2
SONY	ECM40	SHIELD	WHITE	JUMP TO PIN 2
COUNTRYMAN	ISOMAX	SHIELD	WHITE	JUMP TO PIN 2
GUITAR		SHIELD	N/C	AUDIO
PIN INFORMATION	SWITCHCRAFT TA3F	GROUND	+Vdc	AUDIO

Procedure for wiring CT7L connector: Unscrew rubber boot 1 and pass wire through 1 and 2. Solder wire to 3 after removing from 4 (use chart above). Reinsert 3 to 4 with attached wire (3 is keyed to fit 4). Plug 2 into 3 again (2 is keyed to 3) and crimp wire. Resc

Specifications

System Specifications:

Channels	6
Frequency Type	F3
Modulation Type	FM
Noise Reduction Type	Compander/Expander
Distance	300 feet

Transmitter (HT7, CT7):

Oscillation Type	Direct PLL
Pre-emphasis	50 μ sec
Antenna	
HT7	Integral Antenna
CT7	1/4 Wave Length Wire (Pig Tail)
Input (CT7)	TB3M Switchcraft Connector
Maximum Input Level	3 V p-p
Battery	Duracell MN1604 9-volt alkaline
Operating Temperature	-20° C / 55° C
Switches / Controls	Power ON/OFF, Audio ON/OFF
HT7	Mic Level Volume
CT7	Audio Level
Display (LED)	Battery Low/Mid/High (corresponds to <5.3 V / 5.3 - 7 V / >7V)
Operating Voltage	9 Volts +20% / -40%
Current Consumption	47 mA
RF Power	10 mW
Frequency Stability	\pm 20 kHz
Spurious Ratio	2.5 nW
Deviation	20 kHz (16.5 kHz - 23.5 kHz)
T.H.D. (Overall)	0.5% (3% max) (@AF 1 kHz, RF 46 dBu)
AF Frequency Response	50 Hz - 15 kHz (\pm 3 dB overall)
Battery life	12 hours

Receiver (CR77):

Oscillation Type	PLL
De-emphasis	50 μ sec
IF Frequency	10.7 MHz
Antenna	1/4 Wavelength Rod
In/Out	DC Inlet, Balanced Output, Unbalanced Output
Display (LED)	Receiver A/B (Green), Power On (Red), Peak (Yellow), RF Level (5 pc)
Level Control	Audio Level Volume, Mute Level Control
Operating Temperature	0° C / 50° C
Operating Voltage	12 Volts \pm 10%
Current Consumption	160 mA (at all LED lights)
Receiving Frequency Range	801 - 805 MHz
Sensitivity	18 dB μ (@ THD 2%)
Squelch Sensitivity	0 - 40 dB μ (Adjustable)
Selectivity	\pm 150 kHz (AF Out Ratio -60 dB)
T.H.D. (Overall)	1% Max (@AF 1 kHz, RF 46 dBu)
S/N Ratio (Overall)	90 dB (w/IHF-A Filter)
Residual Noise	90 dBv (w/IHF-A Filter)
Band Mute	\pm 40 kHz / \pm 100 kHz (RF IN: 46 dBu EMF)
AF Frequency Response	50 Hz - 15 kHz (\pm 3 dB overall)
Audio Output Level - Unbalanced	0 dBv
Audio Output Level - Balanced	-20 dBm (Line), -40 dBm (Mic)
Audio Output Impedance - Unbalanced	5 k Ohms
Audio Output Impedance - Balanced	600 Ohms

Specifications subject to change.

FCC Rules and Regulations

**Samson wireless systems complies with FCC
rules parts 74 and 15.**

Licensing of Samson equipment is the user's responsibility and licensability depends on the user's classification, application and frequency selected.

**Operation is subject to the following two conditions:
(1) this device may not cause harmful interference and (2)
this device must accept any interference received, including
interference that may cause
undesired operation.**

Samson Technologies Corp.
575 Underhill Blvd.
P.O. Box 9031
Syosset, NY 11791-9031
Phone: 1-800-3-SAMSON (1-800-372-6766)
Fax: 516-364-3888
www.samsontech.com