

Preliminary

CUSTOMER APPROVAL SHEET

Company Name	
MODEL	ST-GR2900N
CUSTOMER APPROVAL	

- APPROVAL FOR SPECIFICATIONS ONLY (Spec. Ver. 1.0)**
- CUSTOMER REMARK :**

Issued By	Checked By	Approved By
YJ Kim	YB Lee	JG Ryu

Samsung Electro-Mechanics

150, Maeyoung-ro(Maetan3-Dong), YoungTong-Gu, Suwon, Gyeonggi-Do, Korea

Tel : 82-31-210-5114

Preliminary

S-TAG Datasheet

S-Label (Electronic Label System)

REV 1.0

Samsung Electro-Mechanics

2015-08-24

Summary

This datasheet presents the general performance and specifications of S-Tag for S-Label ESL (Electronic Shelf Label) system, which is based on IEEE 802.15.4.

© 2015 Samsung Electro-Mechanics. All rights reserved

The names of actual companies and products mentioned herein may be the trademarks of their respective owners.

No part of this document may be reproduced, stored in a retrieval system, or transmitted in any form or by any means without the express written consent of Samsung Electro-Mechanics.

This document is subject to change without notice.

Preliminary

Table of Contents

1	GENERAL DESCRIPTION	5
1.1	FEATURES	6
1.2	TYPICAL APPLICATIONS	6
1.3	APPEARANCE	7
2	SPECIFICATION	8
2.1	PRODUCT SPECIFICATION	8
2.2	RADIO (RF) SPECIFICATION	8
2.3	NFC SPECIFICATION	9
2.4	MECHANICAL DRAWING	9
2.5	LABELS	11
2.6	BARCODE SCANNING	13
3	OPERATION TEST	14
4	ESL OPERATION BY DISPLAY	16
5	PACKAGE	19
6	CAUTIONS FOR TREATMENT	20
6.1	USAGE ENVIRONMENT	20
6.2	STORAGE AND USE	20
6.3	BATTERY REPLACEMENT	21
6.4	FCC	22

Preliminary

Document History

Rev.	Date	Revision history	Page
1.0	24 AUG 2015	Initial release	-

CONFIDENTIAL

Preliminary

1 General Description

This S-Tag product is a part of Samsung S-Label (Electronic Shelf Label) system as well as S-Label Gateway (S-Gate), Remote controller (S-RC). S-Label system make up a system that electronically displays price and other product information on S-Tags, which has been traditionally printed or written on paper in places like retail markets.

S-Tag receives product price/information updates from S-Gate and updates or changes its display of price and other information.

S-Tag is the product based on IEEE standard 802.15.4 for low power wireless communication applications. S-Tag consists of RF transceiver, RF circuitry and ARM Cortex M3 MCU offering IEEE 802.15.4 based network protocol and MAC protocol and other peripheral devices.

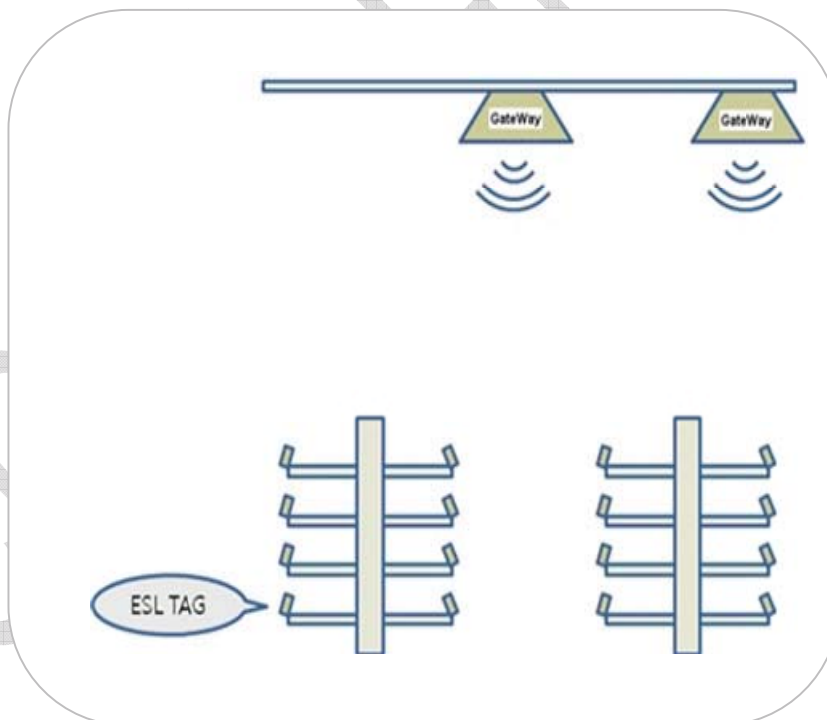

Figure 1 ESL System

Preliminary

1.1 Features

- Display : E-Paper Display (EPD) (active type) (68.72 x31.02 mm)
- Display Color : Black, White, Red
- Display Resolution : 296 x 128 pixel (112dpi)
- Communication : Wireless communication based on IEEE 802.15.4
- Operating on 2.4GHz Unlicensed ISM band for ZigBee (2405 ~ 2480 MHz)
- Low Power Consumption
- External Wakeup : RF Wakeup (using ISM Band[2.4GHz])
- Outline Dimension : 84.22 mm x 41.12 mm x 11.83 mm
- Working condition: Indoor where wireless communication is available.
- NFC(13.56MHz) Available

1.2 Typical Applications

- Retail industry with electronic displays, platforms, solutions and services.
- Intelligently communicating, managing, and optimizing price and product informations.

Preliminary

1.3 Appearance



[Front]

[Rear]



Preliminary

2 Specification

2.1 Product Specification

Item	Description
Size	84.22 x 41.12 x 11.83 mm
Battery	CR2450 Lithium Battery (3V, 2PCS) 2.4 ~ 3.3Vdc (condition : In active status)
Display	EPD PANEL display (Graphic type) 2.9 Inch, 112 Dpi, 296 x 128 Pixel 3Color : White / Black / Red
Housing Color	White
Information display	Price, Unit, Symbol etc.
Communication	Wireless communication based on IEEE 802.15.4 (2405 ~ 2480 MHz)
Communication Distance	Radius 20m (Line of Sight)
Operation Temp.	0 ~ 40 °C (@20~60% RH)
Etc.	No additional anti-theft locking structure : Rail Mounted only

2.2 Radio (RF)¹ Specification

Item	Parameter	SPEC			Unit	Condition
		Min	Typ	Max		
TX	Transmit Power	-3	1.5	6	dBm	
	Error Vector Magnitude	-	10	28	%	When measured for 100 chips
	Tx Current		-	33	mA	Total current at max Tx Power
RX	Receiver Sensitivity	-90	-	-	dBm	PER < 1%

¹ Test Channel : 2480MHz

Preliminary

2.3 NFC Specification

Items	Parameter	spec.			Units	Condition
		Min	Typ	Max		
NFC	Read/Write Distance	-	40	-	mm	PCB status
		-	30	-	mm	TAG status

2.4 Mechanical Drawing

2.4.1 Case Dimension

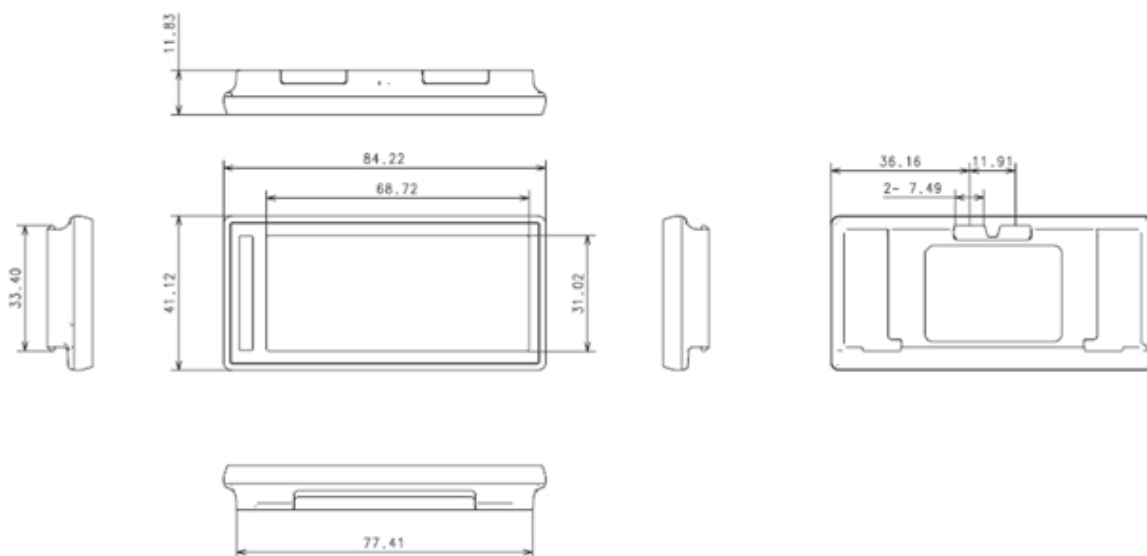

Figure 3 Mechanical Dimension

Preliminary

2.4.2 Exploded View

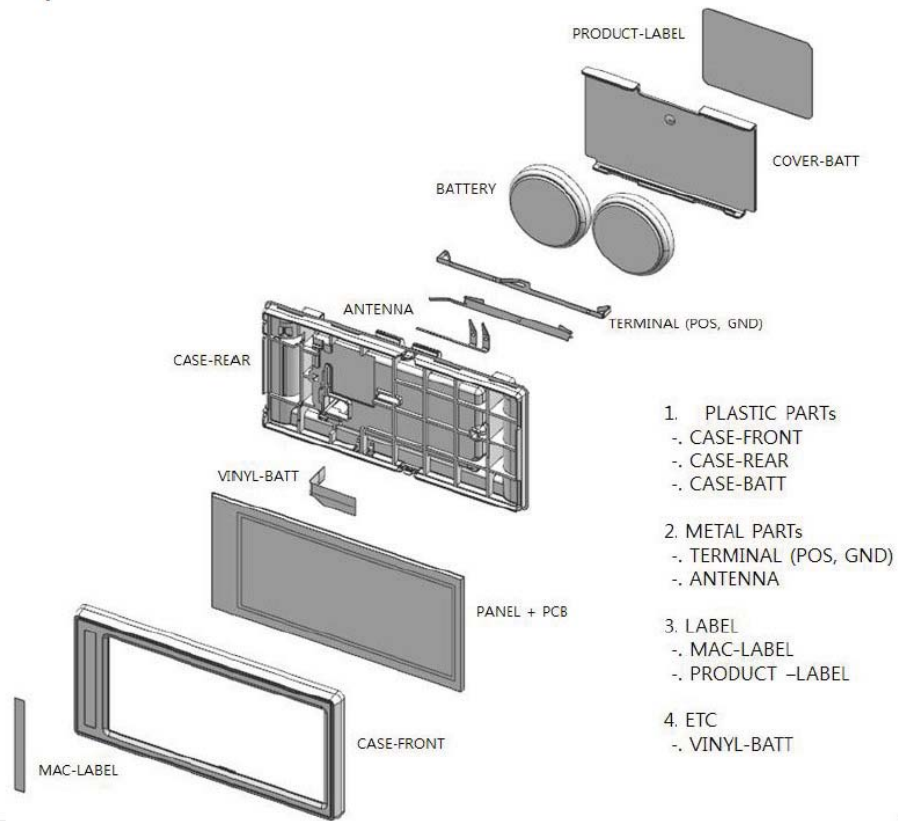

Figure 4 Exploded View

Preliminary

2.5 Labels

2.5.1 Serial Number Information

Serial 1, 2 Code Value

14	3	G	S	A	A	2JW
①	②	③	④	⑤	⑥	⑦

- ① Year : Last two digits of manufacturing year.
(00 ~ 99, Example : 2014 is '14')
- ② Month : Manufacturing month
(1 ~ 9, X(10), Y(11), Z(12))
- ③ Date : Manufacturing date
(1 ~ 9, A(10) ~ V(31))
- ④ Vendor : Manufacturing vendor
(S : SEMTHAI, T : TSEM, etc)
- ⑤ Line number : Manufacturing Line number
('A', 'B', 'C', etc)
- ⑥ Revision : Product revision number
(A : First, B : Second, C : Third, etc)
- ⑦ ZigBee IC Lot Number : Last 3 characters

①

년	CODE
2009	09
2010	10
2011	11
2012	12
2013	13
2014	14
2015	15
2016	16
2017	17
2018	18
2019	19
2020	20
2021	21
2022	22

②

월	CODE
1	1
2	2
3	3
4	4
5	5
6	6
7	7
8	8
9	9
10	X
11	Y
12	Z

③

일	CODE
1	1
2	2
3	3
4	4
5	5
6	6
7	7
8	8
9	9
10	A
11	B
12	C
13	D
14	E
15	F
16	G
17	H
18	I
19	J
20	K
21	L
22	M
23	N
24	O
25	P
26	Q
27	R
28	S
29	T
30	U
31	V

Preliminary

2.5.2 Product and Mac Label Drawings

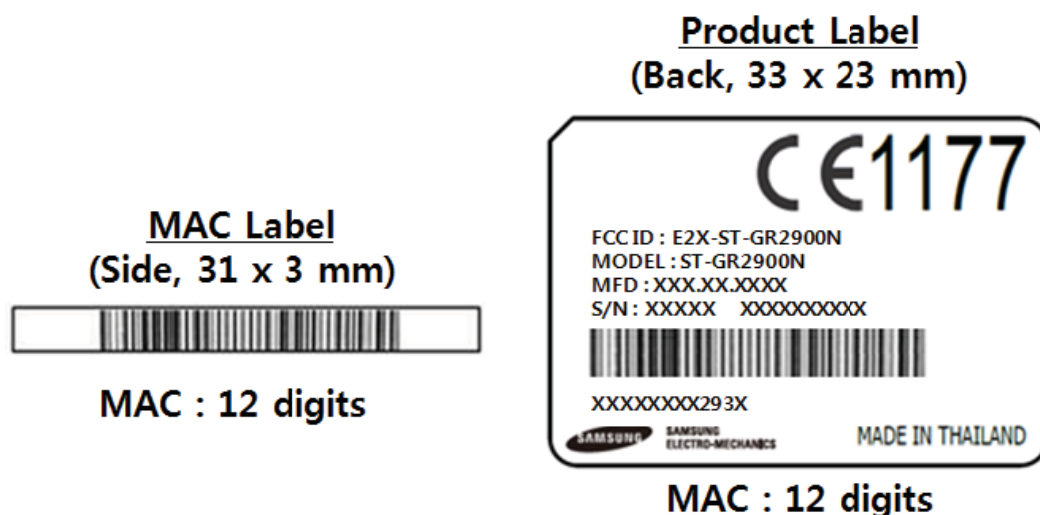

Figure 5 Product and Mac Labels

Product information is indicated in a printed sticker label. The information consists of FCC ID, MODEL (model name), MFD (manufacturing date), S/N (serial number), MAC (MAC address), CE certification mark, FCC ID and Manufacture (SEMCO).

- 1) FCC ID : E2X-ST-GR2900N
- 2) Model Name : ST-GR2900N
- 3) MFD : (Month).(Date).(Year) ex) May.16.2014
- 4) S/N : Serial Number Information
- 5) MAC : barcode & barcode number(hexadecimal 16 digits)
 - 8 digits(1st ~ 8th) : xxxxxx (Tag I.D.)
 - 2 digits(9th ~ 10th) : 29 (Tag size & type)
 - 1 digit(11th) : 3 (Panel & NFC type)
 - 1 digit(12th) : x (Checksum)

Preliminary

2.6 Barcode Scanning

2.6.1 Barcode Scanning Condition

Typically Scan distance is 8 ~ 9cm and angle is horizontality

Example)

Item	MODEL		Distance	Angle
Scanner	SYMBOL	(DS6708-SR20007ZZR)	8~9cm	Horizontality
	DATALOGIC	(QUICKSCAN QD2430)	8~9cm	Horizontality
	Motorola	(MC3190-SI2H04E0A)	8~9cm	Horizontality
PDA	Motorola	(MC17T-00)	6cm	30°
	Motorola	(MC4597-BAPBA0000)	8~9cm	Horizontality
	M3	(NA8NWCNMH40078)	8~9cm	Horizontality

<Horizontality>

<30°>



Preliminary

3 Operation Test

It will be updated before 2nd release. Below is just a sample.

- Equipments : Gateway (S-Gate), R/C (S-TAG), Jig for power supply
- Target DUT : EPD TAG



Figure 6 Operation Test

- **Test Scenario**
 - ① Install Tag on Jig
 - ② Ready to Gateway(S-Gate) and R/C
 - ③ wake up Tag with R/C
 - ④ Tag start to communicate with Gateway
 - ⑤ Tag display the numeric information received from Gateway
 - ⑥ Check Tag(EPD display status & MAC address value)
 - ⑦ Wake up Tag with R/C
 - ⑧ Check Tag(EPD display(blank display))
- **Criterion** (Below both two conditions should be all satisfied)
 - ① Good : You can see 'Black' → 'White' display
 - ② Compare MAC address with that of label attached to Front or Back plane.

Preliminary

- **Position**

- ① Wake up
- ② NFC

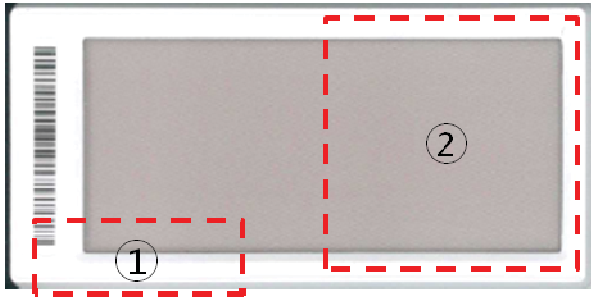





CONFIDENTIAL



Preliminary

4 ESL Operation by display

It will be updated before 2nd release. Below is just a sample.

Display	State	User Action
	STATE: 1 Initial display when shipped from the manufacturer (Blank display).	None
	STATE: 1 No change.	To assign a tag using a PDA
	STATE 1 → 2 Searching for GWs (MAC address, tag version and triangle).	A tag woken up by an RC
	STATE 2 → 4 A tag is connected to a GW and received price (Price)	None

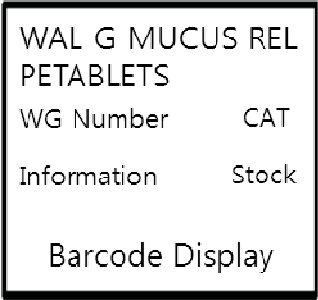
Preliminary

	<p>STATE 2 → 3</p> <p>A tag failed to locate a GW (blank).</p>	
	<p>STATE 4 → 5</p> <p>When a tag is connected to a GW, and woken up by an RC, Next page display predefined.</p> <p>Display is end, tag wait 10 second wakeup signal by RC. When signal is detected in this time, immediately return first Page and Send Price Request to GW. No signal in this time, after 10 second return first Page and Same Operation.</p>	<p>Woken up by an RC</p>
	<p>STATE 4 → 6</p> <p>Connection to a GW is lost (price and Rectangle on upper right corner)</p>	<p>None</p>
	<p>STATE 6 → 6</p> <p>When connection is lost and woken up by an RC (blinks with the price and Rectangle)</p> <p>Starts to search GWs.</p>	<p>Woken up by an RC</p>

Preliminary

	<p>STATE 4 → 1 Initial display (Blank display).</p>	<p>To clear an assigned tag using a PDA</p>
---	---	---

CONFIDENTIAL

Preliminary

5 Package

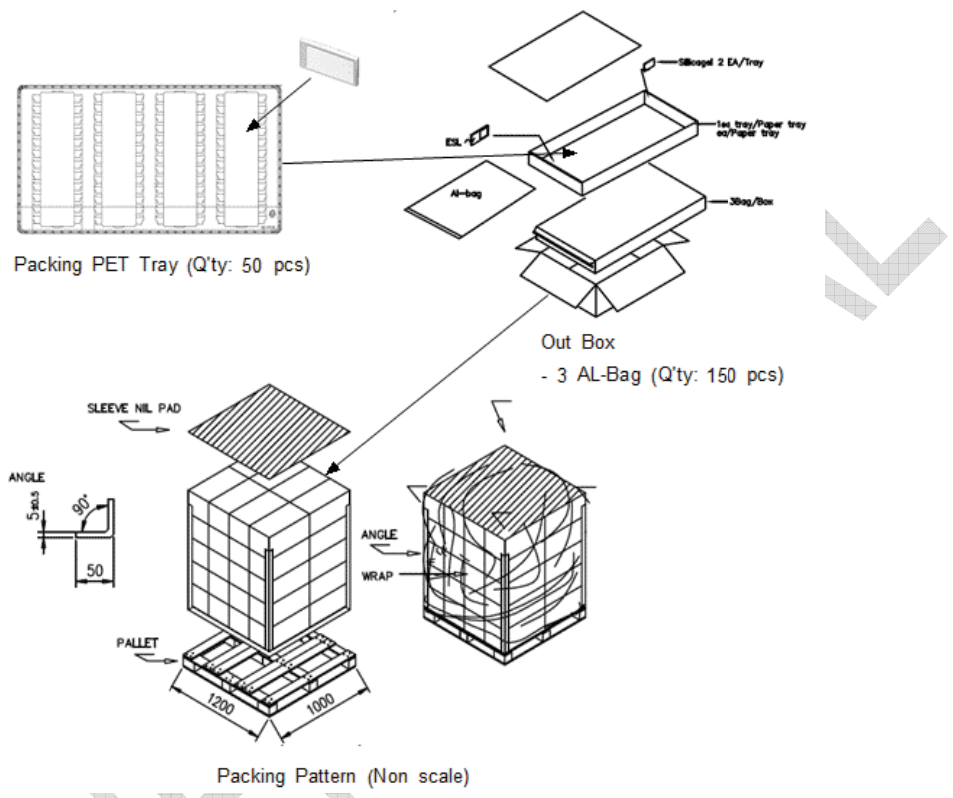

LABEL-BAG

LABEL-OUTBOX(L)

LABEL-OUTBOX(R)

TAG (WORLD)
 PART NAME : XXXXXXXXXXXXXXXX
 PART NO : XXX-XXXXX

 LOT NO : XXXXXX

 Q'TY : XXX PCS

TAG (WORLD)
 PART NAME : XXXXXXXXXXXXXXXX
 PART NO : XXX-XXXXX

 LOT NO : XXXXXX

 Q'TY : XXX PCS

TAG SIZE : H X W X D
 COUNTRY : XXXXXX
 ESEL VERSION : X.X
 FIRMWARE VERSION : X.X

Preliminary

6 Cautions for Treatment

Provisions should be made to protect against any damage to the product caused by improper handling.

It is highly recommended that the product should be installed within 3 months from the date of arrival in the logistics hub. Recommended storage condition is in 0-40 Celsius degree, 20-60% RH environment.

This RF device operates on the 2.4GHz frequency band and can produce radio interference. The device, therefore, may not be used for applications where safety of human lives is concerned.

6.1 Usage Environment

Take extra cautions when using this RF device in the vicinity of other electronic devices and appliances. Most electronic devices and appliances use electromagnetic waves. Electromagnetic waves emitted by this RF device can affect other electronic devices and appliances.

If using the device in an explosion hazard area, follow all safety regulations, instructions, and signals.

6.2 Storage and Use

- Moisture and liquids can damage internal parts and circuit boards if allowed to enter into the device itself.
- Do not place or store the product on a sloped surface. The product may slide and fall off the surface and damaged.
- Use the product in temperatures ranging from 0°C to +40°C. Parts and circuits may be damaged if used or stored under temperature extremes.
- The display panel needs extra care when handling.
 - Do not apply any impacts on outside since e-Paper display is fragile.
 - Continuous exposure to excessive moisture (over 60% RH) or UV makes display lifetime shortened.
 - Ghosting image may be appeared in temperature conditions of less than 15 Celsius degree.
- Avoid areas with strong magnetism or subject to magnetism.
Contact between the device and a magnetic object can lead to malfunctions.
- Do not place the product near heat-producing kitchen appliances like a stove or a microwave or in

Preliminary

the vicinity of highly pressurized containers.

- External impact to the product, such as from being dropped, can damage the product or battery casing can be separated.
- Twisting and bending the product can damage the exterior casing and the internal components.
- If this product operates abnormally in eliminating battery vinyl or replacing battery, you should discharge it by contacting battery terminal (+) and (-).
- This product uses 2.4GHz frequency band for wireless communication network. Radio communications can be limited or affected by other applications which share same frequency band, such as WiFi, Bluetooth, Zigbee, etc.
- Frequent communications, updates and screen renewals may reduce battery life time.

6.3 Battery Replacement

Audience

Authorized persons with the following knowledge are allowed to replace the battery.

- . Battery / -. Electronic assemblies like circuit board / -. Compliance of the instruction

※ Note : If not authorized person, it will not give any warranty.

(When need to replace the battery. Please contact authorized person and get instructions.)

Instructions

- Risk of short circuit if battery is incorrectly installed/stored.
- Keep attention that your hands are dry before you start with replacement
- Keep away batteries from children and infants.
- Don't heat, charge, bend, drop, short-circuit and disassemble battery.
- Don't mix the used battery together with the new battery or different type of batteries.

※ Note : Battery rarely has a little stain or leak.

Steps

- ① Open the battery cover.
- ② Take out the batteries.
- ③ Put in the new batteries.
- ④ Check the batteries direction.
- ⑤ Put the battery cover.

[View] Top : (+) Positive

Bottom : (-) Negative

■ Battery directional

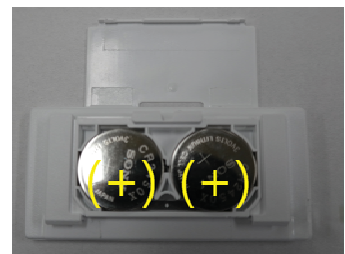

Preliminary**6.4 FCC**

FCC ID : E2X-ST-GR2900N

WARNING : This equipment may generate or use radio frequency energy. Changes or modifications to this equipment may cause harmful interference unless the modifications are expressly approved in the instruction manual. The user could lose the authority to operate this equipment if an unauthorized change or modification is made.

This device complies with part 15 of the FCC Rules. Operation is subject to the following two conditions: (1) This device may not cause harmful interference, and (2) this device must accept any interference received, Including interference that may cause undesired operation.

NOTE : This equipment has been tested and found to comply with the limits for a Class B digital device, pursuant to part 15 of the FCC Rules. These limits are designed to provide reasonable protection against harmful interference in a residential installation This equipment generates, uses and can radiate radio frequency energy and, if not installed and used in accordance with the instructions, may cause harmful interference to radio communications, However, there is no guarantee that interference will not occur in a particular installation. If this equipment does cause harmful interference to radio or television reception, which can be determined by turning the equipment off and on, the user is encouraged to try to correct the interference by one or more of the following measures:

- Reorient or relocate the receiving antenna.
- Increase the separation between the equipment and receiver.
- Connect the equipment into an outlet on a circuit different from that to which the receiver is connected.
- Consult the dealer or an experienced radio/TV technician for help.

Caution

This device complies with FCC radiation exposure limits for an uncontrolled environment.

Avoid operating this device at a distance less than 20cm form the user