

**SAMSUNG**

# User Manual

# Table of contents

## Getting started

- 3 About this manual
- 7 Layout
- 12 Turning the computer on and off
- 14 Unlocking the screen
- 14 Windows

## Basics

- 17 Wired keyboard/mouse (optional)
- 19 Wireless keyboard/mouse (optional)
- 26 Memory card
- 29 External display
- 30 Using the LCD as an external monitor (optional)

- 31 Playing music from a mobile device through the computer's speakers (optional)
- 34 Wired LAN
- 37 Wireless LAN
- 38 Using the Security slot

## Applications

- 39 Using applications
- 40 Samsung Settings
- 41 Samsung Update
- 42 Online Support (S Service)
- 43 Samsung PC Help (Self-help application)

## Settings & Upgrade

- 44 LCD brightness
- 45 Volume
- 46 BIOS (Setup utility)

## Troubleshooting

- 51 Samsung Recovery
- 57 Windows recovery function
- 57 Q&A

## Appendix

- 60 Product specifications
- 61 Ergonomic tips
- 65 Safety precautions
- 73 Important safety information
- 76 Replacement parts and accessories
- 79 Regulatory compliance statements
- 89 WEEE symbol information
- 91 Samsung package Take-Back program

# Getting started

## About this manual

- This user manual is specially designed to detail the computer's functions and features.
  - The user manual supplied with the computer may vary depending on the model.
  - Please read this manual before using the computer to ensure safe and proper use.
  - Optional accessories, some devices, and software referred to in this manual may not be provided or may not be subject to upgrades. Note that the computer environment referred in the user manual may not be the same as your environment.
  - Descriptions are based on the computer's default settings and the Windows 10 operating system. Available features and additional services may vary depending on the computer or operating system.
- This user manual describes procedures for using the touchpad, mouse and touch screen. Instructions for using the touch screen are for models with the touch screen feature.
  - Images and screenshots are those of the representative model of the series and may differ in appearance from the actual product.
  - Content may differ from the final product and is subject to change without prior notice. For the latest version of the manual, refer to the Samsung website, [www.samsung.com](http://www.samsung.com).

## Instructional icons and expressions



**Warning:** situations that could cause injury to yourself or others



**Caution:** situations that could cause damage to the computer or other equipment



**Note:** notes, usage tips, or additional information



The path you should follow to carry out an instruction. For example, “select **Settings** → **Devices**” indicates that you should select **Settings** and then **Devices**.

**Select** Click the mouse or tap the touchpad or touch screen.

## Copyright

Copyright © 2016 Samsung Electronics

This manual is protected under international copyright laws.

No part of this manual may be reproduced, distributed, translated, or transmitted in any form or by any means, electronic or mechanical, including photocopying, recording, or storing in any information storage and retrieval system, without the prior written permission of Samsung Electronics.

Computer specifications or the contents of this manual may be changed without prior notice due to an upgrade of the computer’s functions.

## Trademarks

- Samsung and the Samsung logo are trademarks or registered trademarks of Samsung Electronics.
- Intel and Core are trademarks or registered trademarks of the Intel Corporation.
- Microsoft, MS-DOS, and Windows are trademarks or registered trademarks of the Microsoft Corporation.
- Bluetooth® is a registered trademark of Bluetooth SIG, Inc. worldwide.



- Wi-Fi®, Wi-Fi Protected Setup™, Wi-Fi Direct™, Wi-Fi CERTIFIED™, and the Wi-Fi logo are registered trademarks of the Wi-Fi Alliance.

- HDMI, the HDMI logo, and the term High Definition Multimedia Interface are trademarks or registered trademarks of HDMI Licensing LLC.
- All other trademarks and copyrights are the property of their respective owners.



## Data precautions

Samsung Electronics shall not be liable for any data loss. Please take care to avoid losing any important data and back up your data to prevent any such data loss.

## Operating system and software support

If you change the product's factory OS (Operating System) to another OS or if you install software which is not supported by the product's original factory OS, you will not receive any technical support, product exchange or refund, and a fee will be charged when requesting a service.

Please use your computer with the original factory OS. If you install an OS other than the factory OS, data may be deleted or the computer may not start.

## Recommended screen resolutions

It is recommended to set the resolution of your display based on standard Windows settings.

If you set a high resolution, such as QHD+ (3200x1800), it may not correctly display some applications.

## Product capacity representation

### Storage capacity representation

The capacity of the storage device (HDD, SSD) of the manufacturer is calculated assuming that 1 KB = 1,000 Bytes.

However, the operating system (Windows) calculates the storage device capacity assuming that 1 KB = 1,024 Bytes. Therefore, the available capacity of the HDD in Windows is smaller than the actual capacity due to the difference in capacity calculation. For example, for an 80 GB HDD, Windows calculates the capacity as 74.5 GB,  $(80 \times 1,000 \times 1,000 \times 1,000) \text{ Bytes} / (1,024 \times 1,024 \times 1,024) \text{ Bytes} = 74.505 \text{ GB}$ .

In addition, the capacity representation in Windows may be even smaller because some programs, such as Samsung Recovery, may reside in a hidden area of the HDD.

### Memory capacity representation

The available memory capacity in Windows is less than the actual capacity of memory. This is because some memory is required for regular system operations.

For example, for 1 GB (= 1,024 MB) memory installed, Windows may report the capacity as 1,022 MB or less.

## Layout



- Features or options may differ depending on the model.
- The items marked as optional may not be provided or may be provided in different locations.

### Front view

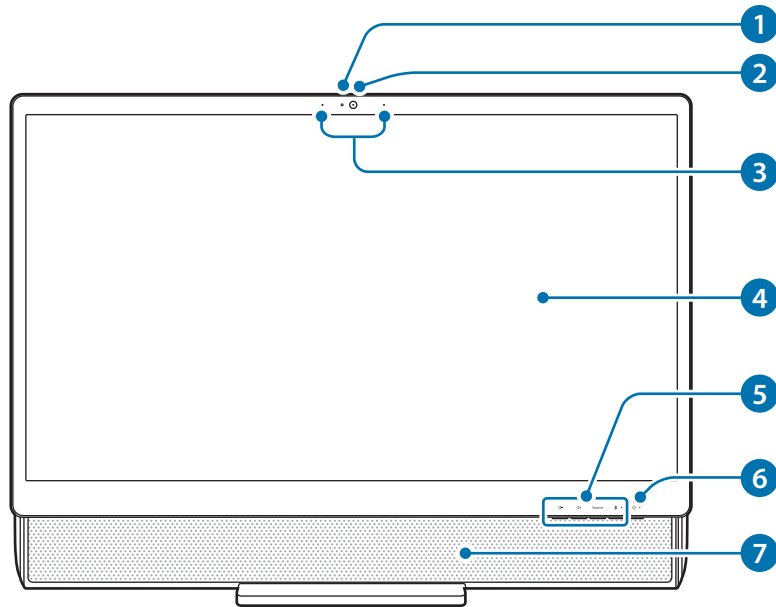

Number/Name	Description
1 Camera indicator light	• This indicates the camera operating status.
2 Camera	• Using this camera, you can take still pictures and record video.
3 Microphone	• You can use the built-in microphone.
4 LCD	• The screen's images are displayed here.
5 Control buttons (specified models only)	• This allows you to adjust various functions.
6 Power button/Power LED 	• Turns the computer on and off. • When the computer is on, the power LED is lit.
7 Speaker	• It emits the sound.



- To change the angle of the LCD screen, hold the side of the vent and the LCD and tilt it to the desired angle using both hands.
- Do not apply downward force to the product when it is placed face down. Doing so may damage the LCD.

## Control buttons (specified models only)

Use the buttons at the bottom of the monitor to control various functions.

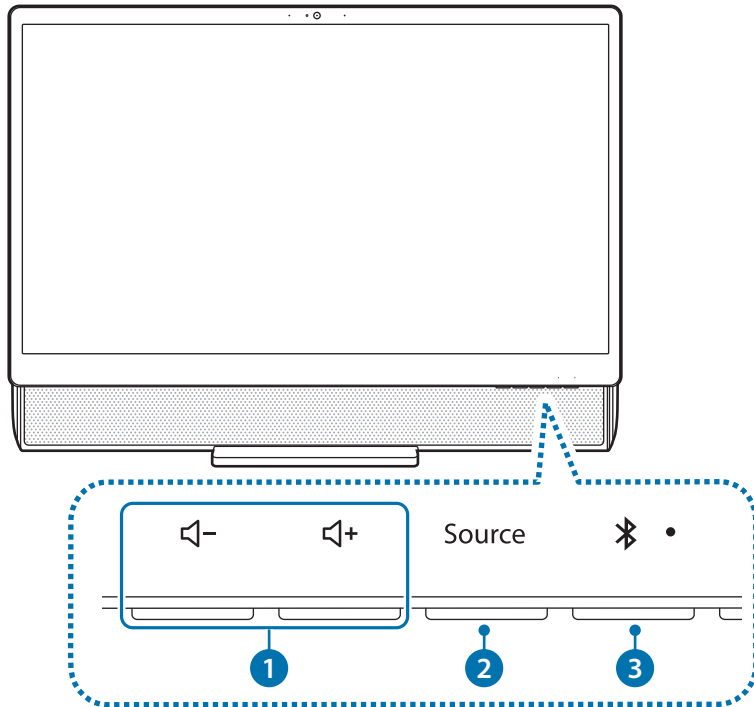

Number/Name	Description
1 Volume control 🔊- / 🔊+	<ul style="list-style-type: none"> <li>Adjust the volume.</li> </ul>
2 Mode selection Source	<ul style="list-style-type: none"> <li>Switches between <b>PC mode</b> and <b>Monitor mode</b>.                             <ul style="list-style-type: none"> <li><b>PC mode:</b> The computer operates normally as a computer.</li> <li><b>Monitor mode:</b> The computer functions as a monitor.</li> </ul> </li> </ul>
3 Bluetooth 📶 (optional)	<ul style="list-style-type: none"> <li>Enable or disable Bluetooth.</li> </ul>



Mode selection is used to switch between the PC mode and the Monitor mode.



## Side view

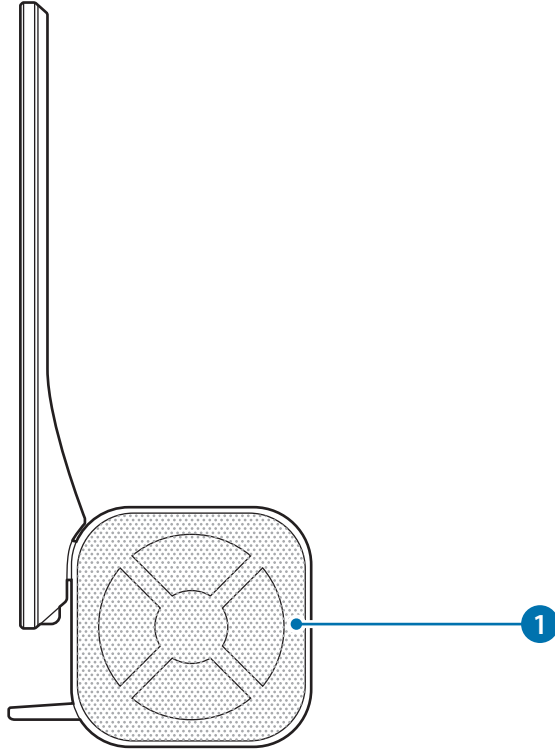







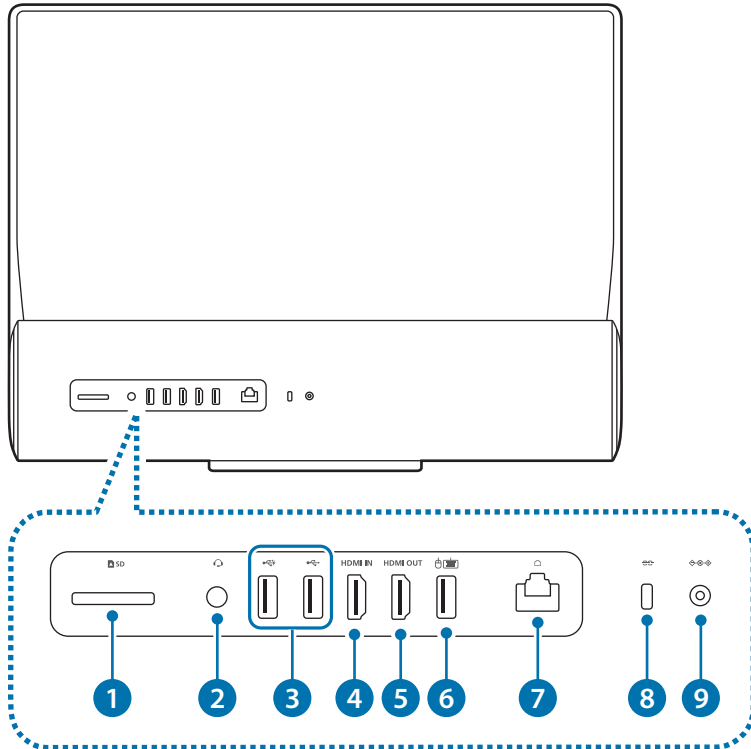

Number/Name	Description
1 Fan vents	<ul style="list-style-type: none"><li>• The internal heat of the computer is emitted through these holes.</li><li>• If the vents are blocked the computer may overheat. Avoid blocking the vents as this may be dangerous.</li></ul>







Do not block the vents or it may interfere with heat release.

## Rear view

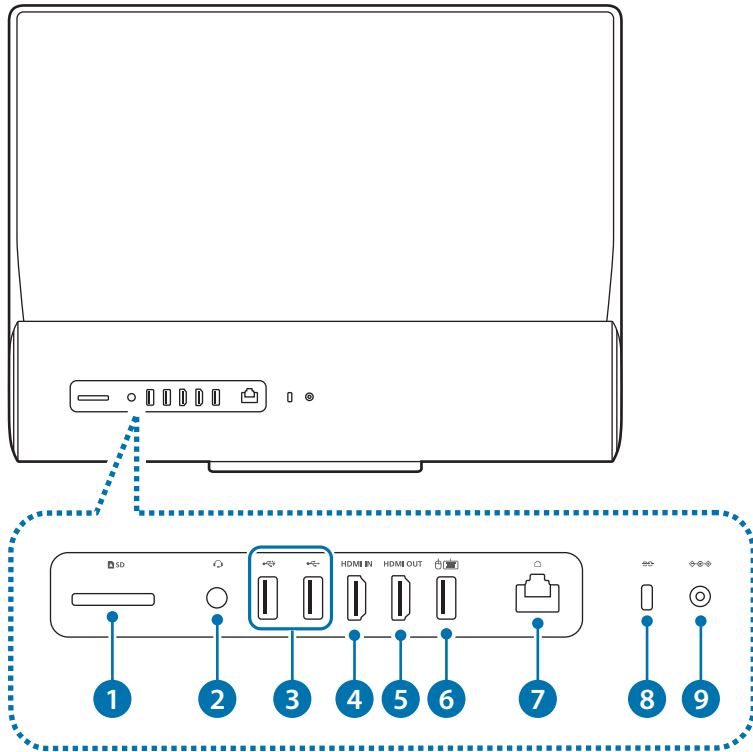

Number/Name	Description
1 Memory card slot  SD	<ul style="list-style-type: none"> <li>Insert a memory card into the slot.</li> </ul>
2 Earpiece/ Headset jack 	<ul style="list-style-type: none"> <li>Connect an earpiece or a headset to the computer to listen to audio.</li> </ul>
3 USB 3.0 port  or chargeable USB 3.0 port  (optional)	<ul style="list-style-type: none"> <li>USB ports to which you can connect USB devices as well as a chargeable USB port are provided.</li> <li>The chargeable USB port can be used to connect and charge a USB device.</li> </ul> <p> You can distinguish the ports by the figures printed on the ports or by color.</p> <ul style="list-style-type: none"> <li> : USB port</li> <li> : Chargeable USB port</li> </ul>
4 HDMI input port HDMI IN	<ul style="list-style-type: none"> <li>Used to connect an HDMI cable from an external device.</li> <li>Connect to another device via an HDMI cable to receive its audio and video on your computer.</li> </ul>



Number/Name	Description
5 HDMI output port HDMI OUT	<ul style="list-style-type: none"> <li>Used to connect an HDMI cable to an external device.</li> </ul>
6 USB 2.0 port 	<ul style="list-style-type: none"> <li>Connect various USB devices. You can connect the wireless receiver for the wireless keyboard and mouse to this port.</li> </ul>
7 Wired LAN port 	<ul style="list-style-type: none"> <li>Connect the Ethernet cable to this port.</li> </ul>
8 Security slot 	<ul style="list-style-type: none"> <li>Secure the computer by connecting an optional lock and cable to it.</li> </ul>
9 DC jack 	<ul style="list-style-type: none"> <li>This jack connects to the AC adapter to supply power to the computer.</li> <li>The appearance of the jack may differ depending on the model.</li> </ul>



### About the chargeable USB port

- The charging status of the USB device is not displayed on the computer.
- This feature may not be available with some USB devices.

# Turning the computer on and off

## Turning the computer on

- 1 Connect the power cable to the AC adapter.
- 2 Connect the AC adapter to the DC jack of the computer.
- 3 Plug the power cable into an electric socket.

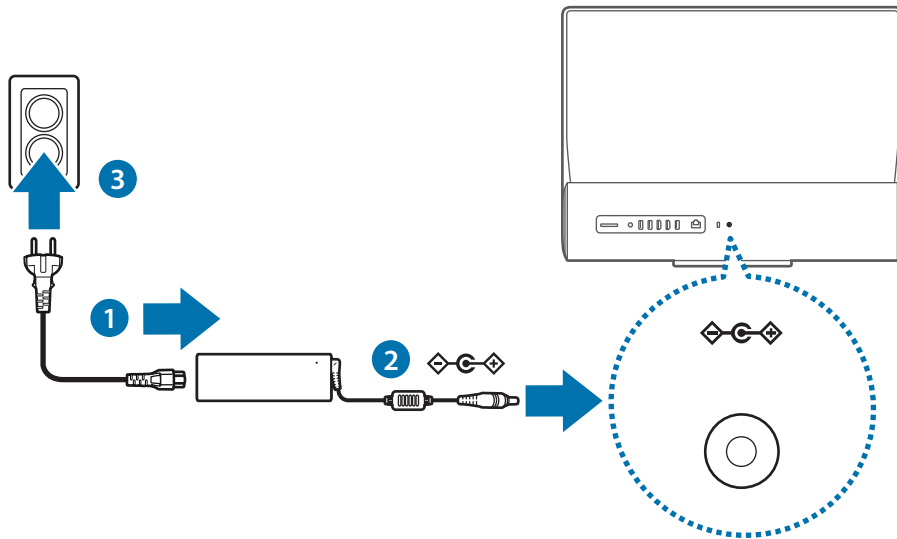

- 4 Press the Power button to turn the computer on.  
While the computer is on, the power LED is lit.

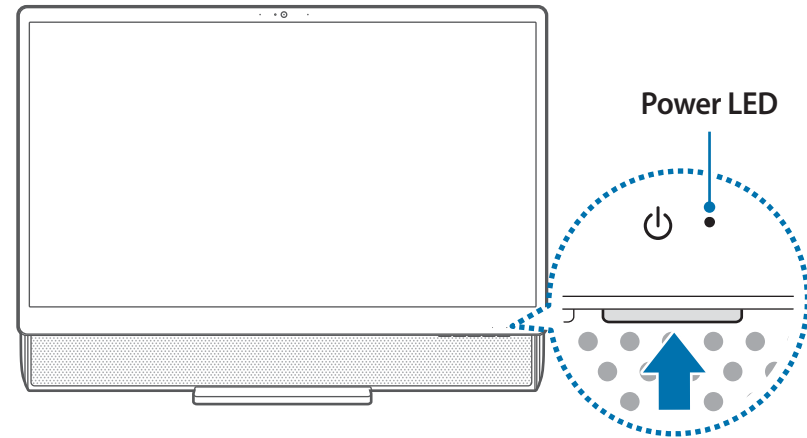

## About Windows Activation

When you turn the computer on for the first time, the Windows activation screen appears.

Follow the activation procedures according to the instructions on the screen to use the computer.



Do not allow the adapter to make contact with your skin for a long time. A low temperature burn may result.



After turning on the computer, if the HDMI message appears on the screen, press the Source button to change the screen modes (Monitor mode → PC mode).

## Turning the computer off

- 1 Select the Start button (■).
- 2 Select  → **Shut down**.

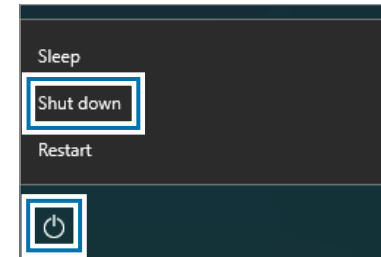

- Save all data before turning off the computer.
- Since the procedures to turn the computer off may differ depending on the installed operating system, turn the computer off according to the procedures for the purchased operating system.

## Unlocking the screen

To unlock the lock screen, do one of the following:

- **Mouse:** Click the lock screen.
- **Keyboard:** Press any key.

If the account has a password, enter the password to log in after unlocking the screen.

## Windows

Microsoft Windows is an operating system that is used to control a computer.



- Images and available features may differ depending on the model and operating system.
- This manual is designed for Windows 10 and content may differ depending on the OS version.
- The image displayed on the desktop screen may differ between models and OS versions.

## Help

To access help information, select the Start button (■) → **Get Started** (🔧).



You can check the help information after connecting to the Internet.

## Using the control panel

You can adjust basic system settings, such as hardware, software, or user account settings.

Select the Start button (☰) → **Windows System** → **Control Panel**. Alternatively, right-click the Start button (☰) and select **Control Panel**.

Then, select options you want to change.

## Using a multi desktop

Multi desktop allows you to work on various tasks at the same time via multiple desktops. You can use different desktops for various purposes.

### Creating a new desktop

- 1 Select [Task View] on the taskbar.

- 2 Select **New desktop**.

A new desktop will be added. You can select a desktop from the list displayed at the bottom of the screen.



### Deleting a desktop

- 1 Select [Task View] on the taskbar.
- 2 Move the cursor over the desktop icon you want to delete. Then, select **X** in the upper-right corner of the icon.

## Moving a program to another desktop

- 1 Select [□] on the taskbar.
- 2 Select a program or window you want to move.

## Action Center

The Windows 10 action center allows you to receive system notifications, such as updates, and push notifications, such as emails and SNS updates. You can also adjust settings conveniently. For example, you can select wireless network options or adjust the volume and screen brightness via hot keys in the action center.

## Checking notifications

- 1 Select [□] on the taskbar.

- 2 When the action center panel appears, select a message to check it.

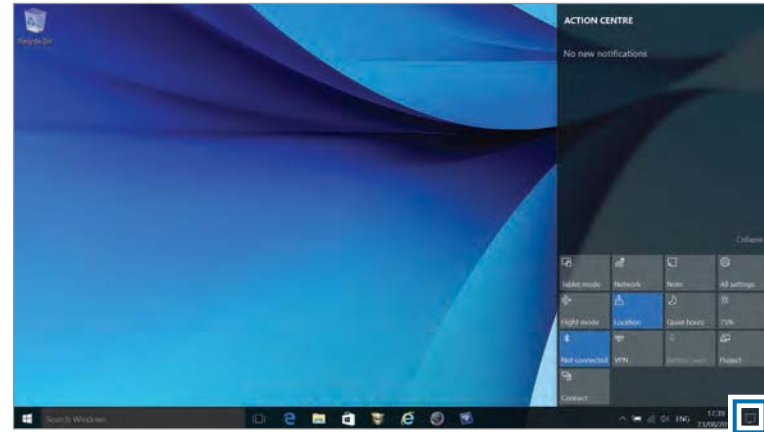

- You can enable or disable push notifications for applications. You can also set personalized hot keys to appear in the action center by selecting the Start button (■) → ⚙️ → **System** → **Notifications & actions**.
- Select **Expand** or **Collapse** to expand or minimize the action center menu and select the feature you want to use.



# Basics

## Wired keyboard/mouse (optional)

### Wired keyboard

Use the keyboard to enter characters and perform various functions.

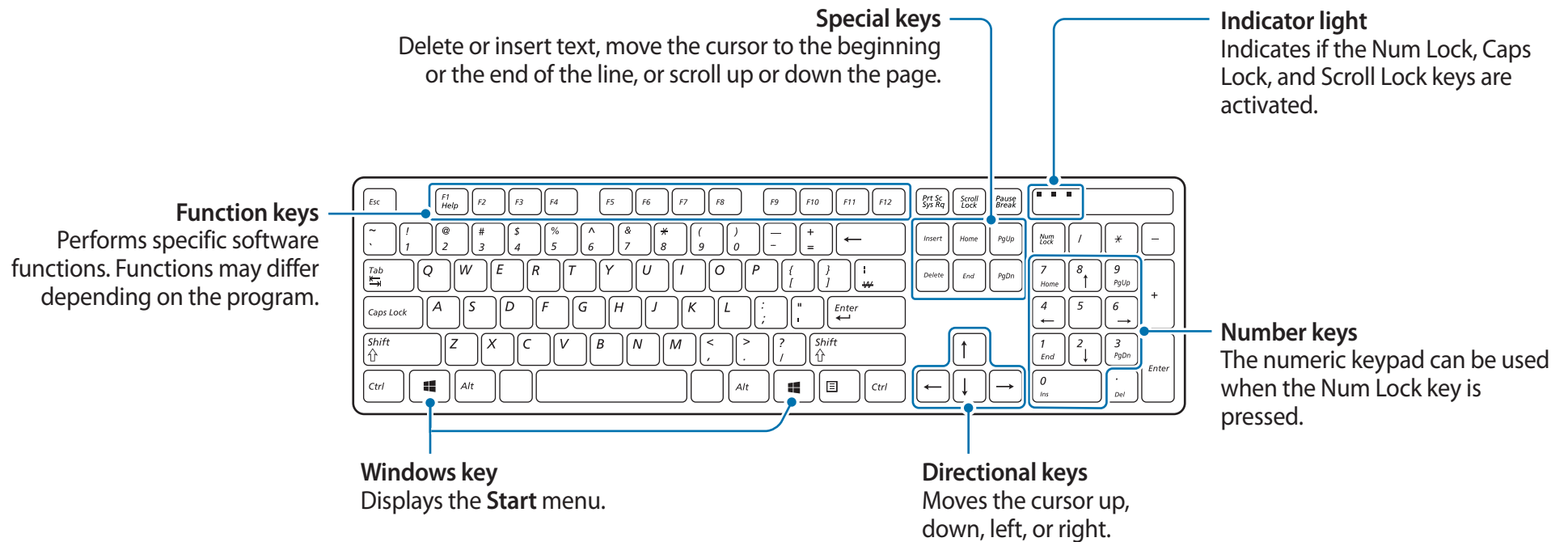

## Wired mouse

A mouse controls the cursor on the screen.

The appearance of the provided mouse may differ depending on the model.

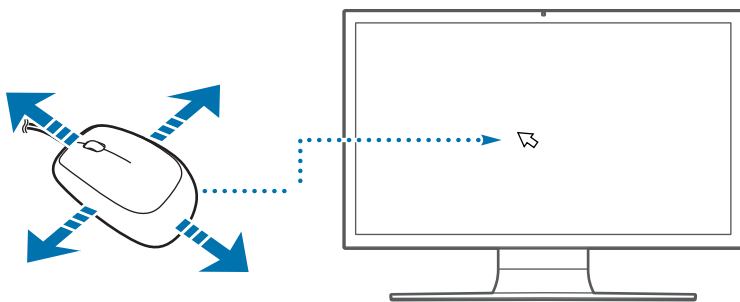
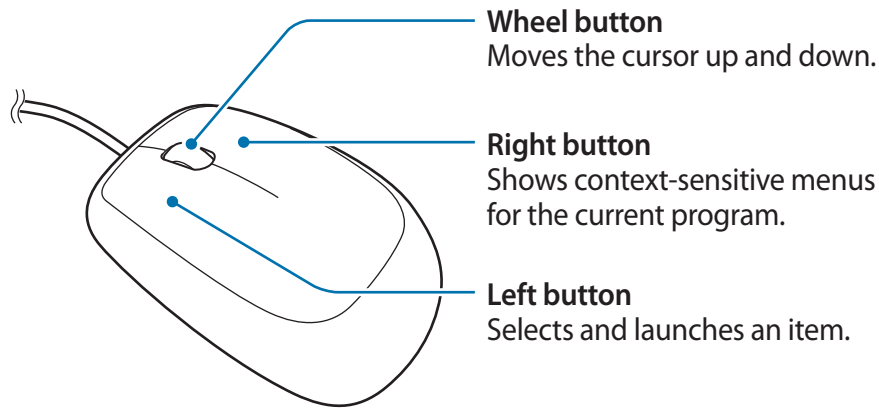

If you move the mouse, the cursor moves in the same direction on the screen.

## Clicking

Briefly press the left mouse button once.  
Click this button once to select an item.



## Double-clicking

Rapidly click the left mouse button twice.  
Double-click an item to launch it.

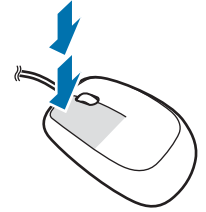

## Right-clicking

Click the right mouse button once to display the context-sensitive menu for the current program.

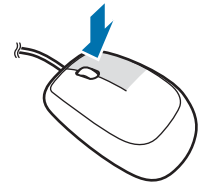

## Dragging

Use the mouse to position the cursor on an item to be moved. Then, click the left mouse button and move the item while the left mouse button is held down.

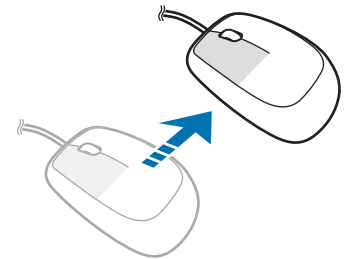

## Scrolling

Move the wheel in either direction to move through a screen in either direction when the page is larger than the computer screen.

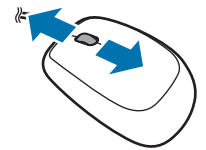

## Wireless keyboard/mouse (optional)

The wireless keyboard and mouse are optional and the appearance may differ depending on the model.

Some models may be supplied with a wired keyboard and mouse.

To use the wireless mouse and keyboard, first install the batteries and then install the wireless receiver.

### Installing the wireless receiver

- 1 Open the wireless mouse and keyboard's battery covers and insert the batteries. Make sure to insert the batteries with the positive (+) and negative (-) ends in the right direction, and remove the wireless receiver from the wireless keyboard.

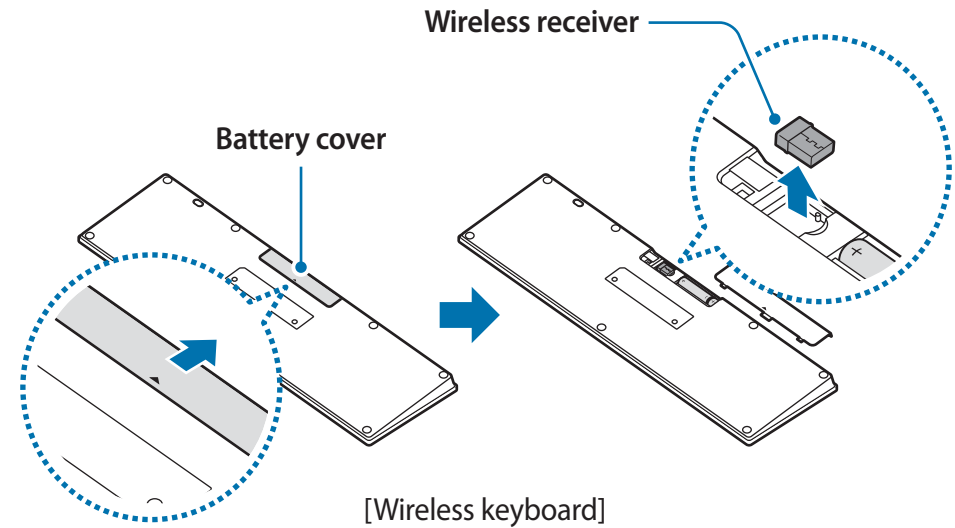
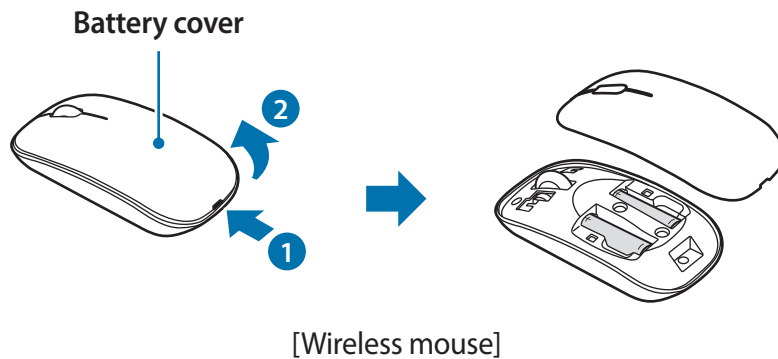

- Ensure the positive (+) and negative (-) ends of the batteries are positioned correctly.
- The AAA batteries supplied with the product cannot be recharged.

- 2 Connect the wireless receiver to a USB port (🖱️) at the back of the computer.

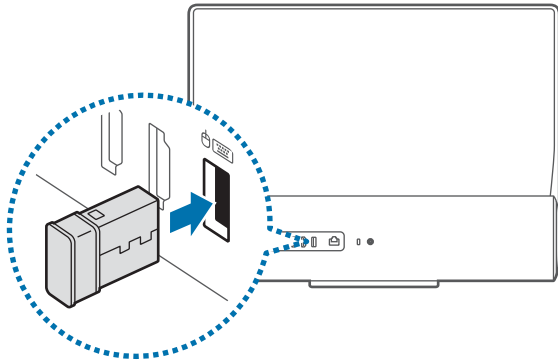

- 3 Move the switch at the bottom of the mouse to the ON position. You can now use your wireless keyboard and mouse.

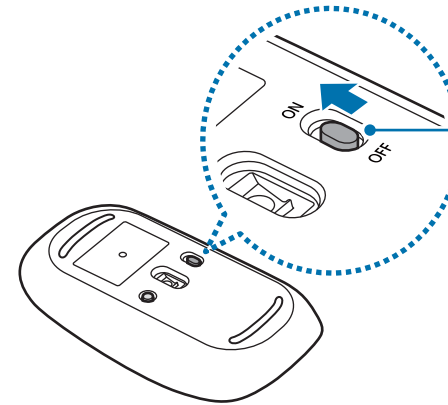

**Power switch**

Set the switch to the OFF position when the mouse is not in use to save the battery power.



- The wireless keyboard and wireless mouse can operate within 5 meters of the wireless signal sensor.
- The range is based on the operating environment. If there is electromagnetic interference present, such as that created by a Wi-Fi network AP, the range may decrease.

## Wireless keyboard

Use the keyboard to enter characters and perform various functions.



## Using the hot keys

Choose one of the following methods to use a hot key.

### ► Method 1

Press and hold the **Fn** key and then press a hot key.

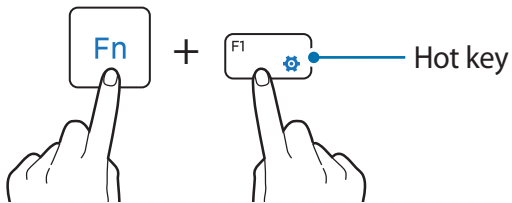







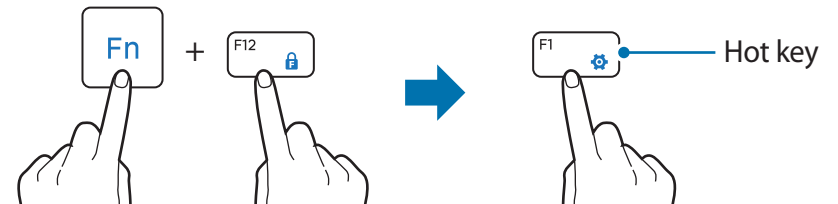

### ► Method 2





Press and hold the **Fn** key and press the **F12**.

When the Fn Lock LED turns on, press a hot key.



## Hot key functions

Key/Icon	Function	Description
F1 	Setup	The functions are based on Windows menus. The key will activate the function if it is supported by the operating system.
F2 	Search	
F3 	Calculator	
F4 	Power saving mode	
F5 	Play the previous file	Multimedia playback
F6 	Play/Pause	
F7 	Stop	
F8 	Play the next file	

Key/Icon	Function	Description
F9 	Mute	Toggle the sound on and off.
F10 	Volume control	Adjust the volume.
F11 		
F12 	Fn Lock	Press this key to make the <b>Fn</b> key function as if it is pressed.



The wireless keyboard automatically enters power saving mode if there is no key input for a preset period. When the keyboard is in power saving mode, press any key to start using it again. The wireless keyboard cannot be turned off.

## Wireless mouse

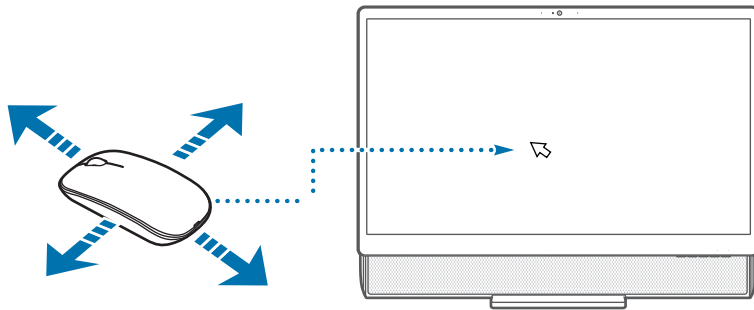
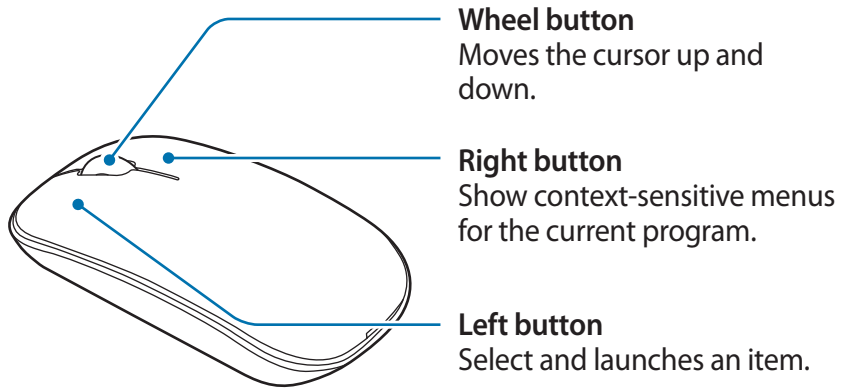

When you move the mouse, the cursor on the screen moves in the same direction.

### Clicking

Briefly press the left mouse button once.  
Click this button once to select an item.



### Double-clicking

Rapidly click the left mouse button twice.  
Double-click an item to launch it.

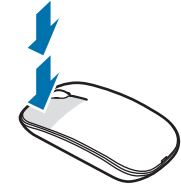

### Right-clicking

Click the right mouse button once to display the context-sensitive menu for the current program.



### Dragging

Use the mouse to position the cursor on an item to be moved. Then, click the left mouse button and move the item while the left mouse button is held down.

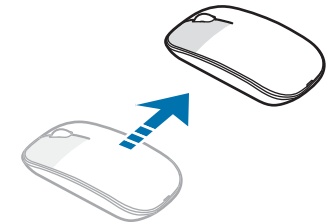

### Scrolling

Move the wheel in either direction to move through a screen in either direction when the page is larger than the computer screen.

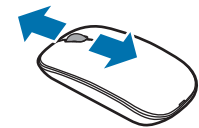

## If the wireless mouse does not work

- ▶ Ensure that the switch on the bottom side of the mouse is in the ON position.
  - ▶ Check the batteries.
  - ▶ Check the wireless receiver connection.
- 1 Slide the switch on the bottom side of the mouse to the OFF position.

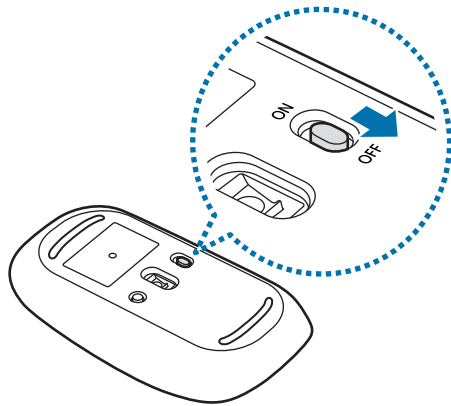

- 2 Disconnect the wireless receiver from the USB port and then reconnect it.

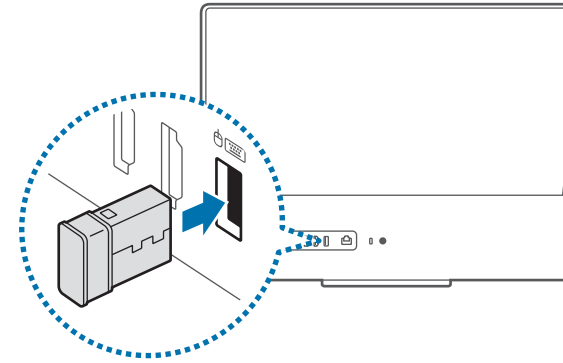

- 3 Return the switch on the mouse to the ON position.

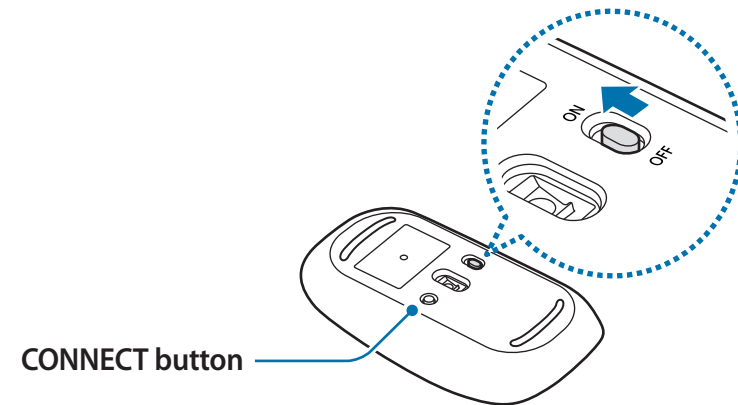



- 4 Immediately place the mouse near the receiver. Then, briefly press and hold the CONNECT button.
- 5 Check that the wireless mouse is operating properly.

## If the wireless keyboard does not work

- ▶ Check the batteries.
  - ▶ Check the wireless receiver connection.
- 1 Disconnect the wireless receiver from the USB port and then reconnect it.

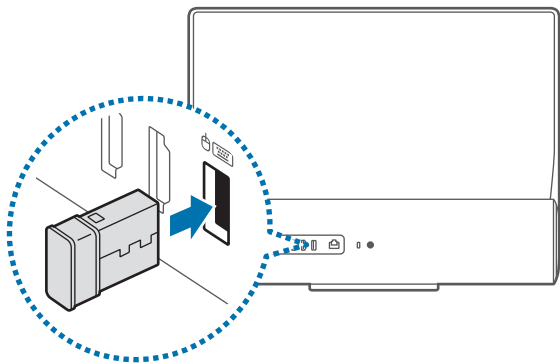

- 2 Immediately place the keyboard near the receiver. Then, briefly press and hold the CONNECT button.

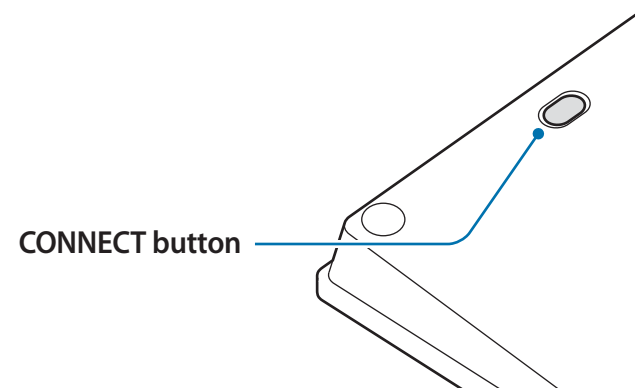

- 3 Check that the wireless keyboard is operating properly.

## Memory card

Use a memory card to transfer data to other devices, such as digital cameras or MP3 players. Memory cards are sold separately. Purchase a memory card with the necessary capacity for the requirement.

This computer supports the following types of memory cards.

Abbreviation	Description
SD	• Secure Digital
mini SD	• mini Secure Digital
micro SD	• micro Secure Digital
SDHC	• Secure Digital High Capacity
mini SDHC	• mini Secure Digital High Capacity
micro SDHC	• micro Secure Digital High Capacity
SDXC	• Secure Digital eXtended Capacity
micro SDXC	• micro Secure Digital eXtended Capacity

To use a mini or micro card, insert the card into an adapter before inserting it into the memory card slot.



- Some memory cards may not be fully compatible with the computer. Using an incompatible card may damage the computer or the memory card, or corrupt the data stored in it.
- Use caution to insert the memory card in the indicated direction.
- Store the card separately to prevent losing the card when moving the computer.
- Memory card speeds vary.

## Inserting a memory card

- 1 If a dummy card or a memory card adapter is inserted in the memory card slot, remove it.
- 2 Insert a memory card into the memory card slot in the indicated direction.

Use a memory card adapter to insert a micro memory card into the memory card slot. For mini memory cards, use a mini card adapter.



You can insert a micro memory card into the memory card adapter.

The memory card adapter is optional and must be purchased separately.

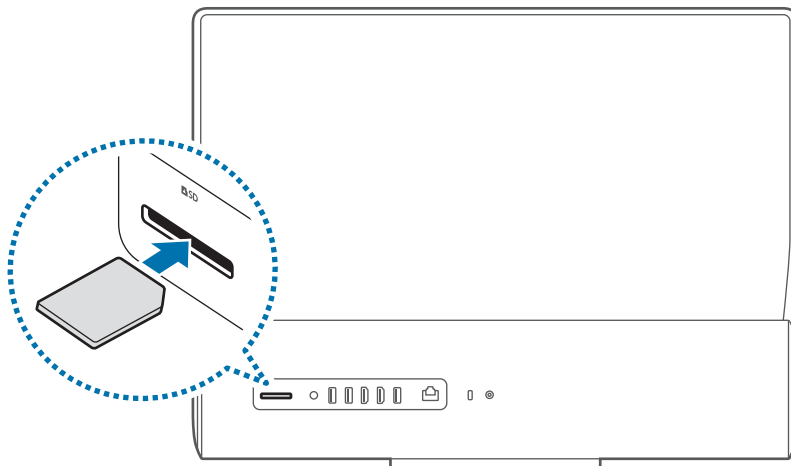

- 3 Select the pop-up message to open the memory card folder.  
If a pop-up message appears, select the corresponding window → **Continue without scanning**.
- 4 Select **Open folder to view files**.
- 5 Save, move, or delete data on the memory card.  
The memory card folder opens only on the desktop.

## Removing a memory card

Grasp the end of the card and pull it out of the slot.

## Formatting a memory card

Format the memory card to remove all data or before using it for the first time.



Formatting a memory card deletes all data saved on the card. If necessary, back up important data before formatting the card.

- 1 On the taskbar, select File Explorer (.
- 2 Right-click the memory card drive, and then select **Format**.
- 3 Select **Start**.



- To use a memory card to exchange data with a digital device, such as a digital camera, formatting the data with the digital device is recommended.
- When trying to use a formatted memory card in another digital device, format the memory card again in the device.
- Data protected by copyright laws cannot be reviewed or modified.
- Inserting and removing a memory card repeatedly may damage the memory card.
- Secure Digital Input Output (SDIO) is not supported.
- If the write-protect tab is in the locked position, you cannot format, write, or delete data on the card.

## External display

Connecting the computer to an external display device can be useful for presentations or when watching a movie. The cables required to connect an external display are sold separately. The computer supports HDMI cables.

### Connecting to a display

1 Connect the HDMI output port on the computer to the HDMI input port on the external display using an HDMI cable.



- This option is available on computers that have an HDMI output port only.
- If the computer is connected to an external display, change the external input mode on the external display to HDMI.

2 On the desktop screen, right-click the Start button (■) and select **Control Panel** → **Appearance and Personalization** → **Display** → **Change display settings** → **Multiple displays** → an option.

Select a mode.

<b>Duplicate these displays</b>	Show the screen on both the computer and the external display.
<b>Extend these displays</b>	Extend the screen to the external display.
<b>Show only on 1</b>	Show the screen on the computer monitor only.
<b>Show only on 2</b>	Show the screen on the external display only.



An external display is not supported when using the DOS Command Prompt window.

## Using the LCD as an external monitor (optional)

The computer's LCD can be used as an external monitor by using the Digital Video and Audio Input ports (HDMI-IN).

You can connect to HDMI-enabled devices, such as a computer, a gaming console, or a DVD player.

### Connecting the LCD as an external monitor

- 1 Use an HDMI cable to connect the external device's HDMI-OUT port and the computer's HDMI-IN port.

Press the Source button to switch to the Monitor mode.

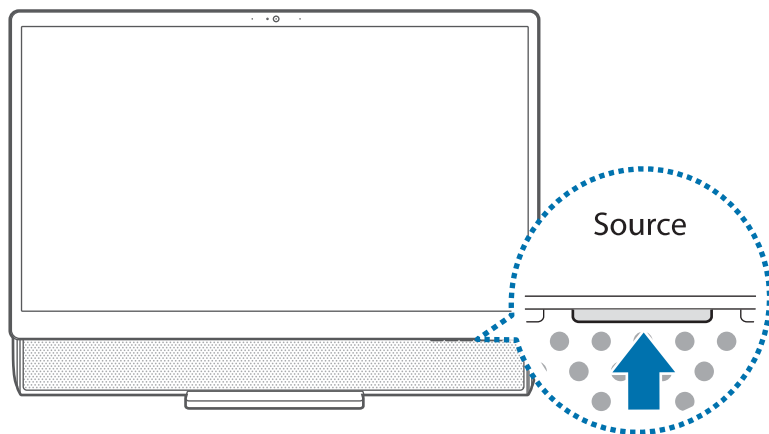

Monitor mode is only available when a source is detected at the HDMI-IN port.



- If the computer is turned off, the LCD can still be used as a monitor as long as the power adapter is connected to an electrical outlet.
- Even if the product is switched to Monitor mode by pressing the Source button during an operation, the operating system does not shut down. Press the Source button again to return to PC Mode.
- When the computer is in Monitor mode the external audio is also switched to the computer.
- If no video signal is displayed on the LCD in Monitor mode, disconnect and reconnect the HDMI cable.
- When the computer is in Power saving mode or its system turns off while in Monitor mode, press the LCD ON/OFF button to wake the computer.

### Using the screen in PC mode

To return to PC mode from Monitor mode, press the Source button.

## Playing music from a mobile device through the computer's speakers (optional)

Use the Bluetooth feature to play music stored on a mobile device, such as a smartphone or tablet, through the computer's speakers.

You can use the computer as a speaker by connecting a mobile device to the computer even if it is off.



- This feature is available with Bluetooth-enabled mobile devices only.
- Maintain the distance between the computer and the mobile device within the Bluetooth connection range.
- The layout of the screen and controls vary based on the device model and the software version.

## Connecting the computer to a mobile device using Bluetooth

If you connect the computer and the mobile device via Bluetooth for the first time, perform the following steps.

- 1 Press the Bluetooth button (ⓑ) on the computer to turn on the Bluetooth speaker.

After the alarm notifies you that the Bluetooth feature has been activated, the Bluetooth LED will blink and **Pairing** will be displayed on the computer screen.

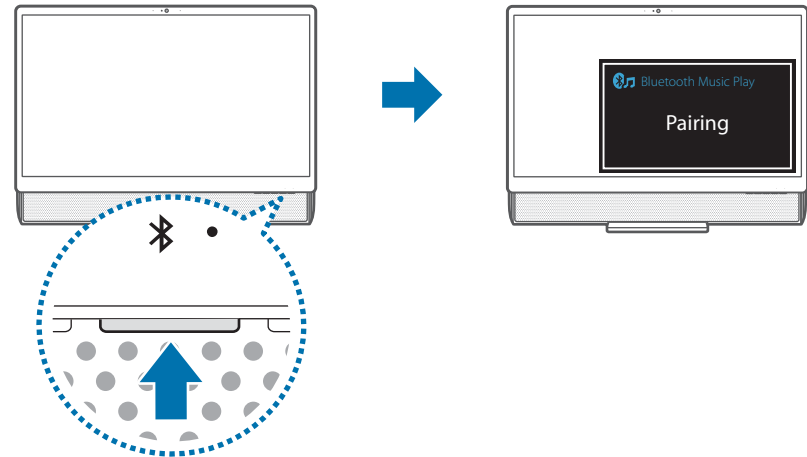



- Other devices, such as smartphones, can pair with the computer only when it is in Bluetooth pairing mode.
- After pairing, press and hold the Bluetooth button (⌘) for more than three seconds to reconnect the computer and the mobile device. **Pairing** will be displayed on the computer screen.

On the mobile device, activate the Bluetooth feature and tap **Bluetooth Music Play**. For more information, refer to your mobile device's manual.

On a Samsung smartphone, tap **Settings** → **Bluetooth**, and then tap the Bluetooth switch to activate it. Then, tap **Bluetooth Music Play**.

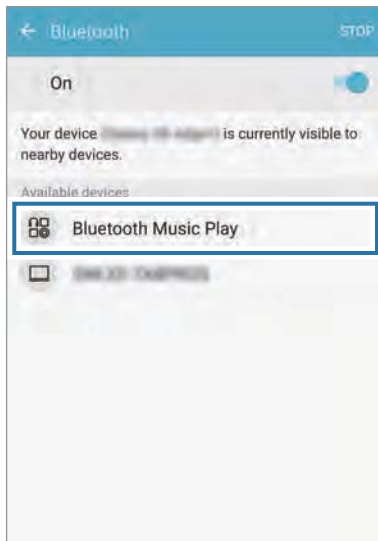

When the devices are paired, **Connected** is displayed on the computer screen.

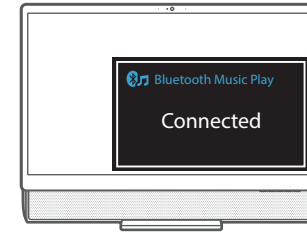

You can now select a music file stored on the mobile device and listen to it using the computer's speakers.



## Using the computer's speakers

If the computer and the mobile device have been connected previously, you can easily connect them again by pressing the Bluetooth button (⌘).

- 1 Press the Bluetooth button (⌘) on the computer. The Bluetooth LED turns on.

The computer's speakers turn on and **Ready** is displayed in the lower right corner of the computer screen.

- 2 Move the mobile device near to the computer to automatically connect the two devices.

When the devices are connected, **Connected** appears on the computer screen.

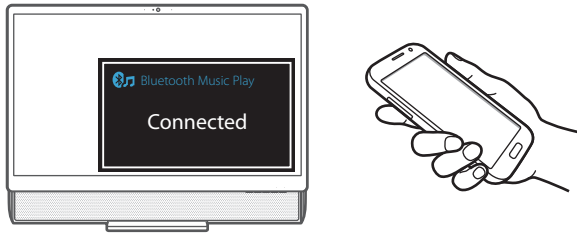

- 3 Select and play a song.

## Turning off the computer speakers

To turn off the speakers, press the Bluetooth button (⌘) on the computer.

The Bluetooth LED will turn off and **Off** will be displayed in the lower-right corner of the screen.



- If the speakers do not work properly, check the Bluetooth connection and try again. Refer to [Connecting the computer to a mobile device using Bluetooth](#) for more information.
- If the devices are no longer paired, position the mobile device near to the computer and try again.
- When music stored on the mobile device is playing through the computer's speakers, the volume is not controlled at the computer. To adjust the volume, use the volume controls on the mobile device.

## Wired LAN

To access the Internet at home, set up an account with an Internet service provider (ISP). To purchase Internet service and a modem, contact a local ISP.



- Some features or procedures may differ depending on the model.
- These descriptions are written for Windows 10, so some figures and descriptions may differ from your operating system. Since the procedures for other Windows operating systems are similar, use the computer referring to these descriptions.

## Wired LAN

- 1 Connect a LAN cable to the LAN port on the computer.

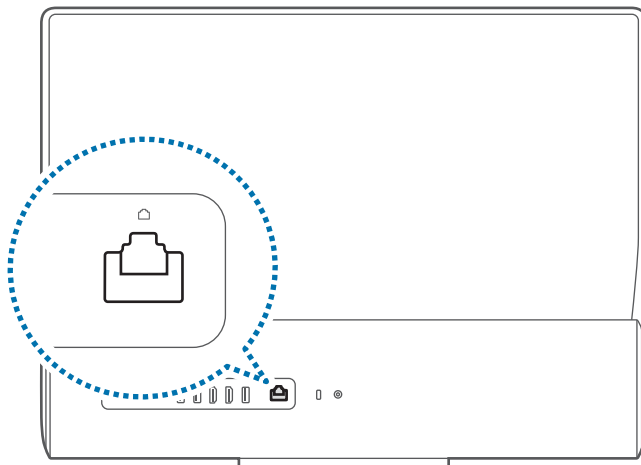

- 2 On the desktop, right-click the Start button (Windows logo) and select **Control Panel** → **Network and Internet** → **Network and Sharing Center** → **Change adapter settings**.

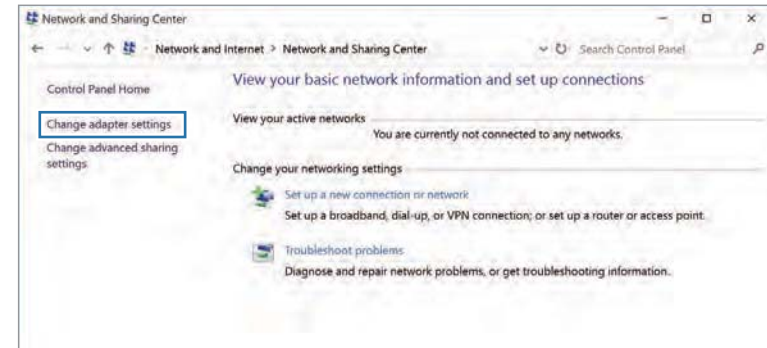

- 3 Right-click **Ethernet** and select **Properties**. The LAN device name may differ depending on the computer's network device.

4 Select **Internet Protocol Version 4 (TCP/IPv4)** from the list below **This connection uses the following items** → **Properties**.

- The Network Component name may differ depending on the operating system.

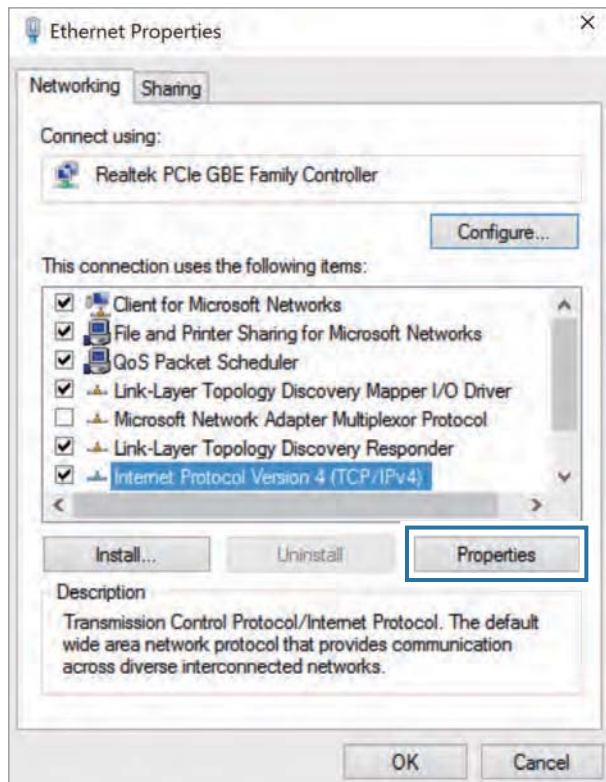

- To add a network item such as a client, service, or protocol, select **Install...** under the list of network items.

5 Configure the IP settings.

- When using DHCP, select **Obtain an IP address automatically**.
- When not using DHCP, contact the network administrator for the IP address. To use a static IP address, select **Use the following IP address** and set the IP address manually.

6 Select **OK** to save the settings.

## Wake on LAN (WOL) feature

Activate the system remotely from sleep mode when a signal, such as a magic packet command, is received via a wired LAN.

- 1 On the desktop, right-click the Start button (■) and select **Control Panel** → **Network and Internet** → **Network and Sharing Center** → **Change adapter settings**.
- 2 Right-click **Ethernet** and select **Properties**.
- 3 Select **Configure...** → **Power Management** → **Allow this device to wake the computer** → **OK**.

### 4 Restart the computer.

- If the computer wakes up from sleep mode inadvertently, disable the Wake on LAN feature.
- This feature may not work while using other power saving features. To disable other sleep functions, right-click the Start button (■) and select **Control Panel** → **Hardware and Sound** → **Power Options**.



When connected to a 100 Mbps/1 Gbps wired LAN, a message appears informing the user of connection to a 10 Mbps/100 Mbps wired LAN when the computer wakes from sleep mode. This happens because restoring the network takes about 3 seconds. When the network is restored, the computer will be connected to the 100 Mbps/1 Gbps LAN.

## Wireless LAN

Connect the computer to a wireless network to use the Internet.



The descriptions below are for computer models with a Wireless LAN card or device. A Wireless LAN device is optional. The pictures in this manual may differ from the actual product depending on the wireless LAN device model.

### About Access Point (AP)

An Access Point (AP) is a network device that bridges wired and wireless LANs and corresponds to a wireless hub in a wired network. Multiple devices can be connected to an AP.

### Connecting to a Wi-Fi network

- 1 On the taskbar, select .

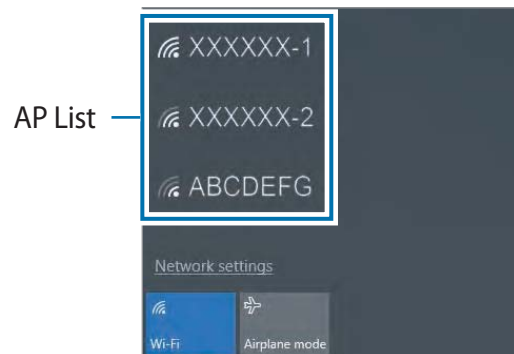

- 2 Select a network from the list of detected wireless networks and select **Connect automatically** → **Connect**.

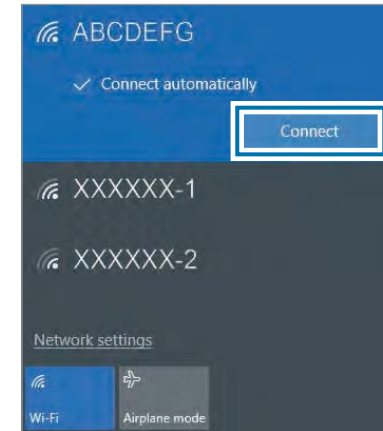

- 3 Enter a password, if necessary, and select **Next**.

Once the computer has been connected to a wireless network, it will attempt to connect to it automatically when it is available. If you require a network password, contact the system administrator.

## Using the Security slot

You can secure the computer by connecting a lock and cable to the Security slot.

Tie the lock and cable to a fixed object and install the other end of the cable to the Security slot.

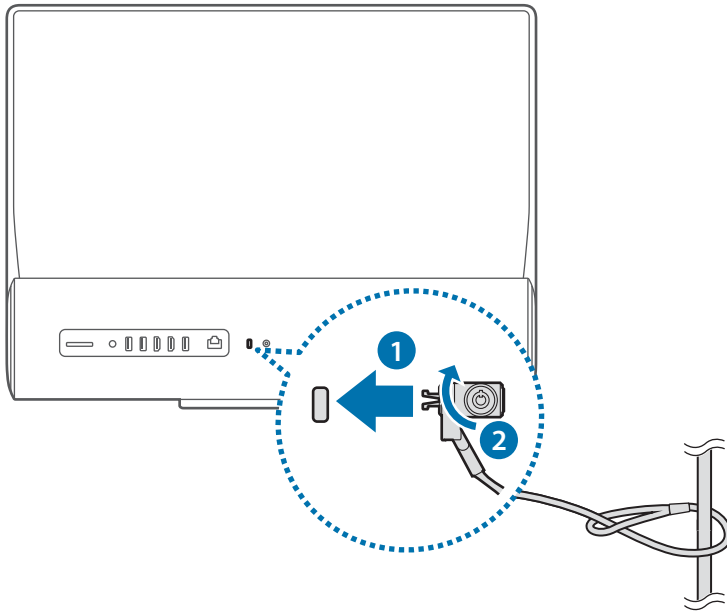

To use this feature, you must purchase a lock and cable (sold separately). Your product may differ from the one shown above. For more information, refer to your lock's manual.

# Applications

## Using applications



- Images and features may differ depending on the model and the application version.
- Some applications may not be supported depending on the model.
- Applications that are provided by Samsung can be installed from **Samsung Update**.
- **Third-party software related services**  
For descriptions about and service requests for third-party applications, please contact the relevant manufacturer. Some troubleshooting actions in response to service requests may not work depending on the application manufacturer.

# Samsung Settings

**Samsung Settings**, a Samsung-integrated settings application, offers various settings functions.



Images and features may differ depending on the model and the application version.

- 1 Select the Start button (■) → **Samsung** → **Samsung Settings**.
- 2 Select an option to configure the corresponding function.

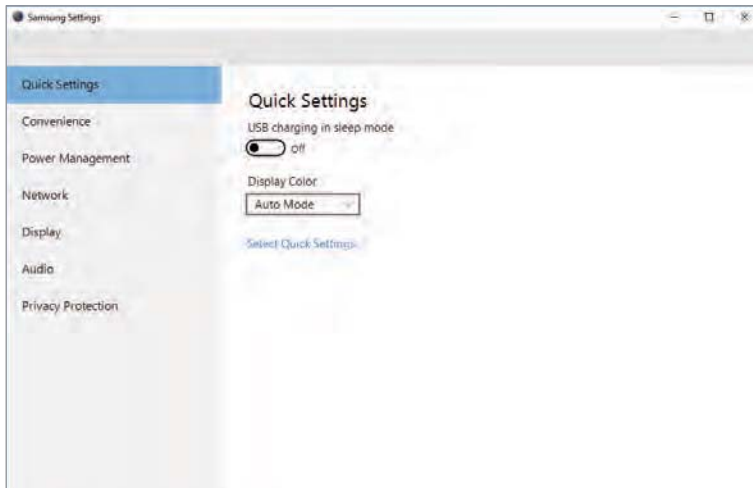

Menu	Description
Quick Settings	• Set quick settings.
Convenience	• Set system settings.
Power Management	• Set power-related settings.
Network	• Set network functions and settings.
Display	• Set the screen brightness and color.
Audio	• Set sound settings.
Privacy Protection	• Set security functions and settings.



## Samsung Update

Install and update Samsung applications and drivers on the computer easily and conveniently. This application enables the user to search for or download the BIOS, drivers, and applications over the Internet. Keep the computer performing better and more stably with **Samsung Update**.



- To check for available updates, the computer must be connected to the Internet.
- Only applications that have been installed with this application can be updated.
- Images and features may differ depending on the model and the application version.

1 Select the Start button (  ) → **Samsung** → **Samsung Update**.

2 Read and agree to the User Agreement.

This step appears only when the application runs for the first time.

3 Select **Install & Update**.

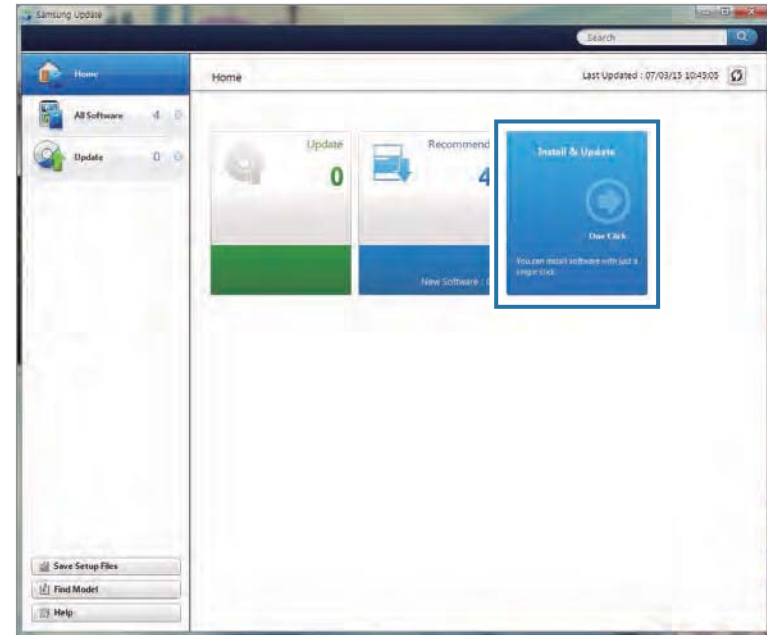



4 Select items to update and select **OK**.

## Online Support (S Service)

A service associate can resolve any problems you have with your computer using the online chat and remote control program. You can receive the help when you are having trouble using Samsung software.

You can access the online service for free for a certain period of time after purchasing your computer.



- **Online Support (S Service)** may not be offered or its version may be different depending on the model you are using.
- If **Online Support (S Service)** is not installed, select the Start button (  ) → **Store** (  ) and, search for **S Service** to download it.

1 Select the Start button (  ) → **Online Support (S Service)**.

2 Select **Online Support (S Service)** on the main page. Enter the **Contents** and select **Request**.

Online Support (S Service)

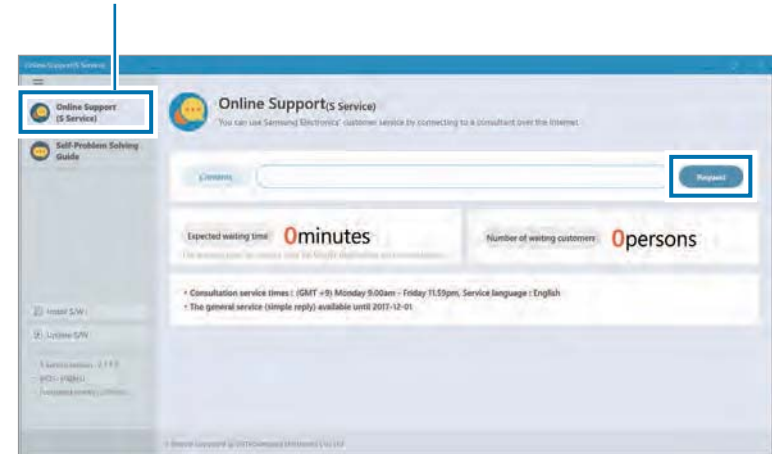

3 You can speak to a service associate to resolve your computer's problems.



Waiting times may vary depending on the network and number of waiting customers.

## Samsung PC Help (Self-help application)

Use **Samsung PC Help** to access help-related content for Samsung computers from a smartphone.

Watch the **Samsung PC Help** videos to become familiar with new functions or to find solutions to problems.



For more information, visit [www.samsungpchelp.com](http://www.samsungpchelp.com).

## Installing Samsung PC Help

- 1 On a smartphone, tap **Play Store** and search for **Samsung PC Help**.
- 2 Tap **INSTALL** → **ACCEPT** to complete the setup.

## Using Samsung PC Help

- 1 On a smartphone, tap **Samsung PC Help**.
- 2 On the **Samsung PC Help** main screen, select a menu to display the available content.



- You may incur additional charges when you access content.
- When you register your computer in the **Settings** menu, you can view its information on the Samsung PC Help app.

# Settings & Upgrade

## LCD brightness

Adjust the LCD brightness to reduce eye strain and save power.

- 1 Select the Start button (■) → **Samsung** → **Samsung Settings**.
- 2 Select **Display** → **Screen Brightness** and then adjust the level of brightness.

## Changing display mode

Select the optimal screen settings based on your activity.



Some options may not be available depending on the model.

- 1 Select the Start button (■) → **Samsung** → **Samsung Settings**.
- 2 Select **Display** → **Display Color**, and then select an option.
  - **Dynamic:** Makes scenes more vivid and clear.
  - **Standard:** Appropriate for normal environments and convenient for most situations.
  - **Photo Editing:** Appropriate for viewing photos.
  - **Reading:** Appropriate for reading documents.

## Volume

Adjust the system volume or sound volume when playing music or video.

### Controlling volume using the Volume control buttons

Press the  or  buttons to adjust the volume.

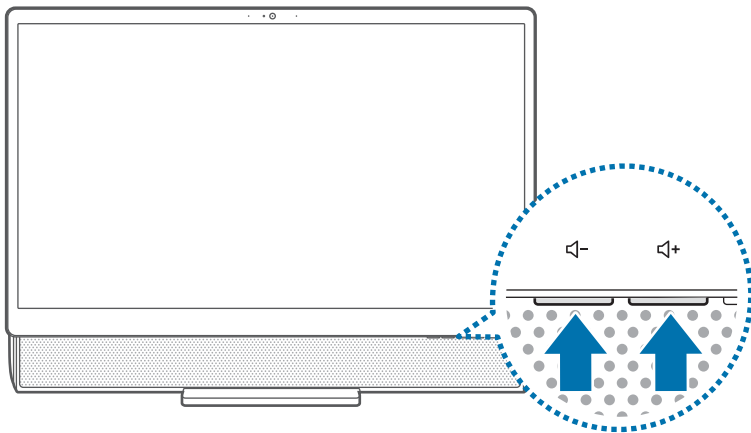

### Controlling volume using the taskbar

- 1 Select  on the taskbar.
- 2 Drag the adjustment bar to the desired volume.



Volume adjustment bar

## BIOS (Setup utility)

Define a boot password, change the boot priority, or configure the installed chipsets.



- Incorrect settings may cause the system to malfunction or crash.
- The BIOS setup screens, menus, and items may appear differently depending on the model and BIOS version.
- BIOS setup functions are subject to upgrades.

## Entering the BIOS screen

- 1 Turn on the computer.
- 2 Before the Samsung logo appears, press the **F2** key several times.
  - If the computer is password-protected, press the **F2** key several times before the password screen appears.
  - If the password screen or the Windows start screen appears, restart the computer and try again.

## The BIOS screen

The BIOS setup screen appears as shown below.

You can change BIOS settings using the keyboard or mouse.

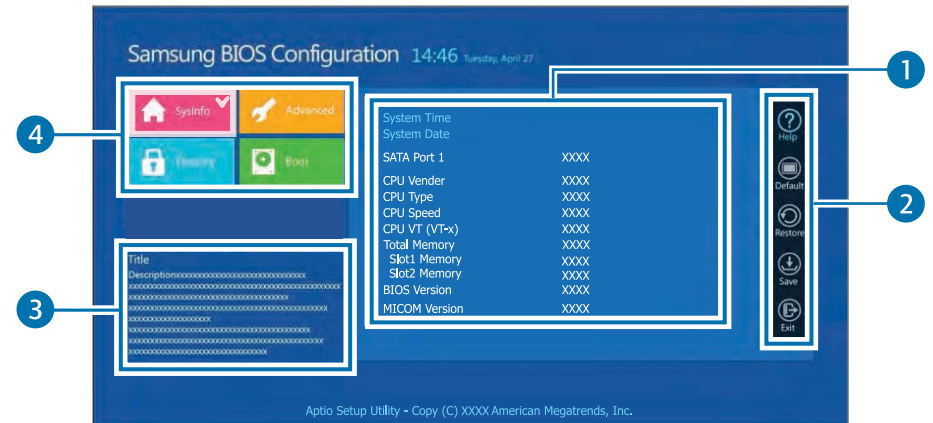

Number	Name
1	<ul style="list-style-type: none"> <li>• Setup items</li> </ul>
2	<ul style="list-style-type: none"> <li>• Setup tools <ul style="list-style-type: none"> <li>- <b>Help:</b> View the help for BIOS set up.</li> <li>- <b>Default:</b> Return to the default settings.</li> <li>- <b>Restore:</b> Cancel changes.</li> <li>- <b>Save:</b> Save settings.</li> <li>- <b>Exit:</b> Exit BIOS setup.</li> </ul> </li> </ul>
3	<ul style="list-style-type: none"> <li>• Help</li> </ul>
4	<ul style="list-style-type: none"> <li>• Setup menu <ul style="list-style-type: none"> <li>- <b>SysInfo:</b> View the basic specifications of the computer.</li> <li>- <b>Advanced:</b> Configure the chipsets and additional functions.</li> <li>- <b>Security:</b> Configure security functions.</li> <li>- <b>Boot:</b> Configure peripherals and boot-related settings.</li> </ul> </li> </ul>

## Boot password

Setting a password with the BIOS enhances protection against viruses and hacking attacks.



- Do not forget your password or expose it to others.
- If you forget the **Supervisor Password** or **HDD Password**, request assistance from the Samsung Service Center. In this case, a service fee will be charged.
- If you forget the **User Password**, disable the **Supervisor Password**, and the **User Password** is also automatically disabled.



The BIOS setup screen appears only in English.

## Setting passwords

There are three password settings available: **Supervisor Password**, **User Password**, and **HDD Password**.

- **Supervisor Password** (low security level): This password is required when turning on the computer or entering the BIOS setup.
- **User Password** (low security level): This password is required to enter the BIOS setup. This password will be deactivated automatically if the **Supervisor Password** is disabled.
- **HDD Password** (high security level): This password is required to access the hard disk drive (HDD) from another computer. This password may not be supported, depending on the model.

## Setting a boot password

- 1 Turn on the computer.
- 2 Before the Samsung logo appears, press the **F2** key several times.
- 3 Access the **Security** menu.
- 4 Select a password type (**Supervisor Password**, **User Password**, or **HDD Password**).

If you cannot select an item or the **HDD Password Frozen** message appears, turn off the computer and turn it on again. Then, press the **F2** key several times before the Samsung logo appears to enter the BIOS setup screen.



5 Enter a password and select **Ok**.

The password can be up to 20 characters.

6 Enter the password again to confirm it and select **Ok**.

7 Select **Save** → **Ok** to save and restart.



- To enable the **Password On Boot** option, set a **Supervisor Password** and enter the password when starting up the computer.
- To change the **HDD Password** after setting it, restart the computer.
- For some models, if the password entered message appears in the Setup Notice window, select **Ok** to complete the setup.

## Removing a password

1 Turn on the computer.

2 Before the Samsung logo appears, press the **F2** key several times.

3 Access the **Security** menu.

4 Select a password type (**Supervisor Password**, **User Password**, or **HDD Password**).

5 Enter the current password and select **Ok**.

6 Without entering any characters, select **Ok** → **Ok**.

7 Select **Save** → **Ok** to save and restart.



For some models, to cancel the password, select **Cancel** in the Setup Notice window.

## Boot priority

Change the boot priority from the BIOS setup.

- 1 Turn on the computer.
- 2 Before the Samsung logo appears, press the **F2** key several times.
- 3 Access the **Boot** menu.
- 4 Select **Boot Device Priority**.
- 5 Select an option menu to open the list.
- 6 Select an option.
- 7 Select **Save** → **Ok** to save and restart.  
Select **Exit** → **Ok** to restart without saving the changes.

# Troubleshooting

## Samsung Recovery

When a problem occurs with the computer, it is easy to restore the computer back to the factory default settings by using the **Samsung Recovery** application (Recovery/Backup). It is also possible to restore the computer to a previously backed up point. Back up important data regularly before a problem occurs with the computer.



- The **Samsung Recovery** application may not be provided in models with less than 64 GB of storage. If you cannot access the Samsung Recovery application, refer to [Windows recovery function](#).
- Some functions may differ or may be unavailable depending on the version. Refer to the application's help information.
- Run the **Samsung Recovery** application with administrator privileges.
- The **Samsung Recovery** application (Recovery/Backup) is not available when using CD/DVD drives.
- Recovering the computer erases the data or applications saved after a backup point. Therefore, back up important data regularly before a problem occurs with the computer.
- When you launch the application for the first time, read and accept the Terms and Conditions when they display on the screen.

## Recovering to factory default

You can restore the computer to its factory default settings. If necessary, back up important data to an external storage device before restoring the system. See [Backing up the current system](#).

**1 When the computer starts Windows:** Select the Start button (Windows logo) → Samsung → Samsung Recovery.

**When the computer does not start Windows:** Turn on the computer and press the **F4** key several times before the Samsung logo appears.

**2** Select **Backup Management** → **Factory image** → **Recover**.

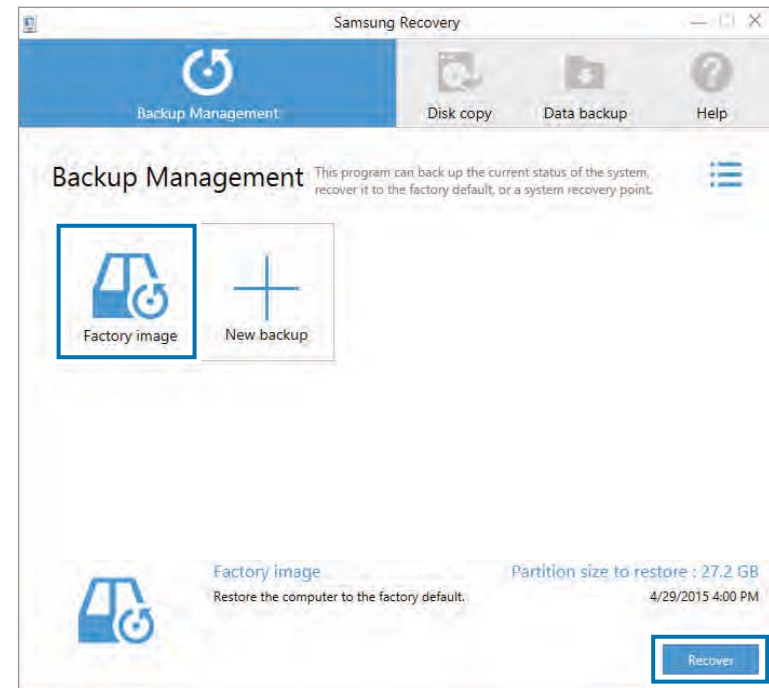

### 3 Select **Recover**.

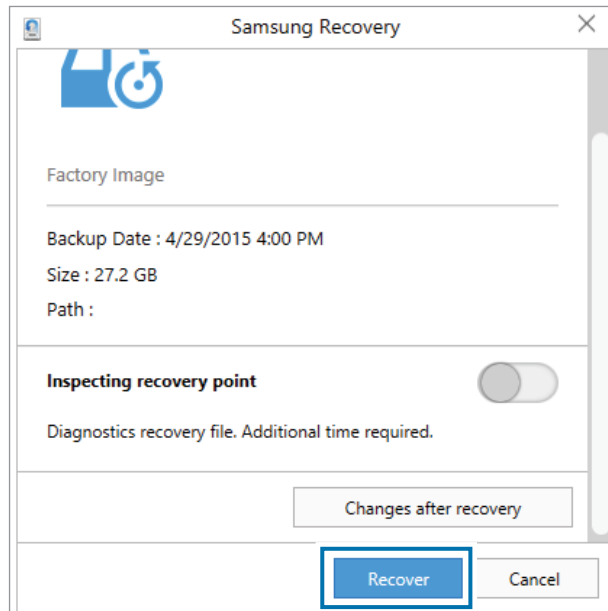

### 4 Follow the on-screen instructions to complete the recovery.

## Backing up the current system

Back up important data to an alternate internal drive or an external storage device regularly to prevent data loss.

### 1 Select **Backup Management** → **New backup**.

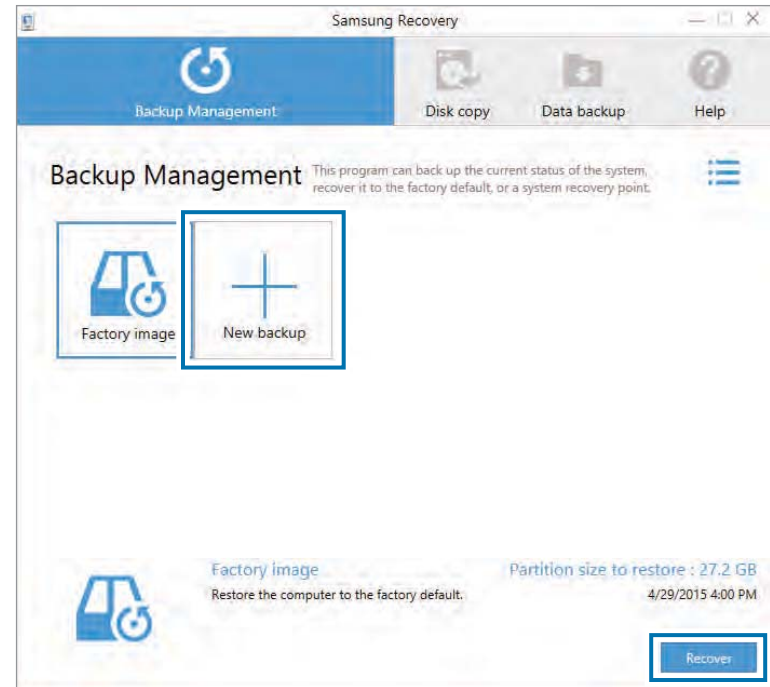

2 Select a drive from the drive list → **Backup**.

- When backing up to an external storage device, connect the device to the computer and then select the external drive.

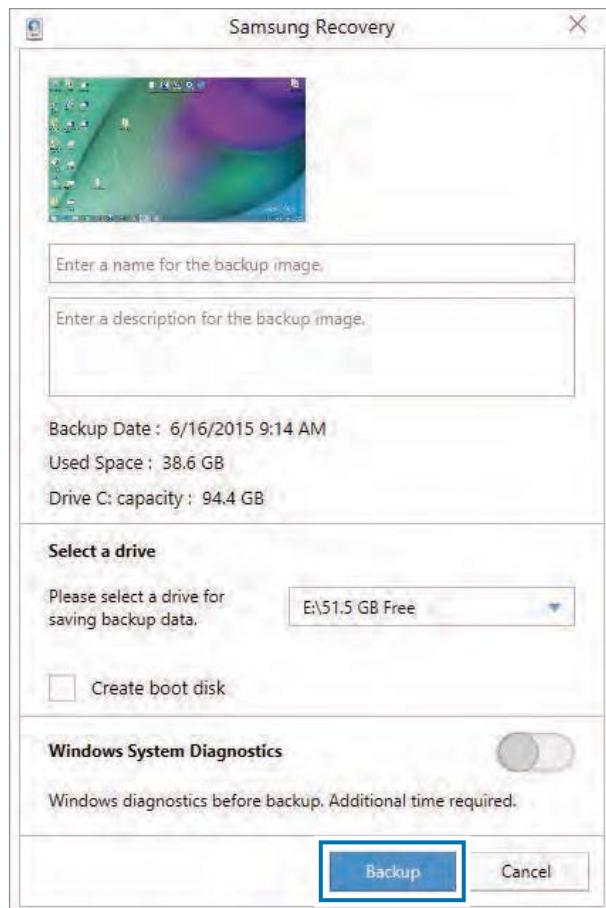

3 Follow the on-screen instructions to complete the backup.

## Recovering after a backup

Select a backup point saved on an alternate internal drive or an external storage device to recover the computer to that point.

- 1 When backing up to an external storage device, connect the device to the computer.
- 2 Select the Start button (■) → **Samsung** → **Samsung Recovery**.

3 Select **Backup Management** → a backup image → **Recover**.

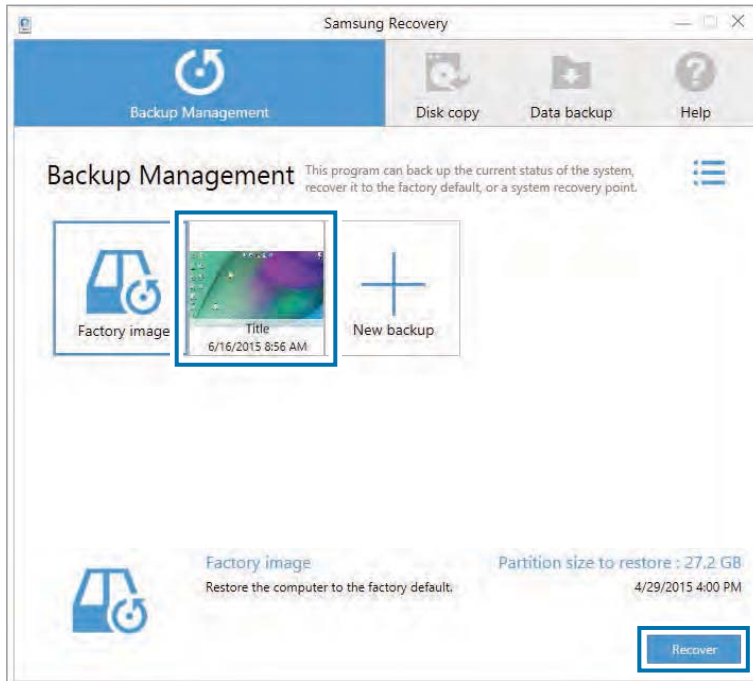

4 Follow the on-screen instructions to complete data recovery.

## Copying the drive (making a disk image)

To replace the drive, move the data to the new drive by making a disk image. The new drive must be large enough to hold the data from the current drive.

Purchase an external hard drive connector separately to connect the new drive to the computer.

- 1 Connect the new drive to the computer with an external hard drive connector.
- 2 Select the Start button (Windows logo) → **Samsung** → **Samsung Recovery**.
- 3 Select **Disk copy**.

4 Select a backup option → **Disk copy.**

The data on the disk is copied to the new disk.

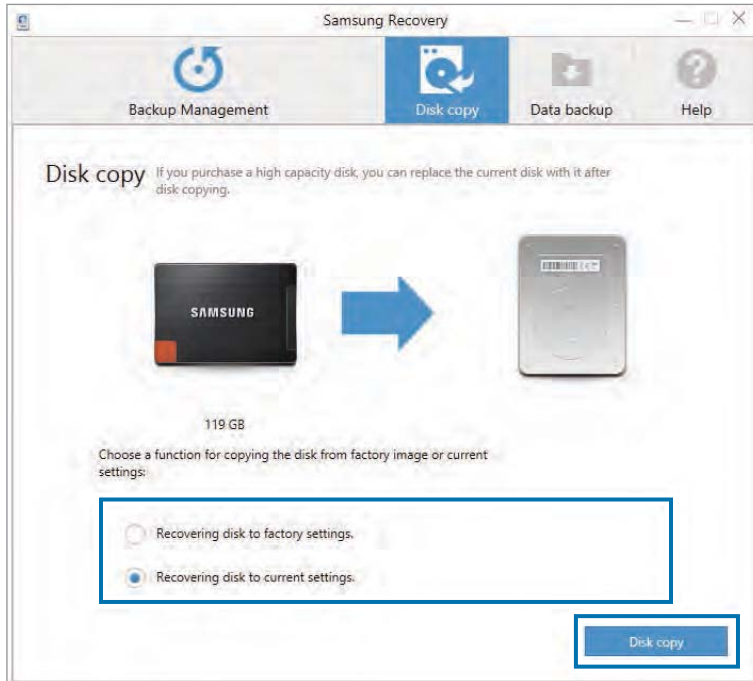



## Windows recovery function

If the **Samsung Recovery** application is not supported by the computer, reinstall Windows using the recovery function of Windows.



Reinstalling Windows will erase all data saved on the computer. Back up application and personal data to an external storage device before reinstalling Windows.

- 1 Select the Start button (🪟) → ⚙️ → **Update & security** → **Recovery**.
- 2 Select **Reset this PC** → **Get started**.
- 3 Select **Keep my files** or **Remove everything**.



After the system is recovered, select the Start button (🪟) → **Samsung** → **Samsung Update** to install the required Samsung applications.

## Q&A

When experiencing problems with the computer, try these solutions.

### Windows

#### How can I uninstall an application?

- 1 On the desktop, right-click the Start button (🪟) and select **Control Panel** → **Uninstall a program**.
- 2 On the list, right-click an application to delete, and then select **Uninstall**.

## How can I start my computer in DOS?

To start the computer in DOS via a USB device:

- 1 Turn on the computer.
- 2 Before the Samsung logo appears, press the **F2** key several times.
- 3 Select the **Boot** menu.
- 4 Select **Boot Device Priority**.
- 5 Select the USB device for **Boot Option #1**.
- 6 Set **Fast BIOS Mode** to **Off**.
- 7 Set **Secure Boot Control** to **Off**.
- 8 Set **OS Mode Selection** to **CSM OS**.
- 9 Select **Save** → **Ok** to save and restart.

## Samsung Recovery

### What is a Recovery area?

The computer has an additional partition for restoring data or saving backup files (only for models with the **Samsung Recovery** application). This partition is called a Recovery area and it includes a recovery image comprised of the operating system and applications.

## Why is the capacity representation of the hard disk drive (HDD) in Windows different from the product specifications?

The capacity of the storage device (HDD or SSD) of the manufacturer is calculated assuming that 1 KB = 1,000 Bytes. However, the operating system (Windows) calculates the storage device capacity assuming that 1 KB = 1,024 Bytes, and therefore the capacity representation of the HDD in Windows is smaller than the actual capacity. The capacity representation in Windows may be smaller than the actual capacity because some applications occupy a certain area of the HDD outside of Windows.

For models with the **Samsung Recovery** application, the HDD capacity representation in Windows may be smaller than the actual capacity because the **Samsung Recovery** application uses a hidden area of 5–20 GB of the HDD to save the recovery image, and that hidden area is not counted towards the total size available to Windows. The size of the **Samsung Recovery** application varies by model.

## What is a recovery image?

This refers to the operating system, drivers, and software that are converted to a data image. It is required to recover the computer and is embedded in the computer's HDD. However, this is not provided for storage devices where the capacity is less than 64 GB, due to their small capacities.

## How can I restore a computer that does not have the Samsung Recovery application?

Restore the computer with the recovery function provided by Windows. Refer to the Recover Functionality item in the help for more details.

# Appendix

## Product specifications

The system specifications may differ depending on the derived model. For detailed system specifications, refer to the product catalog.

Item	Specification
Operating environment	<ul style="list-style-type: none"><li>• Temperature: -5–40 °C for storage, 10–35 °C when operating</li><li>• Humidity: 5–90 % for storage, 20–80 % when operating</li></ul>
AC/DC rating	<ul style="list-style-type: none"><li>• Input: 100–240 VAC, 50–60 Hz</li><li>• Output: 19 VDC, 4.74 A</li></ul>
PC rating	<ul style="list-style-type: none"><li>• 19 VDC, 4.74 A (90 W)</li></ul>



- Optional components may not be provided or different components may be provided depending on the model.
- The system specifications are subject to change without notice.
- The Storage device capacity of a computer in which **Samsung Recovery** is installed, is smaller than the product specification.
- Due to this computer's design, memory cannot be added, replaced, or upgraded. Also, additional storage space cannot be added.
- The amount of memory that Windows can use may be smaller than the actual amount of memory available.

## Ergonomic tips

Maintaining the proper posture during computer use is very important to prevent physical injury. Improper or prolonged keyboard use may result in repetitive strain injury. Viewing the monitor screen for extended periods of time may result in eye strain. Therefore, please follow these guidelines carefully when setting up and using the computer.

### Back and neck

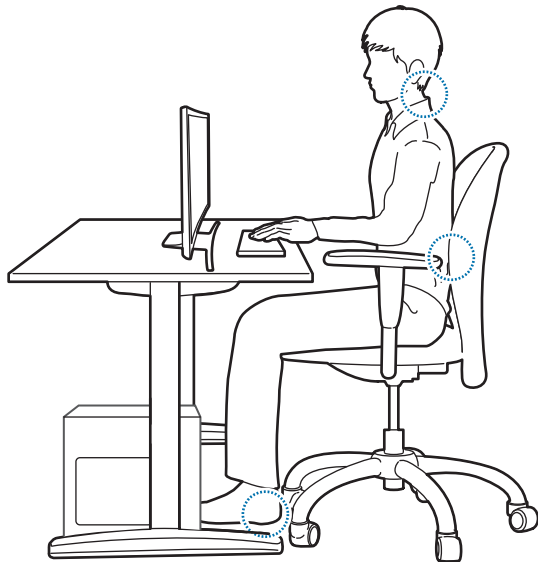

- Use an adjustable chair with firm, comfortable support.
- Adjust the height of your chair so that thighs are horizontal to the floor and feet are flat on the floor.
- The back of the chair should support the lower back. Adjust the backrest to fit your body properly.
- Sit back fully in your chair and straighten the back and neck. Avoid leaning forward or craning your neck toward the computer screen.
- Avoid using the computer while lying down or on your lap. If the computer's temperature increases, there is a danger of burn injury.



- The instructions in this manual have been prepared so that they can be applied to the range of needs of general users. If the user is not included in the range, the recommendations should be applied according to the user's needs.
- Images may differ from actual products.

## Arms and hands

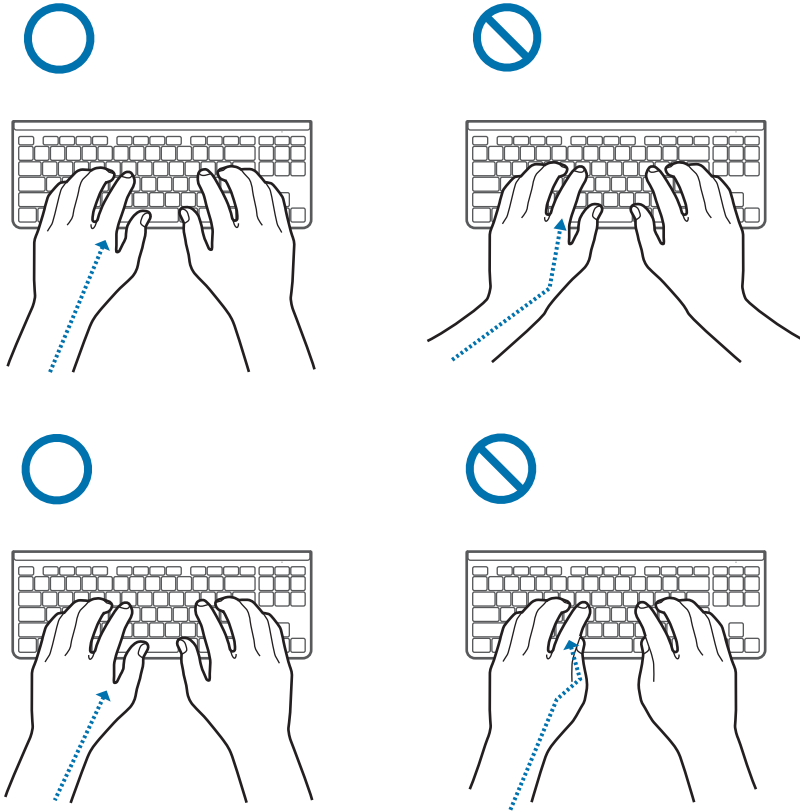

- When using the keyboard and touchpad, the shoulders should be relaxed. The upper arm and forearm should form an angle that is slightly greater than a right angle, with the wrist and hand in almost a straight line.
- Use a light touch when typing or using the touchpad and keep the hands and fingers relaxed. Avoid rolling the thumbs under your palms or supporting the wrists on the desk while typing.
- Use an external keyboard and mouse when using the computer for long periods. When using an external keyboard and mouse, position the devices at the same height as the computer and within comfortable reach.

## Eye position and display illumination

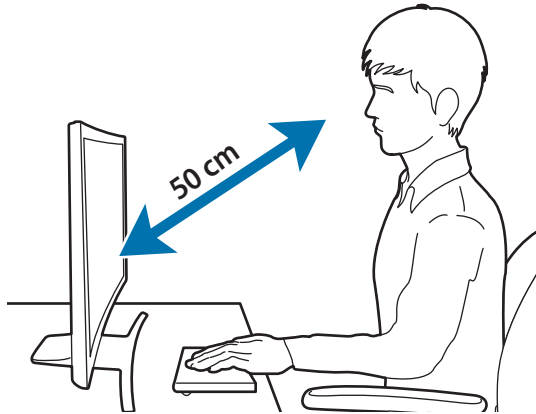

- Position the screen at least 50 cm away from your eyes.
- Adjust the height of the screen so that its top edge is equal to or just below the level of your eyes.
- Avoid setting the screen's brightness settings excessively high.
- Keep the screen clean.
- If wearing glasses, clean them before using the computer.
- When referring to printed content while typing, use a static paper holder to hold the paper at about the same height as the monitor.

## Hearing and volume control

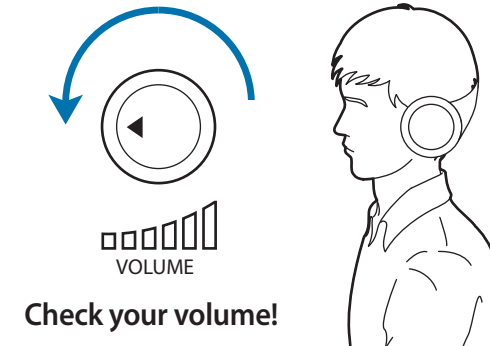

- Ensure that the volume is not too loud before using the headset or earpiece. Excessive exposure to loud sounds can cause hearing damage.
- Always turn the volume down before plugging the earphones into an audio source and use only the minimum volume setting necessary to hear your conversation or music.
- Avoid using headphones for long periods of time.
- Default audio settings can be changed by software and driver updates without your knowledge. Always recheck equalizer and volume settings before listening to audio.
- To prevent possible hearing damage, do not listen at high volume levels for long periods.



## Operating conditions

- Take at least a 10 minute break every hour.
- Avoid using the computer in dark locations. Use the computer with as much ambient light as you would when reading a book.
- Indirect illumination is recommended. Use a curtain to prevent reflections and glare on the screen.
- While operating a computer and talking on the phone, use a headset. Using the computer while holding a phone on your shoulder or with your neck may lead to muscle strain or injury.
- Keep frequently used items within reach.
- Only use the computer within the temperature and humidity ranges specified in this manual.

### Use caution when exposed to flashing lights.

- While using your computer, leave some lights on in the room and do not hold the screen too close to your eyes.
- Seizures or blackouts can occur when you are exposed to flashing lights while watching videos or playing Flash-based games for extended periods. If you feel any discomfort, stop using the computer immediately.

- If anyone related to you has experienced seizures or blackouts while using a similar product, consult a physician before using the computer.
- If you feel discomfort, such as a muscle spasm, or disoriented, stop using the computer immediately and consult a physician.
- To prevent eye strain, take frequent breaks while using the computer.

### Reduce the risk of repetitive motion injuries.

When you repetitively perform actions, such as pressing keys, drawing characters on a touch screen with your fingers, or playing games, you may experience occasional discomfort in your hands, neck, shoulders, or other parts of your body. When using your computer for extended periods, hold the computer with a relaxed grip, press the keys lightly, and take frequent breaks. If you continue to have discomfort during or after such use, stop using the computer and consult a physician.



## Safety precautions

For your safety and security and to prevent damage, carefully read the following safety instructions. This 'Safety precautions' relate to computer use. Some of the content may be not applicable to your computer.



- Since this is commonly applied to Samsung Computers, some pictures may differ from actual products.
- The product mentioned in this guide refers to all items supplied with the computer including the battery, the AC adapter, and all other Samsung-provided accessories.



### Warning

Failure to follow the instructions marked with this symbol may result in physical injury or fatality.

## Power related

### Handle the power cord with care.

- Do not touch with wet hands.
- Do not use a damaged power cord.
- Do not overload a multi-outlet or an extension cord beyond the specified voltage/current capacity.
- Firmly insert the power cable into the AC adapter.
- Do not unplug the power cord by pulling on the cable.
- Unplug the wall-mount AC adapter (integrated plug and power adapter) from the wall outlet while holding the body and pulling it in the direction of the arrow.

Failure to do so may result in electric shock or fire.

### Connect the power cord to the AC adapter firmly.

An improper connection may result in a fire.

### Use the approved adapter or cable included in the product box.

If you use the unapproved adapter or cable, it cause the damage or malfunction of the computer.

**Use only properly earthed electric sockets or extension cords.**

Unearthed electric sockets or extension cords may cause electric shock. Any connection to unearthed electric sockets or extension cords may produce an electric field from a current leak.

**If water or other substances enters the product, disconnect the power cable and contact a Samsung Service Center.**

Failure to do so may result in electric shock or fire due to the malfunction of the inner part.

**Do not let dust accumulate on the power cord or the electric socket. Regularly wipe the power cord and the electric socket with a dry cloth.**

Failure to do so may result in electric shock or fire.

**Do not bend or damage the power cable or the AC adapter with a heavy or sharp-edged object.**

A damaged cable or cord may result in electric shock or fire.

**Keep the battery, AC adapter, and the power cord away from infants, children, and pets.**

Failure to do so may result in electric shock or damage.

## **Battery usage related**

**Use manufacturer-approved batteries, chargers, accessories, and supplies.**

- Using generic batteries or chargers may shorten the life of your product or cause the computer to malfunction. They may also cause a fire or cause the battery to explode.
- Samsung cannot be responsible for the user's safety when using accessories or supplies that are not approved by Samsung.

**Take care not to allow metal objects such as a key or clip to touch the battery terminal (metal parts).**

This may cause excessive current and result in fire, burns, or damage to the battery.

**If the computer or the computer battery leaks, emits strange odors, or swells, immediately stop using the computer and contact a Samsung Service Center.**

Failure to do so may result in an explosion or fire.

**Replace a run-down battery with a new, Samsung-approved battery.**

**Dispose of worn-out batteries properly.**

- There is a danger of fire or explosion.
- The battery disposal method may differ depending on your country and region. Dispose of the used battery in an appropriate way.

**When removing the real time clock (RTC) battery, keep it away from infants and children.**

If a child swallows the battery, the child may suffocate. If this happens, immediately contact a doctor.

**Usage related**

**Do not use the computer on heated floors or electric pads, or on beds, blankets, or cushions that block the ventilation of the computer.**

A blocked vent causes the computer to overheat, resulting in an explosion, fire, burns, or computer malfunction.

**Do not use the computer in hot or humid locations, such as a bathroom, sauna, or inside a car during summer.**

Failure to do so may result in computer malfunction or electric shock.

The computer can be used in locations with an ambient temperature of 10 °C to 35 °C and a relative humidity of 20 % to 80 %RH.

**To avoid suffocation, keep the plastic bag away from infants and children.**

Putting a plastic bag over the head may result in suffocation.

**Never heat the computer (or the battery) or put the computer (or the battery) into a fire.**

Failure to do so may result in an explosion or fire.

**Before cleaning the computer, disconnect all the cables that are connected to the computer.**

Failure to do so may result in electric shock or fire.

**Keep the computer away from water or liquid.**

Water or liquid entering the computer may short-circuit the computer, resulting in electric shock or fire.

**If the computer is dropped or broken, disconnect the power cord and contact a Samsung Service Center.**

Using a broken computer may result in electric shock or fire.

**Do not touch the computer's surface or the vents for extended periods while the computer is on.**

Contact with the vent or the surface for extended periods may result in low-temperature burns, such as redness on the skin.

## **Caution**

Failure to follow instructions marked with this symbol may result in minor physical injury or damage to the computer.

### **Installation related**

**Do not block the ports (holes), vents, etc. of the product and do not insert objects.**

Damage to a component within the computer may cause electric shock or fire.

**When using the computer on its side, ensure the vents are clear and facing upwards.**

Failure to do so, may cause the internal temperature of the computer to rise and the computer to malfunction or halt.

**Keep the computer's vents at least 15 cm away from walls and other objects.**

Failure to do so may result in physical injury.

**Do not place or use the computer on slanted or vibrating surfaces.**

Failure to do so may result in computer malfunction or damage.

**Do not place heavy objects on the product.**

This may cause a problem with the computer. In addition, the object may fall and cause injury or damage the computer.

**Properly shut down, disconnect and secure the computer cables before moving it.**

Failure to do so may damage the computer or cause someone to trip over a loose cable.

### **Usage related**

**Do not use the pen for unintended purposes, such as poking the body like eyes or ears and do not put it in your mouth.**

Doing so may result in physical injury.

**Do not place a candle, light cigar, etc. over or on the product.**

There is a danger of fire.

**Make sure to have the product tested by a safety service engineer after repairing the product.**

Using a repaired product without testing it for safety may cause an electric shock or fire.

**In case of lightning, immediately turn the system off, disconnect the power cord from the wall outlet and phone line from modem.**

There is a danger of electric shock or fire.

**Connect only permitted devices to the connectors or ports of the computer.**

Failure to do so may result in an electric shock or fire.

**Do not press the eject button while the CD-ROM drive is in operation.**

You might lose data and the disc might be suddenly ejected and could cause an injury.

**Do not drop or hit the computer against anything.**

Failure to do so may result in physical injury or computer malfunction.

**Do not allow the antenna and a source of electricity, such as a socket outlet, to come into contact.**

There is a danger of electric shock.

**When handling computer parts, follow the instructions on the manual supplied with the parts.**

Failure to do so may result in damage to the product.

**If the product emits smoke or there is a burning smell, disconnect the power plug from the wall outlet and contact a Samsung Service Center immediately.**

There is a danger of fire.

**Do not use damaged or illegally modified CDs.**

There is a danger of damaging the product or personal injury.

**Do not insert the fingers into the ports (holes), card slot, or vents.**

There is a danger of injury or electric shock.

**Use recommended computer cleansing solutions when cleaning the product and only use the computer when it is completely dry.**

Failure to do so may result in electric shock or fire.

**You should not use a paper clip to perform an emergency disc ejection while the disc is in motion. Make sure to use the emergency disc eject method only when the Optical Disc Drive has stopped.**

There is a danger of injury.

**Do not place your face close to the Optical Disc Drive tray when it is operating.**

There is a danger of injury due to an abrupt ejection.

**Do not use the product if it is cracked or broken.**

Broken glass or acrylic could cause injury to your hands and face. Take the device to a Samsung Service Center to have it repaired.

**When using wireless communication (LAN, Bluetooth, etc.) always follow applicable instructions. For example, airlines and hospitals have strict requirements.**

**Avoid exposing a drive to magnetic fields. Security devices with magnetic fields include airport walk-through devices and security wands. The airport security devices that check carry-on luggage, such as conveyor belts, use X-rays instead of magnetism and will not damage a drive.**

**Keep the computer away from magnetic material.**

- Magnetic materials may cause computer malfunction.
- To avoid damaging the computer or magnetic stripe cards, such as credit cards, keep magnetic stripe cards away from the computer.

**Do not use your computer in a hospital or on an aircraft that can be interfered with by radio frequency.**

- Avoid using your computer within a 15 cm range of a pacemaker, if possible, as your computer can interfere with the pacemaker.
- To minimize possible interference with a pacemaker, use your computer only on the side of your body that is opposite the pacemaker.
- If you use medical equipment, contact the equipment manufacturer before using your computer to determine whether or not the equipment will be affected by radio frequencies emitted by the computer.
- When in a hospital, turn off your computer and follow all hospital regulations. Radio frequencies emitted from the computer may affect medical equipment.

## Upgrade Related

**Do not attempt to upgrade the computer, unless you are qualified. Otherwise, contact a Samsung Service Center or an authorized technician.**

**Follow the specified instructions contained in the manual for user maintenance. Do not disassemble any other parts by yourself.**

Failure to do so may result in computer malfunction, electric shock, or fire.

**Take care when touching the product or parts.**

The computer may be damaged or you may be injured.

**Do not disassemble the power supply unit in any circumstances.**

Failure to do so may result in electric shock, fire, or an explosion.

**Shut down the computer and disconnect all cables before disassembling the computer.**

Failure to do so may cause electric shock.

**Make sure to close the computer cover before connecting the power after a reassembly.**

There is a danger of electric shock if your body touches an internal part.

**Never disassemble or repair the product by yourself.**

There is a danger of accident. Use authorized Samsung Service Center.

**To connect a device that is not manufactured or authorized by Samsung, enquire at a Samsung Service Center before connecting the device.**

There is a danger of damaging the product.

## Storage and movement related

**Do not operate or look at the computer while driving a vehicle.**

There is a danger of a traffic accident. Please concentrate on driving.

## **Cautions on preventing data loss (hard disk management)**

**Take care not to damage the data on a storage device.**

- Subjecting the device to physical impacts may result in data loss.
- The data may be lost when the computer is turned off or reset by a power failure while the storage device is operating.
- The data may be lost and irrecoverable due to a computer virus.
- The data may be lost if the power is turned off while running an application.
- Samsung is not liable for any loss of data on the storage device.

**To prevent data loss due to damage to the hard disk drive, please back up the data frequently.**

## **LCD bad pixels**

**Samsung observes strict specifications regarding the quality and reliability of the LCD. However, there is a small chance that a few pixels may be bad. A large number of bad pixels can cause problems with the display, but a small number of bad pixels does not generally affect computer performance.**

Samsung's quality standards for bad pixels are as follows:

- **Bright dot:** 2 or fewer
- **Black dot:** 4 or fewer
- **Combination (bright and dark):** 4 or fewer

**Clean the LCD screen with a soft cloth dampened with computer cleansing detergent.**

Do not use excessive force. Doing so may damage the LCD screen.



## Important safety information

### Safety instructions

The system is designed and tested to meet the latest standards for safety of information technology equipment. However, to ensure safe use of this product, it is important that the safety instructions marked on the product and in the documentation are followed.



Always follow these instructions to help guard against personal injury and damage to the system.

### Setting up the system

- Read and follow all instructions marked on the product and in the documentation before operating the system. Retain all safety and operating instructions for future use.
- Do not use this product near water or a heat source such as a radiator.
- Set up the system on a stable work surface.
- The product should be operated only with the type of power source indicated on the rating label.
- Ensure that the electrical outlet to power the equipment is easily accessible in case of fire or short circuit.
- If the computer has a voltage selector switch, make sure that the switch is in the proper position for your area.
- Openings in the computer case are provided for ventilation. Do not block or cover these openings. Make sure you provide adequate space, at least 6 inches (15 cm), around the system for ventilation when setting up your work area. Never insert objects of any kind into the computer ventilation openings.

- Ensure that the fan vents on the bottom of the casing are clear at all times. Do not place the computer on a soft surface, doing so will block the bottom vents.
- When using an extension cord with this system, make sure that the total power rating on the products plugged into the extension cord does not exceed the extension cord power rating.
- For Notebooks with glossy display bezels the user should consider the placement of the Notebook as the bezel may cause reflections from surrounding light and bright surfaces.

### Care during use

- Do not walk on the power cord or allow anything to rest on it.
- Do not spill anything on the computer or its components. The best way to avoid spills is to not eat or drink near the computer or its components.
- Some products have a replaceable CMOS battery on the system board. There is a danger of explosion if the CMOS battery is replaced incorrectly. Replace the battery with the same or equivalent type recommended by the manufacturer. Dispose of batteries according to the manufacturers instructions. If the CMOS battery requires replacement ensure that a qualified technician performs the task.
- When the computer is turned off, a small amount of electrical current still flows through the computer.  
To avoid electrical shock, always unplug all power cables, remove the battery and modem cables from the wall outlets before cleaning the system.

- Unplug the system from the wall outlet and contact a Samsung Service Center if:
  - The power cord or plug is damaged.
  - Liquid has been spilled into the computer.
  - The computer does not operate properly when the operating instructions are followed.
  - The computer was dropped or the casing is damaged.
  - The computer performance changes.

## Operating instructions

- 1 When installing and operating devices please refer to safety requirements in the user manual.
- 2 Devices can be used only with the equipment specified in the technical specifications of the devices.
- 3 If any smell of burning or smoke is detected from the computer the unit should be switched off and the battery removed. The unit should be checked by a qualified technician before reuse.
- 4 Service and repair of devices should be carried out by authorized service centers.
- 5 Do not allow the portable computer to operate with the base resting directly on exposed skin for extended periods of time. The surface temperature of the base will rise during normal operation (particularly when AC Power is present). Allowing sustained contact with exposed skin can cause discomfort or eventually a burn.

## Replacement parts and accessories

Use only replacement parts and accessories recommended by manufacturer.

 To reduce the risk of fire, use only No. 26 AWG or larger telecommunications line cord.

 Do not use this product in areas classified as hazardous. Such areas include patient care areas of medical and dental facilities, oxygen rich environments, or industrial areas.

## Battery disposal

 Do not put rechargeable batteries or products powered by non-removable rechargeable batteries in the garbage.

Contact the Samsung Service Center for information on how to dispose of batteries that you cannot use or recharge any longer. Follow all local regulations when disposing of old batteries.

 THERE IS RISK OF EXPLOSION IF BATTERY IS REPLACED BY AN INCORRECT TYPE.  
DISPOSE OF USED BATTERIES ACCORDING TO THE INSTRUCTIONS.

## Laser safety

All systems equipped with CD or DVD drives comply with the appropriate safety standards, including IEC 60825-1. The laser devices in these components are classified as “Class 1 Laser Products” under a US Department of Health and Human Services (DHHS) Radiation Performance Standard. Should the unit ever need servicing, contact an authorized service location.



- **Laser Safety Note:** Use of controls or adjustments or performance of procedures other than those specified in this manual may result in hazardous radiation exposure. To prevent exposure to laser beams, do not try to open the enclosure of a CD or DVD drive.
- Class 1M laser radiation when operating part is open. Do not view directly with optical instruments.
- Class 3B invisible laser radiation when open. Avoid exposure to the beam.

## Connect and disconnect the AC adapter

The socket-outlet shall be installed near the equipment and shall be easily accessible.

**Do not unplug the power cord by pulling the cable only.**

## Power cord requirements

The power cord set (all plug, cable and AC adapter plug) you received with your computer meets the requirements for use in the country where you purchased your equipment.

Power cord sets for use in other countries must meet the requirements of the country where you use the computer. For more information on power cord set requirements, contact your authorized dealer, reseller, or service provider.

## General requirements

The requirements listed below are applicable to all countries:

- All power cord sets must be approved by an acceptable accredited agency responsible for evaluation in the country where the power cord set will be used.
- The power cord set must have a minimum current capacity of 7A and a nominal voltage rating of 125 or 250 volts AC, as required by each country's power system (USA only).
- The appliance coupler must meet the mechanical configuration of an EN 60 320/IEC 320 Standard Sheet C7 (or C5) connector, for mating with appliance inlet on the computer.

## Regulatory compliance statements

### Wireless guidance

(If fitted with 2.4 G band or 5 G band)

Low power, Radio LAN type devices (radio frequency (RF) wireless communication devices), operating in the 2.4 GHz/5 GHz Band, may be present (embedded) in the notebook system. The following section is a general overview of considerations while operating a wireless device.

Additional limitations, cautions, and concerns for specific countries are listed in the specific country sections (or country group sections). The wireless devices in the system are only qualified for use in the countries identified by the Radio Approval Marks on the system rating label. If the country you will be using the wireless device in, is not listed, please contact your local Radio Approval agency for requirements. Wireless devices are closely regulated and use may not be allowed.

The RF field strength of the wireless device or devices that may be embedded in the notebook are well below all international RF exposure limits as known at this time. Because the wireless devices (which may be embedded into the notebook) emit less energy than is allowed in radio frequency safety standards and recommendations, manufacturer believes these devices are safe for use. Regardless of the power levels, care should be taken to minimize human contact during normal operation.

Some circumstances require restrictions on wireless devices.

Examples of common restrictions are listed on the next page:



- Radio frequency wireless communication can interfere with equipment on commercial aircraft. Current aviation regulations require wireless devices to be turned off while traveling in an airplane.

802.11ABGN (also known as wireless Ethernet or Wi-Fi) and Bluetooth communication devices are examples of devices that provide wireless communication.

- In environments where the risk of interference to other devices or services is harmful or perceived as harmful, the option to use a wireless device may be restricted or eliminated. Airports, Hospitals, and Oxygen or flammable gas laden atmospheres are limited examples where use of wireless devices may be restricted or eliminated. When in environments where you are uncertain of the sanction to use wireless devices, ask the applicable authority for authorization prior to use or turning on the wireless device.

- Every country has different restrictions on the use of wireless devices. Since your system is equipped with a wireless device, when traveling between countries with your system, check with the local Radio Approval authorities prior to any move or trip for any restrictions on the use of a wireless device in the destination country.
- If the system came equipped with an internal embedded wireless device, do not operate the wireless device unless all covers and shields are in place and the system is fully assembled.
- Wireless devices are not user serviceable. Do not modify them in any way. Modification to a wireless device will void the authorization to use it. Please contact the manufacturer for service.
- Only use drivers approved for country in which the device will be used. See the manufacturer System Restoration Kit, or contact the manufacturer's technical support for additional information.



## United States of America

### USA and Canada Safety Requirements and Notices

Do not touch or move antenna while the unit is transmitting or receiving.

Do not hold any component containing the radio such that the antenna is very close to touching any exposed parts of the body, especially the face or eyes, while transmitting.

Do not operate the radio or attempt to transmit data unless the antenna is connected; if not, the radio may be damaged.

#### Use in specific environments:

The use of wireless devices in hazardous locations is limited by the constraints posed by the safety directors of such environments.

The use of wireless devices on airplanes is governed by the Federal Aviation Administration (FAA).

The use of wireless devices in hospitals is restricted to the limits set forth by each hospital.



#### Explosive Device Proximity Warning

Do not operate a portable transmitter (such as a wireless network device) near unshielded blasting caps or in an explosive environment unless the device has been modified to be qualified for such use.



#### Use On Aircraft Caution

Regulations of the FCC and FAA prohibit airborne operation of radio-frequency wireless devices because their signals could interfere with critical aircraft instruments.

#### Other wireless devices

##### Safety notices for other devices in the wireless network:

Refer to the documentation supplied with wireless Ethernet adapters or other devices in the wireless network.



The Part 15 radio device operates on a non-interference basis with other devices operating at this frequency. Any changes or modification to said product not expressly approved by Intel could void the user's authority to operate this device.

### **Unintentional emitter per FCC Part 15**

This device complies with Part 15 of the FCC Rules. Operation is subject to the following two conditions: (1) this device may not cause harmful interference, and (2) this device must accept any interference received, including interference that may cause undesired operation.



This equipment has been tested and found to comply with the limits for a Class B digital device pursuant to Part 15 of the FCC Rules. These limits are designed to provide reasonable protection against harmful interference in a residential installation. This equipment generates, uses, and can radiate radio frequency energy. If not installed and used in accordance with the instructions, it may cause harmful interference. If this equipment does cause harmful interference to radio or television reception, which can be determined by turning the equipment off and on, the user is encouraged to try to correct the interference by one or more of the following measures:

- Reorient or relocate the receiving antenna.
- Increase the separation between the equipment and receiver.
- Connect the equipment into an outlet on a circuit different from that to which the receiver is connected.
- Consult the dealer or an experienced radio/TV technician for help.

If necessary, the user should consult the dealer or an experienced radio/television technician for additional suggestions. The user may find the following booklet helpful: "Something About Interference."

This is available at FCC local regional offices. Our company is not responsible for any radio or television interference caused by unauthorized modifications of this equipment or the substitution or attachment of connecting cables and equipment other than those specified by our company. The correction will be the responsibility of the user. Use only shielded data cables with this system.

## **Intentional emitter per FCC Part 15**

(If fitted with 2.4 G band or 5 G band)

Low power, Radio LAN type devices (radio frequency (RF) wireless communication devices), operating in the 2.4 GHz/5 GHz Band, may be present (embedded) in the notebook system. This section is only applicable if these devices are present. Refer to the system label to verify the presence of wireless devices.

Wireless devices that may be in the system are only qualified for use in the United States of America if an FCC ID number is on the system label.

This device is restricted to indoor use due to its operation in the 5.15 to 5.25 GHz frequency range. FCC requires this product to be used indoors for the frequency range 5.15 to 5.25 GHz to reduce the potential for harmful interference to co-channel Mobile Satellite systems. High power radars are allocated as primary users of the 5.25 to 5.35 GHz and 5.65 to 5.85 GHz bands. These radar stations can cause interference with and/or damage this device.

Operation of this device is subject to the following two conditions:

(1) This device may not cause harmful interference, and (2) this device must accept any interference received, including interference that may cause undesired operation of the device.



Wireless devices are not user serviceable. Do not modify them in any way.

Modification to a wireless device will void the authorization to use it. Contact manufacturer for service.

## Health and safety information

### Exposure to Radio Frequency (RF) Signals Certification Information

This product can contain an embedded radio transmitter and receiver. It is designed and manufactured not to exceed the exposure limits for radio frequency (RF) energy set by the Federal Communications Commission (FCC) of the U.S. government. These FCC exposure limits are derived from the recommendations of two expert organizations, the National Council on Radiation Protection and Measurement (NCRP) and the Institute of Electrical and Electronics Engineers (IEEE). In both cases, the recommendations were developed by scientific and engineering experts drawn from industry, government, and academia after extensive reviews of the scientific literature related to the biological effects of RF energy.

Before a new model is available for sale to the public, it must be certified to the FCC that it does not exceed the exposure limit established by the FCC. Evaluation per each model is performed in positions and locations (e.g. at the bottom on the body) as required by the FCC.

For body worn operation, this model meets the FCC RF exposure guidelines when used with Samsung accessory designated for this product. Non-compliance with the above restrictions may result in violation of FCC RF exposure guidelines.

RF exposure or SAR information can be viewed on-line at [www.fcc.gov/oet/ea/fccid/](http://www.fcc.gov/oet/ea/fccid/). This site uses this product FCC ID number on the outside of the product. Sometimes it may be necessary to remove the battery pack to find number. Once you have the FCC ID number for a particular product, follow the instructions on the website and it should provide RF exposure information or values for typical or maximum SAR for particular product.

For corresponding model only

The Specific Absorption Rate (SAR) is a measure of the rate of absorption of RF energy by the human body expressed in units of watts per kilogram (W/kg). The FCC wireless devices to comply with a safety limit of 1.6 watts per kilogram (1.6 W/kg).

SAR level of this device while operating can be well below the maximum value. This is because the device is designed to operate at multiple power levels so as to use only the power required to reach the network. In general, the closer you are to a wireless base station antenna, the lower the power output.

## Canada

### Unintentional emitter per ICES-003

This digital apparatus does not exceed the Class B limits for radio noise emissions from digital apparatus as set out in the radio interference regulations of Industry Canada.

### Intentional emitter per RSS 210

This device complies with RSS 210 of Industry Canada. Operation is subject to the following two conditions: (1) this device may not cause interference, and (2) this device must accept any interference, including interference that may cause undesired operation of this device.

The term “IC” before the equipment certification number only signifies that the Industry Canada technical specifications were met. To reduce potential radio interference to other users, the antenna type and its gain should be so chosen that the equivalent isotropically radiated power (EIRP) is not more than that required for successful communication. To prevent radio interference to the licensed service, this device is intended to be operated indoors and away from windows to provide maximum shielding. Equipment (or its transmit antenna) that is installed outdoors is subject to licensing.

(If fitted with 2.4 G band or 5 G band)

Low power, Radio LAN type devices (radio frequency (RF) wireless communication devices), operating in the 2.4 GHz/5 GHz Band, may be present (embedded) in your notebook system. This section is only applicable if these devices are present. Refer to the system label to verify the presence of wireless devices.

Wireless devices that may be in your system are only qualified for use in Canada if an Industry Canada ID number is on the system label.

When using IEEE 802.11a wireless LAN, this product is restricted to indoor use due to its operation in the 5.15 to 5.25 GHz frequency range. Industry Canada requires this product to be used indoors for the frequency range of 5.15 to 5.25 GHz to reduce the potential for harmful interference to co-channel mobile satellite systems. High power radar is allocated as the primary user of the 5.25 to 5.35 GHz and 5.65 to 5.85 GHz bands. These radar stations can cause interference with and/or damage to this device.

The maximum allowed antenna gain for use with this device is 6dBi in order to comply with the E.I.R.P limit for the 5.25 to 5.35 GHz and 5.725 to 5.85 GHz frequency range in point-to-point operation.

The power output of the wireless device (or devices), which may be embedded in your notebook, is well below the RF exposure limits as set by Industry Canada.

Operation of this device is subject to the following two conditions: (1) This device may not cause harmful interference, and (2) this device must accept any interference received, including interference that may cause undesired operation of the device.



To prevent radio interference to licensed service, this device is intended to be operated indoors and away from windows to provide maximum shielding. Equipment (or its transmit antenna) that is installed outdoors is subject to licensing.



Wireless devices are not user serviceable. Do not modify them in any way. Modification to a wireless device will void the authorization to use it. Contact manufacturer for service.

## Brazil

Este produto está homologado pela ANATEL, de acordo com os procedimentos regulamentados pela Resolução 242/2000, e atende aos requisitos técnicos aplicados.

Este equipamento opera em caráter secundário, isto é, não tem direito a proteção contra interferência prejudicial, mesmo de estações do mesmo tipo, e não pode causar interferência a sistemas operando em caráter primário.

### Manufacturer information

#### **Samsung Electronics Co., Ltd.**

129, Samsung-Ro, Yeongtong-Gu, Suwon-City, Gyeonggi-Do, 443-742, Korea

#### **Samsung Electronics Suzhou Computer Co., Ltd.**

No. 198, Fangzhou Road, Suzhou Industrial Park, Jiangsu Province, 215021, China

Tel: +86-0512-6253-8988

#### **Samsung Electronics Vietnam Co., Ltd.**

Yen Phong 1, I.P Yen Trung Commune, Yen Phong Dist., Bac Ninh Province, Vietnam

For the web or the phone number of the Samsung Service Center, see the Warranty or contact the retailer where you purchased your product.

## RTC caution

CAUTION: Danger of explosion if battery is incorrectly replaced. Replace only with the same or equivalent type recommended by the manufacturer. Discard used batteries according to the Manufacturer's instruction.



## WEEE symbol information



**Correct disposal of this product (Waste Electrical & Electronic Equipment)**

**■ (Applicable in countries with separate collection systems)**

This marking on the product, accessories or literature indicates that the product and its electronic accessories (for example, charger, headset, USB cable) should not be disposed of with other household waste at the end of their working life.

To prevent possible harm to the environment or human health from uncontrolled waste disposal, please separate these items from other types of waste and recycle them responsibly to promote the sustainable reuse of material resources.

Household users should contact either the retailer where they purchased this product, or their local government office, for details of where and how they can take these items for environmentally safe recycling.

Business users should contact their supplier and check the terms and conditions of the purchase contract. This product and its electronic accessories should not be mixed with other commercial wastes for disposal.

For information on Samsung's environmental commitments and product specific regulatory obligations e.g. REACH visit: [samsung.com/uk/aboutsamsung/samsungelectronics/corporatecitizenship/data\\_corner.html](https://samsung.com/uk/aboutsamsung/samsungelectronics/corporatecitizenship/data_corner.html)

### India only

For more information on safe disposal and recycling visit our website [www.samsung.com/in](https://www.samsung.com/in) or contact our Helpline numbers - 18002668282, 180030008282.

This product is RoHS compliant.



**Correct disposal of batteries in this product**

**(Applicable in countries with separate collection systems)**

This marking on the battery, manual or packaging indicates that the batteries in this product should not be disposed of with other household waste at the end of their working life. Where marked, the chemical symbols Hg, Cd or Pb indicate that the battery contains mercury, cadmium or lead above the reference levels in EC Directive 2006/66. If batteries are not properly disposed of, these substances can cause harm to human health or the environment.

To protect natural resources and to promote material re-use, please separate batteries from other types of waste and recycle them through your local, free battery return system.

## USA only

This Perchlorate warning applies only to primary CR (Manganese Dioxide) Lithium coin cells in the product sold or distributed ONLY in California USA.

“Perchlorate Material- special handling may apply, see [www.dtsc.ca.gov/hazardouswaste/perchlorate](http://www.dtsc.ca.gov/hazardouswaste/perchlorate).”

Dispose unwanted electronics through an approved recycler.

To find the nearest recycling location, go to our website:

[www.samsung.com/recyclingdirect](http://www.samsung.com/recyclingdirect)

or call, (877) 278-0799.

For battery recycling go to [call2recycle.org](http://call2recycle.org); or call 1-800-822-8837.

Warning: This product contains chemicals known to the state of California to cause cancer, birth defects, or other reproductive harm.

## Samsung package Take-Back program

In partnering with select recyclers, Samsung offers packaging take-back at no cost to you.

Simply call the following number for the locations nearest you.

CRT Processing, LLC

(877) 278-0799

Kathy Severson – Logistics contact

Dispose unwanted electronics through an approved recycler.

To find the nearest recycling location, go to our website:

[www.samsung.com/recyclingdirect](http://www.samsung.com/recyclingdirect) or call, (877) 278-0799

Some content may differ from the computer depending on the region, service provider, software version, or computer model, and is subject to change without prior notice.

**SAMSUNG**