

Changing the Camera Angle

When a DVD contains multiple angles of a particular scene, you can use the ANGLE function.

Using the ANGLE button (DVD)

If the disc contains multiple angles, the ANGLE (⊕) icon appears on the screen.

1

Press the **ANGLE** button, then the ANGLE icon will appear with the current angle number and the number of angles available.

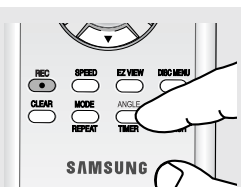

2

Press the ◀▶ buttons repeatedly to select the desired angle. To remove the ANGLE icon, press the **CLEAR** or **RETURN** button.

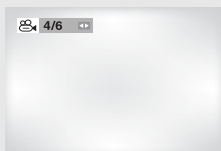

Note

If the disc has only one angle, this feature won't work. Currently, very few discs have this feature.

Using the Bookmark Function

This feature lets you bookmark sections of a DVD so you can quickly find them at a later time.

Using the MARK button (DVD)

1

During play, press the **MARK** button on the remote control.

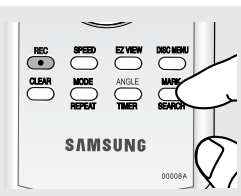

2

When you reach the scene you want to mark, press the **ENTER** button. Up to three scenes may be marked at a time.



Note

Depending on a disc, the Bookmark function may not work.

Recalling a Marked Scene

1

During play, press the **MARK** button on the remote control.

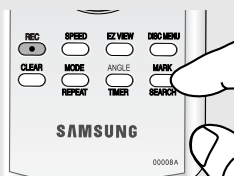

2

Press the ◀▶ buttons to select a marked scene.



3

Press the ▶|| (Play/Pause) button to skip to the marked scene.

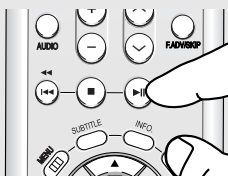

Clearing a Bookmark

1

During play, press the **MARK** button on the remote control.

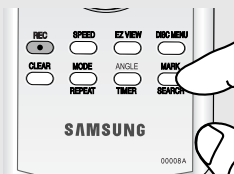

2

Press the ◀▶ buttons to select the bookmark number you want to delete.



3

Press the **CLEAR** button to delete a bookmark number.

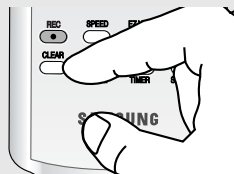

Using the Zoom Function (DVD)

1

During the playback of a DVD disc, press the **MENU** button on the remote control.

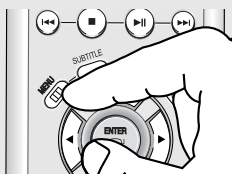

2

Press the **▲/▼** buttons to select **Function**, then press the **▶** or **ENTER** button.

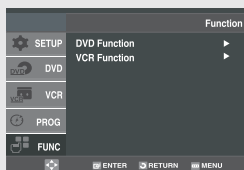

3

Press the **▲/▼** buttons to select **DVD Function**, then press the **▶** or **ENTER** button.

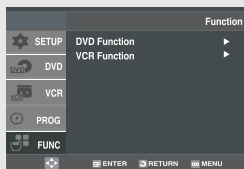

4

Press the **▲/▼** buttons to select **Zoom**, then press the **▶** or **ENTER** button.

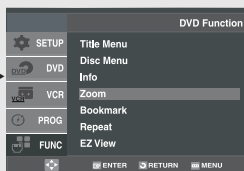

5

Press the **▲/▼** or **◀▶** buttons to select the part of the screen you want to zoom in on.

Press the **ENTER** button.

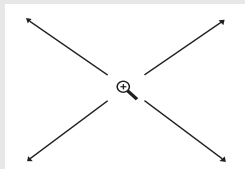

◀ During DVD play, press **ENTER** to zoom in 2X/4X/2X/Normal in order.

Note

Depending on a disc, the Zoom function may not be available.

Clips Menu for MP3/WMA/JPEG

Discs with MP3/WMA/JPEG contain individual songs and/or pictures that can be organized into folders as shown below. They are similar to how you use your computer to put files into different folders.

- 1**
Open the disc tray.
- 2**
Place the disc on the tray.
- 3**
Close the tray.
The tray closes and this screen displays.

Parent Folder, Current Folder and Peer Folders

Folders and Files in Current Folder

- : Name of currently playing file.
- : Current Playback Time.
- : Current Playback Mode : There are four modes. They can be selected in order by pressing the REPEAT button.
 - Off: Normal Playback
 - Track: Repeats the current track.
 - Folder: Repeats the current folder.
 - Random: Files in the disc will be played in random order.
- : MP3 file icon.
- : WMA file icon.
- : JPEG file icon.
- : Folder icon.
- : Current Folder icon.

Folder Selection

The folder can only be selected in the Stop mode.

- **To select the Parent Folder**
Press the **RETURN** button to go to the parent folder, or press the **▲/▼** buttons to select “..” and press the **ENTER** button to go to the parent folder.
- **To select the Peer Folder**
Press the **◀/▶** buttons to highlight the left window. Press the **▲/▼** buttons to select the desired folder, then the **ENTER** button.
- **To select the Sub-Folder**
Press the **◀/▶** buttons to highlight the right window. Press the **▲/▼** buttons to select the desired folder, then press the **ENTER** button.

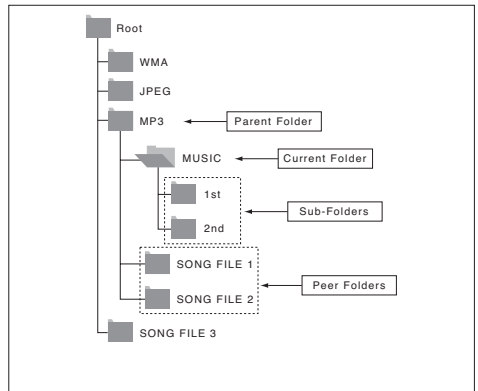

MP3/WMA Playback

1

Open the disc tray.

2

Place the disc on the tray.

3

Close the tray.

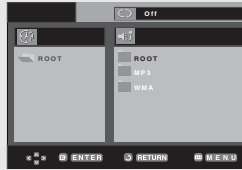

4

Press the ▲/▼ or ◀/▶ buttons to select a song file.

Press the **ENTER** button to begin playback of the song file.



◀ When a disc or a folder contains both MP3 and WMA files, only one type will be played, not both.

Notes

- Depending on the recording method, some MP3 CD-Rs may not be played.
- Only MP3/WMA Format files with the “.mp3 and .wma” extensions can be played.

Repeat/Random playback

During play, press the **REPEAT** button to change the playback mode. There are four modes.

Off, Track, Folder and Random.

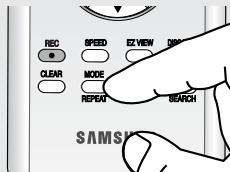

- Off: Normal Playback
- Track: Repeats the current song file.
- Folder: Repeats the song files which have the same extension in the current folder.
- Random: Song files which have the same extension will be played in random order.

To resume normal play, press the **CLEAR** button.

MP3/WMA file

When you record MP3 or WMA files on CD-R, please refer to the following.

- **Your MP3 or WMA files should be ISO 9660 or JOLIET format.**

ISO 9660 format and Joliet MP3 or WMA files are compatible with Microsoft's DOS and Windows, and with Apple's Mac. This format is the most widely used.

- **When naming your MP3 or WMA files, do not exceed 8 characters, and enter ".mp3, .wma" as the file extension.**

General name format : Title.mp3. or Title.wma.
When composing your title, make sure that you use 8 characters or less, have no spaces in the name, and avoid the use of special characters including: (.,/\,=,+).

- **Use a decompression transfer rate of at least 128 Kbps when recording MP3 files.**

Sound quality with MP3 files basically depends on the rate of compression/decompression you choose. Getting CD audio sound requires an analog/digital sampling rate, that is conversion to MP3 format, of at least 128 Kbps and up to 160 Kbps. However, choosing higher rates, like 192

Kbps or more, only rarely give better sound quality. Conversely, files with decompression rates below 128 Kbps will not be played properly.

- **Use a decompression transfer rate of at least 64Kbps when recording WMA files.**

Sound quality with WMA files basically depends on the rate of compression/decompression you choose.

Getting CD audio sound requires an analog/digital sampling rate, that is conversion to WMA format, of at least 64Kbps and up to 192Kbps.

Conversely, files with decompression rates below 64Kbps or over 192Kbps will not be played properly.

- **Do not try recording copyright protected MP3 files.**

Certain "secured" files are encrypted and code protected to prevent illegal copying. These files are of the following types: Windows Media™ (registered trade mark of Microsoft Inc) and SDMITM (registered trade mark of The SDMI Foundation). You cannot copy such files.

- **Important:**

The above recommendations cannot be taken as a guarantee that the DVD-VCR will play MP3 recordings, or as an assurance of sound quality. You should note that certain technologies and methods for MP3 file recording on CD-Rs prevent optimal playback of these files on your DVD-VCR (degraded sound quality and in some cases, inability of the player to read the files).

- This unit can play a maximum of 3000 files and 300 folders per disc.

Program Play & Random Play

You can listen to songs randomly or in the desired sequence.

Up to 20 tracks can be programmed.

This function is available only with Audio CDs.

Program Play

1

With the unit in stop mode, press the **REPEAT** button.

- The play mode menu will appear.

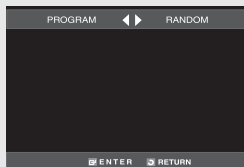

2

Press the ◀ or ▶ buttons to select **PROGRAM**, then press the **ENTER** button.

- The program play screen will appear.

3

Press the ▲/▼ or ◀/▶ buttons to select the desired track, then press the **ENTER** button.

- The selected track will be added to the Program order.
- If you delete the track, press the **CLEAR** button. The track added last will be deleted from the Program order.

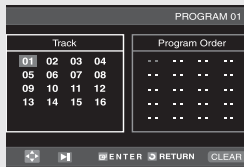

4

To finish programming and start playback, press the ▶|| button.

The disc will be played in programmed order.

Note

Random Play

- With the unit in stop mode, press the **REPEAT** button.
 - The play mode menu will appear.
- Press the ◀ or ▶ buttons to select Random, then press the **ENTER** button.
 - The disc will be played in random order.

Note

If the disc tray is opened during programming, program play will be canceled.

• To Cancel Programming

- Press the **REPEAT** button. The program will not be saved and the program screen will disappear.

• To Cancel Program Play

- During playback or in Stop mode, press the **CLEAR** button.

Picture CD Playback

1

Select the desired folder, then press the **ENTER** button.



2

Press the **▲/▼** buttons to select a Picture file in the clips menu, then press the **ENTER** button.



3

Press the **INFO.** button to display the menu.

Press the **◀▶** buttons to select the menu you want to view, then press the **ENTER** button.

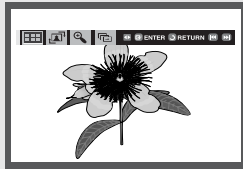

Notes

- If no buttons on the remote control are pressed for 10 seconds, the menu will disappear.
- Press the **■** (Stop) button to return to the clips menu.
- When playing a Kodak Picture CD, the unit displays the Photo directly, not the clips menu.

Album Screen

- : Returns to the Album Screen.
- To see the next six pictures, press the **▶▶** (Skip) button.
- To see the previous six pictures, press the **◀◀** (Skip) button.

Rotation

: Each time the **ENTER** button is pressed, the picture rotates 90 degrees clockwise.

Zoom

: Press the **▲/▼** or **◀▶** buttons to select the part of the screen you want to zoom in on. Press the **ENTER** button. Each time the **ENTER** button is pressed, the picture is enlarged up to 4X. (2X → 4X → 2X → Normal)

Slide Show

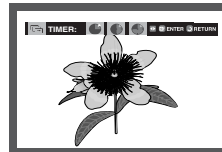

- : The unit enters slide show mode.
- Before beginning the Slide Show, the picture interval must be set.
- : When this icon is selected and **ENTER** is pressed, the pictures change automatically with about a 6 second interval.
- : The pictures change automatically with about a 12 second interval.
- : The pictures change automatically with about a 18 second interval.

Notes

- Depending on a file size, the amount of time between each picture may be different from the set interval time.
- If you don't press any button, the slide show will start automatically in about 10 seconds by default.

JPEG Discs

When playing a CD-R/Picture CD

- Only files with the “.jpg” and “.JPG” extensions can be played.
- If the disc is not closed, it will take longer to start playing and not all of the recorded files may be played.
- Only CD-R discs with JPEG files in ISO 9660 or Joliet format can be played.
- The name of the JPEG file may not be longer than 8 characters and should contain no blank spaces or special characters (. / = +).
- Only a consecutively written multi-session disc can be played. If there is a blank segment in the multi-session disc, the disc can be played only up to the blank segment.
- A maximum of 3000 images can be stored on a single CD.
- Kodak Picture CDs are recommended.
- When playing a Kodak Picture CD, only the JPEG files in the pictures folder can be played.
- Kodak Picture CD: The JPEG files in the pictures folder can be played automatically.
- Konica Picture CD: If you want to see the Picture, select the JPEG files in the clips menu.
- Fuji Picture CD: If you want to see the Picture, select the JPEG files in the clips menu.
- QSS Picture CD: The unit may not play QSS Picture CD.
- If the number of files in 1 Disc is over 3000, only the first 3000 JPEG files can be played.
- If the number of folders in 1 Disc is over 300, only JPEG files in the first 300 folders can be played.

Using the Setup Menu

The Setup menu lets you customize your DVD-VCR by allowing you to select various language preferences, set up a parental level, even adjust the player to the type of television screen you have.

1

With the unit in Stop mode, press the **MENU** button on the remote control.

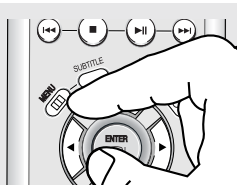

2

Press the ▲/▼ buttons to select **DVD**, then press the ► or **ENTER** button.

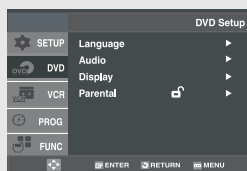

- ① Language: Setup of the Language.
- ② Audio: Setup of the Audio Options.
- ③ Display: Setup of the Display Options. Used to select which type of screen you want to watch and several display options.
- ④ Parental: Setup of the Parental Level. Allows users to set the level necessary to prevent children from viewing unsuitable movies such as those with violence, adult subject matter, etc.

3

Press the ▲/▼ buttons to access the different features. Press the ► or **ENTER** button to access the sub features.

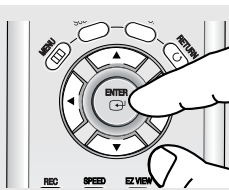

4

To make the DVD setup screen disappear after setting up, press the **MENU** button again.

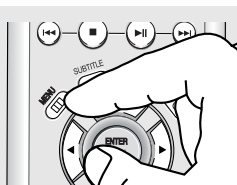

Note

Depending on the disc, some DVD Setup menu selections may not be available.

Setting Up the Language Features

If you set the audio and subtitle language in advance, they will come up automatically every time you watch a movie.

1

With the unit in Stop mode, press the **MENU** button on the remote control.

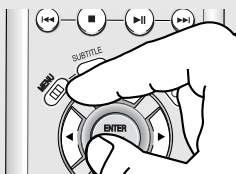

2

Press the $\blacktriangle/\blacktriangledown$ buttons to select **DVD**, then press the \blacktriangleright or **ENTER** button.



3

Press the $\blacktriangle/\blacktriangledown$ buttons to select **Language**, then press the \blacktriangleright or **ENTER** button.

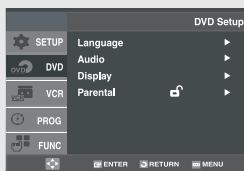

4

Press the $\blacktriangle/\blacktriangledown$ buttons to select the desired item, then press the \blacktriangleright or **ENTER** button.

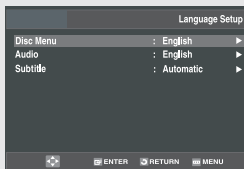

5

Press the $\blacktriangle/\blacktriangledown$ buttons to select the desired language, then press the \blacktriangleright or **ENTER** button.

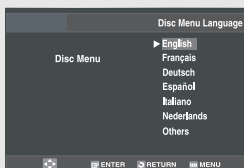

- ◀ - The language is selected and the screen returns to Language Setup menu.
- To make the DVD Setup menu disappear, press the **MENU** button.

Language Function

Disc Menu

To set the Disc Menu Language to your preferred language, follow these steps. If your preferred language is available on a DVD, your Disc Menu Language will automatically be set to the language you choose.



- ◀ - Select "Others" if the language you want is not listed.
- If the selected language is not recorded on the disc, the original pre-recorded language is selected.

Audio

To set the Audio Language to your preferred language, follow these steps. If your preferred language is available on a DVD, your Audio Language will automatically be set to the language you choose.



- ◀ - Select "Original" if you want the default soundtrack language to be the original language the disc is recorded in.
- Select "Others" if the language you want is not listed.
- If the selected language is not recorded on the disc, the original pre-recorded language is selected.

Subtitle

To set the Subtitle Language to your preferred language, follow these steps. If your preferred language is available on a DVD, your Subtitle Language will automatically be set to the language you choose.

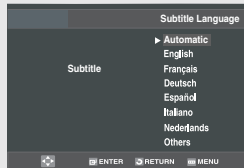

- ◀ - Select "Automatic" if you want the subtitle language to be the same as the language selected as the audio language.
- Select "Others" if the language you want is not listed. Some discs may not contain the language you select as your initial language; in that case the disc will use its original language setting.

Setting Up the Audio Options

Audio Options allows you to set up sound for use with your external audio system.

1

With the DVD in Stop mode, press the **MENU** button on the remote control.

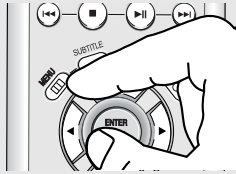

2

Press the **▲/▼** buttons to select **DVD**, then press the **▶** or **ENTER** button.



3

Press the **▲/▼** buttons to select **Audio**, then press the **▶** or **ENTER** button.



4

Press the **▲/▼** buttons to select the desired item, then press the **▶** or **ENTER** button.

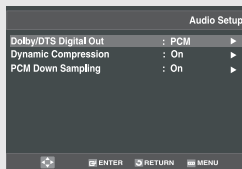

◀ - To make the DVD Setup menu disappear, press the **MENU** button.

Audio Options

Dolby/DTS Digital Out

- PCM: Converts to PCM(2CH) audio.
- Bitstream: Outputs Dolby/DTS Digital via the digital output. Select Bitstream when connecting to a Dolby/DTS Digital Decoder.

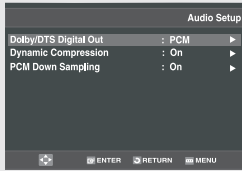

Note

There is no analog audio output when you play a DTS disc.

Manufactured under license from Dolby Laboratories. "Dolby" and the double-D symbol are trademarks of Dolby Laboratories. "DTS" and "DTS Digital Out" are trademarks of Digital Theater Systems, Inc.

Dynamic Compression

- On: To select dynamic compression.
- Off : To select the standard range.

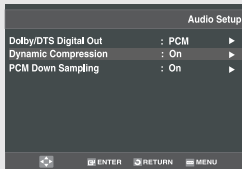

- ◀ - Dynamic compression restrains the dynamic range of the sound, i.e. the difference between the loud and quiet passages of a DVD audio track. This is useful when watching a DVD late at night.

PCM Down Sampling

- On: Select this when the Amplifier connected to the player is not 96KHz compatible. In this case, the 96KHz signals will be down converted to 48KHZ.
- Off: Select this when the Amplifier connected to the player is 96KHz compatible. In this case, all signals will be output without any changes.

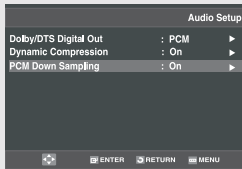

Note

Even when PCM Down sampling is Off, some discs will still output down sampled (48KHZ) audio through the digital outputs.

Setting Up the Display Options

Display options enable you to set various video functions of the player.

1

With the unit in Stop mode, press the **MENU** button on the remote control.

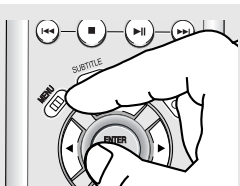

2

Press the ▲/▼ buttons to select **DVD**, then press the ► or **ENTER** button.

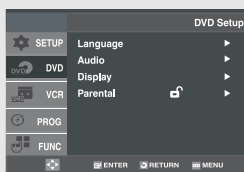

3

Press the ▲/▼ buttons to select **Display**, then press the ► or **ENTER** button.

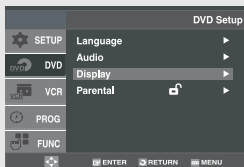

4

Press the ▲/▼ buttons to select the desired item, then press the ► or **ENTER** button.

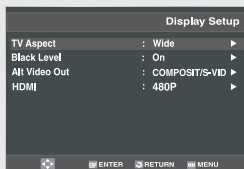

◀ - To make the DVD Setup menu disappear, press the **MENU** button.

Display Options

TV Aspect

Depending on the type of television you have, you may want to adjust the screen setting (aspect ratio).



- 4:3 Letter Box: Select when you want to see the total 16:9 ratio screen DVD supplies, even though you have a TV with a 4:3 ratio screen. Black bars will appear at the top and bottom of the screen.
- 4:3 Pan Scan: Select this for conventional size TVs when you want to see the central portion of the 16:9 screen. (Extreme left and right side of movie picture will be cut off.)
- 16:9 Wide: You can view the full 16:9 picture on your wide screen TV.

Black Level

The Black Level feature adjusts black reference level in the video signal to one of two choices:



- On: This will enhance the Black Level for increased brightness/contrast when viewing DVDs.
- Off: This is the Standard NTSC reference Black Level for consistent brightness/contrast across all sources.

Alt Video Out

The “Alt Video Out” option must be set in the on-screen menu if you have connected your DVD-VCR to a TV using the S-VIDEO OUT or COMPONENT VIDEO OUT jacks.



- **COMPOSITE/S-VIDEO**: Select when you want to use S-Video output.
- **COMPONENT(I-SCAN)**: Select when you want to use Component interlace(525i) Out or Progressive(525p) Out.
- **HDMI/COMPONENT(P-SCAN)** : Select when you want to use Progressive(525p) Out.

Note

It cannot be adjusted when Alt Video Out is set to Progressive.

- ◀ - See your TV owner’s manual to determine what type of TV you have.
- **COMPONENT(I-SCAN)**: Interlaced Scan mode will work.
- **HDMI/COMPONENT(P-SCAN)**: Progressive Scan mode will work, and Video and S-Video will not work.
- Press the **P.SCAN** button on the front panel in stop mode. Be sure to set the correct Video output for the proper picture.

DVD OPERATIONS

HDMI

This setting is used when the unit is connected by HDMI with Display devices (TV, projector, etc).

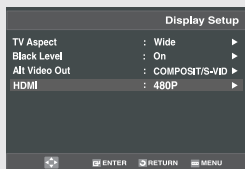

- Resolution

- 480p/576p : 720 x 480, 720 x 576
- 720p : 1280 x 720
- 768p : 1024 x 768
- 1080i : 1920 x 1080

- Format

This feature can be used to fine-tune the output of the DVD-V9500 to your TV or Monitor for best color reproduction.

You can use this function to set the HDMI output's digital data RGB range.

- RGB-Normal : HDMI Limited range RGB data output.
- RGB-Expand : HDMI Full range RGB data output.
- YCbCr-(4:4:4) : HDMI Limited range YCbCr-(4:4:4) output.
- YCbCr-(4:2:2) : HDMI Limited range YCbCr-(4:2:2) output.

If you set the HDMI output resolution to 768p, you cannot use the YCbCr format.

Limited range Black/White and color level are displayed within Limited data range.

ex) When the bit depth is 8 bits

- Y : 16~235
- CbCr : 16~240

Full range Black/White and color level are displayed within full data range.

ex) When the bit depth is 8 bits

- Y : 0~255
- CbCr : 0~255

- Brightness

You can use this function to set HDMI/COMPONENT (P-SCAN) output brightness.

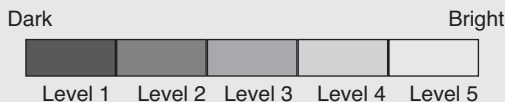

- **Consult your TV User's Manual to find out if your TV supports Progressive Scan. If Progressive Scan is supported, follow the TV User's Manual regarding Progressive Scan settings in the TV's menu system.**
- **If Video Output is set incorrectly, the screen may be blocked.**
- **The resolutions available for HDMI output depend on the connected TV or projector. For details, see the user's manual of your TV or projector.**
- **When the resolution is changed during playback, it may take a few seconds for a normal image to appear.**
- **If you set the HDMI output resolution 720p or 1080i, HDMI output provides better picture quality.**

Setting Up the Parental Control

The Parental Control function works in conjunction with DVDs that have been assigned a rating, which helps you control the types of DVDs that your family watches. There are up to 8 rating levels on a disc.

1

With the DVD in Stop mode, press the **MENU** button on the remote control.

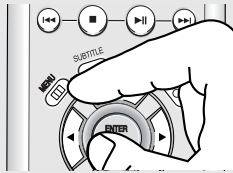

2

Press the **▲/▼** buttons to select **DVD**, then press the **▶** or **ENTER** button.



3

Press the **▲/▼** buttons to select **Parental**, then press the **▶** or **ENTER** button.



4

Press the **▶** or **ENTER** button to select **Yes** if you want to use a password. The Enter Password screen appears.

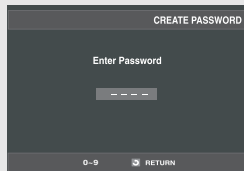

5

Enter your password. The Re-enter Password screen appears to confirm the password. Enter your password again.

The player is locked (🔒).

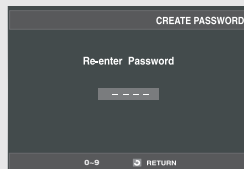

◀ - To make the DVD Setup menu disappear, press the **MENU** button.

Note

There is no default password.

DVD OPERATIONS

Setting Up the Rating Level

1

With the unit in stop mode, press the **MENU** button on the remote control.

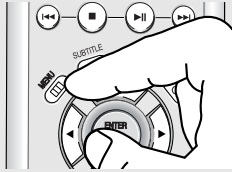

2

Press the **▲/▼** buttons to select **DVD**, then press the **▶** or **ENTER** button.



3

Press the **▲/▼** buttons to select **Parental**, then press the **▶** or **ENTER** button.

Enter your password.

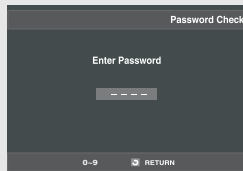

4

Press the **▲/▼** buttons to select **Rating Level**, then press the **▶** or **ENTER** button.

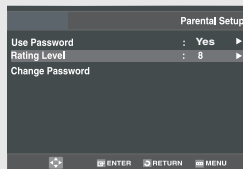

5

Press the **▲/▼** buttons to select the Rating Level you want, then press the **▶** or **ENTER** button.

e.g) Setting up in Level 6.

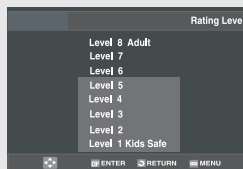

- ◀ - To make the DVD setup menu disappear, press the **MENU** button.
- For example, if you select up to Level 6, discs that contain Level 7, 8 will not play.

DVD OPERATIONS

Changing the Password

1

With the unit in stop mode, press the **MENU** button on the remote control.

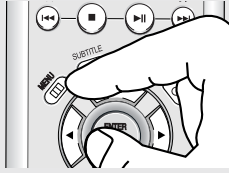

2

Press the ▲/▼ buttons to select **DVD**, then press the ► or **ENTER** button.



3

Press the ▲/▼ buttons to select **Parental**, then press the ► or **ENTER** button.
Enter your password.

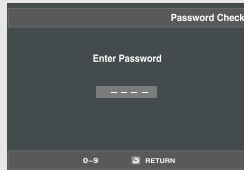

4

Press the ▲/▼ buttons to select **Change Password**, then press the ► or **ENTER** button.

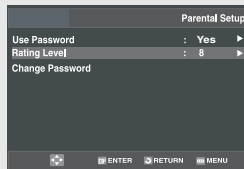

5

Enter your new password.
Re-enter the new password again.

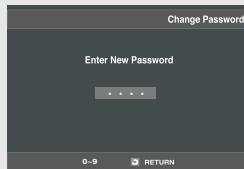

◀ - To make the DVD setup menu disappear, press the **MENU** button.

Note

If you forgot your password, press power on from a cold start with no disc in the unit. Press the **HDMI/CH (V)** buttons simultaneously on the front panel for 5 seconds. The "Reset Ok" message will appear. Press the **POWER** button.

Chapter 5

VCR OPERATIONS

In this chapter, you will learn how to play a video cassette tape, how to use the time counter and memory stop features, and how to record a program as you are watching TV.

Inserting and Ejecting a Video Cassette Tape

To Insert a Video Cassette Tape

1

Hold the video cassette tape window-side up with the arrow pointing away from you.

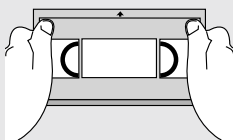

2

Gently push the tape through the compartment door until you feel the VCR pull it.

The VCR loads the tape automatically.

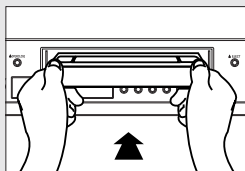

- ◀ - Don't try to insert a tape upside down or backwards.
- Use only video tapes labeled "VHS." European PAL VHS video tapes and S-VHS pre-recorded tapes aren't compatible with this unit. Choose brand name, high quality tapes for best results.
- ◀ - If the safety tab of your video tape has been removed, the tape begins to play automatically. You don't have to press PLAY. For more information on the safety tab, see page 77.

To Eject a Video Cassette Tape

1

Press the ■ (Stop) button to stop playing the tape.

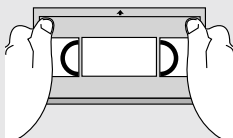

2

Press the **EJECT** button on the front panel to eject the tape.

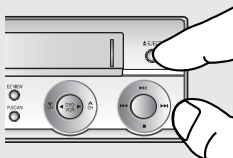

- ◀ When you're finished playing a pre-recorded video tape, it's best to rewind it to the beginning and remove it from the VCR to protect it from wear and tear.
- ◀ After ejecting a tape, you should remove it completely from the compartment and turn off the VCR.

Playing a Pre-Recorded Video Cassette Tape

Playing the Tape

1

Insert the video cassette tape.

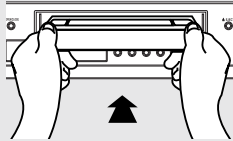

◀ - For more information on the safety tab, see page 77.

2

If the tape doesn't begin to play automatically, press the ►|| (Play/Pause) button.

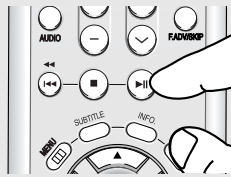

3

Pausing Play

While a tape is playing, press the ►|| (Play/Pause) button when you want to interrupt play. The tape pauses temporarily.

Press the ►|| (Play/Pause) button to resume playing the tape.



◀ - The VCR does not play sound while a video tape is paused.

- If you see white lines on the screen, see "Using Automatic Tracking" on page 68.

Special VCR Playback Features

While a videotape is playing, you can enjoy a variety of special playback features, including Still, Frame Advance, Audio Advance, Skip, Repeat, and more. Press the Play/Pause button again to resume normal playback.

Frame Advance

In the pause mode, press **F.ADV** to advance to the next frame.

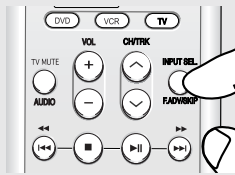

Fps/Rps Review

In Play mode, press the **▶▶** (Forward) or **◀◀** (Rewind) to review at two speeds:

- Picture Search: Press and release to advance the tape forward or backward at 5 times normal speed.
- Jet Search: Press and hold down the **SEARCH** button, then release it to play back at the normal speed.

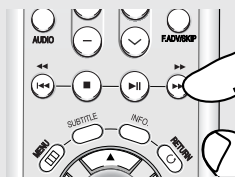

Skip

In Play mode, press the **SKIP** button to move ahead exactly 30 seconds. Press the **SKIP** button repeatedly up to 4 times to move ahead 2 minutes.

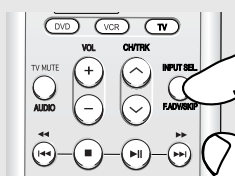

Repeat

- In Play mode, press the **REPEAT** button to review the last 5 seconds of tape (SP mode).
- In Play mode, press the **REPEAT** button to review the last 15 seconds of tape (SLP mode).

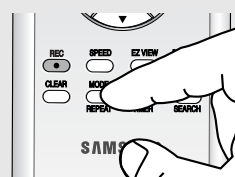

VCR OPERATIONS

Shuttle

In Play mode, **Shuttle >>** gradually increases the cue speed: Double Speed playback → Picture Search → Jet Search.

Shuttle << gradually slows down the tape, then goes into Slow mode, Still mode, Reverse Picture Search and Reverse Jet Search.

Each time you press the **SHUTTLE** button, the playback speed is different accordingly.

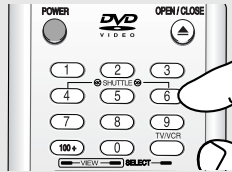

Using Automatic Tracking

The Tracking adjustment removes the white lines that sometimes appear during playback because of slight differences in recording decks. The TRK button will automatically align the recorded tracks with the playback heads to solve this problem. You may also set tracking manually.

1

Insert and play a video cassette tape.

As soon as the tape begins to play, the VCR begins automatic tracking.

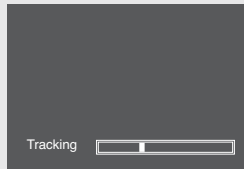

2

If automatic tracking doesn't remove the streaks from the picture, press and hold the TRK (↶) or TRK (↷) button until the streaks disappear.



Selecting the Cassette Type

If you wish to use the tape counter to display the time remaining on a cassette, you must indicate the type of cassette inserted.

1

Press the **MENU** button on the remote control.

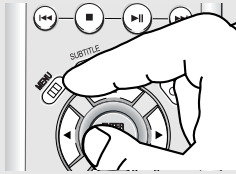

2

Press the ▲/▼ buttons to select **VCR**, then press the ► or **ENTER** button.

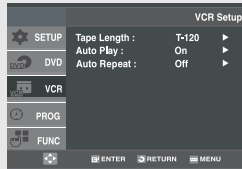

3

Press the ▲/▼ buttons to select **Tape Length**, then press the ► or **ENTER** button to select the correct cassette length.

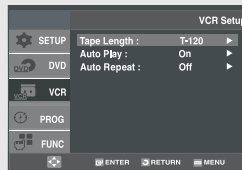

Note

This information is usually printed on the tape box. The menu cycles through: T-120, T-160 or T-180.

Once the type of cassette is set, the VCR can display the amount of time remaining on the tape when you press the **INFO**. button.

4

Press the **MENU** button to exit.

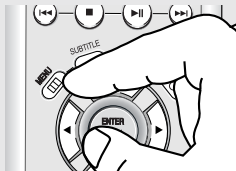

Setting the Auto Play

If you want your videotapes to play automatically when you insert them, turn on Auto Play.

1

Press the **MENU** button on the remote control.

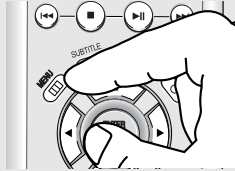

Note

Only tapes that are missing the Record Safety Tab will play automatically when inserted (See page 77).

2

Press the **▲/▼** buttons to select **VCR**, then press the **▶** or **ENTER** button.

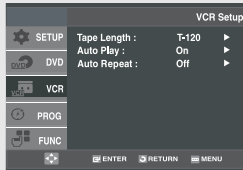

3

Press the **▲/▼** buttons to select **Auto Play**, then press the **▶** or **ENTER** button to select **On** or **Off**.



- ◀ - On: The VCR will automatically begin playing a video tape when it is inserted, as long as the safety tab of the cassette has been removed.
- Off: Auto play is disabled.

4

Press the **MENU** button to exit.

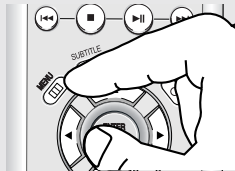

Setting the Auto Repeat

If you want your videotapes to play repeatedly, turn on Auto Repeat.

1

Press the **MENU** button on the remote control.

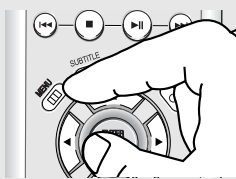

2

Press the ▲/▼ buttons to select **VCR**, then press the ► or **ENTER** button.



3

Press the ▲/▼ buttons to select **Auto Repeat**, then press the ► or **ENTER** button to select **On** or **Off**.

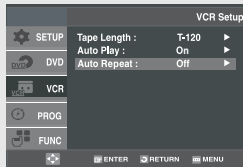

- ◀ - On: The VCR will play a tape repeatedly [unless a tape control is activated (stop, fast forward or rewind)].
- Off: Auto Repeat is disabled.

4

Press the **MENU** button to exit.

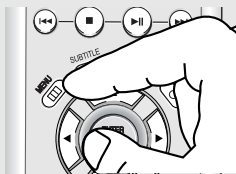

Using the Tape Counter

The tape counter:

- Indicates the elapsed time in the play and record modes (hours, minutes and seconds).
- Is reset when a cassette is inserted in the DVD-VCR.
- Allows you to easily find the beginning of a sequence.
- If the remaining time is to be calculated correctly, you must indicate the type of cassette being used.

1

Insert a cassette in your DVD-VCR. To set the tape counter to zero at the beginning of a sequence:

- Press the **INFO.** button twice to display the counter
- Press the **CLEAR** button when you want to set the tape counter to zero.

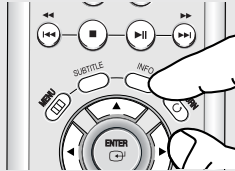

2

When you are ready,

- Start playback or Recording.
- Press the **■** (Stop) button.
- To fast-forward or rewind to the sequence at which the counter was set to zero, press the **▶▶** (Forward) or **◀◀** (Rewind) button.
- Some DVD-VCR information, such as the counter, can be displayed on the television screen.

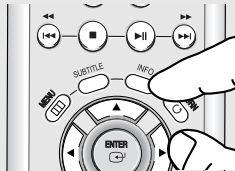

Press the **INFO.** button:

- Once to display the current function, recording speed and counter.
- Twice to display the counter only.
- Three times to display the time remaining on the cassette.
- Four times to clear the display.

Using the Assemble Edit Function

This function allows you to start a new recording at a specific position on the cassette while maintaining a very smooth scene change.

1

Insert the cassette to be edited in your DVD-VCR.

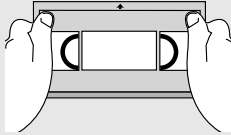

2

Press the **▶II** (Play/Pause) button to start playback.



3

When you reach the position from which you wish to start the new recording, press the **▶II** (Play/Pause) button.



4

Press the **F.ADV** button as often as necessary to advance frame by frame, until the exact recording position is located.

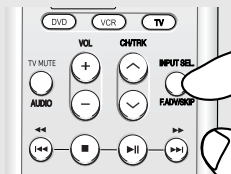

5

While the DVD-VCR is in pause mode, press the **REC** button. The pause mode is displayed on the screen.

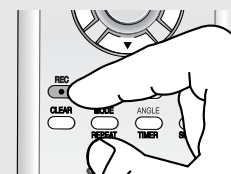

VCR OPERATIONS

6

Select the source from which you wish to record by pressing:

- The **CH** \wedge or \vee buttons for television channel.
- The **INPUT SEL.** button for the **LINE** input source.



7

Press the **REC** button to start recording. When you have finished recording, press the **■** (Stop) button.

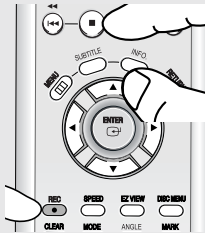

Selecting the Audio Output Mode

You can select the mode in which the sound is reproduced on the loudspeakers and AV outputs. The following options are available.

Press the **AUDIO** button on the remote control until the required option is displayed.

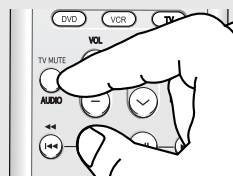

Audio output mode

- Left: Used to listen to the sound on the left Hi-Fi channel.
- Right: Used to listen to the sound on the right Hi-Fi channel.
- Mono: Used to listen to the sound on the normal mono channel.
- Hi-Fi: Used to listen to Hi-Fi stereo sound on the left and right channels. When playing back tapes recorded in Hi-Fi, the sound switches to Hi-Fi after five seconds of Mono.

Searching for a Specific Sequence

Each time you record a cassette on this DVD-VCR, an “index” is automatically marked on the tape when recording starts.

The Search function allows you to fast-forward or rewind to a specific index and start playback from that point. Depending on the direction selected, the indexes are numbered as follows:

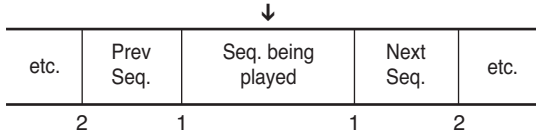

This DVD-VCR uses a standard indexing system (VISS). As a result, it will recognize any indexes marked by other VCRs using the same system and vice versa.

1

Press the **MENU** button on the remote control.

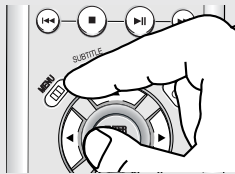

2

Press the ▲/▼ buttons to select **Function**, then press the ► or **ENTER** button.



3

Press the ▲/▼ buttons to select **VCR Function**, then press the ► or **ENTER** button.

VCR Function can be displayed simply by pressing the **SEARCH** button.

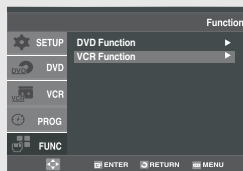

4

Press the ▲/▼ buttons to select the desired item, then press the ► or **ENTER** button.

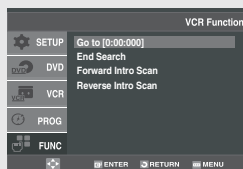

Variable Search System

Go To [0:00:00] Stop

Use this feature when you want to search for the 0:00:00 counter position on a cassette.

Press the **CLEAR** button at the point on the tape where you want to set the counter to **[0:00:00]**.

The VCR will rewind or fast forward, searching for the 0:00:00 counter position, and then automatically stop at that position.



End Search

Use this feature when you want to search for a blank position to record a program on a cassette.

The VCR will fast forward, searching for a blank position, and then automatically stop at that position.

If the VCR reaches the end of the tape during end search, the tape will be ejected.

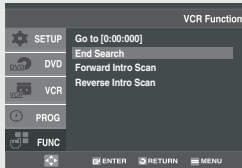

Scan and play

Use scan and play when you don't know exactly where a program is located on a cassette tape.

- Forward Intro Scan

Select "Forward Intro Scan", then press the **ENTER** button.

- Reverse Intro Scan

Select "Reverse Intro Scan", then press the **ENTER** button.

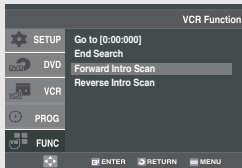

Basic Recording

You can record a TV show in progress by inserting a blank tape and pressing the REC button. You can even add time in 30-minute increments up to 4 hours by pressing the REC button repeatedly; see page 79.

Note

Be sure your videotape has a Record Safety Tab. If the tab is missing, you can cover the opening with a small piece of tape. Warning: Do not cover this opening unless you are sure you want to record over the tape.

Before You Begin...

- Power on the DVD-VCR
- Power on the TV

Protecting a Recorded Cassette

Video cassettes have a safety tab to prevent accidental erasure. When this tab has been removed, you cannot record on the tape.

If you wish to protect a cassette, break off the tab using a small screwdriver.

To re-record over a protected cassette (safety tab broken), cover the hole with adhesive tape.



Recording

1

Insert a blank VHS tape into the VCR deck. Make sure the tape is long enough to record the entire program. Press the **SPEED** button to set to the record speed. (See page 80)

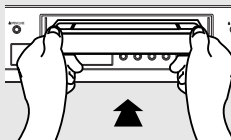

2

Use the Number buttons or the **CH ▲** or **▼** buttons to select the desired channel, or press the **INPUT SEL.** button to select **LINE** if recording from an external device connected to the front or rear jacks, respectively.

VCR OPERATIONS

3

Press the **REC** button on the remote control or front panel.

For options while recording is in progress, see "Special Recording Features" on this page.

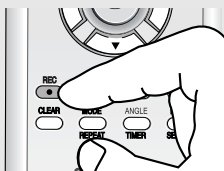

Note

Recording from the DVD-VCR to the VCR is not possible.

4

Pause/Resume Recording

Press the **▶||** (Play/Pause) button.

Press the **REC** button again to resume.



5

Stop Recording

Press the **■** (Stop) button.



Special Recording Features

While a recording is in progress, you can watch a different channel or a DVD, or add recording time in 30-minute increments.

To Watch a different Channel while Recording

Make sure that you connect the DVD-VCR to the TV using an RF cable.

- When you watching through the Antenna input during recording, press the TV/VCR button on the remote control. Using your TV remote control, change the channel you want to watch.
- When you watching through Line input during recording, change the input of your TV from Line to Antenna. Using your TV remote control, change the channel you want to watch.

VCR OPERATIONS

To Watch a DVD while Recording

Insert a DVD in the DVD tray and press the ►|| (Play/Pause). The output will automatically change to the DVD.

To Add Recording Time

See One-Touch Recording (OTR) below.

Using One-Touch Recording

One-Touch Recording (OTR) allows you to add recording time in 30-minute increments up to 4 hours at the touch of a button.

1

Insert a blank VHS tape into the VCR deck.

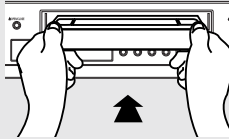

2

Use the Number buttons or the **CH ▲** or **▼** buttons to select the desired channel, or press the **INPUT SEL.** button to select **LINE** if recording from an external device connected to the front or rear jacks, respectively.

3

Press the **REC** button on the remote control or front panel.

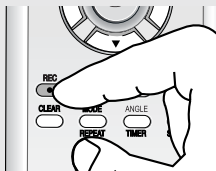

VCR OPERATIONS

4

While in Record mode, press the **REC** button again to activate One-Touch Recording (OTR).

Record length 0:30 appears on the On-screen display and the DVD-VCR will record for exactly 30 minutes.

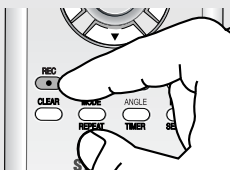

5

Add Recording Time

Continue pressing **REC** button to add recording time in 30 minute increments up to 4 hours.

The DVD-VCR stops recording automatically when the time has elapsed. The DVD-VCR will automatically be turned off when the OTR finished.

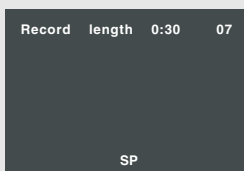

Selecting the Recording Speed

You can slow down the recording speed from SP to SLP in order to fit six hours of programming on a T-120 tape.

Press the **SPEED** button on the remote control to select the Record Speed.

- SP: Standard Play, for best quality.
- SLP: Super Long Play, for maximum recording time (3 times SP).

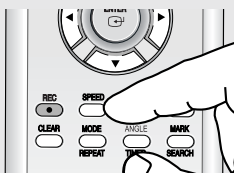

Note

The selected Record Speed will appear on the front panel display and on-screen display.

Maximum Recording Time - SP vs. SLP

Tape Length	SP (Standard Play)	SLP (Super Long Play)
T-120	2 hrs	6 hrs
T-160	2hrs 40 mins	8 hrs
T-180	3 hrs	9 hrs

Using a Timer Recording

Insert a blank videotape into the VCR deck. Be sure to leave the Record Safety Tab intact. With the Timer Recording function, you can program up to 7 events at a time to record up to a month in advance.

To Begin Setting the Timer Recording,

- Power On your DVD-VCR.
- Power On your TV.

1

Press the **MENU** button on the remote control.

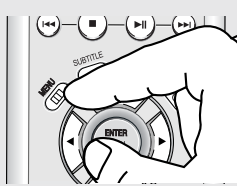

2

Press the **▲/▼** buttons to select **PROG**, then press the **▶** or **ENTER** button.

It can be displayed simply by pressing the **TIMER** button.

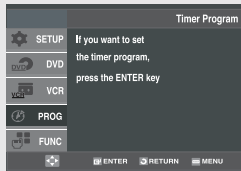

3

Select Channel Number

Press the **▶** button, then press the **▲/▼** buttons to set the channel.

Press the **▶** button to move to the next setting.

No	Ch	Start	End	Date	Speed
1	07	--:--	--:--	--/--	--
2	--	--:--	--:--	--/--	--
3	--	--:--	--:--	--/--	--
4	--	--:--	--:--	--/--	--
5	--	--:--	--:--	--/--	--
6	--	--:--	--:--	--/--	--
7	--	--:--	--:--	--/--	--

4

Set Time/Date/Speed

Repeat Step 3 above to set start time, end time, date and record speed.

Date can be set for one time, daily or weekly recording.

No	Ch	Start	End	Date	Speed
1	07	9:00am	11:00am	5/10	SP
2	--	--:--	--:--	--/--	--
3	--	--:--	--:--	--/--	--
4	--	--:--	--:--	--/--	--
5	--	--:--	--:--	--/--	--
6	--	--:--	--:--	--/--	--
7	--	--:--	--:--	--/--	--

Note

You can select external input directly (L1) using **INPUT SEL.** button.

VCR OPERATIONS

Selecting Auto Speed

If the length of the videotape is not long enough for a timer recording in the SP mode, set the recording tape speed to "Auto". Recording will start in the SP mode. If the length is not long enough, the tape speed will automatically change from SP mode to SLP mode.

Daily/Weekly Date Programming

Weekly [sun's~sat's]: Use this to record TV programs on the same channel at the same time every week. **Daily [MO - FR] :** Use this to record TV programs on the same channel at the same time every day Monday through Friday.

5

Save Timer Recording

Press the **RETURN** button to finish setting the timer recording.

Stop the DVD-VCR or turn the power off. Then the DVD-VCR will automatically turn on and begin recording at the time you set.

To stop the timer recording, press the **POWER** button or press the **■** (Stop) button twice.

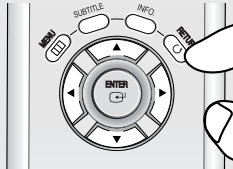

Chapter 6

REFERENCE

Using the TV Buttons on the Remote Control

Your DVD-VCR remote control will work with Samsung televisions and compatible brands.

To determine whether your television is compatible, follow the instructions below.

- 1 Switch your television on.
- 2 Point the remote control towards the television.
- 3 Hold down the TV button and enter the two-figure code corresponding to the brand of your television, by pressing the appropriate numeric buttons.

TV Codes	
BRAND	CODE
SAMSUNG	01, 14, 15, 23
DAEWOO	19
EMERSON	21
HITACHI	10
LG	06, 08, 18
LOEWE	28
MAGNAVOX	04
NEWSAN	27
NOBLEX	25
PANASONIC	12, 24
RCA	07, 29
SANYO	05, 20
SHARP	02, 16, 22
SONY	03
TELEFUNKEN	26
TOSHIBA	09
ZENITH	17

Note

- If your television is compatible with the remote control, it will switch off. It is now programmed to operate with the remote control.
- If several codes are indicated for your television brand, try each one in turn until you find one that works.

You can then control the television using the following buttons.

Button	Function
POWER	Used to switch the television on and off.
INPUT SEL.	Used to select an external source.
VOL + or -	Used to adjust the volume of the television.
CH (^ or v)	Used to select the required channel.
TV MUTE	Used to toggle the sound on and off.

The various functions will not necessarily work on all televisions. If you encounter problems, operate the television directly.

Troubleshooting

Before contacting a Samsung authorized service center, perform the following simple checks.

If you are unable to solve the problem after reading the above instructions, note:

- The model and serial number on the rear of your DVD-VCR
- The warranty information
- A clear description of the problem

Then contact your nearest SAMSUNG service center.

Identifying DVD Problems

Problem	Action	Page
No operations can be performed with the remote control.	<ul style="list-style-type: none"> • Check the batteries in the remote control. They may need replacing. • Operate the remote control at a distance of no more than 20 feet. • Remove batteries and hold down one or more buttons for several minutes to drain the microprocessor inside the remote control to reset it. Reinstall batteries and try to operate the remote control again. 	P3
Disc does not play.	<ul style="list-style-type: none"> • Ensure that the disc is installed with the label side facing up. • Check the region number of the DVD. 	P7
5.1 channel sound is not being reproduced.	<ul style="list-style-type: none"> • 5.1 channel sound is reproduced only when the following conditions are met.: <ol style="list-style-type: none"> 1) The DVD-VCR is connected with the proper Amplifier 2) The disc is recorded with 5.1 channel sound. • Check whether the disc being played has the “5.1 ch” mark on the outside. • Check if your audio system is connected and working properly. • In a DVD Setup Menu, is the Audio Output set to Bitstream? 	P20
The  icon appears on screen.	<ul style="list-style-type: none"> • The features or action cannot be completed at this time because: <ol style="list-style-type: none"> 1. The DVD's software restricts it. 2. The DVD's software doesn't support the feature (e.g., angles). 3. The feature is not available at the moment. 4. You've requested a title or chapter number or search time that is out of range. 	-
Disc Menu doesn't appear.	<ul style="list-style-type: none"> • Check if the disc has a Menu. 	-
Play mode differs from the Setup Menu selection.	<ul style="list-style-type: none"> • Some of the functions selected in the Setup Menu may not work properly if the disc is not encoded with the corresponding function. 	-
The screen ratio cannot be changed.	<ul style="list-style-type: none"> • The Screen Ratio is fixed on your DVDs. 	P41~42
No audio.	<ul style="list-style-type: none"> • Make sure you have selected the correct Digital Output in the Audio Options Menu. 	P57~58

REFERENCE

Problem	Action	Page
The screen is blocked	<ul style="list-style-type: none"> Press the HDMI/CH (V) buttons simultaneously for more than 5 seconds with no disc in the unit. All settings will revert to the factory settings. 	-
Forgot password	<ul style="list-style-type: none"> Press the HDMI/CH (V) buttons simultaneously for more than 5 seconds with no disc in the unit. All settings including the password will revert to the factory settings. Don't use this unless absolutely necessary. 	P62-64
If you experience other problems.	<ul style="list-style-type: none"> Go to the contents and find the section of the instruction book that contains the explanations regarding the current problem, and follow the procedure once again. If the problem still cannot be solved, please contact your nearest authorised service center. 	
The picture is noisy or distorted	<ul style="list-style-type: none"> Make sure that the disc is not dirty or scratched. Clean the disc. 	

Identifying VCR Problems

Problem	Action	Page
No power	<ul style="list-style-type: none"> Check that the power plug is connected to a wall outlet. 	-
You cannot insert a video cassette	<ul style="list-style-type: none"> A video cassette can only be inserted with the window side up and the safety tab facing you. 	P65
The television program was not recorded	<ul style="list-style-type: none"> Check the DVD-VCR antenna/cable connections. Is the DVD-VCR tuner properly set? Check if the safety tab is intact on the cassette. 	-
Timer recording was unsuccessful	<ul style="list-style-type: none"> Re-check the recording start/stop time settings. If there was a power failure or interruption during timer recording, the recording will have been cancelled. 	P81-82
No playback picture or the picture is distorted	<ul style="list-style-type: none"> Check to see if you are using a prerecorded tape. 	P77
You cannot see normal broadcasts	<ul style="list-style-type: none"> Check the tuner or external setting. It should be on tuner. Check the TV or VCR antenna connections. 	-
Noise bars or streaks on playback	<ul style="list-style-type: none"> Press the TRK buttons to minimize this effect. 	P68
When the ►II button is pressed during playback, the still picture has severe "noise bars" streaks	<ul style="list-style-type: none"> A still picture may have "noise bars", depending on the condition of the tape. Press the TRK buttons during slow motion to minimize this effect. 	-
Video Head Cleaning	<ul style="list-style-type: none"> If poor pictures appear on a variety of cassettes, the video heads may need cleaning. This is not a common problem and unless it appears, the heads should not be cleaned. When cleaning the video heads, read all instructions provided with the head cleaning cassette. Incorrect head cleaning can permanently damage the video heads. 	-

Technical Specifications

Inputs	AUDIO	1 Stereo audio inputs, RCA Connector, -8dbm, 47K Ω , front and rear
	VIDEO	1 Composite video inputs, RCA Connector, 75 Ω , 1Vp-p
	RF	Antenna or CATV Input, F-Connector, 75 Ω
Outputs	AUDIO	1 Stereo audio outputs, RCA Connector, -8dbm, 1.5K Ω
	AUDIO (DVD only)	1 Digital audio output (1 coaxial) 1 pair Stereo audio outputs, Optical
	VIDEO	1 Composite video output, RCA Connector, 75 Ω , 1Vp-p
	VIDEO (DVD only)	1 S-Video output, S-Connector, 75 Ω , Y=1.0Vp-p, C=0.286Vp-p
		1 Component video output, 75 Ω , Y=1.0Vp-p, Pb=0.7Vp-p, Pr=0.7Vp-p
HDMI	480p, 720p, 768p, 1080i	
VCR	RF	Channel 3 or 4
	VIDEO SYSTEM	1/2-inch VHS system, 4 rotary head helical scanning; FM azimuth luminance;chrominance: converted sub system phase shift
	AUDIO TRACK	Normal: 1 track; Hi-Fi: 2 track
	PLAY/RECORD TIME	T-180 tape: SP 3 hours, SLP 9 hours
	FF/REW TIME	T-120 tape: <2 minutes
	HEADS	Video: DA 4 rotary Audio: 2 rotary heads (Hi-Fi); 1 stationary head (Linear) Control: 1 stationary head Erase: 1 full track, 1 audio track
	WOW & FLUTTER	Less than 0.005% (Hi-Fi)
	FREQ. RESPONSE	20-20,000 Hz (Hi-Fi)
DVD	DISC COMPATIBILITY	CD, CD-R, CD-RW DVD-Video, CD-Digital Audio (5" and 3.5")
	FREQ. RESPONSE	96/48 kHz Sampling: 4 Hz-22kHz
	S/N RATIO	110 dB
	DYNAMIC RANGE	96 dB
	THD	0.003 %
SYSTEM	POWER REQUIREMENT	120V AC, 60 Hz, 25 watts
	ENVIRONMENT	41-104° F (5-40° C); 10%-75% humidity
	WEIGHT	13.8 lbs.

- Samsung Electronics Co., Ltd reserves the right to change the specifications with out notice.
- Weight and dimensions are approximate.

MEMO

Warranty

LIMITED WARRANTY TO ORIGINAL PURCHASER

THIS SAMSUNG BRAND PRODUCT, AS SUPPLIED AND DISTRIBUTED BY SAMSUNG ELECTRONICS AMERICA, INC. (SAMSUNG) AND DELIVERED NEW, IN THE ORIGINAL CARTON TO THE ORIGINAL CONSUMER PURCHASER, IS WARRANTED BY SAMSUNG AGAINST MANUFACTURING DEFECTS IN MATERIALS AND WORKMANSHIP FOR THE FOLLOWING LIMITED WARRANTY PERIOD:

One (1) Year Parts / Ninety (90) days Labor

This limited warranty begins on the original date of purchase, and is valid only on products purchased and used in the United States, and does not include transportation, installation, removal or reinstallation. WARRANTY REPAIRS MUST BE PERFORMED BY SAMSUNG'S AUTHORIZED SERVICE CENTER. TO RECEIVE WARRANTY SERVICE, THE ORIGINAL DATED BILL OF SALE MUST BE PRESENTED UPON REQUEST AS PROOF OF PURCHASE TO SAMSUNG OR SAMSUNG'S AUTHORIZED SERVICE CENTER. TRANSPORTATION TO AND FROM THE SERVICE CENTER IS THE RESPONSIBILITY OF THE PURCHASER.

SAMSUNG WILL REPAIR OR REPLACE THIS PRODUCT, AT OUR OPTION AND AT NO CHARGE WITH NEW OR RECONDITIONED PARTS, IF FOUND TO BE DEFECTIVE DURING THE LIMITED WARRANTY PERIOD SPECIFIED ABOVE. The product must be returned during the warranty period with transportation charges prepaid to SAMSUNG's designated service center. Prior to returning any product for warranty service, the purchaser must contact SAMSUNG for problem determination and service procedures. SAMSUNG DOES NOT WARRANT UNINTERRUPTED OR ERROR-FREE OPERATION OF THE PRODUCT. All replaced parts and products become the property of SAMSUNG and must be returned to SAMSUNG. Replacement parts and products assume the remaining original warranty, or ninety (90) days, whichever is longer.

This limited warranty covers manufacturing defects in materials and workmanship encountered in normal, noncommercial use of this product and shall not apply to the following, including, but not limited to: damage which occurs in shipment; applications and uses for which this product was not intended; failures or problems which are caused by products or equipment not supplied by SAMSUNG; accidents, misuse, abuse, neglect, misapplication, fire, water, lightning or other acts of nature; incorrect electrical line voltage, fluctuations or surges; damage caused by improper or faulty installation; improper connection with any peripheral; product alteration or modification; improper or unauthorized repair; cosmetic damage or exterior finish; product with altered serial numbers; failure to follow operating instructions, customer adjustments, maintenance and environmental instructions that are covered and prescribed in the instruction book; use of non-SAMSUNG or unauthorized parts, supplies, accessories or equipment which damage this product or result in service problems; failures or problems due to incompatibility with other equipment.



ELECTRONICS

HEADQUARTERS
105 Challenger Road
Ridgefield Park, NJ 07660-0511
TEL: 1-800-SAMSUNG

SERVICE DIVISION
400 Valley Road, Suite 201
Mount Arlington, NJ 07856
1-800-SAMSUNG (1-800-726-7864)
www.samsung.com

AK68-00742A-00