

# Quick Setup Guide

To register this product please visit  
[www.samsung.com/register](http://www.samsung.com/register).

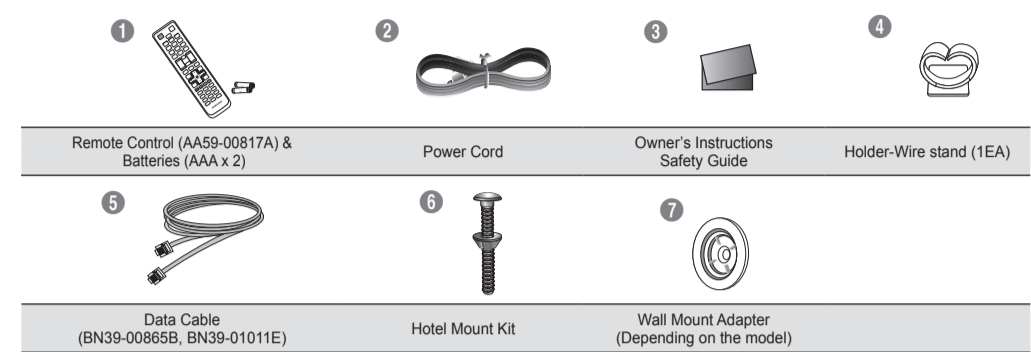

## List of Parts



## Installing the LED TV Stand

◆ HG40ND470S / HG40ND477S / HG43ND470S / HG43ND477S / HG50ND470S / HG50ND477S

### Components

When installing the stand, use the provided components and parts.

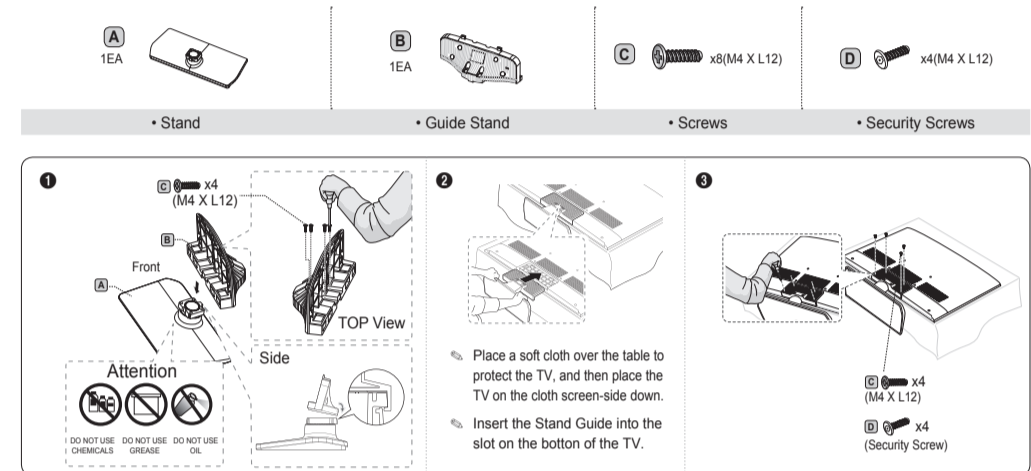

- Make sure to distinguish between the front and back of the Stand and Stand Guide when connecting them.
- Make sure that at least two people lift and move the LED TV.
- When connecting the stand, lay the product down on a soft surface, with the screen facing down, and then fasten the screws.
- The number of screws may differ depending on the model.



### UI Scenario

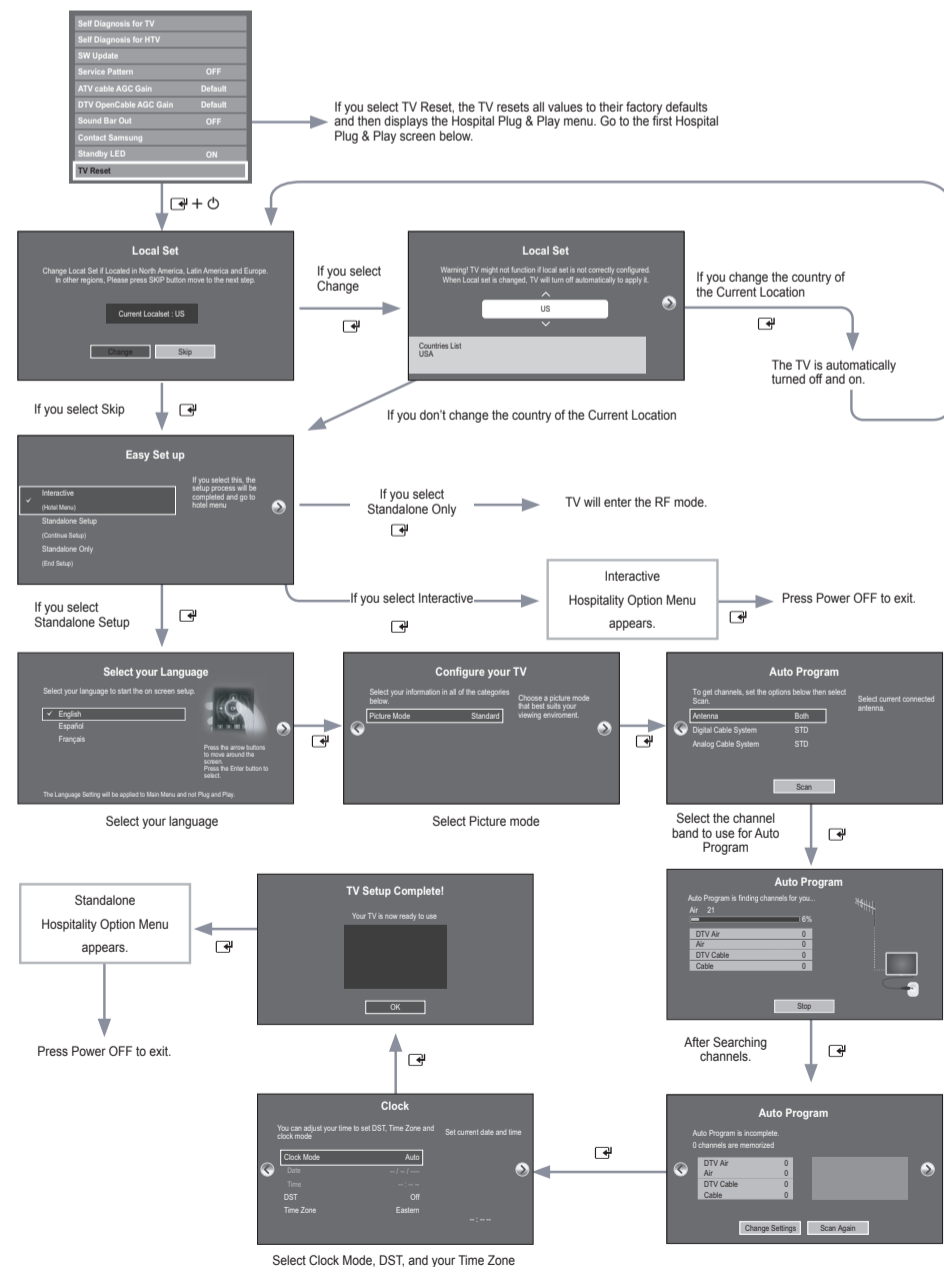

### Assembling the swivel

The 40" and larger LED TVs have swivel stands. You can set these stands so that the TV swivels 20 degrees left and right, 60 degrees left and right, or 90 degrees left and right.

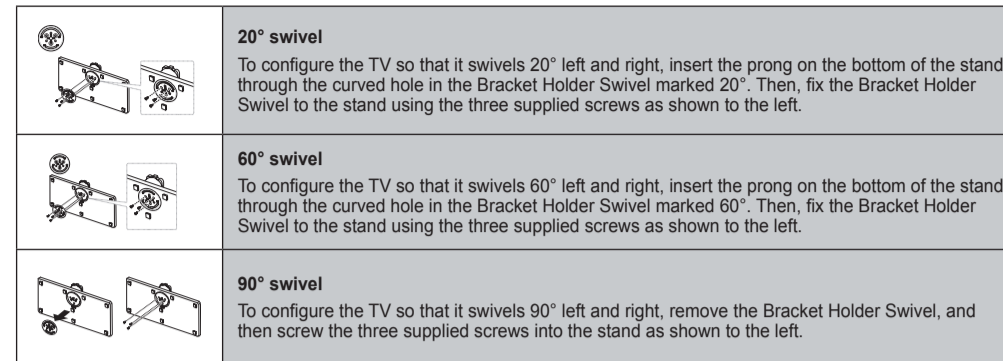

### Hotel Mount Kit

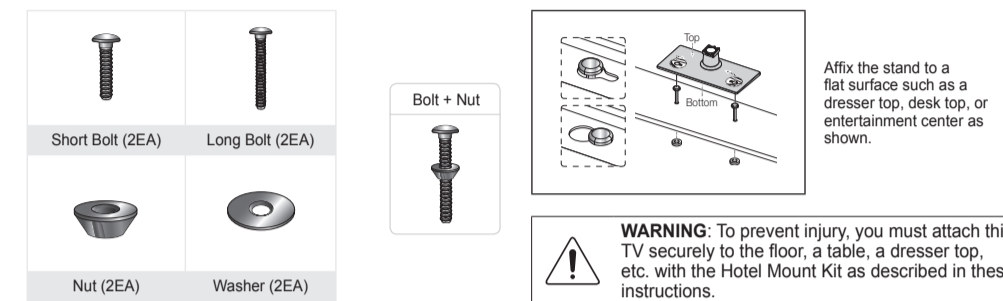

## TV Controller

The TV's Controller on the bottom right side of the TV, lets you control the TV without the remote control.

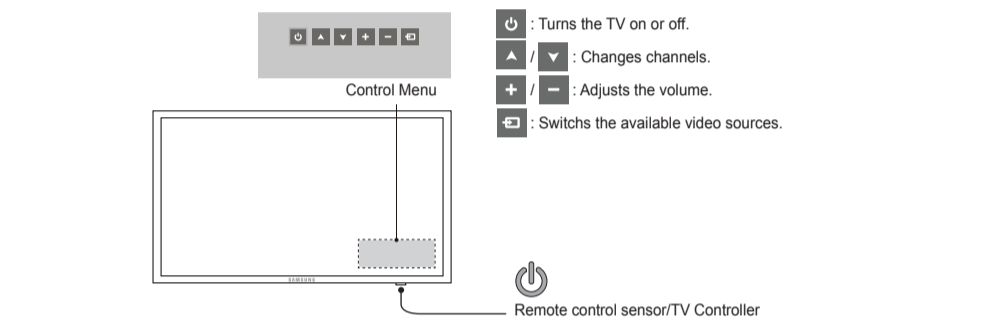

- If you press it first, the control menu appears. You can select the function by pressing and holding the TV's controller.
- The product color and shape may vary depending on the model.
- With the TV's Controller, you cannot perform other operations except for turning the TV on or off, changing the channel, adjusting the volume, and switching the input source.

### Standby mode

Your TV enters Standby mode when you turn it off and continues to consume a small amount of electric power. To be safe and decrease power consumption, do not leave your TV in standby mode for long periods of time (when you are away on vacation, for example). It is best to unplug the power cord.

## Wall Mount Kit Specifications (VESA)

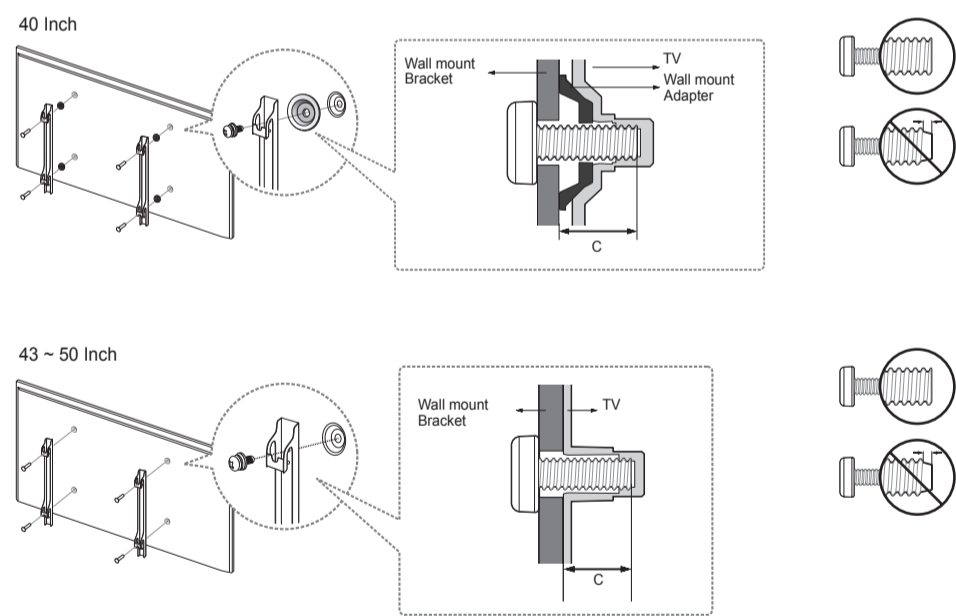

Install your wall mount on a solid wall perpendicular to the floor. If you are attaching the wall mount to building materials other than plaster board, contact your nearest dealer. If installed on a ceiling or slanted wall, the TV may fall and cause severe personal injury.

- Standard dimensions for wall mount kits are shown in the table below.
- Samsung wall mount kits contain a detailed installation manual. All parts necessary for assembly are provided.
- Do not use screws that do not comply with the VESA standard screw specifications.
- Do not use screws that are longer than the standard dimension or do not comply with the VESA standard screw specifications. Screws that are too long may cause damage to the inside of the TV set.
- For wall mounts that do not comply with the VESA standard screw specifications, the length of the screws may differ depending on the wall mount specifications.
- Do not fasten the screws too firmly. This may damage the product or cause the product to fall, leading to personal injury. Samsung is not liable for these kinds of accidents.
- Samsung is not liable for product damage or personal injury when a non-VESA or non-specified wall mount is used or the consumer fails to follow the product installation instructions.
- Do not mount the TV at more than a 15 degree tilt.
- Always have two people mount the TV onto a wall.

Product Family	TV size in inches	VESA screw hole specs (A * B) in millimeters	C (mm)	Standard Screw	Quantity
LED-TV	40	200 x 200	32.5 ~ 33.5	M8	4
	43 - 50		21.5 ~ 22.5		

Do not install your Wall Mount Kit while your TV is turned on. This may result in personal injury due to electric shock.

## Viewing the Connection Panel

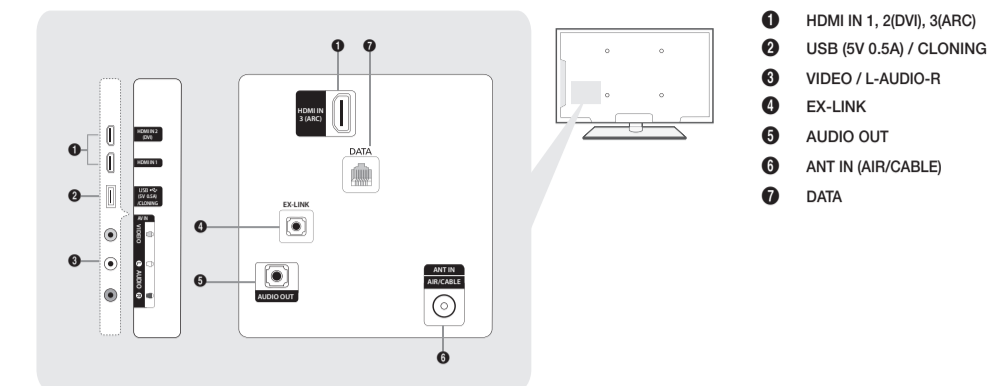

The product color and shape may vary depending on the model.

Notice When in Hotel mode (Interactive or Standalone), all Channel menu items in the Menu OSD except for the Channel List are deactivated. If you need to change the channel line up, use the Channel Setup item in the Hotel options menu.

## Sound Bar

### Samsung Sound-Bars and Hotel TVs in 2015

- Samsung Sound-Bars and hospitality TVs support the ARC feature in HDMI 1.4. If you connect a compatible Samsung Sound-Bar to a compatible Samsung hospitality TV using a single HDMI cable, guests can listen to the TV's sound through the Sound-Bar.
- The item of Sound bar Out in Hospitality Option Menu makes you control to where the TV sound is outputted when the TV is turned on.
- If Sound bar Out is On, the TV sound is automatically outputted in the Sound Bar device only whenever TV is turned on.
- If Sound bar Out is Off, the TV sound is automatically outputted in the TV speaker only whenever TV is turned on.
- Models supporting the ARC function are listed below:
  - Sound-Bars: HW-E350/E450/E550
  - HW-F350/F355/FM35/F450/FM45/FM45C/ F550/F551/FM55/FM55C/F750/F75
- Setting the Sound-Bar to Hotel Mode.
  - Set the following Hotel menu options:
    - Hotel option > System > Sound Bar Out = On.
    - Hotel option > Power On > Power On Volume = User Defined.
    - Hotel option > Power On > Power On Volume Num > Set greater than 0.
    - Hotel option > Power On > Max Volume > Set greater than 0.
  - Connect an HDMI cable from the HDMI OUT jack at the back of the Sound-Bar to the HDMI3 port (supporting ARC) on the hospitality TV.
  - After the Sound-Bar is connected to the hospitality TV, when the TV turns on, the Sound-Bar automatically detects the TV, and then automatically switches to Hotel Mode.

### Sound Bar Hotel mode functional characteristics:

- Power On/Off is synchronized with the TV
- HDMI\_CEC defaults to On
- Functions through the 'HDMI OUT' port only
- Disables the 'Input mode' key on the VFD to prevent unexpected audio-source changes.
- Acquires adjustable Power On and Max Volume settings from the TV's Hotel option menu. The Sound-Bar's Power On Volume and Max Volume values, however, are 1/2 of the Power On Volume and Max Volume settings in the TV's Hotel options menu.
- Example: If the TV's Power On Volume=20 and Max Volume=90, then the Sound Bar's Power On Volume=10 and Max Volume=45.

## License

**DOLBY DIGITAL PLUS** Manufactured under license from Dolby Laboratories. Dolby and the double-D symbol are trademarks of Dolby Laboratories.

**dts Premium Sound | 5.1** Manufactured under a license from U.S. Patent No's: 5,956,674, 5,974,380, 5,978,762, 6,487,535, 6,226,616, 7,212,872, 7,003,467, 7,272,567, 7,668,723, 7,392,195, 7,930,184, 7,333,929 and 7,548,853. DTS, the Symbol, and DTS and the Symbol together are registered trademarks & DTS Premium Sound is a trademark of DTS, Inc. ©2012 DTS, Inc. All Rights Reserved.

**dts Studio Sound** Manufactured under a license from U.S. Patent No's: 6,285,767, 8,027,477, 5,319,713, 5,333,201, 5,638,452, 5,771,295, 5,970,152, 5,912,976, 7,200,236, 7,492,907, 8,050,434, 7,720,240, 7,031,474, 7,907,736 and 7,764,802. DTS, the Symbol, and DTS and the Symbol together are registered trademarks & DTS Studio Sound is a trademark of DTS, Inc. ©2012 DTS, Inc. All Rights Reserved.

**HDMI** The terms HDMI and HDMI High-Definition Multimedia Interface, and the HDMI Logo are trademarks or registered trademarks of HDMI Licensing LLC in the United States and other countries.

**DivX HD** DivX Certified® to play DivX® video up to HD 1080p, including premium content.

ABOUT DIVX VIDEO: DivX® is a digital video format created by DivX, LLC, a subsidiary of Rovi Corporation. This is an official DivX Certified® device that has passed rigorous testing to verify that it plays DivX video. Visit [divx.com](http://divx.com) for more information and software tools to convert your files into DivX videos.

ABOUT DIVX VIDEO-ON-DEMAND: This DivX Certified® device must be registered in order to play purchased DivX Video-on-Demand (VOD) movies.

To obtain your registration code, locate the DivX VOD section in your device setup menu. Go to [vod.divx.com](http://vod.divx.com) for more information on how to complete your registration.

DivX®, DivX Certified® and associated logos are trademarks of Rovi Corporation or its subsidiaries and are used under license.

Covered by one or more of the following U.S. patents: 7,295,673; 7,460,668; 7,515,710; 7,519,274

**Open Source License Notice**  
 Open Source used in this product can be found on the following webpage. (<http://opensource.samsung.com>)  
 Open Source License Notice is written only English.

## Connecting the TV with an SBB or STB

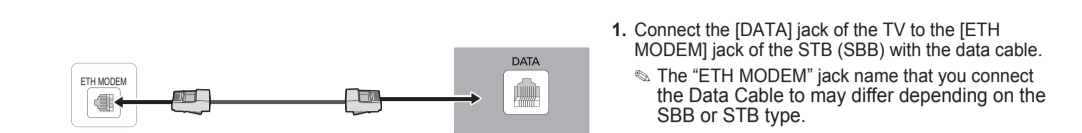

### List of Vendors and Compatible Data Cables Supplied with the TV

Vendor	Cable code
Samsung OCC	BN39-00865B
Enseo Guest-Tek	BN39-01011B
NXTV	BN39-01110A
NStreams	BN39-01110A
MTI	BN39-01011C

## Hotel Plug & Play

The Hospital Plug & Play function, which automatically performs the Hospital Mode selection, Country Setup, Clock Setup, and Picture Mode Setup, runs once when power is first turned ON. Setup also runs automatically after you have executed a Service Reset.

### Local Set

- Initially highlighted: US
- If you press the Enter key after selecting Change, you can change the country.
- If the country is changed, the TV automatically turns off and on.
- If you select the incorrect country, execute TV Reset again after entering the Service section of the Hospital Menu.

### Easy Set up OSD

- Initially highlighted: Interactive
- If you select the Standalone Only button, Standalone hospital mode is set by default and the "Standalone mode has been set" OSD appears for 3 seconds.
- TV enters into RF mode automatically after displaying the "Standalone mode has been set" OSD for 3 seconds.
- If you select Interactive mode, the Interactive Setup Menu is displayed. Press the power off key to exit the Interactive menu.
- If you select Standalone setup mode, the "Select your Language" OSD appears.

### Select Menu Language OSD

- If you select Standalone setup from the "Select Hospital TV Mode" OSD, the "Select Menu Language" OSD appears.
- Initially highlighted: English
- Display time: OSD time out and operation are the same as Samsung's consumer TV models.
- If you press the Enter key, the "Picture Mode" OSD appears.

### Configure your TV OSD

- Initially highlighted: Standard.
- The TV displays the Picture Mode OSD where you can choose Dynamic or Standard Picture mode.

### Auto Program OSD

- If you press the Enter key, the TV automatically searches for channels.
- After the automatically searches for channels complete, press the next button to continue.

### Set Clock Mode, DST (Daylight saving time), and TimeZone OSD

- Initially highlighted: Clock Mode : Auto, DST : Off, TimeZone : Eastern
- If the TV will be tuned to digital broadcast channels, and these channels transmit date and time information, set the Clock Mode to Auto. The TV will set the date and time automatically.
- If the TV will not be tuned to digital broadcast channels, set the Clock Mode to Manual, and then set the date and time on the TV manually.
- Set DST On or Off to apply or not apply daylight saving time to the TV.
- Select your time zone on the map appears.

## Dimensions

HG40ND470S / HG40ND477S / HG43ND470S / HG43ND477S / HG50ND470S / HG50ND477S

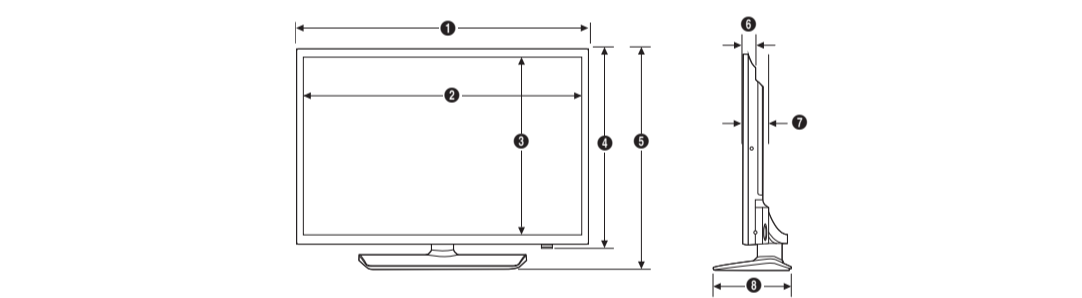

	①	②	③	④	⑤	⑥	⑦	⑧
HG40ND470S	922.7	880.1	487.4	530.7	582.3	40.5	72.0	226.5
HG40ND477S	985.5	942.9	531.3	575.3	624.2	40.5	72.2	226.5
HG43ND470S	1140.8	1097.8	618.4	662.3	713.9	41.6	72.9	226.5
HG43ND477S								

(unit: mm)

## Specifications

Environmental considerations			
Operating Temperature	50°F to 104°F (10°C to 40°C)		
Operating Humidity	10% to 80%, non-condensing		
Storage Temperature	-4°F to 113°F (-20°C to 45°C)		
Storage Humidity	5% to 95%, non-condensing		
Model Name	HG40ND470S / HG40ND477S	HG43ND470S / HG43ND477S	HG50ND470S / HG50ND477S
Display Resolution	1920 x 1080		
Screen Size (Diagonal)	40" Class (39.5" measured diagonally)	43" Class (42.5" measured diagonally)	50" Class (49.5" measured diagonally)
Sound (Output)	10W x 2		
Dimensions (WxDxH)			
Body	922.7 x 72.0 x 530.7 mm	985.5 x 72.2 x 575.3 mm	1140.8 x 72.9 x 662.3 mm
With stand	922.7 x 226.5 x 582.3 mm	985.5 x 226.5 x 624.2 mm	1140.8 x 226.5 x 713.9 mm
Weight			
Without Stand	6.53 kg	7.71 kg	10.50 kg
With Stand	9.47 kg	10.65 kg	13.44 kg
Stand Swivel (Left / Right)	20° / 60° / 90°		

- Design and specifications are subject to change without prior notice.
- This device is a Class B digital apparatus.

**WARNING:** This product contains chemicals known to the State of California to cause cancer and reproductive toxicity.