

SAMSUNG

SAMSUNG

DLPTV  DLPTV



**1-800-SAMSUNG (1-800-726-7864)**

**Samsung Electronics America  
Service Division**

400 Valley Road, Suite 201  
Mount Arlington, NJ 07856  
[www.samsungusa.com](http://www.samsungusa.com)

**Samsung Electronics Canada Inc.  
Samsung Customer Care**

7037 Financial Drive  
Mississauga, Ontario  
L5N 6R3  
[www.samsung.ca](http://www.samsung.ca)

BP68-00283A-00

**I N S T R U C T I O N   M A N U A L**

HLP4663W/HLP5063W/HLP6163W

**This device is a Class B digital apparatus.**

## Table of Contents

Your New Wide TV .....	6
Replacing the Lamp .....	6
List of Features .....	8
Accessories .....	8
Side Panel Buttons .....	9
Side Panel Jacks .....	9
Front Panel LED Indicators .....	10
Rear Panel Jacks .....	11
Remote Control .....	12
Installing Batteries in the Remote Control .....	13
Connections .....	16
Connecting VHF and UHF Antennas .....	16
Antennas with 300-ohm Flat Twin Leads .....	16
Antennas with 75-ohm Round Leads .....	16
Separate VHF and UHF Antennas .....	17
Connecting Cable TV and VCR .....	18
Cable without a Cable Box .....	18
Cable with a Cable Box that Descrambles All Channels .....	18
Connecting a Cable Converter Box .....	19
Connecting a Cable Converter Box and a VCR .....	19
Connecting a Camcorder .....	20
Connecting a DVD Player .....	21
Connecting to Y,Pb,Pr .....	21
Connecting to Audio and Video Jacks .....	21
Connecting a DTV Set-Top Box .....	22
Connecting to Y,Pb,Pr .....	22
Connecting to DVI (Digital Visual Interface) .....	22
Connecting to HDMI (High Definition Multimedia Interface) .....	23
Connecting to R,G,B .....	23
Operation .....	26
Turning the TV On and Off .....	26
Viewing the Menus and On-Screen Displays .....	26
Selecting the Menu Language .....	27
Selecting the Antenna Input .....	27
Memorizing the Channels .....	28
Adding and Erasing Channels .....	29
Changing Channels .....	30
Selecting Your Favorite Channels .....	31
Scanning the Channels .....	32
Labeling the Channels .....	33
Picture Control .....	34
Sound Control .....	36
Setting the Clock .....	38
Setting the Timers .....	39
Viewing an External Signal Source .....	41
Assigning Names to External Input Mode .....	42
Freezing the Current Picture .....	43
Remote Control VCR/DVD Buttons .....	43

Special Features .....	46
Customizing Your Remote Control .....	46
Remote Control Codes .....	47
Fine Tuning Channels .....	48
LNA (Low Noise Amplifier) .....	49
Selecting the Color Tone .....	50
Changing the Picture Size .....	51
Digital Noise Reduction .....	52
DNIe™ (Digital Natural Image engine) [DNIe] .....	53
Setting the MCC (My Color Control) Mode .....	54
Setting the Film Mode .....	56
Viewing Picture-In-Picture .....	57
Activating the PIP .....	57
Selecting an External Source .....	58
Swapping the Sub Picture and Main Picture .....	59
Changing the Size of the Sub Picture .....	60
Changing the Location of the Sub Picture .....	61
Selecting a Signal Source for the Sub Picture .....	62
Changing the Channel of the Sub Picture .....	63
Selecting the Sound Source .....	64
Setting the SRS TSXT .....	65
Choosing a Multi-Channel Sound (MTS) track .....	66
Auto Volume .....	67
Using the V-Chip (USA) .....	68
Viewing Closed Caption Information .....	74
Setting the Blue Screen Mode .....	76
Setting The On/Off Melody .....	77
Using the Color Weakness Assistant Feature .....	78
PC Display .....	80
Using Your TV as a Computer (PC) Display .....	80
How to Connect Your PC to the TV .....	80
Setting up Your PC Software (Based on Windows 98) .....	81
Display Modes .....	82
Adjusting the Picture Quality .....	83
Changing the Picture Position .....	84
Adjusting the Picture Quality and Position Automatically .....	85
Initializing the Picture Settings .....	86
Changing the Picture Size (PC Mode) .....	87
Appendix .....	90
Troubleshooting .....	90
Cleaning and Maintaining Your TV .....	91
Using Your TV in Another Country .....	91
Specifications .....	91

SAMSUNG

**Your New Wide TV**

## Your New Wide TV

### Replacing the Lamp

- **Why do I need to replace the lamp?**

The lamp used in a projection TV has a limited lifespan. For the best screen quality it needs to be replaced periodically. After replacing the lamp, the screen quality will be bright and clear as new.

- **When do I need to replace it?**

It should be replaced when the screen becomes darker, less clear or when all three LEDs on the front (Timer, Lamp, & Temp.) are flashing.

- **Check before lamp replacement**

1. The lamp must be the same code number and type.
2. The lamp type is indicated on the right side of the TV. It is also indicated on the lamp case.
3. After checking the code number for the lamp, give the code number to the store where you purchased the TV or to a Samsung Service center.

- **Caution**

1. Replace with the correct code numbered lamp to avoid damage to the TV.
2. Turn the power off and wait for 30 minutes before replacing the lamp as it will be hot.
3. Do not touch the glass part of the lamp with your bare hands nor insert any foreign object inside the cover as it may cause poor screen quality, electric shock or fire.
4. Do not place the old lamp near flammable objects or within the reach of children.

- For replacement, you will need a 5.91 Inches-long Phillips screwdriver and a pair of gloves.

- 1 Unplug TV, then use a screwdriver to remove the screw.

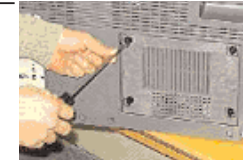

- 2 Remove the Lamp cover.



- 3 Remove the screws securing the Lamp by hand.

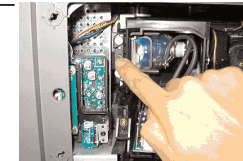

- 4 Separate the Lamp from the engine by holding the handle and pulling it out.



- 5 To reinstall the Lamp, follow these steps in reverse order.

#### NOTES

- Be sure the replacement Lamp is the same type.
- After replacing the lamp, align the lamp cover with the groove and secure the screw.
- The TV will not turn on if the lamp cover is not correctly closed (as this will activate the protective circuit).

## Your New Wide TV

### List of Features

Your TV was designed and engineered using the latest technology. It is a full-featured, high-performance unit that exceeds industry standards. In addition, it has these special features:

- Easy-to-operate remote control
- Easy-to-use on-screen menu system you can access from the side panel or remote control
- Automatic timer to turn the TV on and off at any time you choose
- Adjustable picture and sound settings and the ability to memorize your favorite settings
- Automatic channel tuning for up to 181 channels
- A special filter to reduce or eliminate reception problems
- Fine tuning control for the sharpest picture possible
- A built-in multi-channel sound decoder for stereo and bilingual listening
- Built-in, dual channel speakers
- A special sleep timer
- Picture-in-Picture capability that lets you watch two channels at once
- Widescreen TV with adjustable image size
- Life-like clear images provided by DNLe technology
- MCC (My Color Control) Mode for corresponding with your color style
- Color weakness Mode

### Accessories

Once you have unpacked your TV, check to make sure that you have all the parts shown here. If any piece is missing or broken, call your dealer.



**Remote Control**  
**(BP59-00048A)/**  
**AAA Batteries**  
**(4301-000121)**



**Audio/Video Cable**  
**(AA39-40001B)**



**Instruction Manual/  
Safety Guide Manual/  
Quick Guide Manual**



**Warranty Cards (2)/  
Registration Card (1)**

### Side Panel Buttons

The buttons on the side panel control your TV's basic features, including the on-screen menu system. To use the more advanced features, you must use the remote control.

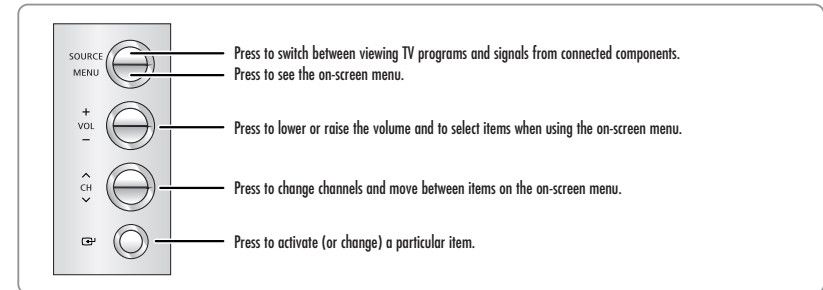

### Side Panel Jacks

Use the side panel jacks to connect a component that is used only occasionally (a camcorder or video game, for example).

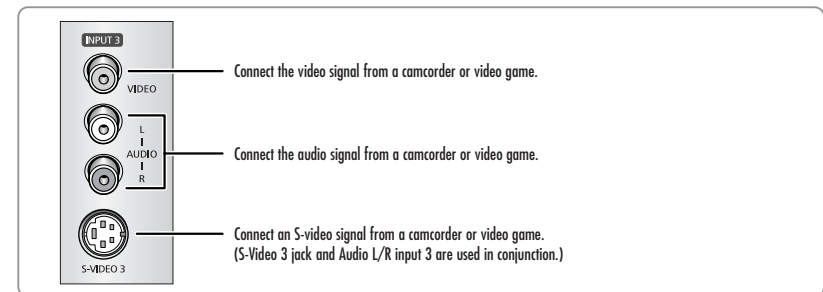

## Your New Wide TV

### Front Panel LED Indicators

The three lights on the front panel indicate the status of your TV.

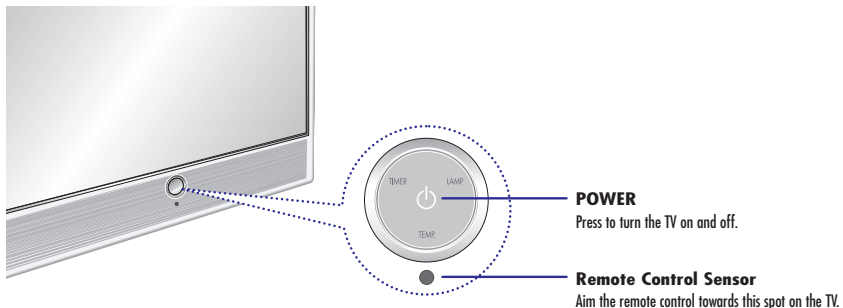

- : Light is On
- ◐ : Light is Blinking
- : Light is Off

Timer	Lamp	Temp	Indication
●	○	○	Auto Timer ON/OFF has been set.
○	◐	○	Standby state. The picture will automatically appear in about <b>15 seconds</b> .
●	◐	○	Auto Timer ON/OFF has been set and the set will automatically be turned on in about <b>25 seconds</b> .
◐	○	◐	A cooling fan inside the set is not operating normally.
○	◐	◐	Lamp cover on rear of the set is not properly shut.
○	○	◐	Check if the ventilation hole on the rear of the set is blocked, because if the inner temperature is too high, the power will shut off.
◐	◐	◐	Lamp may be defective. Please contact a certified technician.

- It takes about **30 seconds** for the TV to warm up, so normal brightness may not appear immediately.
- The TV has a fan to keep the inside lamp from overheating. You'll occasionally hear it working.

### Rear Panel Jacks

Use the rear panel jacks to connect components such as a VCR. You can connect different components such as VCRs, Set-Top Box and a DVD player etc., because there are two sets of video input jacks and three set of component video input jacks on the rear panel of your TV. For more information, please see "Connections".

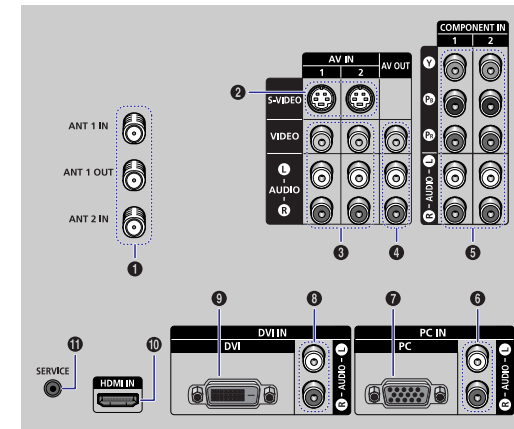

- 1 ANTENNA terminals**  
Two independent cables or antennas can be connected to these terminals. Use "ANT 1 IN" and "ANT 2 IN" terminals to receive a signal from VHF/UHF antennas or your cable system. Use the "ANT 1 OUT" terminal to send the signal being received by the "ANT 1 IN" terminal out to another component (such as a Cable Set-Top Box). The PIP channel can be received only when a signal source is connected to "ANT 1 IN".
- 2 S-VIDEO INPUT jacks**  
Connects an S-Video signal from an S-VHS VCR or DVD player.
- 3 VIDEO/AUDIO INPUT jacks (VCR1, VCR2)**  
Connect video/audio signals from external sources, such as a VCR or DVD players.
- 4 VIDEO/AUDIO OUTPUT jacks**  
Sends a video signal from the TV to an external source, such as a VCR.  
Note: It is available only in RF, Video and S-Video modes.
- 5 Component 1, 2 jacks (Y, PB, PR, L, R)**  
Use these jacks to connect the component video/audio signals from a DVD player or a set top box when using the component video input jacks.
- 6 PC AUDIO INPUT jacks**  
Connect these to the audio output jacks on your PC.
- 7 PC VIDEO INPUT jack**  
Connect these to the video output jack on your PC.
- 8 DVI (Digital Video Interface) AUDIO INPUT jacks**  
Connect to the digital audio output jacks for device with DVI output.
- 9 DVI (Digital Video Interface) VIDEO INPUT jack**  
Connect to the digital video output jack for device with DVI output.
- 10 HDMI (High Definition Multimedia Interface) VIDEO/AUDIO INPUT jack**  
Connect to the HDMI jack for device with HDMI output.
- 11 SERVICE**  
This jack is for repair and software upgrades.

## Your New Wide TV

### Remote Control

You can use the remote control up to about 23 feet from the TV. When using the remote control, always point it directly at the TV. You can also use your remote control to operate your Set-Top box, VCR, Cable box or DVD player. See pages 46-47 for details.

- 1. POWER**  
Turns the TV on and off.
- 2. S.MODE**  
Adjust the TV sound by selecting one of the preset factory settings (or select your personal, customized sound settings.)
- 3. P.MODE**  
Adjust the TV picture by selecting one of the preset factory settings (or select your personal, customized picture settings.)
- 4. +100**  
Press to select cable channels over 100 on TV.
- 5. VOL +, VOL -**  
Press to increase or decrease the volume.
- 6. MUTE**  
Press to mute the TV sound.
- 7. FAV.CH (Favorite Channel)**  
Press to switch between your favorite channels.
- 8. MENU**  
Displays the main on-screen menu.
- 9. STILL**  
Press to stop the action during a particular scene. Press again to resume normal video.
- 10. P.SIZE**  
Press to change the picture size.
- 11. MODE**  
Selects a target device to be controlled by the Samsung remote control (i.e., TV, STB, VCR, CABLE, or DVD).
- 12. PRE-CH**  
Tunes to the previous channel.
- 13. TV/VIDEO**  
Press to display all of the available video sources (i.e., TV, Set-Top box, VCR, DVD, DTV, PC).
- 14. CH ^, CH v**  
Press to change channels.
- 15. INFO**  
Press to display information on the TV screen.
- 16. EXIT**  
Press to exit the menu.
- 17. ▲, ▼, ◀, ▶, ENTER**  
Press to select highlight up, down, left, or right. While using the on-screen menus, press the ENTER to activate (or change) a particular item.
- 18. MTS (Multichannel Television Stereo)**  
Press to choose Stereo, Mono or SAP (Separate Audio Program).
- 19. SRS TSXT**  
Activates TruSurround.
- 20. ADD/DEL**  
Press to add or erase channels in the TV's memory. Use the ADD/DEL button to memorize and erase the fine tuning after fine tuning channels.
- 21. SLEEP**  
Press to select a preset time interval for automatic shutoff.
- 22. PIP (Picture In Picture)**  
Activates PIP.
- 23. SET**  
Used during set up of this remote control, so that it will work compatibly with other devices (Set-Top box, VCR, Cable box, DVD, etc.)
- 24. DNLe (Digital Natural Image engine)**  
Activates DNLe.
- 25. PIP Controls**  
**SIZE**; Press to select the size of PIP window.  
**SWAP**; Press to exchange the video signal that is currently displayed on the main screen with the signal in the PIP window.  
**CH ^/v**; Press to display the available channels in sequence. (These buttons change channels in the PIP window only.)
- 26. VCR/DVD Controls**  
Controls VCR or DVD Functions: Rewind, Stop, Play/Pause, Fast Forward.
- 27. RESET**  
If your remote control is not functioning properly, take out the batteries and press the reset button for about 2-3 seconds. Re-insert the batteries and try using the remote control again.

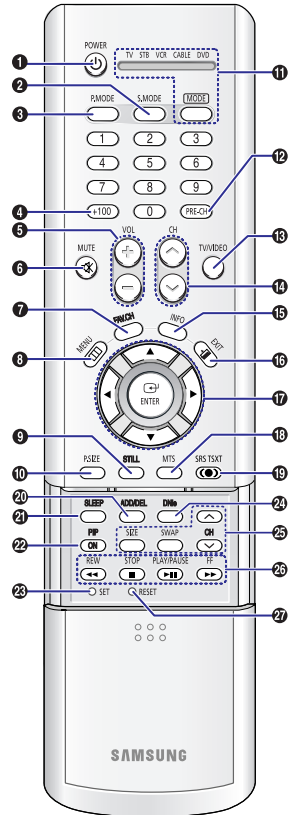

### Installing Batteries in the Remote Control

With normal use, the batteries in the remote control should last about a year. If you notice a performance degradation while using the remote, the batteries may need to be replaced. Make sure you replace both batteries and do not mix old and new batteries in the remote control. If you won't be using the remote control for a long time, remove the batteries and store them in a cool dry place.

- 1** Slide the back cover all the way out to open the battery compartment of the remote control.

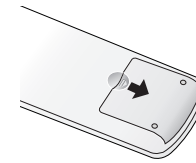

- 2** Install two AAA size batteries. Make sure to match the "+" and "-" ends of the batteries with the diagram inside the compartment.

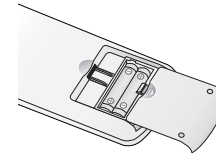

- 3** Slide the cover back into place.

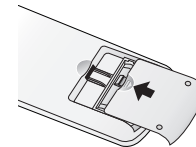

SAMSUNG

**Connections**



## Connections

### Connecting VHF and UHF Antennas

If you do not have a cable system, you will need to connect an antenna to your TV.

#### Antennas with 300-ohm Flat Twin Leads

If your antenna looks like this:  it has 300-ohm flat twin leads.

- 1 Place the wires from the twin leads under the screws on the 300-75 ohm adaptor (not supplied). Use a screwdriver to tighten the screws.

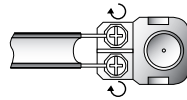

- 2 Plug the adaptor into the "ANT 1 IN" terminal on the rear panel.

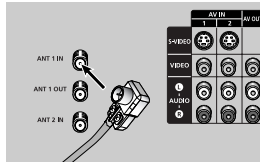

#### Antennas with 75-ohm Round Leads

If your antenna looks like this:  it is an antenna with 75-ohm round leads.

- 1 Plug the antenna lead into the "ANT 1 IN" terminal on the rear panel.

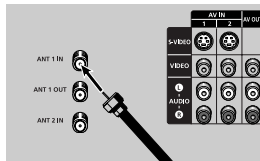

### Separate VHF and UHF Antennas

If you have two separate antennas for your TV (one VHF and one UHF), you must combine the two antenna signals before connecting the antennas to the TV. This procedure requires an optional combiner-adaptor (available at most electronics shops).

- 1 Connect both antenna leads to the combiner.

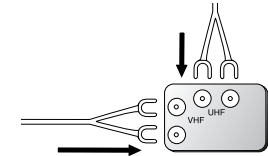

- 2 Plug the combiner into the "ANT 1 IN" terminal on the rear panel.

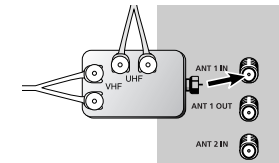

## Connections

### Connecting Cable TV and VCR

You can connect different cable systems to your TV, including cable without a cable box, and cable with a cable box that descrambles some or all channels.

#### Cable without a Cable Box

If you want to connect cable, and you do not need to use a cable box:

- 1 Plug the incoming cable into the "ANT 1 IN" terminal on the rear panel.

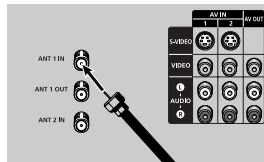

#### Cable with a Cable Box that Descrambles All Channels

- 1 Find the cable that is connected to the ANTENNA OUT terminal on your cable box. This terminal might be labeled "ANT OUT", "VHF OUT" or simply, "OUT".

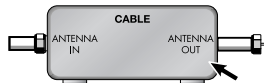

- 2 Connect the other end of this cable to the "ANT 1 IN" terminal on the rear panel.

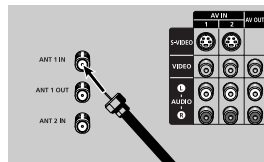

#### Connecting a Cable Converter Box

This connection allows you to watch cable and premium channels. You should keep your TV selected to "ANT 1 IN" so that you can use the TV features. When viewing premium channels, select "ANT 2 IN" and tune the TV to channel 3 or 4 (whichever channel is vacant in your area), then use the converter box to change channels. You will need two coaxial cables.

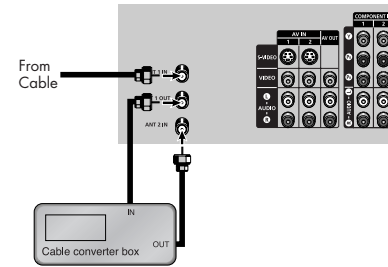

Note: When you use a converter box with your TV, there may be features that you can not program using the remote control, such as programming your favorite channels and blocking channels.

#### Connecting a Cable Converter Box and a VCR

This connection allows you to watch and record basic and premium cable channels, as well as watch videotapes. You should keep your TV selected to "ANT 1 IN" so that you can use the TV's features. When viewing premium channels or recording with the VCR, select "ANT 2 IN" (whichever channel is vacant in your area), then use the converter box to change channels.

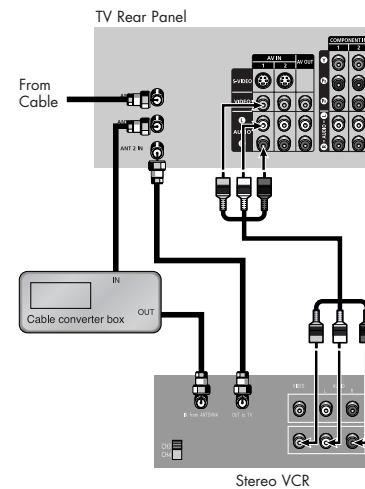

Caution: If you want to record one channel while watching another channel, a splitter (not included) must be added between the cable and "ANT 1 IN". One output of the splitter goes to "ANT 1 OUT" and the second output is connected to IN on the cable converter box.

If you have a mono VCR, connect L/Mono to VCR Audio OUT using only one audio cable.

If you have a S-VHS VCR, use the S-video connections and remove the video cable. Do not connect the video cable and the S-video cable to video1 simultaneously.

When you use a converter box with your TV there may be features that you can not program using the remote control, such as programming your favorite channels and blocking channels.

## Connections

### Connecting a Camcorder

The side panel jacks on your TV make it easy to connect a camcorder to your TV. You can use your camcorder to view tapes without using a VCR.

- 1 Locate the A/V output jacks on the camcorder. They are usually found on the side or back of the camcorder.
- 2 Connect a set of audio cables between the AUDIO IN jacks on the TV and the AUDIO OUT jacks on the camcorder. If you have mono camcorder, connect L(mono) to camcorder audio out using only one audio cable.
- 3 Connect a video cable between the VIDEO IN (or S-VIDEO IN) jack on the TV and the VIDEO OUT jack on the camcorder. The audio-video cables shown here are usually included with a Camcorder. (If not, check your local electronics store.) If your camcorder is stereo, you need to connect a set of two cables.

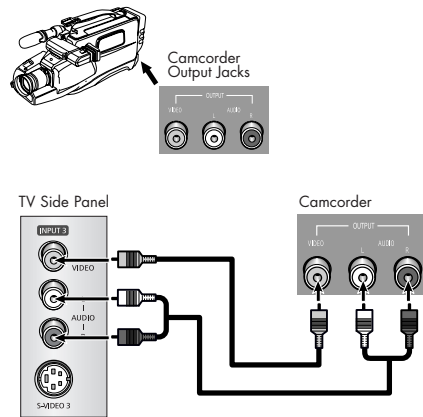

### Connecting a DVD Player

The rear panel jacks on your TV make it easy to connect a DVD player to your TV.

#### Connecting to Y,Pb,Pr

- 1 Connect a set of audio cables between the COMPONENT (1 or 2) AUDIO (L,R) IN jacks on the TV and the AUDIO OUT jacks on the DVD player.
- 2 To enable Component video viewing, connect a set of video cables between the COMPONENT (1 or 2) VIDEO (Y, Pb, Pr) IN jacks on the TV and VIDEO (Y, Pb, Pr (or Y, Cb, Cr)) VIDEO OUT jacks on the DVD player.

Note: For an explanation of Component video, see your DVD player's owner's manual.

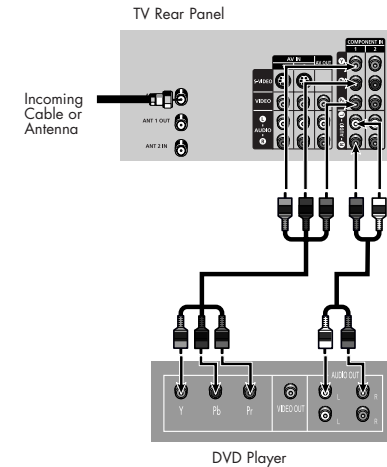

#### Connecting to audio and video jacks

- 1 Connect a set of audio cables between the AUDIO IN (1 or 2) jacks on the TV and the AUDIO OUT jacks on the DVD player.
- 2 Connect a video cable between the VIDEO IN (1 or 2) jack on the TV and the VIDEO OUT jack on the DVD player.

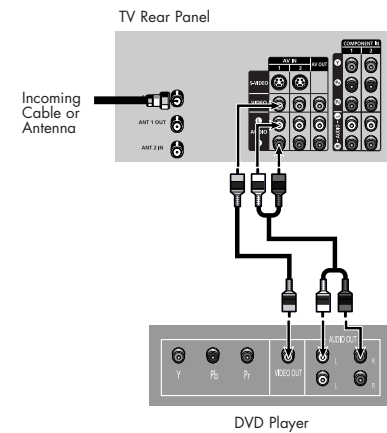

# Connections

## Connecting a DTV Set-Top Box

### Connecting to Y,Pb,Pr

- 1 Connect a set of audio cables between the **COMPONENT (1 or 2)** AUDIO (L,R) IN jacks on the TV and the AUDIO OUT jacks on the Set-Top Box.
- 2 Connect a set of video cables between the **COMPONENT (1 or 2)** VIDEO (Y, Pb, Pr) IN jacks on the TV and VIDEO (Y, Pb, Pr (or Y, Cb, Cr)) OUT jacks on the Set-Top Box.  
Note: For an explanation of Component video, see your Set Top Box owner's manual.

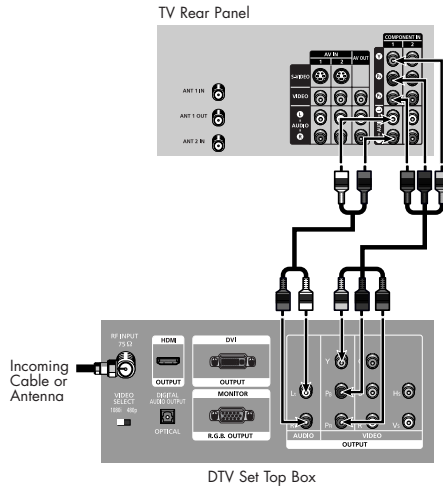

### Connecting to R,G,B

- 1 Connect a set of audio cables between the PC AUDIO (L,R) IN jacks on the TV and the AUDIO OUT jacks on the Set-Top Box.
- 2 Connect a video cable between the PC IN jack on the TV and the R.G.B OUT jack on the Set-Top Box.

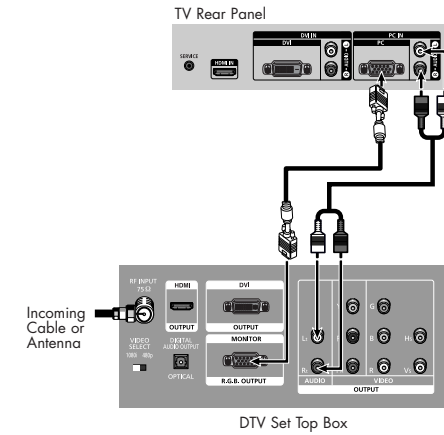

### Connecting to DVI (Digital Visual Interface)

- 1 Connect a set of audio cables between the DVI AUDIO (L,R) IN jacks on the TV and the AUDIO OUT jacks on the Set-Top Box.
- 2 Connect a video cable between the DVI IN jack on the TV and the DVI OUT jack on the Set-Top Box.

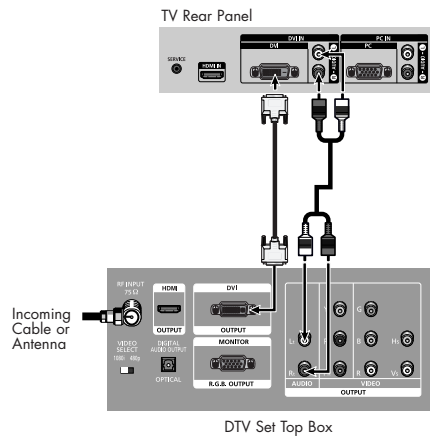

### Connecting to HDMI (High Definition Multimedia Interface)

- 1 Connect a HDMI cable between the HDMI IN jack on the TV and the HDMI OUT jack on the Set-Top Box.

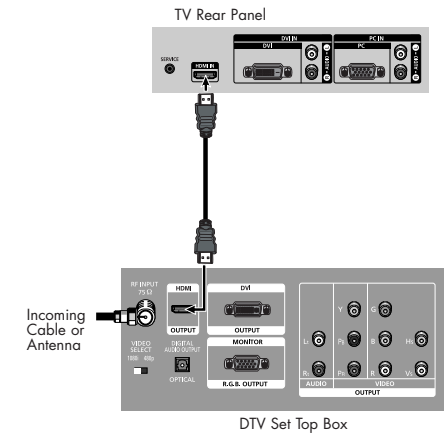

SAMSUNG

**Operation**

# Operation

## Turning the TV On and Off

Press the POWER button on the remote control.  
You can also use the POWER button on the front panel.

## Viewing the Menus and On-Screen Displays

The on-screen menu system allows you to control the settings of your TV. Access the on-screen menu system by pressing the MENU button on the remote control. Once the on-screen menu appears, use the ▲/▼/◀/▶/ENTER on your remote control to select menu items and make adjustments. You can also view the on-screen menu system and make some adjustments using the TV's side panel buttons.

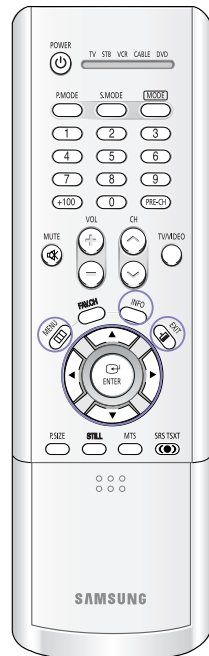

### Viewing the Menus

- 1 Press the MENU button. The main menu is displayed. There are five menu groups: "Input", "Picture", "Sound", "Channel" and "Setup".
- 2 Press the ▲ or ▼ button to select to an item you want in the menu. Press the ◀, ▶ or ENTER button to display, change, or use the selected items. Use the ENTER button to enter items in the menu.
- 3 Press the EXIT button to exit.

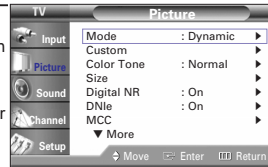

### Viewing the Display

Press the INFO button on the remote control. The TV displays the current channel, the status of certain picture and sound settings and the current time.

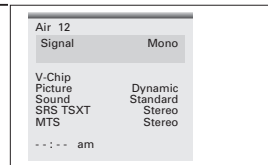

## Selecting the Menu Language

Choose a language for the on-screen menus: English, Spanish or French.



- 1 Press the MENU button. Press the ▲ or ▼ button to select "Setup", then press the ENTER button.
- 2 Press the ENTER button to select "Language". Press the ▲ or ▼ button to select the appropriate language, then press ENTER button.  
  
Press the EXIT button to exit.

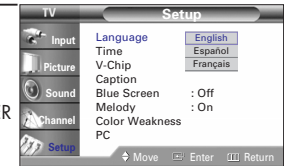
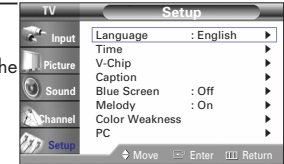

## Selecting the Antenna Input

You can connect to two different signal sources by choosing the antenna input (1 or 2).

- 1 Press the MENU button. Press the ▲ or ▼ button to select "Channel", then press the ENTER button.
- 2 Press the ENTER button to select "Antenna". Press the ▲ or ▼ button to select "Ant.1" or "Ant.2", then press ENTER button.  
  
Press the EXIT button to exit.

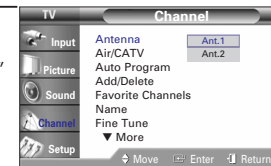
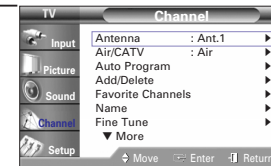

# Operation

## Memorizing the Channels

Your TV can memorize and store all of the available channels for both "off-air" (antenna) and cable channels. After the available channels are memorized, use the CH $\wedge$  and CH $\vee$  buttons to scan through the channels. This eliminates the need to change channels by entering the channel digits. There are three steps for memorizing channels: selecting a broadcast source, memorizing the channels (automatic) and adding/deleting channels (manual).



### Selecting the Video Signal Source

Before your TV can begin memorizing the available channels, you must specify the type of signal source that is connected to the TV (i.e., an antenna or a cable system).

- 1 Press the MENU button. Press the  $\blacktriangle$  or  $\blacktriangledown$  button to select "Channel", then press the ENTER button.

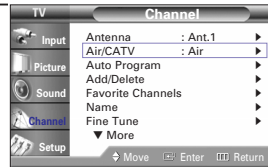

- 2 Press the  $\blacktriangle$  or  $\blacktriangledown$  button to select "Air/CATV", then press the ENTER button. If you are connected to an antenna, press the  $\blacktriangle$  or  $\blacktriangledown$  button to select "Air". If you connected cable, press the  $\blacktriangle$  or  $\blacktriangledown$  button to select the type of cable system: "STD", "HRC" or "IRC".

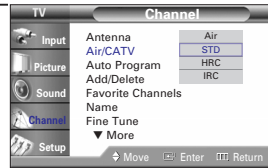

Press the EXIT button to exit.

### NOTES

- "STD", "HRC" and "IRC" identify various types of cable TV systems. Contact your local cable company to identify the type of cable system that exists in your particular area. At this point the signal source has been selected. Proceed to "Storing Channels in Memory".
- Subscription cable services require service-specific requirement for viewing.

## Storing Channels in Memory (Automatic Method)

First, select the correct signal source ("Air", "STD", "HRC" or "IRC") as described on the previous page.

- 1 Press the MENU button. Press the  $\blacktriangle$  or  $\blacktriangledown$  button to select "Channel", then press the ENTER button.

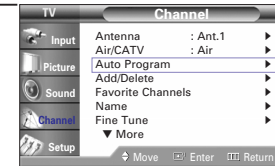

- 2 Press the  $\blacktriangle$  or  $\blacktriangledown$  button to select "Auto Program", then press the ENTER button. Press the ENTER button to start the auto program. The TV begins memorizing all of the available stations. Press the ENTER button at any time to interrupt the memorization process.



Press the EXIT button to exit.

## Adding and Erasing Channels

To add channels that were not memorized (or to delete unwanted channels from memory):

- 1 Press the MENU button. Press the  $\blacktriangle$  or  $\blacktriangledown$  button to select "Channel", then press the ENTER button.

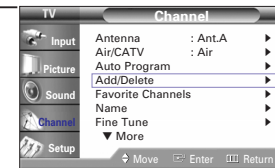

**Quick way to access Add/Delete: Just press the ADD/DEL button on the remote control.**

- 2 Press the  $\blacktriangle$  or  $\blacktriangledown$  button to select "Add/Delete", then press the ENTER button. Repeatedly pressing the ENTER button will alternate between add channel and delete channel. Press the CH $\wedge$  or CH $\vee$  button (or number buttons) to switch to the appropriate channel, then repeat above.



Press the EXIT button to exit.

## Operation

### Changing Channels

You can change channels on your TV by using the CH $\wedge$  and CH $\vee$  buttons, or by direct selection using the number buttons. You can use the number buttons to tune to any channel (even one that has been erased or has not been memorized).



#### Using the Channel Buttons

Press the CH $\wedge$  or CH $\vee$  button to change channels. When you press the CH $\wedge$  or CH $\vee$  button, the TV changes channels in sequence. You will see all the channels that the TV has memorized. (The TV must have memorized at least three channels.) You will not see channels that were either erased or not memorized.

#### Using the Number Buttons

Press the number buttons to go directly to a channel. When you use the number buttons, you can directly select channels that were either erased or not memorized.

For example, to select channel "27", press the "2", then "7". The TV will change channels when you press the second number.

To change to single-digit channels (0-9) faster, press the "0" before the single digit. (For channel "4", press the "0", then "4".)

To select a channel over 100, press the +100 button. (For channel "122", press the +100 button, then "2", then "2".)

#### Using the Previous Channel

Press the PRE-CH button. The TV changes to the last channel you were watching.

### Selecting Your Favorite Channels

You can store your favorite channels for each available input source (such as TV and CATV). This allows you to quickly and easily find frequently watched channels by pressing the FAV.CH button on the remote control.



#### To Store Your Favorite Channels:

- 1 Press the MENU button. Press the  $\blacktriangle$  or  $\blacktriangledown$  button to select "Channel", then press the ENTER button.



- 2 Press the  $\blacktriangle$  or  $\blacktriangledown$  button to select "Favorite Channels", then press the ENTER button. Press the  $\blacktriangle$  or  $\blacktriangledown$  button to select a channel, then press the ENTER button. Press the ENTER button again to deselect the selected channel.

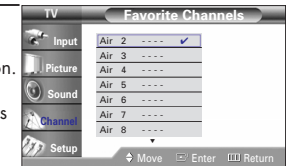

Press the EXIT button to exit.

#### To View Your Favorite Channels:

Press the FAV.CH button repeatedly to jump from one favorite channel to another.

#### NOTE

- Only memorized channels can be set as Favorite channels.



# Operation

## Scanning the Channels

The TV automatically scan all of the channels it has memorized.



1 Press the MENU button. Press the ▲ or ▼ button to select "Channel", then press the ENTER button.

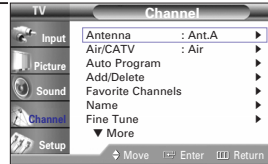

2 Press the ▲ or ▼ button to select "Scan", then press the ENTER button. The TV scans all of the channels memorized.



Press the EXIT button to exit.



### NOTE

- When the "ANT 2 IN" mode is selected, the channel scan function works on the main picture only.

## Labeling the Channels

Use this feature to assign an easy-to-remember label to any channel (i.e., "CBS", "ESPN", "PBS2", "CNN1", etc.) A label consists of five fields, where each field is a letter, a number or a blank. When the INFO button is pressed, the channel label will appear next to the channel number.

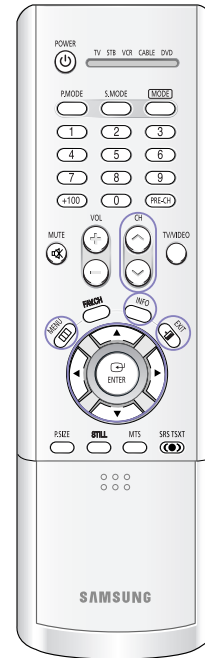

1 Press the CH▲ or CH▼ button to tune to the channel that will be labeled.

2 Press the MENU button. Press the ▲ or ▼ button to select "Channel", then press the ENTER button. Press the ▲ or ▼ button to select "Name", then press the ENTER button.

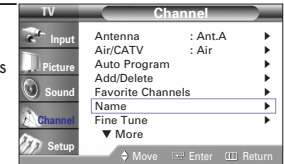

3 Press the ▲/▼/◀/▶ button to move to the channel to be assigned to a new name, then press the ENTER button. Press the ▲ or ▼ button to select a letter, a number or a blank. (Results in this sequence: A...Z, \*, blank, 0...9, -).

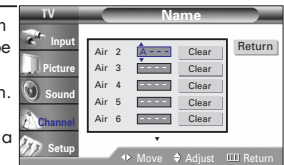

4 Press the ▶ button to switch to the next field, which will be selected. Select a second letter or digit pressing ▲ or ▼ button, as above. Repeat the process to select the last two digits. When you have finished, press the ENTER button. To erase the assigned new name, select "Clear" by pressing the ▲/▼/◀/▶ button, then press the ENTER button.

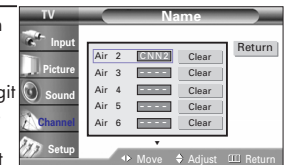

Press the EXIT button to exit.

### NOTE

- If you add or delete the TV channel, the labeled channels list will also be added or deleted.

# Operation

## Picture Control

You can use the on-screen menus to change the "Contrast", "Brightness", "Sharpness", "Color" and "Tint" according to personal preference. (Alternatively, you can use one of the automatic settings. See next page.)

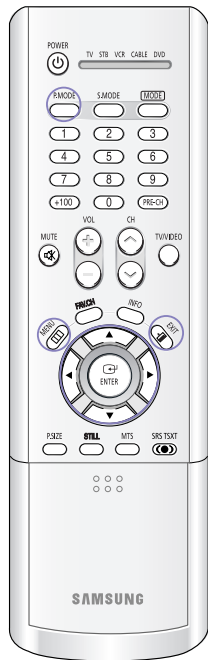

### Customizing the Picture

1 Press the MENU button. Press the ▲ or ▼ button to select "Picture", then press the ENTER button.

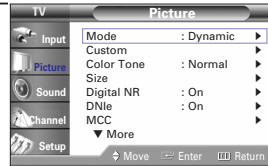

2 Press the ▲ or ▼ button to select "Custom", then press the ENTER button.

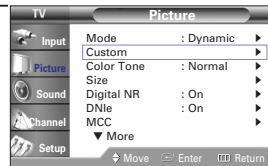

3 Press the ▲ or ▼ button to select a particular item, then press the ENTER button.

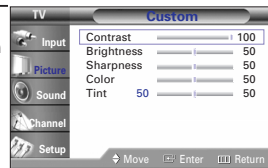

4 Press the ◀ or ▶ button to increase or decrease the value of a particular item.

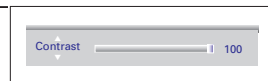

Press the EXIT button to exit.

### NOTE

- "Tint" doesn't operate in PC, DVI or 480p-Component or higher modes.

### Using Automatic Picture Settings

Your TV has automatic picture settings ("Dynamic", "Standard" and "Movie") that are preset at the factory. You can activate either "Dynamic", "Standard" or "Movie" by pressing the P.MODE button (or by making a selection from the menu). Or, you can select "Custom" which automatically recalls your personalized picture settings.

1 Press the MENU button. Press the ▲ or ▼ button to select "Picture", then press the ENTER button.

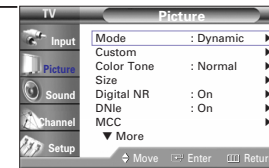

2 Press the ENTER button to select "Mode". Press the ▲ or ▼ button to select a particular item, then press the ENTER button.

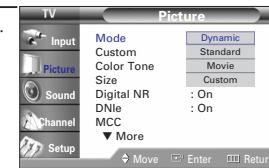

Press the EXIT button to exit.

### Alternate method

Press the P.MODE button on the remote control repeatedly to select one of the standard picture settings.

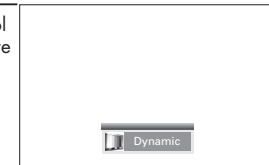

- Choose "Dynamic" for viewing the TV during the day or when there is a bright light in the room.
- Choose "Standard" for the standard factory settings.
- Choose "Movie" when viewing a movie.
- Choose "Custom" if you want to adjust the settings according to personal preference (see previous page).

# Operation

## Sound Control

You can control and customize the sound levels and settings of the TV with the remote control.



### Adjusting the Volume

Press the VOL+ or VOL- buttons to increase or decrease the volume.

### Using the MUTE Button

At any time, you can temporarily cut off the sound. Press the MUTE button on the remote control. The message "Mute" is displayed and the sound cuts off.



To turn mute off press the MUTE button again or, press either the VOL+ or VOL- button.

### Customizing the Sound

The sound settings can be adjusted to suit your personal preference. (Alternatively, you can use one of the automatic settings. See next page.)

- 1 Press the MENU button. Press the ▲ or ▼ button to select "Sound", then press the ENTER button.

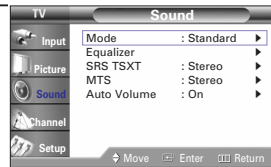

- 2 Press the ▲ or ▼ button to select "Equalizer", then press the ENTER button.

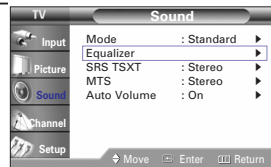

Continued...

- 3 Press the ◀ or ▶ button to select a particular item to be changed. Press the ▲ or ▼ button to increase or decrease the value of a particular item. Press the EXIT button to exit.

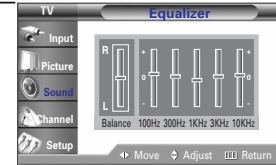

### Using Automatic Sound Settings

Your TV has automatic sound settings ("Standard", "Music", "Movie" and "Speech") that are preset at the factory. You can activate these sound settings by pressing the S.MODE button (or by making a selection from the menu), or you can select "Custom", which automatically recalls your personalized sound settings.

- 1 Press the MENU button. Press the ▲ or ▼ button to select "Sound", then press the ENTER button.

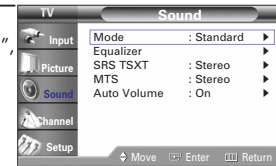

- 2 Press the ENTER button to select "Mode". Press the ▲ or ▼ button to select a particular item, then press the ENTER button. Press the EXIT button to exit.

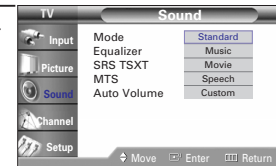

### Alternate method

Press the S.MODE button on the remote control repeatedly to select one of the standard sound settings.



- Choose "Standard" for the standard factory settings.
- Choose "Music" when watching music videos or concerts.
- Choose "Movie" when watching movies.
- Choose "Speech" when watching a show that is mostly dialogue (i.e., news).
- Choose "Custom" to recall your personalized settings.

# Operation

## Setting the Clock

Setting the clock is necessary in order to use the various timer features of the TV. Also, you can check the time while watching the TV. (Just press the INFO button.)



1 Press the MENU button. Press the ▲ or ▼ button to select "Setup", then press the ENTER button. Press the ▲ or ▼ button to select "Time", then press the ENTER button.

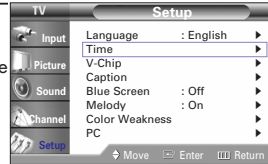

2 Press the ENTER button to select "Clock Set".



3 Press the ◀ or ▶ button to move to "Hour", "Min" or "am/pm". Set the clock you want by pressing the ▲ or ▼ button, then press the ENTER button.

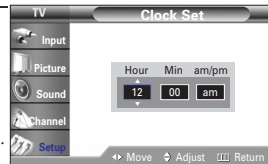

Press the EXIT button to exit.

### NOTES

- The current time will appear every time you press the INFO button.
- You can set the hour and minute directly by pressing the number buttons on the remote control.

## Absent Power Off

When you set the timer "On", your television will eventually be turned off, if you do not operate any controls during the 3 hours after the TV is turned on by timer. This function is available in only the timer "On" mode and will prevent a leakage accident or overheating, caused by your TV left on for a long time due to the timer "On" (when you are away on holiday, for example).

## Setting the Timers

This TV can be set to turn on or off automatically at specific times that you choose. Before using the timers, you must set the TV's clock, as described previously.

### Setting the On/Off Timer

1 Press the MENU button. Press the ▲ or ▼ button to select "Setup", then press the ENTER button.

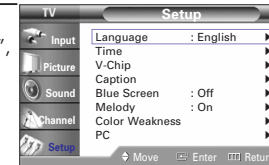

2 Press the ▲ or ▼ button to select "Time", then press the ENTER button. Press the ▲ or ▼ button to select "On Timer", then press the ENTER button.



3 Press the ▲ or ▼ button to adjust "Hour", then press the ▶ button to move to the next step. Set other items using the same method as above. When finished, press the MENU button to return.

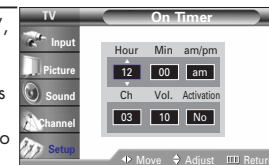

4 Press the ▲ or ▼ button to select "Off Timer", then press the ENTER button.

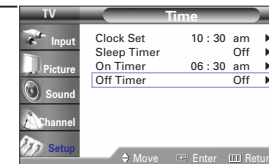

5 Press the ▲ or ▼ button to adjust "Hour", then press the ▶ button to move to the next step. Set other items using the same method as above.

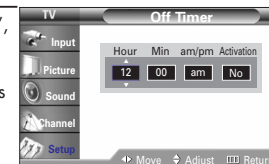

Press the EXIT button to exit.

# Operation

## Setting the Sleep Timer

The sleep timer automatically shuts off the TV after a preset time (from 30 to 180 minutes).



1 Press the MENU button. Press the ▲ or ▼ button to select "Setup", then press the ENTER button.

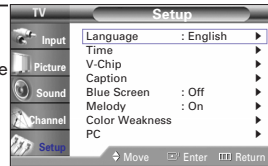

2 Press the ▲ or ▼ button to select "Time", then press the ENTER button. Press the ▲ or ▼ button to select "Sleep Timer", then press the ENTER button.

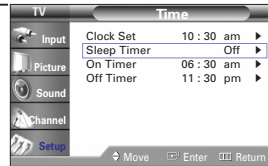

3 Press the ▲ or ▼ button to select "Sleep Timer", then press the ENTER button.



Press the ▲ or ▼ button to select the preset time you want, then press the ENTER button.

Press the EXIT button to exit.

### Alternate method

Press the SLEEP button on the remote control repeatedly until the appropriate time interval appears (any of the preset values from "30 Min." to "180 Min.").



### NOTE

- If no signal is received for 15 minutes, the TV will be automatically turned off.

## Viewing an External Signal Source

Use the remote control to switch between viewing signals from connected equipment, such as VCR, DVD, Set-Top box and the TV source (broadcast or cable).



### Setting the Signal Source

1 Press the MENU button. Press the ENTER button to select "Input".



2 Press the ENTER button to select "Source List". Press the ▲ or ▼ button to select a signal source, then press the ENTER button.

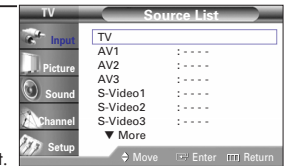

Press the EXIT button to exit.

### Alternate method

Press the TV/VIDEO button on the remote control repeatedly to select an external signal source.



### NOTE

- When you connect equipment to the TV, you can choose between the following sets of jacks: "AV1", "AV2", "S-Video1", "S-Video2", "Component1", "Component2", "PC", "DVI" or "HDMI" on the TV's rear panel, and "AV3" or "S-Video3" on the TV's side panel.

## Operation

### Assigning Names to External Input Mode

This feature enables you to name the input source you have connected.



1 Press the MENU button. Press the ENTER button to select "Input".



2 Press the ▲ or ▼ button to select "Edit Name", then press the ENTER button.

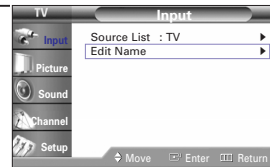

3 Press the ▲ or ▼ button to select a signal source, then press the ENTER button. Press the ▲ or ▼ button to select an external device, then press the ENTER button.

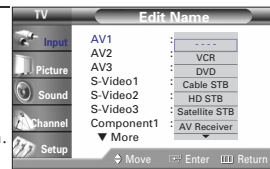

Press the EXIT button to exit.

### Freezing the Current Picture

You can freeze the picture when watching a television programme simply by pressing the STILL button. To return to normal viewing, press it again.



#### NOTES

- In the PIP mode, the main and sub pictures are stilled at the same time.
- The still function doesn't operate in "Component 1", "Component 2", "PC", "DVI" or "HDMI" mode.

### Remote Control VCR/DVD Buttons

Flip the cover of the remote control up to access buttons that can control the tape functions of a connected VCR or DVD, including Rewind, Stop, Play/Pause and Fast Forward.

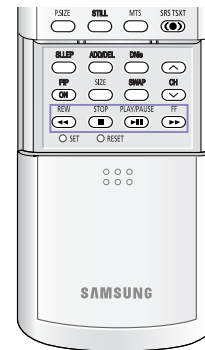

Slide the cover of your remote control unit for access to the tape function controls. Press the appropriate buttons to control your VCR or DVD.