

SAMSUNG

SAMSUNG

1-800-SAMSUNG (1-800-726-7864)

**Samsung Electronics America  
Service Division**

400 Valley Road, Suite 201  
Mount Arlington, NJ 07856  
[www.samsungusa.com](http://www.samsungusa.com)

**Samsung Electronics Canada Inc.  
Samsung Customer Care**

7037 Financial Drive  
Mississauga, Ontario  
L5N 6R3  
[www.samsung.ca](http://www.samsung.ca)

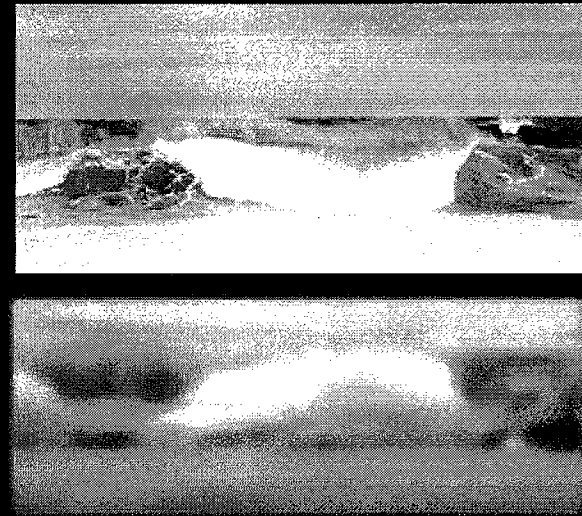

**I N S T R U C T I O N   M A N U A L**  
HLP4663W/HLP5063W/HLP5663W/HLP6163W

BP68-00283A-00

**This device is a Class B digital apparatus.**

## Table of Contents

Your New Wide TV .....	6	Special Features .....	46
Replacing the Lamp .....	6	Customizing Your Remote Control .....	46
List of Features .....	8	Remote Control Codes .....	47
Accessories .....	8	Fine Tuning Channels .....	48
Side Panel Buttons .....	9	LNA (Low Noise Amplifier) .....	49
Side Panel Jacks .....	9	Selecting the Color Tone .....	50
Front Panel LED Indicators .....	10	Changing the Picture Size .....	51
Rear Panel Jacks .....	11	Digital Noise Reduction .....	52
Remote Control .....	12	DNIe™ (Digital Natural Image engine) <b>DNIe™</b> .....	53
Installing Batteries in the Remote Control .....	13	Setting the MCC (My Color Control) Mode .....	54
Connections .....	16	Setting the Film Mode .....	56
Connecting VHF and UHF Antennas .....	16	Viewing Picture-In-Picture .....	57
Antennas with 300-ohm Flat Twin Leads .....	16	Activating the PIP .....	57
Antennas with 75-ohm Round Leads .....	16	Selecting an External Source .....	58
Separate VHF and UHF Antennas .....	17	Swapping the Sub Picture and Main Picture .....	59
Connecting Cable TV and VCR .....	18	Changing the Size of the Sub Picture .....	60
Cable without a Cable Box .....	18	Changing the Location of the Sub Picture .....	61
Cable with a Cable Box that Descrambles All Channels .....	18	Changing the Channel of the Sub Picture .....	62
Connecting a Cable Converter Box .....	19	Selecting the Sound Source .....	63
Connecting a Cable Converter Box and a VCR .....	19	Setting the SRS TSXT .....	64
Connecting a Camcorder .....	20	Choosing a Multi-Channel Sound [MTS] track .....	65
Connecting a DVD Player .....	21	Auto Volume .....	66
Connecting to Y,Pb,Pr .....	21	Enjoying the Sound of External Speakers .....	67
Connecting to Audio and Video Jacks .....	21	Using the V-Chip (USA) .....	68
Connecting a DTV Set-Top Box .....	22	Viewing Closed Caption Information .....	74
Connecting to Y,Pb,Pr .....	22	Setting the Blue Screen Mode .....	76
Connecting to DVI (Digital Visual Interface) .....	22	Setting The On/Off Melody .....	77
Connecting to HDMI (High Definition Multimedia Interface) .....	23	Using the Color Weakness Enhancement Feature .....	78
Connecting to R,G,B .....	23	PC Display .....	80
Operation .....	26	Using Your TV as a Computer [PC] Display .....	80
Turning the TV On and Off .....	26	How to Connect Your PC to the TV .....	80
Viewing the Menus and On-Screen Displays .....	26	Setting up Your PC Software (Based on Windows 98) .....	81
Selecting the Menu Language .....	27	Display Modes .....	82
Selecting the Antenna Input .....	27	Adjusting the Picture Quality .....	83
Memorizing the Channels .....	28	Changing the Picture Position .....	84
Adding and Erasing Channels .....	29	Adjusting the Picture Quality and Position Automatically .....	85
Changing Channels .....	30	Initializing the Picture Settings .....	86
Selecting Your Favorite Channels .....	31	Changing the Picture Size [PC Mode] .....	87
Scanning the Channels .....	32	Appendix .....	90
Labeling the Channels .....	33	Troubleshooting .....	90
Picture Control .....	34	Cleaning and Maintaining Your TV .....	91
Sound Control .....	36	Using Your TV in Another Country .....	91
Setting the Clock .....	38	Specifications .....	91
Setting the Timers .....	39		
Viewing an External Signal Source .....	41		
Assigning Names to External Input Mode .....	42		
Freezing the Current Picture .....	43		
Remote Control VCR/DVD Buttons .....	43		

**Your New Wide TV**

## Your New Wide TV

### Replacing the Lamp

- **Why do I need to replace the lamp?**

The lamp used in a projection TV has a limited lifespan. For the best screen quality it needs to be replaced periodically. After replacing the lamp, the screen quality will be bright and clear as new.

- **When do I need to replace it?**

It should be replaced when the screen becomes darker, less clear or when all three LEDs on the front (Timer, Lamp, & Temp.) are flashing.

- **Check before lamp replacement**

1. The lamp must be the same code number and type.
2. The lamp type is indicated on the right side of the TV. It is also indicated on the lamp case.
3. After checking the code number for the lamp, give the code number to the store where you purchased the TV or to a Samsung Service center.

- **Caution**

1. Replace with the correct code numbered lamp to avoid damage to the TV.
2. Turn the power off and wait for 30 minutes before replacing the lamp as it will be hot.
3. Do not touch the glass part of the lamp with your bare hands nor insert any foreign object inside the cover as it may cause poor screen quality, electric shock or fire.
4. Do not place the old lamp near flammable objects or within the reach of children.

• For replacement, you will need a 5.91 Inches-long Phillips screwdriver and a pair of gloves.

- 1 Unplug TV, then use a screwdriver to remove the screw.

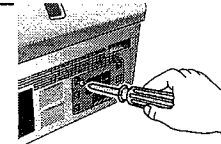

- 2 Remove the Lamp cover.

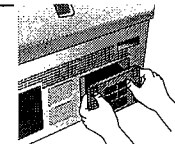

- 3 Remove the screws securing the Lamp by hand.



- 4 Separate the Lamp from the engine by holding the handle and pulling it out.

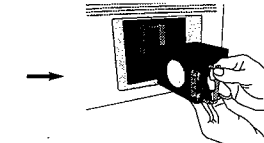
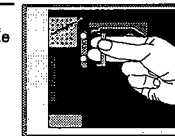

- 5 To reinstall the Lamp, follow these steps in reverse order.

#### NOTES

- Be sure the replacement Lamp is the same type.
- After replacing the lamp, align the lamp cover with the groove and secure the screw.
- The TV will not turn on if the lamp cover is not correctly closed (as this will activate the protective circuit).

## Your New Wide TV

### List of Features

Your TV was designed and engineered using the latest technology. It is a full-featured, high-performance unit that exceeds industry standards. In addition, it has these special features:

- Easy-to-operate remote control
- Easy-to-use on-screen menu system you can access from the side panel or remote control
- Automatic timer to turn the TV on and off at any time you choose
- Adjustable picture and sound settings and the ability to memorize your favorite settings
- Automatic channel tuning for up to 181 channels
- A special filter to reduce or eliminate reception problems
- Fine tuning control for the sharpest picture possible
- A built-in multi-channel sound decoder for stereo and bilingual listening
- Built-in, dual channel speakers
- A special sleep timer
- Picture-in-Picture capability that lets you watch two channels at once
- Widescreen TV with adjustable image size
- Life-like clear images provided by DNle technology
- MCC (My Color Control) Mode for corresponding with your color style
- Color weakness Mode

### Accessories

Once you have unpacked your TV, check to make sure that you have all the parts shown here. If any piece is missing or broken, call your dealer.

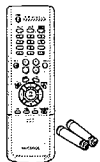

Remote Control  
(BP59-00048B)/  
AAA Batteries  
(4301-000121)



Warranty Cards (2)/  
Registration Card (1)



Instruction Manual/  
Safety Guide Manual/  
Quick Guide Manual

### Side Panel Buttons

The buttons on the side panel control your TV's basic features, including the on-screen menu system. To use the more advanced features, you must use the remote control.

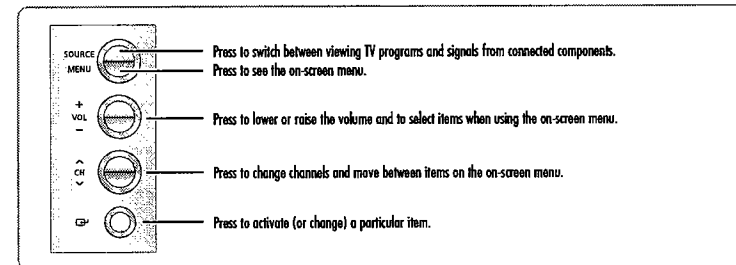

### Side Panel Jacks

Use the side panel jacks to connect a component that is used only occasionally (a camcorder or video game, for example).

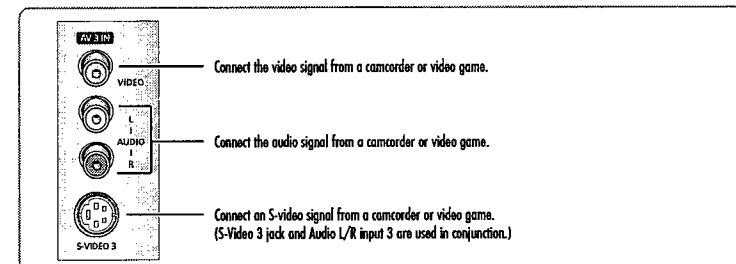

## Your New Wide TV

### Remote Control

You can use the remote control up to about 23 feet from the TV. When using the remote control, always point it directly at the TV. You can also use your remote control to operate your Set-Top box, VCR, Cable box or DVD player. See pages 46-47 for details.

- 1. POWER**  
Turns the TV on and off.
- 2. S.MODE**  
Adjust the TV sound by selecting one of the preset factory settings (or select your personal, customized sound settings.)
- 3. P.MODE**  
Adjust the TV picture by selecting one of the preset factory settings (or select your personal, customized picture settings.)
- 4. +100**  
Press to select cable channels over 100 on TV.
- 5. VOL +, VOL -**  
Press to increase or decrease the volume.
- 6. MUTE**  
Press to mute the TV sound.
- 7. FAV.CH (Favorite Channel)**  
Press to switch between your favorite channels.
- 8. MENU**  
Displays the main on-screen menu.
- 9. STILL**  
Press to stop the action during a particular scene. Press again to resume normal video.
- 10. P.SIZE**  
Press to change the picture size.
- 11. MODE**  
Selects a target device to be controlled by the Samsung remote control (i.e., TV, STB, VCR, CABLE, or DVD).
- 12. PRE-CH**  
Tunes to the previous channel.
- 13. TV/VIDEO**  
Press to display all of the available video sources (i.e., TV, Set-Top box, VCR, DVD, DIV, PC).
- 14. CH ^, CH v**  
Press to change channels.
- 15. INFO**  
Press to display information on the TV screen.
- 16. EXIT**  
Press to exit the menu.
- 17. ▲, ▼, ◀, ▶, ENTER**  
Press to select highlight up, down, left, or right. While using the on-screen menus, press the ENTER to activate (or change) a particular item.
- 18. MTS (Multichannel Television Stereo)**  
Press to choose Stereo, Mono or SAP (Separate Audio Program).
- 19. SRS**  
Activates TruSurround.
- 20. ADD/DEL**  
Press to add or erase channels in the TV's memory. Use the ADD/DEL button to memorize and erase the fine tuning after fine tuning channels.
- 21. SLEEP**  
Press to select a preset time interval for automatic shutoff.
- 22. PIP (Picture In Picture)**  
Activates PIP.
- 23. SET**  
Used during set up of this remote control, so that it will work compatibly with other devices (Set-Top box, VCR, Cable box, DVD, etc.)
- 24. DNIe (Digital Natural Image engine)**  
Activates DNIe.
- 25. PIP Controls**  
**SIZE:** Press to select the size of PIP window.  
**SWAP:** Press to exchange the video signal that is currently displayed on the main screen with the signal in the PIP window.  
**CH ^/v:** Press to display the available channels in sequence. (These buttons change channels in the PIP window only.)
- 26. VCR/DVD Controls**  
Controls VCR or DVD functions: Rewind, Stop, Play/Pause, Fast Forward.
- 27. RESET**  
If your remote control is not functioning properly, take out the batteries and press the reset button for about 2-3 seconds. Re-insert the batteries and try using the remote control again.

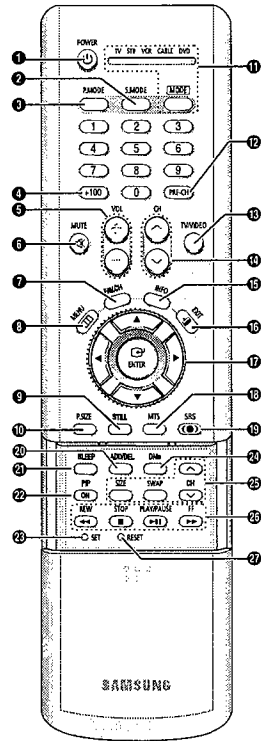

### Installing Batteries in the Remote Control

With normal use, the batteries in the remote control should last about a year. If you notice a performance degradation while using the remote, the batteries may need to be replaced. Make sure you replace both batteries and do not mix old and new batteries in the remote control. If you won't be using the remote control for a long time, remove the batteries and store them in a cool dry place.

- 1** Slide the back cover all the way out to open the battery compartment of the remote control.

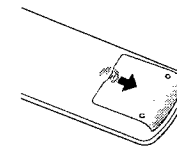

- 2** Install two AAA size batteries. Make sure to match the "+" and "-" ends of the batteries with the diagram inside the compartment.

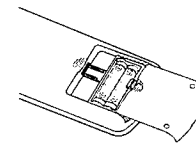

- 3** Slide the cover back into place.

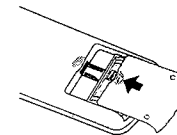



# Connections

## Connections

### Connecting VHF and UHF Antennas

If you do not have a cable system, you will need to connect an antenna to your TV.

#### Antennas with 300-ohm Flat Twin Leads

If your antenna looks like this:  it has 300-ohm flat twin leads.

- 1 Place the wires from the twin leads under the screws on the 300-75 ohm adaptor (not supplied). Use a screwdriver to tighten the screws.

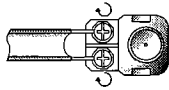

- 2 Plug the adaptor into the "ANT 1 IN" terminal on the rear panel.

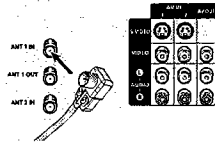

#### Antennas with 75-ohm Round Leads

If your antenna looks like this:  it is an antenna with 75-ohm round leads.

- 1 Plug the antenna lead into the "ANT 1 IN" terminal on the rear panel.

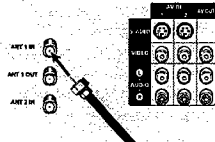

### Separate VHF and UHF Antennas

If you have two separate antennas for your TV (one VHF and one UHF), you must combine the two antenna signals before connecting the antennas to the TV. This procedure requires an optional combiner-adaptor (available at most electronics shops).

- 1 Connect both antenna leads to the combiner.

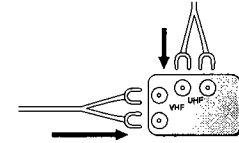

- 2 Plug the combiner into the "ANT 1 IN" terminal on the rear panel.

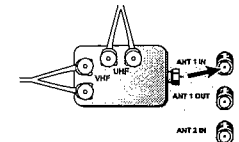



## Connections

### Connecting Cable TV and VCR

You can connect different cable systems to your TV, including cable without a cable box, and cable with a cable box that descrambles some or all channels.

#### Cable without a Cable Box

If you want to connect cable, and you do not need to use a cable box:

- 1 Plug the incoming cable into the "ANT 1 IN" terminal on the rear panel.

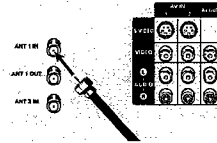

#### Cable with a Cable Box that Descrambles All Channels

- 1 Find the cable that is connected to the ANTENNA OUT terminal on your cable box. This terminal might be labeled "ANT OUT", "VHF OUT" or simply, "OUT".

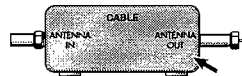

- 2 Connect the other end of this cable to the "ANT 1 IN" terminal on the rear panel.

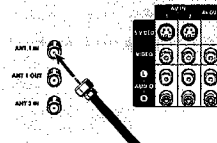

### Connecting a Cable Converter Box

This connection allows you to watch cable and premium channels. You should keep your TV selected to "ANT 1 IN" so that you can use the TV features. When viewing premium channels, select "ANT 2 IN" and tune the TV to channel 3 or 4 (whichever channel is vacant in your area), then use the converter box to change channels. You will need two coaxial cables.

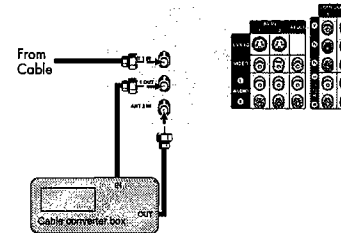

Note: When you use a converter box with your TV, there may be features that you can not program using the remote control, such as programming your favorite channels and blocking channels.

### Connecting a Cable Converter Box and a VCR

This connection allows you to watch and record basic and premium cable channels, as well as watch videotapes. You should keep your TV selected to "ANT 1 IN" so that you can use the TV's features. When viewing premium channels or recording with the VCR, select "ANT 2 IN" (whichever channel is vacant in your area), then use the converter box to change channels.

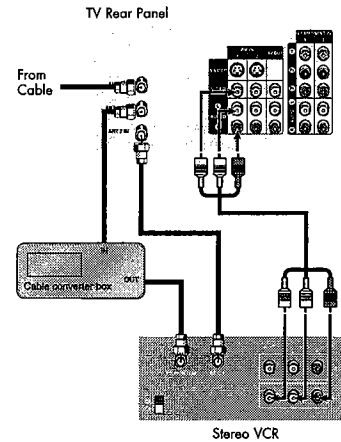

Caution: If you want to record one channel while watching another channel, a splitter (not included) must be added between the cable and "ANT 1 IN". One output of the splitter goes to "ANT 1 OUT" and the second output is connected to IN on the cable converter box.

If you have a mono VCR, connect L/Mono to VCR Audio OUT using only one audio cable.

If you have a S-VHS VCR, use the S-video connections and remove the video cable. Do not connect the video cable and the S-video cable to video 1 simultaneously.

When you use a converter box with your TV there may be features that you can not program using the remote control, such as programming your favorite channels and blocking channels.

## Connections

### Connecting a Camcorder

The side panel jacks on your TV make it easy to connect a camcorder to your TV. You can use your camcorder to view tapes without using a VCR.

- 1 Locate the A/V output jacks on the camcorder. They are usually found on the side or back of the camcorder.
- 2 Connect a set of audio cables between the AUDIO IN jacks on the TV and the AUDIO OUT jacks on the camcorder. If you have mono camcorder, connect L(mono) to camcorder audio out using only one audio cable.
- 3 Connect a video cable between the VIDEO IN (or S-VIDEO IN) jack on the TV and the VIDEO OUT jack on the camcorder. The audio-video cables shown here are usually included with a Camcorder. (If not, check your local electronics store.) If your camcorder is stereo, you need to connect a set of two cables.

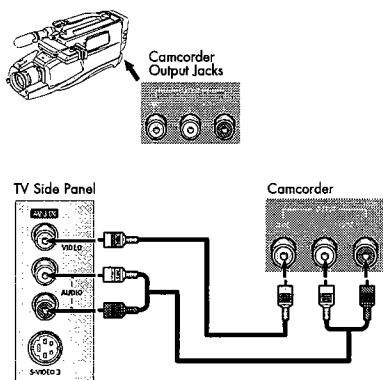

### Connecting a DVD Player

The rear panel jacks on your TV make it easy to connect a DVD player to your TV.

#### Connecting to Y,Pb,Pr

- 1 Connect a set of audio cables between the COMPONENT (1 or 2) AUDIO (L,R) IN jacks on the TV and the AUDIO OUT jacks on the DVD player.
- 2 To enable Component video viewing, connect a set of video cables between the COMPONENT (1 or 2) VIDEO (Y, Pb, Pr) IN jacks on the TV and VIDEO (Y, Pb, Pr (or Y, Cb, Cr) OUT jacks on the DVD player.

Note: For an explanation of Component video, see your DVD player's owner's manual.

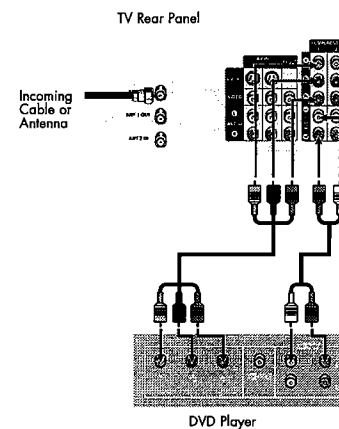

#### Connecting to audio and video jacks

- 1 Connect a set of audio cables between the AUDIO IN (1 or 2) jacks on the TV and the AUDIO OUT jacks on the DVD player.
- 2 Connect a video cable between the VIDEO IN (1 or 2) jack on the TV and the VIDEO OUT jack on the DVD player.

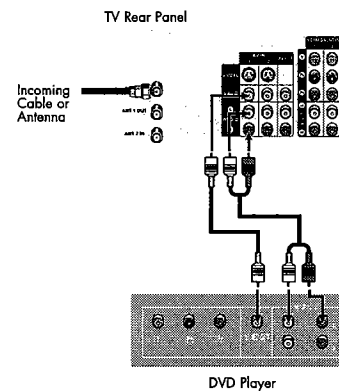

## Connections

### Connecting a DTV Set-Top Box

#### Connecting to Y,Pb,Pr

- 1 Connect a set of audio cables between the COMPONENT (1 or 2) AUDIO (L,R) IN jacks on the TV and the AUDIO OUT jacks on the Set-Top Box.
- 2 Connect a set of video cables between the COMPONENT (1 or 2) VIDEO (Y, Pb, Pr) IN jacks on the TV and VIDEO (Y, Pb, Pr (or Y, Cb, Cr) OUT jacks on the Set-Top Box.  
Note: For an explanation of Component video, see your Set Top Box owner's manual.

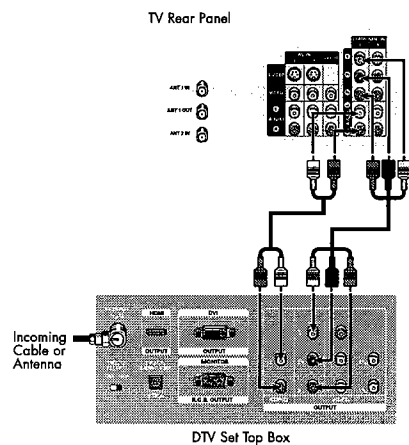

#### Connecting to DVI (Digital Visual Interface)

- 1 Connect a set of audio cables between the DVI AUDIO (L,R) IN jacks on the TV and the AUDIO OUT jacks on the Set-Top Box.
- 2 Connect a video cable between the DVI IN jack on the TV and the DVI OUT jack on the Set-Top Box.

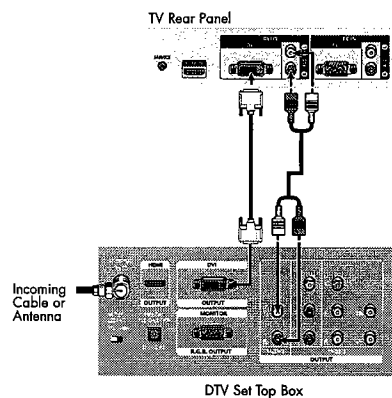

#### Connecting to R,G,B

- 1 Connect a set of audio cables between the PC AUDIO (L,R) IN jacks on the TV and the AUDIO OUT jacks on the Set-Top Box.
- 2 Connect a video cable between the PC IN jack on the TV and the R.G.B OUT jack on the Set-Top Box.

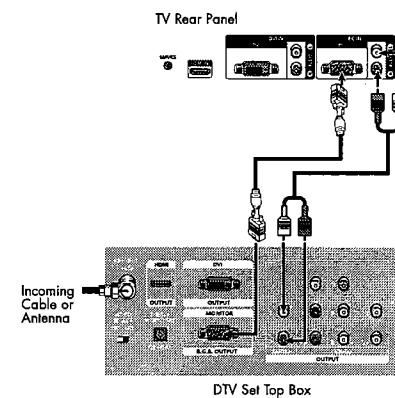

#### Connecting to HDMI (High Definition Multimedia Interface)

- 1 Connect a HDMI cable between the HDMI IN jack on the TV and the HDMI OUT jack on the Set-Top Box.

#### NOTE

- Please check if the power of HDMI source is on, in case that you fail to select HDMI from the "Source List" even after you connected the cable of HDMI source (DTV Set-Top Box, DVD, etc.) to TV.

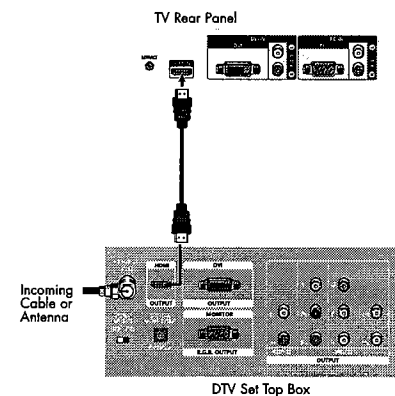

**Operation**

## Operation

### Turning the TV On and Off

Press the POWER button on the remote control.  
You can also use the POWER button on the front panel.

### Viewing the Menus and On-Screen Displays

The on-screen menu system allows you to control the settings of your TV. Access the on-screen menu system by pressing the MENU button on the remote control. Once the on-screen menu appears, use the ▲/▼/◀/▶/ENTER on your remote control to select menu items and make adjustments. You can also view the on-screen menu system and make some adjustments using the TV's side panel buttons.

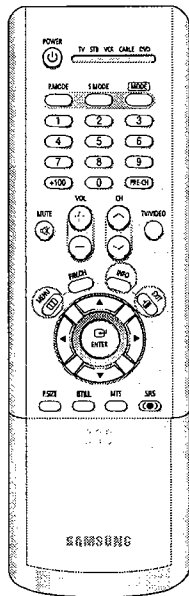

#### Viewing the Menus

- 1 Press the MENU button.  
The main menu is displayed.  
There are five menu groups: "Input", "Picture", "Sound", "Channel" and "Setup".

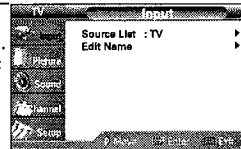

- 2 Press the ▲ or ▼ button to select to an item you want in the menu.  
Press the ◀, ▶ or ENTER button to display, change, or use the selected items.  
Use the ENTER button to enter items in the menu.

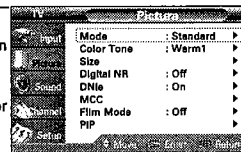

- 3 Press the EXIT button to exit.

#### Viewing the Display

Press the INFO button on the remote control.  
The TV displays the current channel, the status of certain picture and sound settings and the current time.

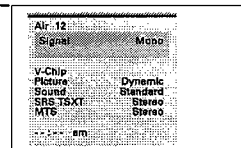

### Selecting the Menu Language

Choose a language for the on-screen menus: English, Spanish or French.

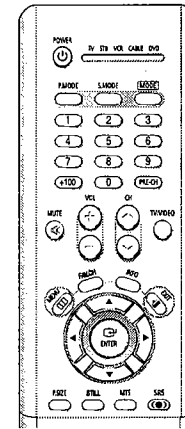

- 1 Press the MENU button.  
Press the ▲ or ▼ button to select "Setup", then press the ENTER button.

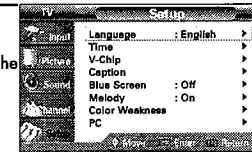

- 2 Press the ENTER button to select "Language".  
Press the ▲ or ▼ button to select the appropriate language, then press ENTER button.

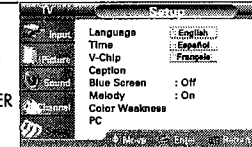

Press the EXIT button to exit.

### Selecting the Antenna Input

You can connect to two different signal sources by choosing the antenna input (1 or 2).

- 1 Press the MENU button.  
Press the ▲ or ▼ button to select "Channel", then press the ENTER button.

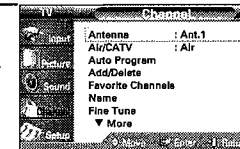

- 2 Press the ENTER button to select "Antenna".  
Press the ▲ or ▼ button to select "Ant.1" or "Ant.2", then press ENTER button.

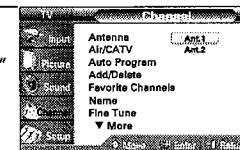

Press the EXIT button to exit.

## Operation

### Memorizing the Channels

Your TV can memorize and store all of the available channels for both "off-air" (antenna) and cable channels. After the available channels are memorized, use the CH $\wedge$  and CH $\vee$  buttons to scan through the channels. This eliminates the need to change channels by entering the channel digits. There are three steps for memorizing channels: selecting a broadcast source, memorizing the channels (automatic) and adding/deleting channels (manual).

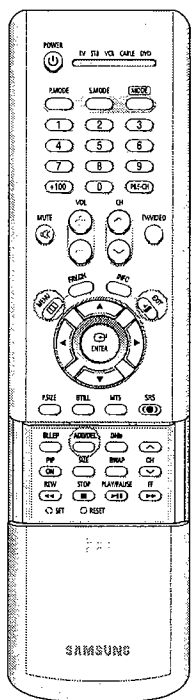

#### Selecting the Video Signal Source

Before your TV can begin memorizing the available channels, you must specify the type of signal source that is connected to the TV (i.e., an antenna or a cable system).

- 1 Press the MENU button. Press the  $\blacktriangle$  or  $\blacktriangledown$  button to select "Channel", then press the ENTER button.

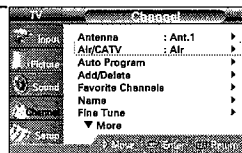

- 2 Press the  $\blacktriangle$  or  $\blacktriangledown$  button to select "Air/CATV", then press the ENTER button. If you are connected to an antenna, press the  $\blacktriangle$  or  $\blacktriangledown$  button to select "Air". If you connected cable, press the  $\blacktriangle$  or  $\blacktriangledown$  button to select the type of cable system: "STD", "HRC" or "IRC".

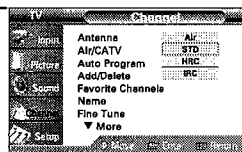

Press the EXIT button to exit.

#### NOTES

- "STD", "HRC" and "IRC" identify various types of cable TV systems. Contact your local cable company to identify the type of cable system that exists in your particular area. At this point the signal source has been selected. Proceed to "Storing Channels in Memory".
- Subscription cable services require service-specific requirement for viewing.

### Storing Channels in Memory (Automatic Method)

First, select the correct signal source ("Air", "STD", "HRC" or "IRC") as described on the previous page.

- 1 Press the MENU button. Press the  $\blacktriangle$  or  $\blacktriangledown$  button to select "Channel", then press the ENTER button.

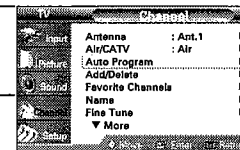

- 2 Press the  $\blacktriangle$  or  $\blacktriangledown$  button to select "Auto Program", then press the ENTER button. Press the ENTER button to start the auto program. The TV begins memorizing all of the available stations. Press the ENTER button at any time to interrupt the memorization process.

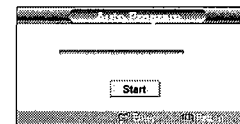

Press the EXIT button to exit.

### Adding and Erasing Channels

You can add channels that were not memorized or delete unwanted channels from memory.

- 1 Press the MENU button. Press the  $\blacktriangle$  or  $\blacktriangledown$  button to select "Channel", then press the ENTER button.

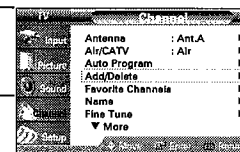

- 2 Press the  $\blacktriangle$  or  $\blacktriangledown$  button to select "Add/Delete", then press the ENTER button. Repeatedly pressing the ENTER button will alternate between add channel and delete channel. Press the CH $\wedge$  or CH $\vee$  button (or number buttons) to switch to the appropriate channel, then repeat above.

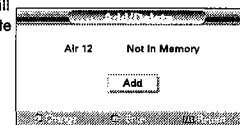

Press the EXIT button to exit.

#### Alternate method

Simply press the ADD/DEL button on the remote control to add or delete channels.

## Operation

### Changing Channels

You can change channels on your TV by using the CH $\wedge$  and CH $\vee$  buttons, or by direct selection using the number buttons. You can use the number buttons to tune to any channel (even one that has been erased or has not been memorized).

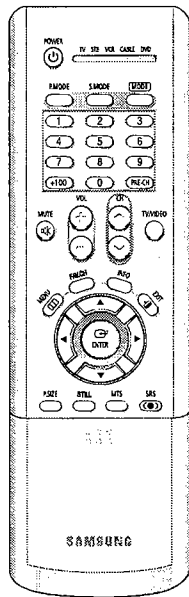

#### Using the Channel Buttons

Press the CH $\wedge$  or CH $\vee$  button to change channels. When you press the CH $\wedge$  or CH $\vee$  button, the TV changes channels in sequence. You will see all the channels that the TV has memorized. (The TV must have memorized at least three channels.) You will not see channels that were either erased or not memorized.

#### Using the Number Buttons

Press the number buttons to go directly to a channel. When you use the number buttons, you can directly select channels that were either erased or not memorized.

For example, to select channel "27", press the "2", then "7". The TV will change channels when you press the second number.

To change to single-digit channels (0-9) faster, press the "0" before the single digit. (For channel "4", press the "0", then "4".)

To select a channel over 100, press the +100 button. (For channel "122", press the +100 button, then "2", then "2".)

#### Using the Previous Channel

Press the PRE-CH button. The TV changes to the last channel you were watching.

### Selecting Your Favorite Channels

You can store your favorite channels for each available input source (such as TV and CATV). This allows you to quickly and easily find frequently watched channels by pressing the FAV.CH button on the remote control.

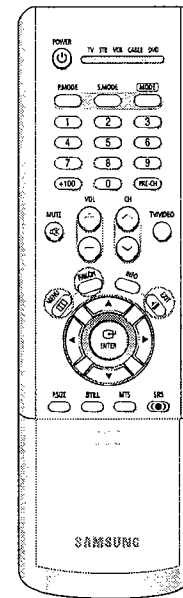

#### To Store Your Favorite Channels:

1 Press the MENU button. Press the  $\blacktriangle$  or  $\blacktriangledown$  button to select "Channel", then press the ENTER button.

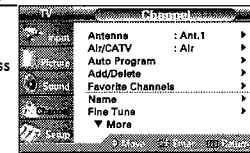

2 Press the  $\blacktriangle$  or  $\blacktriangledown$  button to select "Favorite Channels", then press the ENTER button. Press the  $\blacktriangle$  or  $\blacktriangledown$  button to select a channel, then press the ENTER button. Press the ENTER button again to deselect the selected channel.

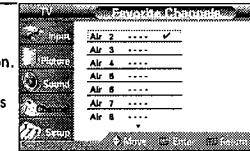

Press the EXIT button to exit.

#### To View Your Favorite Channels:

Press the FAV.CH button repeatedly to jump from one favorite channel to another.

#### NOTE

- Only memorized channels can be set as Favorite channels.





# Operation

## Picture Control

You can use the on-screen menus to change the "Contrast", "Brightness", "Sharpness", "Color" and "Tint" according to personal preference. (Alternatively, you can use one of the automatic settings. See next page.)

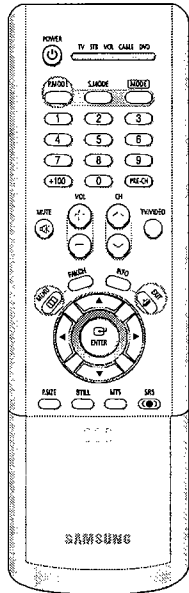

### Customizing the Picture

**1** Press the MENU button. Press the ▲ or ▼ button to select "Picture", then press the ENTER button.

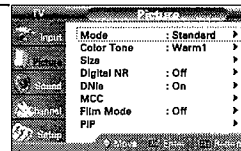

**2** Press the ENTER button to select "Mode".

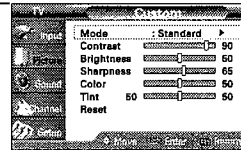

**3** Press the ▲ or ▼ button to select a particular item, then press the ENTER button.



Press the ◀ or ▶ button to increase or decrease the value of a particular item.

### Resetting the Picture Settings to the Factory Defaults

You can return to the factory default picture settings.

**4** Press the MENU button to display the "Custom" menu. Press the ▲ or ▼ button to select "Reset", then press the ENTER button. The previously adjusted picture settings will be reset to the factory defaults.

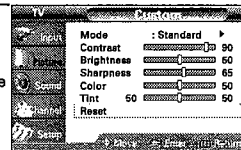

#### NOTE

- "Tint" doesn't operate in PC, DVI, HDMI or 480p-Component or higher modes.

### Using Automatic Picture Settings

Your TV has automatic picture settings ("Dynamic", "Standard" and "Cinema") that are preset at the factory. You can activate either "Dynamic", "Standard" or "Cinema" by pressing the P.MODE button (or by making a selection from the menu). Or, you can select "Custom" which automatically recalls your personalized picture settings.

**1** Press the MENU button. Press the ▲ or ▼ button to select "Picture", then press the ENTER button.

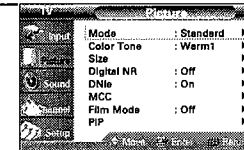

**2** Press the ENTER button to select "Mode".

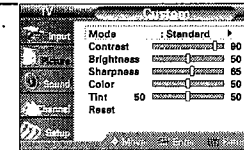

**3** Press the ENTER button again to select "Mode". Press the ▲ or ▼ button to select a particular item, then press the ENTER button.

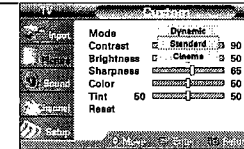

Press the EXIT button to exit.

### Alternate method

Press the P.MODE button on the remote control repeatedly to select one of the standard picture settings.

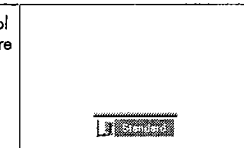

- Choose "Dynamic" for viewing the TV during the day or when there is a bright light in the room.
- Choose "Standard" for the standard factory settings.
- Choose "Cinema" when viewing a movie.



## Operation

### Setting the Clock

Setting the clock is necessary in order to use the various timer features of the TV. Also, you can check the time while watching the TV. (Just press the INFO button.)

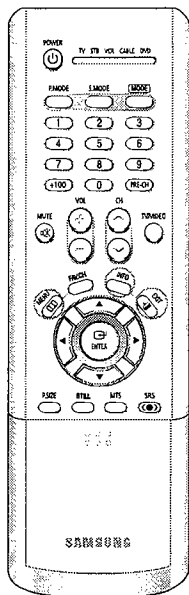

- 1 Press the MENU button. Press the ▲ or ▼ button to select "Setup", then press the ENTER button. Press the ▲ or ▼ button to select "Time", then press the ENTER button.

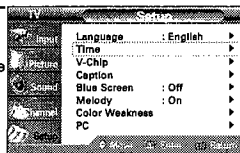

- 2 Press the ENTER button to select "Clock Set".



- 3 Press the ◀ or ▶ button to move to "Hour", "Min" or "am/pm". Set the clock you want by pressing the ▲ or ▼ button, then press the ENTER button.

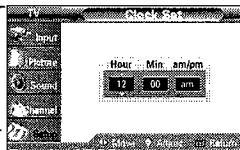

Press the EXIT button to exit.

#### NOTES

- The current time will appear every time you press the INFO button.
- You can set the hour and minute directly by pressing the number buttons on the remote control.

#### Absent Power Off

When you set the timer "On", your television will eventually be turned off, if you do not operate any controls during the 3 hours after the TV is turned on by timer. This function is available in only the timer "On" mode and will prevent a leakage accident or overheating, caused by your TV left on for a long time due to the timer "On" (when you are away on holiday, for example).

### Setting the Timers

This TV can be set to turn on or off automatically at specific times that you choose. Before using the timers, you must set the TV's clock, as described previously.

#### Setting the On/Off Timer

- 1 Press the MENU button. Press the ▲ or ▼ button to select "Setup", then press the ENTER button.

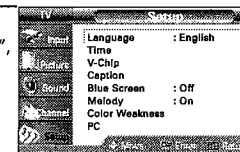

- 2 Press the ▲ or ▼ button to select "Time", then press the ENTER button. Press the ▲ or ▼ button to select "On Timer", then press the ENTER button.



- 3 Press the ▲ or ▼ button to adjust "Hour", then press the ▶ button to move to the next step. Set other items using the same method as above. When finished, press the MENU button to return.



- 4 Press the ▲ or ▼ button to select "Off Timer", then press the ENTER button.

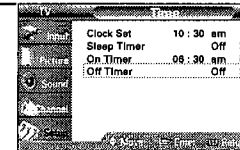

- 5 Press the ▲ or ▼ button to adjust "Hour", then press the ▶ button to move to the next step. Set other items using the same method as above.



Press the EXIT button to exit.

## Operation

### Setting the Sleep Timer

The sleep timer automatically shuts off the TV after a preset time (from 30 to 180 minutes).

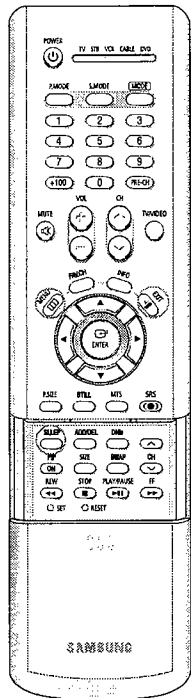

- 1 Press the MENU button. Press the ▲ or ▼ button to select "Setup", then press the ENTER button.

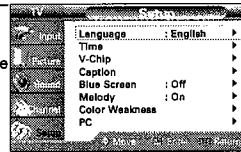

- 2 Press the ▲ or ▼ button to select "Time", then press the ENTER button. Press the ▲ or ▼ button to select "Sleep Timer", then press the ENTER button.

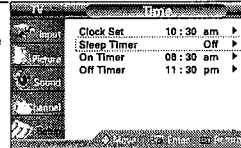

- 3 Press the ▲ or ▼ button to select "Sleep Timer", then press the ENTER button.

Press the ▲ or ▼ button to select the preset time you want, then press the ENTER button.



Press the EXIT button to exit.

#### Alternate method

Press the SLEEP button on the remote control repeatedly until the appropriate time interval appears (any of the preset values from "30 Min." to "180 Min.>").

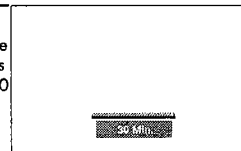

#### NOTE

- If no signal is received for 15 minutes, the TV will be automatically turned off.

### Viewing an External Signal Source

Use the remote control to switch between viewing signals from connected equipment, such as VCR, DVD, Set-Top box and the TV source (broadcast or cable).

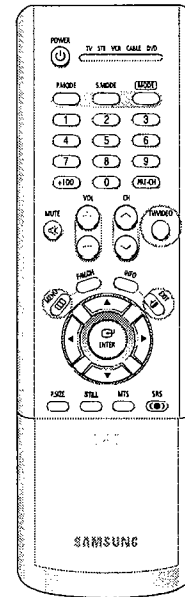

#### Setting the Signal Source

- 1 Press the MENU button. Press the ENTER button to select "Input".

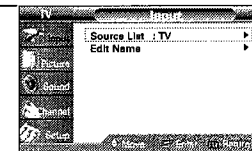

- 2 Press the ENTER button to select "Source List". Press the ▲ or ▼ button to select a signal source, then press the ENTER button.

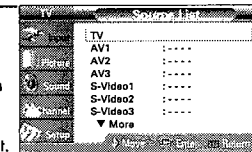

Press the EXIT button to exit.

#### Alternate method

Press the TV/VIDEO button on the remote control repeatedly to select an external signal source.

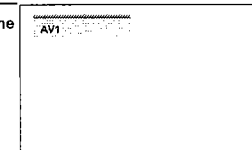

#### NOTE

- When you connect equipment to the TV, you can choose between the following sets of jacks: "AV1", "AV2", "S-Video1", "S-Video2", "Component1", "Component2", "PC", "DVI" or "HDMI" on the TV's rear panel, and "AV3" or "S-Video3" on the TV's side panel.

## Operation

### Assigning Names to External Input Mode

This feature enables you to name the input source you have connected.

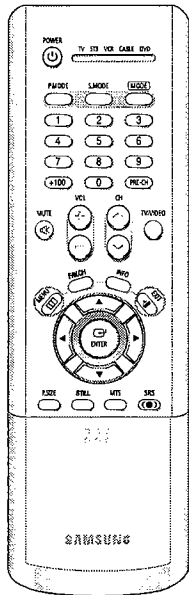

- 1 Press the MENU button. Press the ENTER button to select "Input".

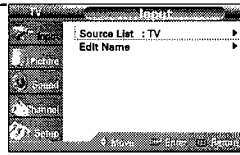

- 2 Press the ▲ or ▼ button to select "Edit Name", then press the ENTER button.

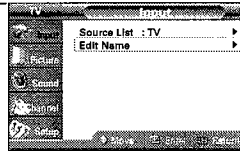

- 3 Press the ▲ or ▼ button to select a signal source, then press the ENTER button. Press the ▲ or ▼ button to select an external device, then press the ENTER button.

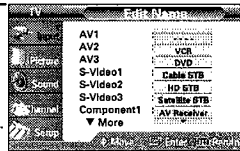

Press the EXIT button to exit.

### Freezing the Current Picture

You can freeze the picture when watching a television programme simply by pressing the STILL button. To return to normal viewing, press it again.

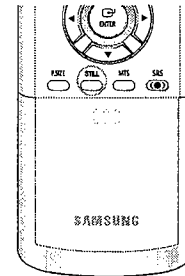

#### NOTE

- In the PIP mode, the main and sub pictures are stilled at the same time.

### Remote Control VCR/DVD Buttons

Flip the cover of the remote control up to access buttons that can control the tape functions of a connected VCR or DVD, including Rewind, Stop, Play/Pause and Fast Forward.

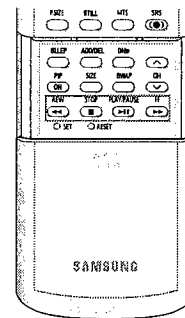

Slide the cover of your remote control unit for access to the tape function controls. Press the appropriate buttons to control your VCR or DVD.



# Special Features

# Special Features

## Customizing Your Remote Control

Your TV comes equipped with a universal remote control. In addition to controlling the TV, the universal remote control can also operate a Set-Top Box, VCR, Cable box and DVD (even if your VCR, Cable box and DVD are made by manufacturers other than Samsung).

### NOTE

- The remote control might not be compatible with all VCRs, DVD players and Cable boxes.

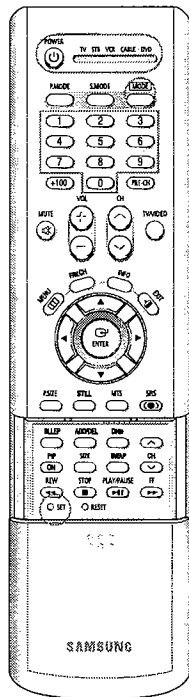

### Setting Up Your Remote Control to Operate Your VCR (Cable box or DVD player)

- Turn off your VCR (Cable box or DVD player).
- Press the MODE button to switch the remote control to the VCR (CABLE or DVD) mode. The remote control has five modes: TV, STB, VCR, CABLE and DVD.
- On your Samsung remote control, press the SET button.
- Enter 3 digits of the VCR (Cable box or DVD player) code listed on next page for your brand of VCR (Cable box or DVD player). Make sure you enter 3 digits of the code, even if the first digit is a "0". (If more than one code listed, try the first one.)
- Press the POWER button. Your VCR (Cable box or DVD player) should turn on. If your VCR (Cable box or DVD player) turns on, your remote control is now set correctly. If your VCR (Cable box or DVD player) does not turn on, repeat steps 2, 3, and 4, but try one of the other codes listed for the brand of your particular VCR (Cable box or DVD player).
- Once your remote control is set up, press the MODE button any time you want to use the remote to operate your VCR (Cable box or DVD player).

### NOTES

- When your remote is in the TV mode, the VCR (or DVD player) control buttons (REW, STOP, PLAY/PAUSE and FF) will still operate your VCR (or DVD player).
- When your remote control is in the STB, VCR, CABLE or DVD mode, the volume buttons still control your TV's volume.

## Remote Control Codes

### VCR Codes

000 Samsung	018 Candie, Citizen, Emerson, (IG)Goldstar, Radio Shack, Realistic, Sears, Toshiba, Teknico, Television	036 Electrolux, Emerson, Radio Shack, Realistic, Sharp	059 Pioneer
001 (IG)Goldstar		037 RCA	060 J.C. Penney
002		038 Magnavox, Marantz, Philips, Philips, Sylvania	061 Candie, Citizen, Portland
003		039 J.C. Penney, JCL, Kenwood, Marantz, NEC, Teac, Teac	062 Canon, Curtis Mathes, General Electric, J.C. Penney, Magnavox, Panasonic, Philips, Radio Shack, Realistic, Sylvania
004 Doewoo	019 Braksonic, Emerson		
005	021 Craig, Fisher, Radio Shack, Realistic, Sanyo, Seon	040 Logi'l, Mulltech, Skinton	063 RCA
006		041 General Electric, Mulltech, Sanyo, Toshiba	064 Skinton
007 Doewoo, (IG)Goldstar	022 Audio Dynamics, Candie, Citizen, Doewoo, Emerson, Samsung	042 Pioneer	065 Magnavox, Philips, Sylvania
008 Doewoo		043 Emerson	066 Emerson
009 Curtis Mathes, Dinnensio, General Electric, PROSCAN, RCA	023 Calorima, Curtis Mathes, DB, (IG)Goldstar, Harmon Kardon, J.C. Penney, JCL, Kenwood, Marantz, NEC	044 Hitachi, J.C. Penney, Philips, RCA, Sears	067 Fisher
010		045 Hitachi	069 (IG)Goldstar
011 Bell & Howell, Fisher, J.C. Penney, JCL, Kenwood, Marantz, NEC, Quartz, Radio Shack, Realistic, Sanyo, Sears, Tandy	024 Anwa, Curtis Mathes, Dynatech, Emerson, Funai, Hitachi, Iloyd, IUI, MIC, Mulltech, Radio Shack, Realistic, Signature, Sylvania, Symphonic, Tandy, Teac, Teknico	046 RCA	070 Marantz, NEC
012		047 Sony	071 Curtis Mathes, NEC
013		048 Sharp	072 Emerson
014 Hitachi, J.C. Penney, Philips, Philips, RCA, Sears, Toshiba		049 Emerson, Samsung	073 Emerson, IMK
015 Admiral, Optima, Radio Shack, Realistic, Sharp	025 Audio Dynamics, DB, J.C. Penney, JCL, Kenwood, Marantz, NEC	050 Emerson, Scott	074 RCA, Teac
016 Candie, Citizen, Craig, Curtis Mathes, General Electric, Go Video, J.C. Penney, MIC, Mulltech, RCA, Samsung, Television	026 Alka, Shinton, Sanyo	051 Emerson, Samsung	075 Emerson
	027 Fisher, Sears	052 Fisher, Radio Shack, Realistic, Sears, Sanyo	076 KUH
	028 Fisher, Radio Shack, Realistic, Sears, Toshiba	053 Portland, Quasar	077 Panasonic
	029 Emerson	054 Candie, Citizen, Doewoo, Portland, Sharp	078 Doewoo
	030 Teknico	055 Candie, Citizen, Curtis Mathes, (IG)Goldstar, JCL, Kenwood, Marantz, NEC, Paces Research	079 Panasonic
	031 Alka, Samsung		080 Doewoo
	032 Alka, Emerson	056 Emerson	081 Panasonic
	035 Shinton, Sony	057 Fisher, Sears, Toshiba	082 Doewoo
		058 Emerson, Scott, Toshiba	083 Panasonic
017 Canon, Curtis Mathes, Emerson, General Electric, Instant Replay, J.C. Penney, JCL, Magnavox, Marantz, Panasonic, Philips, Philips, Quasar, Radio Shack, Realistic, RCA, Sylvania, Technico, Teknico	036		084 Philips
	037		085 Doewoo
			086 Panasonic
			087 KUH
			088 Admiral

### Cable Box Codes

000 Samsung	020 Eastern International, Hamlin, Regal	038 GI, Jerrold	057 Tocom
001 Magnavox	021 Hamlin, Regal	039 Uniko	058 Universal
002 Daehyung/Tang	022 Zenith	040 Magnavox, Philips, Uniko, Viewstar	059 Universal
003 Daehyung			060 Universal
004 Daehyung	023 GI, Jerrold	041 Magnavox, Philips, Regency, Viewstar	063 Tocom
005 Daehyung	024 Ost, Oak Sigma		065 Zenith
006 (IG)Goldstar	025 Tocom	042 Hamlin	066 Stargate 2000
007 Doewoo	026 Pioneer	044 GI, Jerrold	067 Sylvania, Tecom
008 RCA	027 Magnavox, Philips, Viewstar	045 Hitachi, Mocom	069 Panasonic, Zenith
009 Regency	028 Pioneer	046 Ost	070 Jerrold
010 Philips, Panasonic, Regal, Samsung	029 Magnavox, Philips, Tocom, Viewstar	047 Panasonic	071 Samsung
011	030 Samsung	048 Magnavox, Philips, Viewstar	072 Samsung
012 GI, Hamlin, Jerrold		049 Magnavox, Philips, Uniko, Viewstar	073 Jerrold
013 GI, Jerrold	031 GI, Jerrold		074 RCA
014 Amazon, Cable Star, Eagle, Viewstar	032	050 Zenith	075 RCA
	033	051 Hitachi, Mocom	076 GI
	034 Magnavox, Philips, Viewstar	052 Pioneer, Samsung, Warner Ames	077
	035 RCA, Panasonic, Spacostar	054 General Instrument, Hitachi, Jerrold, Signature, Starcom	
017 NSC	036	056 Hamlin	
019 Sylvania, Tecom	037 Magnavox, Philips, Viewstar		

### DVD Codes

000 Samsung	003 JVC	006 Panasonic	009 Curtis Mathes
001 (IG)Goldstar	004 Sony	007 Philips	
002 Toshiba	005 Sharp	008 PROSCAN, RCA	

## Special Features

### Fine Tuning Channels

The Fine Tuning function lets you manually adjust the TV's tuner if you have difficulty tuning channels.

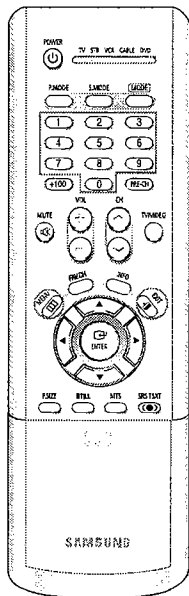

**1** Using the number buttons on the remote control, select the channel you want to fine tune.

**2** Press the MENU button. Press the ▲ or ▼ button to select "Channel", then press the ENTER button.

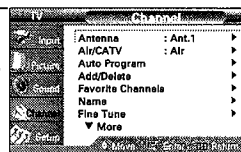

**3** Press the ▲ or ▼ button to select "Fine Tune", then press the ENTER button.

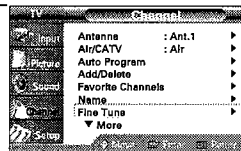

**4** Press the ◀ or ▶ button to adjust the fine tuning.

To store the fine tuning setting in the TV's memory, press the ENTER button. The symbol "\*" is displayed.

To reset the fine tuning to "0", select "Reset" by pressing the ▲ or ▼ button, then press the ENTER button.

Press the EXIT button to exit.

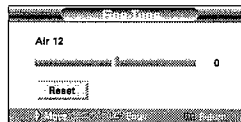
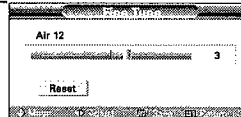

### LNA (Low Noise Amplifier)

This feature is very useful in the situation that the TV is used in a weak signal, and amplifies the TV signal in the weak signal area, but not noise.

This feature is working only in a weak signal condition, and that is memorized on relevant channel's additional information.

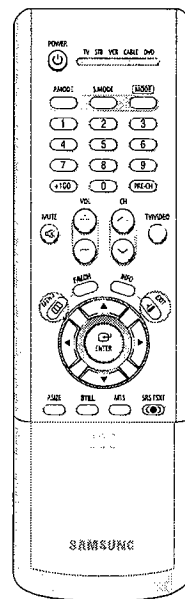

**1** Press the MENU button. Press the ▲ or ▼ button to select "Channel", then press the ENTER button.

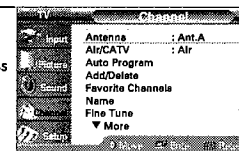

**2** Press the ▲ or ▼ button to select "LNA", then press the ENTER button.

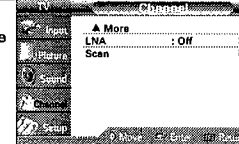

**3** Press the ▲ or ▼ button to select "On" or "Off", then press the ENTER button.

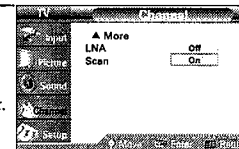

Press the EXIT button to exit.

#### NOTE

- This function works in "ANT 1 IN" mode only (not available in "ANT 2 IN" mode).



## Special Features

### Selecting the Color Tone

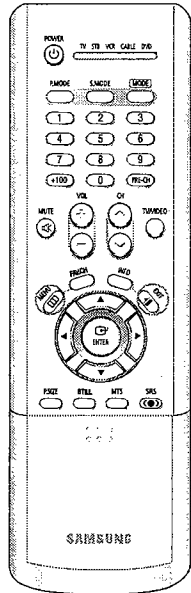

**1** Press the MENU button. Press the ▲ or ▼ button to select "Picture", then press the ENTER button.

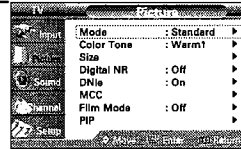

**2** Press the ▲ or ▼ button to select "Color Tone", then press the ENTER button.

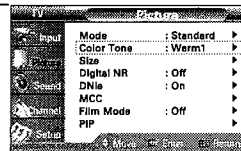

**3** Press the ▲ or ▼ button to select "Cool2", "Cool1", "Normal", "Warm1" or "Warm2", then press the ENTER button.

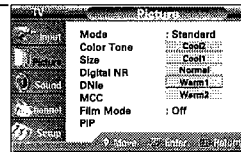

Press the EXIT button to exit.

### Changing the Picture Size

You can select the picture size which best corresponds to your viewing requirements.

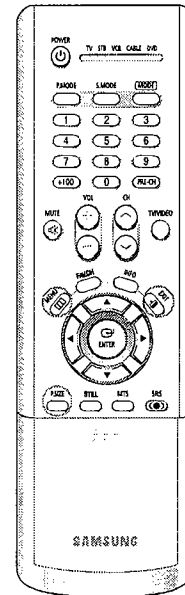

**1** Press the MENU button. Press the ▲ or ▼ button to select "Picture", then press the ENTER button. Press the ▲ or ▼ button to select "Size", then press the ENTER button.

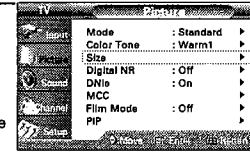

**2** Press the ◀ or ▶ button to select the screen format you want, then press the ENTER button.

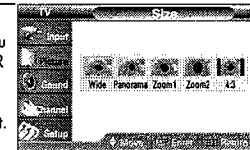

Press the EXIT button to exit.

#### Alternate method

Press the P.SIZE button on the remote control repeatedly to select one of the picture size settings.

- "Wide": Sets the picture to 16:9 wide mode.
- "Panorama": Use this mode for the wide aspect ratio of a panoramic picture.
- "Zoom1": Magnifies the size of the picture on screen. You can also move the picture on screen using the scroll function. Press the ▲ or ▼ button to scroll the picture.
- "Zoom2": Magnifies the size of the picture more than "Zoom1". You can also move the picture on screen using the scroll function. Press the ▲ or ▼ button to scroll the picture.
- "4:3": Sets the picture to 4:3 normal mode. This is a standard TV screen size.

#### NOTES

- You can select only Wide, 4:3 screen size in the Component(480p, 720p, 1080i) Mode.
- With PIP On, the screen automatically becomes wide in the Antenna, AV (1~3), S-Video (1~3) or Component (480i) mode. With PIP Off, it returns to original screen size.
- The picture size can't be changed when the "PIP" is active in the TV or AV mode.

## Special Features

### Digital Noise Reduction

If the broadcast signal received by your TV is weak, you can activate the Digital Noise Reduction feature to help reduce any static and ghosting that may appear on the screen.

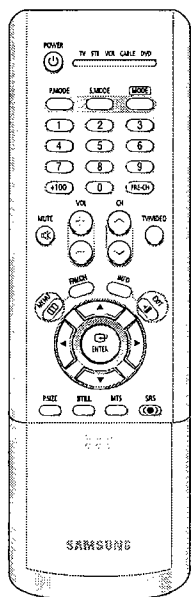

- 1 Press the MENU button. Press the ▲ or ▼ button to select "Picture", then press the ENTER button.

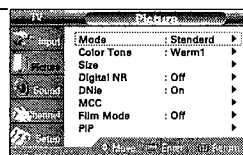

- 2 Press the ▲ or ▼ button to select "Digital NR", then press the ENTER button.

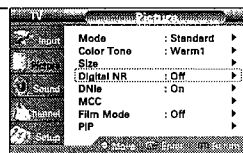

- 3 Press the ▲ or ▼ button to select "Off" or "On", then press the ENTER button. Press the EXIT button to exit.

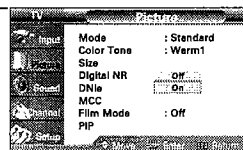

### DNle™ (Digital Natural Image engine) **DNle™**

This feature brings you more detailed image with 3D noise reduction, detail enhancement, contrast enhancement and white enhancement. New image compensation Algorithm presents brighter, clearer, much detailed image. DNle™ technology will fit every signals into your eyes.

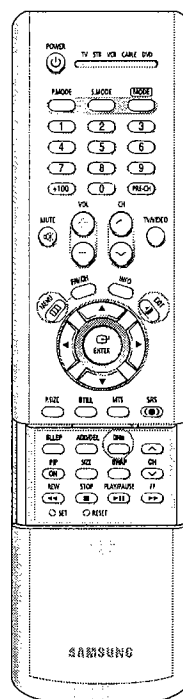

- 1 Press the MENU button. Press the ▲ or ▼ button to select "Picture", then press the ENTER button.

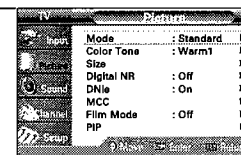

- 2 Press the ▲ or ▼ button to select "DNle", then press the ENTER button.

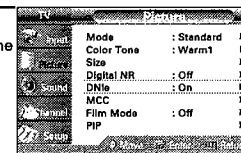

- 3 Press the ▲ or ▼ button to select "Off", "Demo" or "On", then press the ENTER button.

Press the EXIT button to exit.

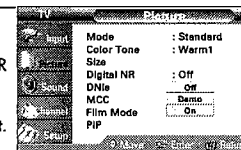

#### Alternate method

Press the DNle button on the remote control repeatedly to select one of the settings.

- On: Switches on the DNle mode.
- Off: Switches off the DNle mode.
- Demo: The screen before applying DNle appears on the right and the screen after applying DNle appears on the left.

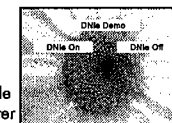

## Special Features

### Setting the MCC (My Color Control) Mode

MCC allows users to adjust colors according to their preferences, by adjusting skin, sky, and grass tones using the predefined settings ("Turkish Blue", "Emerald Green", "Italian Pink", "Standard", "Custom") without affecting other colors on the screen.

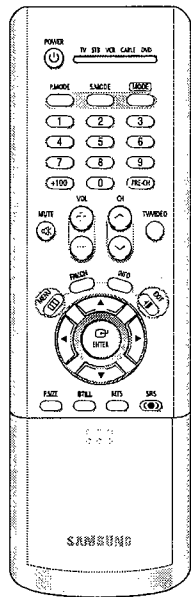

#### Using the Easy Control Menu

**1** Press the MENU button. Press the ▲ or ▼ button to select "Picture", then press the ENTER button.

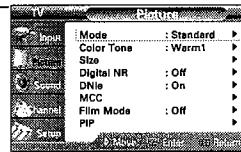

**2** Press the ▲ or ▼ button to select "MCC", then press the ENTER button.

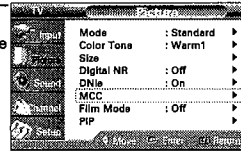

**3** Press the ENTER button to select "Easy Control". Press the ◀ or ▶ button to select one of the picture settings you want. The original picture (before adjustment) is shown on the left side, while the selected mode is shown on the right side.



Press the ENTER button to accept the selected mode.

Press the EXIT button to exit.

#### NOTE

• Changing the settings in the "Detail Control" menu (see next page) will automatically set the MCC mode to "Custom".

- "Turkish Blue": Emphasizing Clear Blues. Feel the clear sun shine on the blue Mediterranean sea.
- "Emerald Green": Emphasizing Mild Greens. Feel the translucent, romantic turquoise sea.
- "Italian Pink": Emphasizing Warm Skin Colors.
- "Standard": Standard Picture

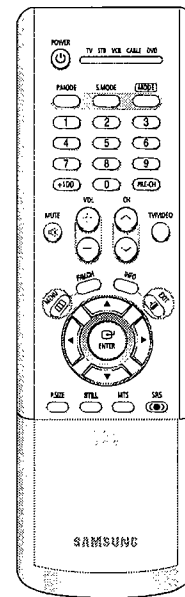

#### Custom Settings

**1** Press the MENU button. Press the ▲ or ▼ button to select "Picture", then press the ENTER button. Press the ▲ or ▼ button to select "MCC", then press the ENTER button.

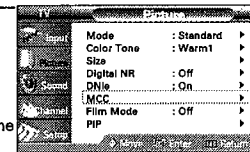

**2** Press the ▲ or ▼ button to select "Detail Control", then press the ENTER button.



**3** Press the ▲ or ▼ button to select one of the MCC color you want, then press the ENTER button. There are three MCC colors: "Skin Tone", "Green Grass" and "Blue Sky".



Press the ◀ or ▶ button to adjust the value of a color selected. Changing the adjustment value will refresh the adjusted screen.

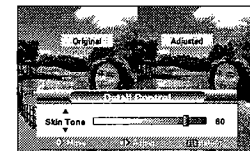

#### Resetting the MCC Colors to the Factory Defaults

You can return to the factory default settings for MCC colors.

**4** Press the MENU button to display the "Detail Control" menu. Press the ▲ or ▼ button to select "Reset", then press the ENTER button. The previously adjusted MCC Colors will be reset to the factory defaults.



## Special Features

### Setting the Film Mode

You can automatically sense and process film signals from all sources and adjust the picture for optimum quality.

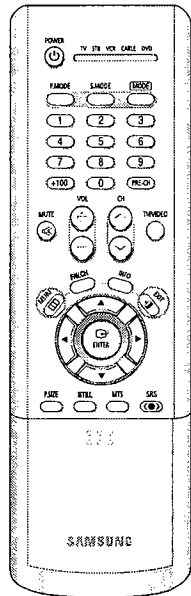

- 1 Press the MENU button. Press the ▲ or ▼ button to select "Picture", then press the ENTER button.

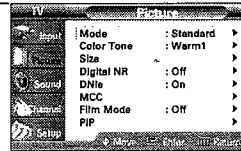

- 2 Press the ▲ or ▼ button to select "Film Mode", then press the ENTER button.

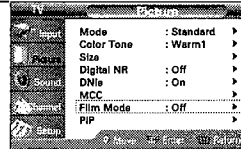

- 3 Press the ▲ or ▼ button to select "Off" or "On", then press the ENTER button.

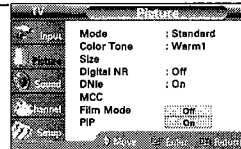

Press the EXIT button to exit.

#### NOTE

- Film mode is supported in 480i only.

### Viewing Picture-In-Picture

One of the most best features of your TV is the Picture-In-Picture (PIP) feature. The advanced PIP system allows you to watch two different pictures at once, even if you don't have a VCR connected to your TV.

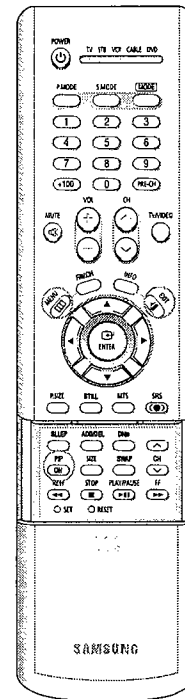

#### Activating the PIP

- 1 Press the MENU button. Press the ▲ or ▼ button to select "Picture", then press the ENTER button.

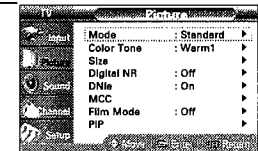

- 2 Press the ▲ or ▼ button to select "PIP", then press the ENTER button.

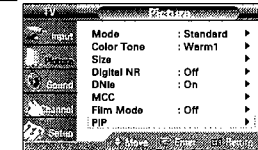

- 3 Press the ENTER button to select "PIP". Press the ▲ or ▼ button to select "On", then press the ENTER button. The sub picture appears in the corner of the screen.

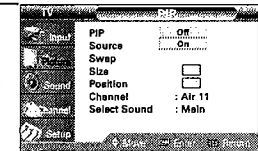

Press the EXIT button to exit.

#### Alternate method

Press the PIP button on the remote control repeatedly to activate or deactivate the PIP.

#### NOTES

- This feature doesn't function when the "V-Chip" or "Caption" is active.
- This feature doesn't operate in the HDMI mode.
- If you turn the TV off while watching and turn it on again, then the mode will return to normal video.



## Special Features

### Changing the Size of the Sub Picture

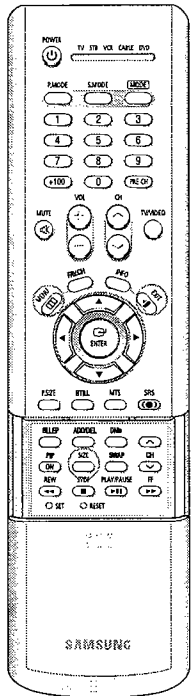

**1** Press the MENU button. Press the ▲ or ▼ button to select "Picture", then press the ENTER button.

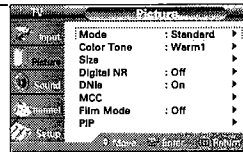

**2** Press the ▲ or ▼ button to select "PIP", then press the ENTER button.

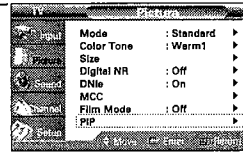

**3** Press the ▲ or ▼ button to select "Size", then press the ENTER button.

Press the ▲ or ▼ button to select a size you want, then press the ENTER button.

Press the EXIT button to exit.

#### Alternate method

Press the SIZE button on the remote control repeatedly to select one of the settings.

#### NOTE

- "□□" (Double 1) function doesn't operate in the "HDMI" mode.

### Changing the Location of the Sub Picture

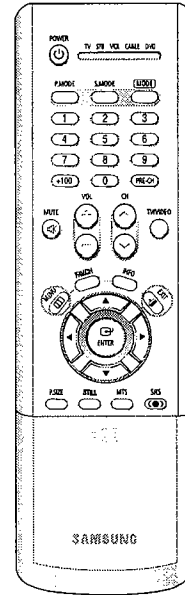

**1** Press the MENU button. Press the ▲ or ▼ button to select "Picture", then press the ENTER button.

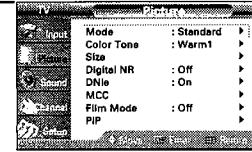

**2** Press the ▲ or ▼ button to select "PIP", then press the ENTER button.

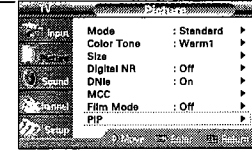

**3** Press the ▲ or ▼ button to select "Position", then press the ENTER button.

Press the ▲ or ▼ button to select a position you want, then press the ENTER button.

Press the EXIT button to exit.



## Special Features

### Setting the SRS TSXT

TruSurround XT is a patented SRS technology that solves the problem of playing 5.1 multichannel content over two speakers. Trusurround delivers a compelling, virtual surround sound experience through any two-speaker playback system, including internal television speakers. It is fully compatible with all multichannel formats.

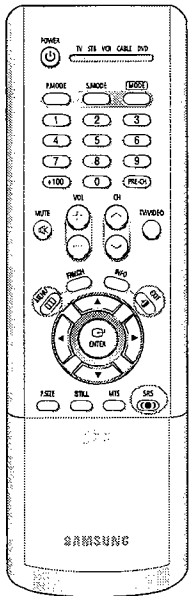

- 1 Press the MENU button. Press the ▲ or ▼ button to select "Sound", then press the ENTER button.

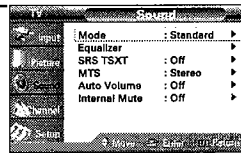

- 2 Press the ▲ or ▼ button to select "SRS TSXT", then press the ENTER button.

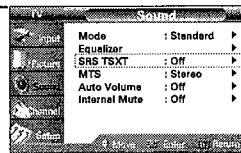

- 3 Press the ▲ or ▼ button to select "Off", "3D Mono" or "Stereo", then press the ENTER button.

Press the EXIT button to exit.

#### Alternate method

Press the SRS TSXT button on the remote control repeatedly to select one of the settings.

### Choosing a Multi-Channel Sound (MTS) track

Depending on the particular program being broadcast, you can listen to "Mono", "Stereo" or "SAP (Separate Audio Program)". "SAP" audio is usually a foreign-language translation. Sometimes "SAP" has unrelated information like news or weather.

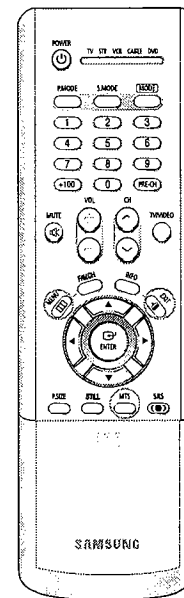

- 1 Press the MENU button. Press the ▲ or ▼ button to select "Sound", then press the ENTER button.

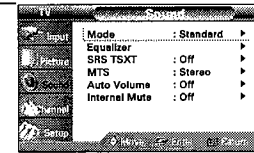

- 2 Press the ▲ or ▼ button to select "MTS", then press the ENTER button.

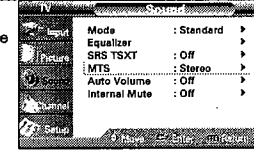

- 3 Press the ▲ or ▼ button to select "Mono", "Stereo" or "SAP", then press the ENTER button.

Press the EXIT button to exit.

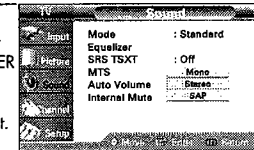

#### Alternate method

Press the MTS button on the remote control repeatedly to select one of the settings.

- Choose "Mono" for channels that are broadcasting in mono, or if you are having difficulty receiving a stereo signal.
- Choose "Stereo" for channels that are broadcasting in stereo.
- Choose "SAP" to listen to the Separate Audio Program, which is usually a foreign-language translation.