

- 4 After inserting the plastic hangers of the PDP panel into the groove of the wall attachment panel (1), lift down (2) and tightly hang the PDP panel on the wall attachment panel.

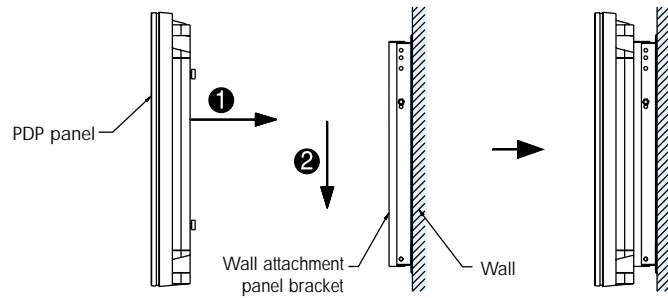

Adjusting the angle of the wall attachment panel

Adjust the angle you want before installing the wall attachment panel on the wall.
Notice : The factory default angle is 5 degrees.

Changing the angle to 0 degree

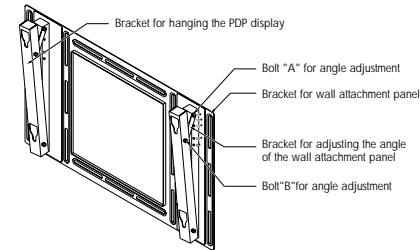

- 1 Loosen the screws for adjusting the wall attachment panel, "A" and "B".
- 2 Remove the bracket for adjusting the angle of the wall attachment panel.
- 3 Fit the bracket for hanging the PDP display into the hole on the PDP display.
- 4 Fit the screw for adjusting the wall attachment panel into the hole indicated by 0 degree and tighten it again.

Factory default

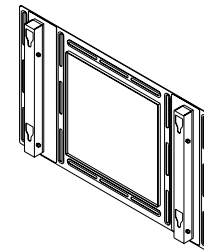

The factory default angle of wall attachment panel is 5 degrees.

Changing the angle to 10 degrees

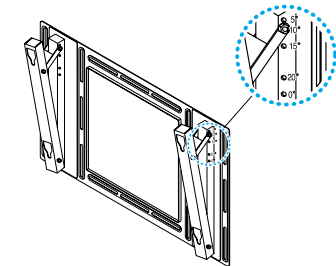

- 1 Loosen the screw for adjusting the wall attachment panel, "A".
- 2 Fit the bracket for angle adjustment to the hole indicated by 10 degrees on the wall attachment panel.
- 3 Fit the screw "A" for adjusting the wall attachment panel to the hole indicated by 0 degree and tighten it again.

• Change the angle to 15 degrees, 20 degrees and other degrees in the same methods as 10 degrees.

SAMSUNG

P L A S M A D I S P L A Y P A N E L

Connections



Connecting VHF and UHF Antennas	20
Connecting Cable TV	21
Connecting Speakers	23
Connecting a VCR	24
Connecting a Camcorder	25
Connecting a DVD Player	26
Connecting a DTV Receiver	27



Connecting VHF and UHF Antennas

Antennas with 75-ohm Round Leads

If your antenna looks like this:  it has 75-ohm round leads.

- 1 Plug the antenna lead into the VHF/UHF terminal on the PDP. Use the Antenna Cable (BN39-00333A), an accessory included in the product package.

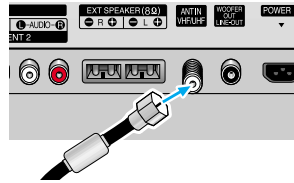

Connecting Cable TV

You can connect different cable systems to your PDP, including cable without a cable box, and cable with a cable box that descrambles some or all channels.

Cable without a Cable Box

- 1 Plug the incoming cable into the VHF/UHF terminal on the PDP. Use the Antenna Cable (BN39-00333A), an accessory included in the product package.

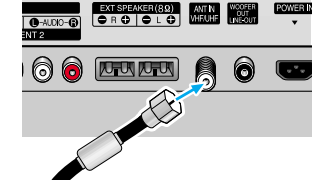

Cable with a Cable Box that Descrambles All Channels.

- 1 Find the cable connected to the ANTENNA OUT terminal on your cable box. This terminal might be labeled "ANT OUT", "VHF OUT", or simply "OUT".



- 2 Connect the cable to the VHF/UHF terminal on the PDP. Use the Antenna Cable (BN39-00333A), an accessory included in the product package.

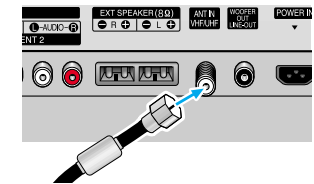



Connecting Speakers

External speakers are sold separately. Check with your dealer.

Cable with a Cable Box that Descrambles Some (But Not All) Channels

To complete this connection you will need a two-way splitter, a RF (A/B) switch, and four coaxial cables (which you can buy from your Samsung dealer or any electronics store).

- 1 Find and disconnect the cable that is connected to the ANTENNA IN terminal of your cable box. This terminal might be labeled "ANT IN", "VHF IN", or simply, "IN". Connect this cable to a two-way splitter.

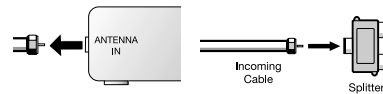

- 2 Connect a coaxial cable between an OUTPUT terminal of the splitter and the IN terminal of the cable box.

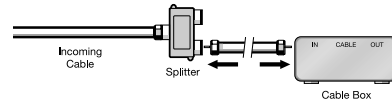

- 3 Connect a coaxial cable between the ANTENNA OUT terminal of the cable box and the B-IN terminal of the A/B switch.

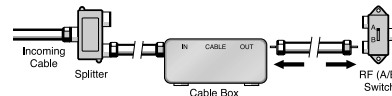

- 4 Connect a coaxial cable between the ANTENNA OUT terminal of the cable box and the B-IN terminal of the A/B switch.

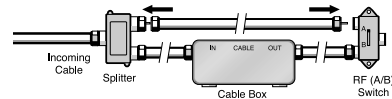

- 5 Connect the last coaxial cable between the OUT terminal of the RF (A/B) switch and the VHF/UHF terminal on the PDP.

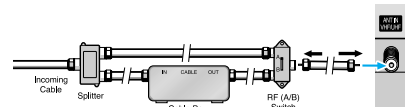

After you've made this connection, set the A/B switch to the "A" position for normal viewing. Set the A/B switch to the "B" position to view scrambled channels. (When you set the A/B switch to "B", you will need to tune your Set-Top Box to the cable box's output channel, which is usually channel 3 or 4.)

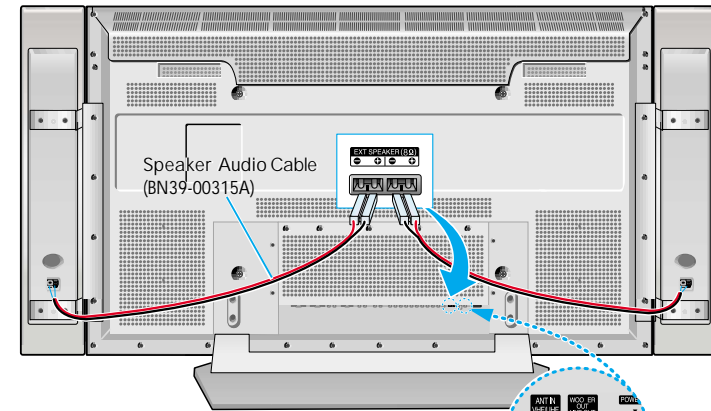

* External speakers MUST have a power handling capability of 10 watts minimum (impedance 8 ohm).

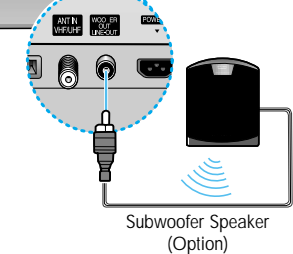

How to Connect

Connect the speaker audio cable to the external speaker output jack on the PDP matching the "+" and "-" ends of the cable with the diagram on the PDP.

Connecting PDP and Speakers

- 1 Fix the bracket onto the guide pole located on the rear of speaker and fasten the screws.
- 2 After removing the four screws on the rear of PDP.
- 3 As shown in figure, insert the loop on a speaker into the groove on the PDP.
- 4 Clamp the speaker and the PDP together and fasten the screws.

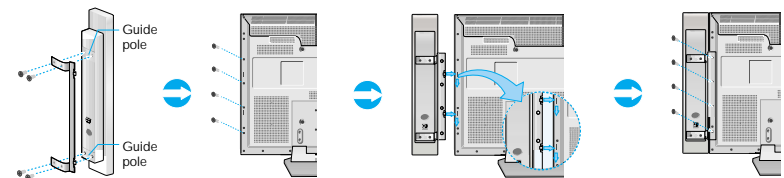



Connecting a VCR

Connecting a VCR to the Video or S-Video/Audio jack

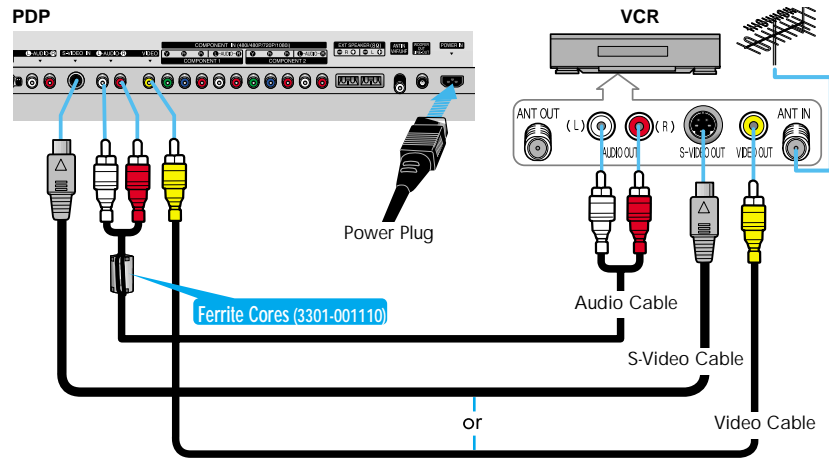

How to Connect

Connect the Video/Audio cables between the AUDIO(L/R)/VIDEO jacks on the PDP and AUDIO/AUDIO OUT jacks on the VCR. (Note: For better video, you can use an S-Video cable.)

Videotape Playback:

1. Turn on your PDP, and press the SOURCE button on the remote control.
2. Move the joystick up or down to select "Video" or "S-Video", then press the joystick to enter.
3. Turn on your VCR, insert a videotape and press the play button.

Ferrite Cores (3301-001110)

The ferrite cores are used to attenuate undesired signals. When connecting audio cable (PC, DVI, S-Video, Video), attach one of these ferrite cores to the cable near the connector.

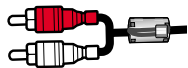

When you connect the audio cable (PC, DVI, S-Video, Video) to the connectors, first bind round the ferrite core to secure it.



Connecting a Camcorder

Viewing camcorder tapes

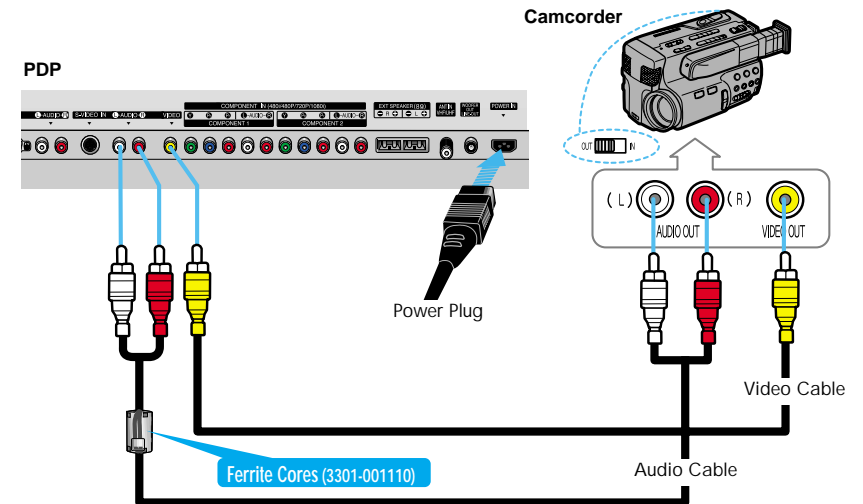

How to Connect

Connect a Video/Audio cable between the AUDIO(L/R)/VIDEO jacks on the PDP and the VIDEO/AUDIO OUTPUT jacks on the camcorder.

Viewing Tapes

1. Turn on your PDP, and press the SOURCE button on the remote control.
2. Move the joystick up or down to select the "Video", then press the joystick to enter.
3. Turn on your camcorder and set it to Video Mode. (For details, refer to your camcorder owner's instructions.)
4. Set the IN/OUT switch on your camcorder to OUT.
5. Insert the tape into the camcorder and press the Play button.



Connecting a DVD Player (480i, 480p)

Playing DVD

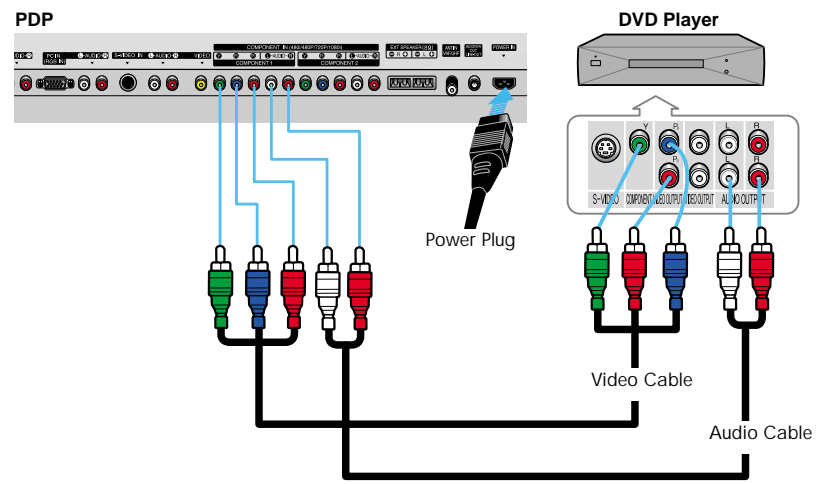

How to Connect

- 1 Connect a Video Cable between the Y, Pb, Pr (COMPONENT1, 2) input jacks on the PDP and Y/P_b/P_r output jacks on the DVD players.
- 2 Connect a Audio Cable between the AUDIO L/R(COMPONENT1, 2) input jacks on the PDP and the AUDIO OUT jacks on the DVD player.

To Play DVD:

1. Turn on your PDP, and press the SOURCE button on the remote control.
2. Move the joystick up or down to select the "COMPONENT1" or "COMPONENT2", then press the joystick to enter.
3. Turn on your DVD player, insert a DVD disc and press the Play button.
 - For an explanation of Component video, see your DVD owner's instructions.



Connecting a DTV Receiver (480p, 720p, 1080i)

Watching DTV

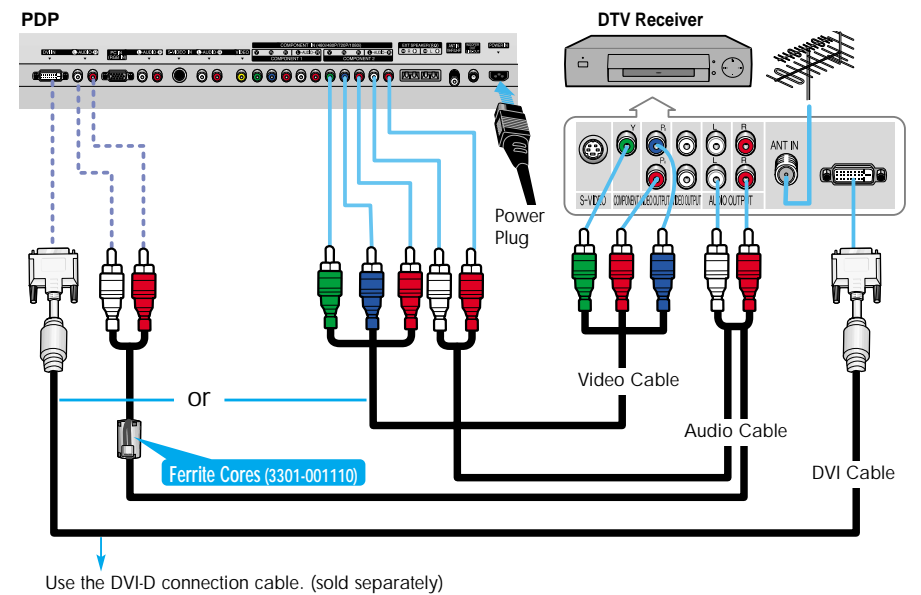

Use the DVI-D connection cable. (sold separately)

How to Connect

- 1 Connect the cable or antenna to the antenna input jack on the DTV.
- 2 Connect a Video cable between the Y, Pb, Pr (COMPONENT 1, 2) or DVI jack on the PDP and the Y, P_b, P_r (VIDEO OUTPUT JACKS) on the DTV receiver.
- 3 Connect an Audio cable between the COMPONENT 1, 2 (L/R AUDIO) or DVI jacks on the PDP and the AUDIO OUTPUT jacks on the DTV.

To Watch DTV:

1. Turn on your PDP, and press the SOURCE button on the remote control.
2. Move the joystick up or down to select the "COMPONENT1", "COMPONENT2" or "DVI", then press the joystick to enter.
3. Turn on your DTV receiver.
 - For an explanation of Component video, see your DTV receiver owner's instructions.

SAMSUNG

P L A S M A D I S P L A Y P A N E L

Operation



Turning the PDP On and Off	30
Memorizing the Channels.....	32
Setting Up Your Remote Control	36



Turning the PDP On and Off

Turning the PDP On and Off

Press the Power button on the remote control. The PDP will be turned on and you will be ready to use its features.

You can also use the Power button on the front of the PDP.

Notes:

- If your PDP isn't turned on when the power button is pressed: Press the MODE button to check if the TV mode has been chosen (TV VCR Cable DVD).

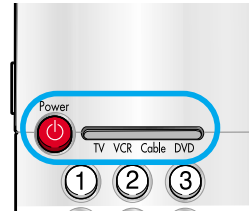

Displaying Status Information

Press the Display button on the remote control. The PDP will display the Picture mode, Sound mode, MTS, Signal and Caption.

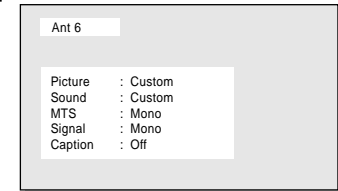

Viewing the Menus and Displays

Your PDP has a simple, easy-to-use menu system that appears on the PDP screen. This system makes it convenient and fast to use features on the PDP. Your PDP also lets you display the status of many of your PDP's features.

Viewing the Menus

- 1 With the power on, press the Menu button on the remote control. The main menu appears on the screen. The Picture menu is selected.

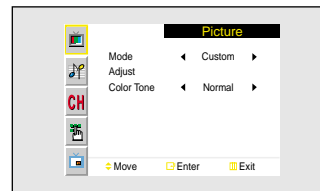

- 2 Use the joystick (up, down) button to move items in the menu. Use the joystick (left, right) button to display, change, or use the selected items. Use the joystick (Enter) button to enter items in the menu. On screen menus disappear from the screen automatically after about thirty seconds, or you can press the Menu button on your remote control to exit the menu.





Memorizing the Channels

Your PDP can memorize and store all of the available channels for both "off-air" (antenna) and cable channels. After the available channels are memorized, use the CH ^ and CH v buttons to scan through the channels. This eliminates the need to change channels by entering the channel digits. There are three steps for memorizing channels: selecting a broadcast source, memorizing the channels (automatic) and adding and deleting channels (manual).

Selecting the Video Signal-source

Before your television can begin memorizing the available channels, you must specify the type of signal source that is connected to the PDP (i.e., an antenna or a cable system).

- 1 Press the Menu button. Move the joystick up or down to select "Channel", then press the joystick to enter.

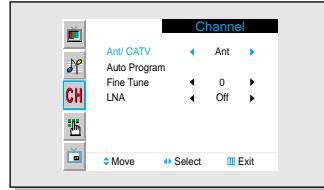

- 2 Move the joystick left or right to select "Ant", "STD", "HRC" or "IRC".
 - If you are connected to an antenna, leave "Ant" displayed. If you connected cable, Move the joystick left or right to the display the type of cable system: "STD", "HRC", or "IRC". (If you are not sure which type of cable system you have, contact your cable company).

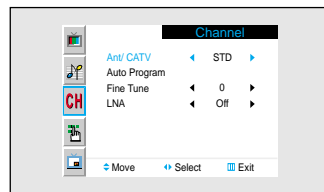

- 3 Press the Menu button to exit.

Note

- STD, HRC and IRC identify various types of cable TV systems. Contact your local cable company to identify the type of cable system that exists in your particular area. At this point the signal source has been selected. Proceed to "Storing Channels in Memory" (next page).

Storing Channels in Memory (Automatic Method)

- 1 First, select the correct signal source (Ant, STD, HRC, IRC). See steps on previous page. Press the Menu button. Move the joystick up or down to select the "Channel", then press the joystick to enter.

Quick way to access the Automatic Channel Setting : Just press the "Auto Program" button on the remote control.

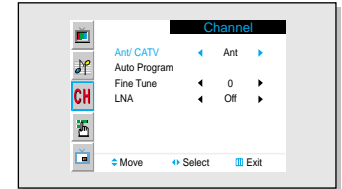

- 2 Move the joystick up or down to select "Auto Program", then press the joystick to enter.

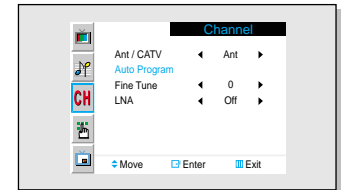

- 3 The PDP will begin memorizing all of the available channels. After all the available channels are stored, the Auto program menu reappears. Move the joystick right to exit.

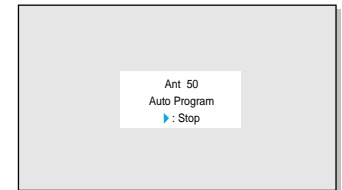

Note

- The PDP automatically cycles through all of the available channels and stores them in memory. This takes about one to two minutes.

Adding and Erasing Channels (Manual Method)

1 Use the number buttons to directly select the channel that will be added or erased.

Ex) Channel "4"

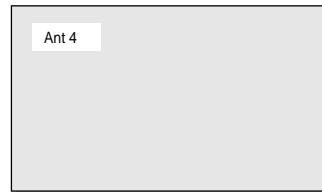

2 Press the Add/Erase button: Repeatedly pressing this button will alternate between "Added" and "Erased."

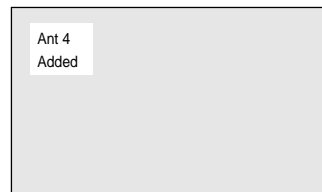
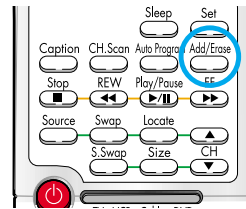

Note

- You can view any channel (including an erased channel) by using the number buttons on the remote control.

Changing Channels

Using the Channel Buttons

Press the CH \wedge or CH \vee buttons to change channels.

When you press the CH \wedge or CH \vee buttons, the PDP changes channels in sequence. You will see all the channels that the PDP has memorized. (The PDP must have memorized at least three channels.) You will not see channels that were either erased or not memorized.

To View Memorized Channel

Press the CH.Scan button or the Channel button. Only the memorized channels are chosen.

Directly Accessing Channels

Press the number buttons to go directly to a channel. For example, to select channel 27, press "2" then "7". The TV will change channels when you press the second number.

When you use the number buttons, you can directly select channels that were either erased or not memorized. To change to single-digit channels (0-9) faster, press "0" before the single digit. (For channel "4" press "0" then "4".)

Using the Pre-CH button to select the previous channel

Press the Pre-CH button. The TV will switch to the last channel viewed.

To quickly switch between two channels that are far apart, tune to one channel, then use the number button to select the second channel. Then, use the Pre-CH button to quickly alternate between them.

Adjusting the Volume

Using the Volume Buttons

Press the VOL + or VOL - buttons to increase or decrease the volume.

Using Mute

Using the Mute Buttons

At any time, you can temporarily cut off the sound using the Mute button.

1 Press the Mute button and the sound cuts off. The word "Mute" will appear in the lower-left corner of the screen.

2 To turn mute off, press the Mute button again, or simply press either the VOL + or VOL - button.





Setting Up Your Remote Control



This PDP's remote control can operate almost any VCR, cable box, or DVD. After it has been set up properly, your remote control can operate in four different modes :TV, VCR, Cable, or DVD. Pressing the corresponding button on the remote control allows you to switch between these modes, and control whichever piece of equipment you choose.

Note: The remote control may not be compatible with all DVD Players, VCRs, and Cable boxes.

Setting Up the Remote to Operate Your VCR, Cable box, or DVD player

1 Turn off your VCR. (or Cable box, DVD player.)

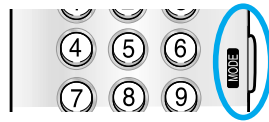

2 Press the MODE button and make sure that the VCR (or Cable box, DVD) LED is illuminated.

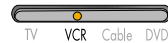

3 Press the Set button on your TV's remote control.

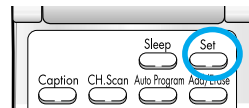

4 Using the number buttons on your remote control, enter three digits of the VCR (or Cable box, DVD) code listed on page 37 of this manual for your brand of VCR (or Cable box, DVD player). Make sure you enter three digits of the code, even if the first digit is a "0".
(If more than one code is listed, try the first one.)



5 Press the Power button on the remote control. Your VCR (or Cable box, DVD player) should turn on if your remote is set up correctly. If your VCR (or Cable box, DVD player) does not turn on after set up, repeat steps 2, 3, and 4, but try one of the other codes listed for your brand of VCR (or Cable box, DVD player).
If no other codes are listed, try each code, 000 through 089 (or Cable box: 000 through 077, DVD player: 000 through 008).



Notes

- When your remote control is in "VCR" mode, the VCR control buttons (Stop, REW, Play/Pause, FF) still operate your VCR.
- When your remote control is in "Cable box" or "DVD" mode, the VCR control buttons (Stop, REW, Play/Pause, FF) still operate your VCR.

Remote Control Codes

VCR Codes

Admiral	006, 079	KLH	073	RCA	000, 005, 007, 008, 028, 035, 037, 054, 069
Aiwa	015	LG	009, 014, 046, 060	Samsung	007, 013, 022, 032, 042, 077
Akai	017, 022, 023, 027, 030	Lloyd	015	Sansui	016
Audio Dynamics	014, 016	Logik	031	Sanyo	002, 012
Bell & Howell	002	LXI	015	Scott	013, 041, 049, 068
Broksonic	010	Magnavox	008, 029, 053, 056	Sears	002, 005, 009, 012, 018, 019, 035, 043, 048
Candle	007, 009, 013, 045, 046, 052	Marantz	002, 008, 014, 016, 029, 030, 046, 061	Sharp	006, 027, 039, 045
Cannon	008, 053	Marta	009	Shintom	017, 026, 031, 055
Citizen	007, 009, 013, 045, 046, 052	MEI	008	Signature	015
Colortyme	014	Memorex	008, 009, 012, 015	Sony	017, 026, 038
Craig	007, 012	MGA	027	Sylvania	008, 015, 029, 053, 056
Curtis-Mathes	000, 007, 008, 014, 015, 046, 053, 064, 067	Midland	032	Symphonic	015
Daewoo	013, 045, 076	Minota	005, 035	Tandy	002, 015
DBX	014, 016	Mitsubishi	005, 027, 035, 040	Tashiko	009
Dimensia	000	Montgomery ward	006	Tatung	030
Dynatech	015	MTC	007, 015	Teac	015, 030, 069
Electrohome	027	Multitech	007, 015, 031, 032	Technics	008
Emerson	008, 009, 010, 013, 015, 020, 023, 027, 034, 041, 042, 047, 049, 057, 062, 065, 067, 068, 070	NEC	002, 014, 016, 030, 046, 061, 064	Ternika	008, 009, 015, 021
Fisher	002, 012, 018, 019, 043, 048, 058	Optimus	006	TMK	067
Funai	015	Panasonic	008, 053, 075, 077	Toshiba	005, 013, 019, 048, 049
GE	000, 007, 008, 032, 053	Pentax	005, 035	Totevision	007, 009
Go Video	007	Pentax Reserch+	046	Unitech	007
Harman Kardon	014	Philco	008, 029, 053, 056	Vector Research	014, 016
Hitachi	005, 015, 035, 036	Philips	008, 029	Victor	016
Instant Replay	008	Pioneer	005, 016, 033, 050	Video Concepts	014, 016
JC Penney	002, 005, 007, 008, 014, 016, 030, 035, 051, 053	Portland	044, 045, 052	Videosonic	007
JCL	008, 002, 014, 016, 030, 046	ProScan	000	Wards	005, 006, 007, 008, 009
JVC	002, 014, 088, 089	Quartz	002	Yamaha	002, 014, 016, 030, 046
Kenwood	002, 014, 016, 030, 046	Quasar	008, 053	Zenith	011, 017, 026, 079
		Radio Shack/Realist	002, 006, 008, 009, 012, 015, 019, 027, 045, 053		

Cable Box Codes

Anvision	007, 008	NSC	009	Signature	046
Cablestar	007, 008	Oak	016, 038	Sprucer	027
Eagle	007, 008	Osk Sigma	016	Starcom	046
Eastern Int.	002	Panasonic	003, 027, 039, 061, 073, 074	Stargate 2000	058
General Instrument	046	Philips	007, 008, 019, 021, 026, 028, 029, 032, 033, 040, 041	Sylvania	011, 059
GI	004, 005, 015, 023, 024, 025, 030, 036, 067, 068, 069	Pioneer	018, 020, 044, 074, 077	Texscan	011, 059
Hamlin	003, 012, 013, 034, 048	Randtek	007, 008	Tocom	017, 021, 049, 050, 055, 073
Hitachi	037, 043, 046	RCA	000, 027, 066	Unika	031, 032, 041
Jerroid	004, 005, 015, 023, 024, 025, 030, 036, 046, 062, 065	Regal	003, 012, 013	Universal	051, 052
Macom	037, 043	Regency	002, 033	Viewster	007, 008, 019, 021, 026, 028, 029, 032, 033, 040, 041
Magnavox	007, 008, 019, 021, 026, 028, 029, 032, 033, 040, 041	SA	070, 071, 072	Warner Amex	044
		Samsung	044, 003, 022, 063, 064	Zenith	014, 042, 057, 061, 075, 076

DVD Codes

Philips	001
Proscan	002
RCA	002
Toshiba	003
Panasonic	004
Sony	008
Samsung	000