

Notices

No part of this publication may be reproduced, stored in a retrieval system, or transmitted, in any form or by any means, mechanical photocopying, recording or otherwise, without the prior written permission of the manufacturer.

The information within this manual is subject to change without notice.

The manufacturer shall not be held liable for technical or editorial errors or omissions contained in herein; nor for incidental or consequential damages resulting from the furnishing, performance or use of this material.

Microsoft Windows is a registered trademark of the Microsoft Corporation.

Product names mentioned herein are for identification purposes only, and may be trademarks and/or registered trademarks of their respective companies.

Macrovision Statement

If your computer has a DVD drive and an analog TV Out port, the following paragraph applies:

This product incorporates copyright protection technology that is protected by method claims of certain U.S. patents and other intellectual property rights owned by Macrovision Corporation and other rights owners. Use of this copyright protection technology must be authorized by Macrovision Corporation, and is intended for home and other limited viewing uses only unless otherwise authorized by Macrovision Corporation. Reverse engineering or disassembly is prohibited.

Copyright 2003 All rights are reserved

Important Safety Information

Safety Instructions

Your system is designed and tested to meet the latest standards for safety of information technology equipment. However, to ensure safe use of this product, it is important that the safety instructions marked on the product and in the documentation are followed.



Always follow these instructions to help guard against personal injury and damage to your system.

Setting Up your System

- Read and follow all instructions marked on the product and in the documentation before you operate your system. Retain all safety and operating instructions for future use.
- Do not use this product near water or a heat source such as a radiator.
- Set up the system on a stable work surface.
- The product should be operated only with the type of power source indicated on the rating label.
- Ensure that the electrical outlet you are using to power your equipment is easily accessible in case of fire or short circuit.
- If your computer has a voltage selector switch, make sure that the switch is in the proper position for your area.
- Openings in the computer case are provided for ventilation. Do not block or cover these openings. Make sure you provide adequate space, at least 6 inches (15 cm), around the system for ventilation when you set up your work area. Never insert objects of any kind into the computer ventilation openings.
- Ensure that the fan vents on the bottom of the casing are clear at all times. Do not place the computer on a soft surface, doing so will block the bottom vents.
- If you use an extension cord with this system, make sure that the total ampere rating on the products plugged into the extension cord does not exceed the extension cord ampere rating.

Care During Use

- Do not walk on the power cord or allow anything to rest on it.
- Do not spill anything on the system. The best way to avoid spills is to not eat or drink near your system.
- Some products have a replaceable CMOS battery on the system board. There is a danger of explosion if the CMOS battery is replaced incorrectly. Replace the battery with the same or equivalent type recommended by the manufacturer. Dispose of batteries according to the manufacturer's instructions. If the CMOS battery requires replacement insure that a qualified technician performs the task
- When the computer is turned off, a small amount of electrical current still flows through the computer. To avoid electrical shock, always unplug all power cables, remove the battery and modem cables from the wall outlets before cleaning the system.
- Unplug the system from the wall outlet and refer servicing to qualified personnel if:
 - The power cord or plug is damaged.
 - Liquid has been spilled into the system.
 - The system does not operate properly when the operating instructions are followed.
 - The system was dropped or the casing is damaged.
 - The system performance changes.

The Instruction On Safety Operation of NotePC

1. At installation and operation of devices it is necessary to carry out requirements of the user's guide.
2. Devices can be used only with the equipment specified in the technical specifications of the devices.
3. At operation of devices it is necessary to carry out the basic requirements
4. At occurrence of malfunctions in the device (a smell of burnt isolation, a smoke, etc.), it is necessary to disconnect the equipment from the power supply and to not to inserted back before reparation.
5. Service and reparation of devices should be carried out by experts of the manufacturer.

Technical director of the service center

Replacement Parts and Accessories

Use only replacement parts and accessories recommended by manufacturer.



To reduce the risk of fire, use only No. 26 AWG or larger telecommunications line cord.



Do not use this product in areas classified as hazardous. Such areas include patient care areas of medical and dental facilities, oxygen rich environments, or industrial areas.

Battery Disposal



Do not put rechargeable batteries or products powered by non-removable rechargeable batteries in the garbage.

Contact the Samsung Helpline for information on how to dispose of batteries that you cannot use or recharge any longer.

Follow all local regulations when disposing of old batteries.

Laser Safety

All systems equipped with CD or DVD drives comply with the appropriate safety standards, including IEC 825. The laser devices in these components are classified as “Class 1 Laser Products” under a US Department of Health and Human Services (DHHS) Radiation Performance Standard. Should the unit ever need servicing, contact an authorized service location.



Laser Safety Note:

Use of controls or adjustments or performance of procedures other than those specified in this manual may result in hazardous radiation exposure. To prevent exposure to laser beams, do not try to open the enclosure of a CD or DVD drive.

Power Cord Requirements

The power cord set (wall plug, cable and AC adapter plug) you received with your computer meets the requirements for use in the country where you purchased your equipment.

Power cord sets for use in other countries must meet the requirements of the country where you use the computer. For more information on power cord set requirements, contact your authorized dealer, reseller, or service provider.

General Requirements

The requirements listed below are applicable to all countries:

- The length of the power cord set must be at least 6.00 feet (1.8m) and a maximum of 9.75 feet (3.0m).
- All power cord sets must be approved by an acceptable accredited agency responsible for evaluation in the country where the power cord set will be used.
- The power cord set must have a minimum current capacity of 7 A and a nominal voltage rating of 125 or 250 volts AC, as required by each country's power system.
- The appliance coupler must meet the mechanical configuration of an EN 60 320/IEC 320 Standard Sheet C7 connector, for mating with appliance inlet on the computer.

Regulatory Compliance Statements

Wireless Guidance

Low power, Radio LAN type devices (radio frequency (RF) wireless communication devices), operating in the 2.4 GHz Band, may be present (embedded) in your notebook system. The following section is a general overview of considerations while operating a wireless device.

Additional limitations, cautions, and concerns for specific countries are listed in the specific country sections (or country group sections). The wireless devices in your system are only qualified for use in the countries identified by the Radio Approval Marks on the system rating label. If the country you will be using the wireless device in, is not listed, please contact your local Radio Approval agency for requirements. Wireless devices are closely regulated and use may not be allowed.

The power output of the wireless device or devices that may be embedded in your notebook is well below the RF exposure limits as known at this time. Because the wireless devices (which may be embedded into your notebook) emit less energy than is allowed in radio frequency safety standards and recommendations, manufacturer believes these devices are safe for use. Regardless of the power levels, care should be taken to minimize human contact during normal operation.

As a general guideline, a separation of 20 cm (8 inches) between the wireless device and the body, for use of a wireless device near the body (this does not include extremities) is typical. This device should be used more than 20 cm (8 inches) from the body when wireless devices are on and transmitting.

This transmitter must not be collocated or operate in conjunction with any other antenna or transmitter.

Some circumstances require restrictions on wireless devices. Examples of common restrictions are listed below:



Radio frequency wireless communication can interfere with equipment on commercial aircraft. Current aviation regulations require wireless devices to be turned off while traveling in an airplane. 802.11B (also known as wireless Ethernet or Wifi) and Bluetooth communication devices are examples of devices that provide wireless communication.



In environments where the risk of interference to other devices or services is harmful or perceived as harmful, the option to use a wireless device may be restricted or eliminated. Airports, Hospitals, and Oxygen or flammable gas laden atmospheres are limited examples where use of wireless devices may be restricted or eliminated. When in environments where you are uncertain of the sanction to use wireless devices, ask the applicable authority for authorization prior to use or turning on the wireless device.



Every country has different restrictions on the use of wireless devices. Since your system is equipped with a wireless device, when traveling between countries with your system, check with the local Radio Approval authorities prior to any move or trip for any restrictions on the use of a wireless device in the destination country.



If your system came equipped with an internal embedded wireless device, do not operate the wireless device unless all covers and shields are in place and the system is fully assembled.



Wireless devices are not user serviceable. Do not modify them in any way. Modification to a wireless device will void the authorization to use it. Please contact manufacturer for service.



Only use drivers approved for the country in which the device will be used. See the manufacturer System Restoration Kit, or contact manufacturer Technical Support for additional information.

United States of America

USA and Canada Safety Requirements and Notices

Do not touch or move antenna while the unit is transmitting or receiving.

Do not hold any component containing the radio such that the antenna is very close or touching any exposed parts of the body, especially the face or eyes, while transmitting.

Do not operate the radio or attempt to transmit data unless the antenna is connected; if not, the radio may be damaged.

Use in specific environments:

The use of wireless devices in hazardous locations is limited by the constraints posed by the safety directors of such environments.

The use of wireless devices on airplanes is governed by the Federal Aviation Administration (FAA).

The use of wireless devices in hospitals is restricted to the limits set forth by each hospital.

Antenna use:

In order to comply with FCC RF exposure limits, low gain integrated antennas should be located at a minimum distance of 20 cm (8 inches) or more from the body of all persons.

High-gain, wall-mount, or mast-mount antennas are designed to be professionally installed and should be located at a minimum distance of 30 cm (12 inches) or more from the body of all persons. Please contact your professional installer, VAR, or antenna manufacturer for proper installation requirements.



Explosive Device Proximity Warning

Do not operate a portable transmitter (such as a wireless network device) near unshielded

blasting caps or in an explosive environment unless the device has been modified to be qualified for such use.



Antenna Warning

To comply with the FCC and ANSI C95.1 RF exposure limits, it is recommended for Intel® PRO/Wireless Network Connections installed in a desktop or portable computer, that the antenna for this device be installed so as to provide a separation distance of at least 20 cm (8 inches) from all persons and that the antenna must not be co-located or operating in conjunction with any other antenna or radio transmitter. It is

recommended that the user limit exposure time if the antenna is positioned closer than 20cm (8 inches).



Use On Aircraft Caution

Regulations of the FCC and FAA prohibit airborne operation of radio-frequency wireless devices because their signals could interfere with critical aircraft instruments.

Other Wireless Devices

Safety Notices for Other Devices in the Wireless Network: Refer to the documentation supplied with wireless Ethernet adapters or other devices in the wireless network.



The Part 15 radio device operates on a non-interference basis with other devices operating at this frequency. Any changes or modification to said product not expressly approved by Intel could void the user's authority to operate this device.

Unintentional Emitter per FCC Part 15

This device complies with Part 15 of the FCC Rules. Operation is subject to the following two conditions:(1) this device may not cause harmful interference, and (2) this device must accept any interference received, including interference that may cause undesired operation.



This equipment has been tested and found to comply with the limits for a Class B digital device pursuant to Part 15 of the FCC Rules. These limits are designed to provide reasonable protection against harmful interference in a residential installation. This equipment generate uses and can radiate radio frequency energy and if not installed and used in accordance with the instructions may cause harmful interference will not occur in a particular installation. If this equipment does cause harmful interference to radio or television reception, which can be determined by turning the equipment off and on, the user is encouraged to try to correct the interference by one or more of the following measures:

- Reorient or relocate the receiving antenna.
- Increase the separation between the equipment and receiver.
- Connect the equipment into an outlet on a circuit different from that to which the receiver is connected.
- Consult the dealer or an experienced radio/TV technician for help.

If necessary, the user should consult the dealer or an experienced radio/television technician for additional suggestions. The user may find the following booklet helpful: “Something About Interference.” This is available at FCC local regional offices. Our company is not responsible for any radio or television interference caused by unauthorized modifications of this equipment or the substitution or attachment of connecting cables and equipment other than those specified by our company. The correction will be the responsibility of the user. Use only shielded data cables with this system.

Intentional emitter per FCC Part 15

Low power, Radio LAN type devices (radio frequency (RF) wireless communication devices), operating in the 2.4 GHz Band, may be present (embedded) in your notebook system. This section is only applicable if these devices are present. Refer to the system label to verify the presence of wireless devices.

Wireless devices that may be in your system are only qualified for use in the United States of America if an FCC ID number is on the system label.

The FCC has set a general guideline of 20 cm (8 inches) separation between the device and the body, for use of a wireless device near the body (this does not include extremities). This device should be used more than 20 cm (8 inches) from the body when wireless devices are on. The power output of the wireless device (or devices), which may be embedded in your notebook, is well below the RF exposure limits as set by the FCC.

This transmitter must not be collocated or operate in conjunction with any other antenna or transmitter.

Operation of this device is subject to the following two conditions: (1) This device may not cause harmful interference, and (2) this device must accept any interference received, including interference that may cause undesired operation of the device.



Wireless devices are not user serviceable. Do not modify them in any way. Modification to a wireless device will void the authorization to use it. Contact manufacturer for service.



FCC Statement for Wireless LAN use:

“While installing and operating this transmitter and antenna combination the radio frequency exposure limit of 1mW/cm² may be exceeded at distances close to the antenna installed. Therefore, the user must maintain a minimum distance of 20cm from the antenna at all times. This device can not be collocated with another transmitter and transmitting antenna.”

FCC Part 68

This equipment complies with part of the FCC rules. On the back of this equipment is a label that contains, among other information, the FCC registration number and ringer equivalence number (REN) for this equipment. If requested, this information must be provided to the telephone company.

This equipment uses the following USOC jacks : RJ11C

An FCC compliant telephone cord and modular plug is provided with this equipment. This equipment is designed to be connected to the telephone network or promises wiring using a compatible modular jack which is Part 68 compliant. See Installation Instructions for details.

The REN is used to determine the quantity of devices which may be connected to telephone line. Excessive RENs on the telephone line may result in the devices not ringing in response to an incoming call. In most, but not all areas, the sum of RENs should not exceed five (5.0). To be certain of the number of devices that may be connected to a line, as determined by total RENs, contact the local telephone company to determine the maximum REN for the calling area.

If the terminal equipment causes harm to the telephone network, the Telephone Company will notify you in advance that temporary discontinuance of service may be required. But if advance notice is not practical, the telephone company will notify the customer as soon as possible. Also, you will be advised of your right to file a complaint with the FCC if you believe it is necessary.

The telephone company may make changes in its facilities, equipment, operations, or procedures that could affect the operation of the equipment. If this happens, the telephone company will provide advanced notice in order for you to make necessary modifications to maintain uninterrupted service.

If trouble is experienced with this equipment (Modem) for repair or warranty information, please contact your local distributor. If the equipment is causing harm to the telephone network, the telephone company may request that you disconnect the equipment until the problem is resolved.

The user must use the accessories and cables supplied by the manufacturer to get optimum performance from the product.

No repairs may be done by the customer.

This equipment cannot be used on public coin phone service provided by the telephone company. Connection to party line service is subject to state tariffs.

The Telephone Consumer Protection Act of 1991 makes it unlawful for any person to use a computer or other electronic device, including fax machines, to send any message unless such message clearly contains in a margin at the top or bottom of each transmitted page or on the first page of the transmission, the date and time it is sent and

an identification of the business or other entity, or other individual sending the message and the telephone number of the sending machine or such business, other entity, or individual. (The telephone number provided may not be any number for which charges exceed local or long-distance transmission charges.)

In order to program this information into your fax machine, refer to your communications software user manual.

Unintentional Emitter per ICES-003

This digital apparatus does not exceed the Class B limits for radio noise emissions from digital apparatus as set out in the radio interference regulations of Industry Canada.

Le présent appareil numérique n'émet pas de bruits radioélectriques dépassant les limites applicables aux appareils numériques de Classe B prescrites dans le règlement sur le brouillage radioélectrique édicté par Industrie Canada.

Intentional Emitter per RSS 210

Low power, Radio LAN type devices (radio frequency (RF) wireless communication devices), operating in the 2.4 GHz Band, may be present (embedded) in your notebook system. This section is only applicable if these devices are present. Refer to the system label to verify the presence of wireless devices.

Wireless devices that may be in your system are only qualified for use in Canada if an Industry Canada ID number is on the system label.

As a general guideline, a separation of 20 cm (8 inches) between the wireless device and the body, for use of a wireless device near the body (this does not include extremities) is typical. This device should be used more than 20 cm (8 inches) from the body when wireless devices are on.

The power output of the wireless device (or devices), which may be embedded in your notebook, is well below the RF exposure limits as set by Industry Canada.

This transmitter must not be collocated or operate in conjunction with any other antenna or transmitter.

Operation of this device is subject to the following two conditions: (1) This device may not cause harmful interference, and (2) this device must accept any interference received, including interference that may cause undesired operation of the device.



To prevent radio interference to licensed service, this device is intended to be operated indoors and away from windows to provide maximum shielding. Equipment (or its transmit antenna) that is installed outdoors is subject to licensing.



Wireless devices are not user serviceable. Do not modify them in any way. Modification to a wireless device will void the authorization to use it. Contact manufacturer for service.

Telecommunications per DOC notice (for products fitted with an IC-compliant modem)

The Industry Canada label identifies certified equipment. This certification means that the equipment meets certain telecommunications network protective, operation, and safety requirements. The Department does not guarantee the equipment will operate to the users' satisfaction.

Before installing this equipment, users should make sure that it is permissible to be connected to the facilities of the local telecommunications company. The equipment must also be installed using an acceptable method of connection. In some cases, the inside wiring associated with a single-line individual service may be extended by means of a certified connector assembly. The customer should be aware that compliance with the above conditions may not prevent degradation of service in some situations.

Repairs to certified equipment should be made by an authorized Canadian maintenance facility designated by the supplier. Any repairs or alterations made by the user to this equipment, or equipment malfunctions, may give the telecommunications company cause to request the user to disconnect the equipment.

Users should make sure, for their own protection, that the electrical ground connections of the power utility, telephone lines, and internal metallic water pipe system, if present, are connected together. This precaution may be particularly important in rural areas.



To avoid electrical shock or equipment malfunction do not attempt to make electrical ground connections by yourself. Contact the appropriate inspection authority or an electrician, as appropriate.

The **Ringer Equivalence Number (REN)** assigned to each terminal device provides an indication of the maximum number of terminals allowed to be connected to a telephone interface. The termination on an interface may consist of any combination of devices subject only to the requirement that the sum of the Ringer Equivalence Numbers of all the devices does not exceed 5.

European Union

European Union CE Marking and Compliance Notices

Products intended for sale within the European Union are marked with the Conformité Européene (CE) Marking, which indicates compliance with the applicable Directives and European standards and amendments identified below. This equipment also carries the Class 2 identifier.

The following information is only applicable to systems labeled with the CE mark .

European Directives

This Information Technology Equipment has been tested and found to comply with the following European directives:

- EMC Directive 89/336/EEC with amending directives 92/31/EEC & 93/68/EEC as per
 - EN 55022 Class B
 - EN 61000-3-2
 - EN 61000-3-3
 - EN 55024
- Low Voltage Directive (Safety) 73/23/EEC as per EN 60950(A1/A2/A3/A4/A11)
- Radio and Telecom Terminal Equipment Directive 199/5/EC as per
 - CTR21 (if fitted with a modem device)
 - ETS 300 328 (if fitted with a 2.4 GHz band embedded wireless device)
 - ETS 301 489-1 (if fitted with a 2.4 GHz band embedded wireless device)
 - ETS 301 489-17 (if fitted with a 2.4 GHz band embedded wireless device)

European Radio Approval Information (for products fitted with EU-approved radio devices)

This Product is a Notebook computer; low power, Radio LAN type devices (radio frequency (RF) wireless communication devices), operating in the 2.4 GHz band, may be present (embedded) in your notebook system which is intended for home or office use. This section is only applicable if these devices are present. Refer to the system label to verify the presence of wireless devices.

Wireless devices that may be in your system are only qualified for use in the European Union or associated areas if a CE mark  with a Notified Body Registration Number and the Alert Symbol is on the system label.

The power output of the wireless device or devices that may be embedded in your notebook is well below the RF exposure limits as set by the European Commission through the R&TTE directive.



See 802.11b and 802.11g restrictions for specific countries or regions within countries under the heading “European Economic Area Restrictions” below.

Translated Statements of Compliance

This product follows the provisions of the European Directive 1999/5/EC.

European Economic Area Restrictions

Local Restriction of 802.11b/802.11g Radio Usage

[Note to integrator: The following statements on local restrictions must be published in all end-user documentation provided with the system or product incorporating the Intel PRO/Wireless 2200BG Network Connection product.]



Due to the fact that the frequencies used by 802.11b/802.11g wireless LAN devices may not yet be harmonized in all countries, 802.11b/802.11g products are designed for use only in specific countries or regions, and are not allowed to be operated in countries or regions other than those of designated use.

As a user of these products, you are responsible for ensuring that the products are used only in the countries or regions for which they were intended and for verifying that they are configured with the correct selection of frequency and channel for the country or region of use. Any deviation from permissible settings and restrictions in the country or region of use could be an infringement of local law and may be punished as such.

The European variant is intended for use throughout the European Economic Area. However, authorization for use is further restricted in particular countries or regions within countries, as follows:

General

European standards dictate maximum radiated transmit power of 100 mW effective isotropic radiated power (EIRP) and the frequency range 2400 – 2483.5 MHz.

Belgium

The product may be used outdoors, but for outdoor transmissions over a distance of 300m or more, a license from the BIPT is required.

This restriction should be indicated in the manual as follows:

Dans le cas d'une utilisation privée, à l'extérieur d'un bâtiment, au-dessus d'un espace public, aucun enregistrement n'est nécessaire pour une distance de moins de 300m. Pour une distance supérieure à 300m un enregistrement auprès de l'IBPT est requise. Pour une utilisation publique à l'extérieur de bâtiments, une licence de l'IBPT est requise. Pour les enregistrements et licences, veuillez contacter l'IBPT.

France

For Metropolitan departments:

2.400 - 2.4835 GHz for indoor use.

2.400 -2.454 GHz (channels 1 to 7) for outdoor use.

For Guadeloupe, Martinique, St Pierre et Miquelon, Mayotte:

2.400 - 2.4835 GHz for indoor and outdoor use.

For Reunion, Guyane:

2.400 - 2.4835 GHz for indoor use.

2.420 - 2.4835 GHz for outdoor use (channels 5 to 13)

European Telecommunication Information (for products fitted with EU-approved modems)

Marking by the symbol  indicates compliance of this equipment to the Radio and Telecom Terminal Equipment Directive 1999/5/EC. Such marking is indicative that this equipment meets or exceeds the following technical standards:

CTR 21 – Attachment requirements for pan-European approval for connection to the analogue Public Switched Telephone Networks (PSTNs) of TE (excluding TE supporting voice telephony services) in which network addressing, if provided, is by means of Dual Tone Multi-Frequency (DTMF) signaling.



Although this equipment can use either loop disconnect (pulse) or DTMF (tone) signaling, only the performance of the DTMF signaling is subject to regulatory requirements for correct operation. It is therefore strongly recommended that the equipment is set to use DTMF signaling for access to

public or private emergency services. DTMF signaling also provides faster call setup.

This equipment has been approved to Council Decision 98/482/EEC—“CTR 21” for Pan-European single terminal connection to the Public Switched Telephone Network (PSTN).

However, due to differences between the individual PSTNs provided in different countries, the approval does not, of itself, give an unconditional assurance of successful operation on every PSTN termination point. In the event of problems, you should contact manufacturer Technical Support.

WEEE SYMBOL INFORMATION



Correct Disposal of This Product (Waste Electrical & Electronic Equipment)

(Applicable in the European Union and other European countries with separate collection systems)

This marking shown on the product or its literature, indicates that it should not be disposed with other household wastes at the end of its working life. To prevent possible harm to the environment or human health from uncontrolled waste disposal, please separate this from other types of wastes and recycle it responsibly to promote the sustainable reuse of material resources.

Household users should contact either the retailer where they purchased this product, or their local government office, for details of where and how they can take this item for environmentally safe recycling.

Business users should contact their supplier and check the terms and conditions of the purchase contract. This product should not be mixed with other commercial wastes for disposal.

Using Your Documentation

Congratulations on your purchase of a notebook computer with the Windows® XP operating system. Whether you are new to using a portable computer or are an experienced user, this user's manual can help you get the most from your computer.

Manual Documentation Conventions

Information Icons

Three icons and their associated messages appear in this manual. The information icons are placed before the step/information they apply to:



Warning:

Indicates the possibility of personal injury.



Caution:

Warns you of possible damage to equipment or data.



Note:

Informs you of special circumstances.



Technical Information:

Informs you of special requirements or limitations for use of item(s).

Keyboard Conventions

Keys that you need to press to perform certain functions are displayed in the manual in brackets. For example:

<Ctrl> indicates the control key (**Ctrl** on the keyboard).

If you need to press two keys at the same time, the key names are shown joined by a plus sign. For example:

<Fn+F8> means that you should press the **Fn** key and hold it and then press the **F8** key.

CD-ROM Device Naming Convention

In many installation programs you will have to get a program from the CD-ROM device. The program installation sequence assumes that the CD is drive d:\, however this is not always the case. The name of the CD-ROM drive is the letter following the letter assigned to your last HDD. For instance, if you have one HDD with two partitions, the HDD is drives C: and D: and the CD-ROM drive is then drive E.

Touchpad Conventions

You may be asked to click or double-click on items on the display screen. As a general note the touchpad actions act much in the same way as a wheel mouse, any differences are explained fully.

The object that needs to be clicked upon will be displayed in **Bold** text or shown in a small figure such as the “**Start Button**” shown on the right => 

Table 1. Touchpad Click Conventions

Action	Process
Click	Depress the touchpad left button and release
Double-click	Quickly click the left touchpad button two times



Windows Conventions:

Almost all “Windows” programs will display the name/function of a button or icon if you place the touchpad pointer on the item you want information about.

Software User Documentation

Your computer is shipped from the factory with several software programs installed. The software may include its own online or printed documentation. Refer to the documentation or the Help options in the software for more information.



The figures and illustrations in this manual may not be identical to those on your system.



General Icon Note:

Some of the Icons used in Windows XP may be placed on the taskbar by selecting (**ex: Place the volume icon in the taskbar**) in the properties dialog box.

Getting Started

Introducing Your Computer

Front View

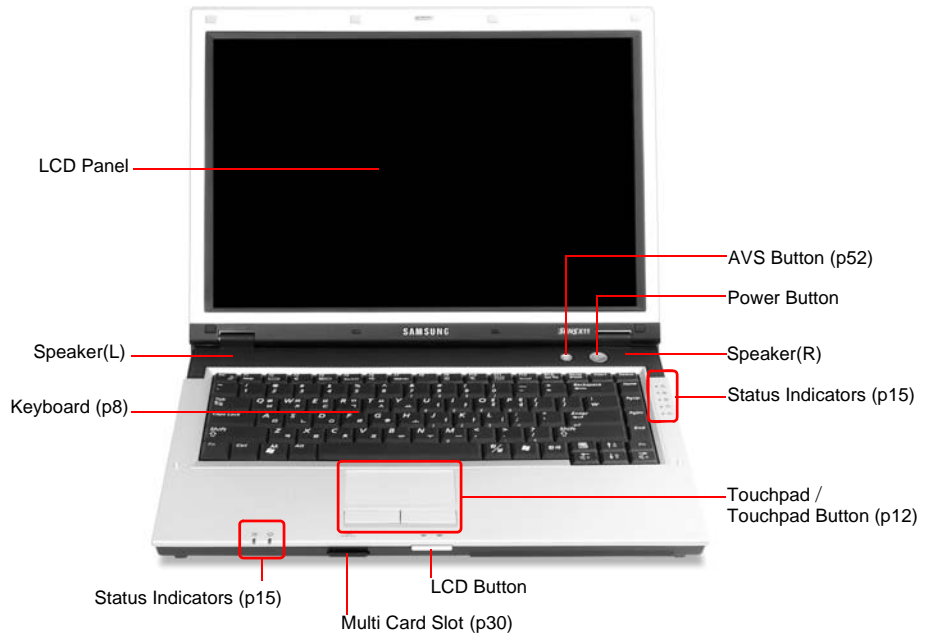

Right View



Serial Port

To use the serial port, you must first connect the supplied dongle cable to the serial port and then connect the serial device to the dongle cable.

Some serial devices may not be supported.

Left View

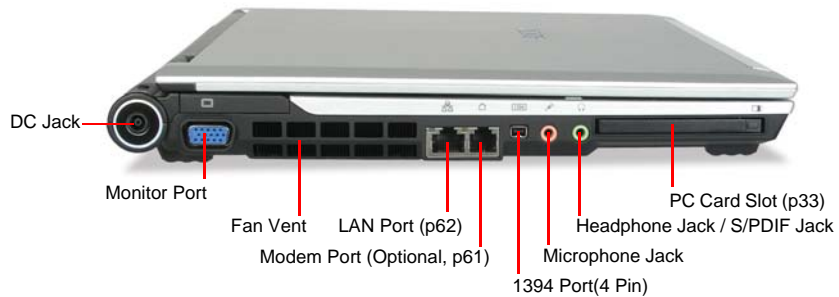

Back View

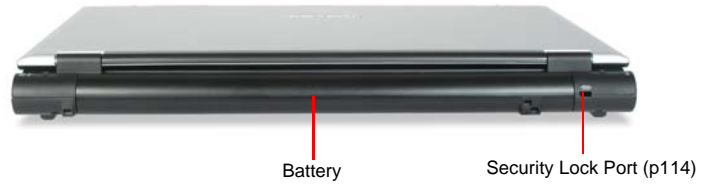

Bottom View



Removing or disassembling the hard disk drive will void your warranty. To replace the hard disk drive, please contact your nearest Samsung Service Centre.

Turning the Computer On and Off

To turn on the computer

1. Insert the battery and connect the AC adapter according to the Installation Guide.
2. Lift up the LCD while pressing the **LCD button**.
3. Press the power button.



To turn off the computer

1. Click the **start** button () on the taskbar.
2. Click **Turn Off Computer**.



3. Click **Turn Off**.

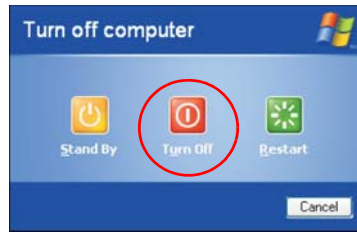

If the computer has not turned off properly due to a system error, press **<Ctrl>+<Alt>+<Delete>**. When [Windows Task Manager] dialog box appears, click **Shut Down > Turn Off** to turn off the computer. Your unsaved work may be lost/damaged.



If **<Ctrl>+<Alt>+<Delete>** keys do not operate either, press the power button for more than 4 seconds to turn off the computer. Your unsaved work may be lost/damaged. The next time you turn on your computer, a hard disk check will be performed, before Windows starts.

Using the Keyboard

Your computer has an 88-key keyboard. By pressing designated key combinations, you can have access to all the key functions of a full-sized keyboard.



The keyboard is supplied according to the corresponding country. Refer to the keyboard figure for the corresponding country.

<United Kingdom>

Function & Special Purpose Keys

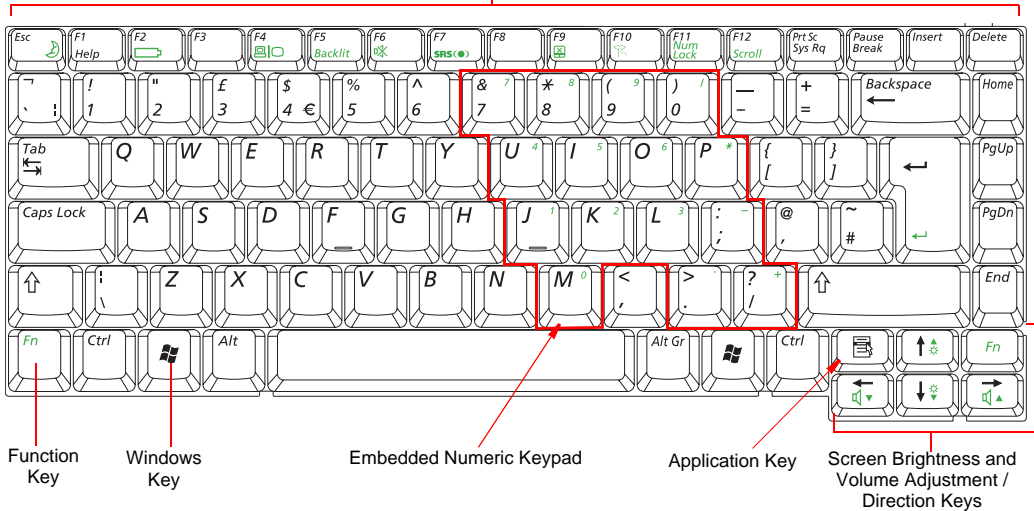

Although the layout of the keys on your computer's keyboard is different from that on a desktop computer's keyboard, the keyboard feels like a full-sized keyboard when you use it.

<United States>

Function & Special Purpose Keys

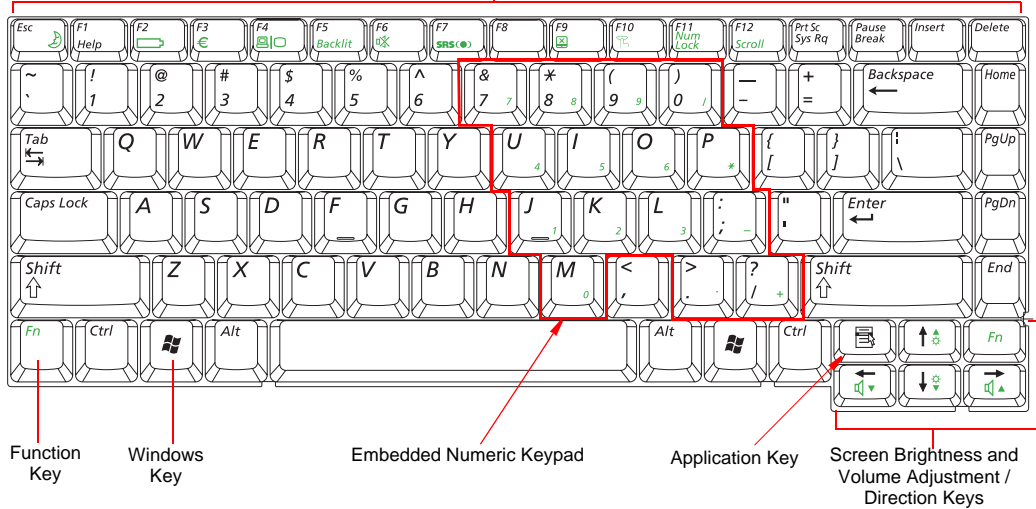

The keys on the keyboard can be grouped into the following categories:

- Full-sized Alphanumeric typewriter keys are arranged like a standard typewriter keyboard and are used for text entry. The Windows keys on either side of the spacebar open Windows menus and perform other special functions.
- Function keys, when pressed together with the <Fn> key, enable special functions.
- Cursor and Screen control keys move the cursor. They may perform other functions, depending on your software.

To clean the computer keyboard, use slightly damp cotton swabs. Scrub the keys and the surface around the keys.



Do not allow liquid to drip into the keyboard or you may damage the keyboard.

Using the Numeric Keypad

Your keyboard includes a numeric keypad, which is a group of keys that you can set to type numbers and mathematical symbols, such as the plus sign. A number or symbol on the corner of each keypad key shows its numeric function.

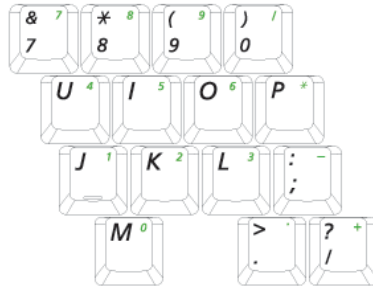

Num Lock LED









Press **<Fn+Num Lock>** to turn on the embedded numeric keypad. The numeric functions of the keypad are enabled and the Num Lock LED turns on. ("Reading the Status Indicators" on page 15 for the location of the Num Lock LED.)

While the numeric functions are enabled, you can temporarily return a key to its normal function by pressing the key and the **<Fn>** key. For example to type the letter *m*, press **<Fn+M>**, this operation displays the letter **m**.



To turn the numeric keypad off, press **<Fn+Num Lock>** again. The Num Lock LED turns off.

Using Special Function Keys

The function key activates special functions when it is pressed in combination with another keys.

<Fn> Key Combinations	Key Name	Key Function
<Esc/  >	Standby	Places the computer into standby mode. To resume from standby mode, press the power button. (p102).
<F2/  >	Gauge	Shows the remaining battery charge. Appears only when the Samsung Display Manager program is installed.
<F4/  >	LCD/CRT	Switches the display between the LCD and external display device when an external display device is connected. (p99)
<F5/Backlit>	Backlight	Turns the LCD on and off.
<F6/Mute>	Mute	Turns the audio output on and off.
<F7/ SRS>	SRS	This feature enables you to experience more stereophonic sound. You can select one of the following modes by pressing the button. Note. WOW XT Mode: Select to listen to music. TRUSURROUND Mode: Select to watch a movie. SRS OFF Mode: Switches off the SRS function. The SRS function is only supported through the built-in speaker of the computer and the headphones. It is not supported through the S/PDIF port.
<F9/  >	Touchpad	Turns the touchpad function on and off.
<F10/  >	Etiquette Mode	You can select Etiquette Mode when you need a tranquil work environment.
<F11/Num Lock>	Number Lock	Enables the numeric keypad. (p10)
<F12/Scroll>	Scroll Lock	Scrolls the screen up and down while the cursor position does not change in some applications.
<  >	Volume Down	Decreases the audio volume.
<  >	Volume Up	Increases the audio volume.
<  >	Brightness Up	Makes the LCD screen brighter.
<  >	Brightness Down	Makes the LCD screen dimmer.

Using the Touchpad

In Windows, you always see a small graphical image on the screen that indicates the location where you can take the next action. This image is called a pointer, and is usually displayed in arrow shape () or 'I' shape ().

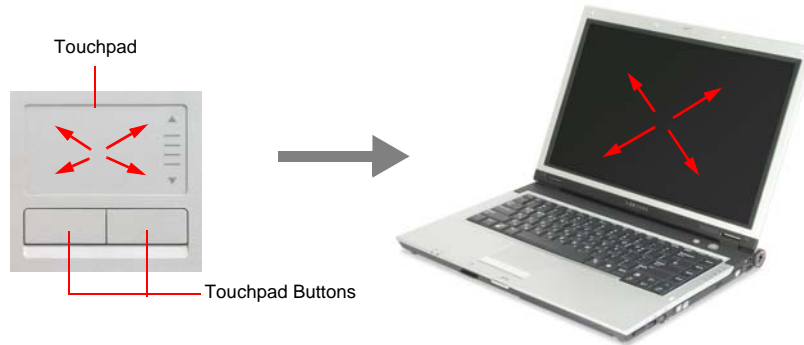







The touchpad on your computer allows you to move the pointer on the LCD screen, just like a mouse that is used with a desktop computer. The touchpad buttons allow you to take actions with the pointer, such as selecting an item or executing a command.



Locking the touchpad

You can lock the touchpad and use only the keyboard and mouse. To lock the touchpad function, press the **<Fn>+<F9>** key combination.

You can perform various actions with your touchpad as described below.

Action	Function	Process
<p>Move</p> 	Move the pointer	Place your finger on the touchpad and slide your finger to a destination.
<p>Click</p>  	Select an object, open a menu, or execute a button	Place the pointer over an object, then press left touchpad button once. Or, place the pointer over an object, then tap the touchpad once with your finger.
<p>Double-Click</p>  	Launch a program or open a file	Place the pointer over an object, then quickly press left touchpad button twice. Or, place the pointer over an object, then quickly tap the touchpad twice with your finger.
<p>Right-Click</p> 	Display a short cut menu	Place the pointer over an object, then press right touchpad button once.
<p>Drag</p> 	Move an object, or select an area or multiple objects	Drag and drop a part to the required place.

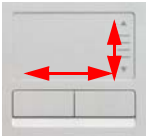
Action	Function	Process
Scroll 	Display upper/lower/left/right part of the content within a window (Applicable to certain programs only)	Place your finger on the right edge or bottom edge of the touchpad and move vertically or horizontally.









Please use the touchpad only with your finger. Using sharp devices may damage the touchpad.

Operating the touchpad or touchpad button while starting your system may increase the time required for starting Windows.

Reading the Status Indicators

Shows the operating status of the computer.



	Num Lock	Turns on when the numeric keypad is activated.
	Caps Lock	Turns on when all alphabet characters you type will be in upper case.
	Scroll Lock	Turns on when it is set to scroll the screen up and down while the cursor position does not change in some applications.
	Hard Disk Drive / CD-ROM Drive	Blinks when the hard disk drive or CD-ROM drive is in operation.
	Wireless LAN	Turns on when the wireless LAN function is enabled. (This light does not operate for models without a wireless LAN.)
	Battery	Turns Light Green - when the battery is fully charged, or when the battery is not installed. Turns amber - when the battery is being charged. Blinks - when the battery is not properly installed.
	Power	Turned On - when the computer is turned on. Blinks - when the computer is in Standby mode.

Adjusting LCD Brightness

There are 8 levels of LCD brightness (1: Dimmest ~ 8: Brightest).

To adjust using keyboard

Press <Fn>+<⌵> or <Fn>+<⌴> keys from the keyboard to adjust LCD brightness.

Whenever you turn the system on or change the power source the brightness level changes according to the settings.

- when operating on AC power: Brightness Level 8
- when operating on battery power: Brightness Level 1

Adjusting the brightness using the Battery Manager

You can adjust the screen brightness using the Battery Manager. (p110)



Maintaining your LCD brightness settings after turning the system off and on

1. Turn the system on. When the Samsung Logo appears, press the <F2> key to enter Setup.

2. In the **Boot** menu, change the **Brightness Mode Control** option to **User Control**.

3. Save the settings and exit Setup.

- When using the Battery Manager, only the screen brightness set in 'Customized Mode' is maintained.

To save the battery charge

When your computer is operating on battery power, adjusting the LCD brightness level to dimmer diminishes the battery power consumption.

Bad pixels in the LCD

The limits of the LCD manufacturing technology allow a maximum of 10 abnormal or bad pixels, which do not affect system performance. This system may have the same level of abnormal or bad pixels as any other company's products.



Maintenance Instructions

When cleaning the LCD panel, use only computer specific cleaners on a soft cloth, and lightly wipe in one direction.

Adjusting the Volume

To adjust using keyboard

Press <Fn>+<⏮> or <Fn>+<⏭> from the keyboard.

To adjust using volume adjustment program

Click the **Volume** icon() on the taskbar, and move the Volume slider to a desired level.



For advanced volume control options, double-click the **Volume** icon() , and adjust the volume level in the volume control program.

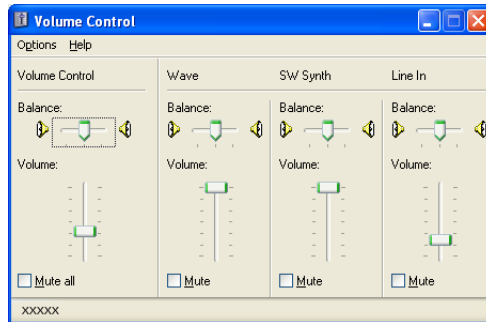



When you turn the system on, a booting noise may occur.

Introducing Windows

Understanding the Desktop

The desktop is the working area on the computer. It consists of the large workspace and a taskbar at the bottom.





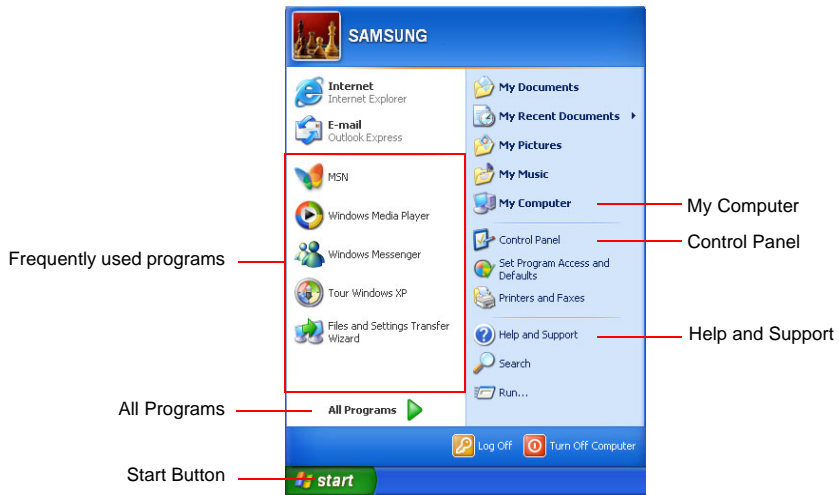

Start Button		Opens the Start menu.
Taskbar		Displays programs that are currently running. Frequently used icons can be placed here.
Recycle Bin		Deleted files or folders are sent here.
Language Bar		Switches text input language.

Understanding the Start Menu

The Start menu includes everything that is required to start Windows. From the Start menu it is possible to run a program, open a file, assign system users with Control Panel, receive support by clicking Help and Support, and search desired items from the computer or Internet by clicking Search.



My Computer		Displays the contents of the hard disk, the CD-ROM drive, the network drive(s), and floppy disks. It can also be used to search and open files and folders.
Control Panel		Enables users to configure settings on the computer.
Help and Support		Provides on-line help, information on Windows and troubleshooting.
Search		Enables users to search for information in files or the Internet.
Run		Run programs or documents.

Understanding a Window

A window is the basic component in working with the computer. The My Computer window, which is a window for the computer's hard drive, will be used as an example here to show the basic composition of a window.

Click **Start > My Computer**.

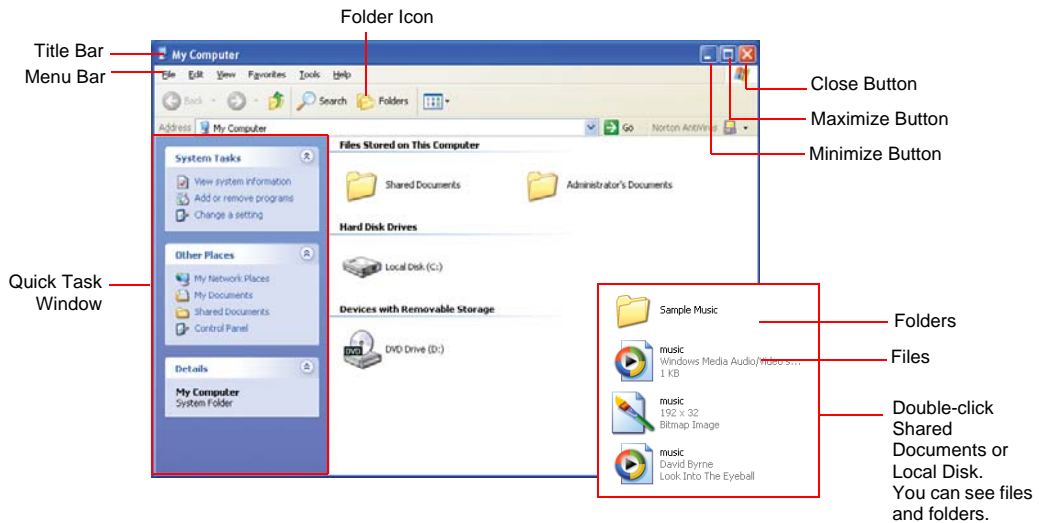

Double-click the hard drive (local disk) to view internal folders and files stored in it. If the contents do not appear, click **Show the contents of this folder**.



What is a drive?

A storage device in which files and folders are saved in, and read from.

What is a folder?

A folder is used to group and manage files systematically, and may include files in sub-folders. It is similar to a bookshelf.

What is a file?

A file is a document or various kinds of material that is generated as a result of program operation. It is also called data.



To view the entire structure of the drive

Click the Folder icon in the taskbar to view the entire structure. Click again to return to the Quick Task Window.

Help and Support Center

Help and Support Center provides references and troubleshooting information regarding computer use.

Click **Start > Help and Support**.

Please refer to help and support centre before calling the Samsung helpline.

Windows XP Tour

You can tour elementary functions provided by Windows XP.

Click **Start > Tour Windows XP**.

Or click **Start > All Programs > Accessories > Tour Windows XP**.

Click on the topics to find out about important functions of Windows XP.

Using the Computer

Using the CD Drive

You have one of following drives installed in your computer.

CD-ROM Drive	Reads CDs.
DVD-ROM Drive	Reads CDs/DVDs.
RW-Combo Drive	Reads a CD/DVD and writes a CD.
DVD Super Multi Drive	Reads CD/DVDs and writes data to CD/DVDs. Supported DVD types include DVD \pm R, DVD \pm RW and DVD-RAM.



A CD-ROM drive is optional. For more detailed product specifications, refer to the product catalog.

To insert a CD

1. Press the eject button on right side of the CD drive.
2. When the tray slides out, place a CD onto the tray with the label facing up, and push the CD down until it clicks.



3. Push the tray in gently until it clicks.

To eject a CD

1. Stop any process that accesses the CD drive and ensure the CD access LED is turned off.
2. Press the eject button on right side of the CD drive.
3. When the tray slides out, remove the CD from the tray.
4. Push the tray in gently until it clicks.



If you remove the CD when the CD access LED is on, the disk and the data in it may be damaged.



Emergency Eject Hole

To eject a CD when the CD drive is not working or the computer is turned off, unfold a paperclip, and insert the unfolded end of the clip into the emergency eject hole (located next to the eject button) and press until the CD tray opens.



To clean a CD or DVD title

Clean the disc with a soft clean cloth by wiping from the center outwards.

To use the Windows Media Player

Windows Media Player enables you to play and manage audio and video files.

To launch the Windows Media Player, click **Start > All Programs > Accessories > Entertainment > Windows Media Player**.

Running the program the first time displays the set up screen. Define the settings according to the instructions displayed on the screen.

When you complete the settings, the following screen appears.

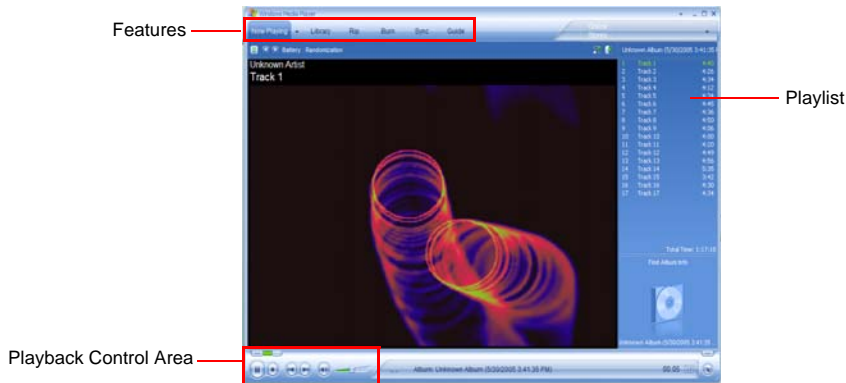

To view detailed information on how to use Windows Media Player

Run Windows Media Player and right-click over the Function Taskbar and select **Help > Windows Media Player Help**.

To play a video CD

If a video CD does not run automatically, follow these steps.

1. Insert a video CD into the CD drive.
2. When the CD drive window appears, double-click the MPEGAV folder.
3. Double-click the .dat file.
4. When the [Caution] dialog appears, click **Open With**.
5. Select "Select the program from a list" and click **OK**.
6. Select the **Windows Media Player**, and click **OK**. The video starts playing.



Above procedure applies only to the video CDs that has a .dat file as the execution file. Playing procedure may be different according to video CDs.

To write data on a CD (Optional)

If your computer has CD-RW functionality, you can copy data to a blank CD or create an audio CD.



You cannot write to a CD that already has data in it.

1. Insert a blank CD into the CD drive.
2. On the [CD Drive] dialog, select **Open Writable CD Folder** and click **OK**. The CD drive window appears.
3. Click **Start > My Computer**.
4. In My Computer window, select files and folders to copy, then drag and drop them onto the CD drive window.

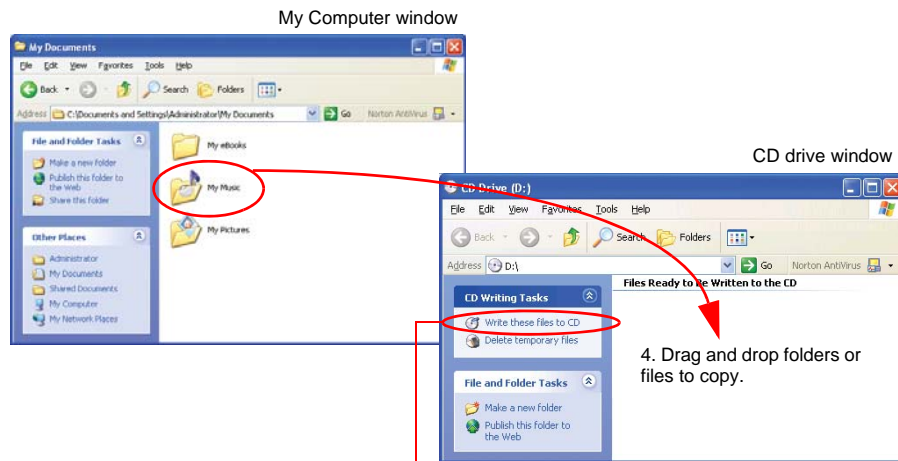

5. Click **Write these files to CD**.

5. Click **Write these files to CD** in the CD drive window.
6. When the CD Writing Wizard appears, enter the CD label, and click **Next**. The data begins copying.
7. When copying is completed, a ‘completed’ message appears and the CD drive window opens automatically.



For more information on writing CDs

Click **Start > Help and Support**. Type “CD copy” in the search field, and click the **Search** icon (➔).



To Burn an Audio CD

Run Windows Media Player and right-click over the Function Taskbar and select **Help > Windows Media Player Help**.

Select **Using the Player > Using CDs, DVDs and VCDs > Using CDs > Burning your own CDs > To burn your own CD** to see detailed information.

Enjoying Home Theater (S/PDIF Port)

Your computer supports 5.1 channel output, which is a basic function for home theater systems, and DVD drives. It provides 3D surrounding sound and vivid screen.



What is a home theater system?

Home theater system usually consists of a TV, DVD, 5.1 channel speaker, and digital amp and provides a high-resolution screen (MPEG2) and 3D surrounding sound (Dolby 5.1 or DTS). With a home theater system, you can enjoy a vivid screen and sound in your home as if you are in a movie theater.

The following devices are required to enjoy a home theater system.

5.1 channel speaker system (amplifier, speakers, connection cables)	Purchased separately
DVD drive and DVD playing program on the computer	Optional
DVD title that supports 5.1 channel	Purchased separately

To use home theater system, complete the following procedures:

- Step 1. Connect 5.1 channel speaker system to your computer.
- Step 2. Configure digital sound output on the computer.
- Step 3. Enable S/PDIF output on the DVD program.

Step 1. Connect 5.1 channel speaker system to your computer

1. Connect the S/PDIF jack of the system and a 5.1 channel amplifier.
2. Connect speakers to the amplifier. (Refer to speaker's manual.)
3. To view through a TV, connect the TV and change the current display device to TV in the Display Properties. ("Using External Display Devices" on page 99)

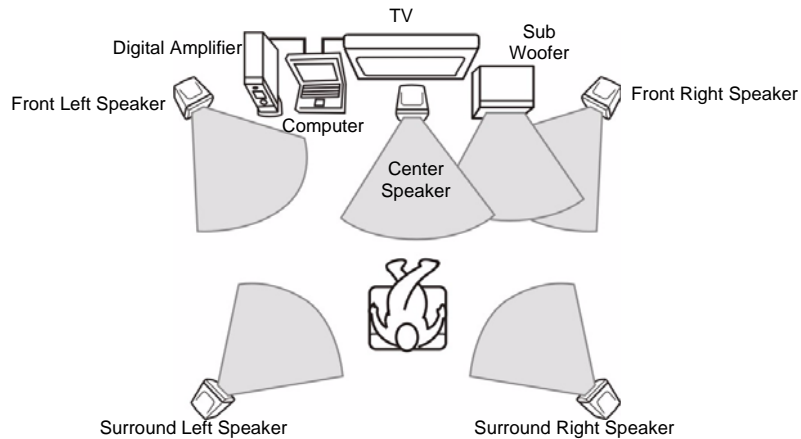

Step 2. Setting the Sound to Digital Sound Output on the Computer

Since the sound of the computer is set to Digital Output by default when purchasing the computer, additional settings are not required. You can confirm the setting as follows.

1. Double-click the Volume Control (🔊) icon in the notification area of the Taskbar and select **Options > Advanced Controls**.
2. Click the **Advanced** button below the Master Volume and check if the **1 Disable Digital Output** item is unselected.
The option must be unselected for sound to be output in digital format.

Step 3. Enable S/PDIF output on the DVD program

To use 5.1 channel speakers, you need to install the CyberLink Power DVD program from the CyberLink DVD Solution Installation CD (or System software Media) provided with your computer, then change the settings as per the following.

The CyberLink PowerDVD program is optional and may not be provided depending on the model.

1. Run CyberLink Power DVD program and click the **Configuration** icon ().



2. On the **Audio** tab, set the Audio Output setting to “Use SPDIF” and click **OK**.

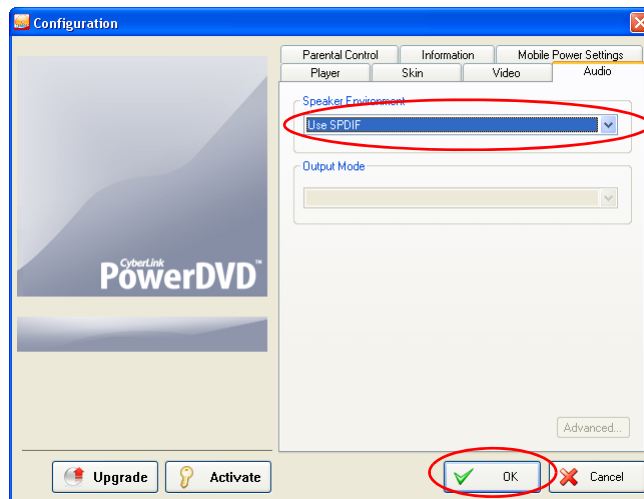

Now, you can enjoy home theater using DVD titles.



To control volume for your 5.1 channel speaker, use the control on the digital amp. (Please refer to the speaker manual.)

Using the Multi Card Slot

Using the Multi Card Slot, you can use memory cards such as a Memory Stick, Memory Stick Pro, SD Card, MMC, or xD Card. A memory card is used as a removable disk and is useful for exchanging data between a computer and a digital device such as a digital camera.



Memory Stick



Memory Stick Pro



SD Card



MMC



xD Card



A multi-card slot is optional and is not provided for some models.



Restrictions when Using Memory Cards

You can use memory cards for storing data only. Copyright protection function is not supported.

To insert and use a memory card



Remove the Slot Protector first, before using the Multi Card Slot. Press the end of the Slot Protector lightly, and remove the Slot Protector when it pops up.



You should insert the memory card with the writing on the card facing downwards.

Inserting wrong side up may cause damage in the memory card and the computer.

1. Insert a memory card into the Multi Card Slot.



2. Click **Start > My Computer**. The inserted memory card is displayed.



Example : Memory Stick

3. You can write data to the memory card. If the memory card is not formatted yet, format the memory card before use.



Since the memory card may be easily mislaid when moving your computer, keep the memory card separately.

To remove a memory card

1. Press the end of the memory card softly to pop it outward.
2. If the card pops out with a clicking sound, remove the card from the system.

To format a memory card

You can use a memory card after the format operation. The procedures to format a memory card are described below.



Since format operation deletes all data in the memory card, please make sure that there is no important data in the memory card before formatting.



To protect the data in the memory card

Set the write protection tab of the Memory Stick or SD memory card to the Lock position.

1. Click **Start > My computer**.
2. Press the right touchpad button on the memory card drive, and select **Format** from the pop-up menu.
3. Click **Start** to start the format operation.



To use a memory card in both the computer and other digital device such as digital camera, it is recommended to format the memory card in the digital device. If you format the memory card in the computer, you may have to format the memory card in other digital device again to use the memory card in the digital device.

Using the PC Card Slot

Various different functions can be added by inserting PCMCIA cards into the system. This system supports 16/32 bit, type I or II PCMCIA card types.



The PC card slot does not support a ZV card or a PCMCIA III card.

To insert a PCMCIA card



Before using the PC Card slot, remove the slot protector.

Push the eject button of the PC card slot once to pop it out. Push the button again to eject the slot protector.

1. Insert a PCMCIA card into the PC card slot on the side of the computer.



Ensure that the PCMCIA card is inserted the correct way, as incorrect insertion will damage the PC card slot.



2. Windows automatically installs the necessary driver for the card. If there is no available driver found by Windows, you have to install the driver using a disk supplied with the card.

To remove a PCMCIA card

1. Double-click **Safely Remove Hardware** icon () on the taskbar.
2. On the [Safely Remove Hardware] dialog box, select the appropriate PCMCIA card and click **Stop**.
3. When [Stop a Hardware Device] dialog box appears, click **OK**.
4. Click **Close** to close the [Safely Remove Hardware] dialog box.
5. Push eject button of the PC card slot once, and the button pops out.
6. Push the button again to eject the PCMCIA card.

Using EasyBox

Use EasyBox program to make use of Windows' complicated function easily and conveniently.

Learn about EasyBox

Double-click the **EasyBox** (🗂️) icon on the desktop.

(Or select **Start > All Programs > Samsung > EasyBox > EasyBox.**)

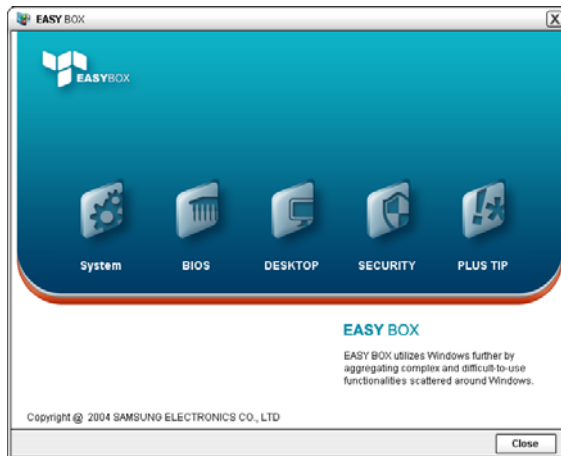

- **System:** System management features are available, including disk defragmenter, disk cleanup, computer scheduling and system restore.
- **BIOS:** In windows-based mode, you can recover the BIOS defaults and change the boot sequence.
- **Desktop:** Desktop management features include changing the font size, executing a magnifier function, the start menu settings and managing the quick launch icons on the taskbar.
- **Security:** Here you can configure the security settings supported by Windows XP SP2. You can also change the configuration of the firewall settings, Windows automatic updates and blocking pop-ups when connected to the Internet.
- **Plus Tip:** This is a collection of additional Windows functions that are useful for system management. (Offering shortcut descriptions of Windows, configuring network sharing and opening local folder sharing, etc.)

Using EasyBox

The Security management function will be used as an example here to show the function of Easybox

Configuring Firewall

The Windows Firewall prevents unauthorized users from gaining access to your system via the network or the Internet.

1. Click **Start > All Programs > Samsung > EasyBox > EasyBox**.
2. Click **Security** from the top menu bar.
3. Select **Windows Firewall Settings** from the Security menu on the left.
4. Select a firewall level.
5. Click **Apply**.



Click the User Setting button for advanced features, including exceptions and permissions.

Using Samsung Update Plus

Samsung Update Plus is software that examines and updates Samsung software and drivers installed on your Samsung computer to the latest version. To use Samsung Update Plus, your computer has to be connected to the Internet.

To Update Samsung Software and Drivers

1. Select **Start > All Programs > Samsung > Samsung Update Plus > Samsung Update Plus**.



If this is the first time you are running the program, a window will appear asking you if you agree to the agreement in the window. Click Agree to use this software.

2. Click **Search for and Install Updates** and click the **Search for New Updates** button.

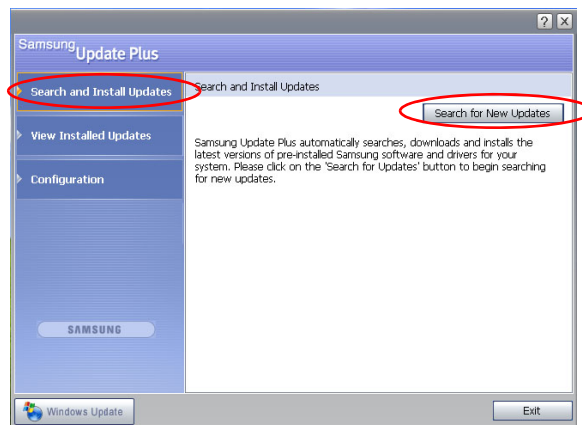

3. If there are available software or driver updates for your computer, the available updates will be listed. Select the required updates from the list and click **Install Update** to start the update.

(The update list on the screen may differ depending on the computer model.)



Updates that must be installed separately.

If you select **Install** as an update item that must be installed separately, a message appears informing you of this. Follow the instruction message to correctly install it.



Automatic update items display

By default, your computer is configured to automatically search for updates. If there is a new update available, this is notified in the notification area. Click the balloon help icon in the notification area. Here you will be able to find the latest available updates.

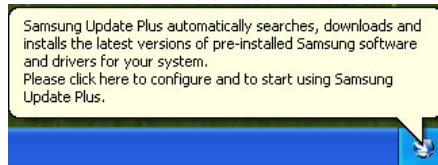

To change the automatic update settings, click the **Configuration** button in Figure 2 and change the settings.



Samsung Update Plus does not provide updates for additionally installed software and device drivers.

Using AVStation premium

AVStation premium is an integrated multimedia program that enables users to enjoy music, photographs, video, movies, etc. all with a single program.



Before You Start!

- AVStation premium is optional and may not be provided depending on the model.
- The screens used in this manual may differ from actual screens according to the program version.
- TV Station is only available for systems supporting the TV function.
- For detailed usage, refer to the program help.

Start and Screen Layout

To launch the program, select **Start > All Programs > Samsung > AVStation premium > AVStation premium**.

Alternatively double-click the AVStation premium icon () on the Desktop.

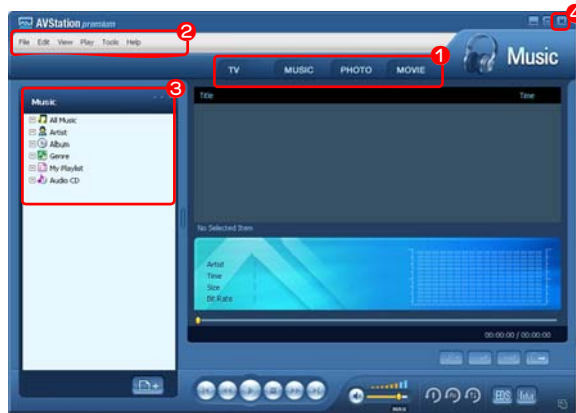

- 1 Station Bar
- 2 Menu Bar
- 3 Library
- 4 Exit

Press the Exit button to exit the program.

MUSIC

You can play a music file or an audio CD.

PHOTO

You can view or edit a photograph (image), and also view the photographs through a SlideShow.

MOVIE

You can play a video (movie) file or a DVD/VCD title.

MUSIC Station

Launch AVStation premium and click **MUSIC** on the Station Bar.

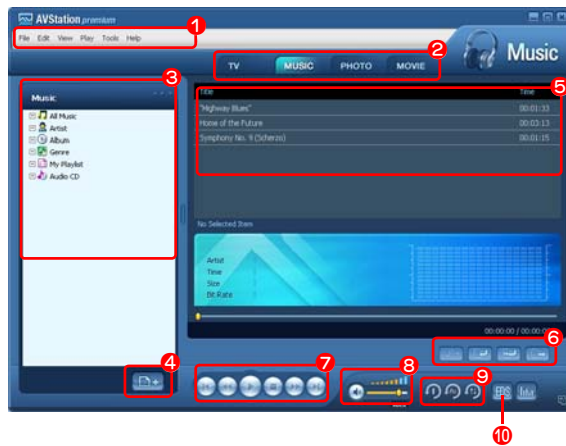

- 1 MUSIC Menu Bar
- 2 Station Bar
- 3 MUSIC Library
- 4 Register a File
- 5 Playlist
- 6 Playlist Control Buttons
- 7 Play Control Buttons
- 8 Volume Control
- 9 Play Options
- 10 EDS Setting Button



What is EDS (Enhanced Digital Sound)?

EDS (Enhanced Digital Sound) is a sound quality enhancement technology developed by Samsung Electronics. You can listen to clearer sound if you enable the EDS function when playing music or video on AVStation premium.

Playing an Audio CD

The procedures to play an audio CD are described below.

1. Launch AVStation premium and insert an audio CD into the CD drive.
2. In the **Audio CD** window, select **Play Audio CD using Samsung AVStation** and click the **OK** button.

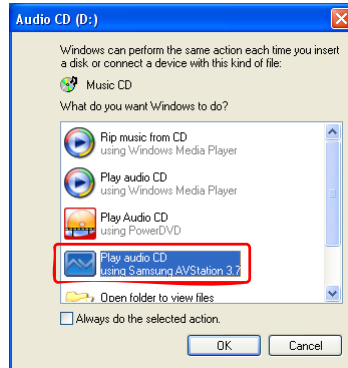

3. The tracks on the audio CD are displayed in the Playlist and the first track is automatically played.

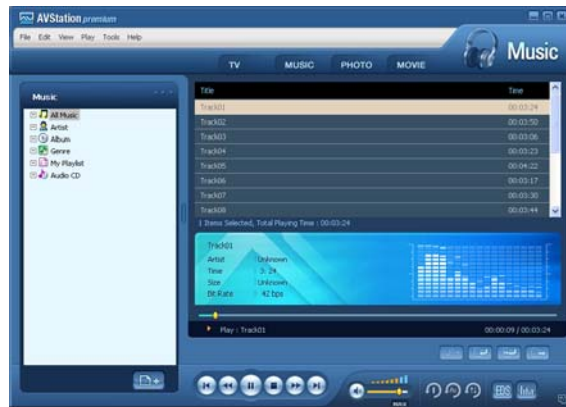

If an audio CD is already in the CD drive, double-click the **album title** in the **Audio CD** folder of the Library and add the tracks to the Playlist. The tracks added to the Playlist are played.

Playing a Music File

If a music file is registered to the MUSIC Library, you can easily play the music file. For the procedures to register tracks to the Library, refer to (p43).

1. Move to MUSIC Station and double-click on All Music.
2. Double-click a music file. The file is added to the playlist and played.



Play a Track not registered to the Library

Click File > Open, select a music file to be played and click Open. The selected track is registered to the Library and played.

Creating My Playlist

My Playlist is a personal album with which you can collect, manage and play your favorite music files. For the procedures to create My Playlist, refer to the descriptions of MUSIC Station in Help.

Adding Music Files to the Library

MUSIC Library is a library holding music files used by MUSIC Station. The procedures to add music files saved on the computer to the Library are described below.

You can add files, folders or search and add files. As an example, the procedures to add a folder are described below.

1. Click on the **Register a File** () button below the Library and click on **Add by Folders**.

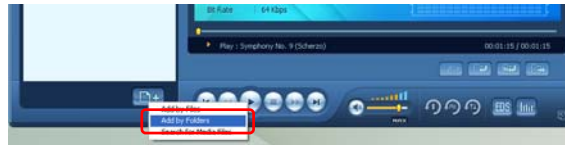

2. Select a folder which included music files and click the OK button. The music files in the folder are added to the Library.



The tracks used in AVStation are automatically added to the Library.

PHOTO Station

Launch AVStation premium and click PHOTO on the Station Bar.

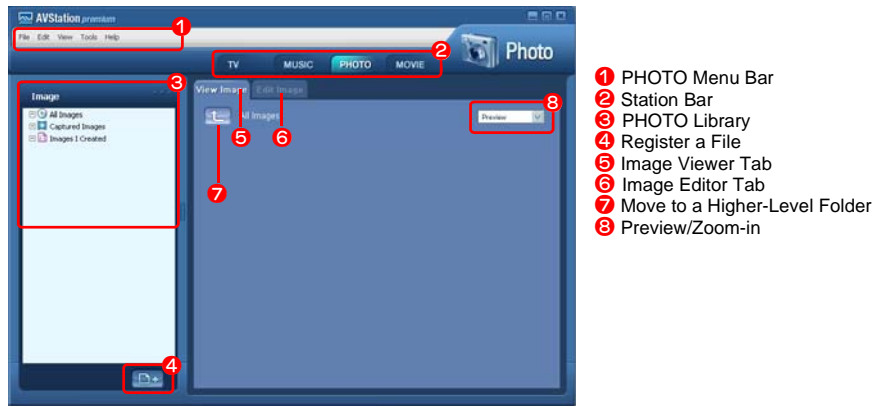

Viewing an Image

The procedures to view images registered to the PHOTO Library one by one and through a SlideShow are described below.

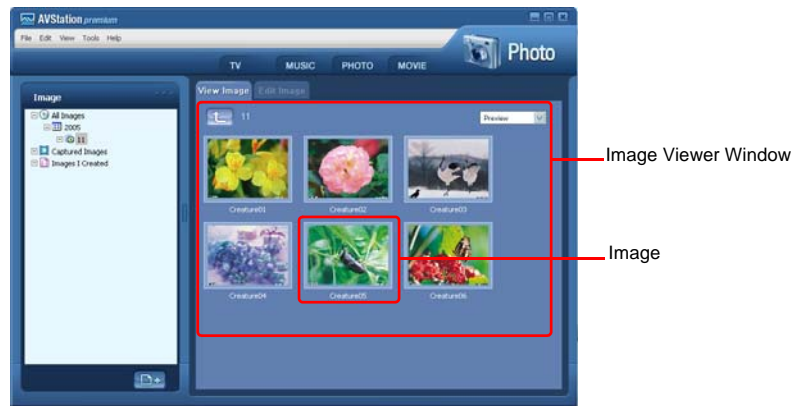

For the procedures to register image files to the Library, refer to (p47).

1. Move to **PHOTO Station** and double-click on **All Images**.
2. Click on a folder which includes images, and the images in the folder are displayed in the Image Viewer window.



3. Double-click on an image. The selected image is zoomed in on.



- Viewing an Image not registered to the Library
Click **File > Open**, select an image file to view and click **Open**.
The selected image file is registered to the Library and displayed in the Image Viewer window.
- Viewing an Image in Full Screen or through a SlideShow.
Click the **Full Screen** () button or **SlideShow** () button below the Image Viewer window.
To return to the Image Viewer window, press the <Esc> key or double-click on the screen.
- Watching a SlideShow while Listening to Music
To watch a SlideShow while listening to music, play music from MUSIC Station and run SlideShow.
- Setting an Image as the Background.
Click the **Set as Background** () button below the Image Viewer window.
The selected image is set as the Desktop background.

Editing an Image

You can change the shape of an image, edit an image or apply special effects to an image. The image editor functions are described below.

1. Select an image to edit in **the Image Viewer window**, and select the **Image Editor** tab. The Image Editor screen appears.

The Image Editor screen consists of an **Image Workspace window** and **3 Tool tabs**.

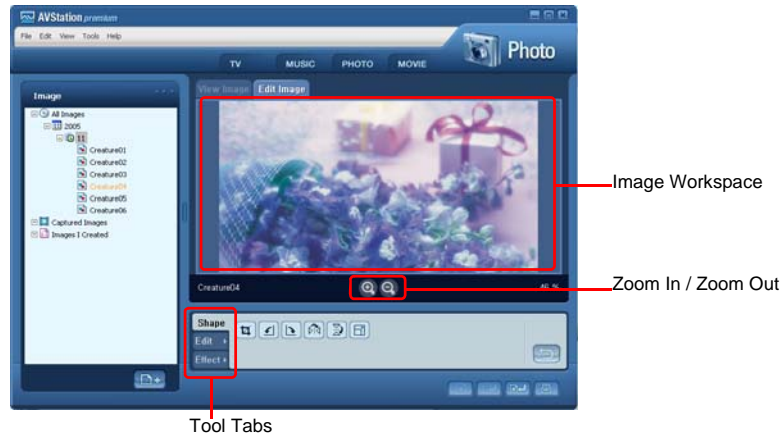

2. Edit the image using the Shape, Edit and Effect tools.



Shape tool: Change the shape of an image through cut, resize.

Edit tool: Draw a line, add some clip art or enter letters.

Effect tool: Apply various effects to an image.

3. When finishing editing an image, click the **Save Edited Image** () button below the Image Editor window. The edited image is saved.