

Regulatory and Safety Compliance Guide



Warning! Important Safety Instructions

(Please read the appropriate section that corresponds to the marking on your Samsung product before attempting to install the product.)



CAUTION: TO REDUCE THE RISK OF ELECTRIC SHOCK, DO NOT REMOVE COVER (OR BACK). THERE ARE NO USER SERVICEABLE PARTS INSIDE. REFER ALL SERVISING TO QUALIFIED PERSONNEL.



This symbol indicates high voltage is present inside. It is dangerous to make any kind of contact with any inside part of this product.



This symbol alerts you that important literature concerning operation and maintenance has been included with this product.

- ☛ The slots and openings in the cabinet and in the back or bottom are provided for necessary ventilation. To ensure reliable operation of this apparatus, and to protect it from overheating, these slots and openings must never be blocked or covered.
 - Do not cover the slots and openings with a cloth or other materials.
 - Do not block the slots and openings by placing this apparatus on a bed, sofa, rug or other similar surface.
 - Do not place this apparatus in a confined space, such as a bookcase, or built-in cabinet, unless proper ventilations is provided.
- ☛ Do not place this apparatus near or over a radiator or heat register, or where it is exposed to direct sunlight.
- ☛ Do not place the sources of heat on this apparatus, such as a candle, ash tray, incense or other similar material.
- ☛ Do not place a water containing vessel on this apparatus, as this can result in a risk of fire or electric shock.
- ☛ Do not expose this apparatus to rain or place it near water (near a bathtub, washbowl, kitchen sink, or laundry tub, in a wet basement, or near a swimming pool etc.). If this apparatus accidentally gets wet, unplug it and contact an authorized dealer immediately. You can clean this apparatus with damp cloth when necessary, but be sure to unplug the apparatus first.
- ☛ Do not expose this apparatus set to extreme temperature conditions or to extreme humidity conditions.
- ☛ This apparatus use batteries. In your community there might be regulations that require you to dispose these batteries properly under environmental considerations. Please contact your local authorities for disposal or recycling information.
- ☛ To cut off the power source, unplug this apparatus from the wall outlet.
- ☛ Do not overload wall outlets, extension cords or convenience receptacles beyond their capacity, since this can result in fire or electric shock.
- ☛ Power-supply cords should be routed so that they are not likely to be walked on or pinched by items placed upon or against them, paying particular attention to cords at plugs, convenience receptacles, and the point where they exit from the appliance.
- ☛ To protect this apparatus from a lightning storm, or when it is left unattended and unused for long periods of time, unplug it from the wall outlet and disconnect the antenna or cable system. This will prevent damage to the set due to lightning and power line surges.
- ☛ Before connecting the AC power cord to the DC adapter outlet, make sure the voltage designation of the DC adapter corresponds the the local electrical supply.
- ☛ Never insert anything metallic into this apparatus openings. Doing so may create the danger of electric shock.
- ☛ To avoid electric shock, never touch the inside of this apparatus. Only a qualified technician should open this apparatus's case.
- ☛ Be sure to hold the plug, not the cord, when disconnecting this apparatus from an electric socket.
- ☛ Locate this apparatus near an easily accessible AC outlet.
- ☛ If this apparatus does not operate normally - in particular, if there are any unusual sounds or smells coming from it - unplug it immediately and contact an authorized dealer or service center.
- ☛ Unplug this apparatus from the AC outlet before any service.

Regulatory Compliance Statements

Your Samsung product is marked to indicate its compliance class:

- Federal Communications Commission (FCC) - USA
- Industry Canada Equipment Standard for Digital Equipment (ICES-003) - Canada
- Voluntary Control Council for Interference (VCCI) - Japan
- Bureau of Standards Metrology and Inspection (BSMI) - Taiwan
- Ministry of Information and Communication (MIC) - Republic of Korea
- Italian Post Ministry (Homologation) - Italy

FCC Information

FCC Class A Notice

This device complies with part 15 of the FCC Rules. Operation is subject to the following two conditions:

1. This device may not cause harmful interference, and
2. This device must accept any interference received, including interference that may cause undesired operation.

NOTE: This equipment has been tested and found to comply with the limits for a Class A digital device, pursuant to Part 15 of the FCC Rules. These limits are designed to provide reasonable protection against harmful interference when the equipment is operated in a commercial environment. This equipment generates, uses, and can radiate radio frequency energy and, if not installed and used in accordance with the instruction manual, may cause harmful interference to radio communications. Operation of this equipment in a residential area is likely to cause harmful interference in which case the user will be required to correct the interference at his own expense.

FCC Class B Notice

This device complies with part 15 of the FCC Rules. Operation is subject to the following two conditions:

1. This device may not cause harmful interference, and
2. This device must accept any interference received, including interference that may cause undesired operation.

NOTE: This equipment has been tested and found to comply with the limits for a Class B digital device, pursuant to Part 15 of the FCC Rules. These limits are designed to provide reasonable protection against harmful interference in a residential installation. This equipment generates, uses and can radiate radio frequency energy and, if not installed and used in accordance with the instructions, may cause harmful interference to radio communications. However, there is no

guarantee that interference will not occur in a particular installation.

If this equipment does cause harmful interference to radio or television reception, which can be determined by turning the equipment off and on, the user is encouraged to try to correct the interference by one or more of the following measures:

- Reorient or relocate the receiving antenna.
- Increase the separation between the equipment and receiver.
- Connect the equipment into an outlet on a circuit different from that to which the receiver is connected.
- Consult the dealer or an experienced radio/TV technician for help.

User Information

Changes or modifications not expressly approved by the party responsible for compliance could void the user's authority to operate the equipment. If necessary, consult with your dealer or an experienced radio/television technician for additional suggestions. You may find the booklet called How to Identify and Resolve Radio/TV Interference Problems helpful. This booklet was prepared by the Federal Communications Commission. It is available from the U.S. Government Printing Office, Washington, DC 20402, Stock Number 004-000-00345-4.

The party responsible for product compliance:

SAMSUNG ELECTRONICS CO., LTD.

America QA Lab of Samsung

3351 Michelson Drive

Suite #290, Irvine, CA92612 USA

Warning

User must use shielded signal interface cables to maintain FCC compliance for the product. Provided with this monitor is a detachable power supply cord with IEC320 style terminations. It may be suitable for connection to any UL Listed personal computer with similar configuration. Before making the connection, make sure the voltage rating of the computer convenience outlet is the same as the monitor and that the ampere rating of the computer convenience outlet is equal to or exceeds the monitor voltage rating.

For 120 Volt applications, use only UL Listed detachable power cord with NEMA configuration 5-15P type(parallel blades) plug cap. For 240 Volt applications use only UL Listed detachable power supply cord with NEMA configuration 6015P type(tandem blades) plug cap.

This television receiver provides display of television closed captioning in accordance with Section 15.119 of the FCC rules.(TV broadcast receivers with picture screens 13 inches or larger in diameter models only)

ICES-003 Class A Notice - Avis NMB-003, Classe A

This Class A digital apparatus complies with Canadian ICES-003.

Cet appareil numérique de la classe A est conforme à la norme NMB-003 du Canada.

ICES-003 Class B Notice - Avis NMB-003, Classe B

This Class B digital apparatus complies with Canadian ICES-003.

Cet appareil numérique de la classe B est conforme à la norme NMB-003 du Canada.

VCCI Class A Notice

この装置は「情報処理装置等電波障害自主規制協議会(VCCI)の基準に基づくクラスA情報技術装置です。この装置を家庭環境で使用すると電波妨害を引き起こすことがあります。この場合には使用者が適切な対策を講ずるよう要求されることがあります。」

VCCI Class B Notice

この装置は「情報処理装置等電波障害自主規制協議会(VCCI)の基準に基づくクラスB情報技術装置です。この装置は「家庭環境で使用することを目的としていますが、この装置がラジオやテレビジョン受信機に近接して使用されると「受信障害を引き起こすことがあります。」取扱説明書に従って正しい取り扱いをして下さい。」

BSMI Class A Notice

The following statement is applicable to products shipped to Taiwan and marked as Class A on the product compliance label.

警告使用者:

這是甲類資訊類產品，在居住環境中使用時，可能會造成射頻干擾，在這種情況下，使用者會被要求採取某些適當的對策。」

European Notice(Europe Only)

Products with the CE marking comply with the EMC Directive(89/336/EEC), (92/31/EEC), (93/68/EEC) and the Low Voltage Directive(73/23/EEC) issued by the Commission of the European Community.

Compliance with these directives implies conformity to the following European Norms:

- EN55022: Radio Frequency Interference
- EN55024: Electromagnetic Immunity of Information Technology Equipment
- EN61000-3-2: Power Line Harmonics
- EN61000-3-3: Voltage Fluctuations
- EN55013: Radio disturbance characteristics of broadcast receivers and associated equipments
- EN55020: Electromagnetic immunity of broadcast receivers and associated equipments

European Class A Warning

This is a class A product. In a domestic environment this product may cause radio interference in which case the user may be required to take adequate measures.(Class A product only)

정보통신기기 A급 기기(MIC Class A Notice)

이 기기는 업무용으로 전자파적합등록을 한 기기이오니 판매자 또는 사용자는 이 점을 주의하시기 바라며 만약 잘못 판매 또는 구입하였을 때에는 가정용으로 교환하시기 바랍니다.

정보통신기기 B급 기기(MIC Class B Notice)

이 기기는 가정용으로 전자파적합등록을 한 기기로서 주거지역에서는 물론 모든 지역에서 사용할 수 있습니다.

Italian Homologation Notice

Questo apparecchio e fabbricato in conformita al D.M.28.08.95 n.548
ed in particolare a quanto specificato nell Art.2, comma 1.

Questo apparecchio e fabbricato nella U.E. in conformita al D.M.28.08.95 n.548
Art.2, comma 1 ed al D.M.26.03.92 Art.1

- For products produced in countries except European Community

Questo apparecchio e fabbricato in conformita al D.M.28.08.95 n.548
ed in particolare a quanto specificato nell Art.2, comma 1.

- For products produced in European Community

Questo apparecchio e fabbricato nella U.E. in conformita al D.M.28.08.95 n.548
Art.2, comma 1 ed al D.M.26.03.92 Art.1

Important Safety Instructions(TV Only)

- 1) Read these instructions.
- 2) Keep these instructions.
- 3) Heed all warnings.
- 4) Follow all instructions.
- 5) Do not use this apparatus near water.
- 6) Clean only with dry cloth.
- 7) Do not block any ventilation openings, Install in accordance with the manufacturer's instructions.
- 8) Do not install near any heat sources such as radiators, heat registers, or other apparatus (including amplifiers) that produce heat.
- 9) Do not defeat the safety purpose of the polarized or grounding-type plug. A polarized plug has two blades with one wider than the other. A grounding type plug has two blades and a third grounding prong. The wide blade or the third prong are provided for your safety. If the provided plug does not fit into your outlet, consult an electrician for replacement of the obsolete outlet.
- 10) Protect the power cord from being walked on or pinched particularly at plugs, convenience receptacles, and the point where they exit from the apparatus.
- 11) Only use attachments/accessories specified by the manufacturer.
- 12) Use only with cart, stand, tripod, bracket, or table specified by the manufacturer, or sold with the apparatus. When a cart is used, use caution when moving the cart/apparatus combination to avoid injury from tip-over.
- 13) Unplug this apparatus during lightning storms or when unused for long periods of time.
- 14) Refer all servicing to qualified service personnel. Servicing is required when the apparatus has been damaged in any way, such as power-supply cord or plug is damaged, liquid has been spilled or objects have fallen into the apparatus, the apparatus has been exposed to rain or moisture, does not operate normally, or has been dropped.



CAUTION
RISK OF ELECTRIC SHOCK DO NOT OPEN
CAUTION: TO REDUCE THE RISK OF ELECTRIC SHOCK, DO NOT REMOVE COVER (OR BACK). NO USER SERVICEABLE PARTS INSIDE. REFER SERVICING TO QUALIFIED SERVICE PERSONNEL.

This symbol indicates high voltage is present inside. It is dangerous to make any kind of contact with any inside part of this product.



This symbol alerts you that important literature concerning operation and maintenance has been included with this product.



Warning: To prevent damage which may result in fire or electric shock hazard, do not expose this appliance to rain or moisture.

(EPA applied model only)
As an ENERGY STAR Partner, Samsung has determined that this product or product models meets the ENERGY STAR guidelines for energy efficiency.

■ Optional ■

Do not place the apparatus in a rack or bookcase. Ensure that there is adequate ventilation and that you've followed that manufacturer's instructions for mounting.
(For PDP or Projection TV apparatus)

If you place the apparatus in a rack or bookcase, ensure that there is adequate ventilation and that you've followed the manufacturer's instructions.

Wiring the Mains Power Supply Plug(UK Only)

IMPORTANT NOTICE

The mains lead on this equipment is supplied with a moulded plug incorporating a fuse. The value of the fuse is indicated on the pin face of the plug and, if it requires replacing, a fuse approved to BS11362 of the same rating must be used.

Never use the plug with the fuse cover omitted if the cover is detachable. If a replacement fuse cover is required, it must be of the same colour as the pin face of the plug. Replacement covers are available from your dealer.

If the fitted plug is not suitable for the power points in your house or the cable is not long enough to reach a power point, you should obtain a suitable safety approved extension lead or consult your dealer for assistance.

However, if there is no alternative to cut off the plug, remove the fuse and then safely dispose of the plug. Do NOT connect the plug to a mains socket as there is a risk of shock hazard from the bared flexible cord.

IMPORTANT

The wires in the mains lead are coloured in accordance with the following code:

BLUE - NEUTRAL BROWN - LIVE

As these colours may not correspond to the coloured markings identifying the terminals in your plug, proceed as follows:

The wire coloured BLUE must be connected to the terminal marked with the letter N or coloured BLUE or BLACK.

The wire coloured BROWN must be connected to the terminal marked with the letter L or coloured BROWN or RED.

WARNING: DO NOT CONNECT EITHER WIRE TO THE EARTH TERMINAL, WHICH IS MARKED WITH THE LETTER E OR BY THE EARTH SYMBOL , OR COLOURED GREEN OR GREEN AND YELLOW.

Russia Only - PCT Notice



MPR II Compliance

TCO'95-Ecological requirements for personal computers (TCO'95 applied model only)
TCO'99-Ecological requirements for personal computers (TCO'99 applied model only)
TCO'03-Ecological requirements for personal computers (TCO'03 applied model only)
TCO'03 Recycling Information (TCO'03 applied model only)
Medical Requirement (Medical applied model only)

● **MPR II Compliance**

This monitor complies with SWEDAC(MPR II) recommendations for reduced electric and magnetic fields.

● **TCO'95-Ecological requirements for personal computers (TCO'95 applied model only)**



AB general requirements

AB2 Written Eco-document accompanying the products

Congratulations! You have just purchased a TCO'95 approved and labelled product! Your choice has provided you with a product developed for professional use. Your purchase has also contributed to reducing the burden on the environment and to the further development of environmentally-adapted electronic products.

Why do we have environmentally-labelled monitors?

In many countries, environmental labelling has become an established method for encouraging the adaptation of goods and services to the environment. The main problem as far as monitors and other electronic equipment are concerned is that environmentally harmful substances are used both in the products and during their manufacture. Since it has not been possible so far for the majority of electronic equipment to be recycled in a satisfactory way, most of these potentially damaging substances sooner or later enter Nature.

There are also other characteristics of a monitor, such as energy consumption levels, that are important from both the working and natural environment viewpoints. Since all types of conventional electricity generation have a negative effect on the environment (acidic and climate-influencing emissions, radioactive waste, etc.) it is vital to conserve energy. Electronic equipment in offices consumes an enormous amount of energy, since it is often routinely left running continuously.

What does labelling involve?

This product meets the requirements for the TCO'95 scheme, which provides for international environmental labelling of monitors. The labelling scheme was developed as a joint effort by the TCO (The Swedish Confederation of Professional Employees), Naturskyddsforeningen (The Swedish Society for Nature Conservation) and NUTEK (The National Board for Industrial and Technical Development in Sweden).

The requirements cover a wide range of issues: environment, ergonomics, usability, emission of electrical and magnetic fields, energy consumption and electrical and fire safety.

The environmental demands concern among other things restrictions on the presence and use of heavy metals, brominated and chlorinated flame retardants, CFCs (freons), and chlorinated solvents. The product must be prepared for recycling and the manufacturer is obliged to have an environmental plan, which must be adhered to in each country where the company conducts its operations policy. The energy requirements include a demand that the monitor after a certain period of inactivity shall reduce its power consumption to a lower level, in one or more stages. The length of time to reactivate the monitor shall be reasonable for the user.

Labelled products must meet strict environmental demands, for example in respect of the reduction of electric and magnetic fields, along with physical and visual ergonomics and good usability.

TCO Development Unit 1996-11-29

On the page this folder you will find a brief summary of the environmental requirements met by this product.

The complete environmental criteria document may be ordered from:

TCO Development Unit

S-11494 Stockholm

Sweden

Fax: +46 8 782 92 07

E-mail (Internet): development@tco.se

Current information regarding TCO'95-approved and labelled products may also be obtained via the Internet, using the address:

<http://www.tco-info.com/>

TCO'95 is a co-operative project between (3 logos)

Environmental Requirements

Brominated flame retardants are present in printed circuit boards, cables, wires, casings and housings. In turn, they delay the spread of fire. Up to thirty percent of the plastic in a computer casing can consist of flame retardant substances. These are related to another group of environmental toxins, PCBs, which are suspected to give rise to similar harm, including reproductive damage in fish eating birds and mammals, due to the bioaccumulative processes. Flame retardants have been found in human blood and researchers fear that disturbances in foetus development may occur.

TCO'95 demand requires that plastic components weighing more than 25 grams must not contain organically bound chlorine and bromine.

Lead

Lead can be found in picture tubes, display screens, solders and capacitors. Lead damages the nervous system and in higher doses, causes lead poisoning.

TCO'95 requirement Permits the inclusion of lead since no replacement has yet been developed.

Cadmium

Cadmium is present in rechargeable batteries and in the colour generating layers of certain computer displays. Cadmium damages the nervous system and is toxic in high doses.

TCO'95 requirement states that batteries may not contain more than 25 ppm (parts per million) of cadmium. The colour-generating layers of display screens must not contain any cadmium.

Mercury

Mercury is sometimes found in batteries, relays and switches. Mercury damages the nervous system and is toxic in high doses.

TCO'95 requirement states that batteries may not contain more than 25 ppm (parts per million) of mercury. It also demands that no mercury is present in any of the electrical or electronics components concerned with the display unit.

CFCs (freons)

CFCs (freons) are sometimes used for washing printed circuit boards and in the manufacturing of expanded foam for packaging. CFCs break down ozone and thereby damage the ozone layer in the stratosphere, causing increased reception on Earth of ultraviolet light with consequent increased risks of skin cancer (malignant melanoma).

The relevant TCO'95 requirement: Neither CFCs nor HCFCs may be used during the manufacturing of the product or its packaging.

● TCO'99-Ecological requirements for personal computers (TCO'99 applied model only)



Congratulations!

You have just purchased a TCO'99 approved and labelled product! Your choice has provided you with a product developed for professional use. Your purchase has also contributed to reducing the burden on the environment and also to the further development of environmentally adapted electronics products.

This product meets the requirements for the TCO'99 scheme which provides for an international environmental and quality labelling of personal computers. The labelling scheme was developed as a joint effort by the TCO(The Swedish Confederation of Professional Employees), Svenska Naturskyddsforeningen(The Swedish Society for Nature Conservation), Slatens Energimyndighet(The Swedish National Energy Administration) and SEMKO AB.

The requirements cover a wide range of issues: environment, ergonomics, usability, reduction of electric and magnetic fields, energy consumption and electrical safety.

Why do we have environmentally labelled computers?

In many countries, environmental labelling has become an established method for encouraging the adaptation of goods and services to the environment. The main problem, as far as computers and other electronics equipment are concerned, is that environmentally harmful substances are used both in the products and during their manufacture. Since it is not so far possible to satisfactorily recycle the majority of electronics equipment, most of these potentially damaging substances sooner or later enter nature.

There are also other characteristics of a computer, such as energy consumption levels, that are important from the viewpoints of both the work (internal) and natural (external) environments. Since all methods of electricity generation have a negative effect on the environment (e.g. acidic and climate-influencing emissions, radioactive waste), it is vital to save energy. Electronics equipment in offices is often left running continuously and thereby consumes a lot of energy.

What does labelling involve?

The environmental demands have been developed by Svenska Naturskyddsforeningen (The Swedish Society for Nature Conservation). These demands impose restrictions on the presence and use of heavy metals, brominated and chlorinated flame retardants, CFCs(freons)and chlorinated solvents, among other things. The product must be prepared for recycling and the manufacturer is obliged to have an environmental policy which must be adhered to in each country where the company implements its operational policy.

The energy requirements include a demand that the computer and/or display, after a certain period of inactivity, shall reduce its power consumption to a lower level in one or more stages. The length of time to reactivate the computer shall be reasonable for the user.

Below you will find a brief summary of the environmental requirements met by this product. The complete environmental criteria document may be ordered from:

TCO Development
SE-114 94 Stockholm, Sweden
Fax: +46 8 782 92 07
Email (Internet): development@tco.se

Current information regarding TCO'99 approved and labelled products may also be obtained via the Internet, using the address: <http://www.tco-info.com/>

Environmental requirements

Flame retardants

Flame retardants are present in printed circuit boards, cables, wires, casings and housings. Their purpose is to prevent, or at least to delay the spread of fire. Up to 30% of the plastic in a computer casing can consist of flame retardant substances. Most flame retardants contain bromine or chloride, and those flame retardants are chemically related to another group of environmental toxins, PCBs. Both the flame retardants containing bromine or chloride and the PCBs are suspected of giving rise to severe health effects, including reproductive damage in fish-eating birds and mammals, due to the bio-accumulative* processes. Flame retardants have been found in human blood and researchers fear that disturbances in foetus development may occur.

The relevant TCO'99 demand requires that plastic components weighing more than 25 grams must not contain flame retardants with organically bound bromine or chlorine. Flame retardants are allowed in the printed circuit boards since no substitutes are available.

Cadmium**

Cadmium is present in rechargeable batteries and in the colour-generating layers of certain computer displays. Cadmium damages the nervous system and is toxic in high doses. The relevant TCO'99 requirement states that batteries, the colour-generating layers of display screens and the electrical or electronics components must not contain any cadmium.

Mercury**

Mercury is sometimes found in batteries, relays and switches. It damages the nervous system and is toxic in high doses. The relevant TCO'99 requirement states that batteries may not contain any mercury. It also demands that mercury is not present in any of the electrical or electronics components associated with the labelled unit. There is however one exception. Mercury is, for the time being, permitted in the back light system of flat panel monitors as today there is no commercially available alternative. TCO aims on removing this exception when a Mercury free alternative is available.

CFCs (freons)

The relevant TCO'99 requirement states that neither CFCs nor HCFCs may be used during the manufacture and assembly of the product. CFCs (freons) are sometimes used for washing printed circuit boards. CFCs break down ozone and thereby damage the ozone layer in the stratosphere, causing increased reception on earth of ultraviolet light with e.g. increased risks of skin cancer (malignant melanoma) as a consequence.

Lead**

Lead can be found in picture tubes, display screens, solders and capacitors. Lead damages the nervous system and in higher doses, causes lead poisoning. The relevant TCO'99 requirement permits the inclusion of lead since no replacement has yet been developed.

-
- **TCO'03-Ecological requirements for personal computers (TCO'03 applied model only)**

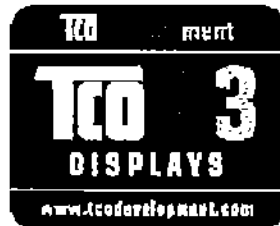

Congratulations!

The display you have just purchased carries the TCO'03 Displays label. This means that your display is designed, manufactured and tested according to some of the strictest quality and environmental requirements in the world. This makes for a high performance product, designed with the user in focus that also minimizes the impact on our natural environment.

Some of the features of the TCO'03 Display requirements:

Ergonomics

Good visual ergonomics and image quality in order to improve the working environment for the user and to reduce sight and strain problems. Important parameters are luminance, contrast, resolution, reflectance, colour rendition and image stability.

Energy

Energy-saving mode after a certain time – beneficial both for the user and the environment
Electrical safety

Emissions

- Electromagnetic fields
- Noise emissions

Ecology

- The product must be prepared for recycling and the manufacturer must have a certified environmental management system such as EMAS or ISO 14 000
- Restrictions on
 - chlorinated and brominated flame retardants and polymers
 - heavy metals such as cadmium, mercury and lead.

The requirements included in this label have been developed by TCO Development in cooperation with scientists, experts, users as well as manufacturers all over the world. Since the end of the 1980s TCO has been involved in influencing the development of IT equipment in a more user-friendly direction. Our labelling system started with displays in 1992 and is now requested by users and IT-manufacturers all over the world.

For more information, Please visit
www.tcodevelopment.com

• TCO'03 Recycling Information (TCO'03 applied model only)

[European Residents Only]

For recycling information for TCO'03 certified monitors, for the residents in the following countries, please contact the company corresponding to your region of residence. For those who reside in other countries, please contact a nearest local Samsung dealer for recycling information for the products to be treated in environmentally acceptable way.

	[U.S.A. Residents Only]	[European Residents Only]		
	U.S.A.	SWEDEN	NORWAY	GERMANY
COMPANY	Solid Waste Transfer & Recycling Inc	ELKRETSSEN	Elektronikkretur AS	vfw AG
ADDRESS	442 Frelinghuysen Ave Newark, NJ 07114	ELKRETSSEN Box 1357, 111 83 Stockholm Barnhusgatan 3, 4 tr.	6454 Etterstad 0602 Oslo Fyrstikkalln 3B	Max Plank Strasse 42 50858 Collogne Germany
TELEPHONE	973-565-0181	08-545 212 90	23 06 07 40	49 0 2234 9587 - 0
FAX	Fax: 973-565-9485	08-545 212 99	23 06 07 41	
E-MAIL	none	info@el-kretsen.se	adm@elektronikkretur.no	vfw.info@vfw-ag.de
HOME PAGE	http://www.bcua.org/SolidWaste_Disposal.htm	http://www.el-kretsen.se/	http://www.elretur.no/	

• Medical Requirement (Medical applied model only)



Classifications:

In accordance with UL 2601-1/IEC 60601-1, the product is classified as Continuous duty Class I equipment, which is not protected against ingress of liquids. The product is not suitable for use in the presence of a flammable anaesthetic mixture with air or with oxygen or nitrous oxide.

EMC

This equipment has been tested and found to comply with the limits for medical devices to the IEC 601-1-2:1994. These limits are designed to provide reasonable protection against harmful interference in a typical medical installation. This equipment generates, uses and can radiate radio frequency energy and, if not installed and used in accordance with the instructions, may cause harmful interference to other devices in the vicinity. However, there is no guarantee that interference will not occur in a particular installation. If this equipment does cause harmful interference to other devices, which can be determined by turning the equipment off and on, the

user is encouraged to try to correct the interference by one or more of the following measures:

- Reorient or relocate the receiving device.
- Increase the separation between the equipment.
- Connect the equipment into an outlet on a circuit different from that to which the other device(s) are connected.
- Consult the manufacturer or field service technician for help.

Video In / RS 232 / Video Out

Accessories equipment connected to the analog and digital interfaces must be certified to the respective IEC standards (i.e. IEC 950 for data processing equipment and IEC 601-1 for medical equipment.) Furthermore all configurations shall comply with the system standard IEC 601-1-1. Everybody who connects additional equipment to the signal input part or signal output part configures a medical system, and is therefore, responsible that the system complies with the requirements of the system standard IEC 601-1-1. If in doubt, consult the technical services department or your local representative.

Transport and Storage Limitations:

Temperature Range of -40°C to +70°C

Relative Humidity of 10 -95%, non-condensing

- * Bio-accumulative is defined as substances which accumulate within living organisms.
- ** Lead, Cadmium and Mercury are heavy metals which are Bio-accumulative.

8 Block Diagram

In This Document can not be used without Samsung's authorization.

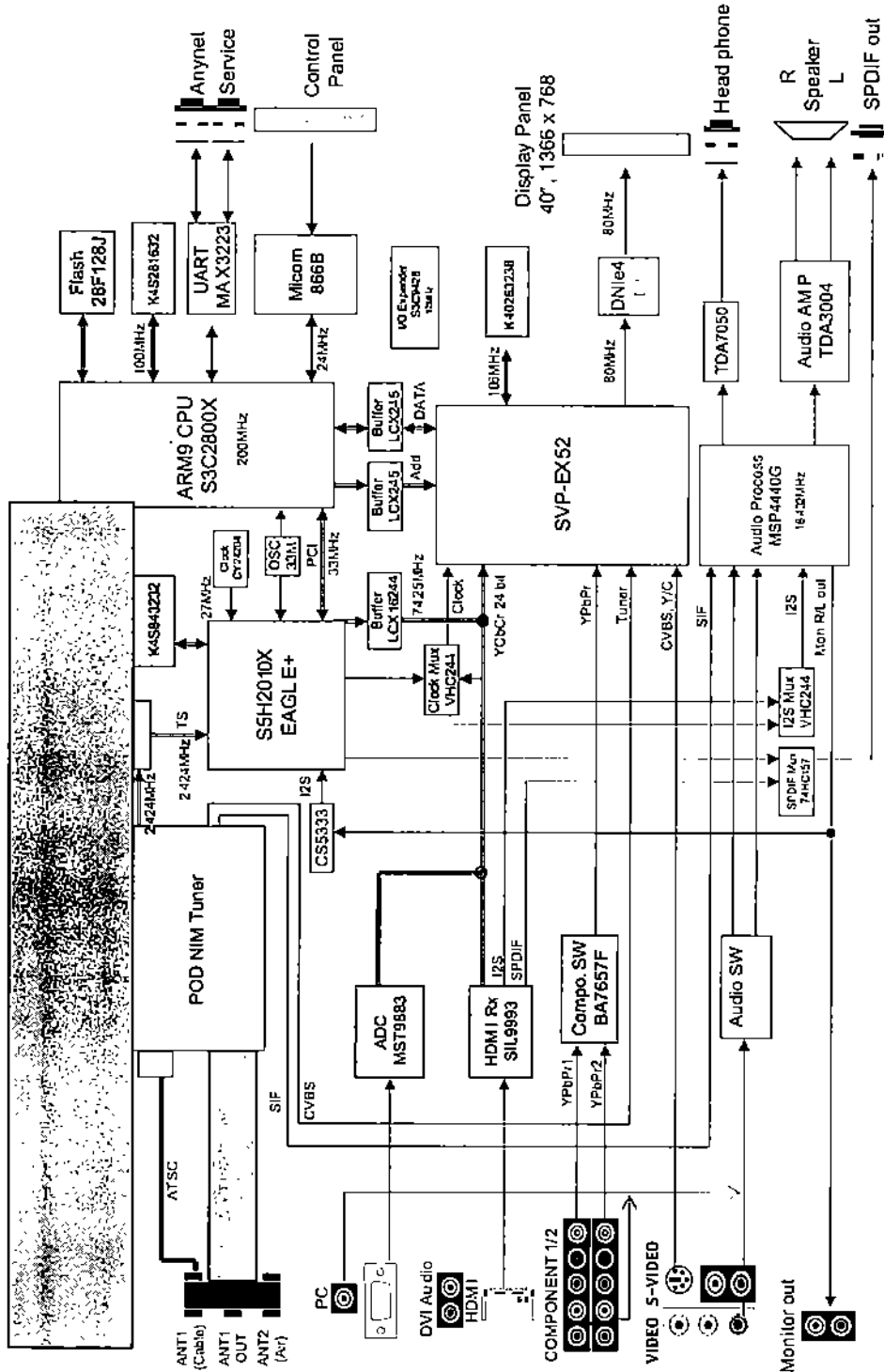

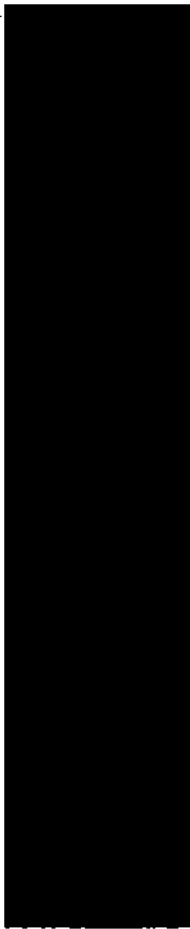

LN-R269D
LN-R329D
LN-R409D
LN-R469D

TFT-LCD TELEVISION



ELECTRONICS

1-800-SAMSUNG (1-800-726-7864)

U.S.A.
Samsung Electronics America
Service Division
400 Valley Road, Suite 301
Mount Arlington, NJ 07856
www.samsung.com

Canada
Samsung Electronics Canada Inc.
Samsung Customer Care
7037 Financial Drive
Mississauga, Ontario
L5N 6R3
www.samsung.ca

BN68-00918A-X0

Owner's Instructions

This device is a Class B digital apparatus.
Register your product at
www.samsung.com/global/register

Precautions When Displaying a Still Image

A still image may cause permanent damage to the TV screen.

Digital Ready TV: When you select the regular screen (4:3) mode to watch an SD-grade digital broadcast (and the Set-Top Box output is 480p).

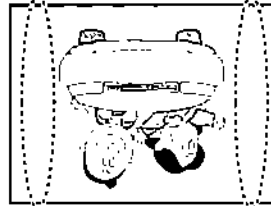

Digital Ready TV: When you select the wide screen (16:9) mode to watch an SD-grade digital broadcast (and the Set-Top Box output is 1080i).

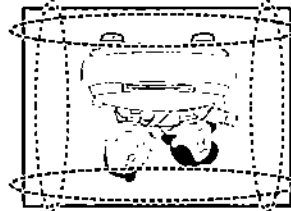

Although digital broadcasting must be in the wide screen (16:9) HD format, broadcasters sometimes show programs made originally in the regular screen format (4:3) by converting the signals into digital form, in which case the left and right side edges of the screen are cropped.

Note: If the borders at the left, right and the

center of the screen remain fixed for an extended period of time, the amount of light transmission will also remain varied and as a result the borders may leave traces.

Do not leave the screen in pause mode for extended periods of time as you may experience temporary or permanent image burn.

Digital Ready TV: When the TV receives HD-grade signals (and the Set-Top Box output is 1080i).

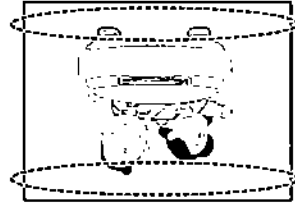

When you watch a digital HD-grade broadcast on a regular (4:3) TV with the screen size "16:9" or "Panorama" selected, you will be able to watch the program but the top and bottom edges of the screen will be cropped.

Note: If the borders at the top, bottom and

the center of the screen remain fixed for an extended period of time, the amount of light transmission will also remain varied and as a result the borders may leave traces.

Do not leave the screen in pause mode for extended periods of time as you may experience temporary or permanent image burn.

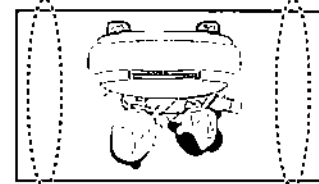

- Integrated Digital TV (Wide-screen): When the TV receives SD-grade (regular) broadcasting signals (receives 480p regular signals).
- Digital Ready TV (wide-screen): digital TV: When the TV receives SD-grade (regular) broadcasting signals (with a Set-Top Box).
- When you watch an analog (regular) broadcast on a wide-screen TV (with the 4:3 screen mode selected).

- When you watch a DVD, CD or a video in wide-screen (21:9) format on a wide-screen (16:9) TV.
- When you connect a computer or a game console to the TV and select the 4:3 screen mode.



Although digital broadcasting must be in the wide screen (16:9) HD format, broadcasters sometimes show programs made originally in the regular screen format (4:3) by converting the signals into digital form, in which case the left and right side edges of the screen are cropped.

Note: If the borders at the left, right and the center of the screen remain fixed for an extended period of time, the amount of light transmission will also remain varied and as a result the borders may leave traces.

Do not leave the screen in pause mode for extended periods of time as you may experience temporary or permanent image burn.

If you connect a DVD player, computer or a game console to the wide-screen TV and watch a movie or play a game in regular (4:3) or wide (21:9) screen mode, the left and right side edges, or the top and bottom edges of the screen will be cropped.

Note: If the borders at the left, right and the center of the screen remain fixed for an extended period of time, the amount of light transmission will also remain varied and as a result the borders may leave traces.

Do not leave the screen in pause mode for extended periods of time as you may experience temporary or permanent image burn.

CONTENTS

Chapter 1: General Information	1
List of Features	1
List of Parts	1
Familiarizing Yourself with Your New TV	2
Buttons on the Lower-Right Part of the Panel	2
Rear Panel Jacks	3
Remote Control	5
Installing Batteries in the Remote Control	7
If the remote control doesn't work	7
Chapter 2: Connections	8
Connecting VHF and UHF Antennas	8
Antennas with 300-ohm Flat Twin Leads	8
Antennas with 75-ohm Round Leads	9
Separate VHF and UHF Antennas	9
Connecting Cable TV	9
Cable without a Cable Box	9
Connecting to a Cable Box that Descrambles All Channels	10
Connecting to a Cable Box that Descrambles Some Channels	10
Connecting a VCR	12
Connecting an S-VHS VCR	14
Connecting a DVD/Set-Top Box via DVI	15
Connecting a DVD/Set-Top Box via HDMI	15
Connecting a DVD Player	16
Connecting a Digital Audio System	16
Connecting an Amplifier/DVD Home Theater	17
Connecting a PC	17
Chapter 3: Operation	19
Turning the TV On and Off	19
Changing Channels	19
Using the Channel Buttons	19
Using the PRF-CH Button to select the Previous Channel	19
Adjusting the Volume	19
Using Mute	19
Viewing the Display	20
Viewing the Menu	20
Plug & Play Feature	21
If you want to reset this feature	24
Memorizing the Channels	25
Selecting the Video Signal-source	25
Storing Channels in Memory (Automatic Method)	26
Adding and Erasing Channels (Manual Method)	28
Setting Up Your Remote Control	29
Remote Control Codes	32
To Select the Source	33
To Edit the Input Source Name	35

37	Using Automatic Picture Settings
39	Adjusting the Color Tone
40	DNic (Digital Natural Image engine)
41	Changing the Screen Size
43	Freezing the Picture
44	Viewing Picture-in-Picture
44	Activating Picture-in-Picture
45	Selecting a Signal Source (External A/V) for PIP
46	Swapping the Contents of the PIP and Main image
46	Changing the PIP Channel
47	Changing the Position of the PIP Window
47	Changing the Size of the PIP Window
48	My Color Control
48	Easy Control
49	Detail Control
50	Dynamic Contrast
51	Brightness Sensor
Chapter 4: Picture Control	
52	Customizing the Sound
53	Using Automatic Sound Settings
54	Setting the Trusurround XT
55	Choosing a Multi-Channel Sound(MTS) track - Digital
55	Preferred Language
56	Multi-Track Sound
57	Automatic volume control
58	Selecting the Internal Mute
59	Choosing a Digital Sound Format
60	Setting the On/Off Melody
Chapter 5: Sound Control	
61	Selecting the antenna
62	To Set-up Your Favorite Channels
63	Labeling Channels
64	Viewing the Channel Lists
65	Editing the Channel Lists
66	Fine Tuning Analog Channels
67	Checking the Digital-Signal Strength
68	LNA (Low Noise Amplifier)
Chapter 6: Channel Control	
69	Using Your TV as a Computer (PC) Display
69	Setting Up Your PC Software (Based on Windows XP)
70	How to Auto Adjust
71	Adjusting the Screen Quality
72	Changing the Screen Position
73	Initializing the Screen Position or Color Settings
Chapter 7: PC Display	

CONTENTS

Chapter 8: Time Setting 74

 Setting the Clock 74

 Option 1: Setting the Clock Manually 74

 Option 2: Setting the Clock Automatically 73

 Setting the Sleep Timer 78

 Setting the On/Off Timer 79

Chapter 9: Function Description 81

 Selecting a Menu Language 81

 Selecting the Film Mode 82

 Digital Noise Reduction 83

 Using the Color Weakness Enhancement Option 84

 Viewing Closed Captions (On-Screen Text Messages) - Analog 86

 Viewing Closed Captions (On-Screen Text Messages) - Digital 88

 Menu Transparency Level 91

 Setting the Function Help 92

 Using the V-Chip 93

 Setting Up Your Personal ID Number (PIN) 93

 How to Enable/Disable the V-Chip 94

 How to Set up Restrictions Using the "TV Parental Guidelines" 95

 How to Set up Restrictions Using the MPA Ratings: 97

 G, PG, PG-13, R, NC-17, X, NR 97

 How to Set up Restrictions Using the "Canadian English" 99

 How to Set up Restrictions Using the "Canadian French" 100

 How to Reset the TV after the V-Chip Blocks a Channel 101

 ("Emergency Escape") 101

 Electronic Program Guide 102

 Viewing the Electronic Program Guide 102

 Using the Electronic Program Guide 103

 Viewing Information about a Single Channel 104

 Viewing Information about Channels 105

 Reminder List 107

 Viewing the Reminder List 107

 To view the Reminder List 108

 To remove the scheduled programs 108

 Using the CableCARD (Sold separately) (LN-R409D, LN-R469D) 109

 Displaying CableCARD related information 109

 Using the CableCARD Setup Function (LN-R409D, LN-R469D) 110

 CableCARD Reset 110

 Channel List Reorganization 111

Chapter 10: Appendix 112

 Identifying Problems 112

 Disconnecting the stand 114

 Installing the Wall Mount Kit (LN-R269D) 115

 Installing the Wall Mount Kit (LN-R329D, LN-R409D, LN-R469D) 116

 Using the Anti-Theft Kensington Lock 117

 Using Your TV in Another Country 117

 CableCARD and Digital Cable Ready TVs 118

 Specifications 119

 Display Modes 121

Chapter One





GENERAL INFORMATION

List of Features

- Excellent Digital Interface & Networking :
With a built-in HD digital tuner, this TV supports HD broadcasts with no Set-Top Box needed, and provides simple access with a single remote control.
- Excellent Picture Quality
- DNIC technology provides life-like clear images.
- My Color Control: Colors can be set to your preference by adjusting pink, blue and green.
- Dynamic Contrast: Automatically detects the input visual signal and adjusts to create optimum contrast.
- Brightness Sensor: Adjusts the screen brightness automatically depending on the brightness of the surrounding environment.
- SRS TruSurround XT
- SRS TruSurround XT provides a virtual Dolby surround system.
- Convenience
- The TV utilizes the HDMI system to implement perfect digital sound and picture quality.
- The Anynet system enables you to easily control Samsung audio-video (AV) devices from this TV.

List of Parts

Please make sure the following items are included with your LCD TV.
If any items are missing, contact your dealer.

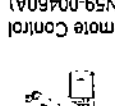
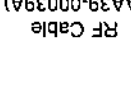
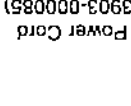
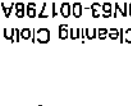
	Remote Control (BN59-00460A) & Batteries (AAA x 2)		RF Cable (AA39-00039A)		Power Cord (3903-000085)		Cleaning Cloth (BN63-001798A)
	Owner's Instructions		Anynet AV Owner's Instructions		Cover-Bottom 26" 32"(BN63-01947A) Cover-Top 40" 46"(BN63-01638A)		Anynet Cable (BN39-00518B)

Familiarizing Yourself with Your New TV

Buttons on the Lower-Right Part of the Panel

The buttons on the lower-right panel control your TV's basic features, including the on-screen menu. To use the more advanced features, you must use the remote control.

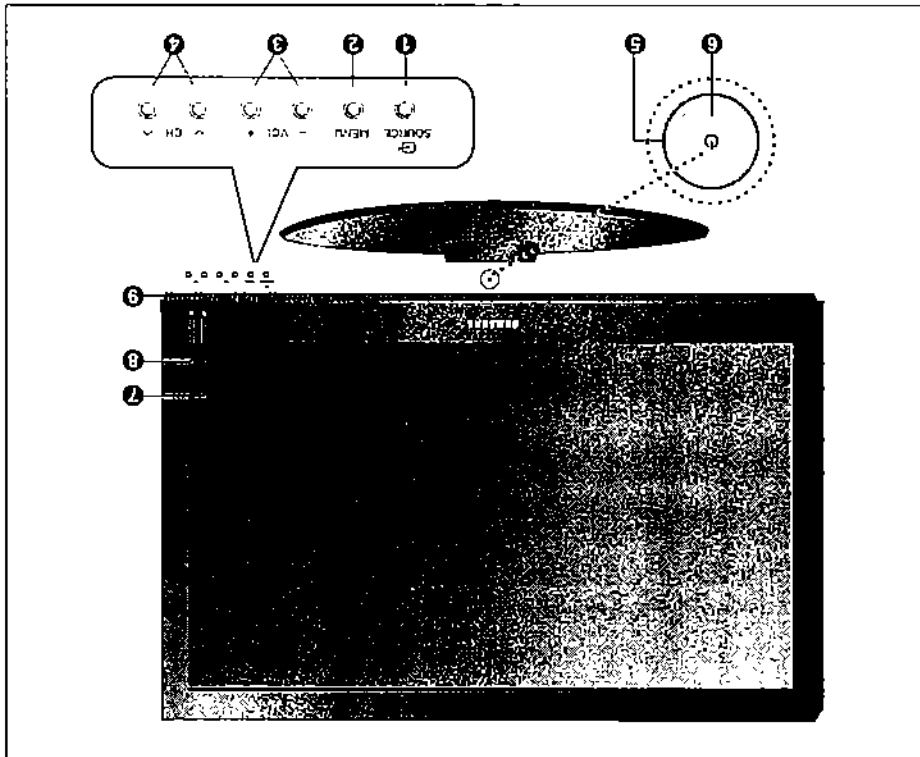

- 1 SOURCE** Displays a menu of all of the available input sources (TV, AV, S-VIDEO, Component 1, Component 2, HDMI, PC).
- 2 MENU** Press to see an on-screen menu of your TV's features.
- 3 - VOL +** Press to decrease or increase the volume. Also used to select items on the on-screen menu.
- 4 CH** Press to change channels. Also press to highlight various items on the on-screen menu.
- 5 (POWER)** Press to turn the TV on and off.
- 6 POWER INDICATOR** Blinks and turns off when the power is on and lights up in stand-by mode.
- 7 REMOTE CONTROL SENSOR** Aim the remote control towards this spot on the TV.
- 8 LIGHT DETECTING SENSOR** Adjusts the brightness of the screen automatically by detecting brightness of the surrounding environment. This sensor works when the Brightness Sensor is on.
- 9 SPEAKERS**

GENERAL INFORMATION

Rear Panel Jacks

Use the rear panel jacks to connect an A/V component that will be connected continuously, such as a VCR or a DVD player.

For more information on connecting equipment, see pages 8-18.

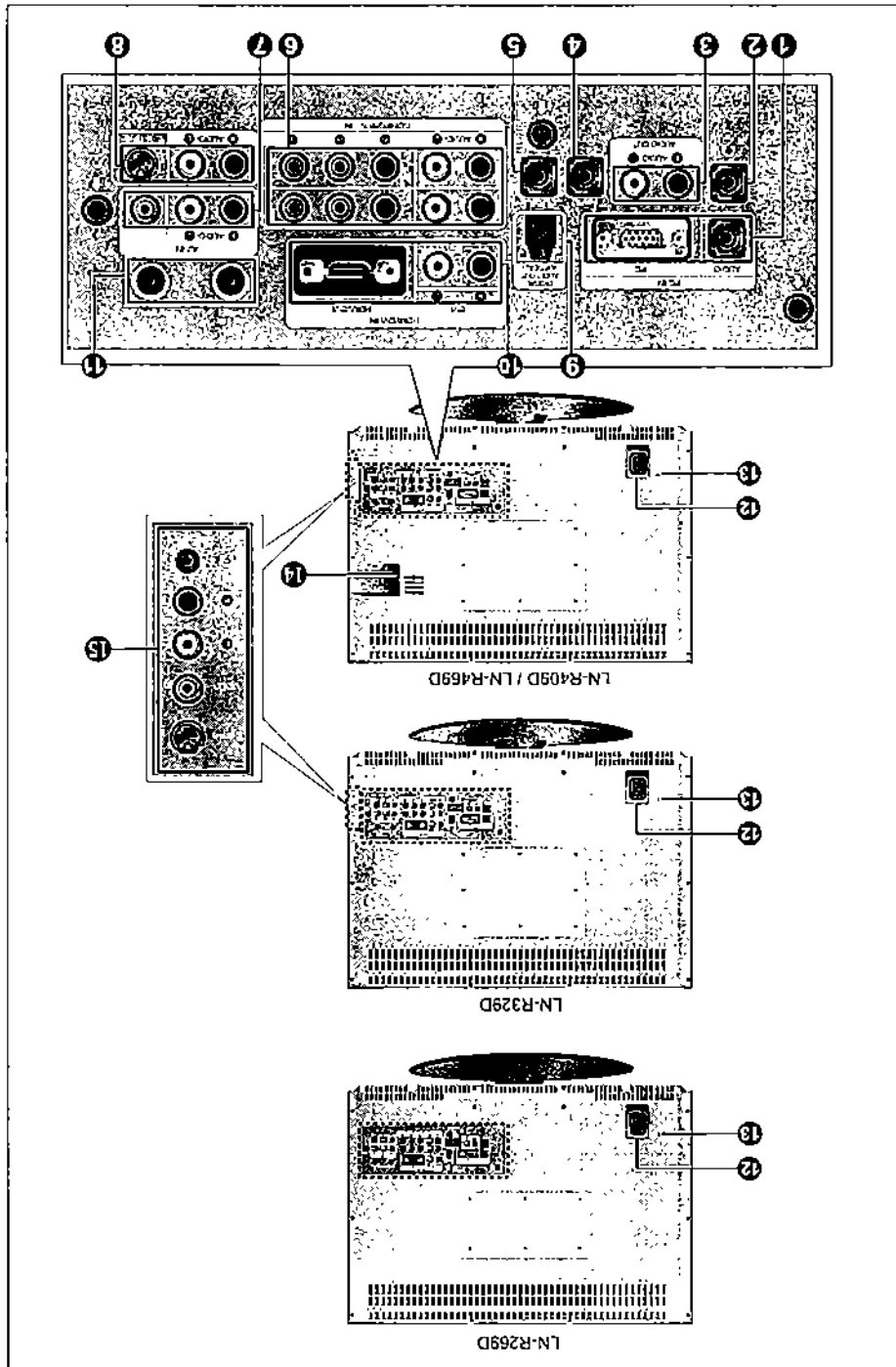

GENERAL INFORMATION

1 PC IN
Connect to the video and audio output jack on your PC.

2 HEADPHONE JACK
Connect a set of external headphones for private listening.

3 AUDIO OUT
Connect to the audio input jack on your Amplifier/home theater.

4 Anynet OUTPUT
Refer to "Aynet AV Owner's Instructions".

5 SERVICE
Connector for service only.

6 COMPONENT IN
Connect component video/audio from a DVD/Set-Top Box.

7 AV IN
Video and audio inputs for external devices, such as a camcorder or VCR.

8 S-VIDEO IN
Video inputs for external devices with an S-Video output, such as a camcorder or VCR.

9 OPTICAL DIGITAL AUDIO OUT
Connect to a Digital Audio component.

Speaker	RF	AV, S-Video	Component, PC, HDMI	RF	AV, S-VIDEO	Component, PC, HDMI
Internal Mute Off	Speaker Output	Speaker Output	Speaker Output	Sound Output	Sound Output	Sound Output
Internal Mute On	Mute	Mute	Mute	Sound Output	Sound Output	Sound Output
Video No Signal	Mute	Mute	Mute	Mute	Sound Output	Sound Output

When "Internal mute" is set to "On", Sound menus except "Mute-Track Options" and "Digital Output" cannot be adjusted.

10 HDMI/DVI IN
Connect to the HDMI jack of a device with HDMI output. Use the HDMI/DVI Adapter (DVI to HDMI) for the connection, and the "R-AUDIO-L" terminal on DVI-IN for sound output.

11 ANT IN
Connect to an antenna or to a cable TV system. (See page 8~11)

12 POWER INPUT
Connect the supplied power cord.

13 KENSINGTON LOCK
Refer to "Using the Anti-Theft Kensington Lock" on page 117.

14 CABLE CARD(LN-R409D/LN-R469D)
Insert the cablCARD into the slot.

15 AV-SIDE SUB
(LN-R329D / LN-R409D / LN-R469D)
Please refer to the contents of 2, 7 and 8.

Remote Control

You can use the remote control up to a distance of about 23 feet from the TV. When using the remote, always point it directly at the TV. You can also use your remote control to operate your VCR, Cable box, DVD player, or Set-Top Box.

- 1 **POWER**
Turns the TV on and off. (See page 19)
- 2 **ANTENNA**
Press to select "AIR" or "CABLE". (See pages 8~11)
- 3 **GUIDE**
Press to display the on-screen Electronic Program Guide (EPG). (See page 103)
- 4 **-**
Press to select additional channels (digital and analog) being broadcast by the same station. For example, to select channel "54-3", press "54", then press "-" and "3".
- 5 **MUTE**
Press to temporarily cut off the sound. (See page 19)
- 6 **MENU**
Displays the main on-screen menu. (See page 20)
- 7 **MODE**
Selects a target device to be controlled by the Samsung remote control (TV, VCR, CATV, DVD, STB). (See pages 29~31)
- 8 **NUMERIC BUTTONS**
Press to change the channel.
- 9 **PRE-CH**
Tunes to the previous channel. (See page 19)
- 10 **CH \blacktriangledown and CH \blacktriangle (channel UP/down)**
Press CH \blacktriangledown or CH \blacktriangle to change channels. (See page 19)
- 11 **VOL + and VOL -**
Press to increase or decrease the volume. (See page 19)
- 12 **SOURCE**
Press to display all of the available video sources.
- 13 **UP / DOWN / LEFT / RIGHT / ENTER**
Use to select on-screen menu items and change menu values.
- 14 **FAVCH**
Press to switch to your favorite channels. (See page 62)
- 15 **MTS**
Press to choose stereo, mono or Separate Audio Program (SAP broadcast). (See pages 55~56)
- 16 **PIP**
Picture-in-Picture ON/OFF. (See page 44)
- 17 **CHLIST**
Displays the channel list.

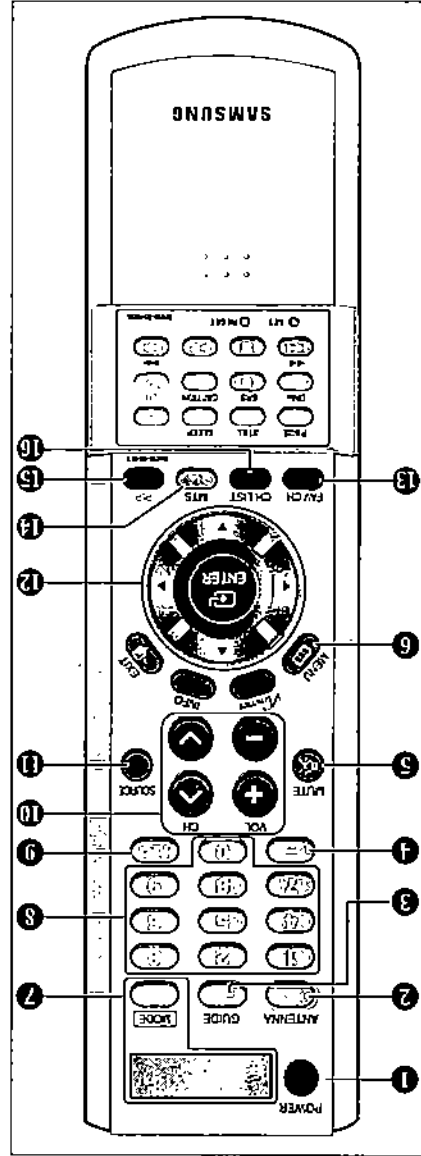

GENERAL INFORMATION

- ① **Anynet**
Press the Anynet button to bring up the Anynet menu.
Refer to "Anynet AV Owner's Instructions".
- ② **STILL**
Press to stop the action during a particular scene.
Press again to resume normal video. (See page 43)
- ③ **P.SIZE**
Press to change the screen size. (See page 42)
- ④ **D.NIe**
Off : DNIe Demo mode is deactivated.
On : The right-hand side of the screen shows the improved DNIe image.
The left-hand side of the screen shows the original image.
(See page 40)
- ⑤ **SRS**
Selects TruSurround XT mode. (See page 54)
- ⑥ **SET**
Adjusts 5 separate devices - TV, VCR, Cable, DVD, or Set-Top Box. (See pages 29-31)
- ⑦ **INFO**
Use to see information on the current broadcast. (See page 20)
- ⑧ **EXIT**
Press to exit the menu.
- ⑨ **SLEEP**
Press to select a preset time interval for automatic shut off.
- ⑩ **CH** ∇ \blacktriangleright
Displays the available channels in sequence. (These buttons change channels in the PIP window only.) (See page 46)
- ⑪ **CAPTION**
Controls the caption decoder. (See pages 86-90)
- ⑫ **VCR/DVD Functions (Anynet mode only)**
- Rewind
- Stop
- Play/Pause
- Fast/Forward
- ⑬ **RESET**
When your remote does not work, change the batteries and press the RESET button for 2-3 seconds before use.

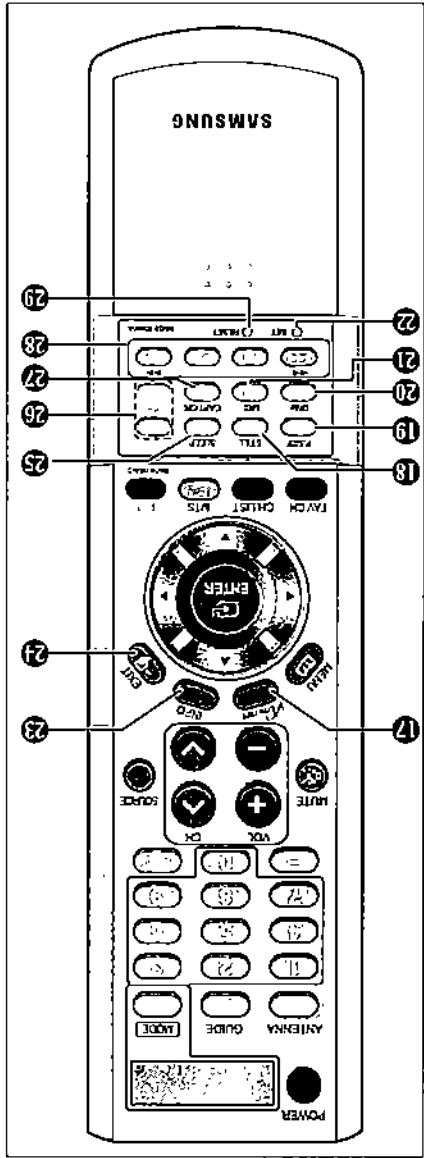

Installing Batteries in the Remote Control

1
Slide the Cover out completely.

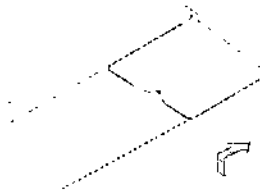

2
Install two AAA size batteries.

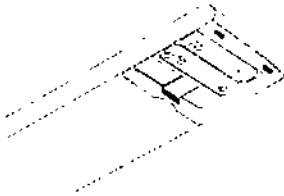

▶ Make sure to match the "+" and "-" ends of the batteries with the diagram inside the compartment.

3
Replace the cover.

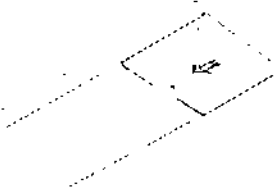

▶ Remove the batteries and store them in a cool, dry place if you won't be using the remote control for a long time.

The remote control can be used up to about 23 feet from the TV. (Assuming typical TV usage, the batteries last for about one year.)

If the remote control doesn't work

Check the following:

1. Is the TV power on?
2. Are the plus and minus ends of the batteries reversed?
3. Are the batteries drained?
4. Is there a power outage, or is the power cord unplugged?
5. Is there a special fluorescent light or a neon sign nearby?

Chapter Two

CONNECTIONS

Connecting VHF and UHF Antennas

If your antenna has a set of leads that look like this, see "Antennas with 300-ohm Flat Twin Leads" below.

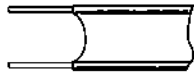

If your antenna has one lead that looks like this, see "Antennas with 75-ohm Round Leads" on page 8.



If you have two antennas, see "Separate VHF and UHF Antennas" on page 8.

Antennas with 300-ohm Flat Twin Leads

If you are using an off-air antenna (such as a roof antenna or "rabbit ears") that has 300-ohm twin flat leads, follow the directions below.

- 1 Place the wires from the twin leads under the screws on a 300-75 ohm adaptor (not supplied). Use a screwdriver to tighten the screws.

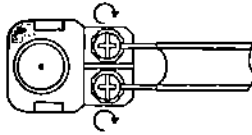

- 2 Plug the adaptor into the ANT 1 IN(CABLE) terminal on the back of the TV.

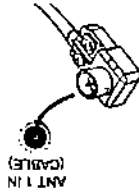

CONNECTIONS

Antennas with 75-ohm Round Leads

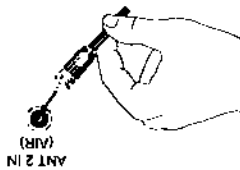

1 Plug the antenna lead into the ANT 2 IN (AIR) terminal on the bottom of the back panel.

Separate VHF and UHF Antennas

If you have two separate antennas for your TV (one VHF and one UHF), you must combine the two antenna signals before connecting the antennas to the TV. This procedure requires an optional combiner-adaptor (available at most electronics shops).

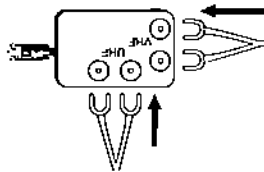

1 Connect both antenna leads to the combiner.

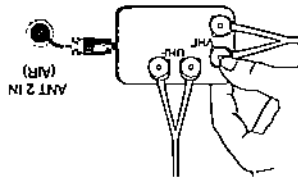

2 Plug the combiner into the ANT 2 IN (AIR) terminal on the bottom of the rear panel.

Connecting Cable TV

To connect to a cable TV system, follow the instructions below:

Cable without a Cable Box

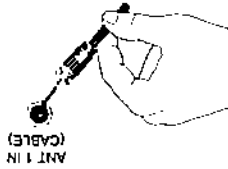

1 Plug the incoming cable into the ANT 1 IN (CABLE) terminal on the back of the TV.

Because this TV is cable-ready, you do not need a cable box to view unscrambled cable channels.

CONNECTIONS

Connecting to a Cable Box that Describes All Channels

1 Find the cable that is connected to the ANT OUT terminal on your cable box.
 ▶ This terminal might be labeled "ANT OUT", "VHF OUT" or simply, "OUT".



2 Connect the other end of this cable to the ANT 1 IN(CABLE) terminal on the back of the TV.
 ▶ This terminal might be labeled "ANT IN", "VHF IN" or simply, "IN".

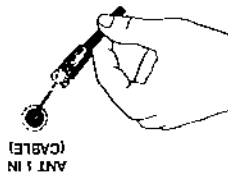

Connecting to a Cable Box that Describes Some Channels

If your cable box describes only some channels (such as premium channels), follow the instructions below. You will need a two-way splitter, an RF (A/B) switch, and four lengths of RF cable. (These items are available at most electronics stores.)

1 Find and disconnect the cable that is connected to the ANT IN terminal on your cable box.

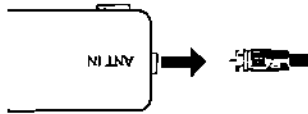

2 Connect this cable to a two-way splitter.

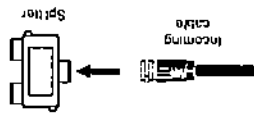

3 Connect an RF cable between an OUTPUT terminal on the splitter and the IN terminal on the cable box.

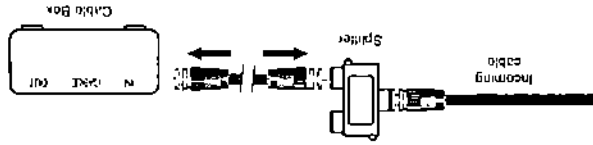

CONNECTIONS

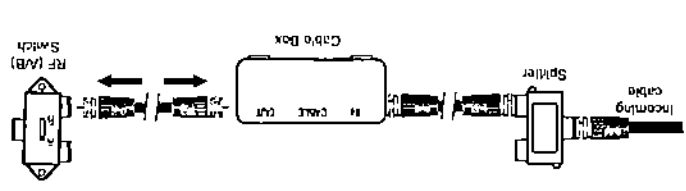

4
 Connect an RF cable between the ANT OUT terminal on the cable box and the B-IN terminal on the A/B switch.

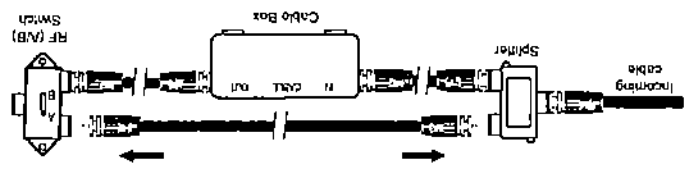

5
 Connect another cable between the other OUT terminal on the splitter and the A-IN terminal on the RF (A/B) switch.

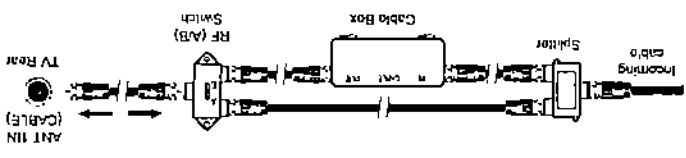

6
 Connect the last RF cable between the ANT 1 IN (CABLE) terminal on the rear of the TV.

After you have made this connection, set the A/B switch to the "A" position for normal viewing. Set the A/B switch to the "B" position to view scrambled channels. (When you set the A/B switch to "B", you will need to tune your TV to the cable box's output channel, which is usually channel 3 or 4.)

CONNECTIONS

These instructions assume that you have already connected your TV to an antenna or a cable TV system (according to the instructions on pages 8-11). Skip step 1 if you have not yet connected to an antenna or a cable system.

Connecting a VCR

1 Unplug the cable or antenna from the back of the TV.

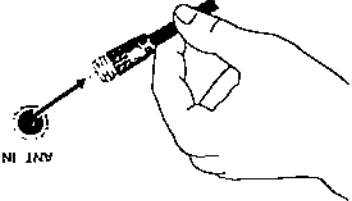

2 Connect the cable or antenna to the ANTENNA IN terminal on the back of the VCR.

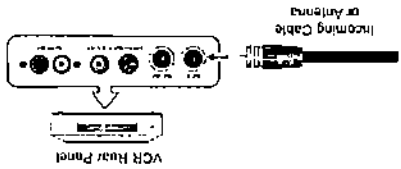

3 Connect an RF cable between the ANT OUT terminal on the VCR and the ANT 1 IN (CABLE) or ANT 2 IN (AIR) terminal on the TV.

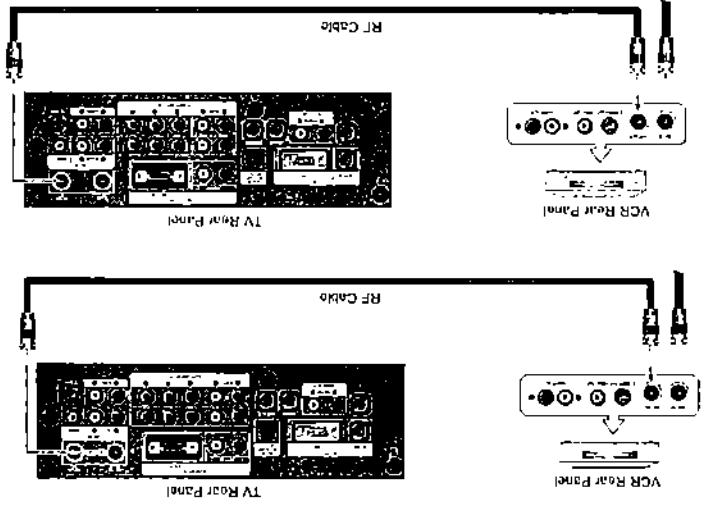

CONNECTIONS

4
Connect an audio cable between the AUDIO OUT jacks on the VCR and the AV IN (R-AUDIO-L) jacks on the TV.

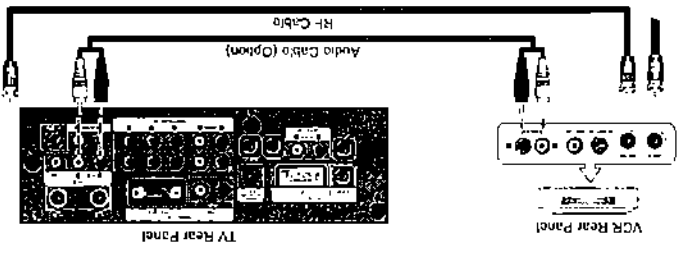

If you have a "mono" (non-stereo) VCR, use the Y-connector (not supplied) to hook up to the right and left audio input jacks of the TV. If your VCR is stereo, you must connect two cables.

5
Connect a video cable between the VIDEO OUT jack on the VCR and the AV IN (VIDEO) jack on the TV.

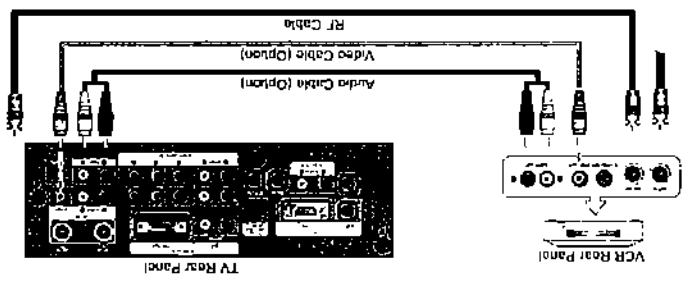

Follow the instructions in "Viewing a VCR or Camcorder Tape" to view your VCR tape.
* Each external input source device has a different back panel configuration.

6 (LN-R329D / LN-R409D / LN-R469D)

- Connect an audio cable between the AUDIO OUT jacks on the VCR and the (AV - SIDE SUB) jacks on the TV.
- Connect a video cable between the VIDEO OUT jack on the VCR and the (AV - SIDE SUB) jack on the TV.
- Connect an s-video cable between the S-VIDEO OUT jack on the VCR and the (AV - SIDE SUB) jack on the TV.

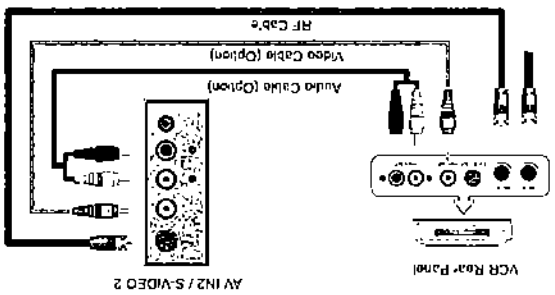

* The following models are applied.

Connecting an S-VHS VCR

Your Samsung TV can be connected to an S-Video signal from an S-VHS VCR. (This connection delivers a better picture as compared to a standard VHS VCR.)

CONNECTIONS

To begin, follow steps 1-3 in the previous section to connect the antenna or cable to your VCR and your TV.



2 Connect an audio cable between the AUDIO OUT jacks on the VCR and the AV IN [R-AUDIO-L] jacks on the TV.

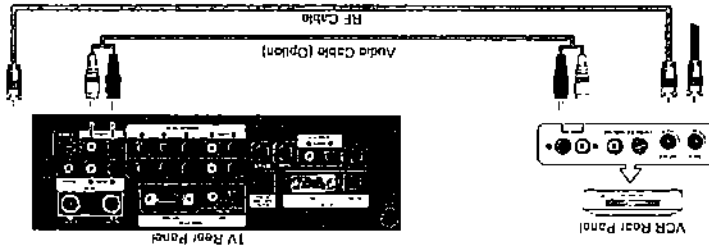

3 Connect an S-video cable between the S-VIDEO OUT jack on the VCR and the AV IN [S-VIDEO] jack on the TV.

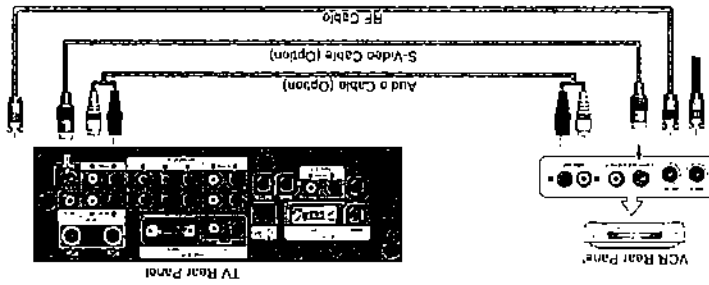

An S-Video cable is usually included with an S-VHS VCR. (If not, check your local electronics store.)
* Each external input source device has a different back panel configuration.

CONNECTIONS

Connecting a DVD/Set-Top Box via DVI

This can be applied only if there is a DVI Output connector on the external device.

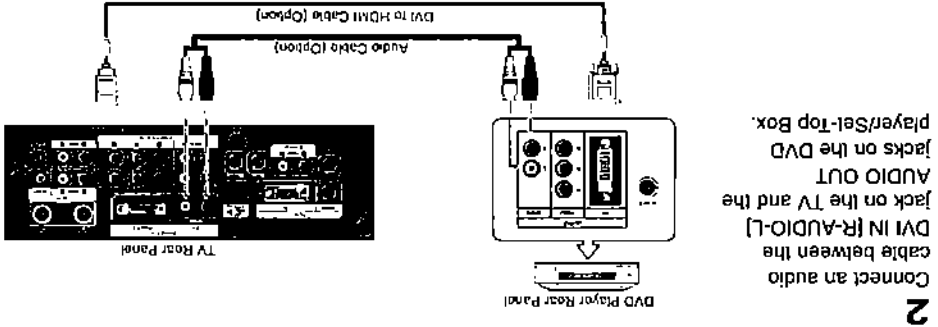
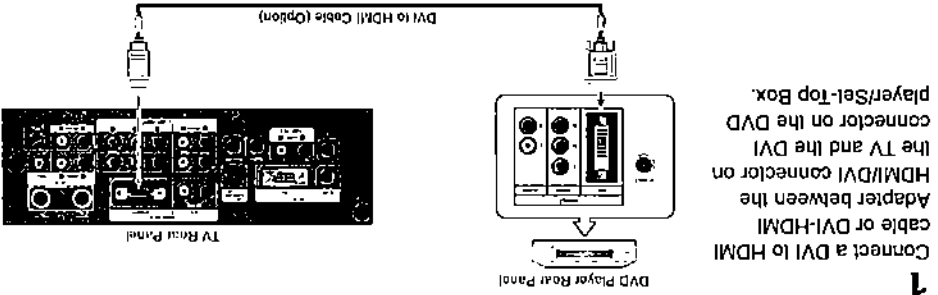

Connecting a DVD/Set-Top Box via HDMI

This can be applied only if there is the HDMI Output connector on the external device.

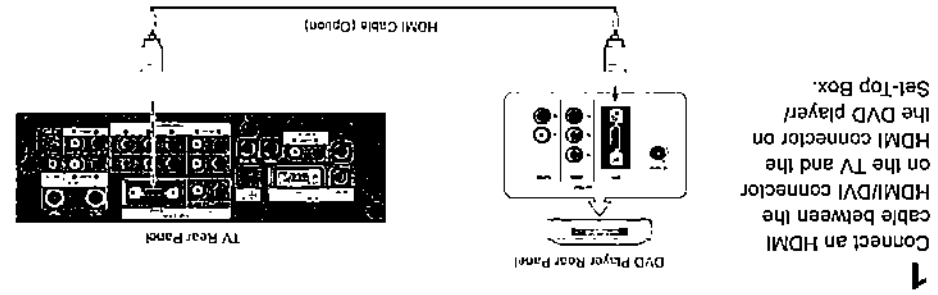

What is HDMI?

- HDMI, or high-definition multimedia interface, is a next-generation interface that enables the transmission of digital audio and video signals using a single cable without compression.
- "Multimedia interface" is a more accurate name for it especially because it allows multiple channels of digital audio (5.1 channels). The difference between HDMI and DVI is that the HDMI device is smaller in size, has the HDCP (High Bandwidth Digital Copy Protection) coding feature installed, and supports multi-channel digital audio.

CONNECTIONS

Connecting a DVD Player

The rear panel jacks on your TV make it easy to connect a DVD player to your TV.

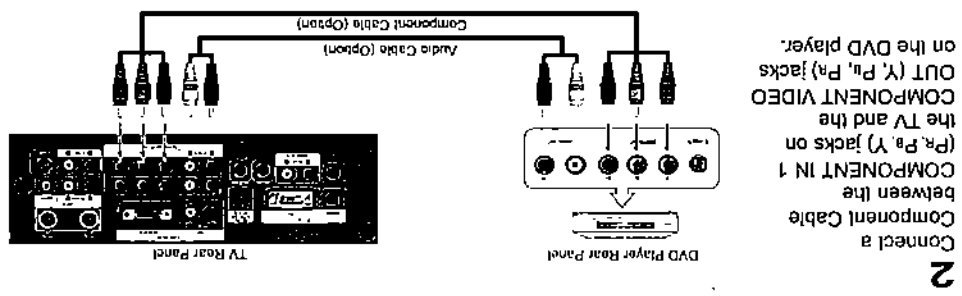
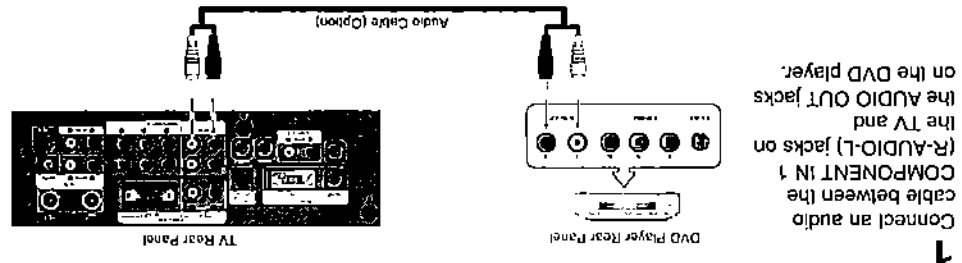

Note: For an explanation of Component video, see your DVD player owner's manual. Be sure to match the component video and audio connections. For example, if connecting the video cable to Component In 1, connect the audio cable to Component In 1 also.

Each external input source device has a different back panel configuration.

Connecting a Digital Audio System

The rear panel jacks on your TV make it easy to connect a Digital Audio System to your TV.

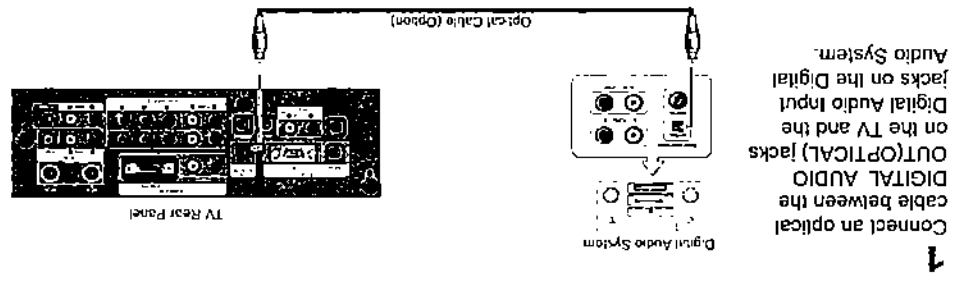

Note: 5.1CH broadcasting is possible when it is connected to an external device supporting 5.1CH. For an explanation of Component video, see your Digital Audio System owner's manual.

Each external input source device has a different back panel configuration.

CONNECTIONS

Connecting an Amplifier/DVD Home Theater

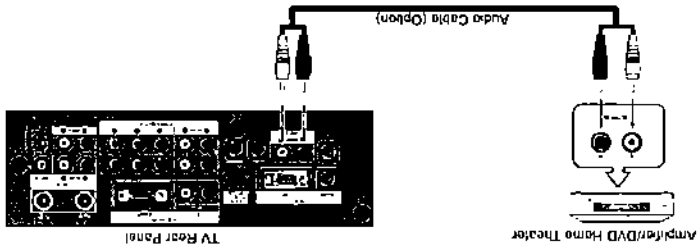

1
Connect an audio cable between the [R-AUDIO-L] on the TV and [R-AUDIO-L] on the Amplifier/DVD Home Theater.

Connecting a PC

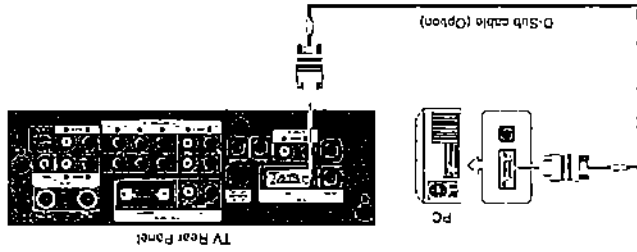

1
Connect the D-Sub cable to "PC (PC IN)" on the rear of your set.

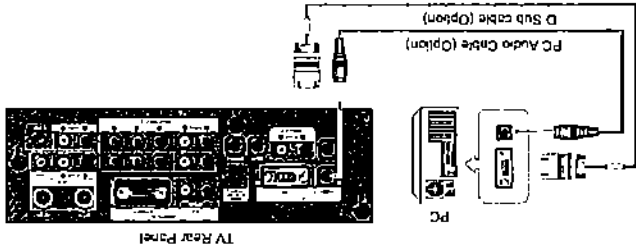

2
Connect the stereo Audio cable to "AUDIO (PC IN)" on the rear of your TFT-LCD and the other end to "Audio Out" of the sound card on your computer.

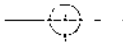

- Once the channel list has been updated, only the channels on the channel list can be selected.
- Remove the cable card by carefully pulling it out with your hands since dropping the cable card may cause damage to it.

Note

The Channel list can now be displayed by pressing CHLIST button.

4

When the channel information configuration has finished, the message "Updating Completed" is displayed, indicating that the channel list is now updated.

3

The pairing information containing a telephone number, CableCARD ID, Host ID, and other information will be displayed in about 2~3 minutes. If an error message is displayed, please contact your service provider.

2

Insert the CableCARD into the "CableCARD" slot and the message "CableCARD Inserted" is displayed on the screen. If the channel information does not exist, the message "Updating Channel List" is displayed during channel information configuration. It could take several minutes to update the channel information depending on your cable service provider.

1

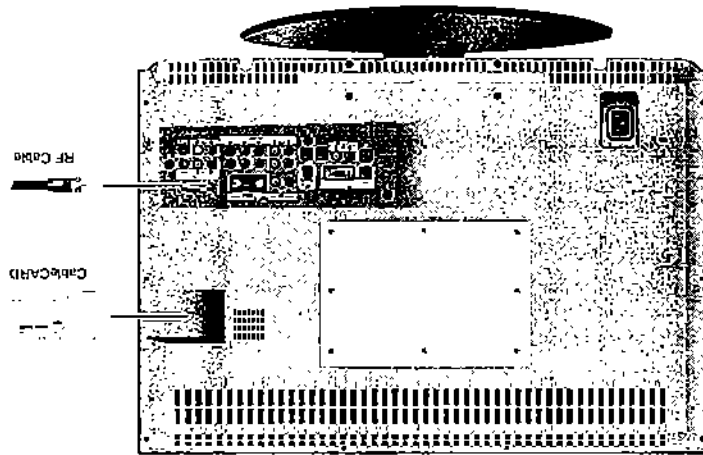

TV Rear Panel



You must obtain a CableCARD from a local cable service provider.

Connecting CableCARD (LN-R409D, LN-R469D)

CONNECTIONS







Turning the TV On and Off

Press the POWER  button on the remote. You can also use the POWER  button on the front of the panel.

Changing Channels

Using the Channel Buttons

1 Press the CH  /  buttons to change channels.

When you press the CH  /  buttons, the TV changes channels in sequence. You will see all the channels that the TV has memorized. (The TV must have memorized at least three channels). You will not see channels that were either erased or not memorized. See pages 21-24 to memorize channels.

Using the PRE-CH Button to select the Previous Channel

1 Press the PRE-CH button. The TV will switch to the last channel viewed.



To quickly switch between two channels that are far apart, tune to one channel, then use the number button to select the second channel. Then use the PRE-CH button to quickly alternate between them.

Adjusting the Volume

1 Press the VOL  +/- buttons to increase or decrease the volume.

Using Mute

At any time, you can cut off the sound using the MUTE button.

1 Press MUTE and the sound cuts off. The word "MUTE" will appear in the lower-left corner of the screen.

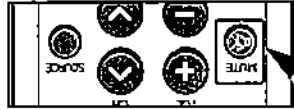

2 To turn mute off, press the MUTE button again, or simply press the VOL  +/- buttons.

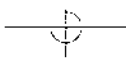

OPERATION

Viewing the Display

The display identifies the current channel and the status of certain audio-viden settings.

Press the INFO button on the remote control.

The TV will display the channel, the type of sound,

and the status of certain

picture and sound settings.

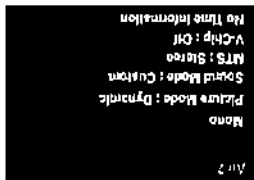

- ▶ The on-screen displays disappear after about ten seconds.
- ▶ Press the INFO button once more or wait approximately 10 seconds and it disappears automatically.
- ▶ Allows the user to adjust the settings according to his/her preference and shows the current settings.

Viewing the Menus

With the power on, press the MENU button.

The main menu appears on the screen. It's left

side has six icons: Input, Picture, Sound, Channel,

Setup, Guide.

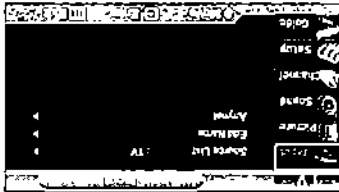

▶ The on-screen menus disappear from the screen after about two minutes.

1

Use the UP/DOWN▲▼ buttons to select one of the six icons. Then press the ENTER button to access the icon's sub-menu.

2

Press the EXIT button to exit.

3

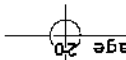

Plug & Play Feature

When the TV is initially powered on, two basic customer settings proceed automatically and subsequently: Setting Auto program, Clock.

1 Press the POWER button on the remote control.



The message "Menu language, Channels and Time will be set." is displayed. Press the ENTER button, then

"Select the language of the OSD" menu is automatically displayed.

2

Press the ENTER button to enter the language.

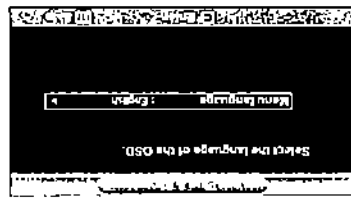

Press the UP/DOWN buttons to select language, then the ENTER button. "Select the antennas to memorize" menu is automatically displayed.

3

Press the UP/DOWN buttons to memorize the channels of the selected connection.
Press the ENTER button to select "Start".

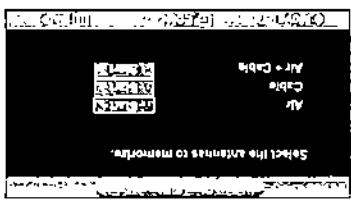

- ▶ If the antenna is connected to ANT1 (CABLE), select "CABLE" and if it is connected to ANT2 (AIR), select "AIR".
- If both ANT1 and ANT2 are connected, select the "Air + Cable".

The following models are applied.

4-1 (LN-R269D / LN-R329D)

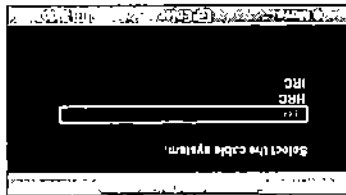

Press the UP/DOWN ▲▼ buttons to select "Cable" or "Alt+Cable" then press the ENTER [↵] button.
Press the UP/DOWN ▲▼ buttons to select "STD", "HRC" or "IRC", press the ENTER [↵] button.

4-2 (LN-R409D / LN-R469D)

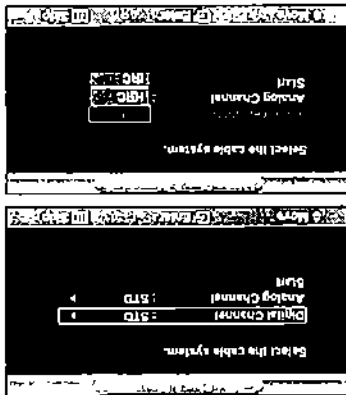

Press the UP/DOWN ▲▼ buttons to select "Digital Channel", then press the ENTER [↵] button.
Press the UP/DOWN ▲▼ buttons to select "STD", "HRC" or "IRC", press the ENTER [↵] button.

Press the UP/DOWN ▲▼ buttons to select "Analog Channel", then press the ENTER [↵] button.
Press the UP/DOWN ▲▼ buttons to select "STD", "HRC" or "IRC", press the ENTER [↵] button.

Press the UP/DOWN ▲▼ buttons to select "Start", then press the ENTER [↵] button to memorize the channels.

- ▶ identify various types of cable TV systems.
- Contact your local cable company to identify the type of cable system that exists in your particular area.
- At this point the signal source has been selected. Proceed to "Storing Channels in Memory".

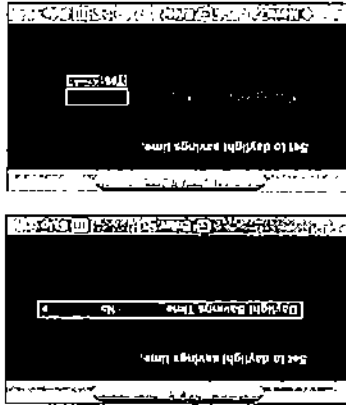

6 Press the ENTER button. Press the UP/DOWN buttons to select "Yes" or "No", then the ENTER button. Select your time zone in which you live menu is automatically displayed.

Note • To stop the search before it has finished, press the ENTER button with stop selected.

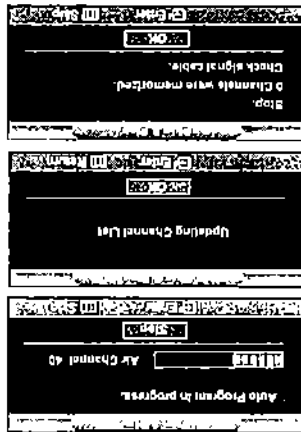

5 The TV will begin memorizing all of the available channels. After all the available channels are stored, the Auto program menu reappears. Press the ENTER button when channel memorization is complete. "Set to daylight savings time" menu is automatically displayed.

OPERATION

Note
• Plug and Play can only be accessed in the TV mode.

2
Press the UP/DOWN ▲▼ buttons to select "Plug & Play".
Press the ENTER button. For further details on selling up options, refer to the previous page.

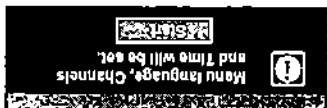

1
Press the MENU button. Press the UP/DOWN ▲▼ buttons to select "Setup", then press the ENTER button.

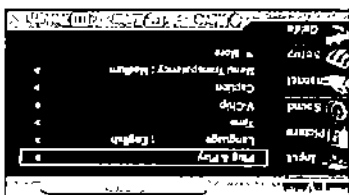

If you want to reset this feature...

8
The message "Completed. Time will be updated automatically" is displayed. When you have finished, press the ENTER button.

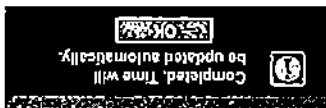

7
Press the UP/DOWN ▲▼ buttons to highlight the time zone for your local area (and to move the highlight to the appropriate time zone on the map of the United States).
Press the ENTER button. If you have received a digital signal, the time will be set automatically. If not, see page 74 to set the clock.



OPERATION

Memorizing the Channels

Your TV can memorize and store all of the available channels for both "off-air" (antenna) and cable channels. After the available channels are memorized, use the CH \wedge and CH \vee buttons to scan through the channels. This eliminates the need to change channels by entering the channel digits. There are three steps for memorizing channels: selecting a broadcast source, memorizing the channels (automatic) and adding and deleting channels (manual).

Selecting the Video Signal-source

Before your television can begin memorizing the available channels, you must specify the type of signal source that is connected to the TV (i.e. an antenna or a cable system).

1

Press the MENU \equiv button to display the menu.
Press the UP/DOWN \blacktriangle buttons to select "Channel".
Then press the ENTER \square button.

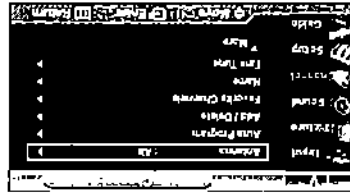

2

Press the ENTER \square button to select "Antenna".
Repeatedly press the UP/DOWN \blacktriangle buttons to cycle through these choices: "Air" or "Cable", then press the ENTER \square button to exit.

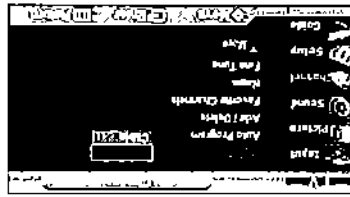

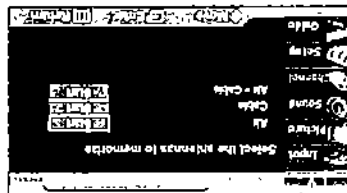
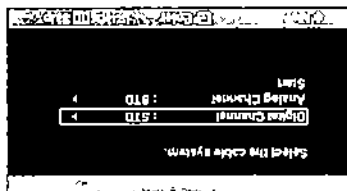

Press the UP/DOWN ▲▼ buttons to select the antenna connection, then press the ENTER ⏏ button. (See page 22)

3-2 (LN-R409D / LN-R469D)

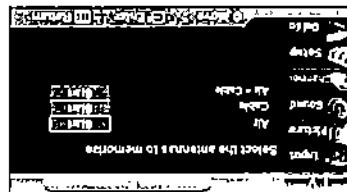
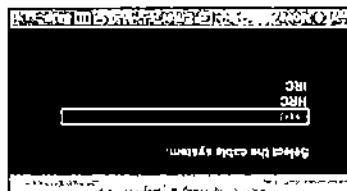

Press the UP/DOWN ▲▼ buttons to select the antenna connection, then press the ENTER ⏏ button. (See page 22)

3-1 (LN-R269D / LN-R329D)

- ▶ Air : "Air" antenna signal.
- Cable : "Cable" antenna signal.
- Air+Cable : "Air" and "Cable" antenna signals.

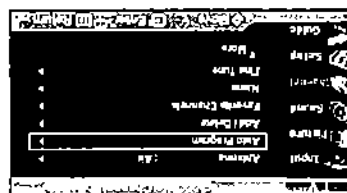

Press the UP/DOWN ▲▼ buttons to select "Auto Program", then press the ENTER ⏏ button.

2

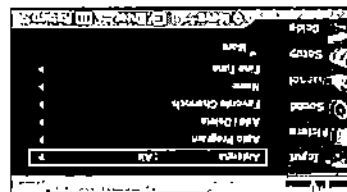

Press the UP/DOWN ▲▼ buttons to select "Channel", then press the ENTER ⏏ button.

1

Storing Channels in Memory (Automatic Method)

OPERATION

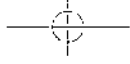

4
 After all the available channels are stored, the "Auto Program" menu reappears.
 Press the EXIT button to exit.

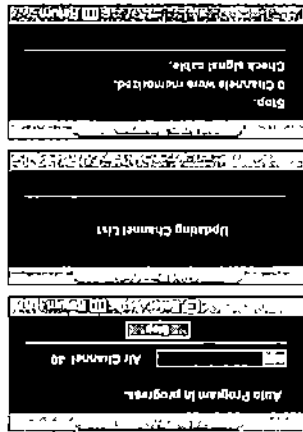

OPERATION



OPERATION

Adding and Erasing Channels (Manual Method)

1 Press the MENU button. buttons to select "Channel", then press the ENTER button.

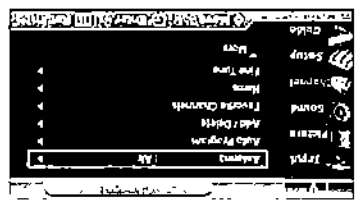

2 Press the UP/DOWN buttons to select "Add/Delete", then press the ENTER button.

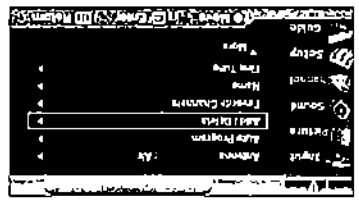

3 Repeatedly pressing the ENTER button will alternate between add channel and delete channel. Press the CH or CH buttons to switch to the appropriate channel, then repeat above. Press the EXIT button to exit.



OPERATION

Setting Up Your Remote Control

After it has been set up properly, your remote control can operate in five different modes: TV, VCR, Cable, DVD, or Set-Top Box. Pressing the corresponding button on the remote control allows you to switch between these modes, and control whichever piece of equipment you choose.

Note

The remote control might not be compatible with all DVD Players, VCRs, Cable boxes, and Set-Top Boxes.

Setting Up the Remote to Operate Your VCR

1 Turn off your VCR.

2 Press the MODE button and make sure that the VCR appears on the LCD screen.

3 Press the SET button on your TV's remote control.

4 Using the number buttons on your remote control, enter three digits of the VCR code listed on page 31 of this manual for your brand of VCR. Make sure you enter three digits of the code, even if the first digit is a "0".
(If more than one code is listed, try the first one.)

5 Press the POWER button on the remote control. Your VCR should turn on if your remote is set up correctly.

If your VCR does not turn on after set-up, repeat steps 2, 3 and 4, but try one of the other codes listed for your brand of VCR. If no other codes are listed, try each VCR code, 000 through 072.

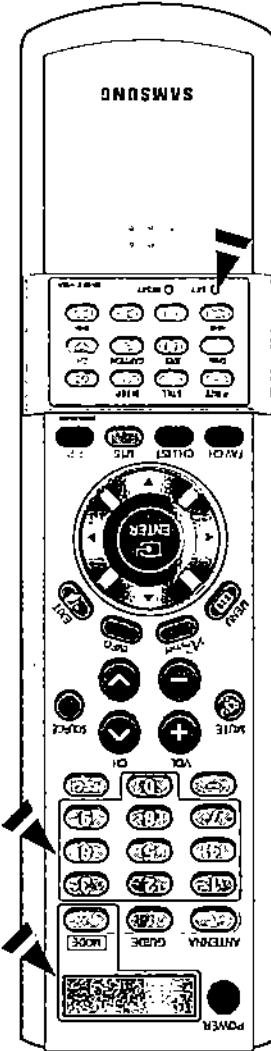

Note on Using Remote Control Modes: VCR
When your remote control is in "VCR" mode, the volume buttons still control your TV's volume.

OPERATION

Setting Up the Remote to Operate Your Cable Box

1 Turn off your cable box.

2 Press the MODE button and make sure that the CATV appears on the LCD screen.

3 Press the SET button on your TV's remote control.

4 Using the number buttons on your remote control, enter three digits of the cable box code listed on page 31 of this manual for your brand of cable box. Make sure you enter three digits of the code, even if the first digit is a "0".
If there is more than one code listed, try the first one.

5 Press the Power button on the remote control. Your cable box should turn on if your remote is set up correctly.

If your cable box does not turn on after set-up, repeat steps 2, 3 and 4, but try one of the other codes listed for your brand of cable box. If no other codes are listed, try each code, 000 through 045.

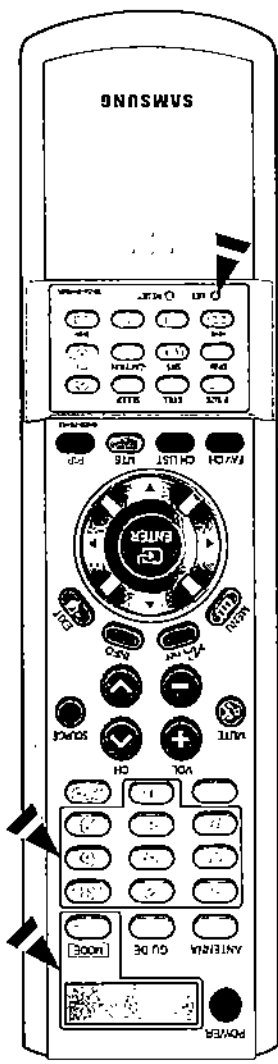

Note on Using Remote Control Modes: Cable Box
When your remote control is in "CATV" mode, the volume buttons still control your TV's volume.

OPERATION

Setting Up the Remote to Operate Your DVD

1 Turn off your DVD.

2 Press the MODE button and make sure that the DVD appears on the LCD screen.

3 Press the SET button on your TV's remote control.

4 Using the number buttons on your remote control, enter three digits of the DVD code listed on page 31 of this manual for your brand of DVD. Make sure you enter three digits of the code, even if the first digit is a "0".
If there is more than one code listed, try the first one.

5 Press the Power button on the remote control. Your DVD should turn on if your remote is set up correctly.

If your DVD does not turn on after set-up, repeat steps 2, 3 and 4, but try one of the other codes listed for your brand of DVD. If no other codes are listed, try each code, 000 through 009.

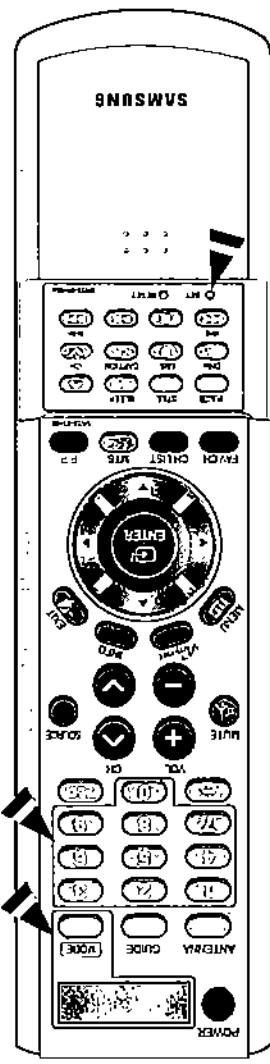

Note on Using Remote Control Modes: DVD
When your remote control is in "DVD" mode, the volume buttons still control your TV's volume.

OPERATION

Remote Control Codes

VCR

Brand	Code
Aiwa	025
Curtis Mathes	002 017 007 008 021 025 056 064 066
Funai	025
GE	017 002 021 005 056
Hitachi	019 025 041 042
JC Penny	002 007 018 019 021 026 037 041 054 056
Kenwood	007 008 018 026 037
Magnavox	021 036 056 059
Marantz	008 007 018 021 026 036 037 062
NEC	018 007 026 037 008 062 064
Panasonic	021 056 071 072
Philco	021 036 056 059
Philips	021 036
Pioneer	019 026 036 053
RCA	017 019 002 021 035 041 043 057 068
Samsung	000
Sanyo	018 024
Sears	018 019 006 024 028 029 041 048 051
Sharp	020 034 045 015
Sony	027 033 044
Sylvania	021 025 036 056 059
Toshiba	003 019 029 051 052

Cable Box

Brand	Code
Hitachi	025 030
Panasonic	003 022 027 037 044
Philips	019 021 023 028
Pioneer	018 020 004 044
RCA	014 022 040
Samsung	000
Zenith	017 029 035 037 045

DVD

Brand	Code
Curtis Mathes	009
JVC	002
LG	006
Samsung	000 001
Sony	007
Panasonic	005
ProScan, RCA	003

To Select the Source

Use to select TV or another external input source connected to the TV. Use to select the input source of your choice.

- 1 Press the MENU button to display the on-screen menu.
Press the ENTER button to select "Input".

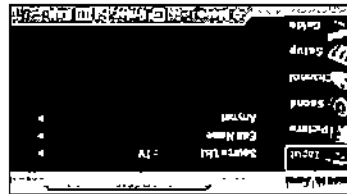

2-1 (LN-R269D)

- Press the ENTER button to select "Source List".
Press the UP/DOWN buttons to select signal source, then press the ENTER button.

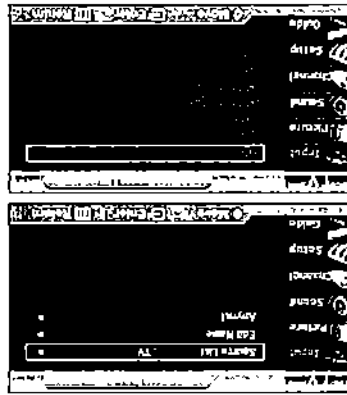

2-2 (LN-R329DLN-R409D / LN-R469D)

- Press the ENTER button to select "Source List".
Press the UP/DOWN buttons to select signal source, then press the ENTER button.

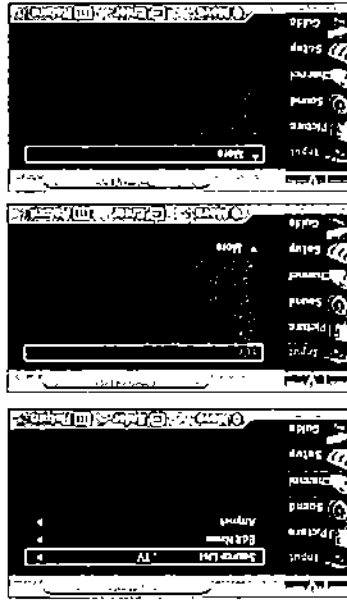

English-33

- ▶ (LN-R329D) When you connect equipment to the LCD, you can choose between the following sets of jacks: TV, AV1, AV2, S-Video, S-Video2, Component 1, Component 2, PC, or HDMI on the TV's rear panel.
HDMI input can only be selected when the external device is turned on and connected via HDMI.

- ▶ (LN-R329D/LN-R409DLN-R469D) When you connect equipment to the LCD, you can choose between the following sets of jacks: TV, AV1, AV2, S-Video, S-Video2, Component 1, Component 2, PC, or HDMI on the TV's rear panel.
HDMI input can only be selected when the external device is turned on and connected via HDMI.

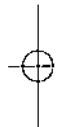
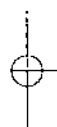

Alternate method:
 Press the **SOURCE** button on the remote control to view an external signal source.



Note
 You can choose only those external devices that are connected to the TV.

OPERATION

To Edit the Input Source Name

Name the device connected to the input jacks to make your input source selection easier. The following models are applied.

↓

Press the MENU button to display the on-screen menu.

Press the ENTER button to select "Input".

Press the UP/DOWN buttons to select "Edit Name", then press the ENTER button.

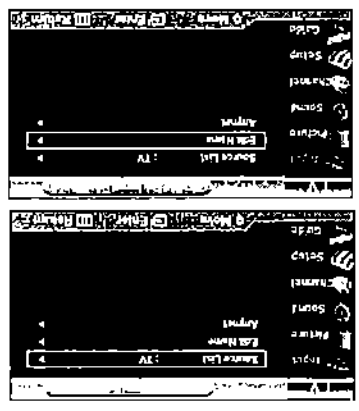

2-1 (LN-R269D)

Press the UP/DOWN buttons to select "AV", "S-Video", "Component1", "Component2", "PC", or "HDMI" input jack, then press the ENTER button.

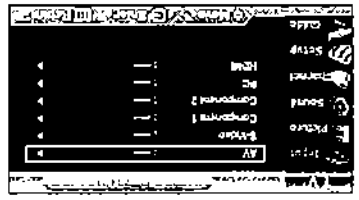

2-2 (LN-R329D / LN-R409D / LN-R469D)

Press the UP/DOWN buttons to select "AV1", "AV2", "S-Video1", "S-Video2", "Component1", "Component2", "PC", or "HDMI" input jack, then press the ENTER button.

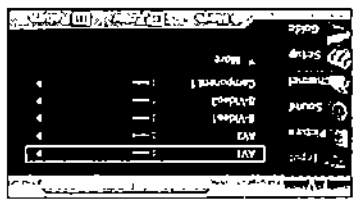

3-1 (LN-R269D)

Press the UP/DOWN ▲▼ buttons to select "VCR", "DVD", "D-VHS", "Cable STB", "HD STB", "Satellite STB", "PVR STB", "AV Receiver", "DVD Receiver", "GAME", "Camcorder", "DVD Combo", "PC", "VOD STB", or "TV" input source, then press the ENTER button. Press the EXIT button to exit.

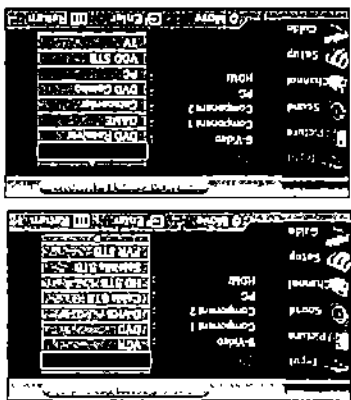

3-2 (LN-R329D / LN-R409D / LN-R469D)

Press the UP/DOWN ▲▼ buttons to select "VCR", "DVD", "D-VHS", "Cable STB", "HD STB", "Satellite STB", "PVR STB", "AV Receiver", "DVD Receiver", "GAME", "Camcorder", "DVD Combo", "PC", "VOD STB", or "TV" input source, then press the ENTER button. Press the EXIT button to exit.

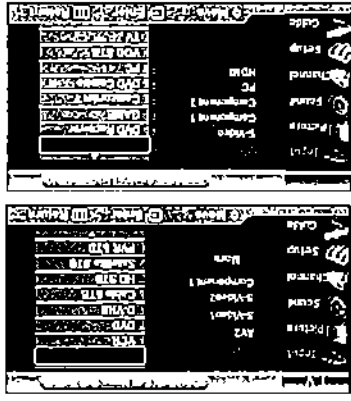



Chapter Four

PICTURE CONTROL



Using Automatic Picture Settings

Your TV has four automatic picture settings ("Dynamic", "Standard", "Movie", and "Custom") that are preset at the factory. You can activate either Dynamic, Standard, Movie, or Custom by making a selection from the menu.

Or, you can select "Custom" which automatically recalls your personalized picture settings.

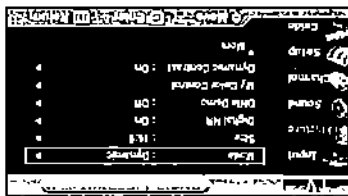
- 1 Press the MENU  button to display the menu.
- Press the UP/DOWN  buttons to select "Picture", then press the ENTER  button.



- 2 Press the ENTER  button.
- Press the ENTER  button.
- Press the UP/DOWN  buttons to select the "Dynamic", "Standard", "Movie", or "Custom" picture setting.

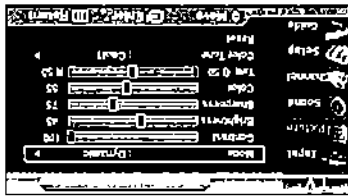

- 3 Press the ENTER  button.

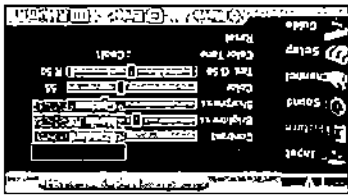

- Choose *Dynamic* to increase the clarity and sharpness of the picture.
- Choose *Standard* for the standard factory settings.
- Choose *Movie* when watching movies.
- Choose *Custom* if you want to adjust the settings according to personal preference.

Note

- Each adjusted value of Picture mode will be stored separately according to its input mode.

PICTURE CONTROL

3 Press the UP/DOWN ▲▼ buttons to select "Contrast", "Brightness", "Sharpness", "Color", or "Tint", then press the ENTER/OK button.

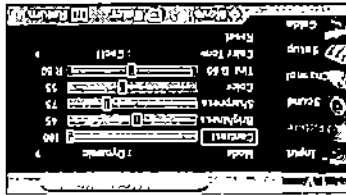

4 Press the LEFT/RIGHT ◀▶ buttons to decrease or increase the value of a particular item. For example, if you select "Contrast", pressing the RIGHT ▶ button increases it. Press the ENTER/OK button. Press the EXIT button to exit.



- In the Component(480p, 720p, 1080i), DVI, HDMI mode, you can't adjust the Tint.
- Each adjusted setting will be stored separately according to its input mode.
- When you make changes to Contrast, Brightness, Color, Tint, OSD color will also be adjusted accordingly.

▶ The Tint can be adjusted in any mode other than PC mode.

PICTURE CONTROL

Adjusting the Color Tone

You can change the color of the entire screen according to your preference.

1 Press the MENU button to display the menu. Press the UP/DOWN buttons to select "Picture", then press the ENTER button.

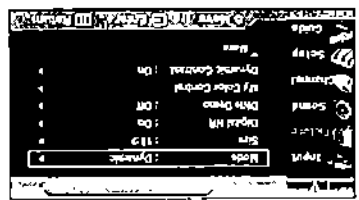

2 Press the ENTER button.

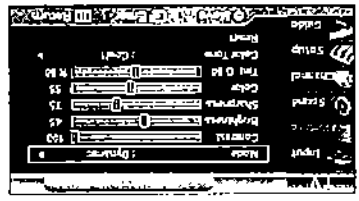

3 Press the UP/DOWN buttons to select "Color Tone", then press the ENTER button.

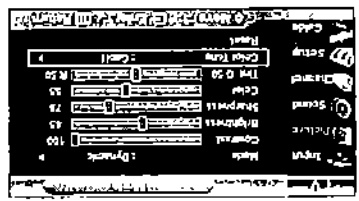

4 Press the UP/DOWN buttons to select "Cool1", "Normal", "Warm1", or "Warm2". Press the ENTER button. Press the EXIT button to exit.

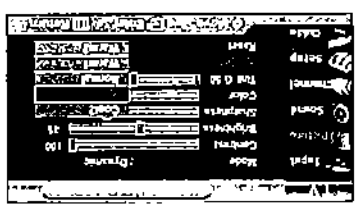

Choose from the following Color Tone settings: "Cool 2", "Cool 1", "Normal", "Warm 1", "Warm 2" according to personal preference.

Press the ENTER button again to select "Mode". Press the UP/DOWN buttons to select "Reset", then press the ENTER button.

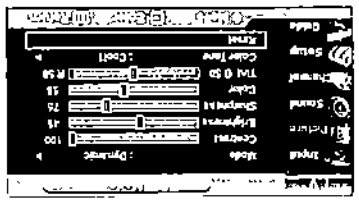

Resetting the Picture Settings to the Factory Defaults

PICTURE CONTROL

DNIe (Digital Natural Image engine)

Samsung's new technology brings you more detailed images with contrast, white enhancement and 3D noise reduction.

You can see how DNIe improves the picture by setting DNIe demo mode to On.

1 Press the MENU button to display the menu.
Press the UP/DOWN buttons to select "Picture", then press the ENTER button.

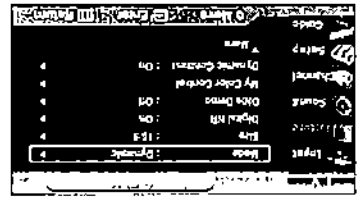

2 Press the UP/DOWN buttons to select "DNIe Demo", then press the ENTER button.

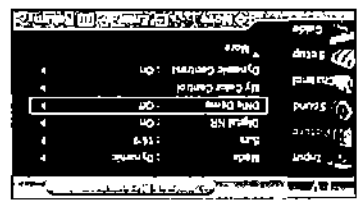

3 Press the UP/DOWN buttons to select "Off" or "On", then press the ENTER button.
Press the EXIT button to exit.

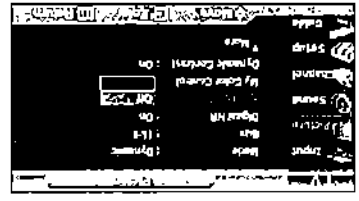

Alternate method :

Press the DNIe button under the remote's cover to change the DNIe Demo mode.

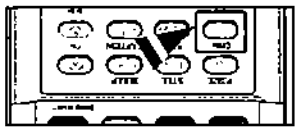

▶ This function doesn't work when Source is in PC mode.

- DNIe Demo: Off
- DNIe Demo mode is deactivated.
- DNIe Demo: On
- The right-hand side of the screen shows the improved DNIe image. The left-hand side of the screen shows the original image.
- The "DNIe Demo" is designed to show the difference between the regular and DNIe pictures.
- By default, the product displays the picture with DNIe applied.

PICTURE CONTROL

Changing the Screen Size

Screen size selection depends on the type of video input.

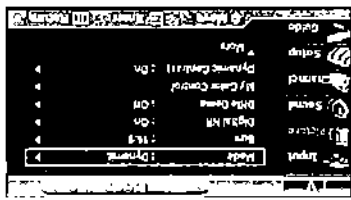

1 Press the MENU button to display the menu. Press the UP/DOWN buttons to select "Picture", then press the ENTER button.

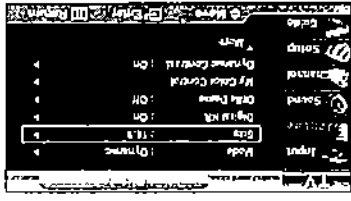

2 Press the UP/DOWN buttons to select "Size", then press the ENTER button.

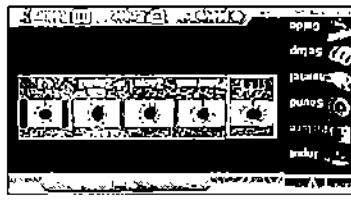

3 Press the LEFT/RIGHT buttons to select the screen format you want. Press the ENTER button. Press the EXIT button to exit.

- 16:9 : Sets the picture to 16:9 wide mode.
- Panorama : Use this mode for the wide aspect ratio of a panoramic picture.
- Zoom1 : Magnifies the size of the picture on the screen.
- Zoom2 : Expands the Zoom1 format picture.
- 4:3 : Sets the picture to 4:3 normal mode.

PICTURE CONTROL

When you press the **SIZE** button under the cover of the remote control, the TV's screen mode should appear in sequence. The screen displays in this order: 16:9, Panorama, Zoom1, Zoom2, 4:3.

Note

- If you watch a still image or the 4:3 mode for a long time (over 2 hours), an image may be burned onto the screen. View the TV in 16:9 or Panorama mode as much as possible.
- HD (High Definition)
16:9 - 1080i (1920x1080)
720P (1280x720)



16:9

Sets the picture to 16:9 wide mode.

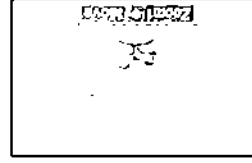

Zoom1

The screen size when Wide screen is vertically enlarged.

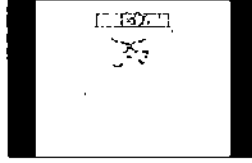

4:3

Sets the picture to 4:3 normal mode.



Panorama

Converts regular 4:3 aspect ratio screen to wide screen.



Zoom2

The screen size when the Zoom1 screen is vertically enlarged.

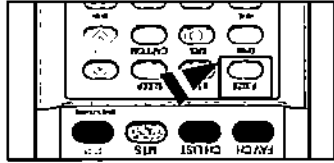

- Note**
- In TV, VIDEO, S-VIDEO, and all COMPONENT modes, all screen modes can be selected.
 - In TV(DTV), DVI, PC, HDMI modes, only 16:9 & 4:3 modes can be selected.
 - In Zoom1, Zoom2 modes, you can move the picture on screen by pressing the UP/DOWN ▲▼ buttons. (All screen modes)
 - Picture size will not change when PIP size is Double.

↓
- Press the STILL button to freeze a moving picture.
- Normal sound will still be heard.
- Press again to cancel.

Freezing the Picture

PICTURE CONTROL

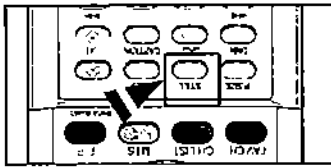

PICTURE CONTROL

Viewing Picture-in-Picture

This product has one built-in tuner, which does not allow PIP to function in the same mode. For example, you cannot watch one TV channel in the main screen, and a different one in the PIP screen. Please see 'PIP Settings' below for details.

You can use the PIP feature to simultaneously watch two video sources.

Note: While V-Chip is in operation, the PIP function cannot be used.

Activating Picture-in-Picture

- 1 Press the MENU button to display the menu.
- Press the UP/DOWN buttons to select "Picture", then press the ENTER button.
- Press the UP/DOWN buttons to select "PIP", then press the ENTER button.

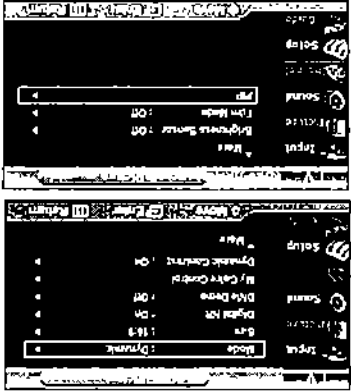

- 2 Press the ENTER button.
- Press the UP/DOWN buttons to select "On", then press the ENTER button.

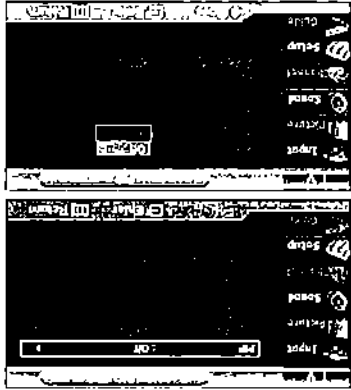

Alternate method : Press the PIP button on the remote control repeatedly to activate or deactivate the PIP.



▶ If you turn the TV off while watching in PIP mode and turn it on again, the PIP window will disappear.

PICTURE CONTROL

PIP Settings

	Main Picture	Sub Picture	DTV	ATV	AV	S-Video	COM1	COM2	PC	HDMI
DTV	X	X	X	X	X	X	X	X	X	X
ATV	X	X	X	X	X	X	X	X	X	X
AV	X	X	X	X	X	X	X	X	X	X
S-Video	X	X	X	X	X	X	X	X	X	X
COM1	X	X	X	X	X	X	X	X	X	X
COM2	X	X	X	X	X	X	X	X	X	X
PC	X	X	X	X	X	X	X	X	X	X
HDMI	X	X	X	X	X	X	X	X	X	X

O: PIP operates
X: PIP doesn't operate

Note

- ATV : Analog TV
- DTV : Digital TV
- COM1 : Component 1
- COM2 : Component 2

Selecting a Signal Source (External AV) for PIP

The following models are applied.

3-1 (LN-R269D)

Press the UP/DOWN ▲▼ buttons to select "Source", then press the ENTER button. Select the source of the sub picture (PIP) by pressing the UP/DOWN ▲▼ buttons and press the ENTER button.

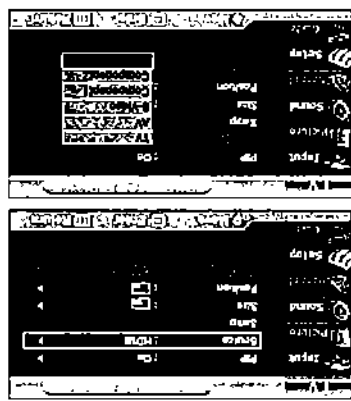

- MAIN : TV(ATV)
- PIP : HDMI

• The sub picture can select different source selections based on what the main picture is set to.

▶ In the PIP Source selection menu, "TV" represents both analog and digital tunings.

3-2 (LN-R329D / LN-R409D / LN-R469D)

Press the UP/DOWN ▲▼ buttons to select "Source", then press the ENTER button. Select the source of the sub picture (PIP) by pressing the UP/DOWN ▲▼ buttons and press the ENTER button.

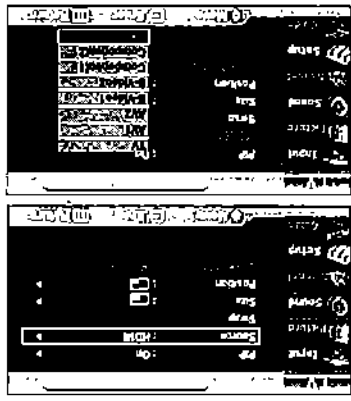

PICTURE CONTROL

Swapping the Contents of the PIP and Main Image

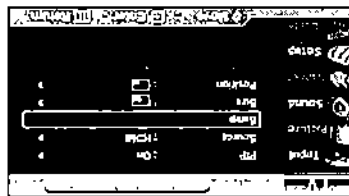

4 Press the UP/DOWN ▲▼ buttons to select "Swap", then press the ENTER button.

Changing the PIP Channel

5 Press the UP/DOWN ▲▼ buttons to select "PIP Channel", then press the ENTER button.

Press the UP/DOWN ▲▼ buttons to select the desired channel in the PIP window.

Press the ENTER button.

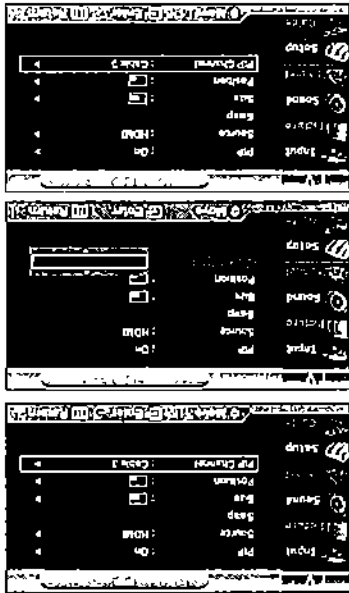

Alternate method :

Press the PIP Channel buttons under the remote's cover.



- ▶ MAIN : AV, S-Video, COM1, COM2
- PIP : TV(DTV)
- MAIN : PC, HDMI
- PIP : TV(ATV)
- The channel can be active when the sub picture is set to TV.

PICTURE CONTROL

Changing the Position of the PIP Window



6 Press the UP/DOWN ▲▼ buttons to select "Position", then press the ENTER button. Press the UP/DOWN ▲▼ buttons to select the desired PIP window position.

Press the ENTER button.

• The Double (□) mode cannot be selected in position.

Changing the Size of the PIP Window

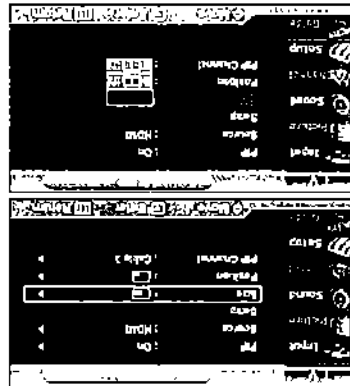

7 Press the UP/DOWN ▲▼ buttons to select "Size", then press the ENTER button. Press the UP/DOWN ▲▼ buttons to select the desired size of the PIP window.

Press the ENTER button. Press the EXIT button to exit.

- When the PC is in energy saving mode, you cannot choose the PIP option.
- You may notice that the picture in the PIP window becomes slightly unnatural when you use the main screen to view a game or karaoke.
- You can adjust picture position only by using the □ size menu.

PICTURE CONTROL

My Color Control

My Color Control allows users to adjust colors to their preference by adjusting Pink, Blue and Green using the predefined settings (Red, Green, Blue, Yellow, Pink, White, Standard, and Custom) without affecting other colors on the screen.

Easy Control

▶ You can also directly access "My Color Control" by pressing and holding the ENTER button for three seconds with no menu on the screen.

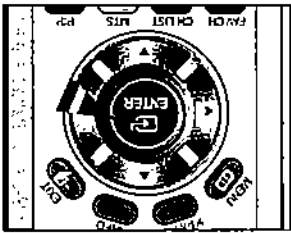

▶ This function doesn't work when Source is in PC mode or PIP is set to on.

▶ This captures the current screen in a still image to adjust the color.

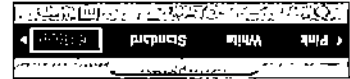
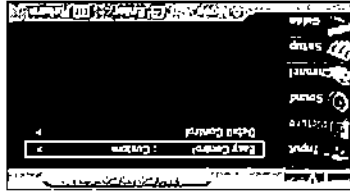
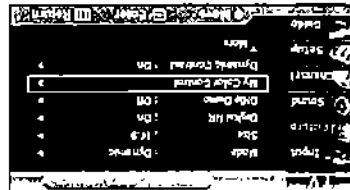
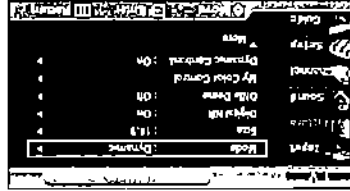

1 Press the MENU button to display the menu.
Press the UP/DOWN buttons to select "Picture", then press the ENTER button.
Press the UP/DOWN buttons to select "My Color Control", then press the ENTER button.

2 Press the UP/DOWN buttons to select "Easy Control", then press the ENTER button.

3 Press the LEFT/RIGHT buttons to select the desired My Color Control color, then press the ENTER button. The Original picture (before adjustment) is shown on the left side, while the selected mode is shown on the right side.

The sources are displayed in the following order:
Red-Green-Blue-Yellow-Pink-White-Standard-Custom

PICTURE CONTROL

Detail Control

1 Press the MENU button to display the menu.

Press the UP/DOWN buttons to select "Picture", then press the ENTER button.

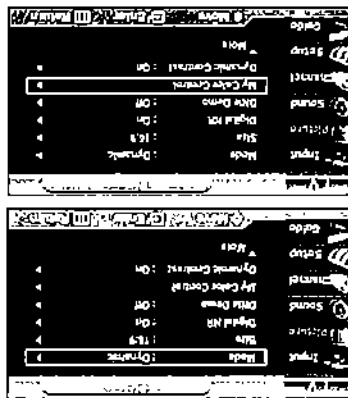

Press the UP/DOWN buttons to select "My Color Control", then press the ENTER button.

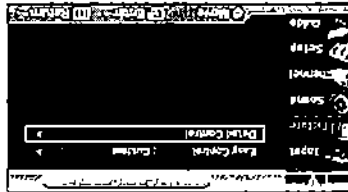

2 Press the UP/DOWN buttons to select "Detail Control", then press the ENTER button.



3 Press the UP/DOWN buttons to select the desired My Color Control color and press the ENTER button. (To reset the "Detail Control" select "Reset" by pressing the UP/DOWN buttons and then press the ENTER button.)

Press the LEFT/RIGHT buttons to increase or decrease the value of a particular item.

Press the ENTER button to exit.

The sources are displayed in the following order:
Red-Green-Blue-Yellow-Pink-White-Reset

▶ You can adjust Red, Green, Blue, Yellow, Pink and White without using the predefined settings in custom mode.

▶ This function doesn't work when the Source is in PC mode, or PIP is set to on.

Dynamic Contrast

Dynamic Contrast detects the visual signal input and adjusts to create optimum contrast.

PICTURE CONTROL

1 Press the MENU button to display the menu. Press the UP/DOWN buttons to select "Picture". Press the ENTER button then press the ENTER button.

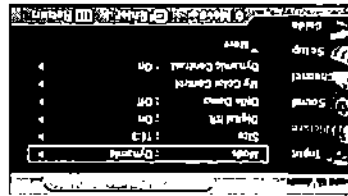

2 Press the UP/DOWN buttons to select "Dynamic Contrast", then press the ENTER button.

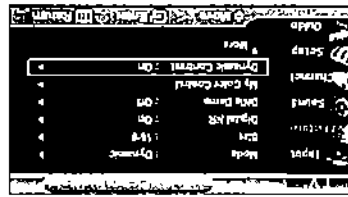

3 Press the UP/DOWN buttons to select "On", then press the ENTER button. Press the EXIT button to exit.

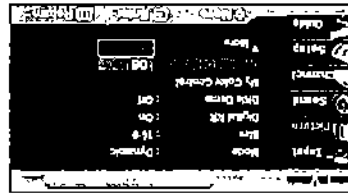

▶ This function doesn't work when the Source is in PC mode, or PIP is set to on.

PICTURE CONTROL

The Brightness Sensor adjusts the screen brightness automatically by using a light detecting sensor.

Brightness Sensor

- ▶ Press the MENU button to display the menu.
 - ▶ Press the UP/DOWN buttons to select "Picture", then press the ENTER button.
 - ▶ Press the UP/DOWN buttons to select "Brightness Sensor", then press the ENTER button.
 - ▶ Press the LEFT/RIGHT buttons to select "On", then press the ENTER button to exit.
 - ▶ Press the EXIT button to exit.
- You can also directly access "Brightness Sensor" by pressing and holding the EXIT button for three seconds with no Menu on the screen.

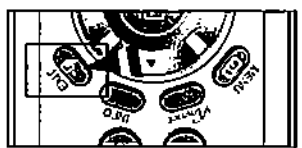
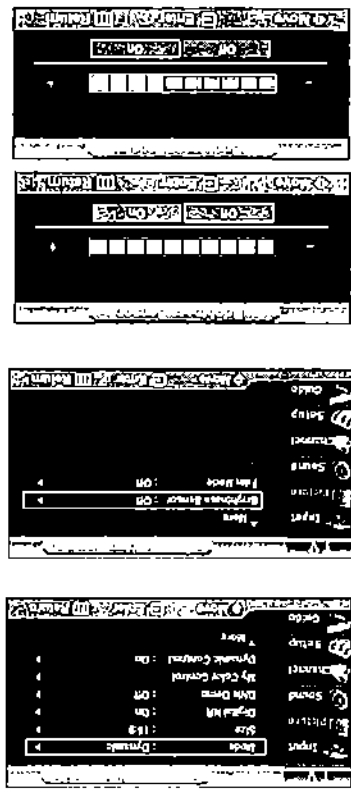

Chapter Five

SOUND CONTROL

Customizing the Sound

The sound settings can be adjusted to suit your personal preference. (Alternatively, you can use one of the "automatic" settings. See next page.)

1 Press the MENU button to display the menu. Press the UP/DOWN buttons to select "Sound", then press the ENTER button.

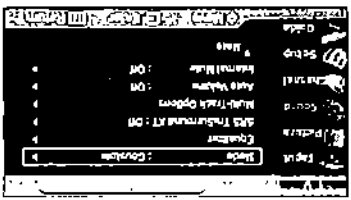

2 Press the UP/DOWN buttons to select "Equalizer", then press the ENTER button.

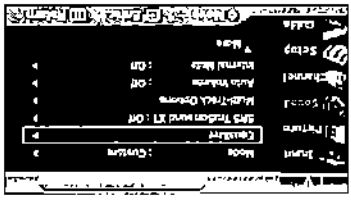

3 Press the LEFT/RIGHT buttons to select a particular frequency to adjust. Press the UP/DOWN buttons to increase or decrease the level of the particular frequency. Press the ENTER button to exit.

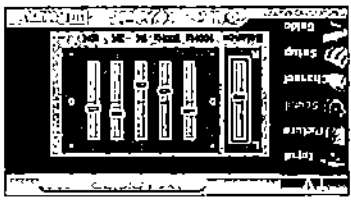

SOUND CONTROL

Using Automatic Sound Settings

Your TV has automatic sound settings ("Standard", "Music", "Movie", "Speech", and "Custom") that are preset at the factory. Or, you can select "Custom," which automatically recalls your personalized sound settings.

- 1 Press the MENU button to display the menu.
- 2 Press the UP/DOWN buttons to select "Sound", then press the ENTER button.

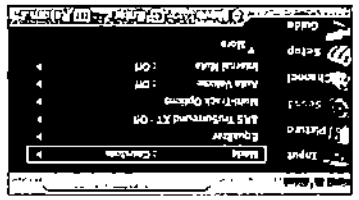

- 2 Press the ENTER button to select "Mode".

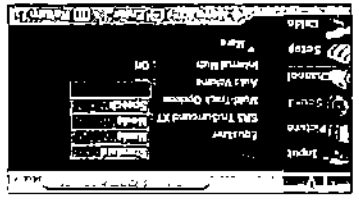

Press the UP/DOWN buttons to select "Standard", "Music", "Movie", "Speech", or "Custom" sound setting, then press the ENTER button.

Press the EXIT button to exit.

- Choose *Standard* for the standard factory settings.
- Choose *Music* when watching music videos or concerts.
- Choose *Movie* when watching movies.
- Choose *Speech* when watching a show that is mostly dialog (i.e., news).
- Choose *Custom* to recall your personalized settings (see "Customizing the Sound", page 50).

SOUND CONTROL

Setting the Trusurround XT

Trusurround XT is a patented SRS technology that solves the problem of playing 5.1 multichannel content over two speakers. Trusurround delivers a compelling, virtual surround sound experience through any two-speaker playback system, including internal television speakers. It is fully compatible with all multichannel formats.

1 Press the MENU button to display the menu.

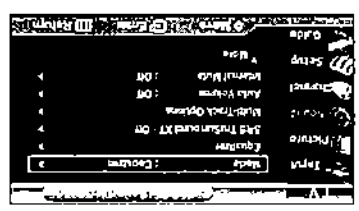

2 Press the UP/DOWN buttons to select 'SRS Trusurround XT', then press the ENTER button.

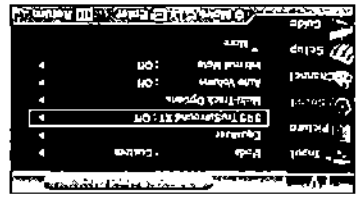

3 Press the UP/DOWN buttons to select 'Off', '3D Mono', 'Stereo', then press the ENTER button. Press the EXIT button to exit.

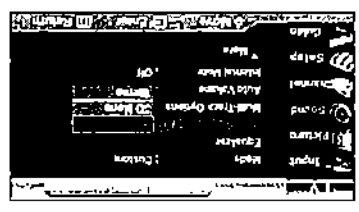

TRADEMARK & LABEL LICENSE NOTICE

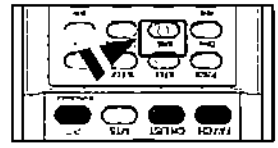

SRS and Trusurround XT are trademarks of SRS Labs, Inc. Trusurround XT technology is incorporated under license from SRS Labs, Inc.



SOUND CONTROL

Choosing a Multi-Channel Sound (MTS) track - Digital

The digital-TV transmission system is capable of simultaneous transmission of many audio tracks (for example, simultaneous translations of the program into foreign languages). The availability of these additional "multitracks" depends upon the program.

Preferred Language

- 1 Press the MENU button to display the menu.
- Press the UP/DOWN buttons to select "Sound", then press the ENTER button.
- Press the MENU button to display the menu.
- Press the UP/DOWN buttons to select "Sound", then press the ENTER button.
- Press the UP/DOWN buttons to select "Multi-Track Options", then press the ENTER button.
- Press the UP/DOWN buttons to select "Preferred Language - English", then press the ENTER button.

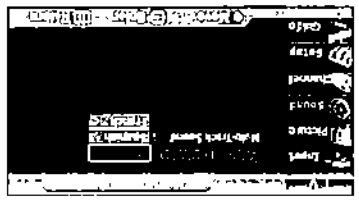
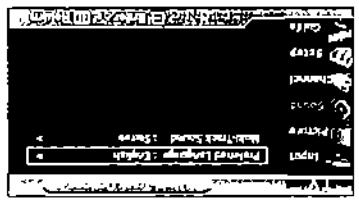
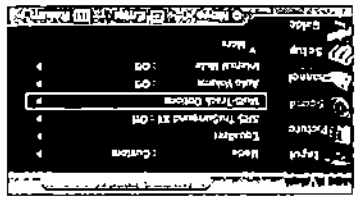
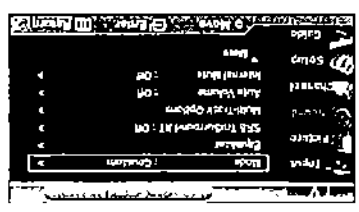

3 Press the ENTER button to select "Preferred Language". Press the UP/DOWN buttons to choose the language you want, then press the ENTER button.

Press the EXIT button to exit.

▶ Quick way to access the MTS menu: Just press the "MTS" button on the remote control. You can listen in a language other than your chosen language by pressing the MTS button.

SOUND CONTROL

Multi-Track Sound

1 Press the MENU button to display the menu. Press the UP/DOWN buttons to select "Sound", then press the ENTER button.

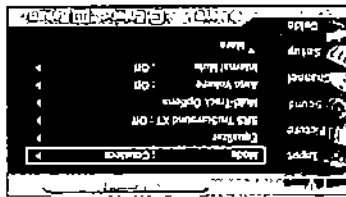

2 Press the UP/DOWN buttons to select "Multi-Track Options", then press the ENTER button.

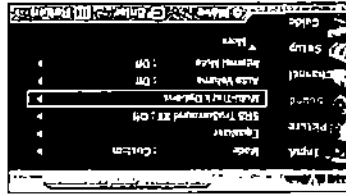

3 Press the UP/DOWN buttons to select "Multi-Track Sound", then press the ENTER button. Press the UP/DOWN buttons to select a setting you want, then press the ENTER button. Press the EXIT button to exit.



- Choose *Mono* for channels that are broadcasting in mono, or if you are having difficulty receiving a stereo signal.
- Choose *Stereo* for channels that are broadcasting in stereo.
- Choose *SAT* to listen to the Separate Audio Program, which is usually a foreign-language translation.



SOUND CONTROL

Automatic volume control

Reduces the differences in volume level among broadcasters.

1 Press the MENU button to display the menu.
 Press the UP/DOWN buttons to select "Sound", then press the ENTER button.

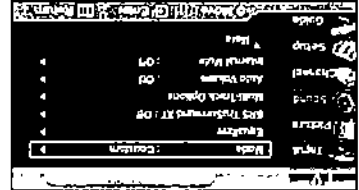

2 Press the UP/DOWN buttons to select "Auto Volume", then press the ENTER button.

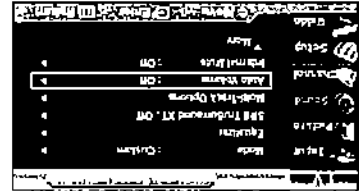

3 Press the UP/DOWN buttons to set Auto Volume "On" then press the ENTER button.
 Press the EXIT button to exit.

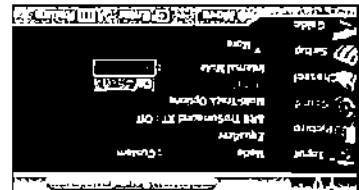

Selecting the Internal Mute

Sound output from the TV speakers is muted.

SOUND CONTROL

1 Press the MENU button to display the menu. Press the UP/DOWN buttons to select "Sound", then press the ENTER button.

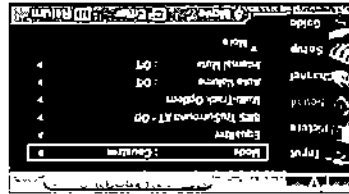

2 Press the UP/DOWN buttons to select "Internal Mute", then press the ENTER button. Press the UP/DOWN buttons to select "On", then press the ENTER button.

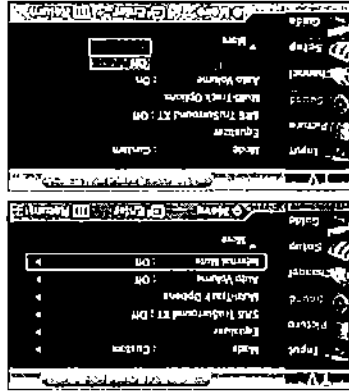

Press the EXIT button to exit.

SOUND CONTROL

Choosing a Digital Sound Format

Digital sound can be output from the rear panel connector on your TV. The digital sound output is a connector labeled "Optical". After connecting a digital-audio component, you must specify the transmission format (Dolby or PCM, as appropriate to your digital audio component).

1 Press the MENU button to display the menu.
 Press the UP/DOWN buttons to select "Sound", then press the ENTER button.

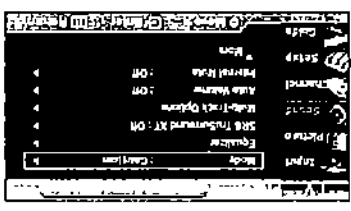

2 Press the UP/DOWN buttons to select "Digital Output", then press the ENTER button.
 Press the UP/DOWN buttons to select "Dolby Digital" or "PCM", then press the ENTER button to exit.

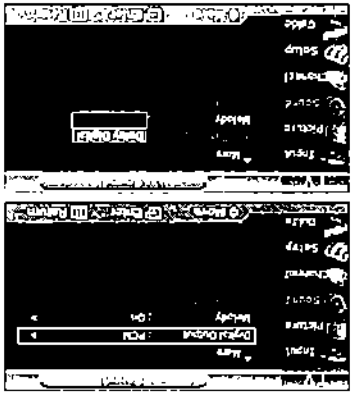

• PCM (Pulse Coded Modulation) is for use with 2 channel Amplifiers that do not support Dolby digital.

DOLBY DIGITAL

Manufactured under license from Dolby Laboratories.
 "Dolby" and the double-D symbol are trademarks of Dolby Laboratories.



Setting the On/Off Melody

A melody sound can be set to come on when the TV is powered On or Off.

SOUND CONTROL



1 Press the MENU button to display the menu. Press the UP/DOWN buttons to select "Sound", then press the ENTER button.

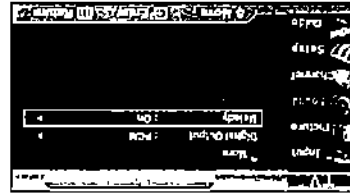

2 Press the UP/DOWN buttons to select "Melody", then press the ENTER button. Press the UP/DOWN buttons to select "On" or "Off", then press the ENTER button.

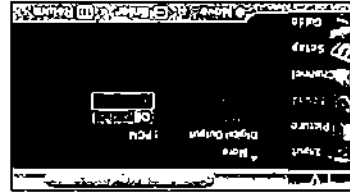

Press the EXIT button to exit.



Chapter Six

CHANNEL CONTROL

Selecting the antenna

1

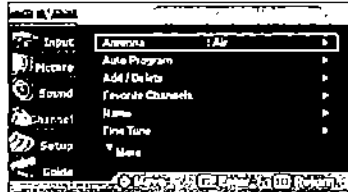

Press the MENU  button to display the menu.

Press the UP/DOWN  buttons to select "Channel", then press the ENTER  button.



2

Press the ENTER  button to select "Antenna".

Press the UP/DOWN  buttons to select "Air" or "Cable", then press the ENTER  button.

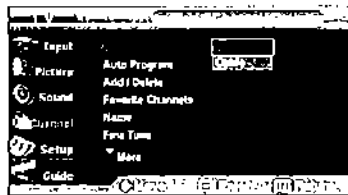

Press the EXIT button to exit.

Note

- If the antenna is connected to ANT 1 (CABLE), select "CABLE" and if it is connected to ANT2 (AIR), select "AIR".

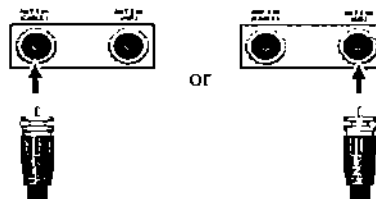

- If both ANT 1 and ANT 2 are connected, select the antenna input you want. If the antenna input is not selected properly, noise may appear on the screen.

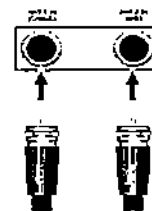

CHANNEL CONTROL

To Set-up Your Favorite Channels

1
Press the **MENU** button to display the menu.

Press the **UP/DOWN** buttons to select "Channel", then press the **ENTER** button.

Press the **UP/DOWN** buttons to select "Favorite Channels", then press the **ENTER** button.

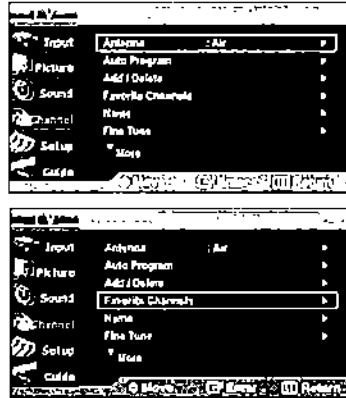

2
Press the **UP/DOWN** buttons to select your favorite channels to watch among the labeled channels.

Press the **UP/DOWN** buttons to select a channel as a favorite channel, then press the **ENTER** button.

Press the **ENTER** button again to deselect the selected channel.

Press the **EXIT** button to exit.

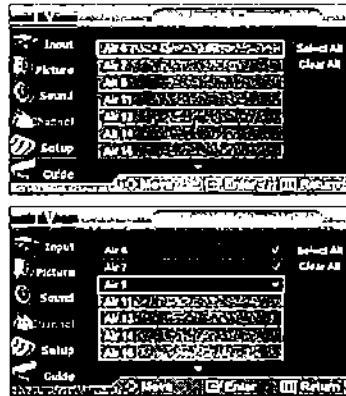

◀ Only memorized channels can be set as favorite channels.

◀ **Select All** : Press to select all channels.
Clear All : Press to clear all channels.

3
To select the favorite channels you have set-up, press the **FAV.CH** button on the remote.







CHANNEL CONTROL

Labeling Channels

1



Press the **MENU**  button to display the menu.

Press the **UP/DOWN**  buttons to select "Channel", then press the **ENTER**  button.

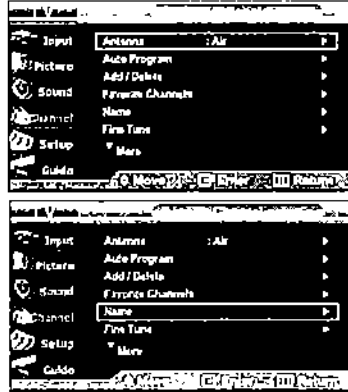

Press the **UP/DOWN**  buttons to select "Name", then press the **ENTER**  button.



2

Press the **UP/DOWN**  buttons to select the channel to be assigned to a new name, then press the **ENTER**  button.

Press the **UP/DOWN**  buttons to select a letter, a number or a blank (Results in this sequence: A...Z, 0...9, +, -, *, /, blank). Press the **▶** button to switch to the next field, which will be selected.

Select a second letter or digit by pressing the **UP/DOWN**  buttons, as above. Repeat the process to select the last two digits. When you have finished, press the **ENTER**  button to assign the new name.

Press the **EXIT** button to exit.

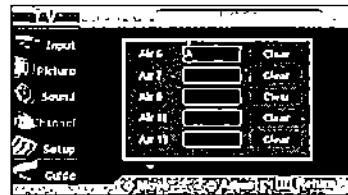

- The names of digital broadcasting channels are automatically assigned and thus cannot be assigned by users.
- When you use cable card to watch cable broadcasting, it might take some time for a channel name to be displayed due to data-receiving time.

CHANNEL CONTROL

Viewing the Channel Lists

You can display a list of all channels or your favorite channels.

1

Press the **MENU** button to display the menu.

Press the **UP/DOWN** buttons to select "Channel", then press the **ENTER** button.

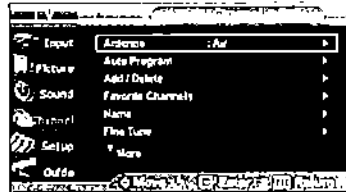

2

Press the **UP/DOWN** buttons to select "Channel List", then press the **ENTER** button.

Press the **UP/DOWN** buttons to select "All" or "Favorite", then press the **ENTER** button.

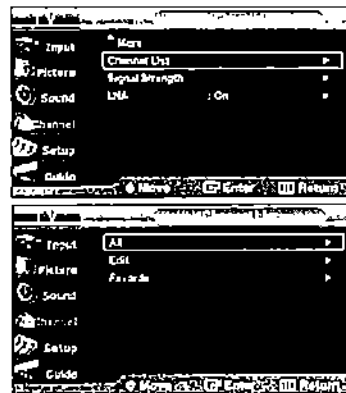

3

Press the **UP/DOWN** buttons to select "Channel" and **ENTER** button.

To toggle between your favorite channels or all channels, use the yellow button on the remote control.

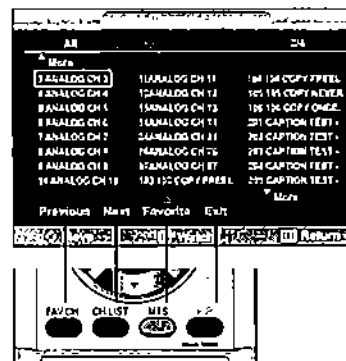

- Red button : Press to display the previous channel list page.
- Green button : Press to display the next channel list page.
- Yellow button : Press to toggle between your favorite channels or all channels.
- Blue or EXIT button : Press to exit.

CHANNEL CONTROL

Editing the Channel Lists

You can edit channels to be added or deleted.

1

Press the **MENU** button to display the menu.

Press the **UP/DOWN** buttons to select "Channel", then press the **ENTER** button.

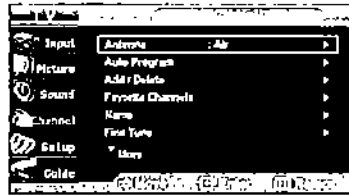

2

Press the **UP/DOWN** buttons to select "Channel List", then press the **ENTER** button.

Press the **UP/DOWN** buttons to select "Edit", then press the **ENTER** button.

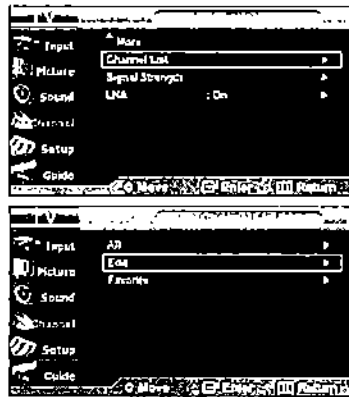

3

Press the **UP/DOWN** buttons to select "Channel" and **ENTER** button.

Then, the channel can be deleted or added. If deleted, the channel number will be dimmed.

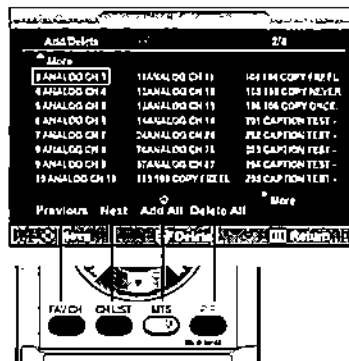

- Enter button : Press to add or delete the channel.
- Red button : Press to display the previous channel list page.
- Green button : Press to display the next channel list page.
- Yellow button : Press to add all channels deleted.
- Blue button : Press to delete all channels memorized.
- EXIT button : Press to exit.



CHANNEL CONTROL

Fine Tuning Analog Channels

Use fine tuning to manually adjust a particular channel for optimal reception.



1

Press the MENU  button to display the menu.

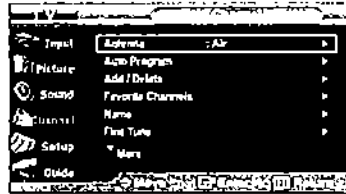
Press the UP/DOWN  buttons to select "Channel", then press the ENTER  button.



2

Press the UP/DOWN  buttons to select "Fine Tune", then press the ENTER  button.

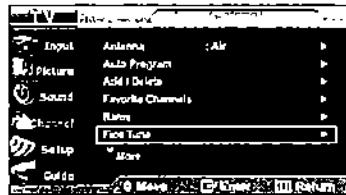



3

Press the LEFT/RIGHT  buttons to adjust the fine tuning.



4

To store the fine tuning setting in the TV's memory, press the ENTER  button.

To reset the fine tuning setting, press the  button to select "Reset", then press the ENTER  button.

Press the EXIT button to exit.



- ◀ Only analog TV channels can be fine tuned.
- "*" will appear next to the name of fine-tuned channels.

- ◀ If you do not store the fine-tuned channel in memory, adjustments are not saved.

- ◀ Fine tuned channels that have been saved are marked with an asterisk "*" on the right-hand side of the channel number in the channel banner.



CHANNEL CONTROL

Checking the Digital-Signal Strength

Unlike analog channels, which can vary in reception quality from “snowy” to clear, digital (HDTV) channels have either perfect reception quality or you will not receive them at all. So, unlike analog channels, you cannot fine tune a digital channel. You can, however, adjust your antenna to improve the reception of available digital channels.

1

Press the **MENU** button to display the menu.

Press the **UP/DOWN** buttons to select “Channel”, then press the **ENTER** button.

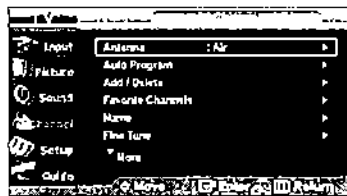

2

Press the **UP/DOWN** buttons to select “Signal Strength”, then press the **ENTER** button.

If the signal strength meter indicates that the signal is weak, physically adjust your antenna to increase the signal strength.

Continue to adjust the antenna until you find the best position with the strongest signal.

Press the **EXIT** button to exit.





CHANNEL CONTROL

LNA (Low Noise Amplifier)

If the TV is operating in a weak-signal area, sometimes the LNA function can improve the reception (a low-noise preamplifier boosts the incoming signal).



1

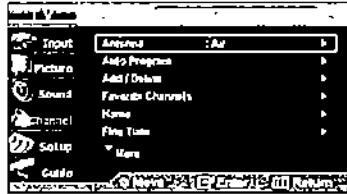

Press the MENU  button to display the menu.

Press the UP/DOWN  buttons to select "Channel", then press the ENTER  button.



2

Press the UP/DOWN  buttons to select "LNA", then press the ENTER  button.

Press the UP/DOWN  buttons to select "On", then press the ENTER  button.

Press the EXIT button to exit.

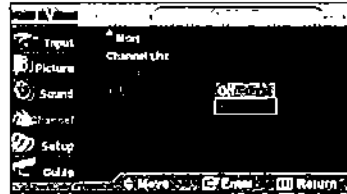
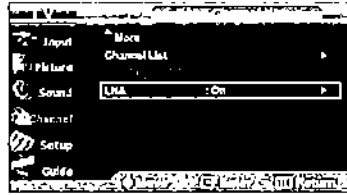

- LNA functions only when antenna is set to AIR and the settings will be stored separately in each channel. (See "Selecting the antenna." on page 61.)

Chapter Seven

PC DISPLAY

Using Your TV as a Computer (PC) Display

Setting Up Your PC Software (Based on Windows XP)

The Windows display-settings for a typical computer are shown below. The actual screens on your PC will probably be different, depending upon your particular version of Windows and your particular video card. However, even if your actual screens look different, the same basic set-up information will apply in almost all cases. (If not, contact your computer manufacturer or Samsung Dealer.)

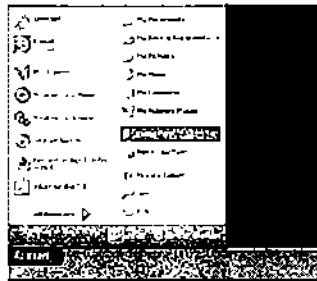

- 1 First, click on "Control Panel" on the Windows start menu.

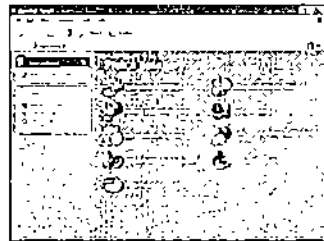

- 2 When the control panel window appears, click on "Appearance and Themes" and a display dialog-box will appear.



- 3 When the control panel window appears, click on "Display" and a display dialog-box will appear.

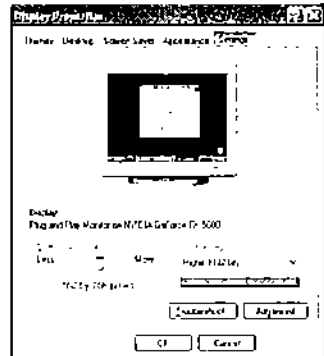

- 4 Navigate to the "Settings" tab on the display dialog-box. The correct size setting (resolution)
LN-R408D: 1360 x 768 pixels
If a vertical-frequency option exists on your display settings dialog box, the correct value is "60" or "60 Hz". Otherwise, just click "OK" and exit the dialog box.

• See "Display Modes" on page 120.

PC DISPLAY



How to Auto Adjust



Use the Auto Adjust function to have the TV set automatically adjust the video signals the monitor receives. The function also automatically fine-tunes the settings and adjusts the frequency values and positions.

Note: This function does not work in DVI-Digital mode.

1



Press the MENU  button to display the menu.

Press the UP/DOWN  buttons to select "Setup", then press the ENTER  button.

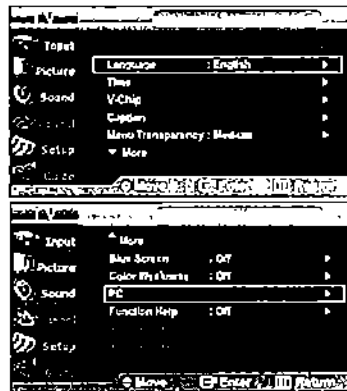
Press the UP/DOWN  buttons to select "PC", then press the ENTER  button.



2

Press the UP/DOWN  buttons to select "Auto Adjustment", then press the ENTER  button.

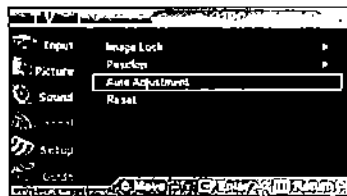

Auto Adjustment In progress. Please wait.

PC DISPLAY

Adjusting the Screen Quality

The purpose of the picture quality adjustment is to remove or reduce picture noise. If the noise is not removed by fine tuning alone, then do the frequency adjustments to the utmost and fine tune again. After the noise has been reduced, re-adjust the picture so that it is aligned on the center of screen.

1

Press the **MENU** button to display the menu.

Press the **UP/DOWN** buttons to select "Setup", then press the **ENTER** button.

Press the **UP/DOWN** buttons to select "PC" then press the **ENTER** button.

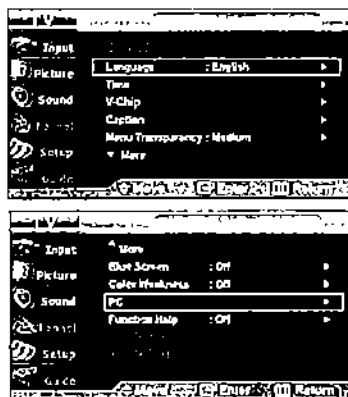

2

Press the **ENTER** button to select "Image Lock".

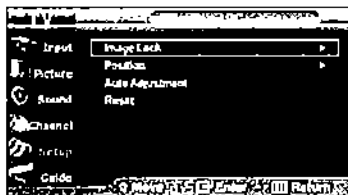

3

Press the **UP/DOWN** buttons to select "Coarse" or "Fine", then press the **ENTER** button.

Press the **LEFT/RIGHT** buttons to adjust the screen quality. Vertical stripes may appear or the picture may be blurry.

Press the **ENTER** button.

Press the **EXIT** button to exit.

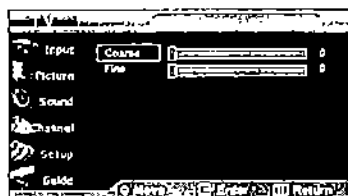





PC DISPLAY

Changing the Screen Position

1



Press the MENU  button to display the menu.

Press the UP/DOWN  buttons to select "Setup", then press the ENTER  button.

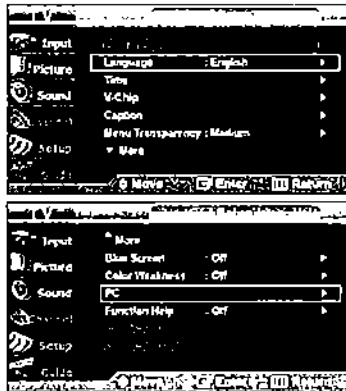
Press the UP/DOWN  buttons to select "PC" then press the ENTER  button.





2

Press the UP/DOWN  buttons to select "Position", then press the ENTER  button.



3

Press the UP/DOWN  buttons to adjust the V-Position.

Press the LEFT/RIGHT  buttons to adjust the H-Position.

Press the ENTER  button.

Press the EXIT button to exit.

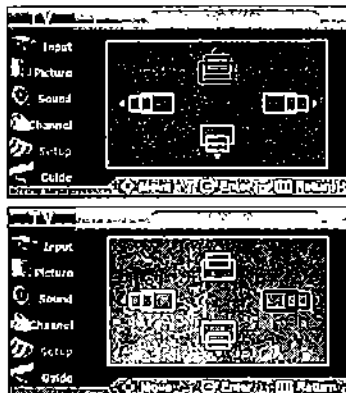

PC DISPLAY

Initializing the Screen Position or Color Settings

1

Press the **MENU** button to display the menu.

Press the **UP/DOWN** buttons to select "Setup", then press the **ENTER** button.

Press the **UP/DOWN** buttons to select "PC", then press the **ENTER** button.

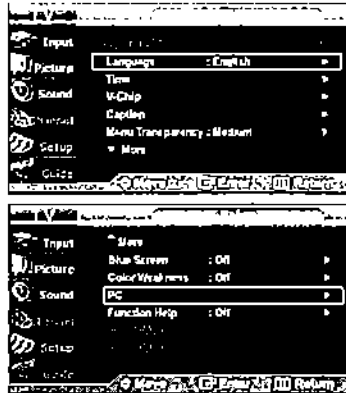

2

Press the **UP/DOWN** buttons to select "Reset", then press the **ENTER** button.

Press the **EXIT** button to exit.

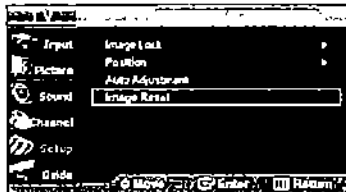

Image Reset is completed.

Chapter Eight

TIME SETTING

Setting the Clock

Setting the clock is necessary in order to use the various timer features of the TV. Also, you can check the time while watching the TV. (Just press the INFO button.)

Option 1: Setting the Clock Manually

1

Press the **MENU** button to display the menu.

Press the **UP/DOWN** buttons to select "Setup", then press the **ENTER** button.

Press the **UP/DOWN** buttons to select "Time", then press the **ENTER** button.

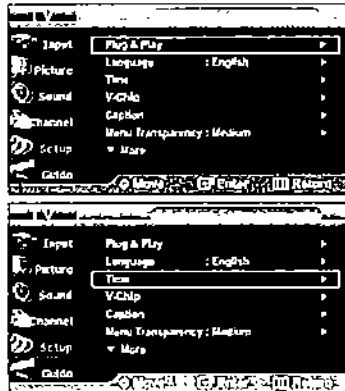

2

Press the **ENTER** button to select "Clock".

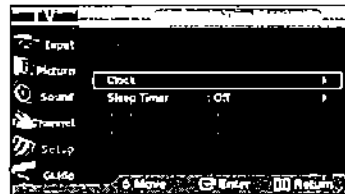

3

Press the **ENTER** button to select "Clock Mode".

Press the **UP/DOWN** buttons to select "Manual", then press the **ENTER** button.



TIME SETTING

4

Press the UP/DOWN ▲▼ buttons to select "Clock Set", then press the ENTER  button.

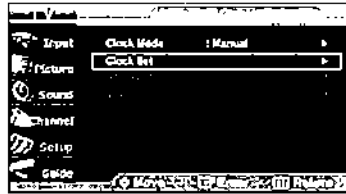

5

Press the LEFT/RIGHT ◀▶ buttons to move to "Month", "Day", "Year", "Hour", "Minute", or "am/pm". Set the date and time you want by pressing the UP/DOWN ▲▼ buttons, then press the ENTER  button.

Press the EXIT button to exit.

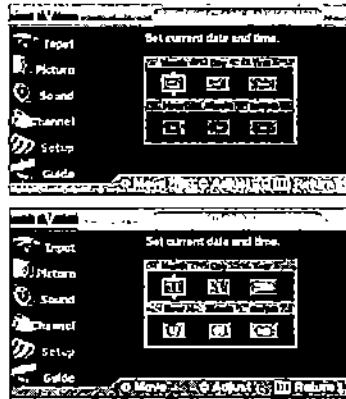



- ◀ • The current time will appear every time you press the INFO button.
- You can set the hour and minute directly by pressing the number buttons on the remote control.



TIME SETTING

Option 2: Setting the Clock Automatically

1

Press the MENU  button to display the menu.

Press the UP/DOWN  buttons to select "Setup", then press the ENTER  button.

Press the UP/DOWN  buttons to select "Time", then press the ENTER  button.

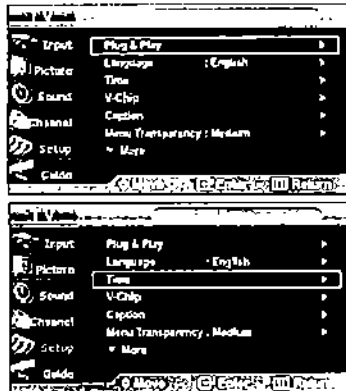



2

Press the ENTER  button to select "Clock".



3

Press the ENTER  button to select "Clock Mode".

Press the UP/DOWN  buttons to select "Auto", then press the ENTER  button.

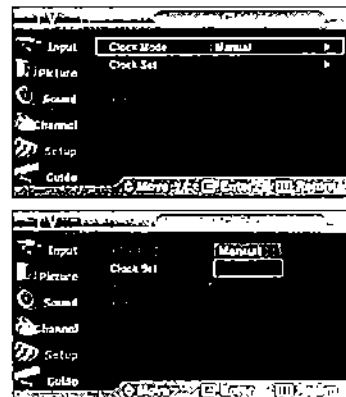

TIME SETTING

4

Press the **UP/DOWN ▲▼** buttons to select "Time Zone", then press the **ENTER** button.

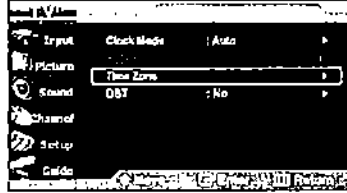

5

Press the **UP/DOWN ▲▼** buttons to highlight the time zone for your local area (and to move the highlight to the appropriate time zone on the map of the United States), then press the **ENTER** button.



6

Press the **UP/DOWN ▲▼** buttons to select "DST" (Daylight Saving Time), then press the **ENTER** button.

Press the **UP/DOWN ▲▼** buttons to select "Yes" or "No", then press the **ENTER** button.

Press the **EXIT** button to exit.



◀ Depending on the broadcast station and signal, the auto time may not be set correctly. If this occurs, set the time manually.

◀ Antenna or cable must be connected in order to set the time automatically.

TIME SETTING

Setting the Sleep Timer

The sleep timer automatically shuts off the TV after a preset time (from 30 to 180 minutes).

1

Press the **MENU** button to display the menu.

Press the **UP/DOWN** buttons to select "Setup", then press the **ENTER** button.

Press the **UP/DOWN** buttons to select "Time", then press the **ENTER** button.

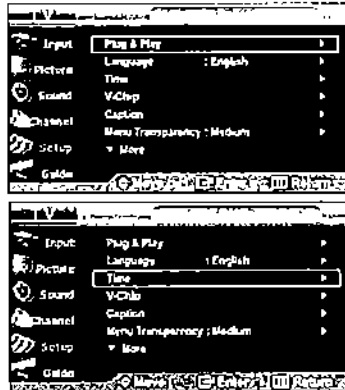

◀ Quick way to access the sleep timer setting: Simply press the "SLEEP" button under the cover of the remote control.

2

Press the **UP/DOWN** buttons to select "Sleep Timer", then press the **ENTER** button.

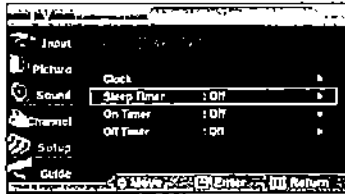

3

Press the **UP/DOWN** buttons to adjust "Minute".



4

Press the **▶** button to select "Activation".

Press the **UP/DOWN** buttons to select "Yes", then press the **ENTER** button.

Press the **EXIT** button to exit.



TIME SETTING

Setting the On/Off Timer

1

Press the **MENU** button to display the menu.

Press the **UP/DOWN** buttons to select "Setup", then press the **ENTER** button.

Press the **UP/DOWN** buttons to select "Time", then press the **ENTER** button.

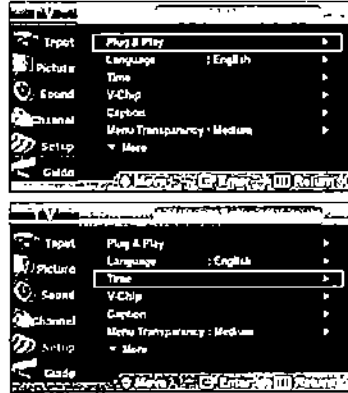

2

Press the **UP/DOWN** buttons to select "On Timer", then press the **ENTER** button.

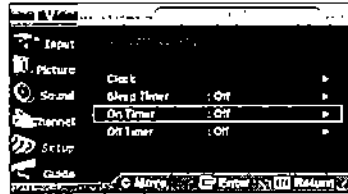

3

Press the **UP/DOWN** buttons to adjust "Hour", then press the **RIGHT** button to move to the next step.

Set other items using the same method as above.

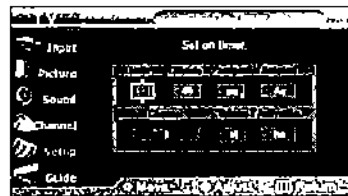

- ◀ When finished, press the **MENU** button to return.
- The current time will appear every time you press the **INFO** button.
- You can set the hour and minute directly by pressing the number buttons on the remote control.

TIME SETTING

4

Press the UP/DOWN ▲▼ buttons to select "Off Timer", then press the ENTER(ENTER) button.



5

Press the UP/DOWN ▲▼ buttons to adjust "Hour", then press the ► button to move to the next step. Set other items using the same method as above. Press the EXIT button to exit.

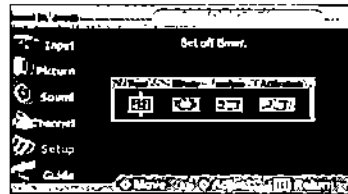

Chapter Nine

FUNCTION DESCRIPTION

Selecting a Menu Language

1

Press the **MENU** button to display the menu.

Press the **UP/DOWN** buttons to select "Setup", then press the **ENTER** button.

Press the **UP/DOWN** buttons to select "Language", then press the **ENTER** button.

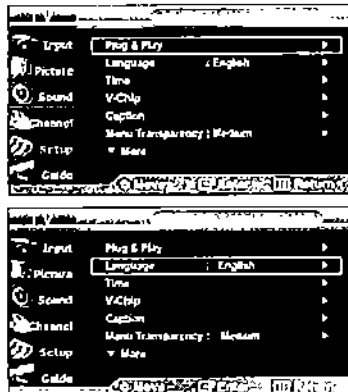

2

Press the **UP/DOWN** buttons to select the appropriate language: "English", "Spanish" or "French".

Press the **ENTER** button.

Press the **EXIT** button to exit.

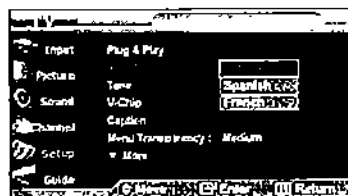

FUNCTION DESCRIPTION

Selecting the Film Mode

On: Automatically senses and processes film signals from all sources and adjusts the picture for optimum quality.

Off: Switches off the Film mode.

1

Press the **MENU** button to display the menu.

Press the **UP/DOWN** buttons to select "Picture", then press the **ENTER** button.

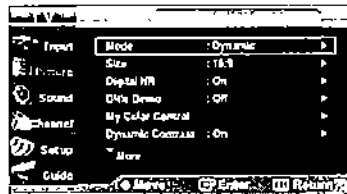

2

Press the **UP/DOWN** buttons to select "Film Mode", then press the **ENTER** button.

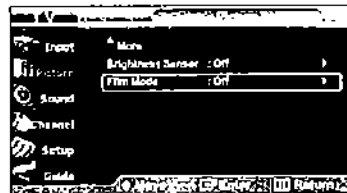

3

Press the **UP/DOWN** buttons to select "On", then press the **ENTER** button.

Press the **EXIT** button to exit.

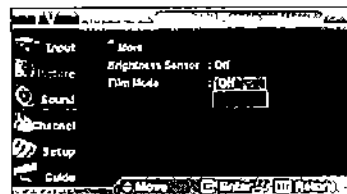

Note

- Film mode is supported in TV, VIDEO, S-VIDEO, and COMPONENT 480i

FUNCTION DESCRIPTION

Digital Noise Reduction

If the broadcast signal received by your TV is weak, you can activate the Digital Noise Reduction feature to help reduce any static and ghosting that may appear on the screen.

1

Press the **MENU** button to display the menu.

Press the **UP/DOWN** buttons to select "Picture", then press the **ENTER** button.

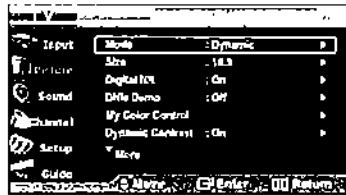

2

Press the **UP/DOWN** buttons to select "Digital NR", then press the **ENTER** button.

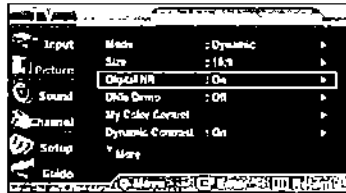

3

Press the **UP/DOWN** buttons to select "On", then press the **ENTER** button.

Press the **EXIT** button to exit.

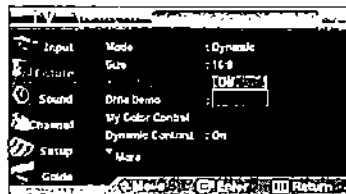

FUNCTION DESCRIPTION



Using the Color Weakness Enhancement Option

This option adjusts the Red, Blue or Green color to enhance the image according to the user's particular color weakness.

The following models are applied.



1

Press the MENU  button to display the menu.

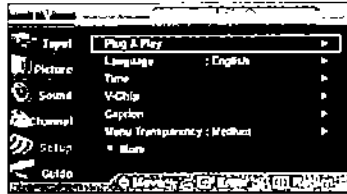
Press the UP/DOWN  buttons to select "Setup", then press the ENTER  button.



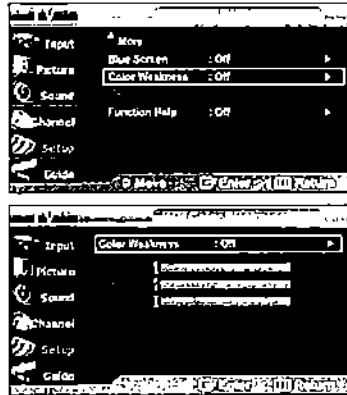

2-1 (LN-R269D / LN-R329D)

Press the UP/DOWN  buttons to select "Color Weakness", then press the ENTER  button.



2-2 (LN-R409D / LN-R469D)

Press the UP/DOWN  buttons to select "Color Weakness", then press the ENTER  button.

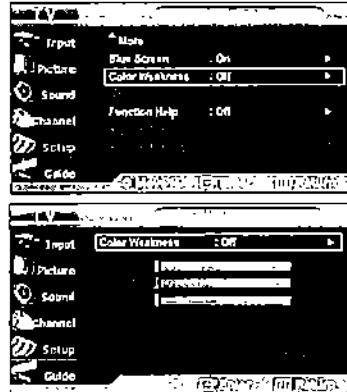

FUNCTION DESCRIPTION

3

Press the **ENTER** button.

Press the **UP/DOWN** buttons to select "On", then press the **ENTER** button.

You will also see the items "Red", "Green" and "Blue".

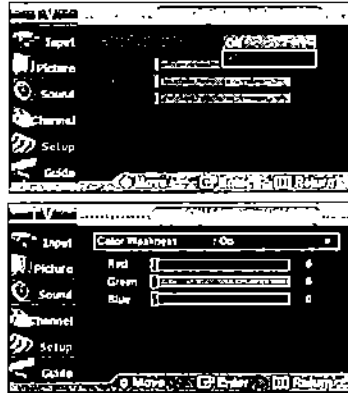

4

Press the **UP/DOWN** buttons to select the item you wish to change, then press the **ENTER** button.

Press the **LEFT/RIGHT** buttons to change the value of the item, then press the **ENTER** button.

Press the **EXIT** button to exit.

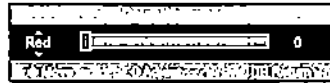



FUNCTION DESCRIPTION

Viewing Closed Captions (On-Screen Text Messages) - Analog

The Analog Caption function operates in either analog RF channel mode or external signal mode.



1

Press the MENU  button to display the menu.

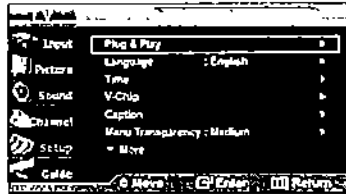
Press the UP/DOWN  buttons to select "Setup", then press the ENTER  button.



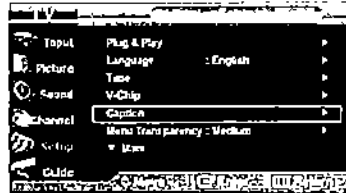

2

Press the UP/DOWN  buttons to select "Caption", then press the ENTER  button.



3

Press the ENTER  button to select "Caption".

Press the UP/DOWN  buttons to select "On", then press the ENTER  button.

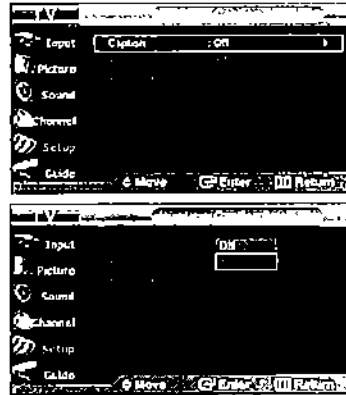

FUNCTION DESCRIPTION

4

Press the UP/DOWN ▲▼ buttons to select "Caption Mode", then press the ENTER button.

Press the UP/DOWN ▲▼ buttons to select submenu (Default, CC1-CC4 or Text1-Text4) you want, then press the ENTER button.

Press the EXIT button to exit.

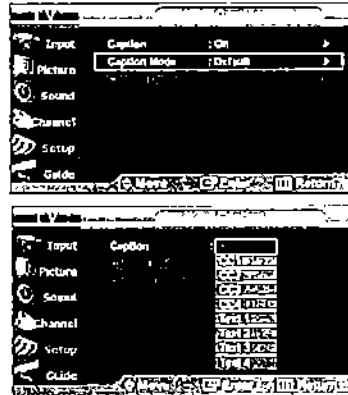

- The default is "CC1".

CC1 : The Primary Synchronous Caption Service.

These are captions in the primary language that must be in sync with the sound, preferably matched to a specific frame.

CC2 : The Special Non-Synchronous Use Captions.

This channel carries data that is intended to augment information carried in the program.

CC3 : Secondary Synchronous Caption Service.

Alternate program-related caption data, typically second language captions.

CC4 : Special Non-Synchronous Use Captions.

Similar to CC2.

Note

- The Caption feature doesn't work in COMPONENT(480p, 720p, 1080i), HDMI modes.
- The availability of captions depends on the program being broadcast.



FUNCTION DESCRIPTION

Viewing Closed Captions (On-Screen Text Messages) - Digital

The Digital Captions function operates on digital channels.



1

Press the MENU  button to display the menu.

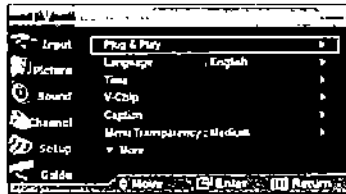
Press the UP/DOWN  buttons to select "Setup", then press the ENTER  button.





2

Press the UP/DOWN  buttons to select "Caption", then press the ENTER  button.



3

Press the ENTER  button to select "Caption".

Press the UP/DOWN  buttons to select "On", then press the ENTER  button.

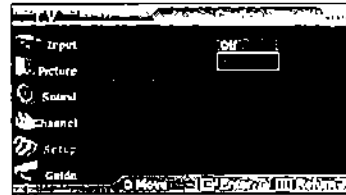

FUNCTION DESCRIPTION

4

Press the UP/DOWN ▲▼ buttons to select "Caption Mode", then press the ENTER (✔) button.

Press the UP/DOWN ▲▼ buttons to select submenu (Default, Service1~Service6, CC1~CC4, or Text1~Text4) you want, then press the ENTER (✔) button.

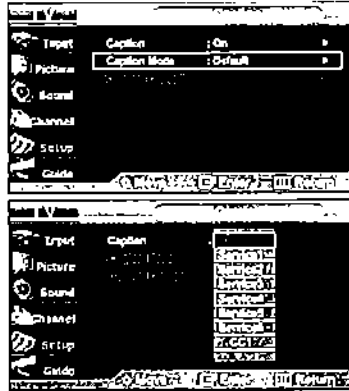

5

Press the UP/DOWN ▲▼ buttons to select "Caption Options", then press the ENTER (✔) button.

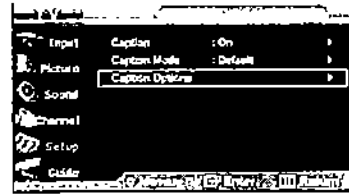

6

Press the UP/DOWN ▲▼ buttons to select "Size", then press the ENTER (✔) button.

Press the UP/DOWN ▲▼ buttons to select the desired Caption option, then press the ENTER (✔) button.

Press the Up or Down button to select the desired sub-menu options(see options below), then press ENTER (✔) .

Press the EXIT button to exit.

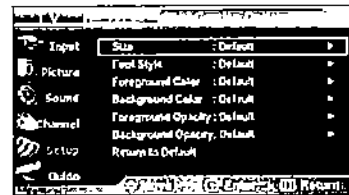

- ◀ • "Caption Options" are available only when "Service1~Service6" can be selected in "Caption Mode".
- SERVICE1~6 in digital caption mode may not be available depending on the broadcast.
- ◀ • The availability of captions depends on the program being broadcast.
- "Default" means to follow the standard set by the broadcaster.

FUNCTION DESCRIPTION

- **Size**
This option consists of "Default", "Small", "Standard", and "Large". The default is "Standard".
- **Font Style**
This option consists of "Default", "Style0 - Style 7". You can change the font you want.
The default is "Style 0".
- **Foreground Color**
This option consists of "Default", "White", "Black", "Red", "Green", "Blue", "Yellow", "Magenta", and "Cyan". You can change the color of the letter. The default is "White".
- **Background Color**
This option consists of "Default", "White", "Black", "Red", "Green", "Blue", "Yellow", "Magenta", and "Cyan". You can change the background color of the caption.
The default is "Black".
- **Foreground Opacity**
This option consists of "Default", "Transparent", "Translucent", "Solid", and "Flashing".
You can change the opacity of the letter.
- **Background Opacity**
This option consists of "Default", "Transparent", "Translucent", "Solid", and "Flashing".
You can change the background opacity of the caption.
- **Return to Default**
This option sets each of "Size", "Font Style", "Foreground Color", "Background color", "Foreground Opacity", and "Background Opacity" to its default.

Alternate method:

Press the CAPTION button on the remote control repeatedly to select "On" or "Off".



FUNCTION DESCRIPTION

Menu Transparency Level

Adjusts the transparency of the menu screen.

1

Press the **MENU** button to display the menu.

Press the **UP/DOWN** buttons to select "Setup", then press the **ENTER** button.

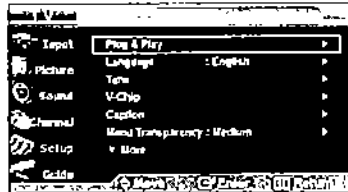

2

Press the **UP/DOWN** buttons to select "Menu Transparency", then press the **ENTER** button. Press the **UP/DOWN** buttons to select level, then press the **ENTER** button.

Press the **EXIT** button to exit.

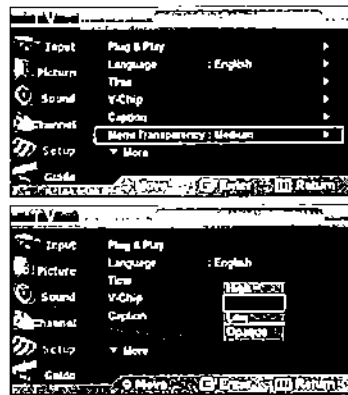

FUNCTION DESCRIPTION

Setting the Function Help

Displays help on the menu functions.

The following models are applied.

1

Press the **MENU** button to display the menu.

Press the **UP/DOWN** buttons to select "Setup", then press the **ENTER** button.



2-1 (LN-R269D / LN-R329D)

Press the **UP/DOWN** buttons to select "Function Help", then press the **ENTER** button.

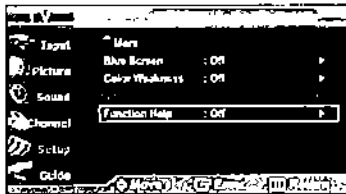

2-2 (LN-R409D / LN-R469D)

Press the **UP/DOWN** buttons to select "Function Help", then press the **ENTER** button.

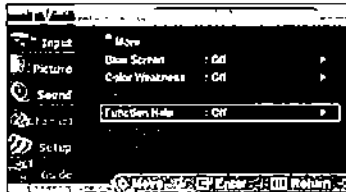

3-1 (LN-R269D / LN-R329D)

Press the **UP/DOWN** buttons to select "On", then press the **ENTER** button.

Press the **EXIT** button to exit

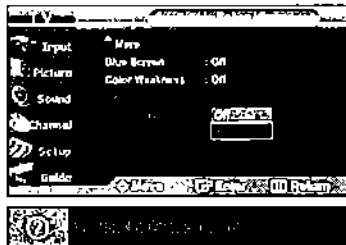

3-2 (LN-R409D / LN-R469D)

Press the **UP/DOWN** buttons to select "On", then press the **ENTER** button.

Press the **EXIT** button to exit



FUNCTION DESCRIPTION

Using the V-Chip

The V-Chip feature automatically locks out programs that are deemed inappropriate for children. The user must enter a PIN (personal ID number) before any of the V-Chip restrictions are set up or changed.

- Notes :
- When the V-chip feature is activated, the PIP features do not function.
 - The V-Chip does not work if the input is DTV (HD or SD).

Setting Up Your Personal ID Number (PIN)

1

Press the **MENU** button to display the menu.

Press the **UP/DOWN** buttons to select "Setup", then press the **ENTER** button.

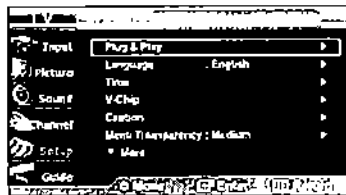

2

Press the **UP/DOWN** buttons to select "V-Chip", then press the **ENTER** button.

The message "Enter PIN" will appear. Enter your 4 digit PIN number.

- The default PIN number of a new TV set is "0-0-0-0".

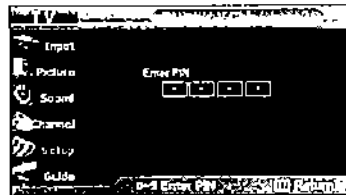
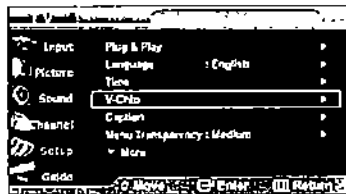

3

The "V-Chip" screen will appear. Press the **UP/DOWN** buttons to select "Change PIN", then press the **ENTER** button.

The Change PIN screen will appear. Choose any 4 digits for your PIN and enter them. As soon as the 4 digits are entered, the "Confirm new PIN" screen appears. Re-enter the same 4 digits. When the Confirm screen disappears, your PIN has been memorized.

Press the **EXIT** button to exit.

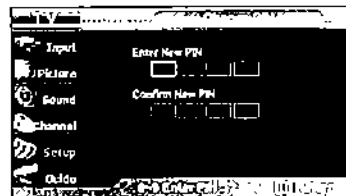
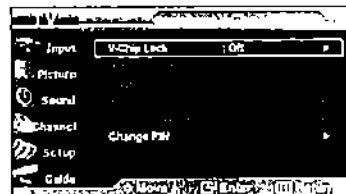

- ◀ If you forget the PIN, press the remote-control buttons in the following sequence, which resets the pin to 0-0-0-0 :
Power Off.
→ Mute → 8 → 2 → 4
→ Power On.

FUNCTION DESCRIPTION

How to Enable/Disable the V-Chip

1

Press the **MENU** button to display the menu.

Press the **UP/DOWN** buttons to select "Setup", then press the **ENTER** button.

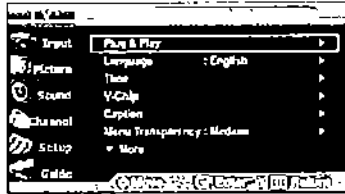

2

Press the **UP/DOWN** buttons to select "V-Chip", then press the **ENTER** button.

The message "Enter PIN" will appear. Enter your 4 digit PIN number.

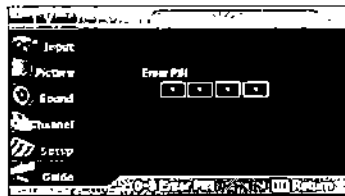

3

The "V-Chip" screen will appear. To enable the V-Chip feature, press the **ENTER** button so that the "V-Chip Lock" field is "On". (Pressing the **UP/DOWN** buttons will alternate between "On" and "Off".) Press the **ENTER** button.

Press the **EXIT** button to exit.

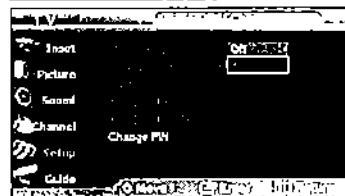
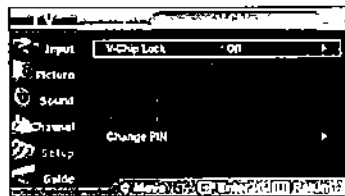

FUNCTION DESCRIPTION

How to Set up Restrictions Using the "TV Parental Guidelines"

First, set up a personal identification number (PIN), and enable the V-Chip. (See previous section.) Parental restrictions can be set up using either of two methods: The TV guidelines or the MPAA rating.

1
 Press the MENU button to display the menu.
 Press the UP/DOWN buttons to select "Setup", then press the ENTER button.

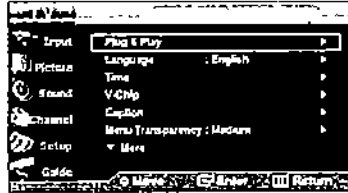

2
 Press the UP/DOWN buttons to select "V-Chip", then press the ENTER button.
 The message "Enter PIN" will appear. Enter your 4 digit PIN number.

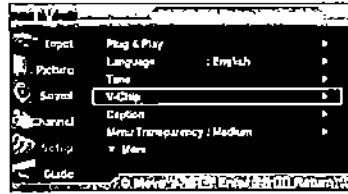

3
 The "V-Chip" screen will appear. Press the UP/DOWN buttons to select "TV Parental Guidelines", then press the ENTER button.

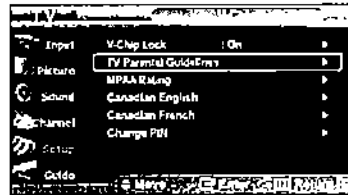

4
 The "TV Parental Guidelines" screen will appear.
 Press the UP/DOWN buttons to select one of the six aged based categories:

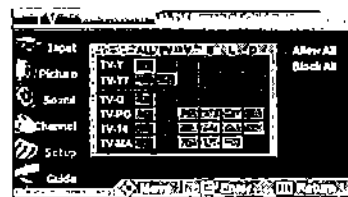



TV-Y	Young children
TV-Y7	Children 7 and over
TV-G	General audience
TV-PG	Parental guidance
TV-14	Viewers 14 and over
TV-MA	Mature audience

FUNCTION DESCRIPTION

5

At this point, one of the TV-Ratings is selected. Press the **ENTER** (↵) button. Depending on your existing setup, a symbol will be selected.

(Blank = Unblocked,
 = Blocked)

While "" is selected, press the **ENTER** (↵) button to block or unblock the category.

To select a different TV-Rating, press the **UP/DOWN** (▲▼) buttons and then repeat the process.

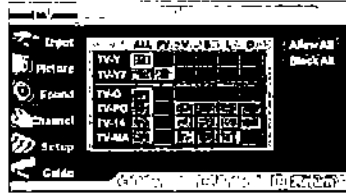

Note 1: The TV-Y, TV-Y7, TV-G, TV-PG, TV-14 and TV-MA have additional options. See the next step to change any of the following sub-ratings:

FV: Fantasy violence
 D: Sexually Suggestive Dialog
 L: Adult Language
 S: Sexual situation
 V: Violence

Note 2: The V-Chip will automatically block certain categories that are "more restrictive". For example, if you block "TV-Y" category, then TV-Y7 will automatically be blocked. Similarly, if you block the TV-G category, then all the categories in the "young adult" group will be blocked (TV-Y, TV-Y7, TV-G, TV-PG, TV-14, and TV-MA). The sub-ratings (D, L, S, V) work together similarly. (See next section.)

6

How to set the FV, D, L, S and V sub-ratings.

First, select one of these TV-Ratings: TV-Y, TV-Y7, TV-G, TV-PG, TV-14, or TV-MA (See Step 4, on previous page), and press the **▶** button. A symbol "" will be displayed for each sub-rating.

While "" is selected, press the **ENTER** (↵) button to go to a sub-rating. Press **ENTER** (↵) to block the sub-rating. To select a different TV-Rating, press the **UP/DOWN** (▲▼) buttons and then repeat the process.

Note: The V-chip will automatically block certain categories that are "More restrictive". For example, if you block "L" sub-rating in TV-PG, then the "L" sub-ratings in TV-14 and TV-MA will automatically be blocked.

7

Press the **MENU** button to clear all the screens. (Or proceed to the next section, and set up additional restrictions based on the MPAA codes.)

Note

- These categories consist of two separate groups: TV-Y and TV-Y7 (young children through age 7), and TV-G through TV-MA (everybody else). The restrictions for these two groups work independently: If a household includes very young children as well as young adults, the TV guidelines must be set up separately for each age group. (See next step.)

FUNCTION DESCRIPTION

How to Set up Restrictions Using the MPAA Ratings: G, PG, PG-13, R, NC-17, X, NR

The MPAA rating system uses the Motion Picture Association of America (MPAA) system, and its main application is for movies. When the V-Chip lock is on, the TV will automatically block any programs that are coded with objectionable ratings (either MPAA or TV-Ratings).

1

Press the **MENU** button to display the menu.

Press the **UP/DOWN** buttons to select "Setup", then press the **ENTER** button.

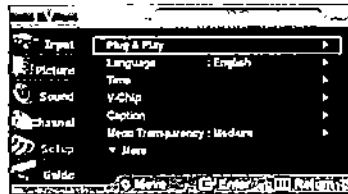

2

Press the **UP/DOWN** buttons to select "V-Chip", then press the **ENTER** button. The message "Enter PIN" will appear. Enter your 4 digit PIN number.

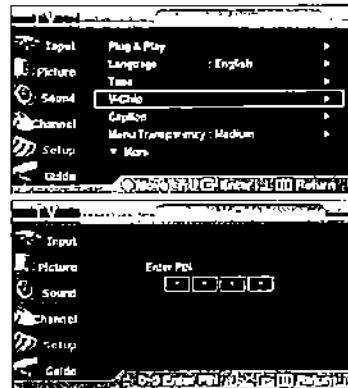

3

The "V-Chip" screen will appear. Press the **UP/DOWN** buttons to select "MPAA Rating", then press the **ENTER** button.

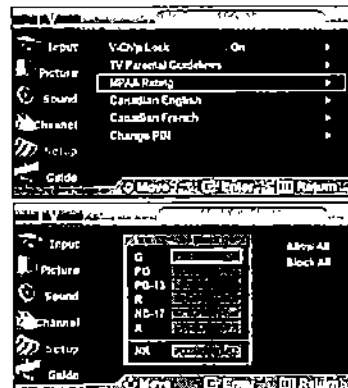

FUNCTION DESCRIPTION

4

The "MPAA Rating" screen will appear. Repeatedly press the **UP/DOWN ▲▼** buttons to select a particular MPAA category. Pressing the **UP/DOWN ▲▼** buttons will cycle through the MPAA categories:



G	General audience (no restrictions).
PG	Parental guidance suggested.
PG-13	PG-13 (Parents strongly cautioned).
R	R (Restricted. Children under 17 should be accompanied by an adult).
NC-17	No children under age 17.
X	X (Adults only).
NR	Not rated.



While a particular category is selected, press the **ENTER** button to activate it. A selected symbol "☑" will be displayed. Press the **ENTER** button to block or unblock the category.

Note: The V-Chip will automatically block any category that is "more restrictive". For example, if you block the "PG-13" category, then "R", "NC-17" and "X" will automatically be blocked also.

How to Set up Restrictions Using the 'Canadian English'



1

Press the MENU  button to display the menu.

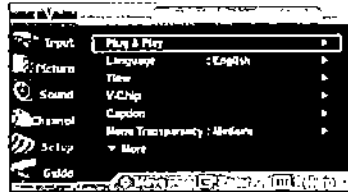
Press the UP/DOWN  buttons to select "Setup", then press the ENTER  button.



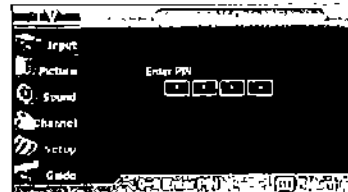
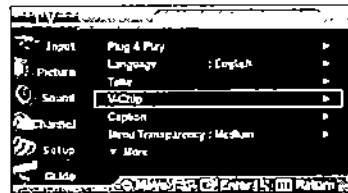

2

Press the UP/DOWN  buttons to select "V-Chip", then press the ENTER  button. The message "Enter PIN" will appear. Enter your 4 digit PIN number.



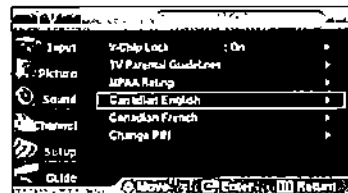

3

Press the UP/DOWN  buttons to select "Canadian English", then press the ENTER  button.



4

Press the UP/DOWN  buttons to select an appropriate restriction. Press the ENTER  button to activate the restriction selected. The  symbol is indicated. Press the EXIT button to exit.



◀ Allow All: Press to unlock all TV ratings.
Block All: Press to lock all TV ratings.

Canadian English

- E : Exempt programming includes...news, sports, documentaries and other information programming, talk shows, music videos, and variety programming.
- C : Programming intended for children under age 8.
- C+ : Programming generally considered acceptable for children 8 years and over to watch on their own.
- G : General programming, suitable for all audiences.
- PG : Parental Guidance.
- 14+ : Programming contains themes or content which may not be suitable for viewers under the age of 14.
- 18+ : Adult programming.

How to Set up Restrictions Using the 'Canadian French'

1

Press the **MENU** button to display the menu.

Press the **UP/DOWN** buttons to select "Setup", then press the **ENTER** button.



2

Press the **UP/DOWN** buttons to select "V-Chip", then press the **ENTER** button. The message "Enter PIN" will appear. Enter your 4 digit PIN number.

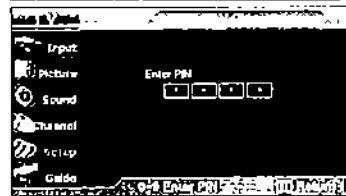
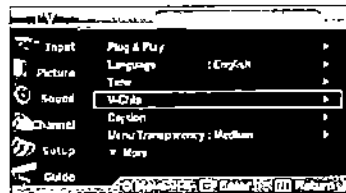

3

Press the **UP/DOWN** buttons to select "Canadian French", then press the **ENTER** button.

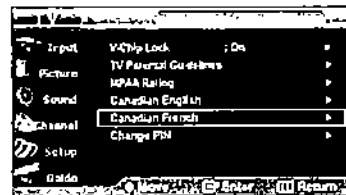

4

Press the **UP/DOWN** buttons to select a appropriate restriction. Press the **ENTER** button to activate the restriction selected. The " " symbol is indicated.

Press the **EXIT** button to exit.



◀ Allow All: Press to unlock all TV ratings.
Block All: Press to lock all TV ratings.

Canadian French

- E : Exempt programming includes...news, sports, documentaries and other information programming, talk shows, music videos, and variety programming.
- G : General.
- 8 ans+ : 8+ General-Not recommended for young children.
- 13 ans+ : Programming may not be suitable for children under the age of 13.
- 16 ans+ : Programming is not suitable for children under the age of 16.
- 18 ans+ : Programming restricted to adults.

FUNCTION DESCRIPTION

How to Reset the TV after the V-Chip Blocks a Channel ("Emergency Escape")

If the TV is tuned to a restricted channel, the V-Chip will block it. The screen will go blank and the following message will appear:

- 1**
Enter your PIN number.



To resume normal viewing, tune to a different channel using CH or CH button. Under certain conditions (depending on the rating of the local TV programs) the V-Chip might lock out all the channels. In this case, use the V-Chip function for an "emergency escape":

- 1** Press the MENU button. Press the UP/DOWN button to select "Setup", then press the ENTER button.
- 2** Press the UP/DOWN button to select "V-Chip", then press the ENTER button.
- 3** Enter your PIN number, and press the UP/DOWN button to temporarily disable the V-Chip Lock.

FUNCTION DESCRIPTION

Electronic Program Guide

Your TV has an "Electronic Program Guide" to help you navigate through all the possible viewing options. The EPG supplies information, such as program lists, start and end times of all available channels. In addition, detailed information about the program is often available in the EPG. (The availability and the amount of program details will vary depending on the broadcaster.)

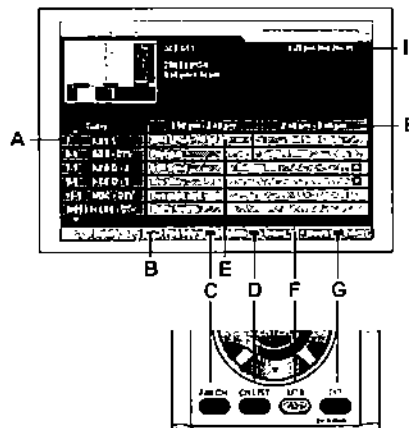

Viewing the Electronic Program Guide

- A** Displays which channel is currently selected to show program information in the Channel Guide.
- B** Press to view detailed information for the selected digital program.
- C** Switches to the mini program guide. The mini guide shows the titles of the available programs of one channel. Press the Red button on the remote control. The set default guide is Mini Guide.
- D** Scrolls backwards quickly (2 hours). Press the Green button on the remote control.
- E** Displays titles and other details about upcoming programs of particular channels. Highlight the program and press the INFO button to see additional and detailed information. (The availability of additional details depends on the broadcaster.) Use the ▲/▼ buttons to search information about another channel.
- F** Scrolls forward quickly (2 hours). Press the Yellow button on the remote control and repeatedly press the ENTER button the appropriate time is displayed.
- G** Exits from the Program Guide and returns to normal viewing mode. Press the Blue button on the remote control.
- H** Displays the program times (arranged in 1 hour time blocks).
- I** Displays the current time and date.

Note



- You can use the GUIDE button on the remote control to display the Electronic Program Guide. The EPG begins its list with the channel that is currently active. The EPG will only work when you are receiving digital channels.

FUNCTION DESCRIPTION

Using the Electronic Program Guide



1

Press the MENU  button to display the menu.

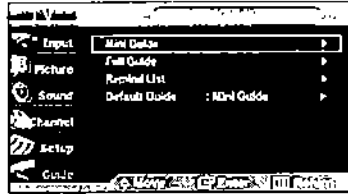
Press the UP/DOWN  buttons to select "Guide", then press the ENTER  button.



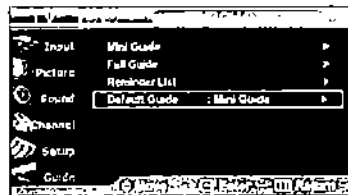

2

Press the UP/DOWN  buttons to select "Default Guide", then press the ENTER  button.



3

Press the UP/DOWN  buttons to select "Mini Guide" or "Full Guide", then press the ENTER  button.

- Mini Guide : Displays the guide for one channel.
- Full Guide : Displays the guide for all channels.

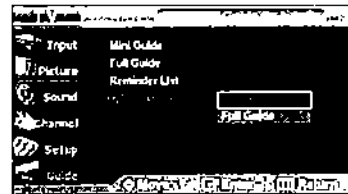



Press the EXIT button to exit.

FUNCTION DESCRIPTION

Viewing Information about a Single Channel

1

Press the **MENU**  button to display the menu.

Press the **UP/DOWN**  buttons to select "Guide", then press the **ENTER**  button.

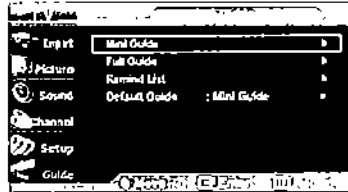

2

Press the **ENTER**  button to select "Mini Guide".

Press the **UP/DOWN**  buttons to view information about one channel by time.

You can switch between Full Guide mode and Mini Guide mode by pressing the **Red** button repeatedly.

Select the program you want by pressing the **UP/DOWN**  buttons and press the **INFO** button on the remote control.

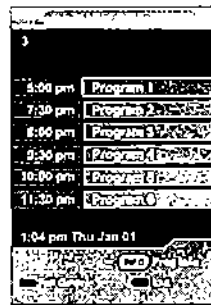

- **ENTER** button : Press to watch the current program or to add the program to reminder list.
- **Red** button : Press to switch to the program guide for all channels. Press again to switch to the program information for the selected channel.
- **Blue** button : Press to exit.
- **INFO** button : Press to view detailed information for the selected digital program.

Press the **EXIT** button to exit.

Note

- You can also view information about a single channel by pressing the **GUIDE** button on the remote control. (The EPG should be pre-set in Mini Guide mode.)
- Press the **INFO** button on the remote control to view the program information for the current channel.

FUNCTION DESCRIPTION

Viewing Information about Channels

Displays the program time and content for all channels.
This function is available only when the program is digital.

1

Press the **MENU** button to display the menu.

Press the **UP/DOWN** buttons to select "Guide", then press the **ENTER** button.

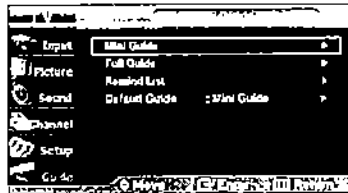

2

Press the **UP/DOWN** buttons to select "Full Guide", then press the **ENTER** button.

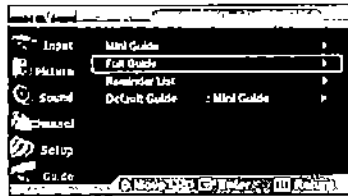

3

Press the Green button to activate "-2 Hours" and the Yellow button to activate "+2 Hours".

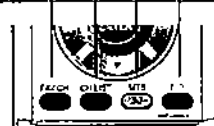
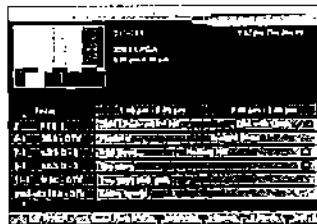

- **INFO** button : Displays detailed information for the selected digital program.
- **▲▼◀▶** button : Displays program information for each channel, based on the time. Select your desired program using the **UP/DOWN/LEFT/RIGHT ▲▼◀▶** buttons, and then press the **INFO** button to view the program information for the selected program.
- **Red** button : Each press switches between program information for one channel and all channels.
- **Green** button : Press to view the program information from two hours ago.
- **Yellow** button : Press to view the program information for the next two hours.
- **Blue** button : Press to exit.
- **ENTER** button : Press to watch the current program or to add the program to reminder list.

FUNCTION DESCRIPTION

4

You may now:

- Jump to a channel directly : Use the **UP/DOWN ▲▼** buttons to highlight the program in the **▶** column and press the enter button.
- Obtain additional program details : Highlight the title of a program using the **▲, ▼, ◀, or ▶** buttons and press the **INFO** button.
- Exit from the Program Guide and return to normal viewing mode : Press the **Blue** button or the **EXIT** button.

Note

- The current time displayed on the program information is subject to the time information sent from the broadcasting station, so it may differ from the actual time.
- Press the **GUIDE** button on the remote control to view the program information for all channels. However, this function is available only when the default program guide setting is set to "Full Guide".

FUNCTION DESCRIPTION



Reminder List

Viewing the Reminder List

If you have made a scheduled viewing list of programs you would like to see, the channel will be automatically switched to the scheduled program at the scheduled time even if you are watching another program.

1

Press the MENU  button to display the menu.

Press the UP/DOWN  buttons to select "Guide", then press the ENTER  button.

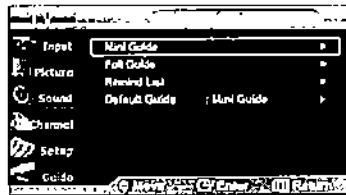

2

Press the ENTER  buttons to select "Mini Guide".

Press the UP/DOWN  buttons to select programs you would like to see, then press the enter button.

The symbol  will be displayed.

Each press of the ENTER  button will switch between "Reminded" and "Clear".

Press the EXIT button to exit.

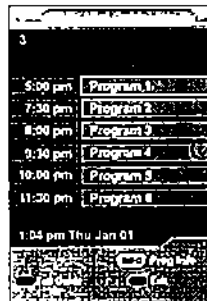

Reminder List

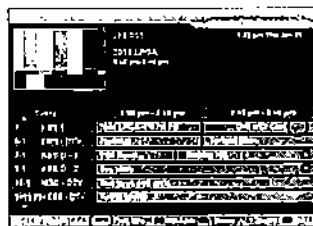

Note



- Up to 8 programs can be scheduled.

FUNCTION DESCRIPTION

To View the Reminder List



1

Press the MENU  button to display the menu.

Press the UP/DOWN  buttons to select "Guide", then press the ENTER  button.





2

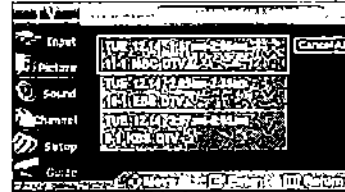
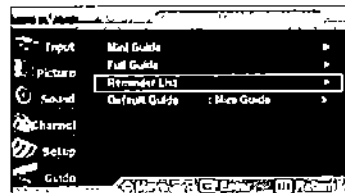

Press the UP/DOWN  buttons to select "Reminder List", then press the ENTER  button.



To remove the scheduled programs

1

Press the UP/DOWN  buttons to select a program to be removed, then press the ENTER  button.

To remove all programs, press the LEFT/RIGHT  buttons to select "Cancel All", then press the ENTER  button.

Press the EXIT button to exit.

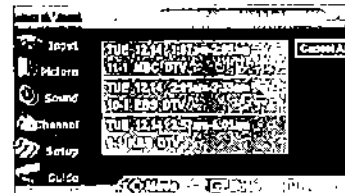
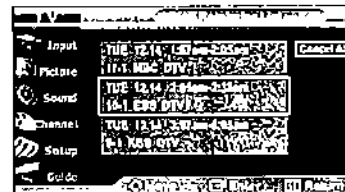

FUNCTION DESCRIPTION

Using the CableCARD (Sold separately) (LN-R409D, LN-R469D)



This menu works with a CableCARD provided by a local cable service provider. Prior to accessing this menu, a CableCARD should be connected to the rear panel of the TV. For detailed connection instructions refer to the "Connecting CableCARD" section of this manual.

Displaying CableCARD related information

Accessing information on Status, Pairing, Network Setup of the CableCARD provided by the service provider in CableCARD menu.



1

Press the MENU  button to display the menu.

Press the UP/DOWN  buttons to select "Setup", then press the ENTER  button.



2

Press the UP/DOWN  buttons to select "CableCARD™", then press the ENTER  button.

Press the EXIT button to exit.

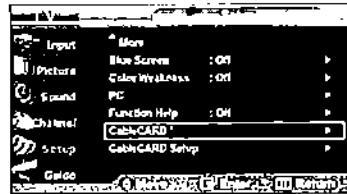

FUNCTION DESCRIPTION

Using the CableCARD Setup Function (LN-R409D, LN-R469D)



Sets up the relevant options for CableCARD.

CableCARD Reset

Resets CableCARD when the channels provided by CableCARD are not available.



1

Press the **MENU**  button to display the menu.

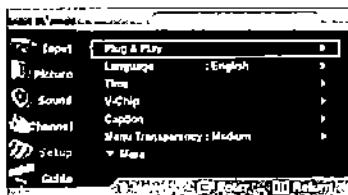
Press the **UP/DOWN**  buttons to select "Setup", then press the **ENTER**  button.



2

Press the **UP/DOWN**  buttons to select "CableCARD Setup", then press the **ENTER**  button.

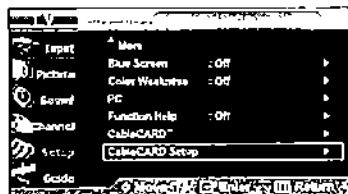

3

Press the **ENTER**  button to select "CableCARD™ Reset".

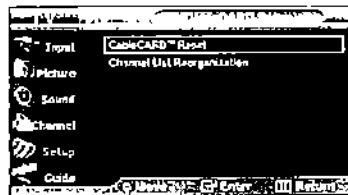



FUNCTION DESCRIPTION

Channel List Reorganization

Deletes and reorganizes the channel list provided by the Cable Company and authorized by the CableCARD.



1

Press the MENU  button to display the menu.

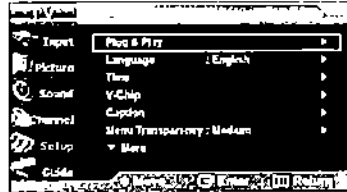
Press the UP/DOWN  buttons to select "Setup", then press the ENTER  button.





2

Press the UP/DOWN  buttons to select "CableCARD Setup", then press the ENTER  button.



3

Press DOWN  to select "Channel List Reorganization", then Press ENTER .

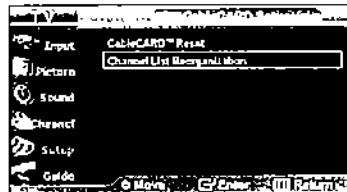

Chapter Ten

APPENDIX

If the TV seems to have a problem, first try this list of possible problems and solutions. If none of these troubleshooting tips apply, call your nearest Samsung service center.

Identifying Problems

Problem	Possible Solution
Poor picture	Try another channel. Adjust the antenna. Check all wire connections.
Poor sound quality.	Try another channel. Adjust the antenna.
No picture or sound.	Try another channel. Press the SOURCE button. Make sure the TV is plugged in. Check the antenna connections.
No sound or sound is too low at maximum volume.	First, check the volume of units connected to your TV (digital broadcasting receiver, DVD, cable broadcasting receiver, VCR, etc.). Then, adjust the TV volume accordingly.
Picture rolls vertically.	Check all wire connections.
The TV operates erratically.	Unplug the TV for 30 seconds, then try operating it again.
The TV won't turn on.	Make sure the wall outlet is working.
Remote control malfunctions	Replace the remote control batteries. Clean the upper edge of the remote control (transmission window). Check the battery terminals.
"Check signal cable" message.	Ensure that the signal cable is firmly connected to the PC sources.
"Not Supported Mode" message.	Check the maximum resolution and the frequency of the Video Adapter. Compare these values with the data in the Display Modes.
Digital broadcasting screen problem.	Please check the digital signal strength and input antenna.

APPENDIX

Problem	Possible Solution						
The image is too light or too dark.	Adjust the Brightness and Contrast. Adjust the Fine tuning.						
Horizontal bars appear to flicker, jitter or shimmer on the image.	Adjust the Coarse tuning and then adjust the Fine tuning.						
Vertical bars appear to flicker, jitter or shimmer on the image.	Adjust the Coarse tuning and then adjust the Fine tuning.						
Screen is black and power indicator light blinks steadily.	On your computer check: Power, Signal Cable. The TV is using its power management system. Move the computer's mouse or press any key on the keyboard.						
Image is not stable and may appear to vibrate when you have a computer connected to the PC input.	If the setting is not correct, use your computer utility program to change the display settings. NOTE: Your TV supports multiscan display functions within the following frequency domain:						
<table border="1"> <tr> <td>Horizontal frequency (kHz)</td> <td>30-60</td> </tr> <tr> <td>Vertical frequency (Hz)</td> <td>60-75</td> </tr> <tr> <td>PC Maximum refresh rate (at 60Hz)</td> <td>1360 x 768</td> </tr> </table>		Horizontal frequency (kHz)	30-60	Vertical frequency (Hz)	60-75	PC Maximum refresh rate (at 60Hz)	1360 x 768
Horizontal frequency (kHz)	30-60						
Vertical frequency (Hz)	60-75						
PC Maximum refresh rate (at 60Hz)	1360 x 768						
Image is not centered on the screen.	Adjust the horizontal and vertical position. The screen position must be adjusted on the output source (i.e. STB) with a digital signal.						
If a still image is displayed for an extended period of time, residual images or blurring may appear.	When you need to leave the monitor unused for an extended period of time, adjust the settings so that the monitor automatically goes into energy saving mode or activates the screen saver to display moving images.						
The TFT LCD panel uses a panel consisting of sub pixels (3,147,264) which require sophisticated technology to produce. However, there may be few bright or dark pixels on the screen. These pixels will have no impact on the performance of the product.							

APPENDIX

Disconnecting the stand

- 1**
Remove four screws from the back of the TV.

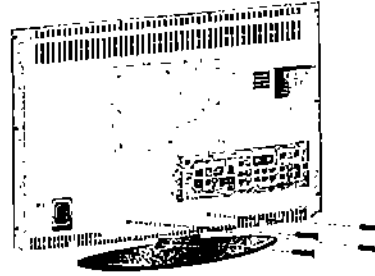

- 2**
Separate the stand from the TV.

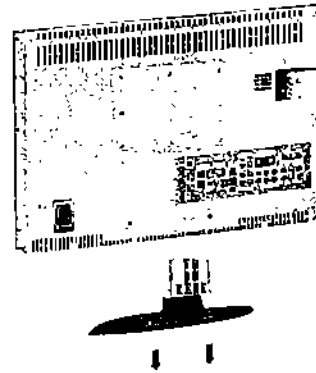

- 3**
Cover the bottom hole with a cap.

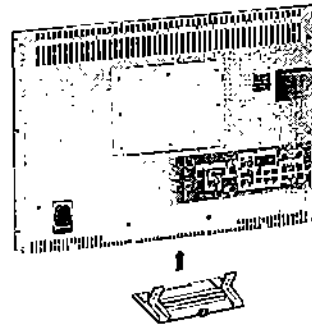

APPENDIX

Installing the Wall Mount Kit (LN-R269D)

*Note: This installation is to be used when attaching the wall mount to a wall.
When attaching to other building materials, please contact your nearest dealer.*

Components (Sold separately)

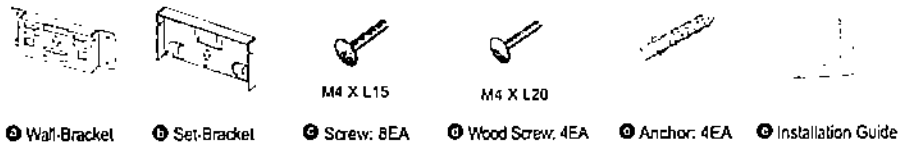

How to assemble the Wall Mount Bracket

- 1 ① Mark the location on the wall where the hole will be drilled.
 - ② Make over 35mm-depth-hole on the marked location using drill.
 - ③ Fix anchors ⑤ on each hole on the wall.
 - ④ Connect wall-bracket ① to the wall with wood screws ④ after fitting anchors ⑤ into the wall-bracket ①.
- Note: If the bracket is not firmly fixed to the wall, LCD TV can fall off.*



- 2 ① Turn the power off and unplug the power cord from the outlet.
- ② Place the TV faced down on a soft cloth or cushion on a table.
- ③ Attach the set-bracket ② onto the rear side of the TV set and secure the screws ③.

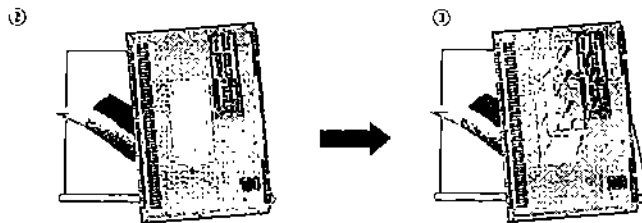

- 3 ① Insert three Hangers of the set-bracket ② into the grooves of the wall-bracket ①.
 - ② Fix set-bracket ② and wall-bracket ① with screws ③.
- Note: Before installing the set on the wall, connect the cables to the set first.*

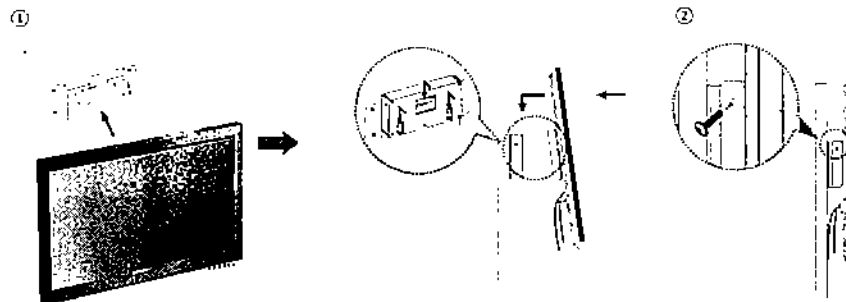

APPENDIX

Installing the Wall Mount Kit (LN-R329D, LN-R409D, LN-R469D)

*Note: This installation is to be used when attaching the wall mount to a wall.
When attaching to other building materials, please contact your nearest dealer.*

Components (Sold separately)

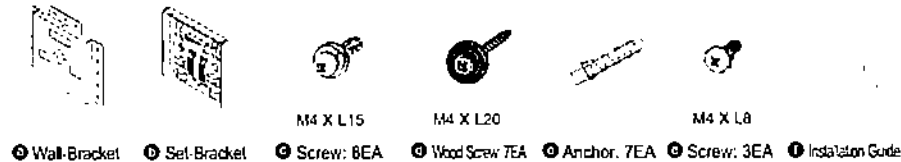

How to assemble the Wall Mount Bracket

- 1 ① Mark the location on the wall where the hole will be drilled.
 - ② Make over 35mm-depth-hole on the marked location using drill.
 - ③ Fix anchors ⑤ on each hole on the wall.
 - ④ Connect wall-bracket ① to the wall with wood screws ④ after filling anchors ⑤ into the wall-bracket ①.
- Note: If the bracket is not firmly fixed to the wall, LCD TV can fall off.*

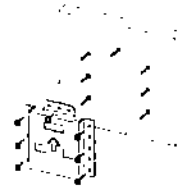

- 2 ① Turn the power off and unplug the power cord from the outlet.
- ② Place the TV faced down on a soft cloth or cushion on a table.
- ③ Attach the set-bracket ② onto the rear side of the TV set and secure the screws ⑥.

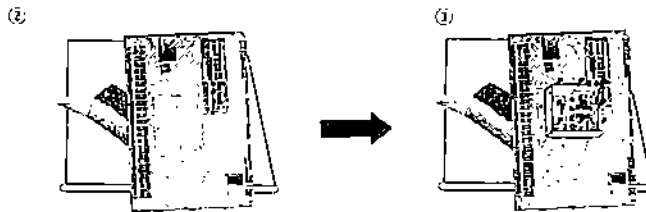

- 3 ① Insert three Hangers of the set-bracket ② into the grooves of the wall-bracket ①.
 - ② Fix set-bracket ② and wall-bracket ① with screws ⑦.
- Note: Before installing the set on the wall, connect the cables to the set first.*

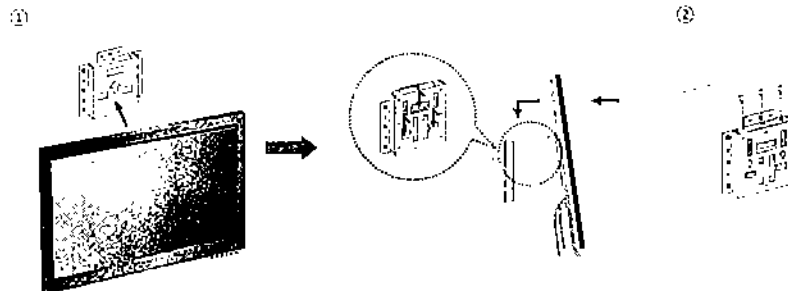

APPENDIX

Using the Anti-Theft Kensington Lock

The Kensington lock is a device used to physically fix the system when using it in a public place. The locking device has to be purchased separately. The appearance and locking method may differ from the illustration depending on the manufacturer. Please refer to the manual provided with the Kensington lock for proper use.

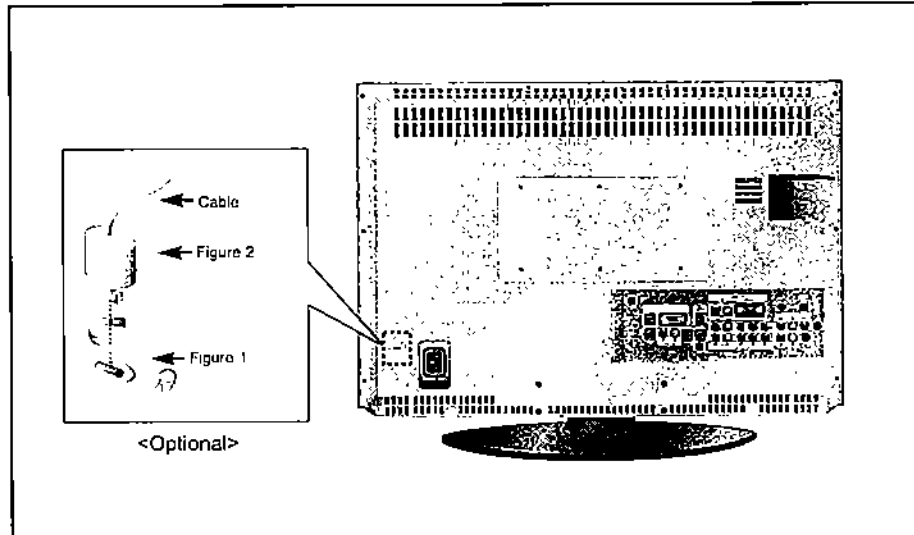

1. Insert the locking device into the Kensington slot on the LCD TV (Figure 1), and turn it in the locking direction (Figure 2).
2. Connect the Kensington lock cable.
3. Fix the Kensington lock to a desk or a heavy stationary object.

Using Your TV in Another Country

If you plan to take your TV with you to a foreign country, please be aware of the different television systems that are in use around the world. A TV designed for one system may not work properly with another system due to differences in the TV channel frequencies.

APPENDIX

CableCARD and Digital Cable Ready TVs

CableCARD and Digital Cable Ready TVs are the products of a new digital cable standard. This new standard is called OpenCable and it is a concerted effort to standardize the digital cable service network interface in North America. For more information, please refer to www.cablelabs.com.

Digital Cable Ready TVs are equipped with a proper digital cable tuner to receive digital cable signals from your local cable service provider. They are also designed to work with digital cable card modules (PCMCIA card modules called CableCARDS). These PCMCIA card modules or CableCARDS will be provided by your local cable service provider after a proper subscription process.

The provided CableCARD from your local cable service provider needs to be inserted into the CableCARD slot of a Digital Cable Ready TV. Please refer to page 26 for how to insert the CableCARD. A digital Set-Top Box which used to be provided by the cable service provider is no longer needed with Digital Cable Ready TVs and CableCARDS.

When the CableCARD is inserted into the slot, the TV screen will show a message that CableCARD is inserted and necessary data such as channel information or subscription information will be downloaded from your digital cable service provider. When you insert CableCARD for the first time, this process may take few minutes depending on the amount of data your cable provider needs to send. During this process, the digital cable service provider or CableCARD may display messages on the TV screen to help or give you further information.

Please contact your local cable provider for more information on service availability and how to acquire a CableCARD.

Note

- This television receiver supports the copy protection system regulated by DTLA (Digital Transmission Licensing Administrator). It should be noted that copy protected content may not be viewable depending on your particular connections.
- Some channels may be scrambled depending on your cable service provider. When you tune to these channels, no screen or a still screen may appear. In order to view the screen properly, you have to go through a subscription process after contacting your service provider. It will take several minutes to update the channel information depending on your cable service provider.

APPENDIX

Specifications

Model	LN-R269D	LN-R329D
Panel		
Size	26 inch	32 inch
Display Size(HXV)	22.67 (H) X 12.74 (V) inches (575.77 (H) X 323.71 (V) mm)	27.47 (H) X 15.44 (V) inches (697.68 (H) X 392.26 (V) mm)
Type	a-si TFT active matrix	a-si TFT active matrix
Pixel Pitch	0.017 (H) X 0.017 (V) inches (0.511 (H) X 0.511 (V) mm)	0.017 (H) X 0.017 (V) inches (0.511 (H) X 0.511 (V) mm)
Viewing Angle	170/170 (H/V)	170/170 (H/V)
Resolution	1366(H) X 768(V)	1366(H) X 768(V)
Frequency		
Horizontal	30 ~ 60 kHz	30 ~ 60 kHz
Vertical	60 ~ 75 Hz	60 ~ 75 Hz
Display Color	16,777,216 colors	16,777,216 colors
PC Resolution		
Maximum mode	1360 x 768 @ 60 Hz	1360 x 768 @ 60 Hz
Optimum mode	1360 x 768 @ 60 Hz	1360 x 768 @ 60 Hz
Input Signal		
Sync Signal	H/V Separate, TTL, P, or N.	H/V Separate, TTL, P, or N.
Video Signal	0.7 Vp-p @ 75ohm	0.7 Vp-p @ 75ohm
TV		
Video System	NTSC(Analog), ATSC(Digital)	NTSC(Analog), ATSC(Digital)
Sound System	STEREO(MTS)	STEREO(MTS)
Video		
Color System	NTSC	NTSC
Video System	CVBS, S-VHS	CVBS, S-VHS
Component		
Video In	10. Vp-p @ 75ohm	10. Vp-p @ 75ohm
Audio In	500mVrms	500mVrms
Power Supply		
Input	AC 110V~120V (60Hz)	AC 110V~120V (60Hz)
Power Consumption		
Normal		
Power Saving	<3W	<3W
Dimensions(W X D X H)		
Unit: body		
With Stand		
Weight		
With Stand		
Environmental Considerations		
Operating Temperature	50°F to 104°F (10°C to 40°C)	50°F to 104°F (10°C to 40°C)
Operating Humidity	10% to 80%, non-condensing	10% to 80%, non-condensing
Storage Temperature	-1°F to 113°F (-20°C to 45°C)	-1°F to 113°F (-20°C to 45°C)
Storage Humidity	5% to 95%, non-condensing	5% to 95%, non-condensing
Audio Characteristics		
Audio Input 1	RCA jack (L, R), 0.5Vrms (-9dB)	RCA jack (L, R), 0.5Vrms (-9dB)
Audio Input 2	3.5σ Stereo Jack, 0.5Vrms (-9dB)	3.5σ Stereo Jack, 0.5Vrms (-9dB)
Headphone Output	Max. 10mW Output(3.5σ Stereo jack 32Ω)	Max. 10mW Output(3.5σ Stereo jack 32Ω)
Frequency	RF: 80Hz ~ 15kHz (at- 3dB)	RF: 80Hz ~ 15kHz (at- 3dB)
Response	A/V: 80Hz ~ 20kHz (at- 3dB)	A/V: 80Hz ~ 20kHz (at- 3dB)

Model	LN-R409D	LN-R469D
Panel		
Size	40 inch	46 inch
Display Size(HXV)	34.84 (H) X 19.59 (V) inches (885.17 (H) X 497.67 (V) mm)	40.09 (H) X 22.54 (V) inches (1018.353 (H) X 572.544 (V) mm)
Type	a-si TFT active matrix	a-si TFT active matrix
Pixel Pitch	0.0255 (H) X 0.0085 (V) inches (0.648 (H) X 0.216 (V) mm)	0.0293 (H) X 0.0097 (V) inches (0.7455 (H) X 0.2485 (V) mm)
Viewing Angle	170/170 (H/V)	170/170 (H/V)
Resolution	1366(H) X 768(V)	1366(H) X 768(V)
Frequency		
Horizontal	30 ~ 60 kHz	30 ~ 60 kHz
Vertical	60 ~ 75 Hz	60 ~ 75 Hz
Display Color	16,777,216 colors	16,777,216 colors
PC Resolution		
Maximum mode	1360 x 768 @ 60 Hz	1360 x 768 @ 60 Hz
Optimum mode	1360 x 768 @ 60 Hz	1360 x 768 @ 60 Hz
Input Signal		
Sync Signal	H/V Separate, TTL, P. or N.	H/V Separate, TTL, P. or N.
Video Signal	0.7 Vp-p @ 75ohm	0.7 Vp-p @ 75ohm
TV		
Video System	NTSC(Analog), ATSC/QAM(Digital)	NTSC(Analog), ATSC/QAM(Digital)
Sound System	STEREO(MTS)	STEREO(MTS)
Video		
Color System	NTSC	NTSC
Video System	CVBS, S-VHS	CVBS, S-VHS
Component		
Video In	10. Vp-p @ 75ohm	10. Vp-p @ 75ohm
Audio In	500mVrms	500mVrms
Power Supply		
Input	AC 110V~120V (60Hz)	AC 110V~120V (60Hz)
Power Consumption		
Normal	285W	
Power Saving	<20W	<20W
Dimensions(W X D X H)		
Unit: body		
With Stand		
Weight		
With Stand		
Environmental Considerations		
Operating Temperature	50°F to 104°F (10°C to 40°C)	50°F to 104°F (10°C to 40°C)
Operating Humidity	10% to 80%, non-condensing	10% to 80%, non-condensing
Storage Temperature	-4°F to 113°F (-20°C to 45°C)	-4°F to 113°F (-20°C to 45°C)
Storage Humidity	5% to 95%, non-condensing	5% to 95%, non-condensing
Audio Characteristics		
Audio Input 1	RCA jack (L, R), 0.5Vrms (-9dB)	RCA jack (L, R), 0.5Vrms (-9dB)
Audio Input 2	3.5φ Stereo Jack, 0.5Vrms (-9dB)	3.5φ Stereo Jack, 0.5Vrms (-9dB)
Headphone Output	Max. 10mW Output(3.5φ Stereo jack 32Ω)	Max. 10mW Output(3.5φ Stereo jack 32Ω)
Frequency	RF: 80Hz ~ 15kHz (at- 3dB)	RF: 80Hz ~ 15kHz (at- 3dB)
Response	A/V: 80Hz ~ 20kHz (at- 3dB)	A/V: 80Hz ~ 20kHz (at- 3dB)

* Referring to Display Modes, page 121.

APPENDIX

Display Modes

If the signal from the system equals the standard signal mode, the screen is adjusted automatically. If the signal from the system doesn't equal the standard signal mode, adjust the mode by referring to your videocard user guide; otherwise there may be no video. For the display modes listed below, the screen image has been optimized during manufacture.

Mode	Resolution	Horizontal Frequency (kHz)	Vertical Frequency (Hz)	Pixel Clock Frequency (MHz)	Sync Polarity (H/V)
IBM	640 X 350	31.469	70.086	25.175	+ / -
	720 X 400	31.469	70.087	28.322	- / +
	640 X 480	31.469	59.940	25.175	- / -
VESA	640 X 480	35.000	70.000	28.560	- / -
	640 X 480	37.861	72.809	31.500	- / -
	640 X 480	37.500	75.000	31.500	- / -
	800 X 600	37.879	60.317	40.000	+ / +
	800 X 600	48.077	72.188	50.000	+ / +
	800 X 600	46.875	75.000	49.500	+ / +
	800 X 600	43.750	70.000	45.500	- / -
	1024 X 768	48.363	60.004	65.000	- / -
	1024 X 768	56.476	70.069	75.000	- / -
	1024 X 768	56.672	72.000	78.434	- / -
	1024 X 768	60.023	75.029	78.750	+ / +
1360 X 768	47.712	60.015	85.800	+ / +	