



# PLASMA DISPLAY

---

Owner's Instructions

HP-R4252



This device is a Class B digital apparatus.

Register your product at [www.samsung.com](http://www.samsung.com)

# Important Warranty Information Regarding Television Format Viewing

Wide screen format PDP Displays (16:9, the aspect ratio of the screen width to height) are primarily designed to view wide screen format full-motion video. The images displayed on them should primarily be in the wide screen 16:9 ratio format, or expanded to fill the screen if your model offers this feature and the images are constantly moving. Displaying stationary graphics and images on screen, such as the dark side-bars on nonexpanded standard format television video and programming, should be limited to no more than 5% of the total television viewing per week.

Additionally, viewing other stationary images and text such as stock market reports, video game displays, station logos, web sites or computer graphics and patterns, should be limited as described above for all televisions. ***Displaying stationary images that exceed the above guidelines can cause uneven aging of PDP Displays that leave subtle, but permanent burned-in ghost images in the PDP picture. To avoid this, vary the programming and images, and primarily display full screen moving images, not stationary patterns or dark bars.***

On PDP models that offer picture sizing features, use these controls to view different formats as a full screen picture.

Be careful in the selection and duration of television formats used for viewing. Uneven PDP aging as a result of format selection and use, as well as burned-in images, are not covered by your Samsung limited warranty.

## User Instructions

### ○ Screen Image retention

Do not display a still image (such as on a video game) on the plasma display panel for more than several minutes as it can cause screen image retention. This image retention is also known as "screen burn". To avoid such image retention, refer to page 52 of this manual to reduce the degree of brightness and contrast of the screen when displaying a still image.

### ○ Altitude

The PDP will not operate normally at altitudes above 6500 ft.

### ○ Heat on the top of the PDP TV

The top side of the product may be hot after long periods of use as heat dissipates from the panel through the vent hole in the upper part of the product.

This is normal and does not indicate any defect or operation failure of the product. However, children should be prevented from touching the upper part of the product.

### ○ The product is making a 'cracking' noise.

A 'cracking' noise may occur when the product contracts or expands due to a change of surrounding environment such as temperature or humidity. This is normal and not a defect of the unit.

### ○ Cell Defects

The PDP uses a panel consisting of 1,230,000(SD-level) to 3,150,000(HD-level) pixels which require sophisticated technology to produce. However, there may be few bright or dark pixels on the screen. These pixels will have no impact on the performance of the product.

### ○ Avoid operating the TV at temperatures below 5°C(41°F)

### ○ A still image displayed too long may cause permanent damage to the PDP Panel.

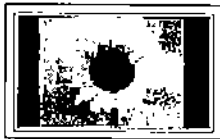

Watching the PDP TV in 4:3 format for a long period of time may leave traces of borders displayed on the left, right and center of the screen caused by the difference of light emission on the screen.

Playing a DVD or a game console may cause similar effect to the screen. Damages caused by the above effect are not covered by the Warranty.

### ○ Afterimage on the Screen.

Displaying still images from Video games and PC for longer than a certain period of time may produce partial afterimages.

To prevent this effect, reduce the 'brightness' and 'contrast' when displaying still images for a long time.

### ○ Warranty

Warranty does not cover any damage caused by image retention. Burn-in is not covered by the warranty.

# CableCARD and Digital Cable Ready TVs

CableCARD and Digital Cable Ready TVs are the products of a new digital cable standard. This new standard is called OpenCable and it is a concerted effort to standardize the digital cable service network interface in North America. For more information, please refer to [www.cablelabs.com](http://www.cablelabs.com).

Digital Cable Ready TVs are equipped with a proper digital cable tuner to receive digital cable signals from your local cable service provider. They are also designed to work with digital CableCARD modules (PCMCIA card modules called CableCARDS). These PCMCIA card modules or CableCARDS will be provided by your local cable service provider after a proper subscription process.

The provided CableCARD from your local cable service provider needs to be inserted into the CableCARD slot of a Digital Cable Ready TV. Please refer to page 25 for how to insert the CableCARD.

A digital set-top box which used to be provided by the cable service provider is no longer needed with Digital Cable Ready TVs and CableCARDS.

When the CableCARD is inserted into the slot, the TV screen will show a message that CableCARD is inserted and necessary data such as channel information or subscription information will be downloaded from your digital cable service provider. When you insert CableCARD for the first time, this process may take few minutes depending on the amount of data your cable provider needs to send. During this process, the digital cable service provider or CableCARD may display messages on the TV screen to help or give you further information.

Please contact your local cable provider for more information on service availability and how to acquire a CableCARD.

## **Notes**

- This television receiver supports the copy protection system regulated by DTLA (Digital Transmission Licensing Administrator). It should be noted that copy protected content may not be viewable depending on your particular connections.
- Some channels may be scrambled depending on your cable service provider. When you tune to these channels, no screen or a still screen may appear. In order to view the screen properly, you have to go through a subscription process after contacting your service provider. It will take several minutes to update the channel information depending on your cable service provider.

## Q&A

### **1. Is the antenna I use for existing TV reception good enough for DTV?**

Over-the-air (OTA) digital TV broadcasting uses the same channels as analog TV and works well with many existing TV antennas. However, DTV broadcast channel assignments are different than analog channels. You should find out whether your local DTV broadcasts are on VHF (channels 2-13) or UHF (channels 14-69) to see if you need a different antenna.

If your DTV channels are on UHF and you already get good UHF reception, your present antenna may work fine. The same holds true for VHF DTV reception. Note that in some markets, both VHF and UHF channels are used for DTV broadcasts.

You can find out the latest DTV channel assignments for your area by browsing selected Internet web sites such as [www.titantv.com](http://www.titantv.com) and [www.fcc.gov](http://www.fcc.gov).

### **2. How difficult is it to receive DTV signals indoors?**

This depends on whether your local DTV stations are running full power or not and how close your location is to the transmission tower. DTV receivers do not require as much signal as analog TV receivers to produce high-quality images and sound.

Once the DTV signal level exceeds a certain threshold at the receiver, the digital video and audio data is decoded at the same quality it was originally encoded for broadcast. This is a big advantage for DTV over analog TV - there is no noise, ghosting, static, or scratchy audio.

### **3. How can I connect an antenna in my townhouse, co-operative apartment, condominium, or apartment?**

The Federal Communications Commission's OTARD Rule (part of the Telecommunications Act of 1996) allows residents of condominiums, townhouse, or members of neighborhood associations to put up outside antennas for reception of broadcast TV signals as long as those antennas are not located in common areas and are no more than 12' in height.

Residents of rental units (apartments, etc.) are not covered by the OTARD rules and will have to use indoor antennas to receive DTV broadcasts. It is possible that the landlord of an apartment complex can provide broadcast DTV signals via a master TV antenna system to each apartment.

### **4. Can I connect my DTV set-top receiver to my cable TV service?**

Cable TV systems use a different method for transmitting digital TV programs that is currently incompatible with broadcast DTV set-top receivers. So you will still need to use an outdoor or indoor antenna to receive OTA broadcast DTV programs.

The good news is that you won't have to pay a monthly or per-program charge to watch OTA DTV and HDTV programs. They're free, unlike subscription satellite TV or premium cable TV. All you need is an antenna and a DTV set-top receiver to enjoy clear, sharp widescreen images and high-quality audio.

# Table of Contents

## General Information

Your New Plasma Display Panel.....	10
Remote Control Buttons .....	13
Wall Installation Instructions .....	15
How to assemble the Stand-Base .....	19

## Connections

Connecting VHF and UHF Antennas .....	22
Connecting Cable TV .....	23
Connecting CableCARD .....	25
Connecting a VCR .....	26
Connecting a Camcorder .....	27
Connecting a DVD Player .....	28
Connecting a DTV Receiver .....	29
Connecting to HDMI (High Definition Multimedia Interface) .....	30
Connecting a Digital TV Set-Top Box.....	31
Connecting a Digital Audio System .....	32
Connecting to an Analog Amplifier .....	33

## Operation

Turning the TV On and Off .....	36
Viewing the Menus and Displays .....	40
Memorizing the Channels .....	41
Adding and Erasing Channels .....	44
Setting Up Your Remote Control .....	47
Viewing an External Signal Source .....	49

## Picture Control

Customizing the Picture .....	52
Using Automatic Picture Settings.....	53
Selecting the Color Tone .....	54
DNLe (Digital Natural Image engine) Demo.....	55
Changing the Screen Size .....	56
Viewing the Picture-in-Picture.....	58
Selecting the Sound Source .....	64
Setting the My Color Control Mode.....	65
Using the Dynamic Contrast .....	69

## Sound Control

Customizing the Sound .....	72
Using Automatic Sound Settings .....	73
Setting the TruSurround XT.....	74
Choosing a Multi-Channel Sound (MTS) track · Digital .....	75
Choosing a Multi-Channel Sound (MTS) track · Analog .....	76
Using the Auto Volume .....	77
Choosing a Digital Sound Format.....	78
Setting the On/Off Melody .....	79
Selecting the Internal Mute .....	80

## Channel Control

Selecting the Antenna .....	82
Selecting Your Favorite Channels .....	83
Labeling the Channels.....	84
Viewing the Channel Lists .....	85
Editing the Channel Lists .....	86
Fine Tuning Analog Channels .....	87
Checking the Digital-Signal Strength .....	88
LNA (Low Noise Amplifier) .....	89

# Plasma Display

## Connecting a PC and Operation

Connecting a PC .....	92
Changing the Position of the Image .....	96
Picture Quality Adjustment.....	97
Image Reset .....	100

## Time Setting

Setting the Clock .....	102
Setting the Sleep Timer .....	104
Setting the On/Off Timer.....	105

## Function Description

Selecting a Menu Language .....	108
Digital Noise Reduction.....	109
Selecting the Film Mode .....	110
Setting the Blue Screen .....	111
Using the Color Weakness Enhancement Option..	112
Viewing Closed Captions (On-Screen Text Messages) - Analog .....	113
Viewing Closed Captions (On-Screen Text Messages) - Digital.....	114
Menu Transparency Level .....	116
Using the Energy Saving feature .....	117
Preventing Screen Burn-in .....	118
Setting the Function Help.....	120
Using the V-Chip .....	121
Electronic Program Guide .....	127
Reminder List .....	131
Using the CableCARD.....	133
Using the CableCARD Setup Function .....	134

## Appendix

Troubleshooting .....	138
Care and Maintenance .....	139
Specifications.....	140
Dimension .....	141

### **Note**

- The information contained in this User's Manual is subject to change without prior notice for improvement, and may vary depending on the version of the TV's software and the regional conditions.





P L A S M A   D I S P L A Y   P A N E L

# General Information



Your New Plasma Display Panel .....	10
Remote Control Buttons .....	13
Wall Installation Instructions .....	15
How to assemble the Stand-Base.....	19



# Your New Plasma Display Panel

## Front Panel

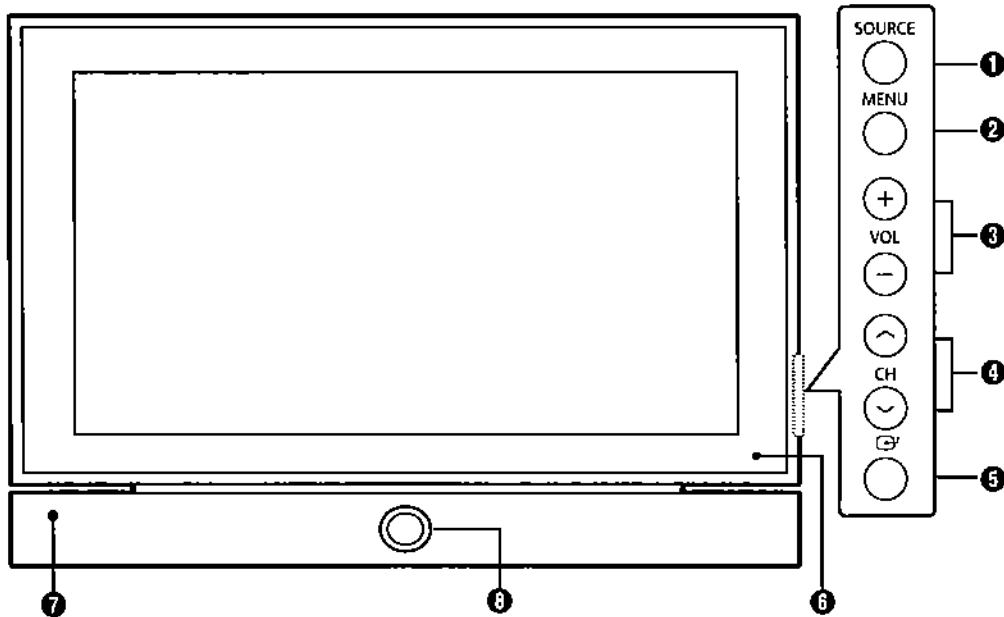

**1 SOURCE button**  
Press to display all of the available video sources (TV, AV, S-VIDEO, COMPONENT1, COMPONENT2, PC, and HDMI).

**2 MENU button**  
Displays the main on-screen menu.

**3 VOL +, - buttons**  
Press to increase or decrease the volume.  
Also used to select or adjust items on the on-screen menu.

**4 CH(^, v) buttons**  
Press CH^ or CHv to change channels.  
Also used to move up or down in the on-screen menu.

**5 (Enter) button**  
Press to confirm a selection.

**6 Remote Control Sensor**  
Aim the remote control towards this spot on the TV.

**7 Speakers**

**8 Power button**  
Press to turn the TV on and off

Power indicator  
- Power Off : Blue  
- Power On : Off

# Plasma Display

## Checking Accessories

Once you have unpacked your TV, check to make sure that you have all the parts shown here. If any piece is missing or broken, call your dealer.



Owner's Instructions

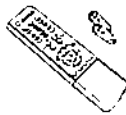

Remote Control / AAA Batteries  
(BN59-00443A)



Ferrite Core for Digital Audio Out (Coaxial)  
(3301-001201)



Ferrite Core for Speaker cable  
(3301-001502)



Power Cord  
(3903-000144)



Antenna Cable  
(BN39-00333A)



Anynet Cable  
(BN39-00333A)

## Sold Separately



S-VIDEO Cable  
(AA39-40001E)



HDMI Cable  
(BN39-00072A)



HDMI-to-DVI Cable  
(AA39-00033A)



Component Cables (RCA)  
(AA39-00033A)



PC Cable



PC Audio Cable



Optical Cable



Coaxial Cable

## Rear Panel

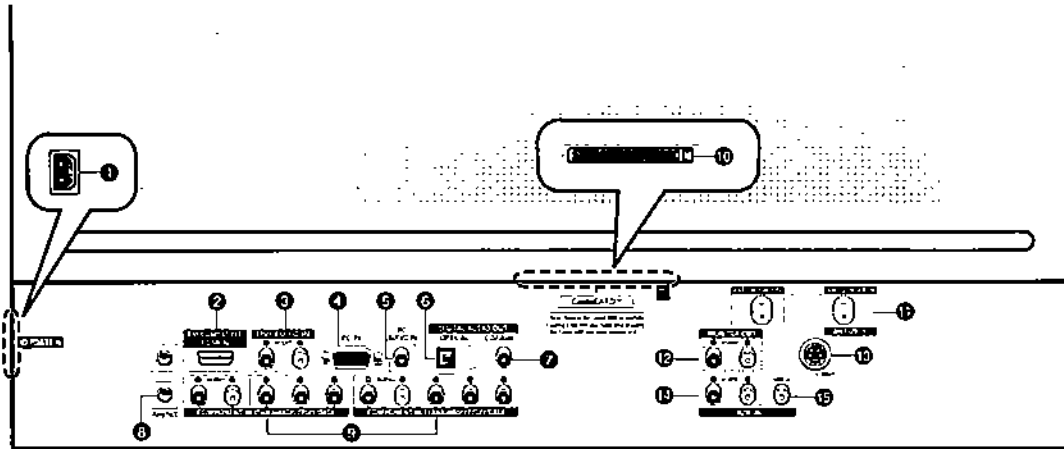

- 1 POWER IN**  
Connect the supplied power cord.
- 2 DVI COMPATIBLE HDMI IN**  
Connect to the HDMI jack of a device with HDMI output.
- 3 DVI AUDIO IN (R-AUDIO-L)**  
Connect to the digital video and audio output jack of a device with DVI output.
- 4 PC IN**  
Connect to the video output jack on your PC.
- 5 PC AUDIO IN**  
Connect to the audio output jack on your PC.
- 6 OPTICAL DIGITAL AUDIO OUT**  
Connect to a Digital Audio component.
- 7 COAXIAL DIGITAL AUDIO OUT**  
Connect to a Digital Audio component.
- 8 Anynet**  
Please refer to the Anynet Owner's Instruction. This jack is for repair and software upgrades.
- 9 COMPONENT IN 1, 2**  
Video (Y/Pb/Pr) and audio (L-AUDIO-R) inputs for component.
- 10 CableCARD™**  
Insert the CableCARD into the slot.
- 11 ANT (75Ω)**  
75Ω Coaxial connector for Antenna/Cable Network.
- 12 MONITOR OUT**  
Outputs for external devices.
- 13 S-VIDEO**  
Video inputs for external devices with an S-Video output, such as a camcorder or VCR.
- 14 A/V IN (R-AUDIO-L)**  
Audio inputs for external devices, such as a camcorder or VCR.
- 15 VIDEO**  
Video inputs for external devices, such as a camcorder or VCR.

# Plasma Display



## Remote Control Buttons

### Remote Control

- 1 POWER button**  
Turns the TV on and off.
- 2 GUIDE button**  
Press to display the on-screen Electronic Program Guide (EPG).
- 3 ANTENNA button**  
Press to select "Air" or "Cable".
- 4 Number buttons**
- 5 - button**  
Press to select additional channels (digital and analog) being broadcast by the same station. For example, to select channel "54-3", press "54", then press "-" and "3".
- 6 MUTE button**  
Press to mute the TV sound.
- 7 VOL (Volume) buttons**  
Use it to adjust volume.
- 8 Anynet button**  
Runs the Anynet view functions and sets up Anynet devices.
- 9 MENU button**  
Displays the main on-screen menu.
- 10 ENTER button**  
Confirms a selection.
- 11 FAV.CH button**  
Press to switch to your favorite channels.
- 12 CH LIST button**  
Displays the channel list.
- 13 MODE button**  
Selects a target device to be controlled by the Samsung remote control (i.e., TV, STB, VCR, CABLE, or DVD).
- 14 PRE-CH button**  
Tunes to the previous channel.
- 15 SOURCE button**  
Press to display all of the available video sources (TV, AV, S-VIDEO, COMPONENT1, COMPONENT2, PC, and HDMI).
- 16 CH (Channel) buttons**  
Use it to switch channels.
- 17 INFO button**  
Press to display information on the TV screen.
- 18 EXIT button**  
Press to exit the menu.
- 19 Up/Down/Left/Right buttons**  
Control the cursor in the menu.

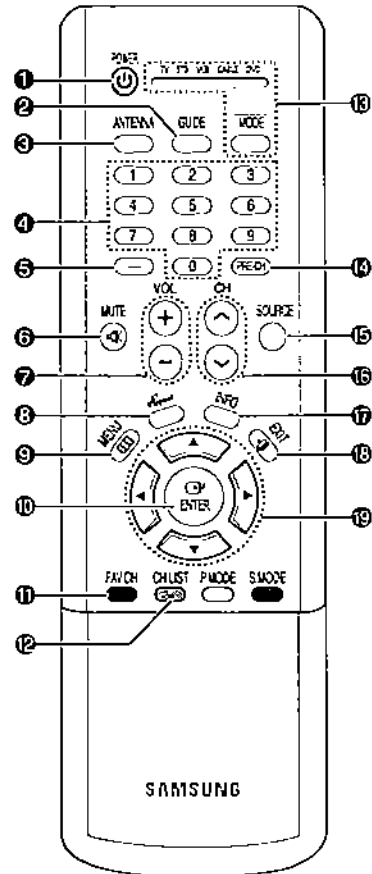

- 20 P.MODE button**  
Adjust the TV picture by selecting one of the preset factory settings (or select your personal, customized picture settings).
- 21 S.MODE button**  
Select Sound effect.
- 22 E.SAVING button**  
Press to adjust brightness of screen according to surround environment.
- 23 P.SIZE button**  
Select Picture size.
- 24 DNIE button**  
Activates DNIE (Digital Natural Image engine).
- 25 MTS button**  
Press to choose stereo, mono or Separate Audio Program (SAP broadcast).
- 26 SET button**  
Used during set up of this Samsung remote control, so that it will work compatibly with other devices (VCR, Cable Box and DVD).
- 27 PIP button**  
Activates picture in picture.
- 28 PIP control buttons**  
CH (▲, ▼): Displays the available channels in sequence.  
(These buttons change channels in the PIP window only.)
- 29 CAPTION button**  
Controls the caption decoder.
- 30 VCR, DVD control buttons**  
Controls VCR tape or DVD disc functions: Stop, Rewind, Play/Pause, and Fast Forward.
- 31 RESET button**  
If your remote control is not functioning properly, take out the batteries and press the reset button for about 2-3 seconds.  
Re-insert the batteries and try using the remote control again.

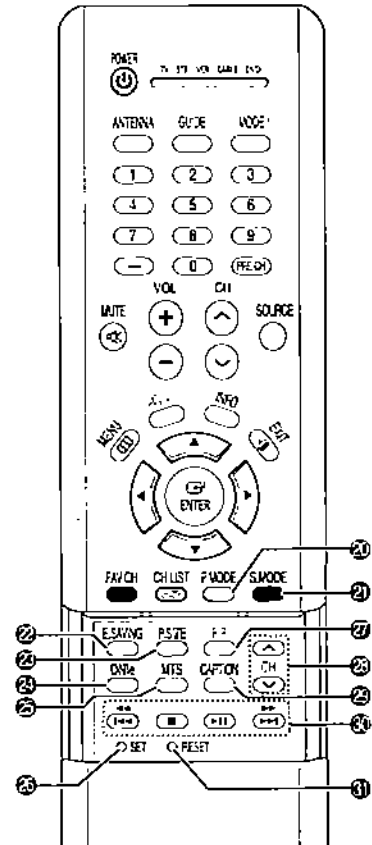

### Installing the Batteries in Your Remote Control

**1** Slide the back cover to open the battery compartment of the remote control.



**2** Install two AAA size batteries. Make sure to match the "+" and "-" ends of the batteries with the diagram inside the compartment.

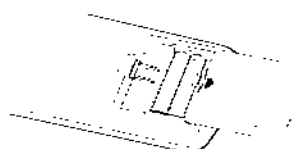

**3** Slide the cover back into place.

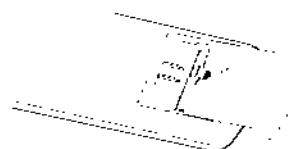



#### Remote Control Operation Range

You can use your remote control within a distance of 23 feet and an angle of 30 degrees from the left and right sides of the TV's remote control receiver.

# Plasma Display



## Wall Installation Instructions

### ○ Installation Notes

- 1 Do not install the TV on any location other than a vertical wall.
- 2 To protect the performance of the TV and prevent problems, avoid the following locations:
  - Do not install next to smoke and fire detectors.
  - Do not install in an area subjected to vibration or high voltage.
  - Do not install near or around any heating apparatus.
- 3 Use only recommended parts and components.

### ○ Parts (Wall attachment panel is sold separately. Check with your dealer.)

Wall Mount Bracket

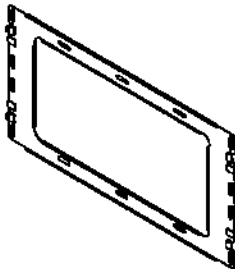

1EA

ASSY-HINGE



LEFT : 1EA    RIGHT : 1EA

Support Bars

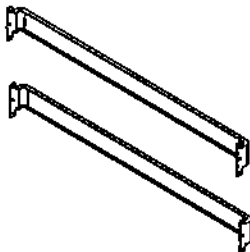

2EA

Screws



Insulation Holder :  
4EA



SCREWⓈ : 4EA



SCREWⓈ : 12EA

## ○ How to assemble the Wall Mount Bracket

- 1 The wall mount comes packaged in 3 parts. These parts must be assembled together. Please tighten the captive screws(4EA) in the direction of the arrow after assembling the bracket. Install the Wall Mount Bracket after the screws are securely inserted into the wall.

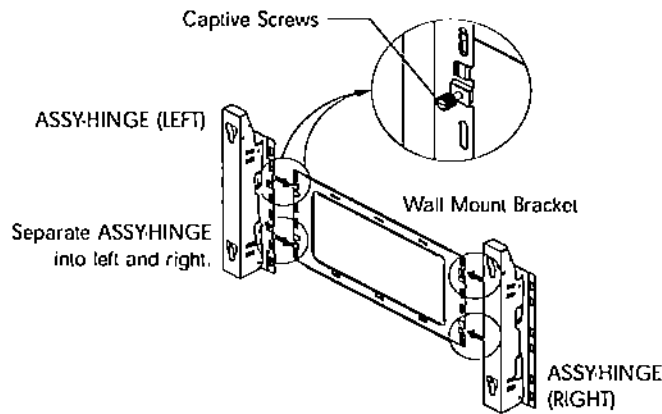

- 2 After installing the wall mount bracket, assemble the support bars and hinges (as illustrated) using screws provided. (12 screws(Ⓢ) are provided. For safety reasons, make sure all 12 screws are firmly attached.)

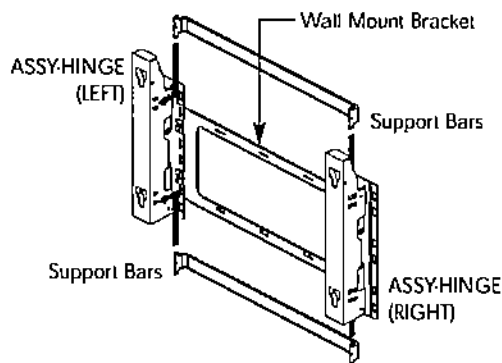

- 3 After securing the screws, be sure that every part is firmly attached (as shown in the illustration).

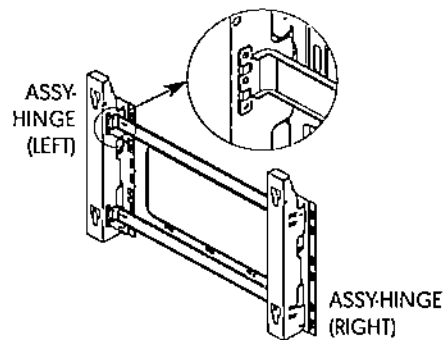



# Plasma Display

## ○ Fixing the TV panel to the wall attachment panel bracket

1 Remove the screws from the back of the TV.

1

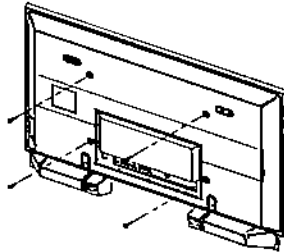

2 Connect insulation holders to screws (see the illustration below).

2

- If you are uncertain about installation, hire a specialist to install the wall mount bracket.
- Be sure to check that the insulation holders are completely secured on both the left and right side after hanging the TV on the wall mount bracket.
- Be careful to avoid getting your fingers caught during installation.
- Make sure the wall attachment panels are tightened. Otherwise the TV may fall.

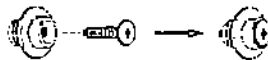

3 Tighten the screws of the insulation holders to the back of the TV.

3

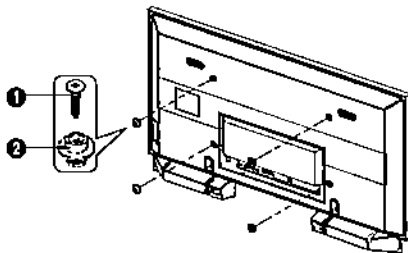

4 Put the 4 insulation holders on the TV in the grooves of the wall mount bracket and pull down on the TV (1) to secure it to the wall mount bracket (2). Tighten the screws as shown (3) so that the TV cannot be separated from wall mount bracket.

4

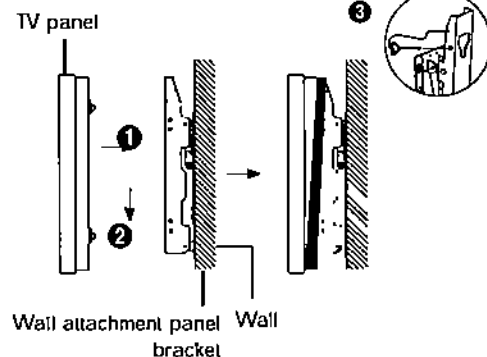

### **Note**

- A 5 inch(12.7 cm) gap is needed between the back of the Plasma TV and the wall.

## ○ How to Adjust Mounting Angle

**Note** : Please secure the mounting bracket on the wall surface after setting its angle at 0°.

### Factory default

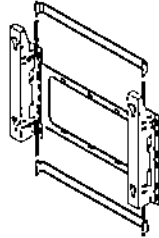

Please tighten the captive screw in the direction of the arrow after assembling the bracket.

### How to Adjust Mounting Angle

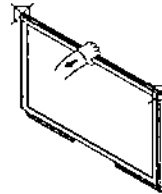

Hold onto the middle of the TV to adjust the angle (not the sides of the TV).

### Change Angle

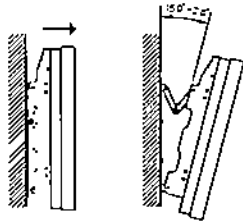

- 1 Secure the set to the wall mount bracket.  
(Please refer to the following instructions.)
- 2 Set the angle by pulling the upper end of the set attached to bracket in the direction of the arrow.
- 3 The angle can be adjusted from 0° to 15° by  $\pm 2^\circ$ .

### Connecting External Devices to the TV

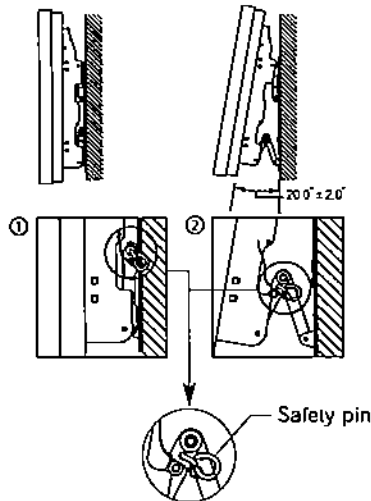

- 1 Be sure to remove the safety pins underneath the TV.  
(**Caution** : If the safety pins are not removed, the angle cannot be adjusted.) Any attempt to do so may cause damage to the TV.
- 2 Hold onto the bottom of the TV and pull forward fully as directed by the arrow(as illustrated) to adjust the angle. (0°~20° by 2°). Insert the safety pins to the front guide holes on both sides as illustrated in figure ②.
- 3 **Viewing the TV after connecting the external devices.** Remove the safety pins to adjust the angle to 0°, then secure the safety pins again. (**Warning** : For safety, be sure to secure the TV using the safety pins. If the safety pins are not used, the TV may fall, causing serious injury.)

### Notes

- Contact an authorized technician when installing the wall attachment panel.
- After hanging the TV panel on the wall attachment panel, make sure that the Insulation holders are completely hung.
- Be careful not to get your fingers caught during installation.
- Make sure the wall attachment panel brackets are tightened. Otherwise, the TV panel may fall down.
- Please secure the mounting bracket on the wall surface after setting its angle at 0°.

# Plasma Display



## How to assemble the Stand-Base

- 1 Firmly secure the pegs to the both sides of the stand base using 8 screws provided.

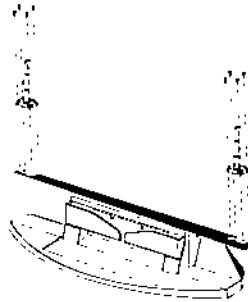

- 2 Using the 4 screws for securing the stand pegs and the monitor, firmly attach the monitor to the stand pegs. (The exterior of the set may be different than the picture.)

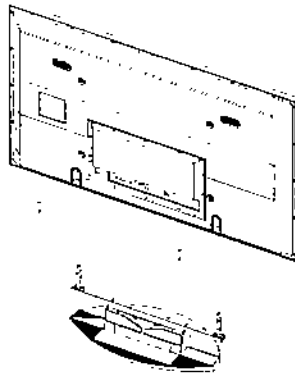

### Warning

Firmly secure the stand for the TV before moving it, as the stand may fall and could cause serious injury.

- Two or more people should carry the TV. Never lay the TV on the floor because of possible damage to the screen. Always store the TV upright.



P L A S M A   D I S P L A Y   P A N E L

# Connections

Connecting VHF and UHF Antennas .....	22
Connecting Cable TV.....	23
Connecting CableCARD.....	25
Connecting a VCR.....	26
Connecting a Camcorder .....	27
Connecting a DVD Player.....	28
Connecting a DTV Receiver .....	29
Connecting to HDMI (High Definition Multimedia Interface) .....	30
Connecting a Digital TV Set-Top Box .....	31
Connecting a Digital Audio System .....	32
Connecting to an Analog Amplifier .....	33



# Connecting VHF and UHF Antennas

## Antennas with 75-ohm Round Leads

If your antenna looks like this:  it has 75-ohm round leads.

- 1 Plug the antenna lead into the ANT 2 IN(AIR IN) on the TV.  
Use the antenna cable, an accessory included in the product package.





## Connecting Cable TV

You can connect different cable systems to your TV, including cable without a Cable box, and cable with a Cable box that descrambles some or all channels.

### Cable without a Cable Box

- 1 Plug the incoming cable into the ANT 1 IN(CABLE IN) on the TV.  
  
Use the antenna cable, an accessory included in the product package.

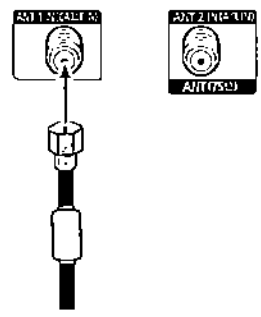

### Cable with a Cable Box that Descrambles All Channels

- 1 Find the cable connected to the ANTENNA OUT terminal on your Cable box. This terminal might be labeled "ANT OUT", "VHF OUT" or simply "OUT".

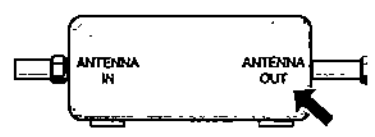

- 2 Connect the cable to the ANT 1 IN(CABLE IN) on the TV.  
  
Use the antenna cable, an accessory included in the product package.

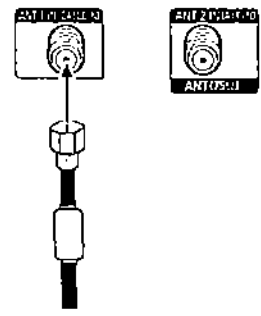

## Cable with a Cable Box that Descrambles Some (But Not All) Channels

To complete this connection you will need a two-way splitter, an RF (A/B) switch, and four coaxial cables (which you can buy from your Samsung dealer or any electronics store).

- 1 Find and disconnect the cable that is connected to the ANTENNA IN terminal of your Cable box. This terminal might be labeled "ANT IN", "VHF IN" or simply, "IN". Connect this cable to a two-way splitter.

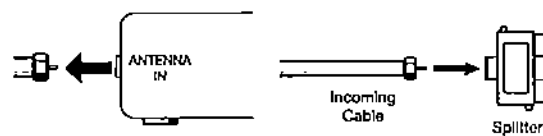

- 2 Connect a coaxial cable between an OUT terminal of the splitter and the IN terminal of the Cable box.

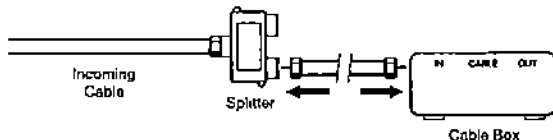

- 3 Connect a coaxial cable between the ANTENNA OUT terminal of the Cable box and the B-IN terminal of the RF (A/B) switch.

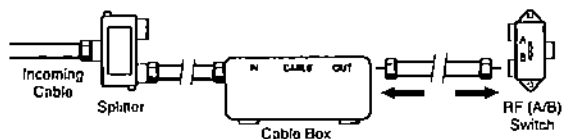

- 4 Connect a coaxial cable between the other OUT terminal of the Cable box and the A-IN terminal of the RF (A/B) switch.

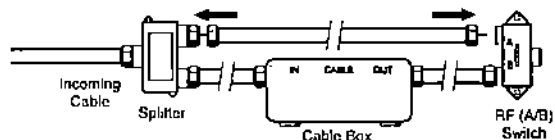

- 5 Connect the last coaxial cable between the OUT terminal of the RF (A/B) switch and the ANT 1 IN (CABLE IN) on the TV.

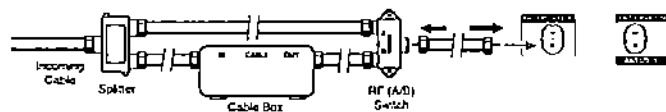

After you've made this connection, set the A/B switch to the "A" position for normal viewing. Set the A/B switch to the "B" position to view scrambled channels. (When you set the A/B switch to "B", you will need to tune your Set-Top Box to the Cable box's output channel, which is usually channel 3 or 4.)



# Plasma Display



## Connecting CableCARD

You must obtain a CableCARD from a local cable service provider.

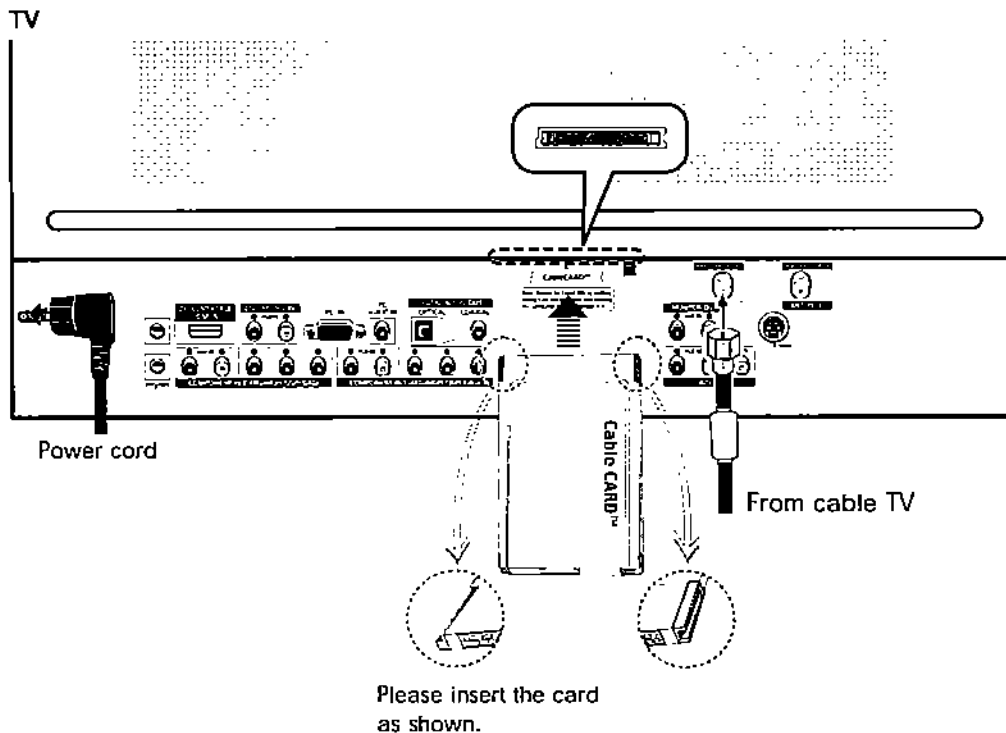

### How to Connect

- 1 Insert the CableCARD into the "CableCARD" slot and the message "CableCARD Inserted" is displayed on the screen. If the channel information does not exist, the message "Updating Channel List" is displayed during channel information configuration. It could take several minutes to update the channel information depending on your cable service provider.
- 2 The pairing information containing a telephone number, CableCARD ID, Host ID, and other information will be displayed in about 2-3 minutes. If an error message is displayed, please contact your service provider.
- 3 When the channel information configuration has finished, the message "Updating Completed" is displayed, indicating that the channel list is now updated.
- 4 The Channel list can now be displayed by pressing CH LIST button.

### Notes

- Once the channel list has been updated, only the channels on the channel list can be selected.
- Remove the Cablecard by carefully pulling it out with your hands since dropping the CableCARD may cause damage to it.



## Connecting a VCR

### Connecting a VCR to the Video or S-Video/Audio jack

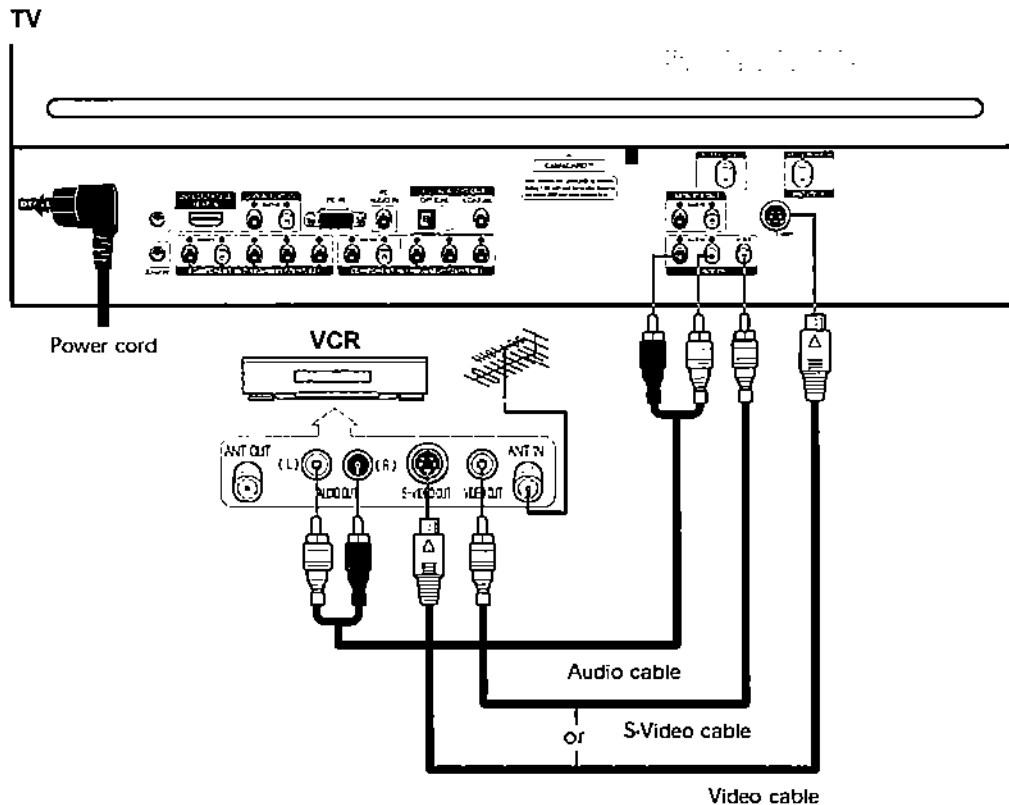

#### How to Connect

Connect the Video/Audio cables between the VIDEO or S-VIDEO/AUDIO input jacks on the TV and VIDEO or S-VIDEO/AUDIO output jacks on the VCR.  
(Note: For better video, use an S-Video cable.)

#### **Note**

- Please be sure to match the color coded input terminals and cable jacks.

#### **Videotape Playback:**

1. Turn on your TV.
2. Press the SOURCE button to select "Video" or "S-Video".
3. Turn on your VCR, insert a videotape and press the Play button.



# Connecting a Camcorder

## Viewing camcorder tapes

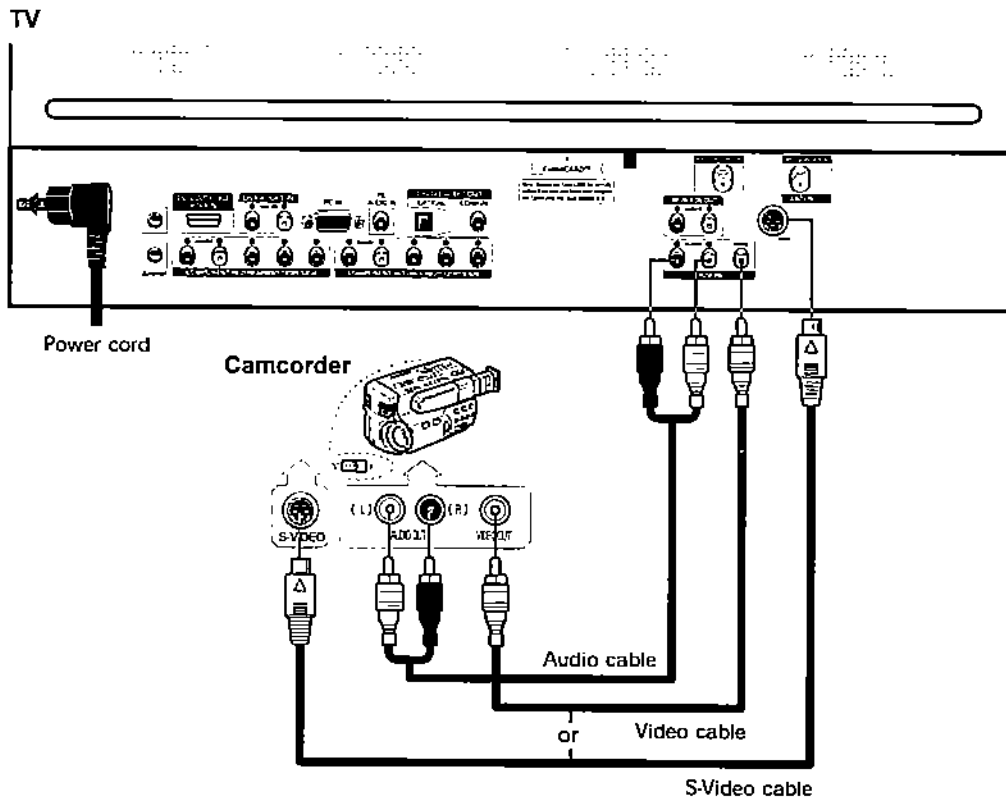

### How to Connect

Connect a Video/Audio cable between the VIDEO or S-VIDEO/AUDIO input jacks on the TV and the VIDEO or S-VIDEO/AUDIO output jacks on the camcorder.  
(Note: For better video, use an S-VIDEO cable.)

#### Note

- Please be sure to match the color coded input terminals and cable jacks.

#### Viewing Tapes

1. Turn on your TV.
2. Press the SOURCE button to select "Video" or "S-VIDEO".
3. Turn on your camcorder and set it to video mode. (For details, refer to your camcorder owner's instructions.)
4. Set the IN/OUT switch on your camcorder to OUT.
5. Insert the tape into the camcorder and press the Play button.



## Connecting a DVD Player (480i, 480p)

This TV displays the optimum picture in 720p mode.

### Playing DVD

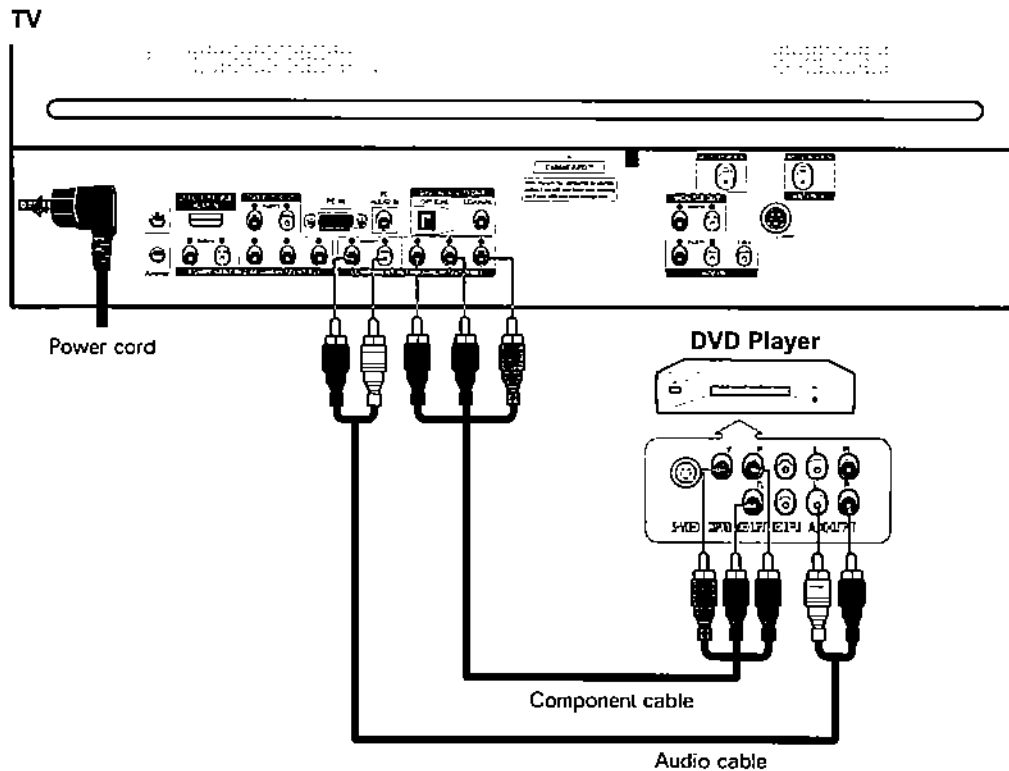

#### How to Connect

- 1 Connect the Y, Pb, Pr (COMPONENT1, 2) input jacks on the TV with Y, Pb, Pr output jacks on the DVD player using a component cable.
- 2 Connect the AUDIO L/R (COMPONENT1, 2) input jacks on the TV with the AUDIO output jacks on the DVD player using an audio cable.

#### **Note**

- Please be sure to match the color coded input terminals and cable jacks.

#### To Play DVD:

1. Turn on your TV.
2. Press the SOURCE button to select "Component 1" or "Component 2".
3. Turn on your DVD player, insert a DVD disc and press the Play button.
  - For an explanation of component video, see your DVD owner's instructions.

# PLASMA Display



## Connecting a DTV Receiver (480p, 720p, 1080i)

This TV displays the optimum picture in 720p mode.

### Watching DTV

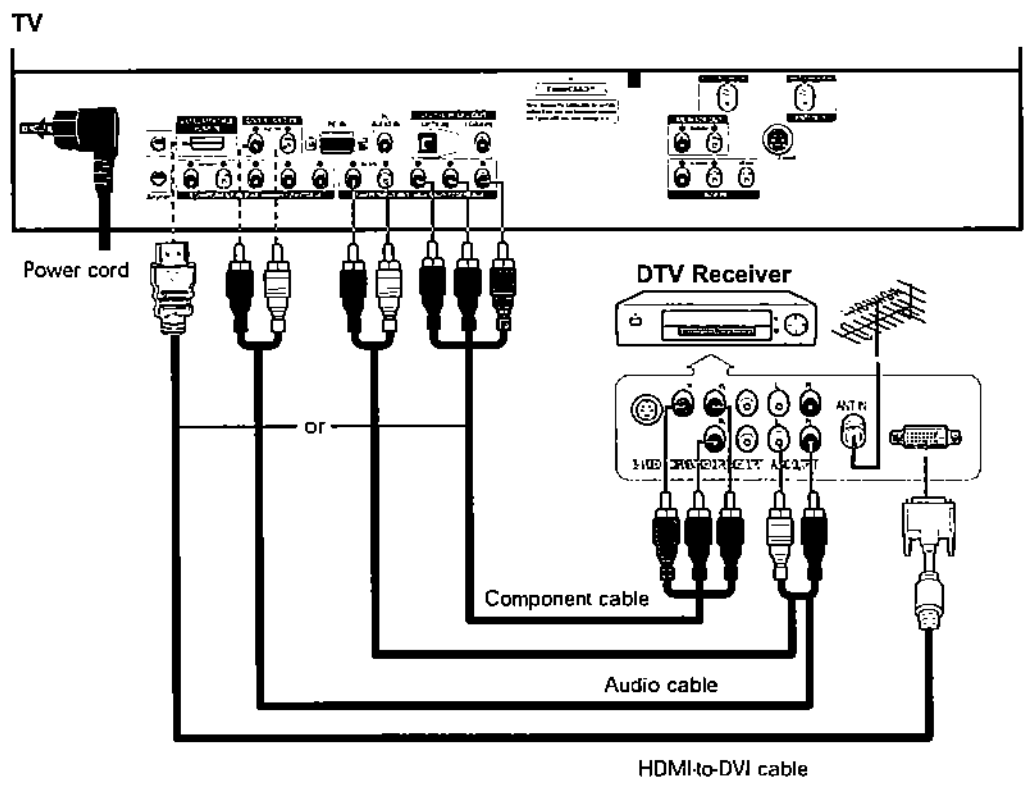

### How to Connect

- 1 Connect the cable or antenna to the antenna input jack on the DTV.
- 2 Connect the Y, Pb, Pr (COMPONENT1, 2) or HDMI input jack on the TV to the Y, Pb, Pr or DVI output jacks on the DTV receiver using a component or HDMI-to-DVI cable.
- 3 Connect the AUDIO L/R (COMPONENT1, 2 or DVI AUDIO IN) input jacks on the TV with the AUDIO output jacks on the DTV receiver using an audio cable.

#### Notes

- Please be sure to match the color coded input terminals and cable jacks.

#### To Watch DTV:

1. Turn on your TV.
2. Press the SOURCE button to select "Component 1", "Component 2", "HDMI".
3. Turn on your DTV receiver.
  - For an explanation of component video, see your DTV receiver owner's instructions.



## Connecting to HDMI (High Definition Multimedia Interface) (480p, 720p, 1080i)

### Watching DTV

TV

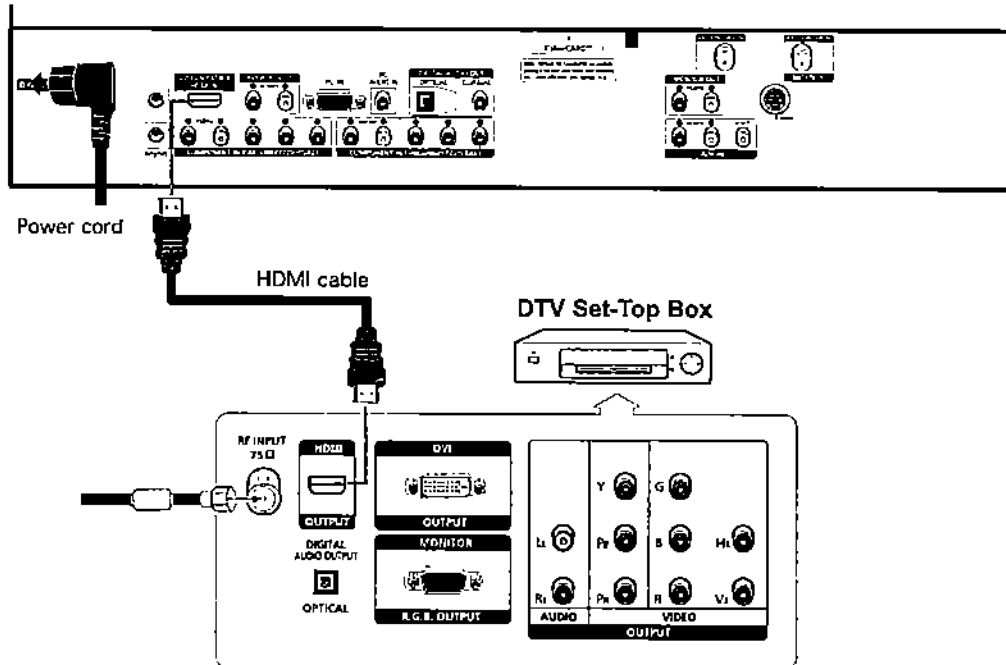

### How to Connect

- 1 Connect the cable or antenna to the antenna input jack on the DTV.
- 2 Connect the HDMI input jack on the TV with the HDMI output jack on the DTV Set-Top Box using a HDMI cable.

#### Notes

- Please make sure the HDMI source's power is on before selecting HDMI from the "Source List".

#### To Watch DTV:

1. Turn on your TV.
2. Press the SOURCE button to select "HDMI".
3. Turn on your DTV receiver.
  - For an explanation of HDMI video, see your DTV receiver owner's instructions.



## Connecting a Digital TV Set-Top Box (480p, 720p, 1080i)

By inputting a high-bandwidth digital content protection High-Definition picture source to the HDMI input jack on the TV, High-Definition pictures can be displayed on the screen in their digital form.

### Connecting to HDMI (High Definition Multimedia Interface)/DVI Compatible

TV

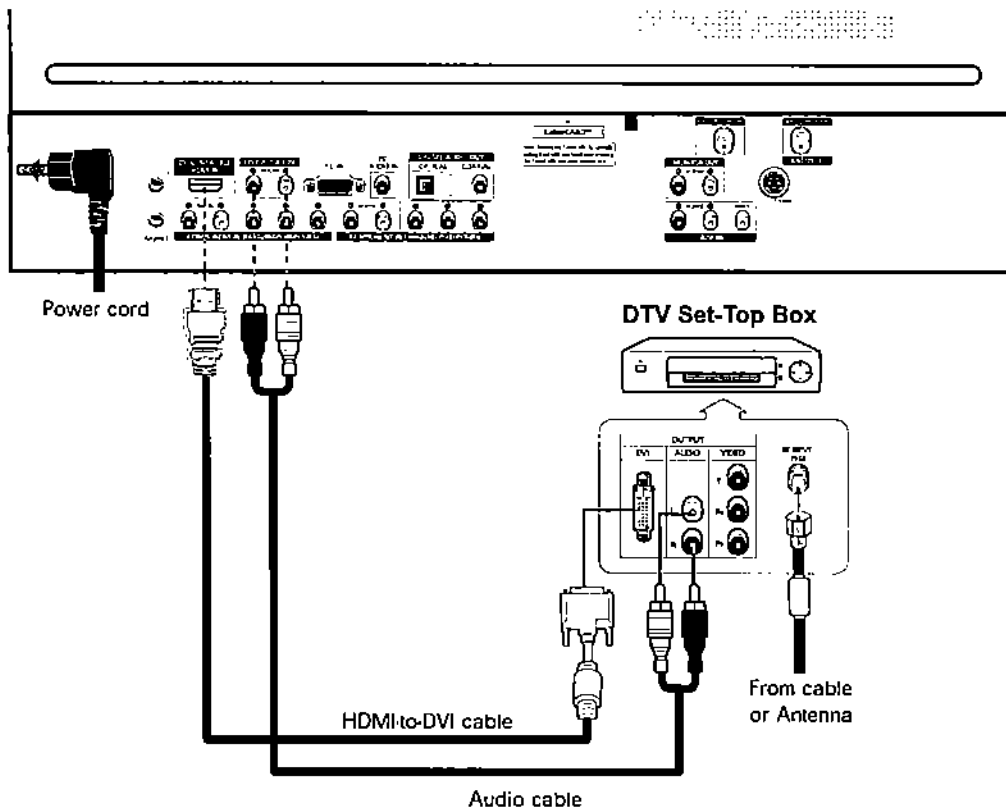

#### How to Connect

- 1 Connect the DVI AUDIO (L, R) input jacks on the TV with the AUDIO output jacks on the Set-Top Box using a audio cable.
- 2 Connect the HDMI input jack on the TV and the VIDEO output jack on the Set-Top Box using a HDMI-to-DVI cable.



# Connecting a Digital Audio System

There are many types of digital audio systems on the market today.

A simplified illustration of an audio system is shown below. For more information, see your audio system owner's manual.

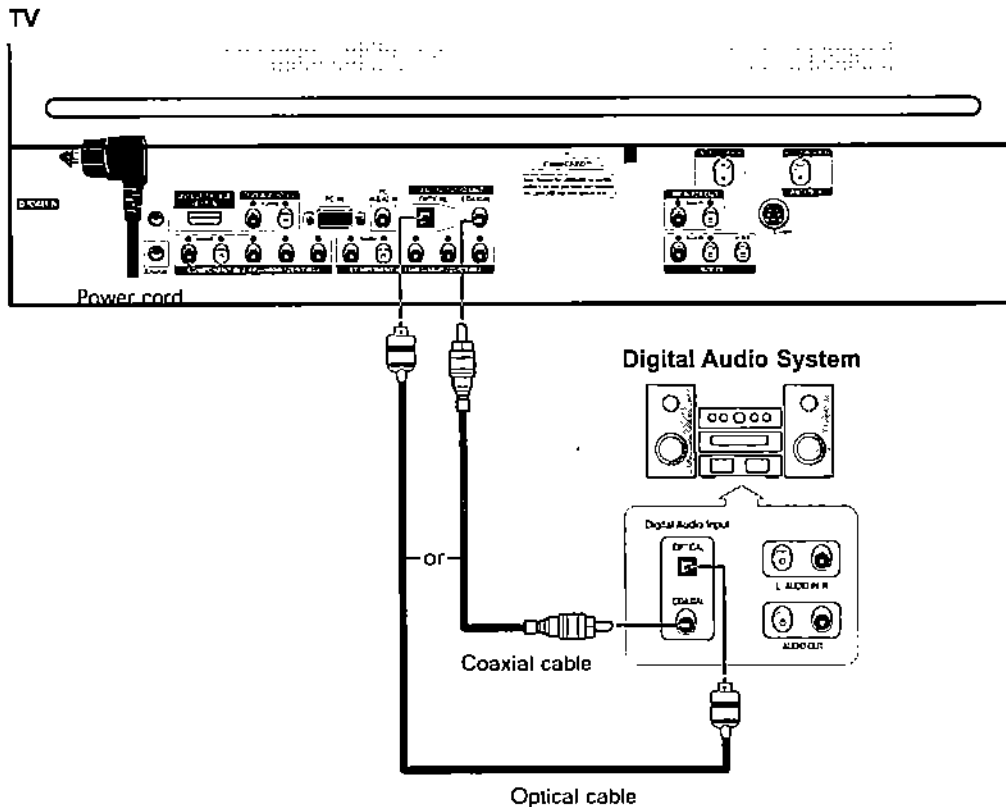

## How to Connect

- 1 If your audio system has a coaxial digital audio input, connect to the "COAXIAL" output jack on the TV.
- 2 If your audio system has an optical digital audio input, connect to the "OPTICAL" output jack on the TV.  
Be certain to remove the black cover from the optical output before inserting the cable.
- 3 If your system has both coaxial and optical digital audio inputs, SAMSUNG recommends you use the optical digital output on the TV.  
Do not connect both optical and coaxial cables. This may damage your audio system.
  - OPTICAL: converts the electric signal into an optical light signal, and transmits it through glass fibers.
  - COAXIAL: The digital audio signal is received through a coaxial copper cable.



# Plasma Display



## Connecting to an Analog Amplifier

TV

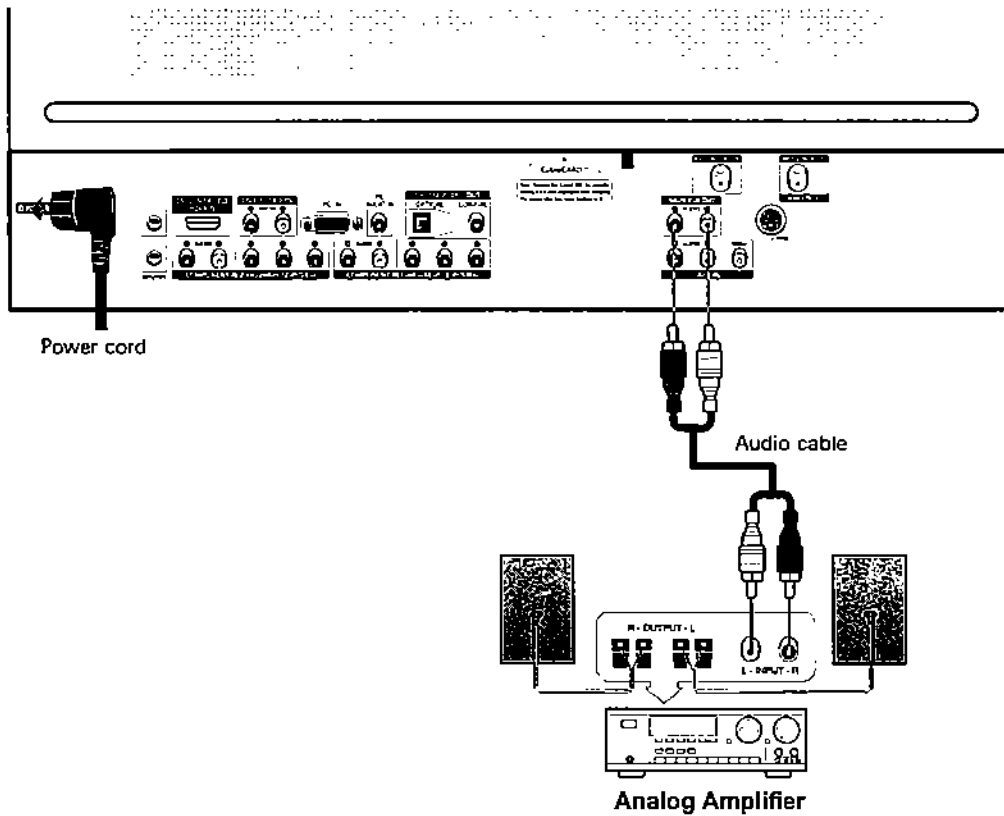

### How to Connect

- 1 The "MONITOR OUT (AUDIO L/R)" terminals cannot be used for external speakers. You must hook them up to an amplifier.

When an audio amplifier is connected to the "MONITOR OUT (AUDIO L/R)" terminals:  
Decrease the gain (volume) of the audio amplifier, and adjust the volume level with the volume control on the TV.



P L A S M A   D I S P L A Y   P A N E L

# Operation

Turning the TV On and Off.....	36
Viewing the Menus and Displays .....	40
Memorizing the Channels .....	41
Adding and Erasing Channels .....	44
Setting Up Your Remote Control .....	47
Viewing an External Signal Source .....	49



# Turning the TV On and Off

## Turning the TV On and Off

Press the POWER button on the remote control.  
The TV will be turned on and you will be able to use its features.  
You can also use the Power button on the front of the TV.

### Note

- If your TV isn't turned on when the POWER button is pressed:  
Press the **MODE** button to check if the TV mode has been chosen.

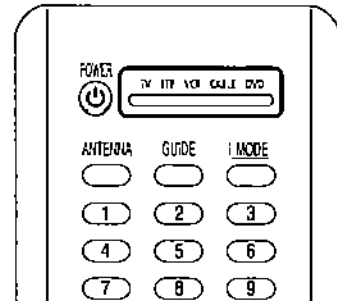

## Plug & Play Feature

When the TV is initially powered On, basic customer settings proceed automatically and subsequently: Setting the language, checking the antenna input, memorizing the channels, and setting the time.

### Note

- The Plug & Play function operates after plugging in the TV for the first time.

- 1 Press the POWER button on the remote control. The message "Menu language, Channels and Time will be set." is displayed. Press the ENTER button, then "Select the language of OSD" menu is automatically displayed.

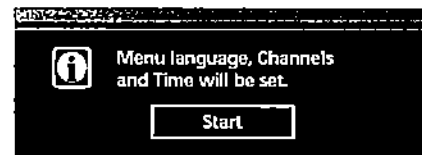

- 2 Press the ENTER button to enter the language. Press the ▲ or ▼ button to select language, then the ENTER button. "Select the antennas to memorize." menu is automatically displayed.



# Plasma Display

- 3 Press the ▲ or ▼ button to memorize the channels of the selected connection.  
Press the ENTER button to select "Start".

## Notes

- If the antenna is connected to ANT 1 IN (CABLE IN), select "Cable" and if it is connected to ANT 2 IN (AIR IN), select "Air".
- If both ANT 1 IN and ANT 2 IN are connected, select the "Air + Cable".
- If the CableCARD is inserted into the "CableCARD" slot on the rear panel, "Cable" and "Air + Cable" are not available.

## When selecting Cable TV :

Press the ▲ or ▼ button to select "Cable" or "Air+Cable", then press the ENTER button.

Press the ▲ or ▼ button to select "Digital Channel", then press the ENTER button.

Press the ▲ or ▼ button to select "STD", "HRC", or "IRC", press the ENTER button.

Press the ▲ or ▼ button to select "Analog Channel", then press the ENTER button.

Press the ▲ or ▼ button to select "STD", "HRC", or "IRC", press the ENTER button.

Press the ▲ or ▼ button to select "Start", then press the ENTER button to memorize the channels.

## Note

- STD, HRC, and IRC identify various types of cable TV systems. Contact your local cable company to identify the type of cable system that exists in your particular area. At this point the signal source has been selected. Proceed to "Storing Channels in Memory" on page 43.

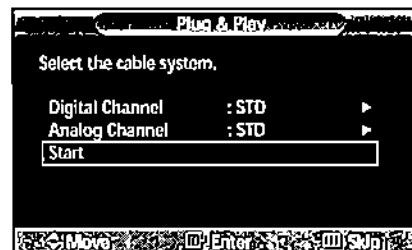
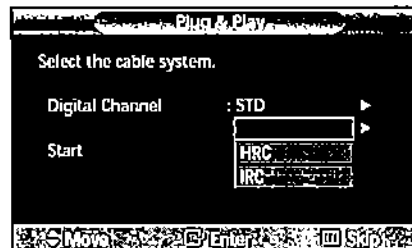
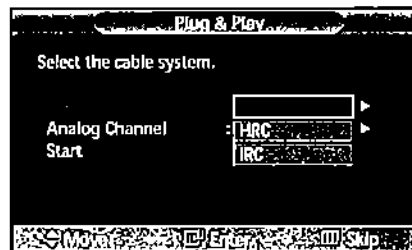
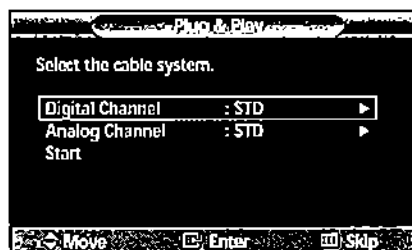
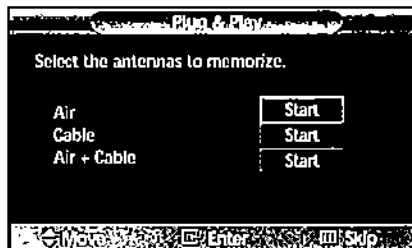

- 4 The TV will begin memorizing all of the available channels. After all the available channels are stored, the Auto program menu reappears. Press the ENTER button when channel memorization is complete. "Set to daylight savings time." menu is automatically displayed.



- 5 Press the ENTER button. Press the ▲ or ▼ button to select "Yes" or "No", then the ENTER button. "Select your time zone in which you live" menu is automatically displayed.

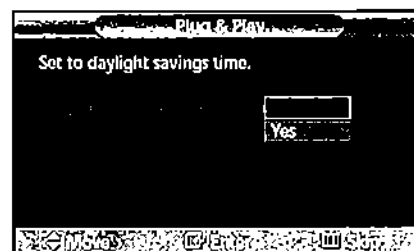

- 6 Press the ▲ or ▼ button to highlight the time zone for your local area (and to move the highlight to the appropriate time zone on the map of the United States). Press the ENTER button.

If you have received a digital signal, the time will be set automatically. If not, see page 102 to set the clock.

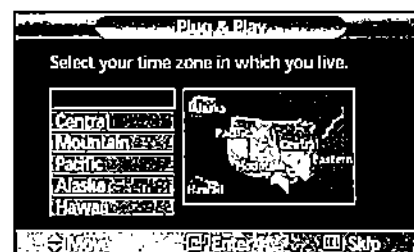

- 7 The message "Completed. Time will be updated automatically." is displayed. When you have finished, press the ENTER button.

- The message will automatically disappear after a few seconds, even if the ENTER button is not pressed.



# Plasma Display

If you want to reset this feature...

- 1 Press the MENU button. Press the ▲ or ▼ button to select "Setup", then press the ENTER button.



- 2 Press the ENTER button to select "Plug & Play".



- 3 For further details on setting up options, refer to the previous page.

### **Note**

- Plug and Play can only be accessed in the TV mode.



# Viewing the Menus and Displays

Your TV has a simple, easy-to-use menu system that appears on the TV screen. This system makes it convenient and fast to use features on the TV. Your TV also lets you display the status of many of your TV's features.

## Viewing the Menus

- 1 With the power on, press the MENU button on the remote control. The main menu appears on the screen. The Input menu is selected.

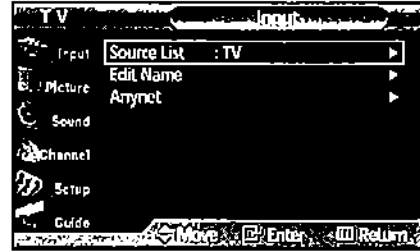

- 2 Press the ▲ or ▼ button to move to items in the menu. Press the ◀/▶/ENTER buttons to display, change, or use the selected items.

Press the ENTER (◻) button to enter items in the menu. On screen menus disappear from the screen automatically after about two minutes or you can press the MENU or EXIT button on your remote control to exit the menu.

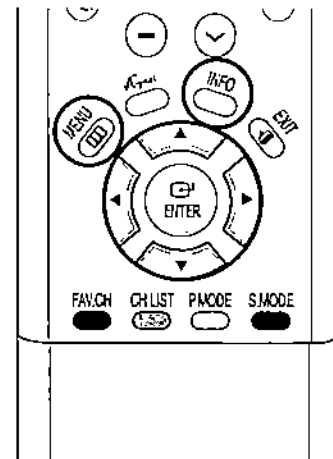

## Displaying Status Information

Press the INFO button on the remote control. The TV will display the Picture Mode, Sound Mode, MTS, V-Chip, and Current Time.

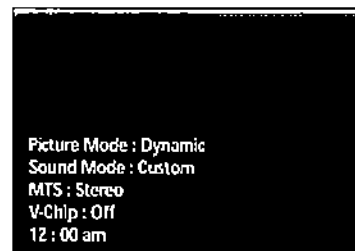





## Memorizing the Channels

Your TV can memorize and store all of the available channels for both "off-air" (antenna) and cable channels. After the available channels are memorized, use the CH  $\odot$  and CH  $\ominus$  buttons to scan through the channels. This eliminates the need to change channels by entering the channel digits. There are three steps for memorizing channels: selecting a broadcast source, memorizing the channels (automatic) and adding and deleting channels (manual).

### Selecting a broadcast source

Before your television can begin memorizing the available channels, you must specify the type of signal source that is connected to the TV (i.e., an antenna or a cable system).

- 1 Press the MENU button. Press the  $\blacktriangle$  or  $\blacktriangledown$  button to select "Channel", then press the ENTER button.

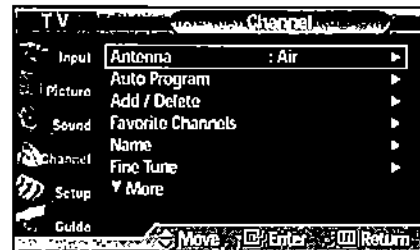

- 2 Press the  $\blacktriangle$  or  $\blacktriangledown$  button to select "Auto Program", then press the ENTER button.



- 3 Press the  $\blacktriangle$  or  $\blacktriangledown$  button to select the antenna connection, then press the ENTER button.

#### Notes

- Air : "Air" antenna signal.
- Cable : "Cable" antenna signal.
- Air + Cable : "Air" and "Cable" antenna signals.

If the CableCARD is inserted into the "CableCARD" slot on the rear panel, "Cable" and "Air + Cable" are not available.

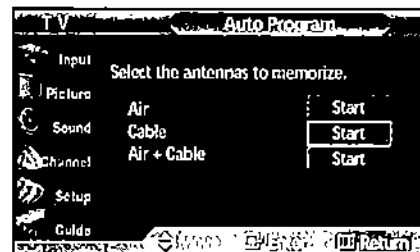
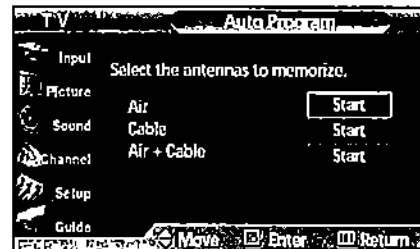

### When selecting Cable TV system :

Press the ▲ or ▼ button to select "Cable" or "Air+Cable", then press the ENTER button.

Press the ▲ or ▼ button to select "Digital Channel", then press the ENTER button.  
Press the ▲ or ▼ button to select "STD", "HRC", or "IRC", press the ENTER button.

Press the ▲ or ▼ button to select "Analog Channel", then press the ENTER button.  
Press the ▲ or ▼ button to select "STD", "HRC", or "IRC", press the ENTER button.

Press the ▲ or ▼ button to select "Start", then press the ENTER button to memorize the channels.

### Note

- STD, HRC, and IRC identify various types of cable TV systems. Contact your local cable company to identify the type of cable system that exists in your particular area. At this point the signal source has been selected. Proceed to "Storing Channels in Memory" on page 43.

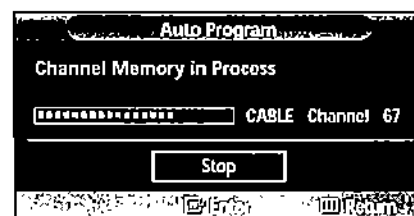
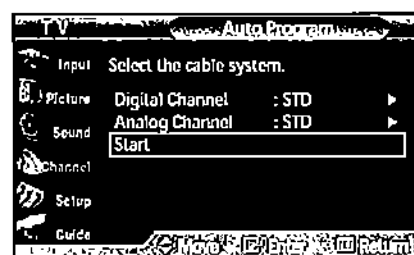
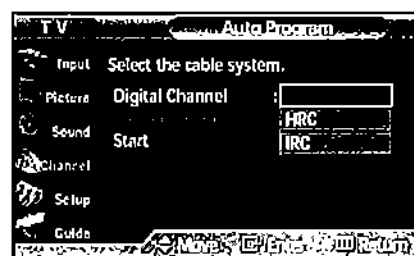
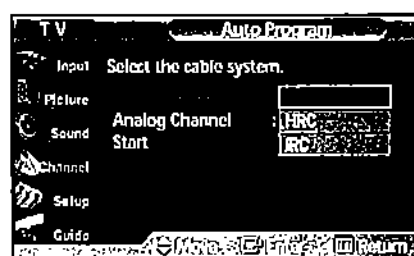
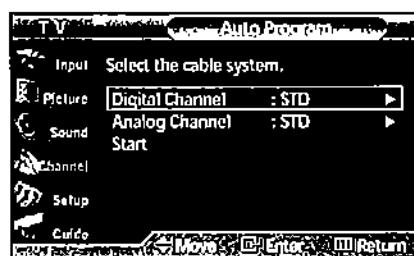

## Storing Channels in Memory

- 4 Press the ▲ or ▼ button to select the antennas to memorize. Press the ENTER button to select "Start".

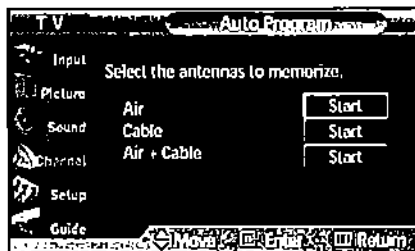

- 5 In Air, press the ENTER button to start the auto program. In Cable or Air + Cable, press the ENTER button to select the cable system. Press the ▲ or ▼ button to select "Digital Channel or Analog Channel", then select the cable system. And press the ▲ or ▼ button to select "Start" and press the ENTER button to start the auto program.

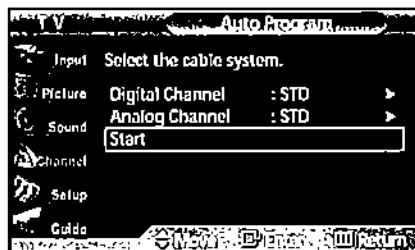

- 6 The TV begins memorizing all available stations. Press the ENTER button at any time to interrupt the memorization process. Press the EXIT button to exit.



### **Note**

- The TV must be connected to an antenna in order to receive digital TV signals. Even if a particular channel is deleted from the memory, you can always tune to that channel directly by using the number buttons on the remote control.

### **Notes**

- All available DTV and analog channels are automatically stored in memory when channels are selected by directly accessing channels.
- It takes approximately 3 to 10 minutes to memorize channels.



# Adding and Erasing Channels

To add channels that were not memorized (or to delete unwanted channels from memory):

- 1 Press the MENU button.  
Press the ▲ or ▼ button to select "Channel", then press the ENTER button.



- 2 Press the ▲ or ▼ button to select "Add/Delete", then press the ENTER button.

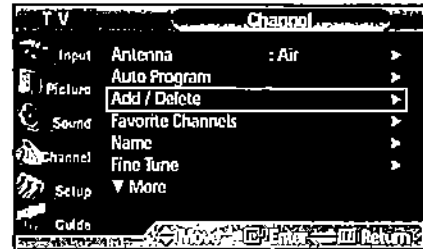

- 3 Repeatedly pressing the ENTER button will alternate between add channel and delete channel.

Press the CH ▲ or CH ▼ button to switch to the appropriate channel, then repeat above.  
Press the EXIT button to exit.

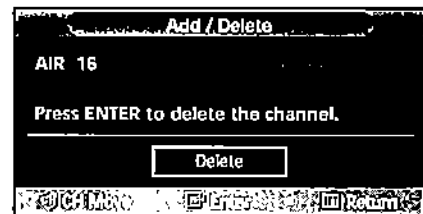
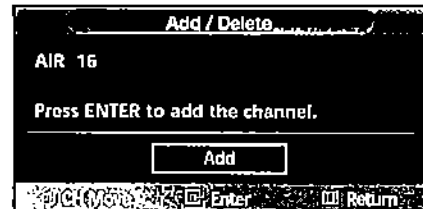

# PLasma Display

## Changing Channels

### Using the Channel Buttons

Press the CH  $\odot$  or CH  $\ominus$  button to change channels.

*When you press the CH  $\odot$  or CH  $\ominus$  button, the TV changes channels in sequence. You will see all the channels that the TV has memorized. (The TV must have memorized at least three channels.) You will not see channels that were either erased or not memorized.*

### Directly Accessing Channels

Press the number buttons to go directly to a channel. For example, to select channel 27, press "2" then "7".

*When you use the number buttons, you can directly select channels that were either erased or not memorized. To change to single-digit channels (0-9) faster, press "0" before the single digit. (For channel "4" press "0", then "4".)*

### Notes

- For quick channel change, press the number buttons and, then press ENTER button.
- After the process of updating the channel information using CableCARD has been completed, only the number of channels on the channel list can be directly accessed.

### Using the PRE-CH button to select the previous channel

Press the PRE-CH button. The TV will switch to the last channel viewed.

*To quickly switch between two channels that are far apart, tune to one channel, then use the number button to select the second channel. Then, use the PRE-CH button to quickly alternate between them.*

## Adjusting the Volume

### Using the Volume Buttons

Press the VOL  $\oplus$  or VOL  $\ominus$  button to increase or decrease the volume.

## Using Mute

### Using the MUTE Button

At any time, you can temporarily cut off the sound using the MUTE button.

- 1 Press the MUTE button and the sound cuts off. The word "MUTE" will appear in the lower-left corner of the screen.
- 2 To turn mute off, press the MUTE button again, or simply press the VOL  $\oplus$  or VOL  $\ominus$  button.

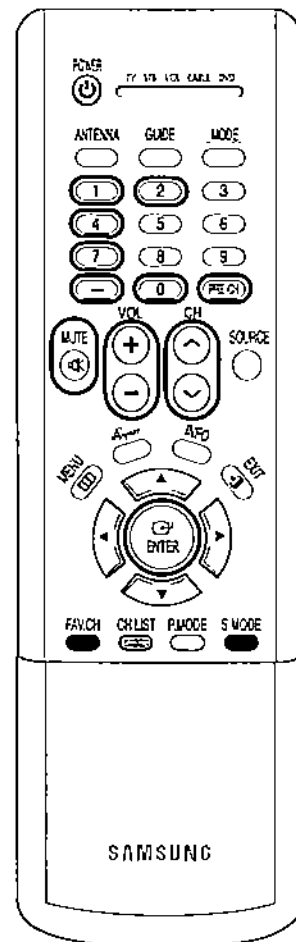

## Using the “-” Button

The “-” button is used to select stations that broadcast both a digital and analog signal.

For example, for Channel 7-1 (digital), press “7”, then “-”, then “1”.

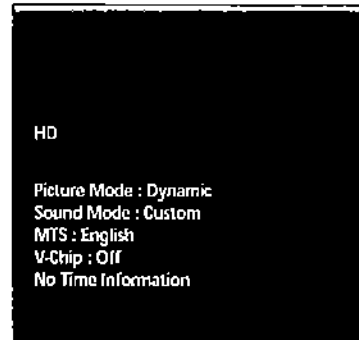

For channel 7-2 (analog), press “7”, then “-”, then “2”.

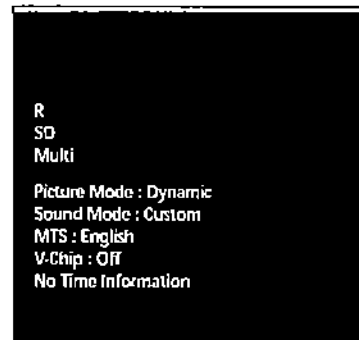

### ***Notes***

- HD indicates the TV is receiving a Digital High Definition signal.
- SD indicates the TV is receiving a standard definition signal.
- For quick channel change, press the number buttons, then press the ENTER button.



## Setting Up Your Remote Control

This TV's remote control can operate almost any VCR, Cable box or DVD. After it has been set up properly, your remote control can operate in five different modes : TV, STB, VCR, CABLE, or DVD. Pressing the corresponding button on the remote control allows you to switch between these modes, and control whichever piece of equipment you choose.

- Notes :**
- The remote control may not be compatible with all DVD Players, VCRs, or Cable boxes.
  - The remote control can only operate Set-Top Boxes made by Samsung.

### Setting Up the Remote to Operate Your VCR, Cable box or DVD player

- 1 Turn off your VCR (or Cable box, DVD player).
- 2 Press the MODE button. The Mode is changed whenever MODE button is pressed.
- 3 Press the SET button on your TV's remote control.
- 4 Using the number buttons on your remote control, enter three digits of the VCR (or Cable box, DVD player) code listed on page 48 of this manual for your brand of VCR (or Cable box, DVD). Make sure you enter three digits of the code, even if the first digit is a "0". (If more than one code is listed, try the first one.)
- 5 Press the POWER button on the remote control. Your VCR (or Cable box, DVD) should turn on if your remote is set up correctly. If your VCR (or Cable box, DVD) does not turn on after setup, repeat steps 2, 3, and 4, but try one of the other codes listed for your brand of VCR (or Cable box, DVD). If no other codes are listed, try each code, 000 through 089 (or Cable box: 000 through 077, DVD player: 000 through 008).

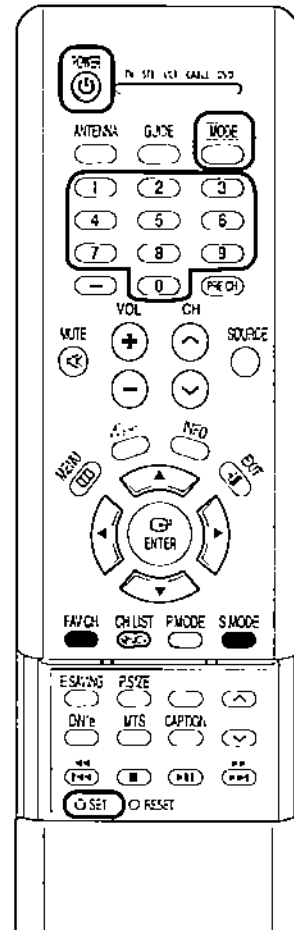

### Notes

- When your remote control is in "VCR", "CABLE", or "DVD" mode, the VCR control buttons (STOP, REW, PLAY/PAUSE, and FF) still operate your VCR.
- You do not need to program the remote for Samsung STBs as the codes are pre-programmed.

## Remote Control Codes

### VCR Codes

Admiral	015,088	Hitachi	014,024,044,045	Quasar	017,053
Aiwa	024	Instant Replay	017	Radio Shack	011,015,017,018,021,024,028,036,052,062
Alai	026,031,032	JC Penny	011,014,016,017,023,025,039,044,060,062	RCA	009,014,016,017,037,044,046,063,078
Audio Dynamics	022,025	JCL	011,017,023,025,039,055	Realitic	011,015,017,018,021,024,028,036,052,062
Bell & Howell	011	Kenwood	011,023,025,039,055	Samsung	000,016,022,031,041,051
Braksonic	019	KUH	082	Sansui	025
Candle	016,018,022,054,055,061	LG(Goldstar)	001,002,007,018,023,055,069	Sanyo	011,021
Canon	017,062	Lloyd	024	Scott	022,050,058,077
Citizen	016,018,022,054,055,061	Logik	040	Sears	011,014,018,021,027,028,044,052,057
ColorTyme	023	LU	024	Sharp	015,036,048,054
Craig	016,021	Magnavox	017,038,062,065	Shin'om	026,035,040,054
Curtis Mathes	009,016,017,023,024,055,062,073,076	Marantz	011,017,023,025,038,039,055,070	Signature	024
Daewoo	003,004,005,006,007,008,022,034,085	MIC	016,024	Sony	026,035,047
DB	023,025	Multitech	016,024,040,041	Sylvania	017,024,038,062,065
Dimensia	009	NEC	011,023,025,039,055,070,073	Symphonic	024
Dynatech	024	Optimus	015	Tandy	011,024
Electrohome	036	Panasonic	017,062,084,086	Tatung	039
Emerson	017,018,019,022,024,029,032,036,043,050,051,056,058,066,071,074,076,077,079	Penix	014,044	Teac	024,039,078
Fisher	011,021,027,028,052,057,067	Penix Research+	055	Technics	017
Fujai	024	Phico	017,038,062,065	Teknika	017,018,024,030
General Electric	009,016,017,041,062	Philips	017,038	TKK	076
Go Video	016	Pioneer	014,023,042,059	Toshiba	014,022,028,057,058
Harman Kardon	023	Portland	053,054,061	Toshiba	018
		PROSCAN	009	Television	016,018
		Quartz	011		

### Cable Box Codes

Anvision	015,016	Magnavox	015,016,027,029,034,036,037,040,041,048,049	Signature	054
Cable Star	015,016	Nawoo	001	Sprucer	035
DasMan	005	NSC	017	Starcom	054
DeaByung	003	Oak	024,046	StarGate2000	066
DongKuk	004	Oak Sigma	024	Sylvania	019,067
Eagle	015,016	Panasonic	011,035,047,069	TaePyungYang	002
Eastern International	020	Philips	015,016,027,029,034,036,037,040,041,048,049	Taxscan	019,067
General Instrument	054	Pioneer	026,028,052	Locom	025,029,057,058,063
GI	012,013,023,031,032,033,036,044,075,076,077	Randtek	015,016	Unika	039,040,049
Hamlin	011,012,020,021,042,056	RCA	008,035,074	Universal	059,060
Hitachi	045,051,054	Regal	011,020,021	Viewstar	015,016,027,029,034,036,037,040,041,048,049
Jerrald	012,013,023,031,032,033,038,044,054,070,073	Regency	010,041	Warner Amex	052
LG(Goldstar)	006	Saewoo	007	Zenith	022,050,065,069
Macom	045,051	Samsung	000,011,030,052,071,072		

### DVD Codes

Curtis Mathes	009	Philips	007	Sharp	005
JVC	003	PROSCAN	008	Sony	004
LG(Goldstar)	001	RCA	008	Toshiba	002
Panasonic	006	Samsung	000		





## Viewing an External Signal Source

Use the remote control to switch between viewing signals from connected equipment, such as VCR, DVD, Set-Top Box, and the TV source (broadcast or cable).

### Setting the Signal Source

- 1 Press the MENU button.  
Press the ENTER button to select "Input".  
 ▶ Quick way to access viewing an external signal source :  
Just press the "SOURCE" button on the remote control.

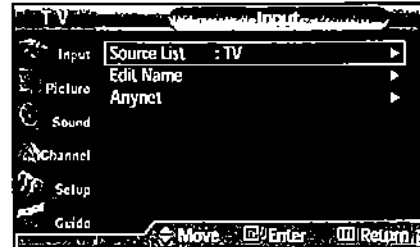

- 2 Press the ENTER button to select "Source List".



- 3 Press the ▲ or ▼ button to select signal source, then press the ENTER button.

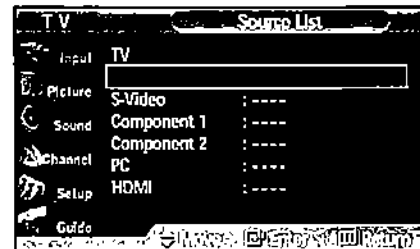

- 4 Press the MENU button to exit.

#### Notes

- When you connect equipment to the TV, you can choose between the following sets of jacks: AV, S-VIDEO, COMPONENT 1, COMPONENT 2, PC, or HDMI on the TV's rear panel.
- HDMI input can only be selected when the external device is turned on.

## Assigning Names to External input mode

- 1 Press the MENU button.  
Press the ENTER button to select "Input".

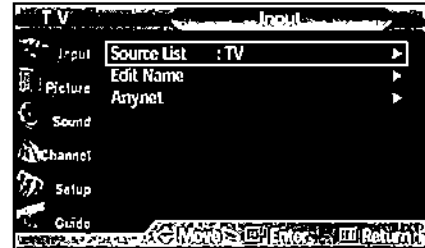

- 2 Press the ▲ or ▼ button to select "Edit Name", then press the ENTER button.

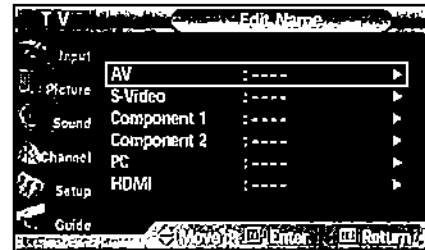

- 3 Press the ENTER button.  
Press the ▲ or ▼ button to select external device, then press the ENTER button.
  - You can select the VCR, DVD, D-VHS, Cable STB, HD STB, Satellite STB, PVR STB, AV Receiver, DVD Receiver, GAME, Camcorder, DVD Combo, PC, VOD STB, or TV.
  - Set other signal sources (S-Video, Component 1, Component 2, PC, or HDMI) using the same method as listed above.

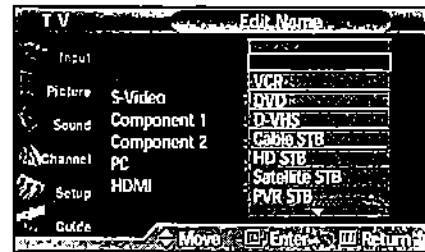

- 4 Press the MENU button to exit.

P L A S M A   D I S P L A Y   P A N E L

# Picture Control



Customizing the Picture .....	52
Using Automatic Picture Settings .....	53
Selecting the Color Tone .....	54
DNle (Digital Natural Image engine) Demo .....	55
Changing the Screen Size .....	56
Viewing the Picture-in-Picture.....	58
Selecting the Sound Source .....	64
Setting the My Color Control Mode.....	65
Using the Dynamic Contrast .....	69



# Customizing the Picture

You can use the on-screen menus to change the Contrast, Brightness, Sharpness, Color, and Tint settings of your TV.

- 1 Press the MENU button. Press the ▲ or ▼ button to select "Picture", then press the ENTER button.

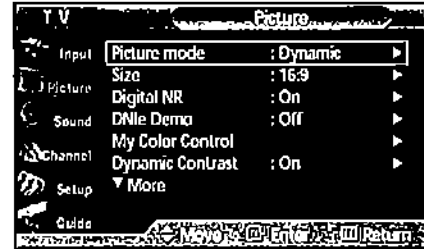

- 2 Press the ENTER button to select "Picture mode". You will also see the items "Contrast", "Brightness", "Sharpness", "Color", "Tint", "Color Tone", and "Reset".

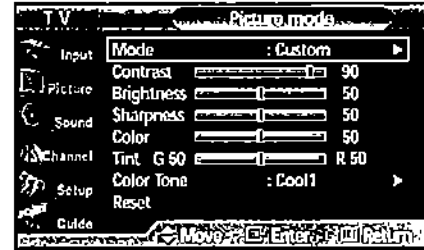

- 3 Press the ENTER button to select "Mode". Press the ▲ or ▼ button to select "Custom", then press the ENTER button.



- 4 Press the ▲ or ▼ button to select the item you wish to change, then press the ENTER button. Press the ◀ or ▶ button to change the value of the item.

- Press the ◀ or ▶ button to select other items.

- 5 Press the MENU button to exit.

## Notes

- In the Component(480p, 720p, 1080i), HDMI mode, you can't adjust the Tint.
- If you make any changes to these settings, the picture mode is automatically switched to custom.
- Each adjusted setting will be stored separately according to its input mode.
- When you make changes to Contrast, Brightness, Color, Tint, OSD color will also be adjusted accordingly.

# Plasma Display



## Using Automatic Picture Settings

Your TV has automatic picture settings that allow you to adjust the video display easily.

- 1 Press the MENU button. Press the ▲ or ▼ button to select "Picture", then press the ENTER button.

► Quick way to access the picture setting: Just press the "P.MODE" button on the remote control.

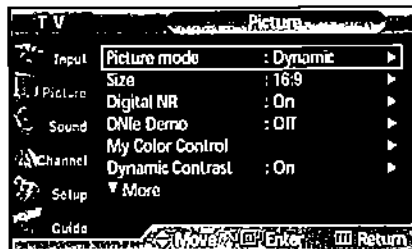

- 2 Press the ENTER button to select "Picture mode".

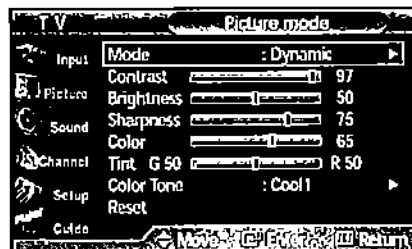

- 3 Press the ENTER button again to select "Mode". Press the ▲ or ▼ button to select "Dynamic", "Standard", "Movie", or "Custom" picture setting, then press the ENTER button.

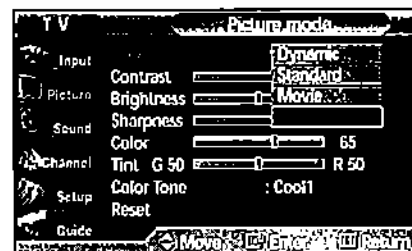
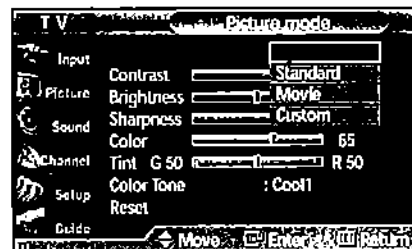

- 4 Press the MENU button to exit.

- Choose Dynamic for viewing the TV during the day or when there is bright light in the room.
- Choose Standard for the standard factory settings.
- Choose Movie when viewing the movie.
- Choose Custom if you want to adjust the settings according to personal preference (see "Customizing the Picture", page 52).

### Note

- Each adjusted value of Picture mode will be stored separately according to its input mode.

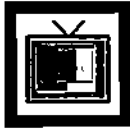

# Selecting the Color Tone

- 1 Press the MENU button. Press the ▲ or ▼ button to select "Picture", then press the ENTER button.

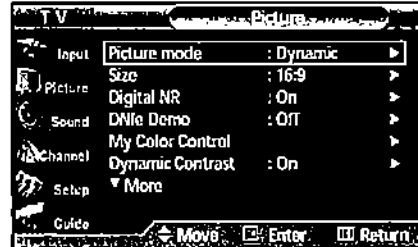

- 2 Press the ENTER button to select "Picture mode".

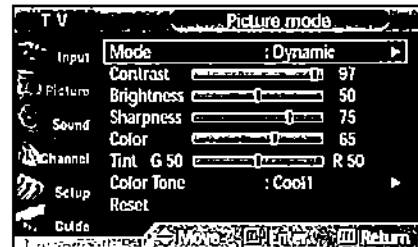

- 3 Press the ▲ or ▼ button to select "Color Tone", then press the ENTER button.

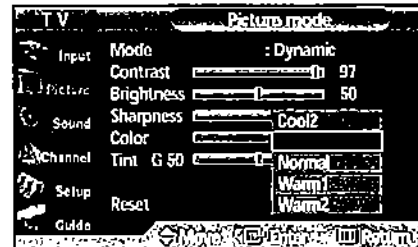

- 4 Press the ▲ or ▼ button to select "Cool2", "Cool1", "Normal", "Warm1", or "Warm2", then press the ENTER button.

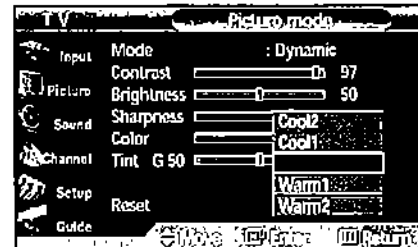

- 5 Press the MENU button to exit.

# Plasma Display



## DNle (Digital Natural Image engine) Demo

Samsung's new technology brings you more detailed images with contrast, white enhancement and 3D noise reduction.

- 1 Press the MENU button. Press the ▲ or ▼ button to select "Picture", then press the ENTER button.

➤ Quick way to select DNle: Simply press the "DNle" button under the cover of the remote control.

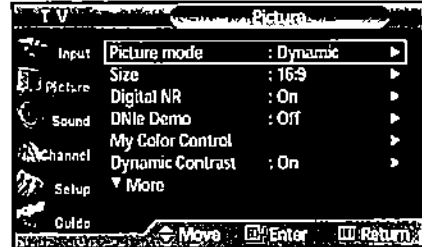

- 2 Press the ▲ or ▼ button to select "DNle Demo", then press the ENTER button.

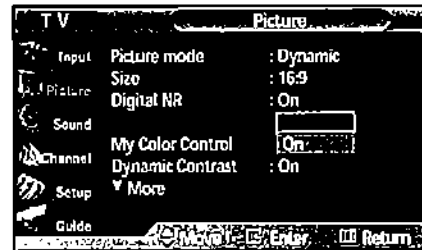

- 3 Press the ▲ or ▼ button to select "Off" or "On", then press the ENTER button.

- Off : Switches off the DNle mode.
- On : Switches on the DNle mode.

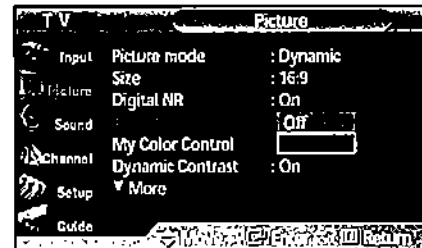

- 4 Press the MENU button to exit.



# Changing the Screen Size

Screen size selection depends on the type of video input.

- 1 Press the MENU button. Press the ▲ or ▼ button to select "Picture", then press the ENTER button.

➤ Quick way to change the Screen size: Simply press the P.SIZE button under the cover of the remote control.

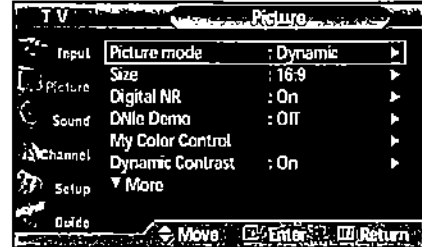

- 2 Press the ▲ or ▼ button to select "Size", then press the ENTER button.

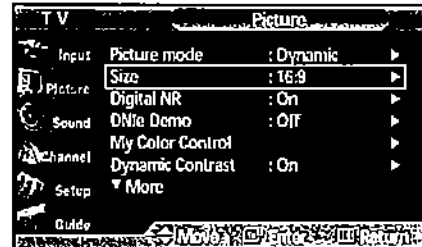

- 3 Press the ◀ or ▶ button to select the screen size you want, then press the ENTER button.

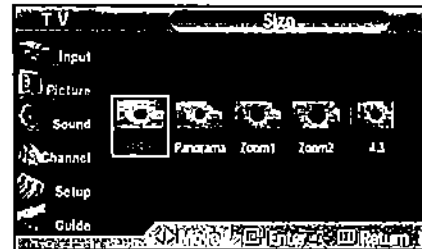

- 4 Press the MENU button to exit.

- 16:9 : Sets the picture to 16:9 wide mode.
- Panorama : Use this mode for the wide aspect ratio of a panoramic picture.
- Zoom1 : Magnifies the size of the picture on the screen.
- Zoom2 : Expands the Zoom1 format picture.
- 4:3 : Sets the picture to 4:3 normal mode.



# Plasma Display

When you press the P.SIZE button under the cover of the remote control, the TV's screen mode should appear in sequence. The screen displays in this order: 16:9, Panorama, Zoom1, Zoom2, 4:3.

## Note

- If you watch a still image or the 4:3 mode for a long time (over 2 hours), an image may be burned onto the screen. View the TV in 16:9 or Panorama mode as much as possible.

## 16:9

Sets the picture to 16:9 wide mode.

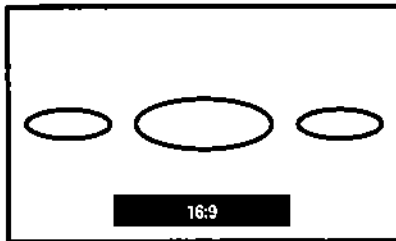

## Zoom2

The screen size when the Zoom1 screen is vertically enlarged.

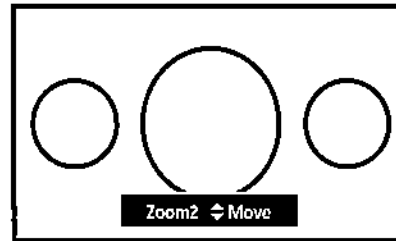

## Panorama

Converts regular 4:3 aspect ratio screen to wide screen.

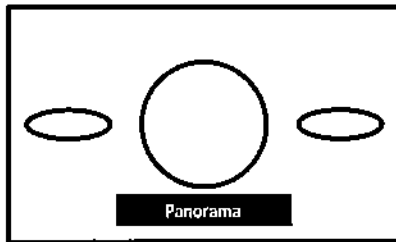

## 4:3

Sets the picture to 4:3 normal mode.

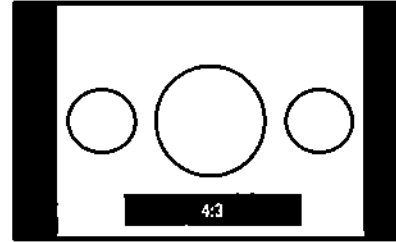

## Zoom1

The screen size when Wide screen is vertically enlarged.

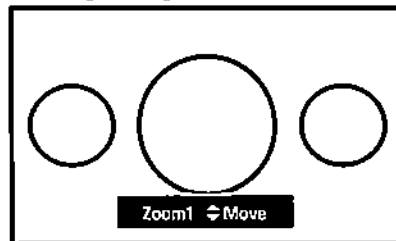

## Notes

- In TV, VIDEO, S-VIDEO, and all COMPONENT modes, all screen modes can be selected. (16:9 → Panorama → Zoom1 → Zoom2 → 4:3).
- In TV(DTV), PC, HDMI modes, only 16:9 & 4:3 modes can be selected.
- In Zoom1, Zoom2 modes, you can move the picture on screen by pressing the ▲ or ▼ button. (All screen modes)
- Picture size will not change when PIP size is Double.

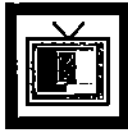

# Viewing the Picture-in-Picture

## Selecting the PIP Screen

1 Press the MENU button. Press the ▲ or ▼ button to select "Picture", then press the ENTER button.

➤ Quick way to access the PIP mode: Simply press the "PIP" button under the cover of the remote control.

2 Press the ▲ or ▼ button to select "PIP", then press the ENTER button.

3 Press the ENTER button, then press the ▲ or ▼ button to select "On". The PIP image will appear in the corner of the screen.

- Pressing the ▲ or ▼ button will alternate between "On" and "Off".

### Note

- Check if the V-Chip Lock (refer to page 122) is On if the PIP On/Off will not function. PIP does not function when the V-Chip Lock is set to On. Change the setting to Off and try it again.

4 Press the MENU button to exit.

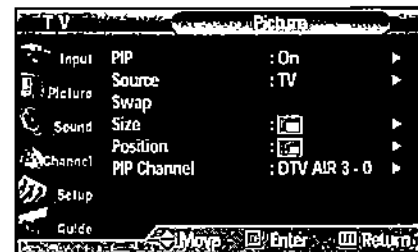
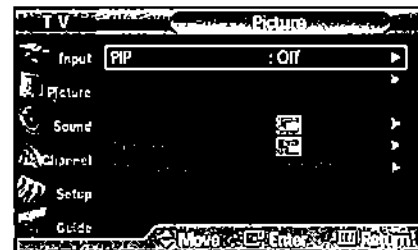
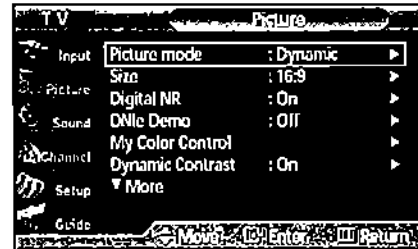

## PIP Settings

A : Analog      O : PIP and swap operate  
D : Digital     X : PIP doesn't operate

Main screen \ PIP screen		TV		AV1(A)	S-Video(A)	Component(A)	PC	HDMI(D)
		Analog	Digital (ATSC)					
TV	Analog	X		X	X	X	X	O
	Digital (ATSC)	X		O	O	O	X	X
AV1(A)		X	O	X	X	X	X	O
S-Video(A)		X	O	X	X	X	X	O
Component(A)		X	O	X	X	X	X	O
PC		O	X	O	O	O	X	X
HDMI(D)		O	X	O	O	O	X	X

# Plasma Display

## Selecting an External Signal

You can use PIP to view a signal from an external source, such as a VCR.

- 1 Press the MENU button. Press the ▲ or ▼ button to select "Picture", then press the ENTER button.

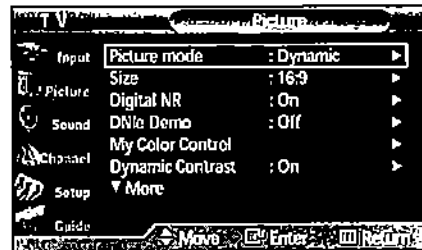

- 2 Press the ▲ or ▼ button to select "PIP", then press the ENTER button.

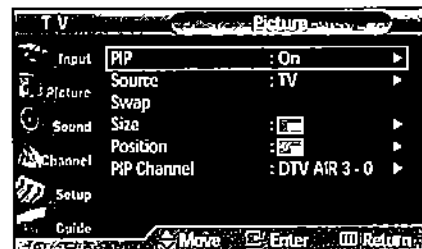

- 3 Press the ▲ or ▼ button to select "Source", then press the ENTER button.

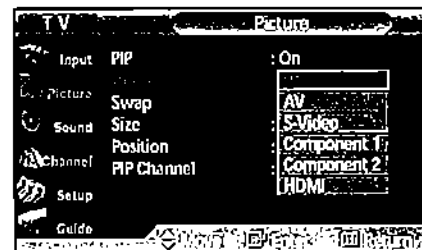

- 4 Press the ▲ or ▼ button to cycle through all of the available signal sources: "TV", "AV", "S-Video", "Component 1", "Component 2", or "HDMI".

The signal from these inputs will not appear if you have not connected any equipment to the TV's respective input jacks.

- 5 Press the MENU button to exit.

### Notes

- The same Source can not be selected on both the main screen and subscreen.
- HDMI is not available in PIP picture.

## Swapping the Contents of the PIP and Main Image

- 1 Press the MENU button. Press the ▲ or ▼ button to select "Picture", then press the ENTER button.

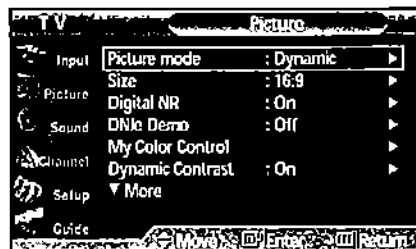

- 2 Press the ▲ or ▼ button to select "PIP", then press the ENTER button.

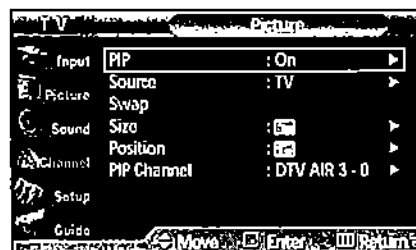

- 3 Press the ▲ or ▼ button to select "Swap", then press the ENTER button.

- The image in the PIP window will appear on the main screen, and vice versa.

### **Note**

- If main picture is in HDMI mode, Swap is not available.

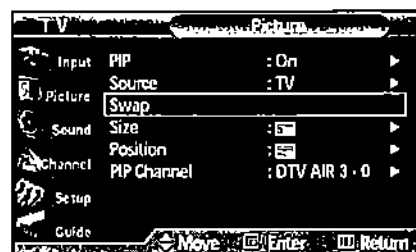

- 4 Press the MENU button to exit.

# Plasma Display

## Changing the Size of the PIP Window

- 1 Press the MENU button. Press the ▲ or ▼ button to select "Picture", then press the ENTER button.

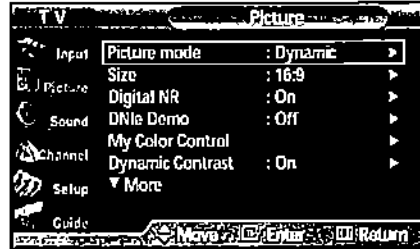

- 2 Press the ▲ or ▼ button to select "PIP", then press the ENTER button.

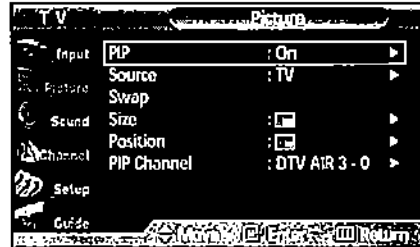

- 3 Press the ▲ or ▼ button to select "Size", then press the ENTER button.

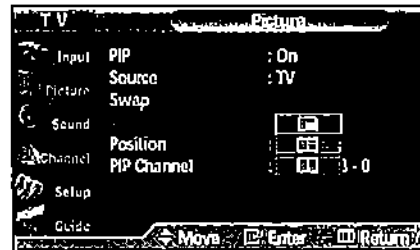

- 4 Press the ▲ or ▼ button to select option you want, then press the ENTER button.

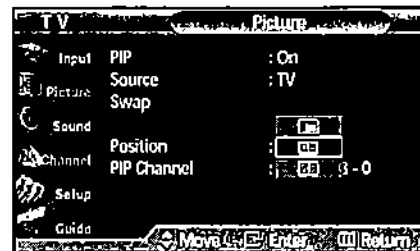

- 5 Press the MENU button to exit.

## Changing the Location of the PIP Image

- 1 Press the MENU button. Press the ▲ or ▼ button to select "Picture", then press the ENTER button.

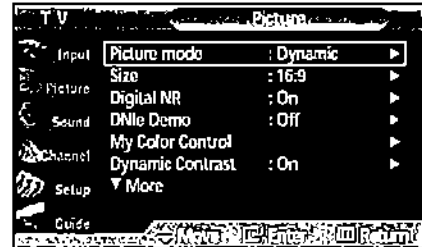

- 2 Press the ▲ or ▼ button to select "PIP", then press the ENTER button.

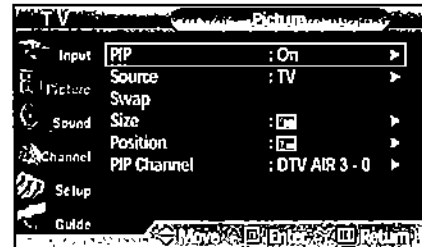

- 3 Press the ▲ or ▼ button to select "Position", then press the ENTER button.



- 4 Press the ▲ or ▼ button to select the PIP position you want, then press the ENTER button.

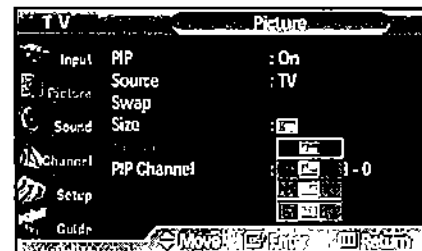

- 5 Press the MENU button to exit.

### **Note**

- The Double1 (□□) and Double2 (□□) mode cannot be selected in Position.

# Plasma Display

## Changing the PIP Channel

- 1 Press the MENU button. Press the ▲ or ▼ button to select "Picture", then press the ENTER button.

➤ Quick way to change the PIP channel: Just press the "CH ▲" or "CH ▼" button under the cover of the remote control.

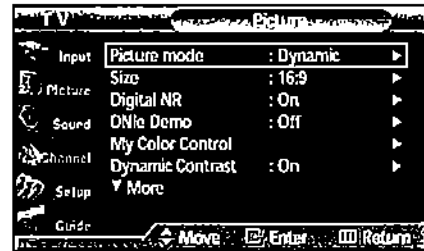

- 2 Press the ▲ or ▼ button to select "PIP", then press the ENTER button.

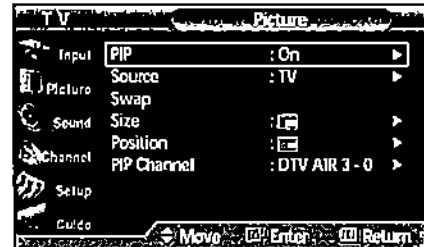

- 3 Press the ▲ or ▼ button to select "PIP Channel", then press the ENTER button.

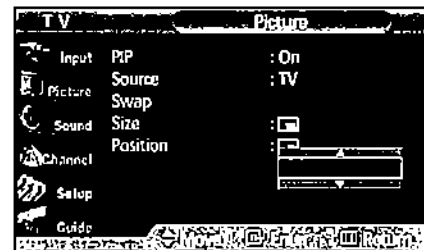

- 4 Press the ▲ or ▼ button to change the channel that appears in the PIP window.

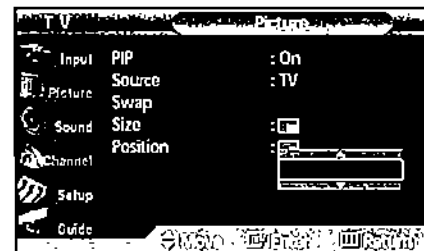

- 5 Press the MENU button to exit.

### Notes

- When PIP screen size is Double, the same channel cannot be selected for both main and sub screens.
- Only Analog channels signal inputs can be viewed through PIP.



# Selecting the Sound Source

You can use this feature to hear sound from the main or sub (PIP) picture.

- 1 Press the MENU button. Press the ▲ or ▼ button to select "Sound", then press the ENTER button.

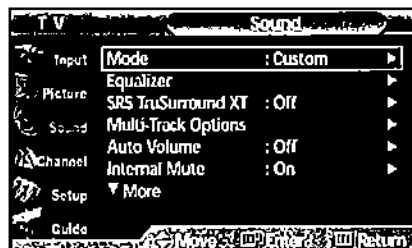

- 2 Press the ▲ or ▼ button to select "Sound Select", then press the ENTER button.

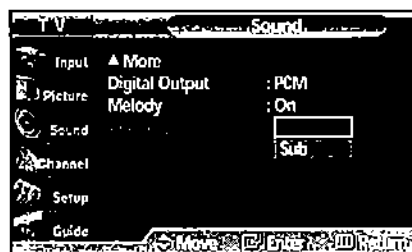

- 3 Press the ▲ or ▼ button to select "Main" or "Sub", then press the ENTER button.

- 4 Press the MENU button to exit.



# Plasma Display



## Setting the My Color Control Mode

My Color Control mode allows users to adjust colors according to their preferences, by adjusting skin, sky, and grass tones using the predefined settings (Standard, Custom, Red, Green, Blue, Yellow, Pink, White) without affecting other colors on the screen.

### Using the My Color Control Function in the Easy Control Menu

Skin, sky and grass tones are easily adjustable to suit your preferences.

- 1 Press the MENU button. Press the ▲ or ▼ button to select "Picture", then press the ENTER button.

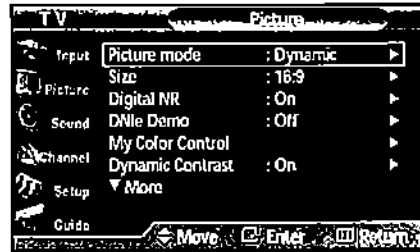

- 2 Press the ▲ or ▼ button to select "My Color Control", then press the ENTER button.

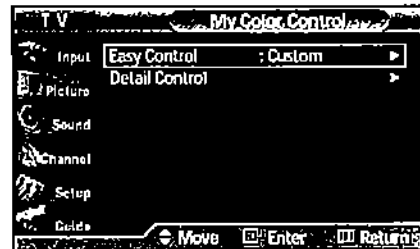

- 3 Press the ▲ or ▼ button to select "Easy Control", then press the ENTER button.

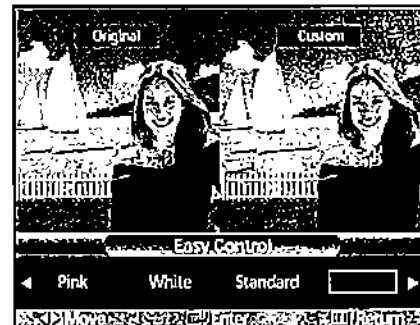

- 4 Press the ◀ or ▶ button to select the setting among the various picture settings. The original picture (before adjustment) is shown on the left side, while the selected mode is shown on the right side.

- ▶ There are eight My Color Control modes: Standard, Custom, Red, Green, Blue, Yellow, Pink, White.



- 5 Press the MENU button to exit the menu.

## My Color Control Mode Characteristics

Using My Color Control mode, you can enjoy vivid colors as shown below.



➤ Standard Picture.



➤ Emphasizes Reds.



➤ Emphasizes Mild Greens.



➤ Emphasizes Clear Blues.



➤ Emphasizes Yellows.



➤ Emphasizes Warm Skin Colors.



➤ Emphasizes Whites.

### **Note**

- Images shown above may differ from the actual adjustment on the screen. These images are presented for illustrative purposes.

## My Color Control Custom Settings

Users can adjust the 6 My Color Control colors (Red, Green, Blue, Yellow, Pink, and White).

- 1 Press the MENU button. Press the ▲ or ▼ button to select "Picture", then press the ENTER button.

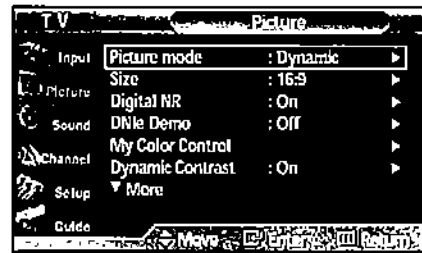

- 2 Press the ▲ or ▼ button to select "My Color Control", then press the ENTER button.

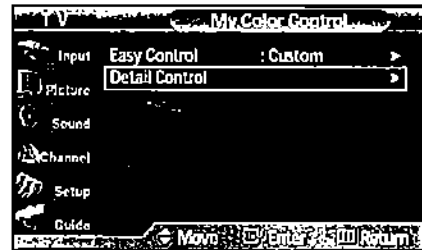

- 3 Press the ▲ or ▼ button to select "Detail Control", then press the ENTER button.

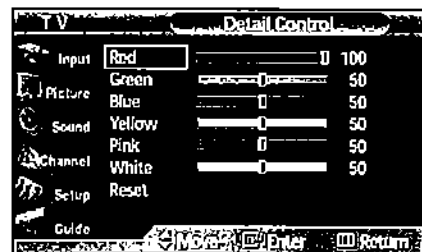

- 4 Press the ▲ or ▼ button to select the desired color and then press the ENTER or ► button.
  - The original picture (before adjustment) is shown on the left side, while the picture after adjustment is shown on the right side, and an adjustment bar on the bottom of the screen.



- 5 Press the ◀ or ▶ button to adjust the settings.
  - Press the ▲ or ▼ button to select other colors.

- 6 Press the ENTER or MENU button to confirm the changes and return to the previous menu.

## Resetting the My Color Control Colors to the Factory Defaults

To return to the factory default settings for My Color Control colors, use the Reset function.

- 1 Press the MENU button. Press the ▲ or ▼ button to select "Picture", then press the ENTER button.

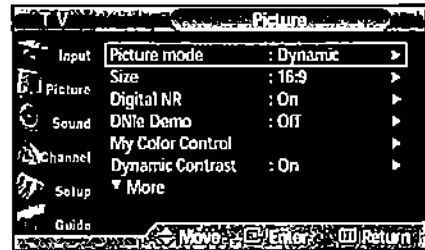

- 2 Press the ▲ or ▼ button to select "My Color Control", then press the ENTER button.

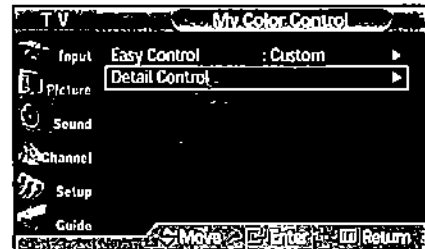

- 3 Press the ▲ or ▼ button to select "Detail Control", then press the ENTER button.

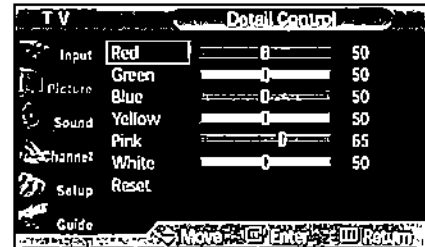

- 4 Press the ▲ or ▼ button to select "Reset" and press the ENTER button.

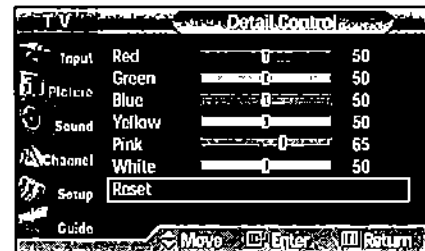

- 5 The previously adjusted My Color Control Colors will be reset to the factory defaults. (The default value for My Color Control colors is 50.)

- 6 Press the MENU button to exit the menu.

# Plasma Display



## Using the Dynamic Contrast

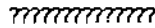

- 1 Press the MENU button. Press the ▲ or ▼ button to select "Picture", then press the ENTER button.

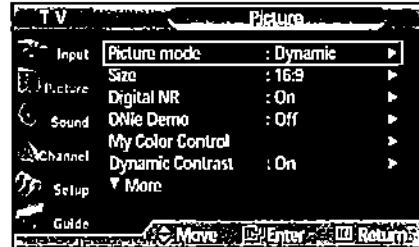

- 2 Press the ▲ or ▼ button to select "Dynamic Contrast", then press the ENTER button.

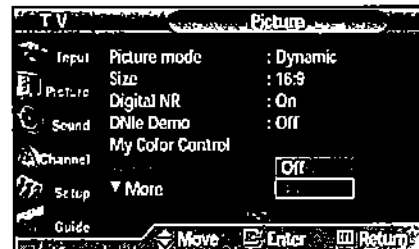

- 3 Press the ▲ or ▼ button to select "On", then press the ENTER button.

- Pressing the ▲ or ▼ button will alternate between "On" and "Off".

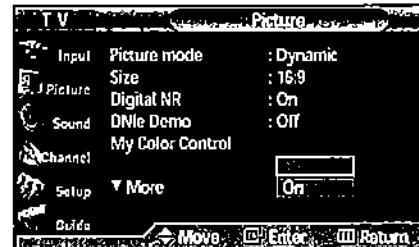

- 4 Press the MENU button to exit.



P L A S M A   D I S P L A Y   P A N E L

# Sound Control



Customizing the Sound .....	72
Using Automatic Sound Settings .....	73
Setting the TruSurround XT .....	74
Choosing a Multi-Channel Sound (MTS) track - Digital.....	75
Choosing a Multi-Channel Sound (MTS) track - Analog .....	76
Using the Auto Volume.....	77
Choosing a Digital Sound Format .....	78
Setting the On/Off Melody .....	79
Selecting the Internal Mute .....	80



# Customizing the Sound

The sound settings can be adjusted to suit your personal preferences.  
(Alternatively, you can use one of the "automatic" settings. See next page.)

- 1 Press the MENU button. Press the ▲ or ▼ button to select "Sound", then press the ENTER button.

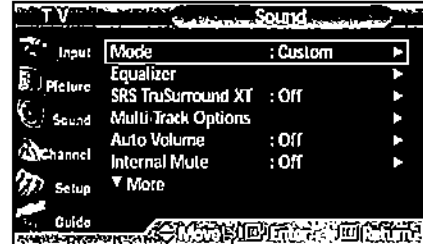

- 2 Press the ▲ or ▼ button to select "Equalizer", then press the ENTER button.

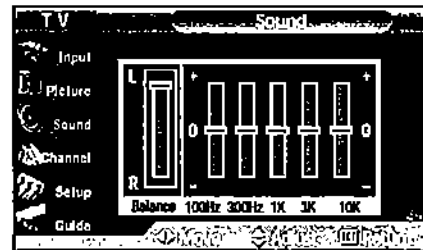

- 3 Press the ◀ or ▶ button to select a particular frequency to adjust. Press the ▲ or ▼ button to increase or decrease the level of the particular frequency.

- 4 Press the MENU button to exit.

## **Note**

- If you make any changes to the equalizer settings, the sound mode is automatically switched to the custom mode.





## Using Automatic Sound Settings

Your TV has automatic sound settings ("Standard", "Music", "Movie", and "Speech") that are preset at the factory. Or, you can select "Custom," which automatically recalls your personalized sound settings.

- 1 Press the MENU button. Press the ▲ or ▼ button to select "Sound", then press the ENTER button.  
➤ Quick way to access the picture setting: Just press the "S.MODE" button on the remote control.

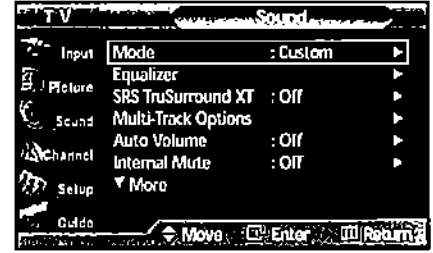

- 2 Press the ENTER button to select "Mode".

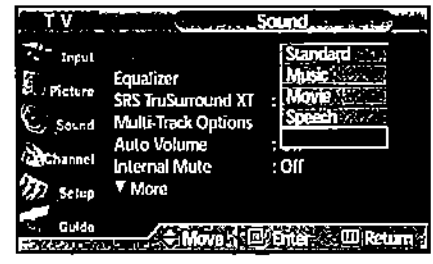

- 3 Press the ▲ or ▼ button to select "Standard", "Music", "Movie", "Speech", or "Custom" sound setting, then press the ENTER button.

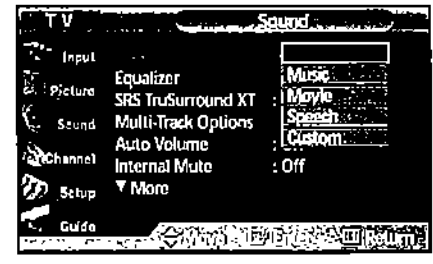

- 4 Press the MENU button to exit.

- Choose Standard for the standard factory settings.
- Choose Music when watching music videos or concerts.
- Choose Movie when watching movies.
- Choose Speech when watching a show that is mostly dialog (i.e., news).
- Choose Custom to recall your personalized settings (see "Customizing the Sound", page 72).



# Setting the TruSurround XT

TruSurround XT is a patented SRS technology that solves the problem of playing 5.1 multichannel content over two speakers. TruSurround delivers a compelling, virtual surround sound experience through any two-speaker playback system, including internal television speakers. It is fully compatible with all multichannel formats.

- 1 Press the MENU button. Press the ▲ or ▼ button to select "Sound", then press the ENTER button.

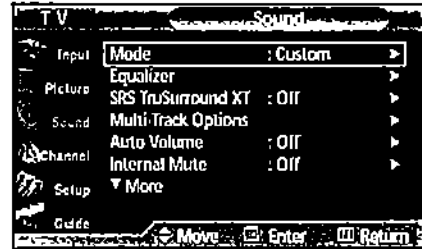

- 2 Press the ▲ or ▼ button to select "SRS TruSurround XT", then press the ENTER button.

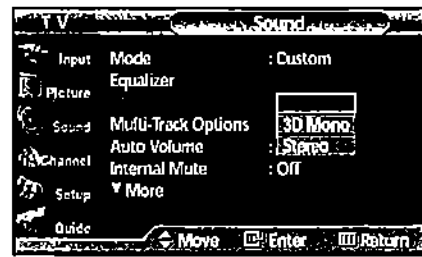

- 3 Press the ▲ or ▼ button to change the setting (Off, 3D Mono, or Stereo), then press the ENTER button.

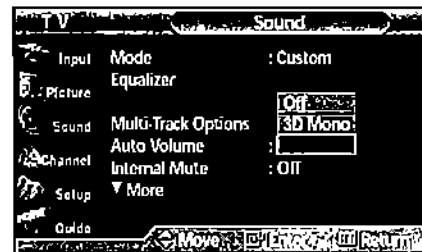

- 4 Press the MENU button to exit.



## Choosing a Multi-Channel Sound (MTS) track - Digital

The digital-TV transmission system is capable of simultaneous transmission of many audio tracks (for example, simultaneous translations of the program into foreign languages). The availability of these additional "multitracks" depends upon the program.

- 1 Press the MENU button. Press the ▲ or ▼ button to select "Sound", then press the ENTER button.

➤ Quick way to access the MTS menu: Just press the "MTS" button on the remote control. You can listen in a language other than the favorite language by pressing the MTS button.

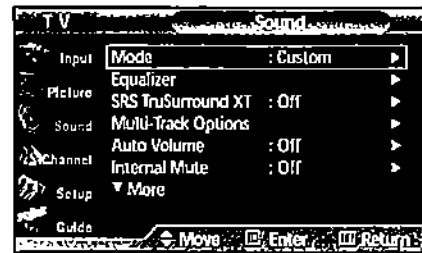

- 2 Press the ▲ or ▼ button to select "Multi-Track Options", then press the ENTER button.



- 3 Press the ENTER button to select "Preferred Language". Press the ▲ or ▼ button to choose the language (English, Spanish, or French) you want, then press the ENTER button.

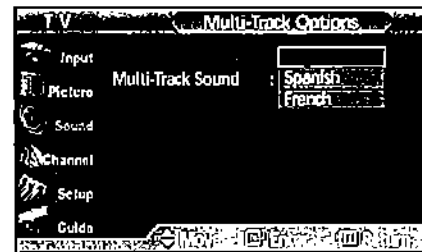

- 4 Press the MENU button to exit.



# Choosing a Multi-Channel Sound (MTS) track - Analog

Depending on the particular program being broadcast, you can listen to Mono, Stereo or SAP.

- 1 Press the MENU button. Press the ▲ or ▼ button to select "Sound", then press the ENTER button.

➤ Quick way to access the MTS menu: Just press the "MTS" button on the remote control repeatedly to select one of the settings.

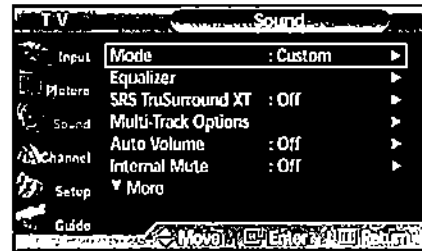

- 2 Press the ▲ or ▼ button to select "Multi-Track Options", then press the ENTER button.



- 3 Press the ▲ or ▼ button to select "Multi-Track Sound", then press the ENTER button. Press the ▲ or ▼ button to select a setting you want, then press the ENTER button.

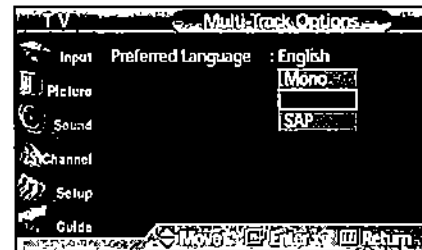

- 4 Press the MENU button to exit.

- Choose "Mono" for channels that are broadcasting in mono, or if you are having difficulty receiving a stereo signal.
- Choose "Stereo" for channels that are broadcasting in stereo.
- Choose "SAP" to listen to the Separate Audio Program, which is usually a foreign-language translation.



## Using the Auto Volume

Each broadcasting station has its own signal conditions, which can make it necessary to adjust the volume every time the channel is changed. "Auto Volume" lets you automatically adjust the volume of the desired channel by lowering the sound output when the modulation signal is high or by raising the sound output when the modulation signal is low.

- 1 Press the MENU button. Press the ▲ or ▼ button to select "Sound", then press the ENTER button.

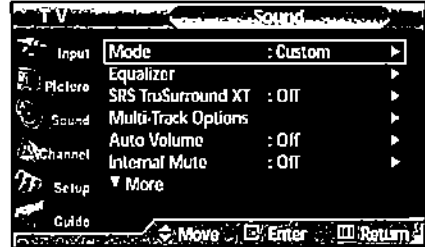

- 2 Press the ▲ or ▼ button to select "Auto Volume", then press the ENTER button.

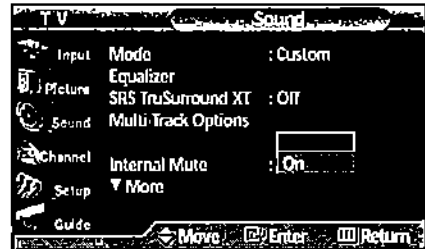

- 3 Press the ▲ or ▼ button to select "On", then press the ENTER button.

- Pressing the ▲ or ▼ button will alternate between "On" and "Off".

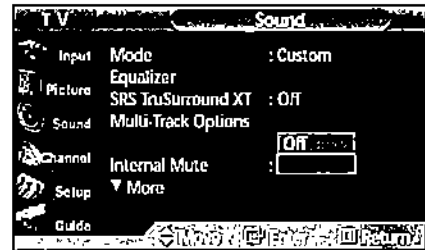

- 4 Press the MENU button to exit.



## Choosing a Digital Sound Format

Digital sound can be output from the rear panel connector on your TV. The digital sound outputs are connectors labeled "Optical" and "Coaxial". After connecting a digital-audio component, you must specify the transmission format (Dolby or PCM, as appropriate to your digital audio component).

- 1 Press the MENU button. Press the ▲ or ▼ button to select "Sound", then press the ENTER button.

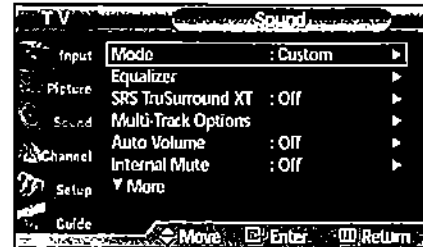

- 2 Press the ▲ or ▼ button to select "Digital Output", then press the ENTER button. Press the ▲ or ▼ button to select "Dolby Digital" or "PCM", then press the ENTER button.

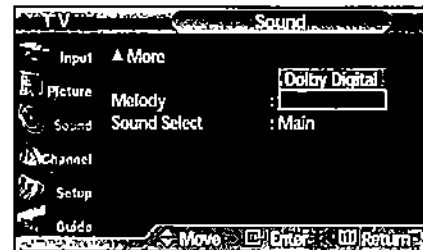

- 3 Press the MENU button to exit.

Manufactured under license from Dolby Laboratories.  
"Dolby" and the double D-symbol are trademarks of Dolby Laboratories.



## Setting the On/Off Melody

A melody sound can be set to come on when the TV is powered On or Off.

- 1 Press the MENU button. Press the ▲ or ▼ button to select "Sound", then press the ENTER button.

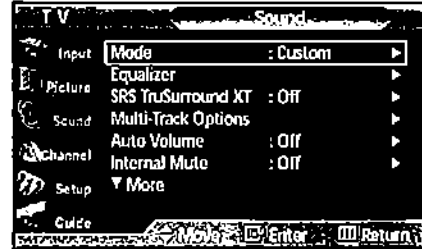

- 2 Press the ▲ or ▼ button to select "Melody", then press the ENTER button. Press the ▲ or ▼ button to select "On" or "Off", then press the ENTER button.

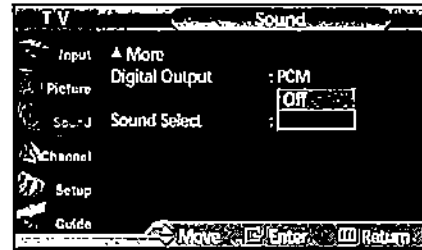

- 3 Press the MENU button to exit.



# Selecting the Internal Mute

Sound output from the TV speakers is muted.

- 1 Press the MENU button. Press the ▲ or ▼ button to select "Sound", then press the ENTER button.

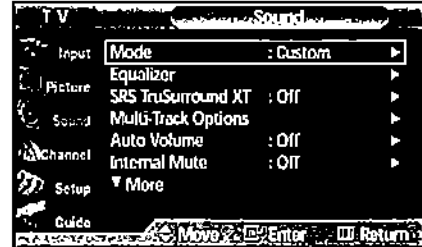

- 2 Press the ▲ or ▼ button to select "Internal Mute", then press the ENTER button.

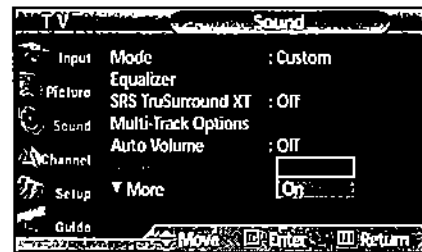

- 3 Press the ▲ or ▼ button to select "On", then press the ENTER button.

- Pressing the ▲ or ▼ button will alternate between "On" and "Off".

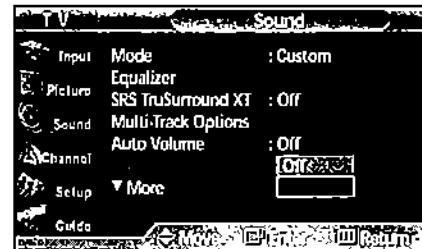

- 4 Press the MENU button to exit.

## ***Notes***

- When Internal mute is set to "On", Sound menus except Multi-track option cannot be adjusted.
- The monitor and digital audio outputs (Optical, Coaxial) remain enabled.



P L A S M A   D I S P L A Y   P A N E L

# Channel Control



Selecting the Antenna .....	82
Selecting Your Favorite Channels .....	83
Labeling the Channels .....	84
Viewing the Channel Lists.....	85
Editing the Channel Lists .....	86
Fine Tuning Analog Channels .....	87
Checking the Digital-Signal Strength .....	88
LNA (Low Noise Amplifier).....	89



# Selecting the Antenna

- 1 Press the MENU button. Press the ▲ or ▼ button to select "Channel", then press the ENTER button.

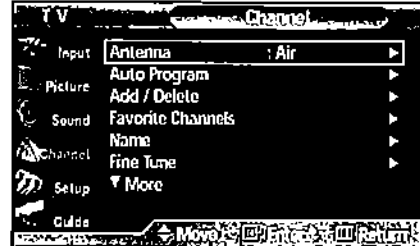

- 2 Press the ENTER button to select "Antenna". Press the ▲ or ▼ button to select "Air" or "Cable", then press the ENTER button.

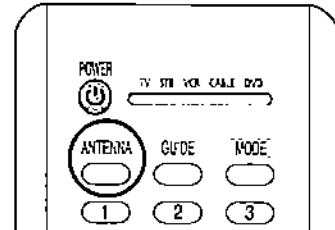

## Notes

- If the antenna is connected to ANT 1 IN (CABLE IN), select "CABLE" and if it is connected to ANT 2 IN (AIR IN), select "Air".

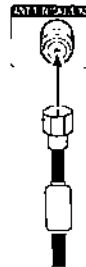

OR

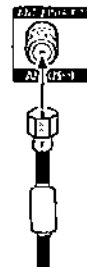

- If both ANT 1 IN and ANT 2 IN are connected, select the antenna input you want. If the antenna input is not selected properly, noise may appear on the screen.

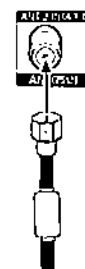
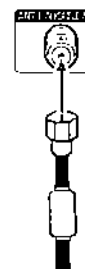



## Selecting Your Favorite Channels

You can store of your favorite channels for each available input source (such as TV and Cable box). Then, when you press the FAV.CH button on the remote control, the TV displays only the favorite channels you previously stored, allowing you to quickly and easily find frequently watched channels.

### To Store Your Favorite Channels:

- 1 Press the MENU button.  
Press the ▲ or ▼ button to select "Channel", then press the ENTER button.



- 2 Press the ▲ or ▼ button to select "Favorite Channels", then press the ENTER button.

Press the ▲ or ▼ button to select a channel as a favorite channel, then press the ENTER button. Press the ENTER button again to deselect the selected channel.

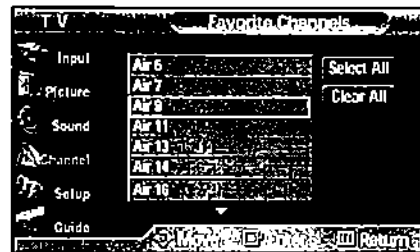

- 3 Press the MENU button to exit.

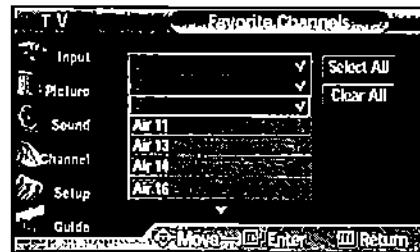

### Notes

- Only memorized channels can be set as favorite channels.
- Select All : Press to select all channels.
- Clear All : Press to clear all channels.

### To View Your Favorite Channels:

Press the FAV.CH button repeatedly to jump from one favorite channel to another.

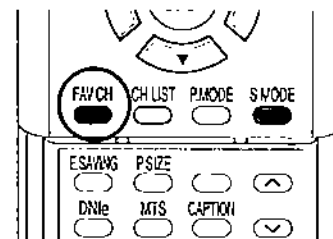



# Labeling the Channels

Use this feature to assign an easy-to-remember label to any channel (i.e., "CBS", "ESPN", "PBS2", "CNN1", etc.) A label consists of five fields, where each field is a letter, a number or a blank. When the INFO button is pressed, the channel label will appear next to the channel number.

- 1 Press the MENU button.  
Press the ▲ or ▼ button to select "Channel", then press the ENTER button.

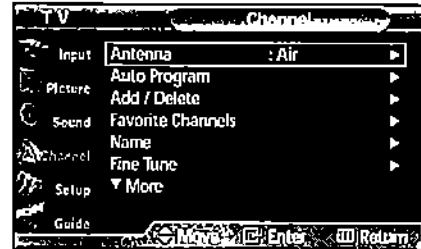

- 2 Press the ▲ or ▼ button to select "Name", then press the ENTER button.

Press the ▲ or ▼ button to select the channel to be assigned to a new name, then press the ENTER button.

Press the ▲ or ▼ button to select a letter, a number or a blank (Results in this sequence: A...Z, 0...9, +, -, ], /, blank).

Press the ► button to switch to the next field, which will be selected.

Select a second letter or digit by pressing the ▲ or ▼ button, as above.

Repeat the process to select the last two digits.

When you have finished, press the ENTER button to assign the new name.

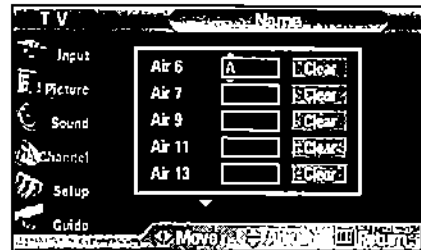
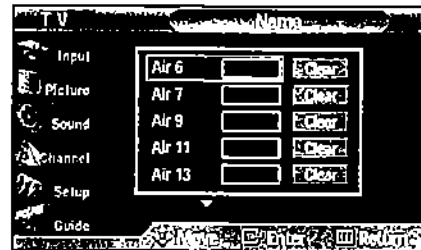

- 3 Press the MENU button to exit.

## Notes

- The names of digital broadcasting channels are automatically assigned and thus cannot be assigned by users.
- When you use CableCARD to watch cable broadcasting, it might take some time for a channel name to be displayed due to data-receiving time.



## Viewing the Channel Lists

You can display a list of all channels or your favorite channels.

- 1 Press the MENU button.  
Press the ▲ or ▼ button to select "Channel", then press the ENTER button.

➤ Quick way to view the Channel Lists: Just press the "CH.LIST" button on the remote control.

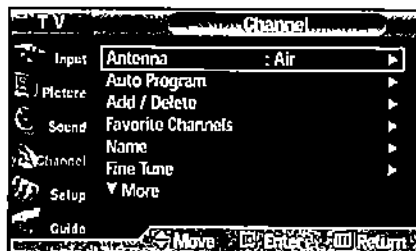

- 2 Press the ▲ or ▼ button to select "Channel List", then press the ENTER button.

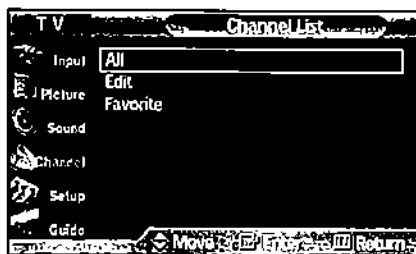

- 3 Press the ▲ or ▼ button to select "All" or "Favorite", then press the ENTER button.

To toggle between your favorite channels or all channels, use the yellow button on the remote control.

- Red button : Press to display the previous channel list page.

Green button : Press to display the next channel

Yellow button : Press to toggle between your favorite channels or all channels.

Blue or EXIT button : Press to exit.

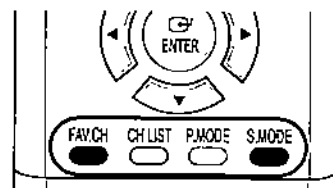
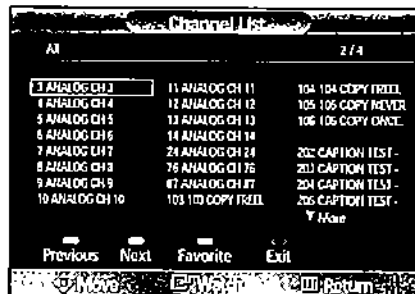

### Alternate method :

Press the CH.LIST button on the remote control to display a list of channels.

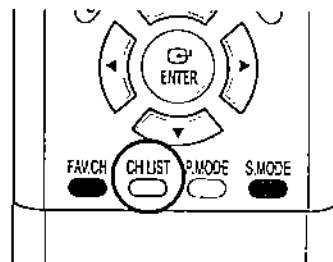



# Editing the Channel Lists

You can edit channels to be added or deleted.

- 1 Press the MENU button.  
Press the ▲ or ▼ button to select "Channel", then press the ENTER button.

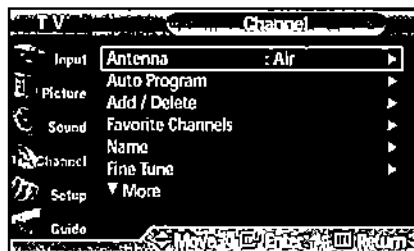

- 2 Press the ▲ or ▼ button to select "Channel List", then press the ENTER button.

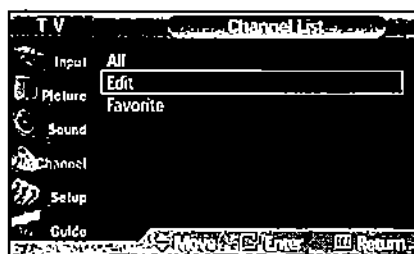

- 3 Press the ▲ or ▼ button to select "Edit", then press the ENTER button.

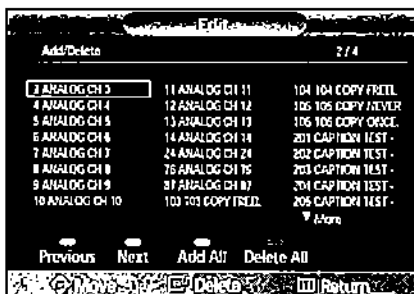

- 4 Press the ▲ or ▼ button to select "Channel" and the ENTER button. Then, the channel can be deleted or added and you can see it dim in case of the deleted channel number.

- Red button : Press to display the previous channel list page.  
Green button : Press to display the next channel  
Yellow button : Press to toggle between your favorite channels or all channels.  
Blue or EXIT button : Press to exit.

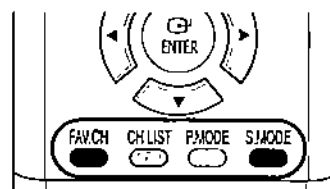
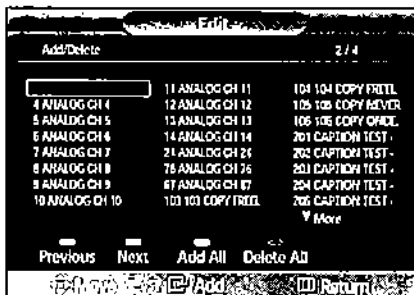

- 5 Press the MENU button to exit.

# PLASMA Display



## Fine Tuning Analog Channels

Use fine tuning to manually adjust a particular channel for optimal reception.

1 Press the MENU button. Press the ▲ or ▼ button to select "Channel", then press the ENTER button.

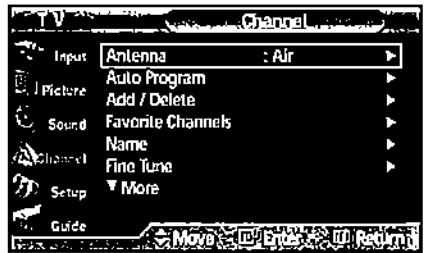

2 Press the ▲ or ▼ button to select "Fine Tune", then press the ENTER button.

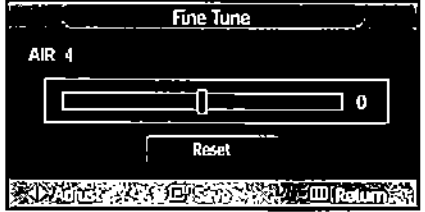

3 Press the ◀ or ▶ button to adjust the fine tuning. To store the fine tuning setting in the TV's memory, press the ENTER button.

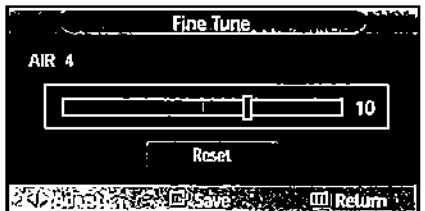

4 To reset the fine tuning setting, press the ▼ button to select "Reset", then press the ENTER button.



5 Press the MENU button to exit.

### Notes

- Only analog TV channels can be fine tuned.
- "•" will appear next to the name of fine-tuned channels.



## Checking the Digital-Signal Strength

Unlike analog channels, which can vary in reception quality from "snowy" to clear, digital (HDTV) channels have either perfect reception quality or you will not receive them at all. So, unlike analog channels, you cannot fine tune a digital channel. You can, however, adjust your antenna to improve the reception of available digital channels.

- 1 Press the MENU button.  
Press the ▲ or ▼ button to select "Channel", then press the ENTER button.

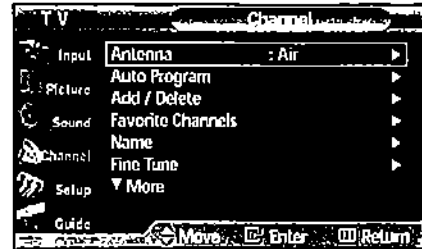

- 2 Press the ▲ or ▼ button to select "Signal Strength", then press the ENTER button.

If the signal strength meter indicates that the signal is weak, physically adjust your antenna to increase the signal strength.

Continue to adjust the antenna until you find the best position with the strongest signal.

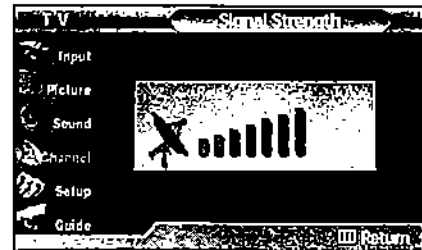

- 3 Press the MENU button to exit.





## LNA (Low Noise Amplifier)

If the TV is operating in a weak-signal area, sometimes the LNA function can improve the reception (a low-noise preamplifier boosts the incoming signal).

- 1 Press the MENU button. Press the ▲ or ▼ button to select "Channel", then press the ENTER button.

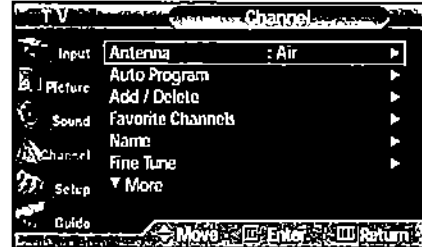

- 2 Press the ▲ or ▼ button to select "LNA", then press the ENTER button.

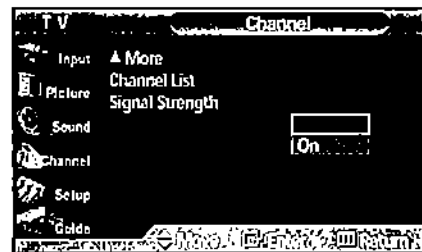

- 3 Press the ▲ or ▼ button to select "On", then press the ENTER button.

- Pressing the ▲ or ▼ button will alternate between "On" and "Off".

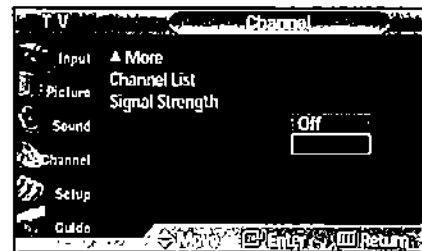

- 4 Press the MENU button to exit.

### **Note**

- LNA functions only when antenna is set to AIR and the settings will be stored separately in each channel. (See "Selecting the Antenna" on page 82.)



P L A S M A   D I S P L A Y   P A N E L

## Connecting a PC and Operation



Connecting a PC.....	92
Changing the Position of the Image.....	96
Picture Quality Adjustment .....	97
Image Reset .....	100



# Connecting a PC

Connection to a Macintosh computer may require an adapter.

TV

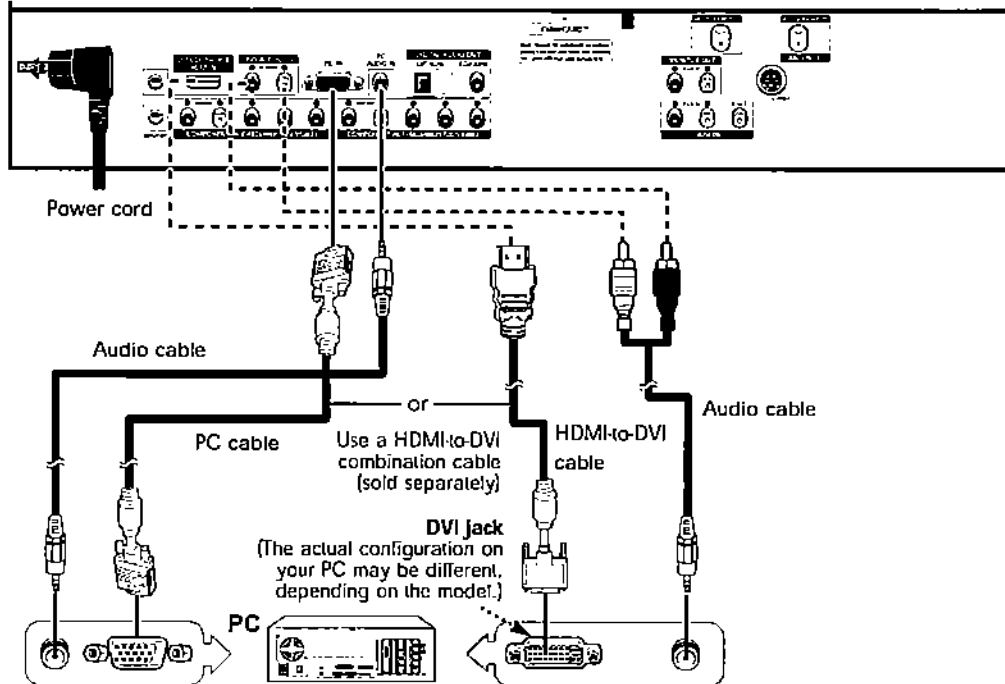

## Connecting a PC (15p D-SUB) to the TV

- 1 Connect a PC cable between the PC Output jack on the PC and the RGB input jack (PC IN) on the TV.
- 2 Connect a Audio cable between the Audio jack on the PC and the Audio input jacks (PC AUDIO IN) on the TV.

## Connecting a PC (DVI) to the TV

- 1 Connect a HDMI-to-DVI cable between the PC DVI jack on the PC and the HDMI input jack on the TV.
- 2 Connect a Audio cable between the Audio jack on the PC and the Audio L/R input (DVI AUDIO IN) jacks on the TV.

### Note

- Please be sure to match the color coded input terminals and cable jacks.

### To watch the PC screen:

1. Turn on your TV.
2. Press the SOURCE button on the remote control or SOURCE button on the front panel to select "PC".
3. Turn on your PC and check for PC system requirements. (Refer to pages 94 and 95 for PC system requirements.)
4. Adjust the PC screen. (Refer to pages 96 and 98.)

# PLasma Display

## Setting up Your TV (Plug and Play)

Our adoption of the new VESA- Plug and Play solution eliminates complicated and time consuming setup. It allows you to install your monitor in a Plug and Play compatible system, without the usual setup hassles and confusion. Your PC system can easily identify and configure itself for use with your display. This monitor automatically tells the PC system its Extended Display Identification data (EDID) using Display Data Channel (DDC) protocols.

## How to Set up Your PC Software (Windows only)

The Windows display-settings for a typical computer are shown below. But the actual screens on your PC will probably be different, depending upon your particular version of Windows and your particular video card. But even if your actual screens look different, the same, basic set-up information will apply in almost all cases. (If not, contact your computer manufacturer or Samsung Dealer.)

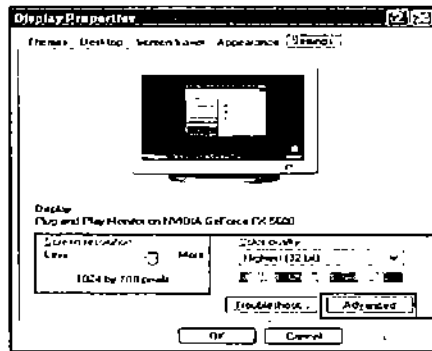
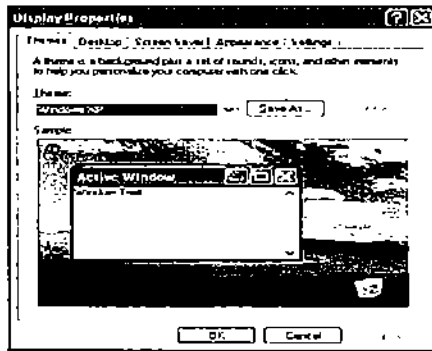

2

3

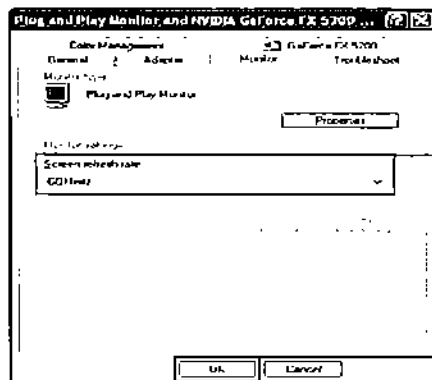

4

5

1 Right click the mouse on the Windows Desktop, then click on Properties. The **Display Dialog-Box** will be displayed.

2 Click on **Settings**, then set the **Display Mode** with reference to the Display Modes Table. You do not need to change the **Colours** settings.

3 Click on **Advanced**. A new settings dialog box will be displayed.

4 Click on the **Monitor** tab, then set the **Screen Refresh Rate** with reference to the Display Modes Table. Set the **Vertical Frequency** and **Horizontal Frequency** individually if you can do so instead of setting the **Screen Refresh Rate**.

5 Press the **OK** button, close the window, then press the **OK** button on the **Display Registration Information** window. Automatic re-booting may commence at this moment.

6 Shutdown the PC, and connect it to your TV. (See page 92)

- The actual screens on your PC may look different, depending on your particular version of Windows and the type of your PC.
- When you use your TV as a PC monitor, it supports Colours up to 32 bits.
- In this case, the display on the TV may look different depending on your particular version of Windows or the PC manufacturer.
- When connecting a PC (including the DVI connection), you must set it to the display settings that are supported by the TV. Otherwise, the message **Out of input range** will be displayed.

# PLasma Display

## **Notes**

Both screen position and size will vary, depending on the type of PC monitor and its resolution. The table below shows all of the display modes that are supported:

Video Signal	Resolution (Dot X Line)	Vertical Frequency(Hz)	Horizontal Frequency(KHz)	Vertical Polarity	Horizontal Polarity
IBM PC / AT Compatible	720 X 400	70.087	31.469	P	N
	640 X 480	59.940	31.469	N	N
		72.809	37.861	N	N
		75.000	37.5	N	N
		85.008	43.269	N	N
	800 X 600	56.250	35.156	N/P	N/P
		60.317	37.897	P	P
		72.188	48.077	P	P
		75.000	46.875	P	P
		85.061	53.674	P	P
	1024 X 768	60.004	48.363	N	N
		70.069	56.476	N	N
		75.029	60.023	P	P
	1280 X 1024	60.020	63.981	P	P

- The interlace mode is not supported.
- The TV operates abnormally if a non-standard video format is selected.
- The table above conforms to IBM/VESA regulations and is based on using the Analog Input.

## **Notes**

- The PC text quality is optimum in XGA mode (1024 x 768@60Hz).
- When this TV is used as a PC display, 32-bit color is supported.
- Depending on the manufacturer, your PC display screen might appear different. (and depending on your particular version of Windows.)  
Check your PC instruction book for information about connecting your PC to a TV.
- If a vertical and horizontal frequency-select mode exists, select 60Hz (vertical) and 48.4KHz (horizontal).
- In some cases, abnormal signals (such as stripes) might appear on the screen when the PC power is turned off (or if the PC is disconnected). If so, press the SOURCE button on the remote control or SOURCE button on the front panel to enter the VIDEO mode. Also, make sure that the PC is connected.
- Connect only a PC monitor to the monitor output port while viewing the PC screen. (Otherwise, random signals might appear).



## Changing the Position of the Image

After connecting the TV to your PC, adjust the position of the screen if it is not well-aligned.

### Preset:

- Press the SOURCE button to select "PC."

1 Press the MENU button. Press the ▲ or ▼ button to select "Setup", then press the ENTER button.

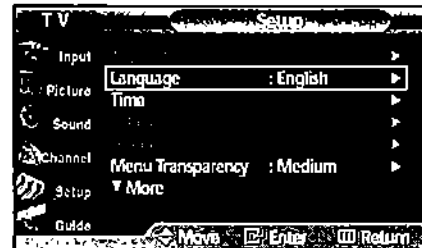

2 Press the ▲ or ▼ button to select "PC", then press the ENTER button.



3 Press the ▲ or ▼ button to select "Position", then press the ENTER button.

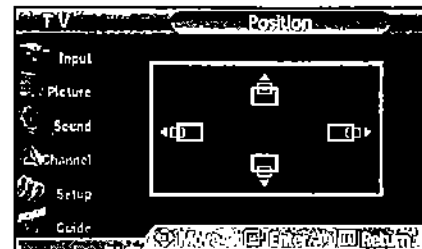

4 Adjust the position of screen by pressing the ▲/▼/◀/▶ button.

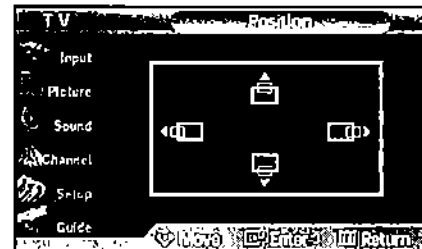

5 Press the MENU button to exit.





## Picture Quality Adjustment

### Picture Automatic Adjustment

**Preset:**

- Press the SOURCE button to select "PC".

- 1 Press the MENU button. Press the ▲ or ▼ button to select "Setup", then press the ENTER button.

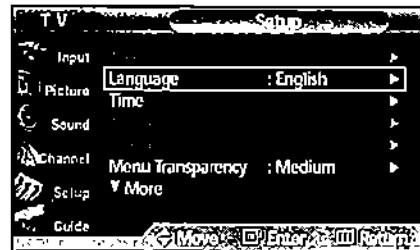

- 2 Press the ▲ or ▼ button to select "PC", then press the ENTER button.

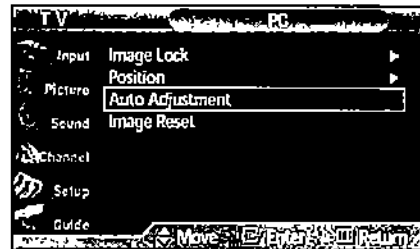

- 3 Press the ▲ or ▼ button to select "Auto Adjustment", then press the ENTER button. The message "Auto Adjustment in progress. Please wait." appears on the screen and the picture adjustments are automatically activated.

Auto Adjustment in progress. Please wait.

# Coarse Adjustment

**Preset:**

- Press the SOURCE button to select "PC".

1 Press the MENU button. Press the ▲ or ▼ button to select "Setup", then press the ENTER button.

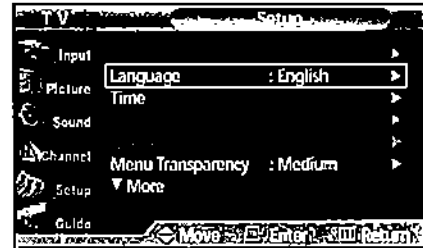

2 Press the ▲ or ▼ button to select "PC", then press the ENTER button.

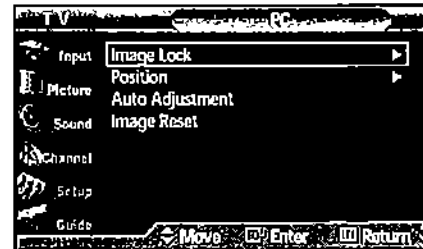

3 Press the ENTER button to select "Image Lock".

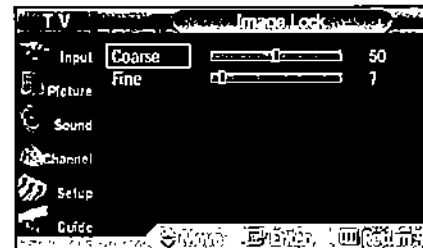

4 Press the ENTER button again to select "Coarse". Remove picture noise (vertical stripes) on the screen by pressing the ◀ or ▶ button. (If Coarse is not set properly, vertical stripes will appear on the screen.)



- Press the ▲ or ▼ button to select another item.

5 Press the MENU button to exit.

# Plasma Display

## Fine Tuning (Fine)

### Preset:

- Press the SOURCE button to select "PC".

1 Press the MENU button. Press the ▲ or ▼ button to select "Setup", then press the ENTER button.

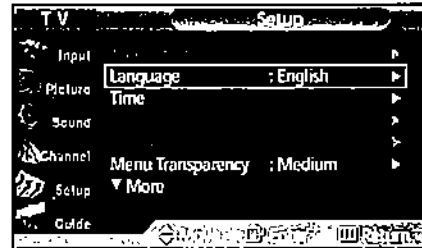

2 Press the ▲ or ▼ button to select "PC", then press the ENTER button.



3 Press the ENTER button to select "Image Lock".

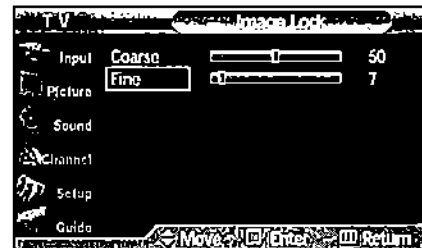

4 Press the ▲ or ▼ button to select "Fine", then press the ENTER button.  
Remove picture noise on the screen by pressing the ◀ or ▶ button. (If Fine is not set properly, noise will appear on the screen.)

- Press the ▲ or ▼ button to select another item.

5 Press the MENU button to exit.





# Image Reset

## Preset:

- Press the SOURCE button to select "PC".

- 1 Press the MENU button. Press the ▲ or ▼ button to select "Setup", then press the ENTER button.

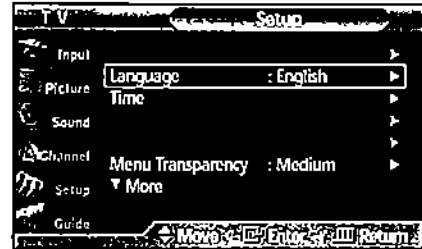

- 2 Press the ▲ or ▼ button to select "PC", then press the ENTER button.



- 3 Press the ▲ or ▼ button to select "Image Reset", then press the ENTER button. The message "Reset..." appears on the screen.



- The previously adjusted settings will be reset to the factory defaults.

P L A S M A   D I S P L A Y   P A N E L

# Time Setting



Setting the Clock .....	102
Setting the Sleep Timer .....	104
Setting the On/Off Timer .....	105



# Setting the Clock

Setting the clock is necessary in order to use the various timer features of the TV. Also, you can check the time while watching the TV. (Just press the INFO button.)

## Option 1: Setting the Clock Manually

- 1 Press the MENU button. Press the ▲ or ▼ button to select "Setup", then press the ENTER button.

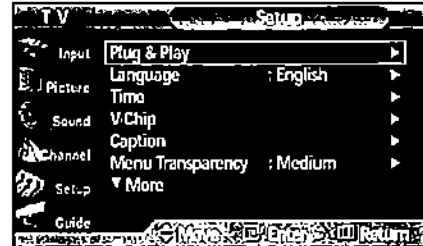

- 2 Press the ▲ or ▼ button to select "Time", then press the ENTER button. Press the ENTER button to select "Clock".

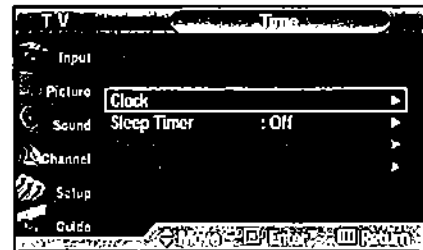

- 3 Press the ENTER button to select "Clock Mode". Press the ▲ or ▼ button to select "Manual", then press the ENTER button.

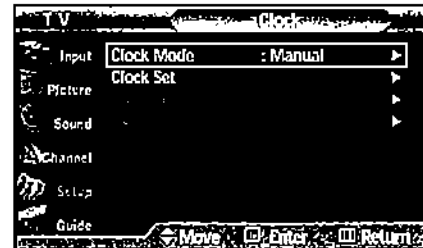

- 4 Press the ▲ or ▼ button to select "Clock Set", then press the ENTER button.

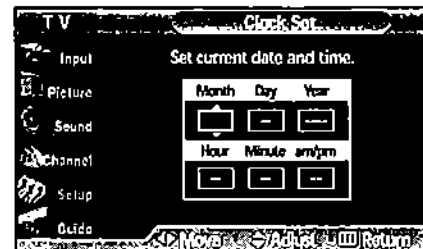

- 5 Press the ◀ or ▶ button to move to "Month", "Day", "Year", "Hour", "Minute", or "am/pm". Set the clock you want by pressing the ▲ or ▼ button, then press the ENTER button.

- 6 Press the MENU button to exit.

### Notes

- The current time will appear every time you press the INFO button.
- You can set the hour and minute directly by pressing the number buttons on the remote control.

# PLASMA Display

## Option 2: Setting the Clock Automatically

The Clock can be set automatically if you are receiving a digital signal.

- 1 Press the MENU button.  
Press the ▲ or ▼ button to select "Setup", then press the ENTER button.

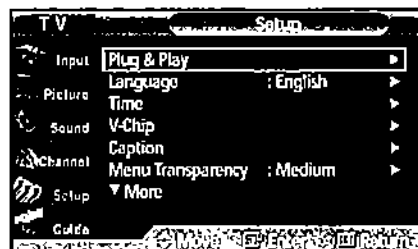

- 2 Press the ▲ or ▼ button to select "Time", then press the ENTER button.  
Press the ENTER button to select "Clock".

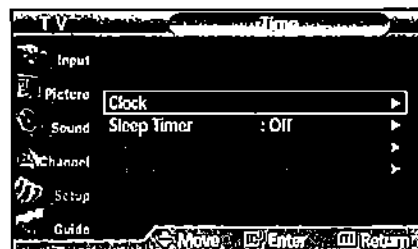

- 3 Press the ENTER button to select "Clock Mode".  
Press the ▲ or ▼ button to select "Auto", then press the ENTER button.

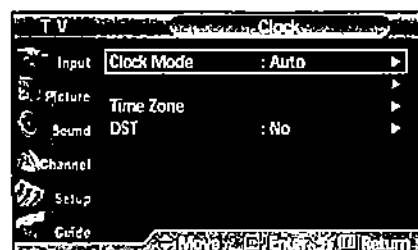

- 4 Press the ▲ or ▼ button to select "Time Zone", then press the ENTER button.

Press the ▲ or ▼ button to highlight the time zone for your local area (and to move the highlight to the appropriate time zone on the map of the United States), then press the enter button.

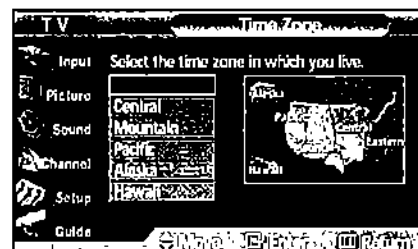

- 5 Press the ▲ or ▼ button to select "DST" (Daylight Saving Time), then press the ENTER button.  
Press the ▲ or ▼ button to select "Yes" or "No", then press the ENTER button.

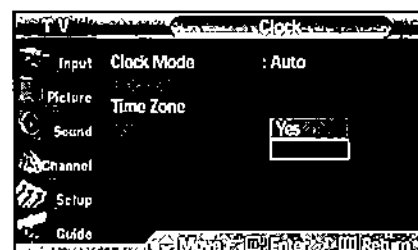

- 6 Press the MENU button to exit.

### Note

- Depending on the broadcast station and signal, the auto time may not be set correctly. If this occurs, set the time manually.

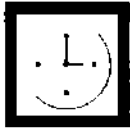

# Setting the Sleep Timer

The sleep timer automatically shuts off the TV after a preset time (from 30 to 180 minutes).

- 1 Press the MENU button. Press the ▲ or ▼ button to select "Setup", then press the ENTER button.



- 2 Press the ▲ or ▼ button to select "Time", then press the ENTER button.

Press the ▲ or ▼ button to select "Sleep Timer", then press the ENTER button.

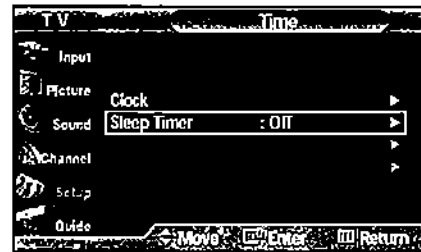

- 3 Press the ▲ or ▼ button to adjust "Minute".

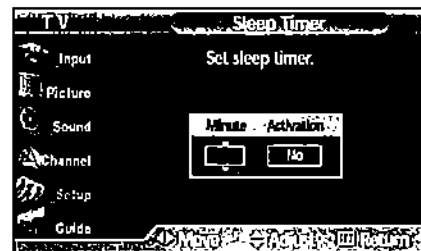

- 4 Press the ► button to select "Activation". Press the ▲ or ▼ button to select "Yes", then press the ENTER button.



- 5 Press the MENU button to exit.





## Setting the On/Off Timer

- 1 Press the MENU button.  
Press the ▲ or ▼ button to select "Setup", then press the ENTER button.



- 2 Press the ▲ or ▼ button to select "Time", then press the ENTER button.

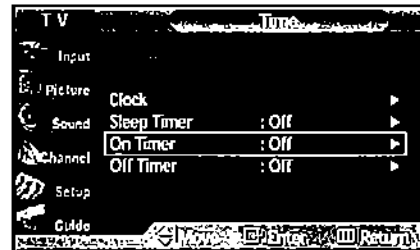

- Press the ▲ or ▼ button to select "On Timer", then press the ENTER button.  
Press the ▲ or ▼ button to adjust "Hour", then press the ► button to move to the next step.  
Set other items using the same method as above.

When finished, press the MENU button to return.

- The current time will appear every time you press the INFO button.
- You can set the hour and minute directly by pressing the number buttons on the remote control.

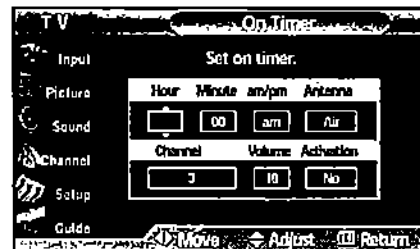

- 3 Press the ▲ or ▼ button to select "Off Timer", then press the ENTER button.  
Press the ▲ or ▼ button to adjust "Hour", then press the ► button to move to the next step.  
Set other items using the same method as above.

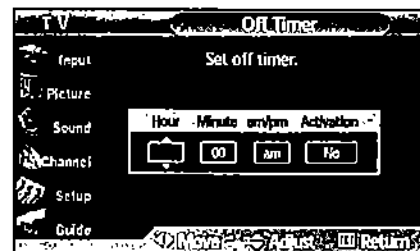

When finished, press the ENTER button.

- 4 Press the MENU button to exit.



P L A S M A   D I S P L A Y   P A N E L

# Function Description



Selecting a Menu Language .....	108
Digital Noise Reduction .....	109
Selecting the Film Mode .....	110
Setting the Blue Screen .....	111
Using the Color Weakness Enhancement Option .....	112
Viewing Closed Captions (On-Screen Text Messages) - Analog...	113
Viewing Closed Captions (On-Screen Text Messages) - Digital....	114
Menu Transparency Level .....	116
Using the Energy Saving feature .....	117
Preventing Screen Burn-in .....	118
Setting the Function Help .....	120
Using the V-Chip .....	121
Electronic Program Guide .....	127
Reminder List .....	131
Using the CableCARD .....	133
Using the CableCARD Setup Function.....	134



## Selecting a Menu Language

- 1 Press the MENU button. Press the ▲ or ▼ button to select "Setup", then press the ENTER button.

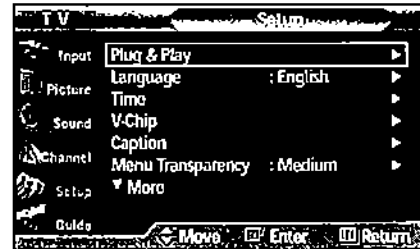

- 2 Press the ENTER button to select "Language".



- 3 Press the ▲ or ▼ button to select the appropriate language: "English", "Spanish", or "French". Press the ENTER button.

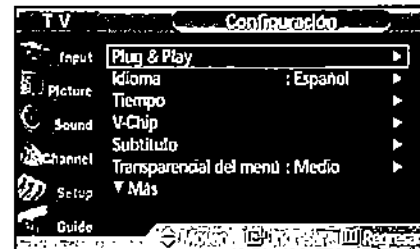

- 4 Press the MENU button to exit.



## Digital Noise Reduction

If the broadcast signal received by your TV is weak, you can activate the Digital Noise Reduction feature to help reduce any static and ghosting that may appear on the screen.

1 Press the MENU button. Press the ▲ or ▼ button to select "Picture", then press the ENTER button.

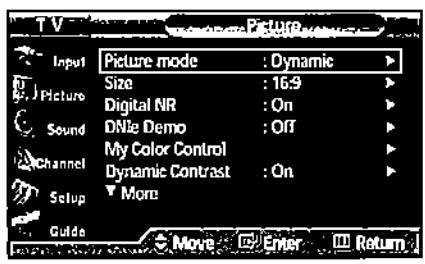

2 Press the ▲ or ▼ button to select "Digital NR", then press the ENTER button.

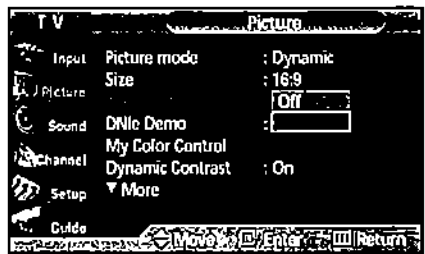

3 Press the ▲ or ▼ button to select "On" or "Off", then press the ENTER button.

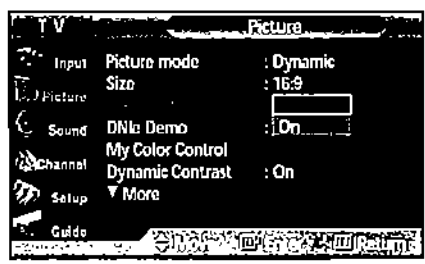

4 Press the MENU button to exit.



## Selecting the Film Mode

On: Automatically senses and processes film signals from all sources and adjusts the picture for optimum quality.

Off: Switches off the Film mode.

- 1 Press the MENU button. Press the ▲ or ▼ button to select "Picture", then press the ENTER button.

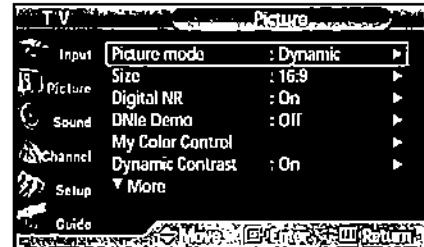

- 2 Press the ▲ or ▼ button to select "Film Mode", then press the ENTER button.

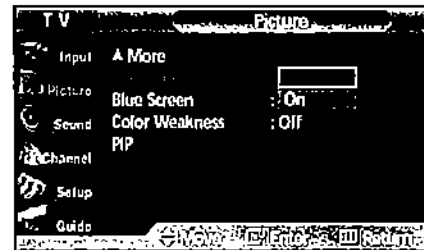

- 3 Press the ▲ or ▼ button to select "On" or "Off", then press the ENTER button.

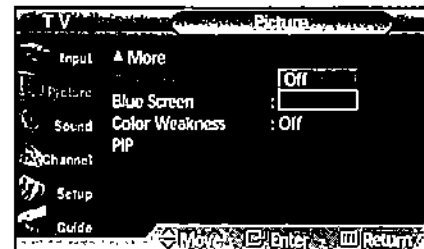

- 4 Press the MENU button to exit.

### **Note**

- Film Mode is supported in TV, VIDEO, S-VIDEO and COMPONENT 480i.



## Setting the Blue Screen

If no signal is being received or the signal is very weak, a blue screen automatically replaces the noisy picture background. If you wish to continue viewing the poor picture, you must set the "Blue Screen" mode to "Off".

- 1 Press the MENU button. Press the ▲ or ▼ button to select "Picture", then press the ENTER button.

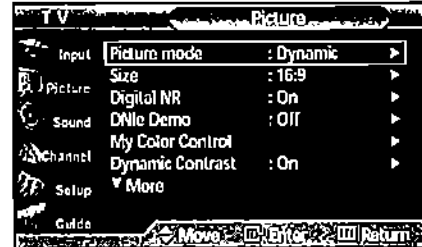

- 2 Press the ▲ or ▼ button to select "Blue Screen", then press the ENTER button.

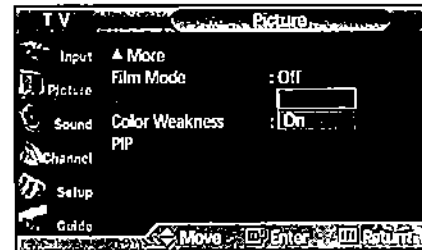

- 3 Press the ▲ or ▼ button to select "On" or "Off", then press the ENTER button.

- Blue Screen is displayed when there is no signal from an external device in the External Mode, regardless of the Blue Screen Setting.

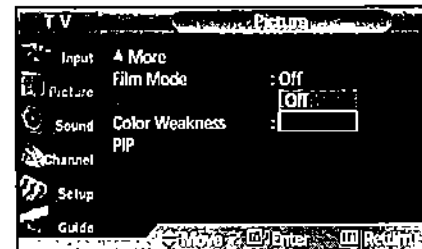

- 4 Press the MENU button to exit.



# Using the Color Weakness Enhancement Option

This option adjusts the Red, Blue or Green color to enhance the image according to the user's particular color weakness.

- 1 Press the MENU button. Press the ▲ or ▼ button to select "Picture", then press the ENTER button.

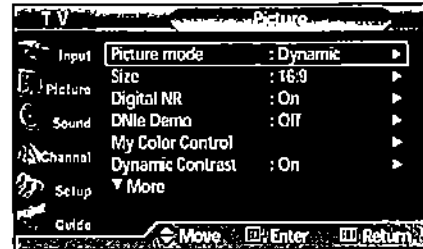

- 2 Press the ▲ or ▼ button to select "Color Weakness", then press the ENTER button.

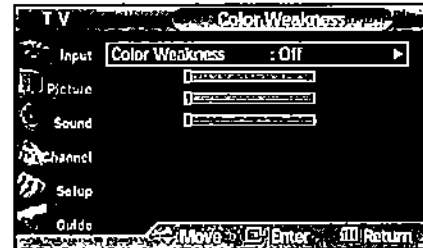

- 3 Press the ENTER button. Press the ▲ or ▼ button to select "On", then press the ENTER button. You will also see the items "Red", "Green", and "Blue".

- Pressing the ▲ or ▼ button will alternate between "On" and "Off".

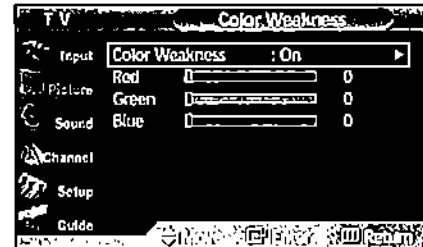

- 4 Press the ▲ or ▼ button to select the item you wish to change, then press the ENTER button. Press the ◀ or ▶ button to change the value of the item, then press the ENTER button.

Press the ▲ or ▼ button to select another item.



- 5 Press the MENU button to exit.



# PLASMA Display



## Viewing Closed Captions (On-Screen Text Messages) - Analog

The Analog Caption function operates in either analog RF channel mode or external signal mode.

- 1 Press the Menu button. Press the ▲ or ▼ button to select "Setup", then press the ENTER button.

➤ Quick way to select Caption: Simply press the "CAPTION" button under the cover of the remote control.

- 2 Press the ▲ or ▼ button to select "Caption", then press the ENTER button.

- 3 Press the ENTER button to select "Caption". Press the ▲ or ▼ button to select "On", then press the ENTER button.

- 4 Press the ▲ or ▼ button to select "Caption Mode", then press the ENTER button. Press the ▲ or ▼ button to select submenu (CC1-CC4 or Text1-Text4) you want, then press the ENTER button.

- The default is "CC1".  
CC1 : The Primary Synchronous Caption Service. These are captions in the primary language that must be in sync with the sound, preferably matched to a specific frame.
- CC2 : The Special Non-Synchronous Use Captions. This channel carries data that is intended to augment information carried in the program.
- CC3 : Secondary Synchronous Caption Service. Alternate program-related caption data, typically second language captions.
- CC4 : Special Non-Synchronous Use Captions. Similar to CC2.

- 5 Press the MENU button to exit.

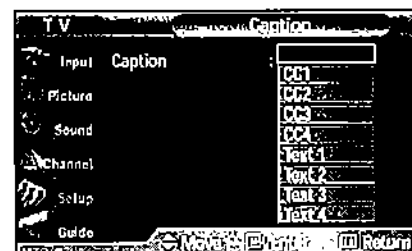
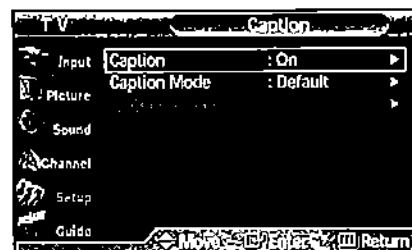
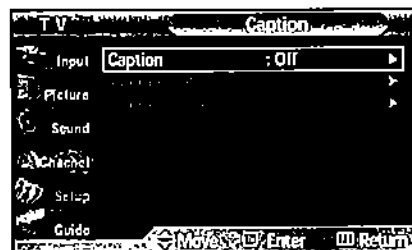
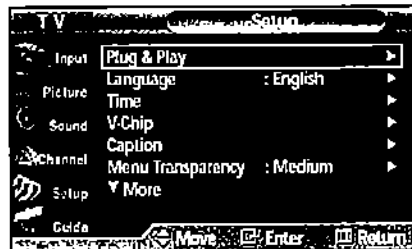

### Notes

- The Caption feature doesn't work in COMPONENT(480p, 720p, 1080i), HDMI modes.
- The availability of captions depends on the program being broadcast.



# Viewing Closed Captions (On-Screen Text Messages) - Digital

The Digital Captions function operates on digital channels.

- 1 Press the MENU button.  
Press the ▲ or ▼ button to select "Setup", then press the ENTER button.



- 2 Press the ▲ or ▼ button to select "Caption", then press the ENTER button.

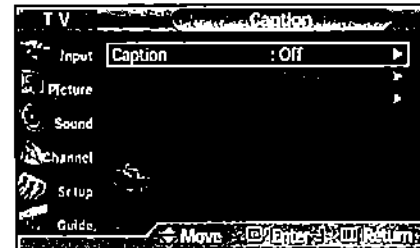

- 3 Press the ENTER button to select "Caption".  
Press the ▲ or ▼ button to select "On", then press the ENTER button.

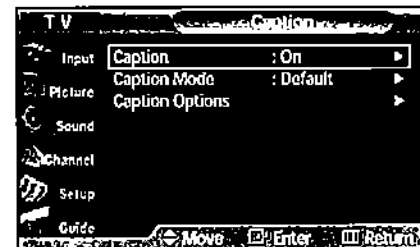

- 4 Press the ▲ or ▼ button to select "Caption Mode", then press the ENTER button.  
Press the ▲ or ▼ button to select submenu (Service1~Service6, CC1~CC4 or Text1~Text4) you want, then press the ENTER button.

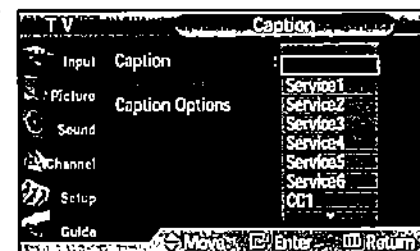

- 5 Press the ▲ or ▼ button to select "Caption Options", then press the ENTER button.

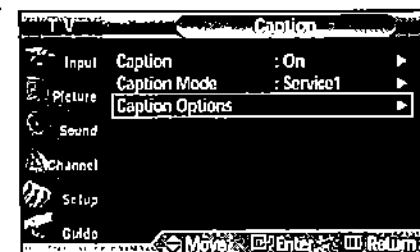

## Notes

- "Caption Options" are available only when "Service1~Service6" can be selected in "Caption Mode".
- Service1~6 in digital caption mode may not be available according to the broadcasting type.

# 10.6.2 Plasma Display

6 Press the ▲ or ▼ button to select "Size", then press the ENTER button.

Press the ▲ or ▼ button to select the desired Caption option, then press the ENTER button.

Press the ▲ or ▼ button to select the desired sub-menu options(see options below), then press ENTER.

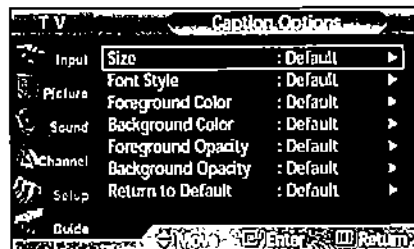

### Notes

- The availability of captions depends on the program being broadcast.
- The "Default" means to follow the rule of broadcasting.

7 Press the MENU button to exit.

- **Size**  
This option consists of "Default", "Small", "Standard", and "Large". The default is "Standard".
- **Font Style**  
This option consists of "Default", "Style 0 – Style 7". You can change the font you want. The default is "Style 0".
- **Foreground Color**  
This option consists of "Default", "White", "Black", "Red", "Green", "Blue", "Yellow", "Magenta", and "Cyan". You can change the color of the letter. The default is "White".
- **Background Color**  
This option consists of "Default", "White", "Black", "Red", "Green", "Blue", "Yellow", "Magenta", and "Cyan". You can change the background color of the caption. The default is "Black".
- **Foreground Opacity**  
This option consists of "Default", "Transparent", "Translucent", "Solid", and "Flashing". You can change the opacity of the letter.
- **Background Opacity**  
This option consists of "Default", "Transparent", "Translucent", "Solid", and "Flashing". You can change the background opacity of the caption.
- **Return to Default**  
This option sets each of "Size", "Font Style", "Foreground Color", "Background color", "Foreground Opacity", and "Background Opacity" to its default.

### **Alternate method:**

Press the CAPTION button on the remote control repeatedly to select "On" or "Off".





# Menu Transparency Level

Adjusts the transparency of the menu screen.

- 1 Press the MENU button.  
Press the ▲ or ▼ button to select "Setup", then press the ENTER button.



- 2 Press the ▲ or ▼ button to select "Menu Transparency", then press the ENTER button.  
Press the ▲ or ▼ button to select level, then press the ENTER button.

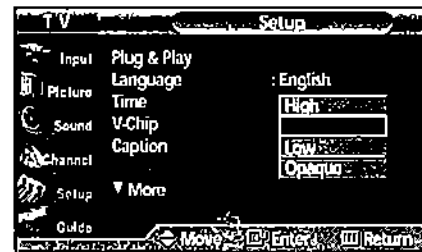

- 3 Press the MENU button to exit.



## Using the Energy Saving Feature

This feature adjusts the screen brightness automatically depending on the surrounding lighting conditions.

- 1 Press the MENU button. Press the ▲ or ▼ button to select "Setup", then press the ENTER button.

➤ Quick way to select Energy Saving: Simply press the "ENERGY SAVING" button under the cover of the remote control.

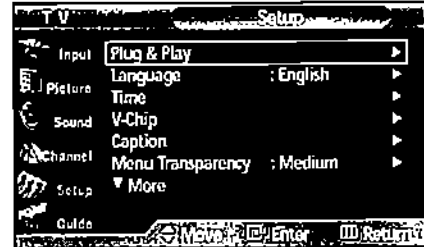

- 2 Press the ▲ or ▼ button to select "Energy Saving", then press the ENTER button.

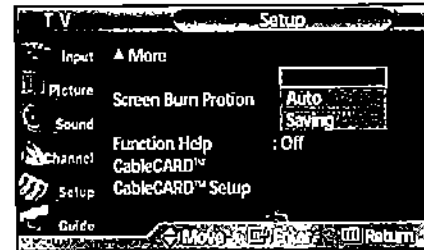

- 3 Press the ▲ or ▼ button to select submenu (Standard, Auto, or Saving) on want, then press the ENTER button.

- Standard : Operates in standard mode regardless of the surrounding illumination.
- Auto : Automatically adjusts to the surrounding illumination.
- Saving : Forcibly enters maximum power saving mode regardless of the surrounding illumination.

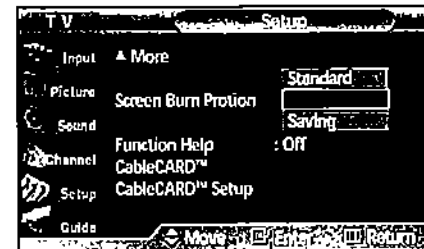

- 4 Press the MENU button to exit.



# Preventing Screen Burn-in

You can prevent image burn-in on the TV screen.

- 1 Press the MENU button.  
Press the ▲ or ▼ button to select "Setup", then press the ENTER button.



- 2 Press the ▲ or ▼ button to select "Screen Burn Protection", then press the ENTER button.

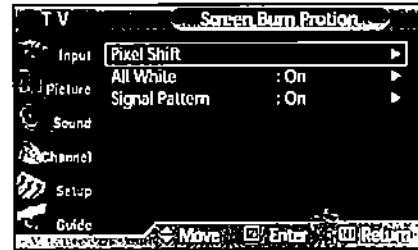

- 3 Press the ENTER button to select "Pixel Shift", then press the ENTER button.

- Pressing the ▲ or ▼ button will alternate between "On" and "Off".  
You will also see the items "Horizontal Dot", "Vertical Line" and "Time".

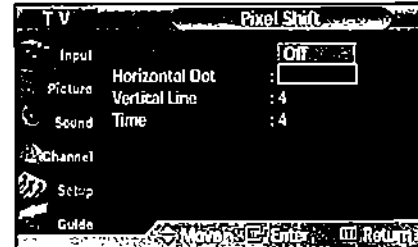

- 4 Press the ▲ or ▼ button to select the item you wish to change, then press the ENTER button.  
Press the ▲ or ▼ button to change the value of the item, then press the ENTER button.

- Optimum condition for pixel shift:

Horizontal Dot	2
Vertical Line	4
Time	4

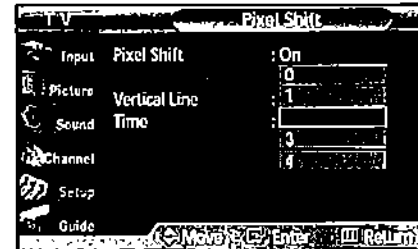

# Plasma Display

- 5 Press the ▲ or ▼ button to select "All White" or "Signal Pattern", then press the ENTER button.

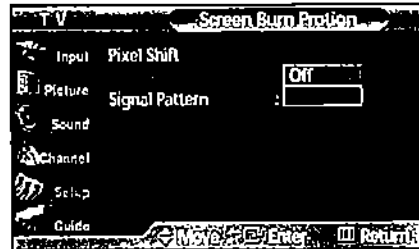

- 6 Press the ▲ or ▼ button to select "On", then press the ENTER button.

- Pressing the ▲ or ▼ button will alternate between "On" and "Off".

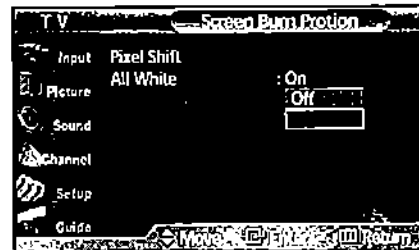

- 7 Press the MENU button to exit.



# Setting the Function Help

Displays help on the menu functions.

- 1 Press the MENU button.  
Press the ▲ or ▼ button to select "Setup", then press the ENTER button.

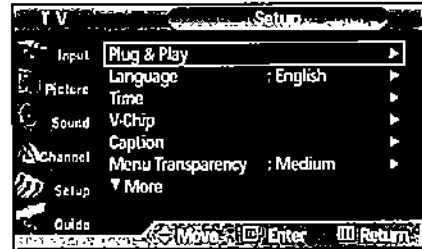

- 2 Press the ▲ or ▼ button to select "Function Help", then press the ENTER button.

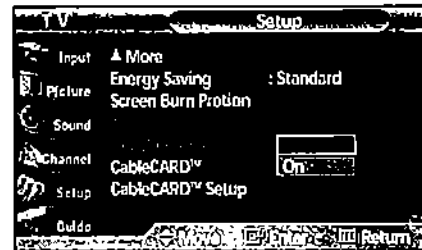

- 3 Press the ▼ button to select "On", then press the ENTER button.

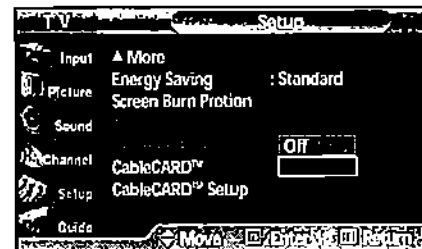

- 4 Press the MENU button to exit.







## Using the V-Chip

The V-Chip feature automatically locks out programs that are deemed inappropriate for children. The user must enter a PIN (personal ID number) before any of the V-Chip restrictions are set up or changed.

- Notes :
- When the V-chip feature is activated, the PIP features do not function.
  - The V-Chip does not work if the input is DTV (HD or SD).

### Setting Up Your Personal ID Number (PIN)

- 1 Press the MENU button. Press the ▲ or ▼ button to select "Setup", then press the ENTER button.

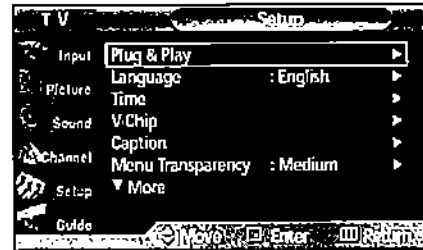

- 2 Press the ▲ or ▼ button to select "V-Chip", then press the ENTER button. The message "Enter PIN" will appear. Enter your 4 digit PIN number.

**Note**

- The default PIN number of a new TV set is "0-0-0-0".

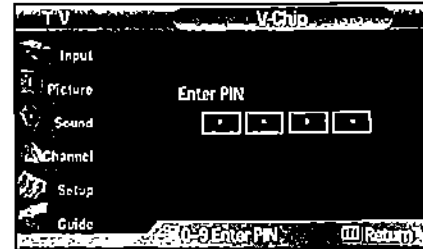

- 3 The "V-Chip" screen will appear. Press the ▲ or ▼ button to select "Change PIN", then press the ENTER button.

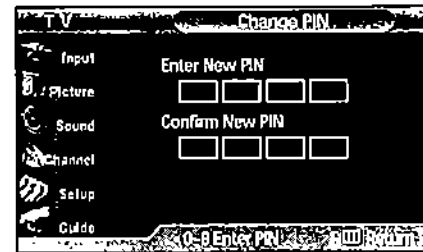

- 4 The Change PIN screen will appear. Choose any 4 digits for your PIN and enter them. As soon as the 4 digits are entered, the "Confirm new PIN" screen appears. Re-enter the same 4 digits. When the Confirm screen disappears, your PIN has been memorized.

- 5 Press the MENU button to exit.

**Note**

- If you forget the PIN, press the remote-control buttons in the following sequence, which resets the pin to 0-0-0-0 : Power Off. → Mute → 8 → 2 → 4 → Power On.

## How to Enable/Disable the V-Chip

- 1 Press the MENU button. Press the ▲ or ▼ button to select "Setup", then press the ENTER button.

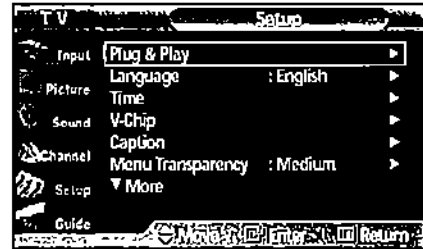

- 2 Press the ▲ or ▼ button to select "V-Chip", then press the ENTER button.  
The message "Enter PIN" will appear.  
Enter your 4 digit PIN number.

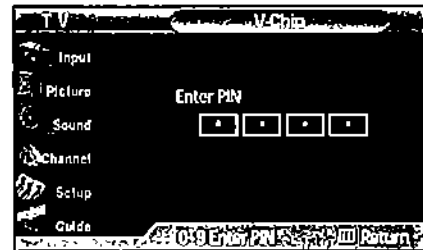

- 3 The "V-Chip" screen will appear. To enable the V-Chip feature, press the ENTER button so that the "V-Chip Lock" field is "On". (Pressing the ▲ or ▼ button will alternate between "On" and "Off".)  
Press the ENTER button.

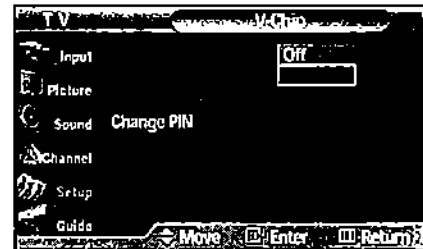

- 4 Press the MENU button to exit.

# Plasma Display

## How to Set up Restrictions using the "TV Parental Guidelines"

First, set up a personal identification number (PIN), and enable the V-Chip. (See previous section.) Parental restrictions can be set up using either of two methods: The TV guidelines or the MPAA rating.

- 1 Press the MENU button. Press the ▲ or ▼ button to select "Setup", then press the ENTER button.

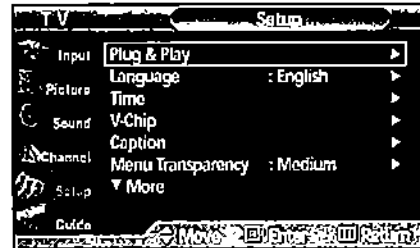

- 2 Press the ▲ or ▼ button to select "V-Chip", then press the ENTER button. The message "Enter PIN" will appear. Enter your 4 digit PIN number.

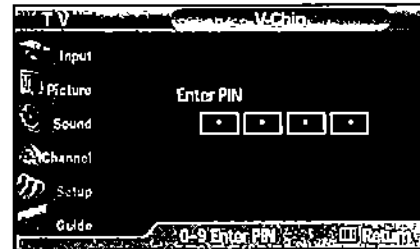

- 3 The "V-Chip" screen will appear. Press the ▲ or ▼ button to select "TV Parental Guidelines", then press the ENTER button.

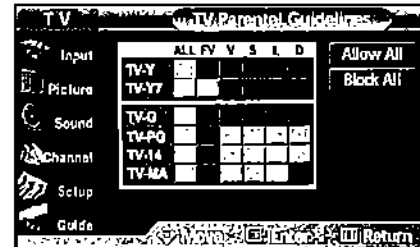



- 4 The "TV Parental Guidelines" screen will appear. Press the ▲ or ▼ button to select one of the six ages based categories:

TV-Y	Young children
TV-Y7	Children 7 and over

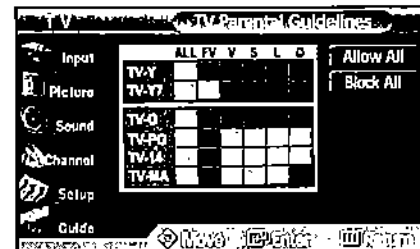
TV-G	General audience
TV-PG	Parental guidance
TV-14	Viewers 14 and over
TV-MA	Mature audience



- 5** At this point, one of the TV-Ratings is selected. Press the ENTER button. Depending on your existing setup, a symbol  will be selected. (Blank = Unblocked,  = Blocked)

While "" is selected, press the ENTER button to block or unblock the category. To select a different TV-Rating, press the ▲ or ▼ button and then repeat the process.

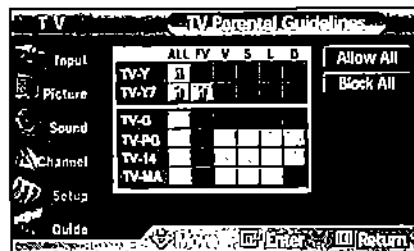



Note 1: The TV-Y, TV-Y7, TV-G, TV-PG, TV-14 and TV-MA have additional options. See the next step to change any of the following sub-ratings:

- FV: Fantasy violence
- D: Sexually Suggestive Dialog
- L: Adult Language
- S: Sexual situation
- V: Violence

Note 2: The V-Chip will automatically block certain categories that are "more restrictive". For example, if you block "TV-Y" category, then TV-Y7 will automatically be blocked. Similarly, if you block the TV-G category, then all the categories in the "young adult" group will be blocked (TV-Y, TV-Y7, TV-G, TV-PG, TV-14, and TV-MA). The sub-ratings (D, L, S, V) work together similarly. (See next section.)

- 6** How to set the FV, D, L, S and V sub-ratings. First, select one of these TV-Ratings: TV-Y, TV-Y7, TV-G, TV-PG, TV-14, or TV-MA (See Step 4, on previous page), and press the ► button.

A symbol "" will be displayed for each sub-rating. While "" is selected, press the ENTER button to go to a sub rating. Press ENTER to block the sub rating. To select a different TV-Rating, press the ▲ or ▼ button and then repeat the process.

Note: The V-chip will automatically block certain categories that are "More restrictive". For example, if you block "L" sub-rating in TV-PG, then the "L" sub-ratings in TV-14 and TV-MA will automatically be blocked.

- 7** Press the MENU button to clear all the screens. (Or proceed to the next section, and set up additional restrictions based on the MPAA codes.)

**Note**

- These categories consist of two separate groups: TV-Y and TV-Y7 (young children through age 7), and TV-G through TV-MA (everybody else). The restrictions for these two groups work independently: If a household includes very young children as well as young adults, the TV guidelines must be set up separately for each age group. (See next step.)

# Plasma Display

## How to Set up Restrictions using the MPAA Ratings: G, PG, PG-13, R, NC-17, X, NR

The MPAA rating system uses the Motion Picture Association of America (MPAA) system, and its main application is for movies. When the V-Chip lock is on, the TV will automatically block any programs that are coded with objectionable ratings (either MPAA or TV-Ratings).

- 1 Press the MENU button. Press the ▲ or ▼ button to select "Setup", then press the ENTER button.

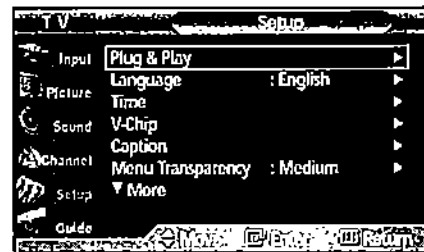

- 2 Press the ▲ or ▼ button to select "V-Chip", then press the ENTER button.  
The message "Enter PIN" will appear.  
Enter your 4 digit PIN number.

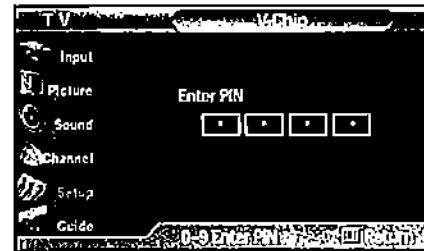

- 3 The "V-Chip" screen will appear.  
Press the ▲ or ▼ button to select "MPAA Rating", then press the ENTER button.

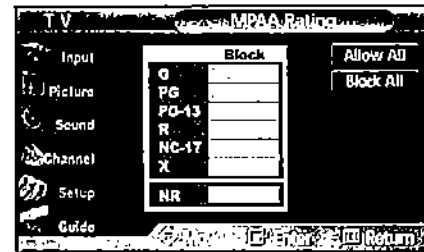

- 4 The "MPAA Rating" screen will appear.  
Repeatedly press the ▲ or ▼ button to select a particular MPAA category.  
Pressing the ▲ or ▼ button will cycle through the MPAA categories:

G	General audience (no restrictions).
PG	Parental guidance suggested.
PG-13	PG-13 (Parents strongly cautioned).
R	R (Restricted. Children under 17 should be accompanied by an adult).
NC-17	No children under age 17.
X	X (Adults only).
NR	Not rated.

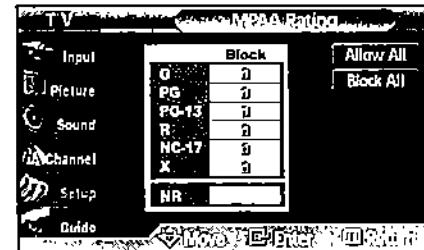

While a particular category is selected, press the ENTER button to activate it.

A selected symbol "⏏" will be displayed.

Press the ENTER button to block or unblock the category.



Note: The V-Chip will automatically block any category that is "more restrictive". For example, if you block the "PG-13" category, then "R", "NC-17" and "X" will automatically be blocked also.



## How to Reset the TV after the V-Chip Blocks a Channel ("Emergency Escape")

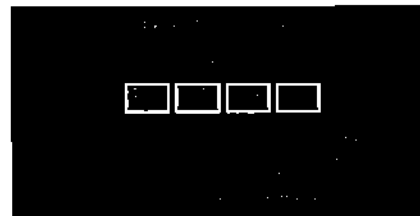
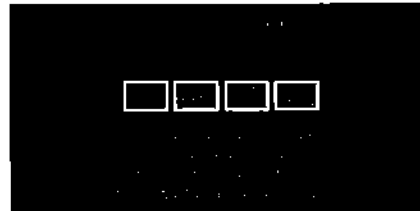

If the TV is tuned to a restricted channel, the V-Chip will block it. The screen will go blank and the following message will appear:



- 
- 1 Enter your PIN number.



To resume normal viewing, tune to a different channel using CH  or CH  button. Under certain conditions (depending on the rating of the local TV programs) the V-Chip might lock out all the channels. In this case, use the V-Chip function for an "emergency escape":

- 
- 1 Press the MENU button. Press the  or  button to select "Setup", then press the ENTER button.

- 
- 2 Press the  or  button to select "V-Chip", then press the ENTER button.

- 
- 3 Enter your PIN number, and press the  or  button to temporarily disable the V-Chip Lock.

# Plasma Display



## Electronic Program Guide

Your TV has an "Electronic Program Guide" to help you navigate through all the possible viewing options. The EPG supplies information, such as program lists, start and end times of all available channels. In addition, detailed information about the program is often available in the EPG. (The availability and the amount of program details will vary depending on the broadcaster.)

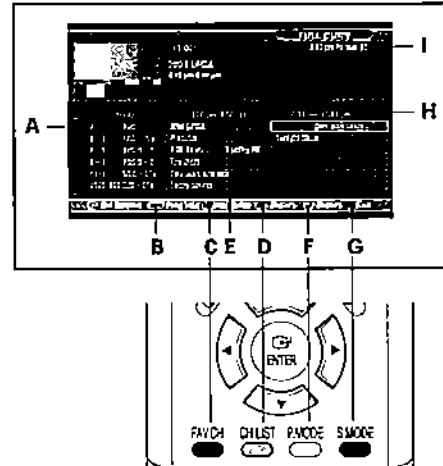

### Viewing the Electronic Program Guide

- A** Displays which channel is currently selected to show program information in the Channel Guide.
- B** Press to view detailed information for the selected digital program.
- C** Switches to the mini program guide. The mini guide shows the titles of the available programs of one channel. Press the Red button on the remote control. The set default guide is Mini Guide.
- D** Scrolls backwards quickly (2 hours). Press the Green button on the remote control.
- E** Displays titles and other details about upcoming programs of particular channels. Highlight the program and press the INFO button to see additional and detailed information. (The availability of additional details depends on the broadcaster.) Use the ▲/▼ buttons to search information about another channel.
- F** Scrolls forward quickly (2 hours). Press the Yellow button on the remote control and repeatedly press the ENTER button the appropriate time is displayed.
- G** Exits from the Program Guide and returns to normal viewing mode. Press the Blue button on the remote control.
- H** Displays the program times (arranged in 1 hour time blocks).
- I** Displays the current time and date.

#### **Note**

- You can use the GUIDE button on the remote control to display the Electronic Program Guide. The EPG begins its list with the channel that is currently active. The EPG will only work when you are receiving digital channels.

## Using the Electronic Program Guide

- 1 Press the MENU button.  
Press the ▲ or ▼ button to select "Guide", then press the ENTER button.

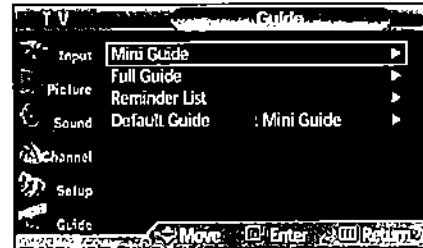

- 2 Press the ▲ or ▼ button to select "Default Guide", then press the ENTER button.

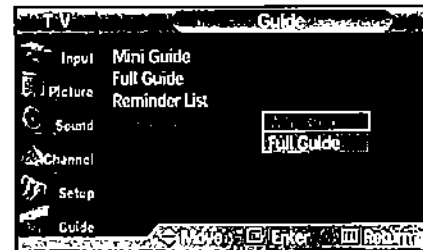

- 3 Press the ▲ or ▼ button to select "Mini Guide" or "Full Guide", then press the ENTER button.
  - Mini Guide : Displays the guide for one channel.
  - Full Guide : Displays the guide for all channels.

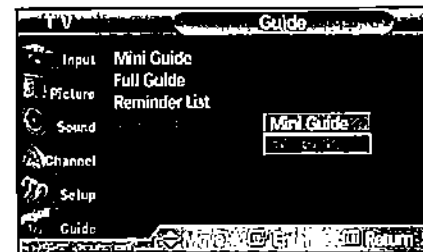

- 4 Press the MENU button to exit.



## Viewing Information about a Single Channel

- 1 Press the MENU button.  
Press the ▲ or ▼ button to select "Guide", then press the ENTER button.

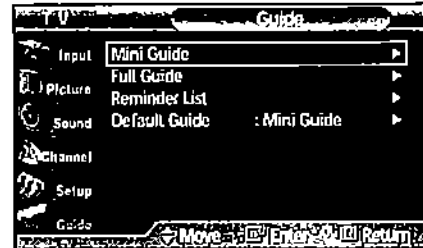

- 2 Press the ENTER button to select "Mini Guide".  
Press the ▲ or ▼ buttons to view information about one channel by time.

You can switch between Full Guide mode and Mini Guide mode by pressing the Red button repeatedly.

Select the program you want by pressing the ▲ or ▼ buttons and press the INFO button on the remote control.

- ENTER button : Press to watch the current program or to add the program to reminder list.
- Red button : Press to switch to the program guide for all channels.  
Press again to switch to the program information for the selected channel.
- Blue button : Press to exit.
- INFO button : Press to view detailed information for the selected digital program.

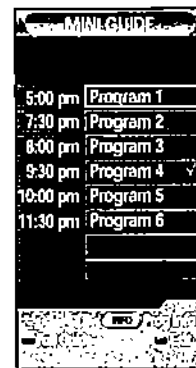

- 3 Press the Blue button or EXIT button to exit.

### Notes

- You can also view information about a single channel by pressing the GUIDE button on the remote control. (The EPG should be pre-set in Mini Guide mode.)
- Press the INFO button on the remote control to view the program information for the current channel.

## Viewing Information about Channels

Displays the program time and content for all channels.  
This function is available only when the program is digital.

- 1 Press the MENU button.  
Press the ▲ or ▼ button to select "Guide", then press the ENTER button.
- 
- 2 Press the ▲ or ▼ button to select "Full Guide", then press the ENTER button.

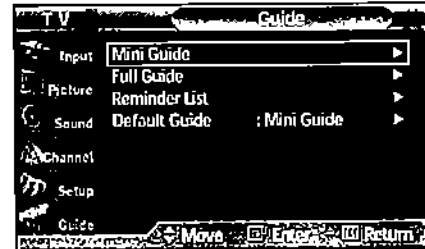

- 3 Press the Green button to activate "-2 Hours" and the Yellow button to activate "+2 Hours".

- INFO button : Displays detailed information for the selected digital program.
- ▲/▼ button : Displays program information for each channel, based on the time. Select your desired program using the ▲/▼ button, and then press the INFO button to view the program information for the selected program.
- Red button : Each press switches between program information for one channel and all channels.
- Green button : Press to view the program information from two hours ago.
- Yellow button : Press to view the program information for two hours from now.
- Blue button : Press to exit.
- ENTER button : Press to watch the current program or to add the program to reminder list.

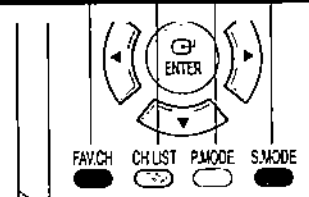
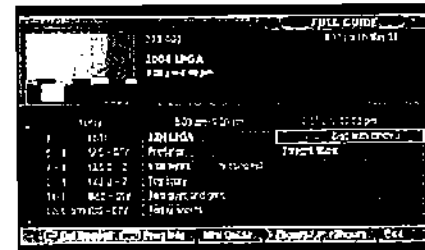

- 4 You may now:
  - Jump to a channel directly : Use the ▲ or ▼ buttons to highlight the program in the ► column and press the enter button.
  - Obtain additional program details : Highlight the title of a program using the ▲, ▼, ◀, or ▶ buttons and press the INFO button.
  - Exit from the Program Guide and return to normal viewing mode : Press the Blue button or the EXIT button.

### Notes

- The current time displayed on the program information is subject to the time information sent from the broadcasting station, so it may differ from the actual time.
- Press the GUIDE button on the remote control to view the program information for all channels. However, this function is available only when the default program guide setting is set to "Full Guide".



## Reminder List

### Viewing the Reminder List

If you have made a scheduled viewing list of programs you would like to see, the channel will be automatically switched to the scheduled program at the scheduled time even if you are watching another program.

- 1 Press the MENU button.  
Press the ▲ or ▼ button to select "Guide", then press the ENTER button.

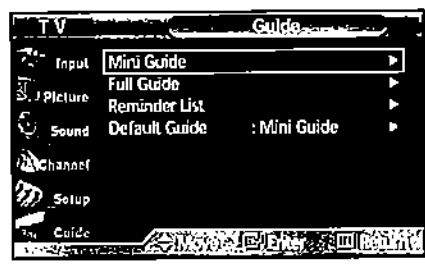

- 2 Press the ENTER button to select "Full Guide".  
Press the ▲ or ▼ button to select programs you would like to see, then press the enter button.  
The symbol "✓" will be displayed.  
Each press of the enter button will switch between "Reminded" and "Clear".

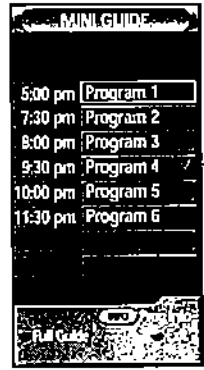

Reminder List

- 3 Press the MENU button to exit.

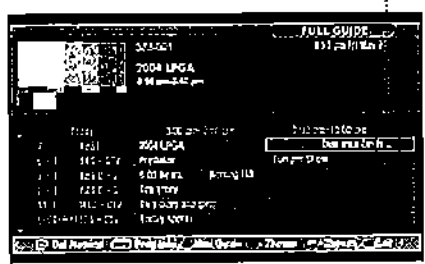

#### Note

- Up to 8 programs can be reminded.

## To view the Reminder List

- 1 Press the MENU button.  
Press the ▲ or ▼ button to select "Guide", then press the ENTER button.

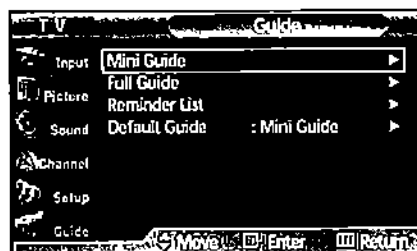

- 2 Press the ▲ or ▼ button to select "Reminder List", then press the ENTER button.

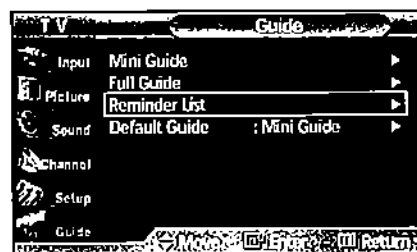

## To remove the scheduled programs

- 1 Press the ▲ or ▼ button to select a program to be removed, then press the ENTER button.  
  
To remove all programs, press the ◀ or ▶ button to select "Cancel All", then press the ENTER button.

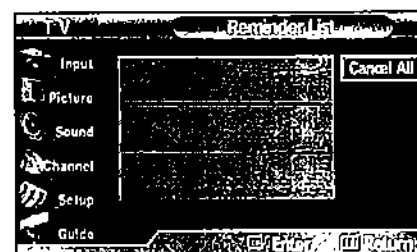

- 2 Press the MENU button to exit.



## Using the CableCARD

This menu works with a CableCARD provided by a local cable service provider. Prior to accessing this menu, a CableCARD should be connected to the rear panel of the TV. For detailed connection instructions refer to the "Connecting CableCARD" section of this manual.

### Displaying CableCARD related information

Accessing information on Status, Pairing, Network Setup of the CableCARD provided by the service provider in CableCARD menu.

- 1 Press the MENU button. Press the ▲ or ▼ button to select "Setup", then press the ENTER button.

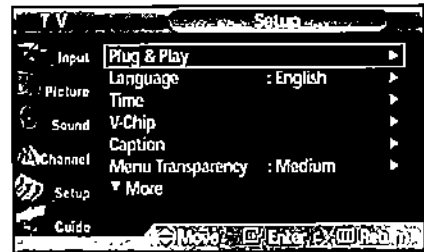

- 2 Press the ▲ or ▼ button to select "CableCARD™", then press the ENTER button.

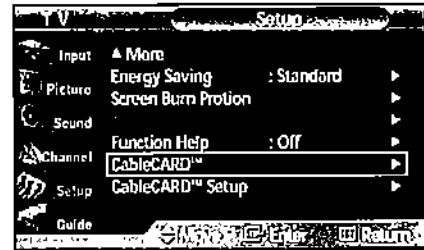

- 3 Press the EXIT button to exit.



# Using the CableCARD Setup Function

Sets up the relevant options for CableCARD.

## CableCARD Reset

Resets CableCARD when the channels provided by CableCARD are not available.

- 1 Press the MENU button.  
Press the ▲ or ▼ button to select "Setup", then press the ENTER button.



- 2 Press the ▲ or ▼ button to select "CableCARD™ Setup", then press the ENTER button.

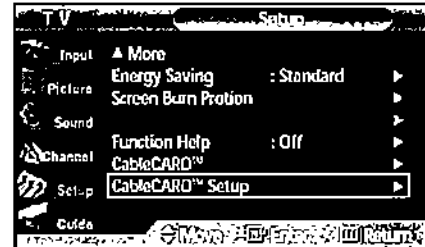

- 3 Press the ENTER button to select "CableCARD™ Reset".

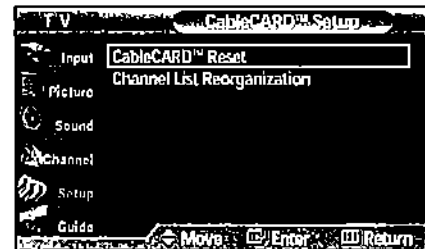

# Plasma Display

## Channel List Reorganization

Deletes and reorganizes the channel list provided by CableCARD.

- 1 Press the MENU button. Press the ▲ or ▼ button to select "Setup", then press the ENTER button.

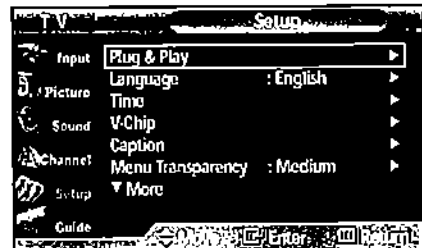

- 2 Press the ▲ or ▼ button to select "CableCARD™ Setup", then press the ENTER button.

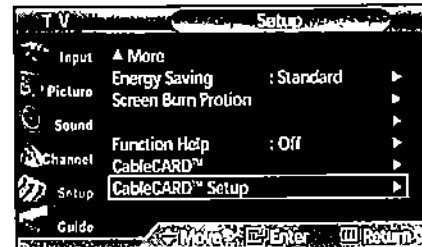

- 3 Press the ENTER button to select "Channel List Reorganization".

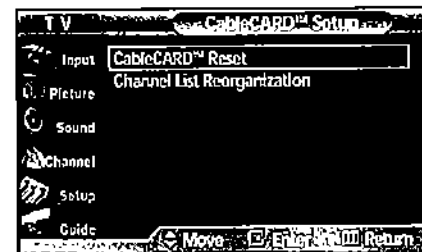





P L A S M A   D I S P L A Y   P A N E L

**Appendix** 

Troubleshooting.....	138
Care and Maintenance .....	139
Specifications .....	140
Dimension .....	141



# Troubleshooting

Before you call a service technician, please scan this list of problems and possible solutions. It may save you time and money.

<b>Problem</b>	<b>Possible Solution</b>
Poor picture.	Check all wire connections.
No picture or sound.	Try another channel. Press the SOURCE button. Make sure the TV is plugged in. Check the antenna connections.
Poor sound quality.	Try another channel. Adjust the volume.
Your remote control does not operate the TV.	Press the "MODE" button to put your remote control in the "TV" mode.
The TV won't turn on.	Check if the power plug is connected.
There is no screen image.	Check to see that both the TV and the source are plugged in and turned on.
The image is too light or too dark.	Adjust the Brightness or Contrast settings.
The image is too large or too small.	Adjust the Size settings.
Digital broadcasting screen problem.	Please check the digital signal strength and input antenna.



## Care and Maintenance

With proper care, your TV will give you many years of service. Please follow these guidelines to get the maximum performance from your TV.

### Identifying Problems

- Do not put the TV near extremely hot, cold, humid or dusty places.
- Do not put the TV near appliances that create magnetic fields.
- Keep the ventilation openings clear.
- Do not place the TV on a rough and slanted surface, such as cloth or paper.

### Liquids

- Do not place liquids near or on the TV.

### Cabinet

- Never open the cabinet or touch the parts inside.
- Wipe your TV with a clean, dry cloth. Never use water, cleaning fluids, wax, or chemicals.
- Do not put heavy objects on top of the cabinet.

### Temperature

- If your TV is suddenly moved from a cold to a warm place, unplug the power cord for at least two hours so that moisture that may have formed inside the unit can dry completely.

# Specifications

Exterior design and product specifications are subject to change without prior notice to improve the performance of this product.

Model		HP-R4252
Dimensions	Display	1425 (W) x 114 (D) x 825.4 (H) mm / 56.10 (W) X 4.49 (D) X 32.50 (H) inches (Without Stand)
		1425 (W) x 490 (D) x 921 (H) mm / 56.10 (W) X 19.29 (D) X 36.26 (H) inches (With Stand)
Weight	Display	59.2 Kg / 130.5 lbs (Without Stand)
		68 Kg / 149.9 lbs (With Stand)
Voltage		AC 100 ~ 240 V, 60 Hz
Power Consumption		530 W
Number of Pixels		1366 (H) x 768 (V)
Screen Size		141 Cm / 55 inches
ANTENNA input		VHF, UHF (75Ω unbalanced)
VIDEO input		AV S-VIDEO COMPONENT1-480i/480p/720p/1080i COMPONENT2-480i/480p/720p/1080i PC HDMI (DVI Compatible)
AUDIO input		AV S-VIDEO COMPONENT1-480i/480p/720p/1080i COMPONENT2-480i/480p/720p/1080i PC DVI
Monitor Output		AUDIO (L/R)
Audio Output		OPTICAL COAXIAL

# Plasma Display



## Dimension

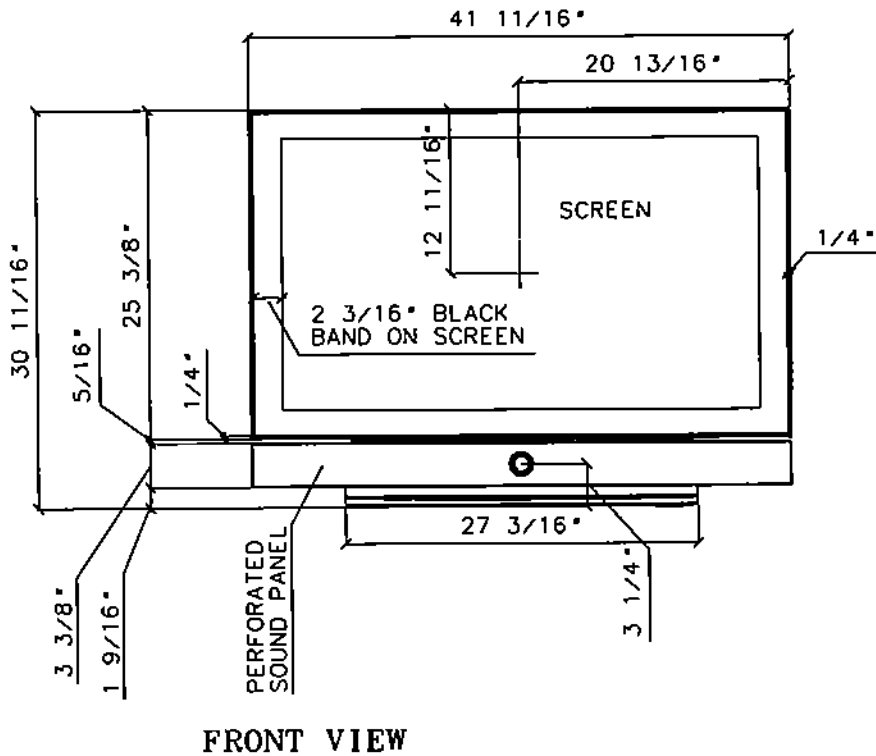
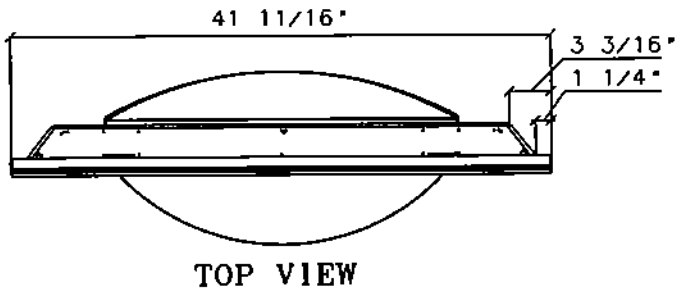

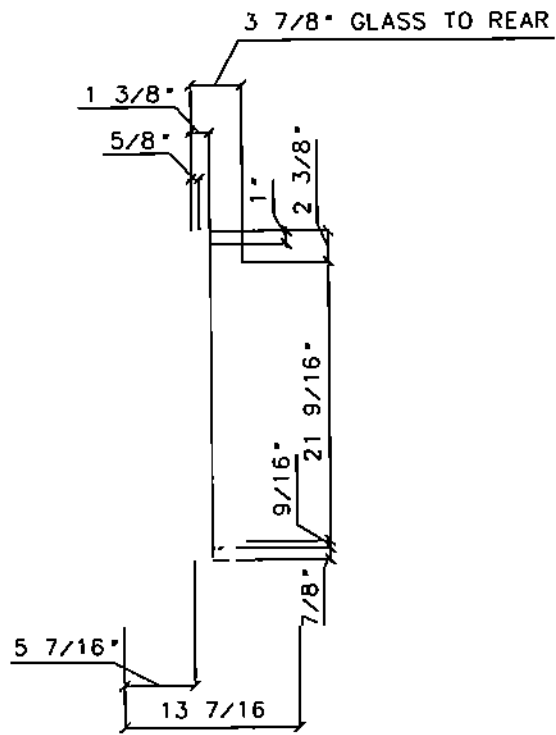

SIDE VIEW

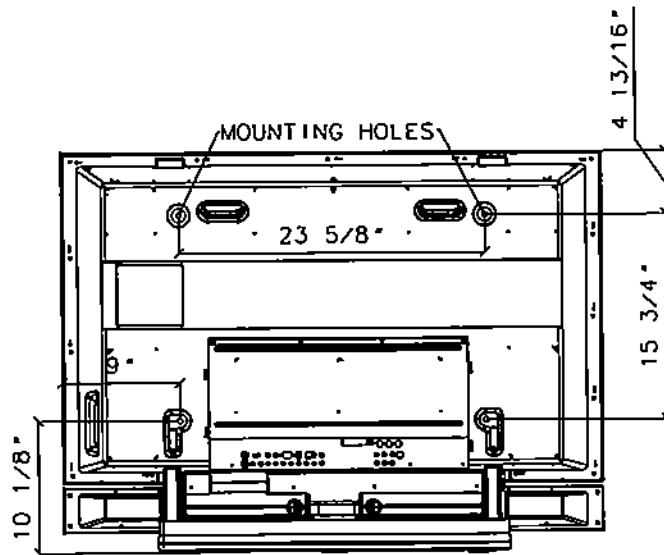

REAR VIEW



Memo

---

---



**ELECTRONICS**

**1-800-SAMSUNG (1-800-726-7864)**

**Samsung Electronics America  
Service Division**

400 Valley Road, Suite 201  
Mount Arlington, NJ 07856  
[www.samsung.com](http://www.samsung.com)

**Samsung Electronics Canada Inc.  
Samsung Customer Care**

7037 Financial Drive  
Mississauga, Ontario  
L5N 6R3  
[www.samsung.ca](http://www.samsung.ca)



# Regulatory and Safety Compliance Guide



# Warning! Important Safety Instructions

(Please read the appropriate section that corresponds to the marking on your Samsung product before attempting to install the product.)

## CAUTION

RISK OF ELECTRIC SHOCK  
DO NOT OPEN

CAUTION: TO REDUCE THE RISK OF ELECTRIC SHOCK, DO NOT REMOVE COVER (OR BACK). THERE ARE NO USER SERVICEABLE PARTS INSIDE. REFER ALL SERVISING TO QUALIFIED PERSONNEL.



This symbol indicated high voltage is present inside. It is dangerous to make any kind of contact with any inside part of this product.



This symbol alerts you that important literature concerning operation and maintenance has been included with this product.

- ☛ The slots and openings in the cabinet and in the back or bottom are provided for necessary ventilation. To ensure reliable operation of this apparatus, and to protect it from overheating, these slots and openings must never be blocked or covered.
  - Do not cover the slots and openings with a cloth or other materials.
  - Do not block the slots and openings by placing this apparatus on a bed, sofa, rug or other similar surface.
  - Do not place this apparatus in a confined space, such as a bookcase, or built-in cabinet, unless proper ventilations is provided.
- ☛ Do not place this apparatus near or over a radiator or heat register, or where it is exposed to direct sunlight.
- ☛ Do not place the sources of heat on this apparatus, such as a candle, ash tray, incense or other similar material.
- ☛ Do not place a water containing vessel on this apparatus, as this can result in a risk of fire or electric shock.
- ☛ Do not expose this apparatus to rain or place it near water (near a bathtub, washbowl, kitchen sink, or laundry tub, in a wet basement, or near a swimming pool etc.). If this apparatus accidentally gets wet, unplug it and contact an authorized dealer immediately. You can clean this apparatus with damp cloth when necessary, but be sure to unplug the apparatus first.
- ☛ Do not expose this apparatus set to extreme temperature conditions or to extreme humidity conditions.
- ☛ This apparatus use batteries. In your community there might be regulations that require you to dispose these batteries properly under environmental considerations. Please contact your local authorities for disposal or recycling information.
- ☛ To cut off the power source, unplug this apparatus from the wall outlet.
- ☛ Do not overload wall outlets, extension cords or convenience receptacles beyond their capacity, since this can result in fire or electric shock.
- ☛ Power-supply cords should be routed so that they are not likely to be walked on or pinched by items placed upon or against them, paying particular attention to cords at plugs, convenience receptacles, and the point where they exit from the appliance.
- ☛ To protect this apparatus from a lightning storm, or when it is left unattended and unused for long periods of time, unplug it from the wall outlet and disconnect the antenna or cable system. This will prevent damage to the set due to lightning and power line surges.
- ☛ Before connecting the AC power cord to the DC adapter outlet, make sure the voltage designation of the DC adapter corresponds the the local electrical supply.
- ☛ Never insert anything metallic into this apparatus openings. Doing so may create the danger of electric shock.
- ☛ To avoid electric shock, never touch the inside of this apparatus. Only a qualified technician should open this apparatus's case.
- ☛ Be sure to hold the plug, not the cord, when disconnecting this apparatus from an electric socket.
- ☛ Locate this apparatus near an easily accessible AC outlet.
- ☛ If this apparatus does not operate normally - in particular, if there are any unusual sounds or smells coming from it - unplug it immediately and contact an authorized dealer or service center.
- ☛ Unplug this apparatus from the AC outlet before any service.

## **Regulatory Compliance Statements**

Your Samsung product is marked to indicate its compliance class:

- Federal Communications Commission (FCC) - USA
- Industry Canada Equipment Standard for Digital Equipment (ICES-003) - Canada
- Voluntary Control Council for Interference (VCCI) - Japan
- Bureau of Standards Metrology and Inspection (BSMI) - Taiwan
- Ministry of Information and Communication (MIC) - Republic of Korea
- Italian Post Ministry (Homologation) - Italy

### **FCC Information**

#### **FCC Class A Notice**

This device complies with part 15 of the FCC Rules. Operation is subject to the following two conditions:

1. This device may not cause harmful interference, and
2. This device must accept any interference received, including interference that may cause undesired operation.

NOTE: This equipment has been tested and found to comply with the limits for a Class A digital device, pursuant to Part 15 of the FCC Rules. These limits are designed to provide reasonable protection against harmful interference when the equipment is operated in a commercial environment. This equipment generates, uses, and can radiate radio frequency energy and, if not installed and used in accordance with the instruction manual, may cause harmful interference to radio communications. Operation of this equipment in a residential area is likely to cause harmful interference in which case the user will be required to correct the interference at his own expense.

#### **FCC Class B Notice**

This device complies with part 15 of the FCC Rules. Operation is subject to the following two conditions:

1. This device may not cause harmful interference, and
2. This device must accept any interference received, including interference that may cause undesired operation.

NOTE: This equipment has been tested and found to comply with the limits for a Class B digital device, pursuant to Part 15 of the FCC Rules. These limits are designed to provide reasonable protection against harmful interference in a residential installation. This equipment generates, uses and can radiate radio frequency energy and, if not installed and used in accordance with the instructions, may cause harmful interference to radio communications. However, there is no

guarantee that interference will not occur in a particular installation.

If this equipment does cause harmful interference to radio or television reception, which can be determined by turning the equipment off and on, the user is encouraged to try to correct the interference by one or more of the following measures:

- Reorient or relocate the receiving antenna.
- Increase the separation between the equipment and receiver.
- Connect the equipment into an outlet on a circuit different from that to which the receiver is connected.
- Consult the dealer or an experienced radio/TV technician for help.

#### User Information

Changes or modifications not expressly approved by the party responsible for compliance could void the user's authority to operate the equipment. If necessary, consult with your dealer or an experienced radio/television technician for additional suggestions. You may find the booklet called How to Identify and Resolve Radio/TV Interference Problems helpful. This booklet was prepared by the Federal Communications Commission. It is available from the U.S. Government Printing Office, Washington, DC 20402, Stock Number 004-000-00345-4.

The party responsible for product compliance:

SAMSUNG ELECTRONICS CO., LTD.

America QA Lab of Samsung

3351 Michelson Drive

Suite #290, Irvine, CA92612 USA

#### Warning

User must use shielded signal interface cables to maintain FCC compliance for the product. Provided with this monitor is a detachable power supply cord with IEC320 style terminations. It may be suitable for connection to any UL Listed personal computer with similar configuration. Before making the connection, make sure the voltage rating of the computer convenience outlet is the same as the monitor and that the ampere rating of the computer convenience outlet is equal to or exceeds the monitor voltage rating.

For 120 Volt applications, use only UL Listed detachable power cord with NEMA configuration 5-15P type(parallel blades) plug cap. For 240 Volt applications use only UL Listed detachable power supply cord with NEMA configuration 6015P type(tandem blades) plug cap.

This television receiver provides display of television closed captioning in accordance with Section 15.119 of the FCC rules.(TV broadcast receivers with picture screens 13 inches or larger in diameter models only)

### **ICES-003 Class A Notice - Avis NMB-003, Classe A**

This Class A digital apparatus complies with Canadian ICES-003.

Cet appareil numérique de la classe A est conforme à la norme NMB-003 du Canada.

### **ICES-003 Class B Notice - Avis NMB-003, Classe B**

This Class B digital apparatus complies with Canadian ICES-003.

Cet appareil numérique de la classe B est conforme à la norme NMB-003 du Canada.

### **VCCI Class A Notice**

この装置は「情報処理装置等電波障害自主規制協議会(VCCI)の基準に基づくクラスA情報技術装置です。この装置を家庭環境で使用すると電波妨害を引き起こすことがあります。この場合には使用者が適切な対策を講ずるよう要求されることがあります。」

### **VCCI Class B Notice**

この装置は「情報処理装置等電波障害自主規制協議会(VCCI)の基準に基づくクラスB情報技術装置です。この装置は「家庭環境で使用することを目的としていますが、この装置がラジオやテレビジョン受信機に近接して使用されると「受信障害を引き起こすことがあります。」取扱説明書に従って正しい取り扱いをして下さい。」

### **BSMI Class A Notice**

The following statement is applicable to products shipped to Taiwan and marked as Class A on the product compliance label.

警告使用者:

這是甲類資訊類產品, 在居住環境中使用時, 可能會造成射頻干擾, 在這種情況下, 使用者會被要求採取某些適當的對策。」

### **European Notice(Europe Only)**

Products with the CE marking comply with the EMC Directive(89/336/EEC), (92/31/EEC), (93/68/EEC) and the Low Voltage Directive(73/23/EEC) issued by the Commission of the European Community.

Compliance with these directives implies conformity to the following European Norms:

- EN55022: Radio Frequency Interference
- EN55024: Electromagnetic Immunity of Information Technology Equipment
- EN61000-3-2: Power Line Harmonics
- EN61000-3-3: Voltage Fluctuations
- EN55013: Radio disturbance characteristics of broadcast receivers and associated equipments
- EN55020: Electromagnetic immunity of broadcast receivers and associated equipments

#### **European Class A Warning**

This is a class A product. In a domestic environment this product may cause radio interference in which case the user may be required to take adequate measures.(Class A product only)

#### **정보통신기기 A급 기기(MIC Class A Notice)**

이 기기는 업무용으로 전자파적합등록을 한 기기이오니 판매자 또는 사용자는 이 점을 주의하시기 바라여 만약 잘못 판매 또는 구입하였을 때에는 가정용으로 교환하시기 바랍니다.

#### **정보통신기기 B급 기기(MIC Class B Notice)**

이 기기는 가정용으로 전자파적합등록을 한 기기로서 주거지역에서는 물론 모든 지역에서 사용할 수 있습니다.

#### **Italian Homologation Notice**

Questo apparecchio e fabbricato in conformita al D.M.28.08.95 n.548  
ed in particolare a quanto specificato nell Art.2, comma 1.

Questo apparecchio e fabbricato nella U.E. in conformita al D.M.28.08.95 n.548  
Art.2, comma 1 ed al D.M.26.03.92 Art.1

- For products produced in countries except European Community

Questo apparecchio e fabbricato in conformita al D.M.28.08.95 n.548  
ed in particolare a quanto specificato nell Art.2, comma 1.

- For products produced in European Community



Questo apparecchio e fabbricato nella U.E. in conformita al D.M.28.08.95 n.548  
Art.2, comma 1 ed al D.M.26.03.92 Art.1

# Important Safety Instructions(TV Only)

- 1) Read these instructions.
- 2) Keep these instructions.
- 3) Heed all warnings.
- 4) Follow all instructions.
- 5) Do not use this apparatus near water.
- 6) Clean only with dry cloth.
- 7) Do not block any ventilation openings, Install in accordance with the manufacturer's instructions.
- 8) Do not install near any heat sources such as radiators, heat registers, or other apparatus (including amplifiers) that produce heat.
- 9) Do not defeat the safety purpose of the polarized or grounding-type plug. A polarized plug has two blades with one wider than the other. A grounding type plug has two blades and a third grounding prong. The wide blade or the third prong are provided for your safety. If the provided plug does not fit into your outlet, consult an electrician for replacement of the obsolete outlet.
- 10) Protect the power cord from being walked on or pinched particularly at plugs, convenience receptacles, and the point where they exit from the apparatus.
- 11) Only use attachments/accessories specified by the manufacturer.
- 12) Use only with cart, stand, tripod, bracket, or table specified by the manufacturer, or sold with the apparatus. When a cart is used, use caution when moving the cart/apparatus combination to avoid injury from tip-over.
- 13) Unplug this apparatus during lightning storms or when unused for long periods of time.
- 14) Refer all servicing to qualified service personnel. Servicing is required when the apparatus has been damaged in any way, such as power-supply cord or plug is damaged, liquid has been spilled or objects have fallen into the apparatus, the apparatus has been exposed to rain or moisture, does not operate normally, or has been dropped.



<b>CAUTION</b>
<b>RISK OF ELECTRIC SHOCK DO NOT OPEN</b>
CAUTION: TO REDUCE THE RISK OF ELECTRIC SHOCK, DO NOT REMOVE COVER (OR BACK). NO USER SERVICEABLE PARTS INSIDE. REFER SERVICING TO QUALIFIED SERVICE PERSONNEL.

This symbol indicates high voltage is present inside. It is dangerous to make any kind of contact with any inside part of this product.	
This symbol alerts you that important literature concerning operation and maintenance has been included with this product.	

Warning: To prevent damage which may result in fire or electric shock hazard, do not expose this appliance to rain or moisture.

(EPA applied model only) As an ENERGY STAR Partner, Samsung has determined that this product or product models meets the ENERGY STAR guidelines for energy efficiency.
---

■ Optional ■

Do not place the apparatus in a rack or bookcase. Ensure that there is adequate ventilation and that you've followed that manufacturer's instructions for mounting.  
(For PDP or Projection TV apparatus)

If you place the apparatus in a rack or bookcase, ensure that there is adequate ventilation and that you've followed the manufacturer's instructions.



## Wiring the Mains Power Supply Plug(UK Only)

### **IMPORTANT NOTICE**

The mains lead on this equipment is supplied with a moulded plug incorporating a fuse. The value of the fuse is indicated on the pin face of the plug and, if it requires replacing, a fuse approved to BS11362 of the same rating must be used.

Never use the plug with the fuse cover omitted if the cover is detachable. If a replacement fuse cover is required, it must be of the same colour as the pin face of the plug. Replacement covers are available from your dealer.

If the fitted plug is not suitable for the power points in your house or the cable is not long enough to reach a power point, you should obtain a suitable safety approved extension lead or consult your dealer for assistance.

However, if there is no alternative to cut off the plug, remove the fuse and then safely dispose of the plug. Do NOT connect the plug to a mains socket as there is a risk of shock hazard from the bared flexible cord.

### **IMPORTANT**

The wires in the mains lead are coloured in accordance with the following code:

BLUE - NEUTRAL    BROWN - LIVE

As these colours may not correspond to the coloured markings identifying the terminals in your plug, proceed as follows:

The wire coloured BLUE must be connected to the terminal marked with the letter N or coloured BLUE or BLACK.

The wire coloured BROWN must be connected to the terminal marked with the letter L or coloured BROWN or RED.

**WARNING; DO NOT CONNECT EITHER WIRE TO THE EARTH TERMINAL, WHICH IS MARKED WITH THE LETTER E OR BY THE EARTH SYMBOL ⊕, OR COLOURED GREEN OR GREEN AND YELLOW.**

## Russia Only - PCT Notice



**MPR II Compliance**

TCO'95-Ecological requirements for personal computers (TCO'95 applied model only)  
TCO'99-Ecological requirements for personal computers (TCO'99 applied model only)  
TCO'03-Ecological requirements for personal computers (TCO'03 applied model only)  
TCO'03 Recycling Information (TCO'03 applied model only)  
Medical Requirement (Medical applied model only)

● **MPR II Compliance**

This monitor complies with SWEDAC(MPR II) recommendations for reduced electric and magnetic fields.

● **TCO'95-Ecological requirements for personal computers (TCO'95 applied model only)**



**AB general requirements**

**AB2 Written Eco-document accompanying the products**

Congratulations! You have just purchased a TCO'95 approved and labelled product! Your choice has provided you with a product developed for professional use. Your purchase has also contributed to reducing the burden on the environment and to the further development of environmentally-adapted electronic products.

**Why do we have environmentally-labelled monitors?**

In many countries, environmental labelling has become an established method for encouraging the adaptation of goods and services to the environment. The main problem as far as monitors and other electronic equipment are concerned is that environmentally harmful substances are used both in the products and during their manufacture. Since it has not been possible so far for the majority of electronic equipment to be recycled in a satisfactory way, most of these potentially damaging substances sooner or later enter Nature.

There are also other characteristics of a monitor, such as energy consumption levels, that are important from both the working and natural environment viewpoints. Since all types of conventional electricity generation have a negative effect on the environment (acidic and climate-influencing emissions, radioactive waste, etc.) it is vital to conserve energy. Electronic equipment in offices consumes an enormous amount of energy, since it is often routinely left running continuously.

**What does labelling involve?**

This product meets the requirements for the TCO'95 scheme, which provides for international environmental labelling of monitors. The labelling scheme was developed as a joint effort by the TCO (The Swedish Confederation of Professional Employees), Naturskyddsforeningen (The Swedish Society for Nature Conservation) and NUTEK (The National Board for Industrial and Technical Development in Sweden).

The requirements cover a wide range of issues: environment, ergonomics, usability, emission of electrical and magnetic fields, energy consumption and electrical and fire safety.

The environmental demands concern among other things restrictions on the presence and use of heavy metals, brominated and chlorinated flame retardants, CFCs (freons), and chlorinated solvents. The product must be prepared for recycling and the manufacturer is obliged to have an environmental plan, which must be adhered to in each country where the company conducts its operations policy. The energy requirements include a demand that the monitor after a certain period of inactivity shall reduce its power consumption to a lower level, in one or more stages. The length of time to reactivate the monitor shall be reasonable for the user.

Labelled products must meet strict environmental demands, for example in respect of the reduction of electric and magnetic fields, along with physical and visual ergonomics and good usability.

TCO Development Unit 1996-11-29

On the page this folder you will find a brief summary of the environmental requirements met by this product.

The complete environmental criteria document may be ordered from:

TCO Development Unit

S-11494 Stockholm

Sweden

Fax: +46 8 782 92 07

E-mail (Internet): [development@tco.se](mailto:development@tco.se)

Current information regarding TCO'95-approved and labelled products may also be obtained via the Internet, using the address:

<http://www.tco-info.com/>

TCO'95 is a co-operative project between (3 logos)

#### **Environmental Requirements**

Brominated flame retardants are present in printed circuit boards, cables, wires, casings and housings. In turn, they delay the spread of fire. Up to thirty percent of the plastic in a computer casing can consist of flame retardant substances. These are related to another group of environmental toxins, PCBs, which are suspected to give rise to similar harm, including reproductive damage in fish eating birds and mammals, due to the bioaccumulative processes. Flame retardants have been found in human blood and researchers fear that disturbances in foetus development may occur.

TCO'95 demand requires that plastic components weighing more than 25 grams must not contain organically bound chlorine and bromine.

#### **Lead**

Lead can be found in picture tubes, display screens, solders and capacitors. Lead damages the nervous system and in higher doses, causes lead poisoning.

TCO'95 requirement Permits the inclusion of lead since no replacement has yet been developed.

#### **Cadmium**

Cadmium is present in rechargeable batteries and in the colour generating layers of certain computer displays. Cadmium damages the nervous system and is toxic in high doses.

TCO'95 requirement states that batteries may not contain more than 25 ppm (parts per million) of cadmium. The colour-generating layers of display screens must not contain any cadmium.

#### **Mercury**

Mercury is sometimes found in batteries, relays and switches. Mercury damages the nervous system and is toxic in high doses.

TCO'95 requirement states that batteries may not contain more than 25 ppm (parts per million) of mercury. It also demands that no mercury is present in any of the electrical or electronics

components concerned with the display unit.

#### **CFCs (freons)**

CFCs (freons) are sometimes used for washing printed circuit boards and in the manufacturing of expanded foam for packaging. CFCs break down ozone and thereby damage the ozone layer in the stratosphere, causing increased reception on Earth of ultraviolet light with consequent increased risks of skin cancer (malignant melanoma).

The relevant TCO'95 requirement: Neither CFCs nor HCFCs may be used during the manufacturing of the product or its packaging.

• TCO'99-Ecological requirements for personal computers (TCO'99 applied model only)



**Congratulations!**

You have just purchased a TCO'99 approved and labelled product! Your choice has provided you with a product developed for professional use. Your purchase has also contributed to reducing the burden on the environment and also to the further development of environmentally adapted electronics products.

This product meets the requirements for the TCO'99 scheme which provides for an international environmental and quality labelling of personal computers. The labelling scheme was developed as a joint effort by the TCO(The Swedish Confederation of Professional Employees), Svenska Naturskyddsforeningen(The Swedish Society for Nature Conservation), Statens Energimyndighet(The Swedish National Energy Administration) and SEMKO AB.

The requirements cover a wide range of issues: environment, ergonomics, usability, reduction of electric and magnetic fields, energy consumption and electrical safety.

**Why do we have environmentally labelled computers?**

In many countries, environmental labelling has become an established method for encouraging the adaptation of goods and services to the environment. The main problem, as far as computers and other electronics equipment are concerned, is that environmentally harmful substances are used both in the products and during their manufacture. Since it is not so far possible to satisfactorily recycle the majority of electronics equipment, most of these potentially damaging substances sooner or later enter nature.

There are also other characteristics of a computer, such as energy consumption levels, that are important from the viewpoints of both the work (internal) and natural (external) environments. Since all methods of electricity generation have a negative effect on the environment (e.g. acidic and climate-influencing emissions, radioactive waste), it is vital to save energy. Electronics equipment in offices is often left running continuously and thereby consumes a lot of energy.

**What does labelling involve?**

The environmental demands have been developed by Svenska Naturskyddsforeningen (The Swedish Society for Nature Conservation). These demands impose restrictions on the presence and use of heavy metals, brominated and chlorinated flame retardants, CFCs(freons)and chlorinated solvents, among other things. The product must be prepared for recycling and the manufacturer is obliged to have an environmental policy which must be adhered to in each country where the company implements its operational policy.

The energy requirements include a demand that the computer and/or display, after a certain period of inactivity, shall reduce its power consumption to a lower level in one or more stages. The length of time to reactivate the computer shall be reasonable for the user.

Below you will find a brief summary of the environmental requirements met by this product. The complete environmental criteria document may be ordered from:

**TCO Development**  
SE-114 94 Stockholm, Sweden  
Fax: +46 8 782 92 07  
Email (Internet): [development@tco.se](mailto:development@tco.se)

Current information regarding TCO'99 approved and labelled products may also be obtained via the Internet, using the address: <http://www.tco-info.com/>

**Environmental requirements**

**Flame retardants**

Flame retardants are present in printed circuit boards, cables, wires, casings and housings. Their purpose is to prevent, or at least to delay the spread of fire. Up to 30% of the plastic in a computer casing can consist of flame retardant substances. Most flame retardants contain bromine or chloride, and those flame retardants are chemically related to another group of environmental toxins, PCBs. Both the flame retardants containing bromine or chloride and the PCBs are suspected of giving rise to severe health effects, including reproductive damage in fish-eating birds and mammals, due to the bio-accumulative\* processes. Flame retardants have been found in human blood and researchers fear that disturbances in foetus development may occur.

The relevant TCO'99 demand requires that plastic components weighing more than 25 grams must not contain flame retardants with organically bound bromine or chlorine. Flame retardants are allowed in the printed circuit boards since no substitutes are available.

#### **Cadmium\*\***

Cadmium is present in rechargeable batteries and in the colour-generating layers of certain computer displays. Cadmium damages the nervous system and is toxic in high doses. The relevant TCO'99 requirement states that batteries, the colour-generating layers of display screens and the electrical or electronics components must not contain any cadmium.

#### **Mercury\*\***

Mercury is sometimes found in batteries, relays and switches. It damages the nervous system and is toxic in high doses. The relevant TCO'99 requirement states that batteries may not contain any mercury. It also demands that mercury is not present in any of the electrical or electronics components associated with the labelled unit. There is however one exception. Mercury is, for the time being, permitted in the back light system of flat panel monitors as today there is no commercially available alternative. TCO aims on removing this exception when a Mercury free alternative is available.

#### **CFCs (freons)**

The relevant TCO'99 requirement states that neither CFCs nor HCFCs may be used during the manufacture and assembly of the product. CFCs (freons) are sometimes used for washing printed circuit boards. CFCs break down ozone and thereby damage the ozone layer in the stratosphere, causing increased reception on earth of ultraviolet light with e.g. increased risks of skin cancer (malignant melanoma) as a consequence.

#### **Lead\*\***

Lead can be found in picture tubes, display screens, solders and capacitors. Lead damages the nervous system and in higher doses, causes lead poisoning. The relevant TCO'99 requirement permits the inclusion of lead since no replacement has yet been developed.

4/07

---

#### ● TCO'03-Ecological requirements for personal computers (TCO'03 applied model only)



#### **Congratulations!**

The display you have just purchased carries the TCO'03 Displays label. This means that your display is designed, manufactured and tested according to some of the strictest quality and environmental requirements in the world. This makes for a high performance product, designed with the user in focus that also minimizes the impact on our natural environment.

Some of the features of the TCO'03 Display requirements:

#### **Ergonomics**

Good visual ergonomics and image quality in order to improve the working environment for the user and to reduce sight and strain problems. Important parameters are luminance, contrast, resolution, reflectance, colour rendition and image stability.

#### **Energy**

Energy-saving mode after a certain time – beneficial both for the user and the environment  
Electrical safety

### Emissions

- Electromagnetic fields
- Noise emissions

### Ecology

- The product must be prepared for recycling and the manufacturer must have a certified environmental management system such as EMAS or ISO 14 000
- Restrictions on
  - chlorinated and brominated flame retardants and polymers
  - heavy metals such as cadmium, mercury and lead.

The requirements included in this label have been developed by TCO Development in cooperation with scientists, experts, users as well as manufacturers all over the world. Since the end of the 1980s TCO has been involved in influencing the development of IT equipment in a more user-friendly direction. Our labelling system started with displays in 1992 and is now requested by users and IT-manufacturers all over the world.

For more information, Please visit  
[www.tcodevelopment.com](http://www.tcodevelopment.com)

- 115 -

### ● TCO'03 Recycling Information (TCO'03 applied model only)

#### [European Residents Only]

For recycling information for TCO'03 certified monitors, for the residents in the following countries, please contact the company corresponding to your region of residence. For those who reside in other countries, please contact a nearest local Samsung dealer for recycling information for the products to be treated in environmentally acceptable way.

	[U.S.A. Residents Only]	[European Residents Only]		
	U.S.A.	SWEDEN	NORWAY	GERMANY
COMPANY	Solid Waste Transfer & Recycling Inc	ELKRETSSEN	Elektronikkretur AS	vfw AG
ADDRESS	442 Frelingbuysen Ave Newark, NJ 07114	ELKRETSSEN Box 1357, 111 83 Stockholm Barnhusgatan 3, 4 tr.	6454 Etterstad 0602 Oslo Fyrstikkallen 3B	Max Plank Strasse 42 50858 Collogne Germany
TELEPHONE	973-565-0181	08-545 212 90	23 06 07 40	49 0 2234 9587 - 0
FAX	Fax: 973-565-9485	08-545 212 99	23 06 07 41	
E-MAIL	none	info@el-kretsen.se	adm@elektronikkretur.no	vfw.info@vfw-ag.de
HOME PAGE	<a href="http://www.bcua.org/SolidWaste_Disposal.htm">http://www.bcua.org/SolidWaste_Disposal.htm</a>	<a href="http://www.el-kretsen.se/">http://www.el-kretsen.se/</a>	<a href="http://www.elretur.no/">http://www.elretur.no/</a>	

### ● Medical Requirement (Medical applied model only)



#### Classifications:

In accordance with UL 2601-1/IEC 60601-1, the product is classified as Continuous duty Class I equipment, which is not protected against ingress of liquids. The product is not suitable for use in the presence of a flammable anaesthetic mixture with air or with oxygen or nitrous oxide.

#### EMC

This equipment has been tested and found to comply with the limits for medical devices to the IEC 601-1-2:1994. These limits are designed to provide reasonable protection against harmful interference in a typical medical installation. This equipment generates, uses and can radiate radio frequency energy and, if not installed and used in accordance with the instructions, may cause harmful interference to other devices in the vicinity. However, there is no guarantee that interference will not occur in a particular installation. If this equipment does cause harmful interference to other devices, which can be determined by turning the equipment off and on, the

user is encouraged to try to correct the interference by one or more of the following measures:

- Reorient or relocate the receiving device.
- Increase the separation between the equipment.
- Connect the equipment into an outlet on a circuit different from that to which the other device (s) are connected.
- Consult the manufacturer or field service technician for help.

**Video In / RS 232 / Video Out**

Accessories equipment connected to the analog and digital interfaces must be certified to the respective IEC standards (i.e. IEC 950 for data processing equipment and IEC 601-1 for medical equipment.) Furthermore all configurations shall comply with the system standard IEC 601-1-1. Everybody who connects additional equipment to the signal input part or signal output part configures a medical system, and is therefore, responsible that the system complies with the requirements of the system standard IEC 601-1-1. If in doubt, consult the technical services department or your local representative.

**Transport and Storage Limitations:**

Temperature Range of -40°C to +70°C

Relative Humidity of 10 -95%, non-condensing

---

\* Bio-accumulative is defined as substances which accumulate within living organisms.

\*\* Lead, Cadmium and Mercury are heavy metals which are Bio-accumulative.