

SSA-R2000

RFID Reader

user manual

imagine the possibilities



Thank you for purchasing this Samsung product.

To receive more complete service,
please visit our website.

www.samsungsecurity.com

SAMSUNG

safety information

	CAUTION RISK OF ELECTRIC SHOCK. DO NOT OPEN	
CAUTION: TO REDUCE THE RISK OF ELECTRIC SHOCK, DO NOT REMOVE COVER (OR BACK) NO USER SERVICEABLE PARTS INSIDE. REFER SERVICING TO QUALIFIED SERVICE PERSONNEL.		



This symbol indicates that dangerous voltage consisting a risk of electric shock is present within this unit.



This exclamation point symbol is intended to alert the user to the presence of important operating and maintenance (servicing) instructions in the literature accompanying the appliance.

WARNING

- To reduce the risk of fire or electric shock, do not expose this appliance to rain or moisture.

WARNING

1. Be sure to use only the standard adapter that is specified in the specification sheet. Using any other adapter could cause fire, electrical shock, or damage to the product.
2. Incorrectly connecting the power supply or replacing battery may cause explosion, fire, electric shock, or damage to the product.
3. Do not connect multiple controllers to a single adapter. Exceeding the capacity may cause abnormal heat generation or fire.
4. Securely plug the power cord into the power receptacle. Insecure connection may cause fire.
5. When installing the controller, fasten it securely and firmly. The fall of controller may cause personal injury.
6. Do not place conductive objects (e.g. screwdrivers, coins, metal parts, etc.) or containers filled with water on top of the controller. Doing so may cause personal injury due to fire, electric shock, or falling objects.
7. Do not install the unit in humid, dusty, or sooty locations. Doing so may cause fire or electric shock.
8. If any unusual smells or smoke come from the unit, stop using the product. In such case, immediately disconnect the power source and contact the service center. Continued use in such a condition may cause fire or electric shock.
9. If this product fails to operate normally, contact the nearest service center. Never disassemble or modify this product in any way. (SAMSUNG is not liable for problems caused by unauthorized modifications or attempted repair.)
10. When cleaning, do not spray water directly onto parts of the product. Doing so may cause fire or electric shock.

CAUTION

1. Do not drop objects on the product or apply strong blows to it. Keep away from a location subject to excessive vibration or magnetic interference.
2. Do not install in a location subject to high temperature (over 50°C), low temperature (below -10°C), or high humidity. Doing so may cause fire or electric shock.
3. If you want to relocate the already installed product, be sure to turn off the power and then move or reinstall it.
4. Remove the power plug from the outlet when there is a lightning storm. Neglecting to do so may cause fire or damage to the product.

2_ Safety information

5. Keep out of direct sunlight and heat radiation sources. It may cause fire.
6. Install it in a place with good ventilation.
7. Avoid aiming the controller directly towards extremely bright objects such as sun.
8. Apparatus shall not be exposed to dripping or splashing and no objects filled with liquids, such as vases, shall be placed on the apparatus.
9. The Mains plug is used as a disconnect device and shall stay readily operable at any time.

FCC Statement

This device complies with part 15 of the FCC Rules. Operation is subject to the following two conditions :

- 1) This device may not cause harmful interference, and
- 2) This device must accept any interference received including interference that may cause undesired operation.

Caution

This equipment has been tested and found to comply with the limits for a Class A digital device, pursuant to part 15 of FCC Rules. These limits are designed to provide reasonable protection against harmful interference when the equipment is operated in a commercial environment.

This equipment generates, uses, and can radiate radio frequency energy and, if not installed and used in accordance with the instruction manual, may cause harmful interference to radio communications. Operation of this equipment in a residential area is likely to cause harmful interference in which case the user will be required to correct the interference at his own expense.

IMPORTANT SAFETY INSTRUCTIONS

1. Read these instructions.
2. Keep these instructions.
3. Heed all warnings.
4. Follow all instructions.
5. Do not use this apparatus near water.
6. Clean only with dry cloth.
7. Do not block any ventilation openings. Install in accordance with the manufacturer's instructions.
8. Do not install near any heat sources such as radiators, heat registers, or other apparatus (including amplifiers) that produce heat.
9. Do not defeat the safety purpose of the polarized or grounding-type plug. A polarized plug has two blades with one wider than the other. A grounding type plug has two blades and a third grounding prong. The wide blade or the third prong is provided for your safety. If the provided plug does not fit into your outlet, consult an electrician for replacement of the obsolete outlet.
10. Protect the power cord from being walked on or pinched particularly at plugs, convenience receptacles, and the point where they exit from the apparatus.
11. Only use attachments/accessories specified by the manufacturer.
12. Use only with cart, stand, tripod, bracket, or table specified by the manufacturer, or sold with the apparatus.
13. Unplug this apparatus when a card is used. Use caution when moving the cart/ apparatus combination to avoid injury from tip-over.
14. Refer all servicing to qualified service personnel. Servicing is required when the apparatus has been damaged in any way, such as powersupply cord or plug is damaged, liquid has been spilled or objects have fallen into the apparatus, the apparatus has been exposed to rain or moisture, does not operate normally, or has been dropped.



contents

PRODUCT INTRODUCTION

5

- 5 Features
- 5 What's included
- 6 At a Glance
- 7 Cable Color Scheme
- 7 Cable Selection

INSTALLATION AND EXTERNAL CONNECTION

8

- 8 Installation
- 9 Precautions on installation
- 10 External Connection

INITIALIZATION

11

- 11 Output Format
- 12 Basic Operations

OUTPUT FORMAT

13

- 13 WIEGAND Output
- 14 4/8 BIT BURST Output Format

TROUBLESHOOTING

15

- 15 Troubleshooting

PRODUCT SPECIFICATIONS

16

- 16 Product Specifications

product introduction





FEATURES

This product is an elegant-looking proximity reader equipped with the built-in keypad, which has the maximum of 10 cm (4") read range. It is also supported by backlighting on the keypad, enabling stable operation at night. This product permits user access through authentication of the presented proximity card and personal identification number using the keypad. Red, green and orange LED indicators and the Piezo buzzer ensure reliable and accurate operation.

- ◆ 125 KHz Proximity / PIN Reader
- ◆ PSK Modulation
- ◆ 26 bit Wiegand Data Output
- ◆ 4/8 Bit Burst Output Format supported
- ◆ Numeric Keypad with Backlighting for Night Operation
- ◆ Control of External LED Indicators
- ◆ Control of External Buzzer
- ◆ Tamper Switch
- ◆ Reverse Polarity Protection

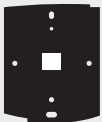
WHAT'S INCLUDED

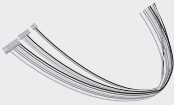
Check if the following items are included in the product package.

		
Product	Rear Panel	O-ring (x5)
		
3.5 x 40mm Screws (x4) 3.5 x 12mm Screws (x4) 6 x 30mm Plastic Anchor (x4)	Cable (x3)	CD Manual
		
Quick Guide		

product introduction

AT A GLANCE

Front/Rear

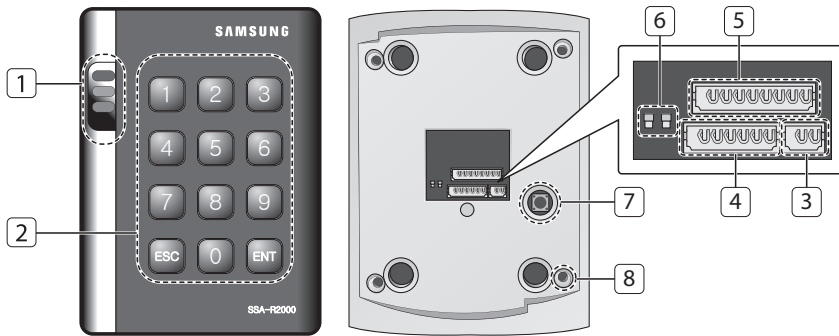

1 LED	Displays the status of the system operation.
2 Keypad	Used to enter the ID/password.
3 2-PIN Connector	Can be connected to the power cable.
4 6-PIN Connector	Can be connected to Wiegand cables.
5 8-PIN Connector	Connected to the tamper, LED and buzzer control connection cables.
6 Output Selection Switch	Switch that allows you to select an output from 8 bit, 4 bit Burst and Wiegand.
7 Tamper Switch	Tamper switch.
8 Fixing Screw	Screws for fixing the devices.

CABLE COLOR SCHEME

❖ 2-PIN Connector

I/O Pins	Signal	Cable Color
Power (+12V)	DC +12V	Red
Earth-grounding	GND (-)	Black

❖ 6-PIN Connector

I/O Pins	Signal	Cable Color
Wiegand Data Output 0	WIK_DATA0	Green
Wiegand Data Output 1	WIK_DATA1	White
Not Used	Not Used	Orange
Not Used	Not Used	Brown

❖ 8-PIN Connector

I/O Pins	Signal	Cable Color
Tamper Switch NC	Tamper NC	Green with White Stripes
Tamper Switch COM	Tamper COM	Gray
LED Control	Red LED Control	White with Red Stripes
LED Control	Green LED Control	Yellow
LED Control	Orange LED Control	Blue with White Stripes
Buzzer Control	BUZZER Control	Blue
Not Used	Not Used	Pink
Not Used	Not Used	Sky Blue

CABLE SELECTION

Item	Cable Type
1 Power (DC12V)	Belden #9409, 18 AWG 2 Conductor, Unshielded (Maximum Allowable Distance : Within 3m)
2 Card/PIN data (Wiegand) Control Signal (LED,BUZZER) TAMPER	Belden #9512, 22 AWG 4 Conductor, Shielded
	Belden #9514, 22 AWG 8 Conductor, Shielded

installation and external connection

INSTALLATION

1. Attach the provided rear panel to the wall and drill two 6-32 holes and one 1/2 inch hole on it.
(See [Figure 1])
2. Refer to [Figure 2] below on how to secure the rear panel to the wall using the provided screws.
3. Apply each of 5 O-rings to the corresponding point as shown in [Figure 2].
4. Fix the main unit with the rear panel by inserting the main unit's cables into the center hole and pushing the main unit towards the rear panel.

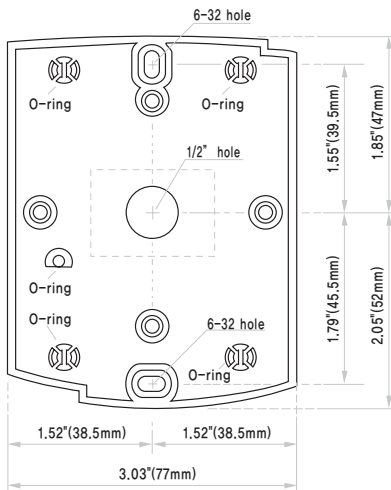

[Figure 1]

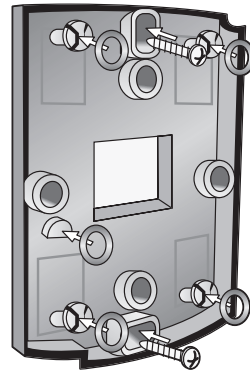

[Figure 2]

- ! ■ Once the main unit is fixed with the rear panel, it will not be loosened. Please check if the device is operating properly before fixing it.
If you try to remove the rear panel once it is fixed, the lock parts of the rear panel will break, resulting in a situation where the whole rear panel must be replaced.

PRECAUTIONS ON INSTALLATION

IF INSTALLING ON A METAL WALL

If you install the reader on a metal wall, the read range may be reduced. To avoid this problem, it is recommended to insert the spacer between the metal wall and the reader as shown below.

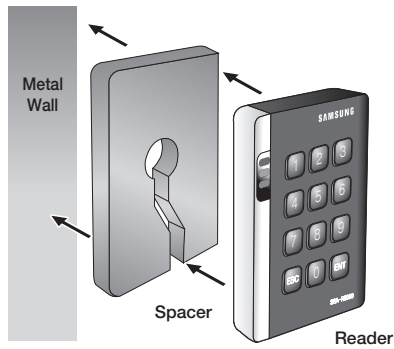

IF INSTALLING MORE THAN ONE READER SIDE BY SIDE OR FRONT AND BACK

If you install more than one reader side by side or front and back, the read range may be reduced. In this case, if you present a card to one reader, the other reader may recognize the same card, meaning both readers read the same card simultaneously.

To avoid this problem, keep at least 20 cm of space between the two readers.

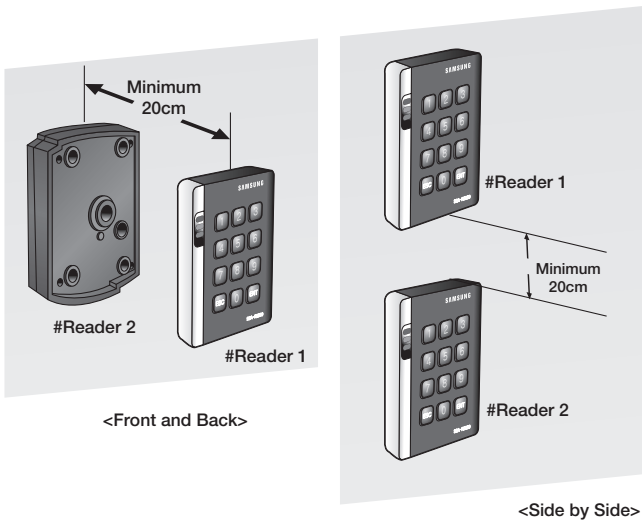

installation and external connection

EXTERNAL CONNECTION

WIRING DIAGRAM

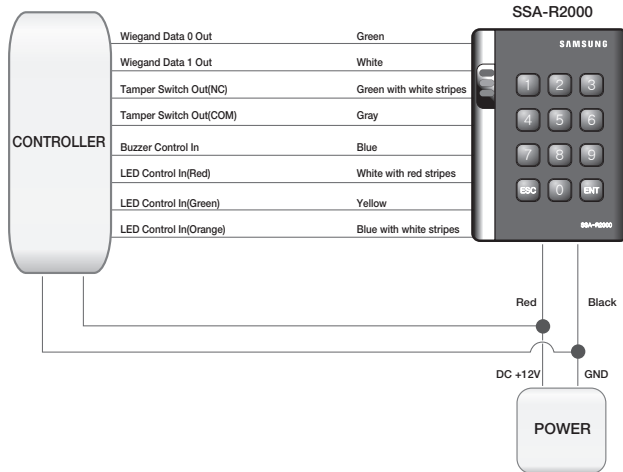

Category	Cable Color
Power Supply Unit	Connect the DC+12V to the red line.
	Connect GND to the black line.
Wiegand Connection	Connect the green line of the product to the Wiegand D0 input port of the controller.
	Connect the white line of the product to the Wiegand D1 input port of the controller.
LED Control	Enables you to turn on or off the LED indicators. To control green indicator, connect the yellow line to the controller's output (relay). Connect the blue with white stripes to control the orange indicator, connect the white with red stripes to control the red indicator. (see page 12)
Buzzer Control	Enables you to turn on or off the buzzer. To control the buzzer, connect the blue line to the controller's output (relay). (see page 12)
Tamper Control	Connect the COM port (gray line) of the product's tamper switch to GND; connect the NC port (green with white stripe) of the tamper switch to the input port of the controller.

initialization

OUTPUT FORMAT

You can adjust the output format of the numeric values from the keypad.

You can select 4/8 bit Burst or 26bit Wiegand.

Adjust the format according to the controller receiving the keypad input.

1. To change the output format, use the switch on the rear of the product.
2. See the table below to make adjustment as needed.

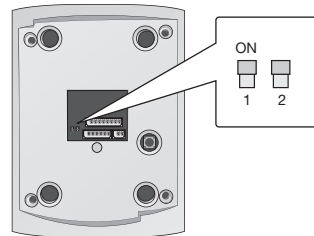

❖ Output Format

SW #1	SW #2	Output Format of Card	Output Format of Keypad
ON	ON	26bit Wiegand	8bit Burst (Default)
ON	OFF	26bit Wiegand	26bit Wiegand
OFF	ON	26bit Wiegand	26bit Wiegand
OFF	OFF	26bit Wiegand	4bit Burst

- Switch #1 and #2 of SW are set to ON by default.
- Before you change the output format, you must disconnected the power.

initialization

BASIC OPERATIONS

Initial State (when the power is supplied)

When you apply power to the product, it will sound beep three times before entering Standby with the red indicator turned on.

Using the card

Present the card to the product until you hear a beep and the green indicator turns on. The reader keeps the green indicator turned on while transferring the card data to the controller. When it is done, the green indicator turns off and for receiving the next card, the red indicator stays ON.



Using the keypad

Hold down the keypad until you hear a beep. The reader transfers the keypad data to the controller.

If the output format of the keypad is 26-bit Wiegand, pressing any key of the keypad turns on orange indicator, and green indicator blinks when [ENT] is pressed after the input. The red indicator stays on after transferring data to the controller. By default, it is 8-bit burst. Hence, keypad input and pressing [ENT] will blink the green indicator only when you change the option to 26bit Wiegand.

LED Control

You can control the red, green and orange indicators as necessary.

To control the red indicator, connect the red indicator control input line (white with red stripes) to the relay output NO port of the controller, and connect the GND line to the COM line. Set I/O of the controller; now you can control turning on/off the indicators.

You can turn on/off the indicators according to the I/O settings of the controller, which can be applied to various situations.

For more information about the I/O settings of the controller, refer to the user manual of the controller.

Connect the yellow line for the green indicator, or the blue with white stripes for the orange indicator, to the COM port of the controller.

Buzzer Control

Connect the buzzer control input line (blue) to the NO port of the controller relay output, and GND to the COM port. You can configure the I/O settings of the controller so that it beeps. If the product continues to beep, it means that the buzzer control is working properly.

The controller can use the I/O settings to set the buzzer control so that it sounds an additional beep for authorized or unauthorized access upon user authentication.

Furthermore, you can make various modifications according to the different I/O settings of the controller.

For more information about the I/O settings of the controller, refer to the user manual of the controller.

Card reading is not available while the buzzer control is sounding the buzzer.

Tamper Control

You can set the signal that you want to output if the device is dismantled forcibly.

Connect the COM port (gray line) of the product's tamper switch to GND; connect the NC port (green with white stripe) of the tamper switch to the input port of the controller. If the tamper of the reader operates, the controller produces an input signal and generates the corresponding output depending on the controller setting.

output format

WIEGAND OUTPUT

Timing Diagram

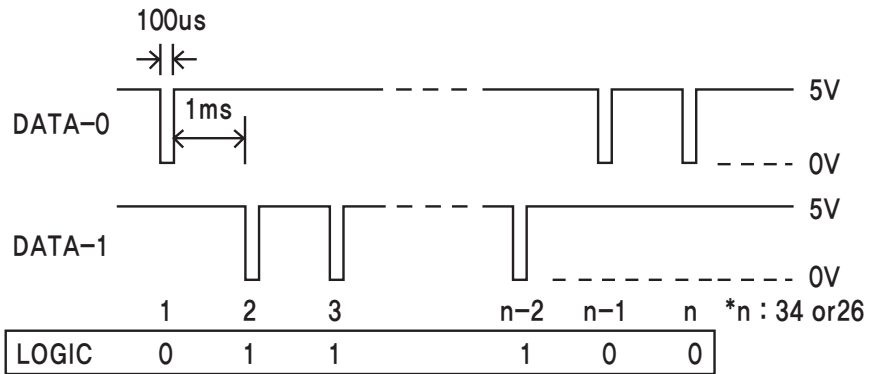

● OUTPUT FORMAT

Data Type (26-bit)

- Bit 1 : Even Parity (bit 2 ~ bit 13)
- Bit 2 ~ 9 : Facility Code (000 ~ 255)
- Bit 10 ~ 25 : ID Number (00000 ~ 65,535)
- Bit 26 : Odd Parity (bit 14 ~ bit 25)

output format

4/8 BIT BURST OUTPUT FORMAT

4Bit Burst Output Format

Keypads	Binary	Hexa	Keypads	Binary	Hexa
0	0000	0	6	0110	6
1	0001	1	7	0111	7
2	0010	2	8	1000	8
3	0011	3	9	1001	9
4	0100	4	ESC	1010	A
5	0101	5	ENT	1011	B

8Bit Burst Output Format

Keypads	Binary	Hexa	Keypads	Binary	Hexa
0	11110000	F0	6	10010110	96
1	11100001	E1	7	10000111	87
2	11010010	D2	8	01111000	78
3	11000011	C3	9	01101001	69
4	10110100	B4	ESC	01011010	5A
5	10100101	A5	ENT	01001011	4B

troubleshooting

TROUBLESHOOTING

If the product does not function properly, please see the below for trouble shooting. If the trouble persists, please contact the SAMSUNG Customer Service near you.

PROBLEM	SOLUTION
My card is not read properly.	<ol style="list-style-type: none">1) Check the rated voltage specified in the user manual and the catalog.2) Ensure that the card must comply with the PSK (125KHz) format provided by Samsung. - Cards of 13.56MHz format can not be used. (Contact the card retailer regarding the card format.)3) If the problem persists, contact the nearest customer service for your assistance.
When I turn on the product, it sounds a beep with dimly turned on indicator.	<ol style="list-style-type: none">1) Ensure that you are using a larger-capacity adaptor than specified in the user manual or the catalog, which should cover the rated current consumption of the reader. If you are using multiple readers that are connected to one adaptor, make sure that the adaptor should be large enough to cover the current consumption multiplied by the reader count.2) Even with a large adaptor enough to supply adequate power, if the power cable is not a dedicated line (such as communication line or UPT cable), or if it's so long to cause power loss, you'd better replace it with a dedicated line or reinforce it.3) If the problem persists, contact the nearest customer service for your assistance.
The read range (R/R) of the card differs each time the product reads the card.	<ol style="list-style-type: none">1) The characteristics of a card are determined by the nature of the coils used and in the manufacturing process engaged by the card manufacturer. So what you do first is to check that the cards in use are made by the same manufacturer. If you are using cards from different card makers, the read range (R/R) differs by the card, which is the result of normal operation.2) If you encounter a different read range for each card that is made by the same manufacturer, please contact the nearest customer service.

product specifications

PRODUCT SPECIFICATIONS

Item	SSA-R2000
Power / Current	DC 12V / Max.95mA
Reading Time (Card)	30ms
Input Port	2 ea : External LED Control, External Buzzer Control
Output Port	26bit Wiegand, 4/8bit Burst for PIN (Selectable)
LED Indicator	3 LED Indicators (Red, Green and Orange)
Beeper	Piezo Buzzer
Keypad	12 Key Numeric Keypad with Back Lighting
Operating Temperature	-30°C to +50°C
Operating Humidity	10% to 90% Relative Humidity Non-Condensing
Color / Material	Silver with Black/ Polycarbonate
Dimension (W x H x D(mm))	87.0 x 109.0 x 31.0
Weight	160g
RF Specifications	Frequency : 125KHz
	Modulation : PSK
	No. of Channels : 1CH
	Output : Less than 65.80dBuA/m at a distance of 10m



Correct Disposal of This Product (Waste Electrical & Electronic Equipment)

(Applicable in the European Union and other European countries with separate collection systems)



This marking on the product, accessories or literature indicates that the product and its electronic accessories (e.g. charger, headset, USB cable) should not be disposed of with other household waste at the end of their working life. To prevent possible harm to the environment or human health from uncontrolled waste disposal, please separate these items from other types of waste and recycle them responsibly to promote the sustainable reuse of material resources.

Household users should contact either the retailer where they purchased this product, or their local government office, for details of where and how they can take these items for environmentally safe recycling.

Business users should contact their supplier and check the terms and conditions of the purchase contract. This product and its electronic accessories should not be mixed with other commercial wastes for disposal.

Correct disposal of batteries in this product

(Applicable in the European Union and other European countries with separate battery return systems.)



This marking on the battery, manual or packaging indicates that the batteries in this product should not be disposed of with other household waste at the end of their working life. Where marked, the chemical symbols Hg, Cd or Pb indicate that the battery contains mercury, cadmium or lead above the reference levels in EC Directive 2006/66. If batteries are not properly disposed of, these substances can cause harm to human health or the environment.

To protect natural resources and to promote material reuse, please separate batteries from other types of waste and recycle them through your local, free battery return system.