

SAMSUNG

MICROWAVE OVEN

Owner's Instructions & Cooking Guide

CE2727N / CE2727NT

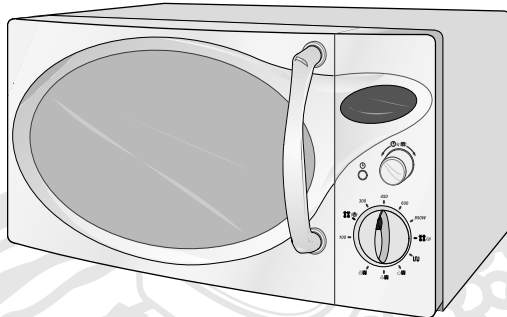

Quick Look-up Guide.....	2
Oven.....	2
Control Panel	3
Accessories	3
Using this Instruction Booklet.....	4
Safety Precauciones	4
Installing Your Microwave Oven.....	5
Setting the Time	6
How a Microwave Oven Works	6
Checking that Your Oven is Operating Correctly	7
What to Do if You are in Doubt or Have a Problem	7
Cooking / Reheating.....	8
Power Levels.....	8
Stopping the Cooking.....	8
Adjusting the Cooking Time	9
Manual Defrosting of Food.....	9
Using the Auto Defrosting Feature.....	9
Auto Defrost Settings	9
Using the Crusty Plate (CE2727NT)	10
Crusty Plate Setting (CE2727NT)	11
Choosing the Heating Element Position.....	12
Choosing the Accessories.....	12
Grilling	13
Combining Microwaves and the Grill.....	13
Cookware Guide.....	14
Cooking Guide.....	15
Cleaning Your Microwave Oven.....	21
Storing and Repairing Your Microwave Oven.....	22
Installation & Wiring Instructions	22
Wiring Instructions.....	23
Cooking Instructions On Food Packaging.....	23
Cooking Instructions.....	23
Technical Specifications.....	Back Cover



Quick Look-up Guide

If you want to cook some food

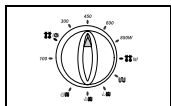

1. Place the food in the oven.
Select the power level by rotating the **COOKING POWER CONTROL** knob.

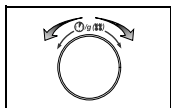

2. Select the cooking time by rotating the **TIME/WEIGHT** (🕒/🍖) dial. .
Result: Cooking starts after about two seconds.

If you want to Auto Defrost some food

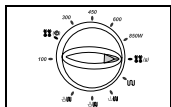

1. Turn the **COOKING POWER CONTROL** knob to the **Auto Defrost** (❄️) symbol.

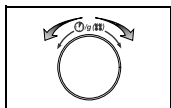

2. Turn the **TIME/WEIGHT** (🕒/🍖) dial to select the appropriate weight.
Result: Cooking starts after about two seconds.

If you want to adjust the cooking time

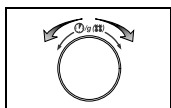

- Leave the food in the oven.
Turn the **TIME/WEIGHT** (🕒/🍖) dial to the desired time.

If you want to grill some food

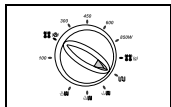

1. Turn the **COOKING POWER CONTROL** dial to the **Grill** (U) symbol.

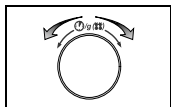

2. Turn the **TIME/WEIGHT** (🕒/🍖) knob to select the appropriate time.
Result: Cooking starts after about two seconds.

Oven

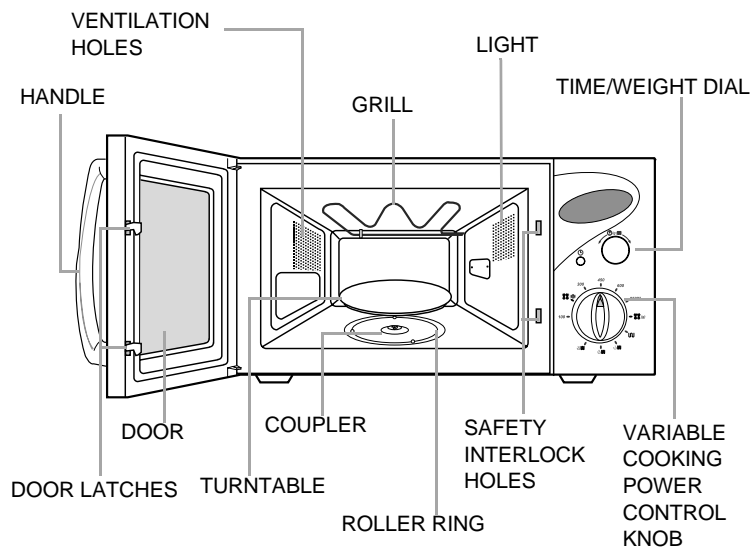

Control Panel

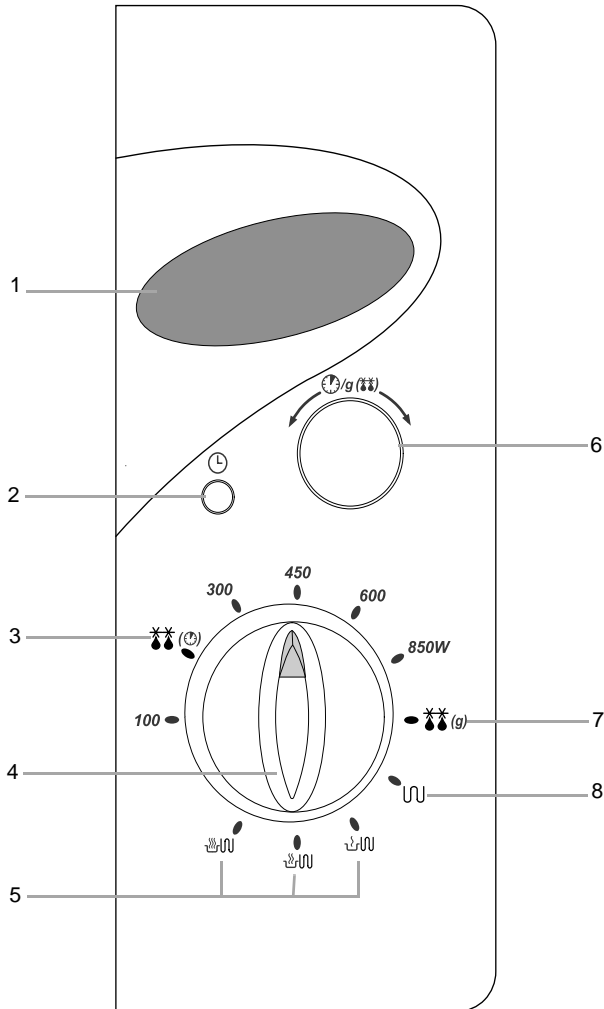

- | | |
|--|------------------------------|
| 1. DISPLAY | 5. COMBI (Microwave + Grill) |
| 2. CLOCK SETTING BUTTON | 6. TIME/WEIGHT DIAL |
| 3. MANUAL DEFROST | 7. AUTO DEFROST |
| 4. VARIABLE COOKING POWER CONTROL KNOB | 8. GRILL |

Accessories

Depending on the model that you have purchased, you are supplied with several accessories that can be used in a variety of ways.

GB

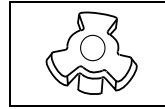

1. **Coupler**, already placed over the motor shaft in the base of the oven.

Purpose: The coupler rotates the turntable.

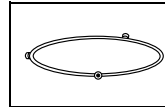

2. **Roller ring**, to be placed in the centre of the oven.

Purpose: The roller ring supports the turntable.

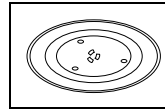

3. **Turntable**, to be placed on the roller ring with the centre fitting to the coupler.

Purpose: The turntable serves as the main cooking surface; it can be easily removed for cleaning.

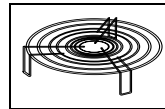

4. **Metal rack**, to be placed on the turntable.

Purpose: The metal rack can be used in grill and combination cooking.

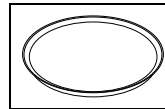

5. **Crusty plate (CE2727NT only)**, see page 10.

Purpose: The crusty plate is used to brown food better in the microwave or grill combination cooking modes. It helps keep pasty and pizza dough crisp.



DO NOT operate the microwave oven without the roller ring and turntable.

Using this Instruction Booklet

You have just purchased a SAMSUNG microwave oven. Your Owner's Instructions contain much valuable information on cooking with your microwave oven:

- Safety precautions
- Suitable accessories and cookware
- Useful cooking tips

Inside the cover you will find a quick look-up guide explaining four basic cooking operations:

- Cooking food
- Defrosting food
- Grilling food
- Adding extra cooking time

At the front of the booklet you will find illustrations of the oven, and more importantly the control panel, so that you can find the buttons more easily.

The step-by-step procedures use four different symbols.



Important



Note



Caution



Turn

PRECAUTIONS TO AVOID POSSIBLE EXPOSURE TO EXCESSIVE MICROWAVE ENERGY

Failure to observe the following safety precautions may result in harmful exposure to microwave energy.

- Under no circumstances should any attempt be made to operate the oven with the door open or to tamper with the safety interlocks (door latches) or to insert anything into the safety interlock holes.
- Do not place any object between the oven door and front face or allow food or cleaner residues to accumulate on sealing surfaces. Ensure that the door and door sealing surfaces are kept clean by wiping after use first with a damp cloth and then with a soft dry cloth.
- Do not operate the oven if it is damaged until it has been repaired by a qualified microwave service technician trained by the manufacturer. It is particularly important that the oven door closes properly and that there is no damage to the:
 - (1) Door, door seals and sealing surfaces
 - (2) Door hinges (broken or loose)
 - (3) Power cable
- The oven should not be adjusted or repaired by anyone other than a properly qualified microwave service technician trained by the manufacturer.

Safety Precauciones

Important Safety Instructions.

Read Carefully and keep for future reference.

Before cooking food or liquids in your microwave oven, please check that the following safety precautions are taken.

- DO NOT** use any metallic cookware in the microwave oven:
 - Metallic containers
 - Dinnerware with gold or silver trimmings
 - Skewers, forks, etc.

Reason: Electric arcing or sparking may occur and may damage the oven.
- DO NOT** heat:
 - Airtight or vacuum-sealed bottles, jars, containers
Ex) Baby food jars
 - Airtight food.
Ex) Eggs, nuts in shells, tomatoes

Reason: The increase in pressure may cause them to explode.
Tip: Remove lids and pierce skins, bags, etc.
- DO NOT** operate the microwave oven when it is empty.
Reason: The oven walls may be damaged.
Tip: Leave a glass of water inside the oven at all times.
The water will absorb the microwaves if you accidentally set the oven going when it is empty.
- DO NOT** cover the rear ventilation slots with cloths or paper.
Reason: The cloths or paper may catch fire as hot air is evacuated from the oven.
- ALWAYS** use oven gloves when removing a dish from the oven.
Reason: Some dishes absorb microwaves and heat is always transferred from the food to the dish. The dishes are therefore hot.
- DO NOT** touch heating elements or interior oven walls.
Reason: These walls may be hot enough to burn even after cooking has finished, even though they do not appear to be so. Do not allow inflammable materials to come into contact with any interior area of the oven. Let the oven cool down first.
- To reduce the risk of fire in the oven cavity:
 - Do not store flammable materials in the oven.
 - Remove wire twist ties from paper or plastic bags.
 - Do not use your microwave oven to dry newspapers.
 - If smoke is observed, keep the oven door closed and switch off or disconnect the oven from the power supply.

Safety Precautions (continued)

8. Take particular care when heating liquids and baby foods.
 - ALWAYS allow a standing time of at least 20 seconds after the oven has been switched off so that the temperature can equalize.
 - Stir during heating, if necessary, and ALWAYS stir after heating.
 - Take care when handling the container after heating. You may burn yourself if the container is too hot.
 - A risk of delayed eruptive boiling exists.
 - To prevent delayed boiling and possible scalding, you should put a plastic spoon or glass stick into the beverages and stir before, during and after heating.
Reason: During the heating of liquids the boiling point can be delayed; this means that eruptive boiling can start after the container is removed from the oven. You may scald yourself.
 - In the event of scalding, follow these FIRST AID instructions:
 - * Immerse the scalded area in cold water for at least 10 minutes.
 - * Cover with a clean, dry dressing.
 - * Do not apply any creams, oils or lotions.
 - **NEVER** fill the container to the top and choose a container that is wider at the top than at the bottom to prevent the liquid from boiling over. Bottles with narrow necks may also explode if overheated.
 - **ALWAYS** check the temperature of baby food or milk before giving it to the baby.
 - **NEVER** heat a baby's bottle with the teat on, as the bottle may explode if overheated.
9. Be careful not to damage the power cable.
 - Do not immerse the power cable or plug in water and keep the power cable away from heated surfaces.
 - Do not operate this appliance if it has a damaged power cable or plug.
10. Stand at arm's length from the oven when opening the door.
Reason: The hot air or steam released may cause scalding.
11. Keep the inside of the oven clean.
Reason: Food particles or spattered oils stuck to oven walls or floor can cause paint damage and reduce the efficiency of the oven.
12. You may notice a "Clicking" sound during operation (especially when the oven is in defrosting).
Reason: This sound is normal when the electrical power output is changing.
13. When the microwave oven is operating without any load, the power will be cut off automatically for safety. You can operate the oven normally after letting it stand for over 30 minutes.

IMPORTANT SAFETY INSTRUCTIONS

During cooking, you should look into the oven from time to time when food is being heated or cooked in disposable containers of plastic, paper or other combustible materials.

IMPORTANT

Young children should NEVER be allowed to use or play with the microwave oven. Nor should they be left unattended near the microwave oven when it is in use. Items of interest to children should not be stored or hidden just above the oven.

Installing Your Microwave Oven

Place the oven on a flat, level surface that is strong enough to safely bear the weight of the oven.

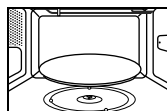
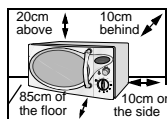

1. When you install your oven, make sure there is adequate ventilation for your oven by leaving at least 10 cm (4 inches) of space behind, and on the sides of the oven and 20 cm (8 inches) of space above the oven and 85 cm (33 inches) of the floor.
 2. Remove all packing materials inside the oven. Install the roller ring and turntable. Check that the turntable rotates freely.
 3. This microwave oven has to be positioned so that plug is accessible.
- * **Never** block the air vents as the oven may overheat and automatically switch itself off. It will remain inoperable until it has cooled sufficiently.
 - * For your personal safety, plug the cable into a 3-pin, 230 Volt, 50Hz, AC earthed socket. If the power cable of this appliance is damaged, it must be replaced by the manufacturer or its service agent or a similarly qualified person in order to avoid a hazard.
 - * **Do not** install the microwave oven in hot or damp surroundings like next to a traditional oven or radiator. The power supply specifications of the oven must be respected and any extension cable used must be of the same standard as the power cable supplied with the oven. Wipe the interior and the door seal with a damp cloth before using your microwave oven for the first time.

Setting the Time

Your microwave oven has an inbuilt clock. The time can be displayed in either the 24-hour or 12-hour notation. You must set the clock:

- When you first install your microwave oven
- After a power failure

☒ Do not forget to reset the clock when you switch to and from summer or winter time.

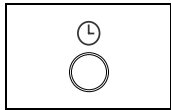

1. To display the time in the.. Then press the button (L)..
24-hour notation Once
12-hour notation Twice

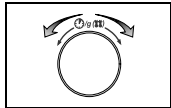

2. Turn the **TIME/WEIGHT** (0/9/12) dial to set hour.

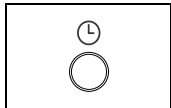

3. Press the L button.

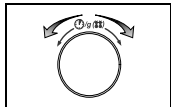

4. Turn the **TIME/WEIGHT** (0/9/12) dial to set minute.

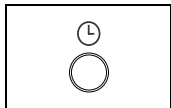

5. Press the L button.

How a Microwave Oven Works

Microwaves are high-frequency electromagnetic waves; the energy released enables food to be cooked or reheated without the foods form or colour changing.

You can use your microwave oven to:

- Defrost (manual & auto)
- Cook
- Reheat

Cooking Principle

1. The microwaves generated by the magnetron are distributed uniformly as the food rotates on the turntable. The food is thus cooked evenly.
2. The microwaves are absorbed by the food up to a depth of about 1 inch (2.5 cm). Cooking then continues as the heat is dissipated within the food.
3. Cooking times vary according to the recipient used and the properties of the food:
 - Quantity and density
 - Water content
 - Initial temperature (refrigerated or not)

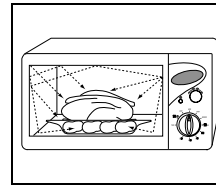

As the centre of the food is cooked by heat dissipation, cooking continues even when you have taken the food out of the oven. Standing times specified in recipes and in this booklet must therefore be respected to ensure:

- Even cooking of the food right to the centre
- The same temperature throughout the food

Checking that Your Oven is Operating Correctly

The following simple procedure enables you to check that your oven is working correctly at all times.

Open the oven door by pulling the handle on the right side of the door. Place a glass of water on the turntable. Then, close the door.

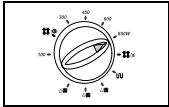

1. Set the power level to maximum by turning **COOKING POWER CONTROL** knob.

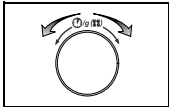

2. Set the time 4 to 5 minutes by turning the **TIME/WEIGHT** (⌚/g) dial.

Result: The oven light comes on and the turntable starts rotating.

- 1) Cooking starts and when it has finished the oven beeps four times.
- 2) The end reminder signal will beep 3 times (once every minute).
- 3) The current time is displayed again.

✖ The oven must be plugged into an appropriate wall socket. The turntable must be in position in the oven. If a power level other than the maximum is used, the water takes longer to boil.

What to Do if You are in Doubt or Have a Problem

If you have any of the problems listed below try the solutions given.

- ◆ This is normal.
 - Condensation inside the oven
 - Air flow around the door and outer casing
 - Light reflection around the door and outer casing
 - Steam escaping from around the door or vents.
 - ◆ The oven does not start when you turn the **TIME/WEIGHT** (⌚/g) dial.
 - Is the door completely closed?
 - ◆ The food is not cooked at all
 - Have you set the time correctly?
 - Is the door closed?
 - Have you overloaded the electric circuit and caused a fuse to blow or a breaker to be triggered?
 - ◆ The food is either overcooked or undercooked
 - Was the appropriate cooking length set for the type of food?
 - Was an appropriate power level chosen?
 - ◆ Sparking and cracking occur inside the oven (arcing)
 - Have you used a dish with metal trimmings?
 - Have you left a fork or other metal utensil inside the oven?
 - Is aluminium foil too close to the inside walls?
 - ◆ The oven causes interference with radios or televisions
 - Slight interference may be observed on televisions or radios when the oven is operating. This is normal. To solve this problem, install the oven away from televisions, radios and aerials.
 - If interference is detected by the oven's microprocessor, the display may be reset. To solve this problem, disconnect the power plug and reconnect it. Reset the time.
- ✖ If the above guidelines do not enable you to solve the problem, contact your local dealer or SAMSUNG after-sales service.

GB

Cooking / Reheating

The following procedure explains how to cook or reheat food. **ALWAYS check your cooking settings before leaving the oven unattended.**

First, place the food in the centre of the turntable. Then, close the door.

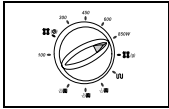

1. Set the power level to maximum by turning **COOKING POWER CONTROL** knob. **(MAXIMUM POWER : 850 W)**

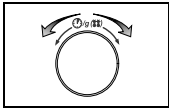

2. Set the time by turning **TIME/WEIGHT** dial.

Result: The oven light comes on and the turntable starts rotating.

 - 1) Cooking starts and when it has finished the oven beeps four times.
 - 2) The end reminder signal will beep 3 times (once every minute).
 - 3) The current time is displayed again..



Never switch the microwave oven on when it is empty.



You can change the power level during cooking by turning the **COOKING POWER CONTROL** knob.

Power Levels

You can choose any of the power levels listed below.

Power Level	Output	
	MWO	GRILL
HIGH	850 W	
MEDIUM HIGH	600 W	
MEDIUM	450 W	
MEDIUM LOW	300 W	
MANUAL DEFROST ()	180 W	
AUTO DEFROST ()	180 W	
LOW / KEEP WARM	100 W	
GRILL	-	1100 W
COMBI I	300 W ()	1100 W
COMBI II	450 W ()	1100 W
COMBI III	600 W ()	1100 W



If you select higher power level, the cooking time must be decreased.



If you select lower power level, the cooking time must be increased.

Stopping the Cooking

You can stop cooking at any time to check the food.

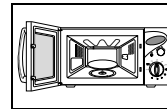

1. To stop temporarily;
Open the door.
Result: Cooking stops. To resume cooking, close the door.

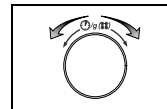

2. To stop completely;
Turn the **TIME/WEIGHT** dial to the left.
“: 0 “ will be displayed.



Adjusting the Cooking Time

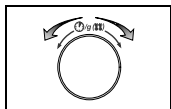

Adjust the remaining cooking time by rotating the **TIME/WEIGHT** (🕒/⚖️) dial.
During the cooking to increase or decrease the cooking time of you food, turn the dial right or left.

Manual Defrosting of Food

The Manual Defrost feature enables you to defrost meat, poultry, fish. First, place the frozen food in the centre of the turntable and close the door.

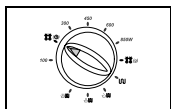

1. Turn the **COOKING POWER CONTROL** knob to the **Manual Defrost** (🍖/🕒) symbol.

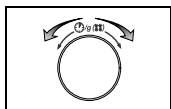

2. Turn the **TIME/WEIGHT** (🕒/⚖️) dial to select the appropriate time.
Result: The oven light comes on and the turntable starts rotating.
1) Cooking starts and when it has finished the oven beeps four times.
2) The end reminder signal will beep 3 times (once every minute).
3) The current time is displayed again.



Use only recipients that are microwave-safe.



Select the Manual Defrosting function with a power level of 180 W if you want to defrost food manually. For further details on manual defrosting and defrosting time, refer to the page 18.

Using the Auto Defrosting Feature

The Auto Defrost feature enables you to defrost meat, poultry, fish. First, place the frozen food in the centre of the turntable and close the door.

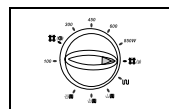

1. Turn the **COOKING POWER CONTROL** knob to the **Auto Defrost** (🍖/🕒) symbol.

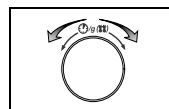

2. Turn the **TIME/WEIGHT** (🕒/⚖️) dial to select the appropriate weight.

Result: The oven light comes on and the turntable starts rotating.

- 1) Cooking starts and when it has finished the oven beeps four times.
- 2) The end reminder signal will beep 3 times (once every minute).
- 3) The current time is displayed again.



Use only recipients that are microwave-safe.

Auto Defrost Settings

Remove all kinds of packaging material before defrosting.

Place the frozen foods on a turntable.

Turn the food over when the oven beeps.

Keep the corresponding standing time after Auto Defrosting has finished.

Food	Portion	Standing Time	Recommendation
Meat	200-1500g	20-60 min	Shield the edges with aluminium foil.
Poultry	200-1500g	20-60 min	Turn the food over when the oven beeps.
Fish	200-1500g	20-50 min	

Using the Crusty Plate (CE2727NT)

Your Samsung microwave oven features a crusty plate as an additional accessory.

This crusty plate allows you to brown food not only on the top with the grill, but also the bottom of the food turns crispy and brown due to the high temperature of the crusty plate.

Several items which you can prepare on the crusty plate can be found in the chart (see next page).

The crusty plate can also be used for bacon, eggs, sausages, etc.

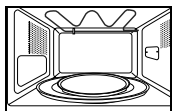

1. Place the crusty plate directly on the turntable and preheat it with the highest Microwave-Grill Combination[600W+Grill (☀️)] setting by following the times and instructions in the chart.

☞ Always use oven gloves to take out the crusty plate, as will become very hot.

2. Brush the plate with oil if you are cooking food, such as bacon and eggs, in order to brown the food nicely.

* Please note that the crusty plate has a teflon layer which is not scratch-resistant. Do not use any sharp objects like a knife to cut on the crusty plate.

* Use plastic accessories to avoid scratches on the surface of the crusty plate or remove the food from the plate before cutting.

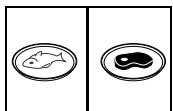

3. Place the food on the crusty plate.

☞ Do not place any objects on the crusty plate that are not heat-resistant; e.g. plastic bowls.

☞ Never place the crusty plate in the oven without the turntable.

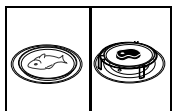

4. Place the crusty plate on the metal rack(or turntable) in the microwave.

5. Select the appropriate cooking time and power. Refer to the table on the next page .

☒ How to clean the Crusty Plate

Clean the crusty plate with warm water and detergent and rinse off with clean water.

- ☒ Do not use a scrubbing brush or a hard sponge otherwise the top layer will be damaged.

* Please Note

The crusty plate is not dishwasher-safe.

Crusty Plate Setting (CE2727NT)

We recommend to preheat the crusty plate directly on the turntable.

Preheat the crusty plate with 600 W + Grill (🔥) function and follow the times and instructions in the table.

Food	Portion	Preheating Time	Power	Cooking Time	Recommendations
Bacon	4 Slices (80g)	3 min	600W+ Grill 🔥	3-3½ min	Preheat crusty plate. Put slices side by side on crusty plate. Put crusty plate on the rack.
Grilled Tomatoes	200 g (2pcs)	3 min	450W+ Grill 🔥	4-4½ min	Preheat crusty plate. Cut tomatoes in halves. Put some cheese on top. Arrange in a circle on crusty plate. Put crusty plate on the rack.
Burger (frozen)	2 pieces (125g)	3 min	600W+ Grill 🔥	6½-7 min	Preheat crusty plate. Put frozen burger in a circle on crusty plate. Put crusty plate on the rack. Turn over after 4- 5 min.
Baguettes (frozen)	200-250 g (2pcs)	4 min	450W+ Grill 🔥	7-8 min	Preheat crusty plate. Put one baguette beside the centre, 2 baguettes side by side on the plate. Put crusty plate on rack.
Pizza (frozen)	300 - 350 g	4 min	600W+ Grill 🔥	8-9 min	Preheat crusty plate. Put the frozen pizza on the crusty plate. Put crusty plate on the rack.

Baked Potatoes	250 g	3 min	600W+ Grill 🔥	5-6 min	Preheat crusty plate. Cut potatoes in halves. Put them on the crusty plate with the cut side to the bottom. Arrange in a circle. Put the plate on the rack.
	500 g			8-9 min	
Fish Fingers (frozen)	150 g (5 pcs)	4 min	600W+ Grill 🔥	6½-7 min	Preheat crusty plate. Brush plate with 1 tbsp. oil. Put fish fingers in a circle on the plate. Turn over after 3½ min (5 pcs) or after 5 min (10 pcs).
	300 g (10 pcs)			9-9½ min	
Chicken Nuggets (frozen)	125 g	4 min	600W+ Grill 🔥	4½ -5 min	Preheat crusty plate. Brush plate with 1 tbsp. oil. Put chicken nuggets on the plate. Put crusty plate on the rack. Turn over after 3 min (125g) or 5 min (250g).
	250 g			7-7½ min	
Pizza (chilled)	300 - 350 g	4 min	450W+ Grill 🔥	5½-6½ min	Preheat crust plate. Put the chilled pizza pieces in a circle on the plate. Put crust plate on rack.

GB

Choosing the Heating Element Position

The heating element is used when grilling. It can be placed in one of two positions:

- **Horizontal position for grilling or combined microwave + grill cooking**

☞ Only change the position of the heating element when it is cold and do not apply excessive force when placing it in the vertical position.

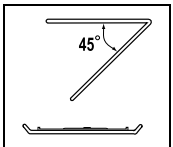
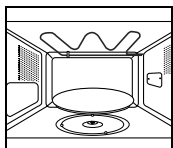

To set the heating element to the...	Then...
Horizontal position (grill or combined microwave + grill)	<ul style="list-style-type: none"> ◆ Pull the heating element towards you ◆ Push it upwards until it is parallel with the roof of the oven

When cleaning the upper part inside the cavity, it will be convenient to turn the heater downward by 45° and clean it.

Choosing the Accessories

Use microwave-safe recipients; do not use plastic containers, dishes, paper cups, towels, etc.

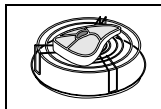

If you wish to select the combined cooking mode (grill and microwave), use only dishes that are microwave-safe and oven-proof. Metallic cookware or utensils may damage your oven.

☒ For further details on suitable cookware and utensils, refer to the Cookware Guide on page 14.

Grilling

The grill enables you to heat and brown food quickly, without using microwaves. For this purpose, a grill rack is supplied with your microwave oven.

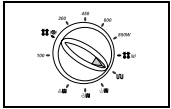

1. Preheat the grill to the required temperature, by turning the cooking power control knob to **grill** symbol (⌋) and turning the **TIME/WEIGHT** (⌚) knob to the appropriate position.

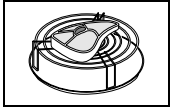

2. Open the door. Place the food on the rack and the rack on the turntable. Close the door.

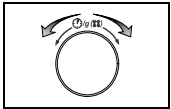

3. Set the time by turning the **TIME/WEIGHT** (⌚) dial.
Result: The oven light comes on and the turntable starts rotating.
 - 1) Cooking starts and when it has finished the oven beeps four times.
 - 2) The end reminder signal will beep 3 times (once every minute).
 - 3) The current time is displayed again.

Do not worry if the heater turns off and on while grilling. This system is designed to prevent overheating of the oven.

Always use oven gloves when touching the dishes in the oven, as they will be very hot. Check that the heating element is in the horizontal position.

Combining Microwaves and the Grill

You can also combine microwave cooking with the grill, to cook quickly and brown at the same time.

- ✎ ALWAYS use microwave-safe and oven-proof cookware. Glass or ceramic dishes are ideal as they allow the microwaves to penetrate the food evenly.
- ✎ ALWAYS use oven gloves when touching the recipients in the oven, as they will be very hot.

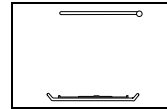

1. Make sure that the heating element is in the horizontal position; refer to page 12 for further details.

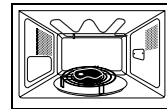

2. Open the oven door. Place the food on the rack and the rack on the turntable. Close the door.

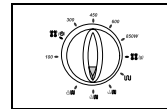

3. Turn the **Cooking Power Control knob** to the appropriate power Level (⌋, ⌋, ⌋).

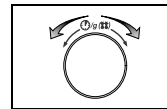

4. Set the time by turning **TIME/WEIGHT** (⌚) dial.
Result: The oven light comes on and the turntable starts rotating.
 - 1) Cooking starts and when it has finished the oven beeps four times.
 - 2) The end reminder signal will beep 3 times (once every minute).
 - 3) The current time is displayed again..

The maximum microwave power for the combined microwave and grill mode is 600W.

Cookware Guide

To cook food in the microwave oven, the microwaves must be able to penetrate the food, without being reflected or absorbed by the dish used.

Care must therefore be taken when choosing the cookware. If the cookware is marked microwave-safe, you do not need to worry.

The following table lists various types of cookware and indicates whether and how they should be used in a microwave oven.

Cookware	Microwave-Safe	Comments
Aluminium foil	✓ X	Can be used in small quantities to protect areas against overcooking. Arcing can occur if the foil is too close to the oven wall or if too much foil is used.
Browning plate	✓	Do not preheat for more than eight minutes.
China and earthenware	✓	Porcelain, pottery, glazed earthenware and bone china are usually suitable, unless decorated with a metal trim.
Disposable polyester cardboard dishes	✓	Some frozen foods are packaged in these dishes.
Fast-food packaging		
• Polystyrene cups containers	✓	Can be used to warm food. Overheating may cause the polystyrene to melt.
• Paper bags or newspaper	X	May catch fire.
• Recycled paper or metal trims	X	May cause arcing.
Glassware		
• Oven-to-table ware	✓	Can be used, unless decorated with a metal trim.
• Fine glassware	✓	Can be used to warm foods or liquids. Delicate glass may break or crack if heated suddenly.
• Glass jars	✓	Must remove the lid. Suitable for warming only.

Metal		
• Dishes	X	May cause arcing or fire.
• Freezer bag twist ties	X	
Paper		
• Plates, cups, napkins and Kitchen paper	✓	For short cooking times and warming. Also to absorb excess moisture.
• Recycled paper	X	May cause arcing.
Plastic		
• Containers	✓	Particularly if heat-resistant thermoplastic. Some other plastics may warp or discolour at high temperatures. Do not use Melamine plastic.
• Cling film	✓	Can be used to retain moisture. Should not touch the food. Take care when removing the film as hot steam will escape.
• Freezer bags	✓ X	Only if boilable or oven-proof. Should not be airtight. Prick with a fork, if necessary.
Wax or grease-proof paper	✓	Can be used to retain moisture and prevent spattering.

Cooking Guide

MICROWAVES

Microwave energy actually penetrates food, attracted and absorbed by its water, fat and sugar content. The microwaves cause the molecules in the food to move rapidly. The rapid movement of these molecules creates friction and the resulting heat cooks the food.

COOKING

Cookware for microwave cooking:

Cookware must allow microwave energy to pass through it for maximum efficiency.

Microwaves are reflected by metal, such as stainless steel, aluminium and copper, but they can penetrate through ceramic, glass, porcelain and plastic as well as paper and wood. So food must never be cooked in metal containers.

Foods suitable for microwave cooking:

Many kinds of food are suitable for microwave cooking, including fresh or frozen vegetables, fruit, pasta, rice, grains, beans, fish, and meat. Sauces, custard, soups, steamed puddings, preserves, and chutneys can also be cooked in a microwave oven. Generally speaking, microwave cooking is ideal for any food that would normally be prepared on a hob. Melting butter or chocolate, for example (see the chapter with tips, techniques and hints).

Covering during cooking

It is very important to cover the food during cooking because evaporated water rises as steam and contributes to the cooking process. Food can be covered in different ways: e.g. with a ceramic plate, plastic cover or microwave suitable cling film.

Standing times

It is important to allow standing time when you have finished cooking the food in order to allow the temperature within the food to even out.

Cooking Guide for frozen vegetables

Use a suitable glass pyrex bowl with lid. Cook covered for the minimum time - see table. Continue cooking to get the result you prefer.

Stir twice during cooking and once after cooking. Add salt, herbs or butter after cooking. Cover during standing time.

Food	Portion	Power	Time (min.)	Standing Time (min.)	Instructions
Spinach	150 g	600W	4½-5½	2-3	Add 15 ml (1 tablespoon) cold water.
Broccoli	300 g	600W	9-10	2-3	Add 30 ml (2 tbsp.) cold water.
Peas	300 g	600W	7½-8½	2-3	Add 15 ml (1 tbsp.) cold water.
Green Beans	300 g	600W	8-9	2-3	Add 30 ml (2 tbsp.) cold water.

Food	Portion	Power	Time (min.)	Standing Time (min.)	Instructions
Mixed Vegetables (carrots/peas/corn)	300 g	600W	7½-8½	2-3	Add 15 ml (1 tbsp.) cold water.
Mixed Vegetables (Chinese style)	300 g	600W	8-9	2-3	Add 15 ml (1 tbsp.) cold water.

Cooking Guide for rice and pasta

Rice : Use a large glass pyrex bowl with lid - rice doubles in volume during cooking. Cook covered. After the cooking time is over, stir before standing time and salt or add herbs and butter.

Remark: the rice may not have absorbed all water after the cooking time is finished.

Pasta : Use a large glass pyrex bowl. Add boiling water, a pinch of salt and stir well. Cook uncovered. Stir occasionally during and after cooking. Cover during standing time and drain thoroughly afterwards..

Food	Portion	Power	Time (min.)	Standing Time (min.)	Instructions
White Rice (parboiled)	250g	850W	16-17	5	Add 500 ml cold water.
Brown Rice (parboiled)	250g	850W	21-22	5	Add 500 ml cold water.
Mixed Rice (rice + wild rice)	250g	850W	17-18	5	Add 500 ml cold water.
Mixed Corn (rice + grain)	250g	850W	18-19	5	Add 400 ml cold water.
Pasta	250g	850W	11-12	5	Add 1000 ml hot water.

Cooking Guide (continued)

Cooking Guide for fresh vegetables

Use a suitable glass pyrex bowl with lid. Add 30-45 ml cold water (2-3 tbsp.) for every 250 g unless another water quantity is recommended - see table. Cook covered for the minimum time - see table. Continue cooking to get the result you prefer. Stir once during and once after cooking. Add salt, herbs or butter after cooking. Cover during a standing time of 3 minutes.

Hint: Cut the fresh vegetables into even sized pieces. The smaller they are cut, the quicker they will cook.

All fresh vegetables should be cooked using full microwave power(850W).

Food	Portion	Time (min.)	Standing Time (min.)	Instructions
Broccoli	250g 500g	4-4½ 8-8½	3	Prepare even sized florets. Arrange the stems to the centre.
Brussels Sprouts	250g	5½-6½	3	Add 60-75 ml (5-6 tbsp.) water.
Carrots	250g	4½-5	3	Cut carrots into even sized slices.
Cauliflower	250g 500g	5-5½ 8½-9	3	Prepare even sized florets. Cut big florets into halves. Arrange stems to the centre.
Courgettes	250g	3½-4	3	Cut courgettes into slices. Add 30 ml (2 tbsp.) water or a knob of butter. Cook until just tender.
Egg Plants	250g	3½-4	3	Cut egg plants into small slices and sprinkle with 1 tablespoon lemon juice.
Leeks	250g	4½-5	3	Cut leeks into thick slices.
Mushrooms	125g 250g	1½-2 3-3½	3	Prepare small whole or sliced mushrooms. Do not add any water. Sprinkle with lemon juice. Spice with salt and pepper. Drain before serving.
Onions	250g	5½-6	3	Cut onions into slices or halves. Add only 15 ml (1 tbsp.) water.
Pepper	250g	4½-5	3	Cut pepper into small slices.
Potatoes	250g 500g	4-5 7½-8½	3	Weigh the peeled potatoes and cut them into similar sized halves or quarters.
Turnip Cabbage	250g	5-5½	3	Cut turnip cabbage into small cubes.

REHEATING

Your microwave oven will reheat food in a fraction of the time that conventional ovens hobs normally take.

Use the power levels and reheating times in the following chart as a guide. The times in the chart consider liquids with a room temperature of about +18 to +20°C or a chilled food with a temperature of about +5 to +7°C.

Arranging and covering

Avoid reheating large items such as joint of meat - they tend to overcook and dry out before the centre is piping hot. Reheating small pieces will be more successful.

Power levels and stirring

- Some foods can be reheated using 850 W power while others should be reheated using 600 W, 450 W or even 300 W. Check the tables for guidance. In general, it is better to reheat food using a lower power level, if the food is delicate, in large quantities, or if it is likely to heat up very quickly (mince pies, for example).

Stir well or turn food over during reheating for best results. When possible, stir again before serving.

Take particular care when heating liquids and baby foods. To prevent eruptive boiling of liquids and possible scalding, stir before, during and after heating. Keep them in the microwave oven during standing time. We recommend putting a plastic spoon or glass stick into the liquids. Avoid overheating (and therefore spoiling) the food.

It is preferable to underestimate cooking time and add extra heating time, if necessary.

Heating and standing times

When reheating food for the first time, it is helpful to make a note of the time taken - for future reference.

Always make sure that the reheated food is piping hot throughout.

Allow food to stand for a short time after reheating - to let the temperature even out. The recommended standing time after reheating is 2-4 minutes, unless another time is recommended in the chart.

- Take particular care when heating liquids and baby food. See also the chapter with the safety precautions.

REHEATING LIQUIDS

Always allow a standing time of at least 20 seconds after the oven has been switched off to allow the temperature to even out. Stir during heating, if necessary, and ALWAYS stir after heating. To prevent eruptive boiling and possible scalding, you should put a spoon or glass stick into the beverages and stir before, during and after heating.

Cooking Guide (continued)

REHEATING BABY FOOD

BABY FOOD:

Empty into a deep ceramic plate. Cover with plastic lid. Stir well after reheating! Let stand for 2-3 minutes before serving. Stir again and check the temperature. Recommended serving temperature: between 30-40°C.

BABY MILK:

Pour milk into a sterilised glass bottle. Reheat uncovered. Never heat a baby's bottle with teat on, as the bottle may explode if overheated.

Shake well before standing time and again before serving! Always carefully check the temperature of baby milk or food before giving it to the baby.

Recommended serving temperature: ca. 37°C.

REMARK:

Baby food particularly needs to be checked carefully before serving to prevent burns. Use the power levels and times in the next table as a guide lines for reheating.

Reheating Baby Food and Milk

Use the power levels and times in this table as guide lines for reheating.

Food	Portion	Power	Time (min.)	Standing Time (min.)	Instructions
Baby food (vegetables + meat)	190g	600W	30sec	2-3	Empty into ceramic deep plate. Cook covered. Stir after cooking time. Stand for 2-3 minutes. Before serving, stir well and check the temperature carefully.
Baby porridge (grain + milk + fruit)	190g	600W	20sec	2-3	Empty into ceramic deep plate. Cook covered. Stir after cooking time. Stand for 2-3 minutes. Before serving, stir well and check the temperature carefully.
Baby milk	100ml 200ml	300W	30-40 sec 50 sec to 1min	2-3	Stir or shake well and pour into a sterilised glass bottle. Place into the centre of turntable. Cook uncovered. Shake well and stand for at least 3 minutes. Before serving, shake well and check the temperature carefully.

Reheating Liquids and Food

Use the power levels and times in this table as guide lines for reheating.

Food	Portion	Power	Time (min.)	Standing Time (min.)	Instructions
Drinks (coffee, milk, tea water with room temperature)	150ml (1 cup) 250ml (1 mug)	850W	1-1 ½ 1½ -2	1-2	Pour in to a ceramic cup and reheat uncovered. Place cup (150ml) or mug (250ml) in the centre of turntable. Stir carefully before and after standing time.
Soup (chilled)	250g	850W	2½-3	2-3	Pour into a deep ceramic plate or deep ceramic bowl. Cover with plastic lid. Stir well after reheating. Stir again before serving.
Stew (chilled)	350g	600W	5½-6½	2-3	Put stew in a deep ceramic plate. Cover with plastic lid. Stir occasionally during reheating and again before standing and serving.
Pasta with sauce (chilled)	350g	600W	4½-5½	3	Put pasta (e.g. spaghetti or egg noodles) on a flat ceramic plate. Cover with microwave cling film. Stir before serving.
Filled pasta with sauce (chilled)	350g	600W	5-6	3	Put filled pasta (e.g. ravioli, tortellini) in a deep ceramic plate. Cover with plastic lid. Stir occasionally during reheating and again before standing and serving.
Plated Meal (chilled)	350g	600W	5½-6½	3	Plate a ready-to heat meal of 2-3 chilled on a ceramic dish. Cover with microwave cling-film.

Cooking Guide (continued)

MANUAL DEFROSTING

Microwaves are an excellent way of defrosting frozen food. Microwaves gently defrost frozen food in a short period of time. This can be of great advantage, if unexpected guests suddenly show up.

Frozen poultry must be thoroughly thawed before cooking. Remove any metal ties and take it out of any wrapping to allow thawed liquid to drain away.

Put the frozen food on a dish without cover. Turn over halfway, drain off any liquid and remove any giblets as soon as possible.

Check the food occasionally to make sure that it does not feel warm.

If smaller and thinner parts of the frozen food start to warm up, they can be shielded by wrapping very small strips of aluminium foil around them during defrosting.

Should poultry start to warm up on the outer surface, stop thawing and allow it to stand for 20 minutes before continuing.

Leave the fish, meat and poultry to stand in order to complete defrosting. The standing time for complete defrosting will vary depending on the quantity defrosted. Please refer to the table below.

Hint: Flat food defrosts better than thick and smaller quantities need less time than bigger ones. Remember this hint while freezing and defrosting food.

For defrosting of frozen food with a temperature of about -18 to -20 °C, use the following table as a guide.

All frozen food should be defrosted using the defrosting power level (180 W, ).

Food	Portion	Time (min.)	Standing Time (min.)	Instructions
Meat	Minced beef	250g 500g	6-7 13-14	5-25 Place the meat on a flat ceramic plate. Shield thinner edges with aluminium foil. Turn over after half of defrosting time!
	Pork steaks	250g	7½-8½	
Poultry	Chicken pieces	500g (2pcs)	14½-15½ 28-30	15-40 First, put chicken pieces skin-side down, whole chicken breast-side-down on a flat ceramic plate. Shield the thinner parts like wings and ends with aluminium foil. Turn over after half of defrosting time!
	Whole chicken	900g		
Fish	Fish fillets/ Whole fish	200g (2pcs)	6-7	5-15 Put frozen fish in the middle of a flat ceramic plate. Arrange the thinner parts under the thicker parts. Shield narrow ends of fillets and tail whole fish with aluminium foil. Turn over after half of defrosting time!
		400g (4pcs)	12-13	
Fruits	Berries	250g	6-7	5-10 Distribute fruits on a flat, round glass dish (with a large diameter).
Bread	Bread rolls	2pcs	½-1	5-20 Arrange rolls in a circle or bread horizontally on kitchen paper in the middle of turntable. Turn over after half of defrosting time!
	(each ca. 50 g)	4pcs	2-2½	
	Toast/ Sandwich	250 g	4½-5	
	German bread (wheat + rye flour)	500 g	8-10	

Cooking Guide (continued)

GRILL

The grill-heating element is located underneath the ceiling of the cavity. It operates while the door is closed and the turntable is rotating. The turntable's rotation makes the food brown more evenly. Preheating the grill for 4 minutes will make the food brown more quickly.

Cookware for grilling:

Should be flameproof and may include metal. Do not use any type of plastic cookware, as it can melt.

Food suitable for grilling:

Chops, sausages, steaks, hamburgers, bacon and gammon rashers, thin fish portions, sandwiches and all kinds of toast with toppings.

IMPORTANT REMARK:

Whenever the grill only mode is used, make sure that the grill-heating element is under the ceiling in the horizontal position and not on the back-wall in the vertical position. Please remember that food must be placed on the high rack, unless another instruction is recommended.

MICROWAVE + GRILL

This cooking mode combines the radiant heat that is coming from the grill with the speed of microwave cooking. It operates only while the door is closed and the turntable is rotating. Due to the rotation of the turntable, the food browns evenly. Three combination modes are available with this model: 600 W + Grill, 450 W + Grill and 300 W + Grill.

Cookware for cooking with microwave + grill

Please use cookware that microwaves can pass through. Cookware should be flame-proof. Do not use metal cookware with combination mode. Do not use any type of plastic cookware, as it can melt.

Food suitable for microwave + grill cooking:

Food suitable for combination mode cooking include all kinds of cooked food which needs reheating and browning (e.g. baked pasta), as well as foods which require a short cooking time to brown the top of the food.

Also, this mode can be used for thick food portions that benefit from a browned and crispy top (e.g. chicken pieces, turning them over half way through cooking). Please refer to the grill table for further details.

IMPORTANT REMARK:

Whenever the combination mode (microwave + grill) is used, make sure that the grill heating element is under the ceiling in the horizontal position and not on the back-wall in the vertical position. The food should be placed on the high rack, unless another instruction is recommended.

Otherwise it has to be placed directly on the turntable.

Please refer to the instructions in the following chart.

The food must be turned over, if it is to be browned on both sides.

Grill Guide for frozen food

Use the power levels and times in this table as guide lines for grilling

Fresh Food	Portion	Power	1. Side Time (min)	2. Side Time (min.)	Instructions
Bread Rolls (each ca. 50 g)	2 pcs 4 pcs	MW+ Grill	300W+ Grill 1-1½ 2-2½	Grill only 1-2 1-2	Arrange rolls in a circle on rack. Grill the second of the rolls up to the crisp you prefer. Stand for 2-5 minutes.
Baguettes + topping (tomatoes, cheese, ham, mushrooms)	250-300 g (2pcs)	450 W + Grill	7-8	--	Put frozen baguette in the centre of the rack. Put 2 and 3 frozen baguettes side by side on the rack. After grilling stand for 2-3 minutes.
Gratin (vegetables or potatoes)	400 g	450 W + Grill	13-14	--	Put frozen gratin into a small, round glass pyrex dish. Put the dish on the rack. After cooking stand for 2-3 minutes.
Pasta (Cannelloni, Macaroni, Lasagne)	400 g	600 W + Grill	14-15	--	Put frozen pasta into a small flat rectangular glass pyrex dish. Put the dish directly on the turntable. After cooking stand for 2-3 minutes.
Chicken Nuggets	250 g	450 W + Grill	5-5½	3-3½	Put chicken nuggets on the rack.
Oven Chips	250 g	450 W + Grill	9-11	4-5	Put oven chips evenly on baking paper on the rack.

Cooking Guide (continued)

Grill Guide for fresh food

Preheat the grill with the grill-function for 4 minutes.

Use the power levels and times in this table as guide lines for grilling.

Fresh Food	Portion	Power	1. Side Time (min)	2. Side Time (min.)	Instructions
Toast Slices	4 pcs (each 25g)	Grill only	3½-4½	3-4	Put the toast slices side by side on the rack.
Bread Rolls (already baked)	2-4 pieces	Grill only	2-3	1-2	Put bread rolls first with the bottom side up in a circle directly on the turntable.
Grilled Tomatoes	200 g (2pcs) 400 g (4pcs)	300 W + Grill	3½-4½ 6-7	--	Cut tomatoes into halves. Put some cheese on top. Arrange in a circle in a flat glass pyrex dish. Place it on the rack.
Toast Hawaii (pineapple, ham, cheese slices)	2 pcs (300 g)	450 W + Grill	3½-4	--	Toast the bread slices first. Put the toast with topping on the rack. Put 2 toasts opposite directly on the rack. Stand for 2-3 minutes.
Baked Potatoes	250 g 500 g	600 W + Grill	4½-5½ 8-9	--	Cut potatoes into halves. Put them in a circle on the rack with the cut side to the grill.
Chicken Pieces	450 - 500 g (2 pcs)	300 W + Grill	8-9	9-10	Prepare chicken pieces with oil and spices. Put them in a circle with the bones to the middle. Put one chicken piece not into the centre of the rack. Stand for 2-3 minutes.

Fresh Food	Portion	Power	1. Side Time (min)	2. Side Time (min.)	Instructions
Lamb Chops (medium)	400 g (4pcs)	Grill only	11-13	8-9	Brush the lamb chops with oil and spices. Lay them in a circle on the rack. After grilling stand for 2-3 minutes.
Pork Steaks	250 g (2pcs)	MW + Grill	(300W + Grill) 7-8	(Grill only) 6-7	Brush the pork steaks with oil and spices. Lay them in a circle on the rack. After grilling stand for 2-3 minutes.
Baked Apples	1 apple (ca. 200g) 2 apples (ca. 400g)	300 W + Grill	4-4½ 6-7	--	Core the apples and fill them with raisins and jam. Put some almond slices on top. Put apples on a flat glass pyrex dish. Place the dish directly on the turntable.

Cooking Guide (continued)

SPECIAL HINTS

MELTING BUTTER

Put 50 g butter into a small deep glass dish. Cover with plastic lid. Heat for 30-40 seconds using 850 W, until butter is melted.

MELTING CHOCOLATE

Put 100 g chocolate into a small deep glass dish. Heat for 3-5 minutes, using 450W until chocolate is melted. Stir once or twice during melting. Use oven gloves while taking out!

MELTING CRYSTALLIZED HONEY

Put 20 g crystallized honey into a small deep glass dish. Heat for 20-30 seconds using 300 W, until honey is melted.

MELTING GELATINE

Lay dry gelatine sheets (10 g) for 5 minutes into cold water. Put drained gelatine into a small glass pyrex bowl. Heat for 1 minute using 300 W. Stir after melting.

COOKING GLAZE/ICING (FOR CAKE AND GATEAUX)

Mix instant glaze (approximately 14 g) with 40 g sugar and 250 ml cold water. Cook uncovered in a glass pyrex bowl for 3 ½ to 4 ½ minutes using 850 W, until glaze/icing is transparent. Stir twice during cooking.

COOKING JAM

Put 600 g fruits (for example mixed berries) in a suitable sized glass pyrex bowl with lid. Add 300 g preserving sugar and stir well. Cook covered for 10-12 minutes using 850 W. Stir several times during cooking. Empty directly into small jam glasses with twist-off lids. Stand on lid for 5 minutes.

COOKING PUDDING

Mix pudding powder with sugar and milk (500 ml) by following the manufacturers instructions and stir well. Use a suitable sized glass pyrex bowl with lid. Cook covered for 6 ½ to 7 ½ minutes using 850 W. Stir several times well during cooking.

BROWNING ALMOND SLICES

Spread 30 g sliced almonds evenly on a medium sized ceramic plate. Stir several times during browning for 3 ½ to 4 ½ minutes using 600 W. Let it stand for 2-3 minutes in the oven. Use oven gloves while taking out!

Cleaning Your Microwave Oven

The following parts of your microwave oven should be cleaned regularly to pre-vent grease and food particles from building up:

- *Inside and outside surfaces*
- *Door and door seals*
- *Turntable and Roller rings*



ALWAYS ensure that the door seals are clean and the door closes properly.

1. Clean the outside surfaces with a soft cloth and warm, soapy water. Rinse and dry.
 2. Remove any splashes or stains on the inside surfaces or on the roller ring with a soapy cloth. Rinse and dry.
 3. To loosen hardened food particles and remove smells, place a cup of diluted lemon juice on the turntable and heat for ten minutes at maximum power.
 4. Wash the dishwasher-safe plate whenever necessary.
- ✘ **DO NOT** spill water in the vents. NEVER use any abrasive products or chemical solvents. Take particular care when cleaning the door seals to ensure that no particles:
 - Accumulate
 - Prevent the door from closing correctly
 - ✘ **Clean the** microwave oven cavity right after each use with a mild detergent solution, but let the microwave oven cool down before cleaning in order to avoid injury .

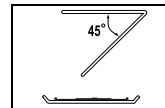

For your convenience, we recommend that you turn the heater downward while cleaning the upper inside part of the cavity.

Storing and Repairing Your Microwave Oven

GB *A few simple precautions should be taken when storing or having your microwave oven serviced.*

The oven must not be used if the door or door seals are damaged:

- *Broken hinge*
- *Deteriorated seals*
- *Distorted or bent oven casing*

Only a qualified microwave service technician should can repair this oven.

- ✎ **NEVER** remove the outer casing from the oven. If the oven is faulty and needs servicing or you are in doubt about its condition:
 - Unplug it from the wall socket
 - Contact the nearest after-sales service centre
- ☒ If you wish to store your oven away temporarily, choose a dry, dust-free place.
Reason: Dust and damp may adversely affect the working parts in the oven.
- ☒ This microwave oven is not intended for commercial use.

Installation & Wiring Instructions

IMPORTANT NOTE :

The mains lead on this equipment is supplied with a moulded plug incorporating a fuse.

The value of the fuse is indicated on the pin face of the plug and, if it requires replacing, a fuse approved to BS1363 of the same rating must be used. Never use the plug with the fuse cover omitted if the cover is detachable. If a replacement fuse cover is required, it must be of the same colour as the pin face of the plug.

Replacement covers are available from your Dealer. If the fitted plug is not suitable for the power points in your house or the cable is not long enough to reach a power point, you should obtain a suitable safety approved extension lead or consult your Dealer for assistance. However, if there is no alternative to cutting off the plug, remove the fuse and then safely dispose of the plug. Do not connect the plug to a mains socket, as there is a risk of shock hazard from the bared flexible cord.

Wiring Instructions

WARNING THIS APPLIANCE MUST BE EARTHED.

This appliance must be earthed. In the event of an electrical short circuit, earthing reduces the risk of electric shock providing an escape wire for the electric current. The appliance is equipped with a mains lead which includes an earth wire for connecting to the earth terminal of your mains plug. The plug must be plugged into a socket that is properly installed and earthed.

☞ The wires in this mains lead are coloured in accordance with the following code:

- Green-and yellow : Earth
- Blue : Neutral
- Brown : Live

- ◆ As the colours of the wires in the mains lead of this appliance may not correspond with the coloured markings identifying the terminals in your plug, proceed as follows.
- ◆ Connect the green-and yellow wire to the terminal in the plug marked with the letter E or the earth symbol (\perp) or coloured green or green-and-yellow.
- ◆ Connect the blue wire to the terminal marked with the letter N or coloured black.

☞ Consult a qualified electrician or service technician if in doubt about any of these instructions.

The manufacturer of this oven will not accept any liability for damage to persons or material for non observance of these requirements.

There are no user+serviceable parts inside the oven and if the mains lead of this appliance is damaged, it must only be replaced by qualified service personnel approved by the manufacturer because special tools are required.

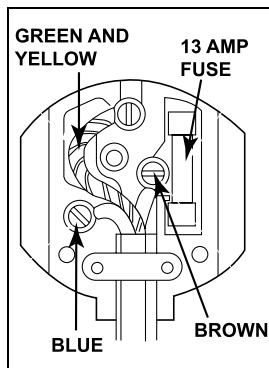

WARNING

Ensure that the plug and power cord are not damaged before use.

If you have any reason to remove the moulded plug from this appliance, immediately remove the fuse and dispose of the plug.

Do not connect the plug to a mains socket under any circumstances as there is a danger of electric shock.

CIRCUITS

Your microwave oven should be operated on a separate circuit from other appliances. Failure to do this may cause the circuit breaker to trip, the fuse to blow, or the food to cook more slowly.

Cooking Instructions On Food Packaging

Microwave Symbols

On the front of your oven there is a microwave oven symbol, as shown below. This symbol has been introduced for your benefit when cooking or reheating packaged food.



Packaged food is also, increasingly, using a microwave symbol similar to the one below.

When you see this



Symbol on food packaging, the cooking instructions are based on either the IEC Power Output Rating, or the Reheating Categories A, B, C, D or E.

Cooking Instructions

The IEC Power Output rating is an internationally standardised rating, so all microwave manufacturers now use the same method of measuring power output. If food packaging gives cooking instructions based on IEC Power ratings, set cooking times according to the IEC Power of your oven.

For example :

If the cooking instructions are based on a 650W oven, then you will need to reduce some cooking time for the CE2727N / CE2727NT (850W)

Ready meals are now very convenient and popular. These are meals which are already prepared and cooked by the food manufacturer, and then frozen, chilled or vacuum sealed for long life.

Increasingly, heating times for such ready meals are being based on the Heating Categories A, B, C, D and E.

On this instance, simply match the heating category of your oven to the instructions on the food package, and set your timer accordingly.

For example :

If the heating instructions are 3 minutes on HIGH for a D category oven, then you will need to set your timer for less than 3 minutes on HIGH for the CE2727N / CE2727NT (E category).

☞ Always remember that cooking instructions are intended only as a guide. If you have followed the instructions and the food is still not piping hot throughout, simply return it to the oven and cook it until it is.

Technical Specifications

SAMSUNG strives to improve its products at all times. Both the design specifications and these user instructions are thus subject to change without notice.

Model	CE2727N / CE2727NT
Power source	230V ~ 50 Hz
Power consumption	
Microwave	1300 W
Grill	1100 W
Combined mode	2400 W
Output power	100 W / 850 W (IEC-705) <ul style="list-style-type: none">• 240 V : 850 W• 230 V : 800 W
Operating frequency	2450 MHz
Magnetron	OM75P(31)
Cooling method	Cooling fan motor
Dimensions (W x H x D)	
Outside	489 x 275 x 415 mm
Oven cavity	306 x 211 x 320 mm
Volume	0.7 cubic feet
Weight	
Net	15 kg approx

