

RICOH

CX2

Camera User Guide

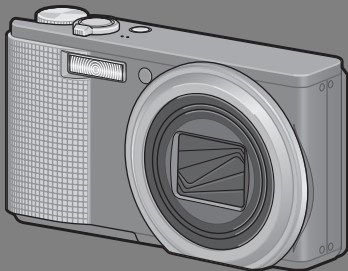

The serial number of this product is given on the bottom face of the camera.

Basic Operations

If you are using the camera for the first time, read this section.

This section provides a basic overview of how to turn on the camera, take pictures and play back pictures.

Advanced Operations

Read this section when you want to learn more about the different camera functions.

This section provides more detailed information about the functions used to take pictures and play back pictures, as well as information on how to customize the camera settings, print pictures, and use the camera with a computer.

The rechargeable battery needs to be charged before use. The battery is not charged at the time of purchase.

Preface

This manual provides information on how to use the shooting and playback functions of this product, as well as warnings on its use.

To make the best use of this product's functions, read this manual thoroughly before use. Please keep this manual handy for ease of reference.

Ricoh Co., Ltd.

Safety Precautions	For the safe use of your camera, be sure to read the safety precautions thoroughly.
Test Shooting	Please be sure to do some test shooting to make sure it is recording properly before normal use.
Copyright	Reproduction or alteration of copyrighted documents, magazines, music and other materials, other than for personal, home or similarly limited purposes, without the consent of the copyright holder is prohibited.
Exemption from Liability	Ricoh Co., Ltd. assumes no liability for failure to record or play back images caused by malfunction of this product.
Warranty	This product is manufactured to local specifications and the warranty is valid within the country of purchase. Should the product fail or malfunction while you are abroad, the manufacturer assumes no responsibility for servicing the product locally or bearing the expenditure incurred thereof.
Radio Interference	Operating this product in the vicinity of other electronic equipment may adversely affect the performance of both devices. In particular, operating the camera close to a radio or television may lead to interference. If interference occurs, follow the procedures below. <ul style="list-style-type: none">• Move the camera as far away as possible from the TV, radio or other device.• Reorient the TV or radio antenna.• Plug the devices into separate electrical outlets.

© 2009 RICOH CO., LTD. All rights reserved. This publication may not be reproduced in whole or in part without Ricoh's express written permission. Ricoh reserves the right to change the contents of this document at any time without prior notice.



Every effort has been made to ensure the accuracy of the information in this document. Should you nevertheless notice any errors or omissions, we would be grateful if you would notify us at the address listed on the back cover of this booklet.

Microsoft, Windows, Windows Vista, and Internet Explorer are registered trademarks of Microsoft Corporation in the United States of America and other countries. Macintosh and Mac OS are registered trademarks of Apple Inc. in the United States of America and other countries. Adobe, the Adobe logo, and Adobe Reader are trademarks of Adobe Systems Incorporated in the United States and other countries. All other trade names mentioned in this document are the property of their respective owners.

Safety Precautions

Warning Symbols

Various symbols are used throughout this instruction manual and on the product to prevent physical harm to you or other people and damage to property. The symbols and their meanings are explained below.

 Danger	This symbol indicates matters that may lead to imminent risk of death or serious injury if ignored or incorrectly handled.
 Warning	This symbol indicates matters that may lead to death or serious injury if ignored or incorrectly handled.
 Caution	This symbol indicates matters that may lead to injury or physical damage if ignored or incorrectly handled.

Sample Warnings



The  symbol alerts you to actions that must be performed.



The  symbol alerts you to prohibited actions.

The  symbol may be combined with other symbols to indicate that a specific action is prohibited.

- Examples
-  Do not touch
-  Do not disassemble

Observe the following precautions to ensure safe use of this equipment.

Danger



- Do not attempt to disassemble, repair or alter the equipment yourself. The high-voltage circuitry in the equipment poses significant electrical hazard.



- Do not attempt to disassemble, alter or directly solder the battery.



- Do not put the battery in a fire, attempt to heat it, use it in a high temperature environment such as next to a fire or inside a car, or abandon it. Do not put it into water or the sea or allow it to get wet.



- Do not attempt to pierce, hit, compress, drop, or subject the battery to any other severe impact or force.



- Do not use a battery that is significantly damaged or deformed.

Warning



- Turn off the power immediately in the event of abnormalities such as smoke or unusual odors being emitted. Remove the battery as soon as possible, being careful to avoid electric shocks or burns. If you are drawing power from a household electrical outlet, be sure to unplug the power cord from the outlet to avoid fire or electrical hazards. Discontinue use of the equipment immediately if it is malfunctioning. Contact the nearest service center at your earliest convenience.



- Turn off the power immediately if any metallic object, water, liquid or other foreign object gets into the camera. Remove the battery and memory card as soon as possible, being careful to avoid electric shocks or burns. If you are drawing power from a household electrical outlet, be sure to unplug the power cord from the outlet to avoid fire or electrical hazards. Discontinue use of the equipment immediately if it is malfunctioning. Contact the nearest service center at your earliest convenience.



- Avoid any contact with the liquid crystal inside the picture display, should the monitor be damaged. Follow the appropriate emergency measures below.
- SKIN: If any of the liquid crystal gets on your skin, wipe it off and rinse the affected area thoroughly with water, then wash well with soap.
- EYES: If it gets in your eyes, wash your eyes with clean water for at least 15 minutes and seek medical advice immediately.
- INGESTION: If any of the liquid crystal is ingested, rinse the mouth out thoroughly with water. Have the person drink a large amount of water and induce vomiting. Seek medical assistance immediately.



- Follow these precautions to prevent the battery from leaking, overheating, igniting or exploding.
- Do not use a battery other than those specifically recommended for the equipment.
- Do not carry or store together with metal objects such as ballpoint pens, necklaces, coins, hairpins, etc.
- Do not put the battery into a microwave or high pressure container.
- If leakage of battery fluid or a strange odor, color change, etc. is noticed during use or during charging, remove the battery from the camera or battery charger immediately and keep it away from fire.



- Please observe the following in order to prevent fire, electrical shock or cracking of the battery while charging.
- Use only the indicated power supply voltage. Also avoid the use of multi-socket adapters and extension cords.
- Do not damage, bundle or alter power cords. Also, do not place heavy objects on, stretch or bend power cords.
- Do not connect or disconnect the power plug with wet hands. Always grip the plug section when disconnecting a power cord.
- Do not cover equipment while charging.



- Keep the battery and SD memory card used in this equipment out of the reach of children to prevent accidental ingestion. Consumption is harmful to human beings. If swallowed, seek medical assistance immediately.



- Keep the equipment out of the reach of children.



- Do not touch the internal components of the equipment if they become exposed as a result of being dropped or damaged. The high-voltage circuitry in the equipment could lead to an electric shock. Remove the battery as soon as possible, being careful to avoid electric shocks or burns. Take the equipment to your nearest dealer or service center if it is damaged.



- Do not use the equipment in wet areas as this could result in fire or electric shock.



- Do not use the equipment near flammable gases, gasoline, benzene, thinner or similar substances to avoid the risk of explosion, fire or burns.
- Do not use the equipment in locations where usage is restricted or prohibited as this may lead to disasters or accidents.



- Wipe off any dust that accumulates on the electrical plug as this may lead to fire.
- Use only the specified AC adapter in household electrical outlets. Other adapters pose the risk of fire, electric shock or injury.



- To avoid the risk of fire, electric shock or injury, do not use the battery charger or AC adapter with commercially available electronic transformers when traveling abroad.

Observe the following precautions to ensure safe use of this unit.

Caution



- Contact with fluid leaking from a battery can lead to burns. If part of your body comes in contact with a damaged battery, rinse the area with water immediately. (Do not use soap.)
If a battery starts to leak, remove it immediately from the equipment and wipe the battery chamber thoroughly before replacing it with a new battery.



- Plug the power cords securely into the electrical outlets. Loose cords pose a fire hazard.



- Do not allow the camera to get wet. In addition, do not operate it with wet hands. Both pose the risk of electric shock.





- Do not fire the flash at drivers of vehicles, as this may cause the driver to lose control and result in a traffic accident.

Safety Precautions for Accessories

When using optional products, carefully read the instructions provided with the product before using that product.

Using the Manuals

The following two manuals are included with your CX2.

	<p>“Camera User Guide” (This booklet)</p> <p>This guide explains the usage and functions of the camera. It also explains how to install the provided software on your computer.</p>
	<p>“Software User Guide” (PDF file)</p> <p>The “Software User Guide” is available in the following folders on the provided CD-ROM.</p> <p>This guide explains how to download images from the camera to your computer.</p> <p>Each language has its own “Software User Guide” in the respective folder.</p>  <p>To copy the User Guide onto your hard disk, copy the PDF file from the respective folder directly to your hard disk.</p>

“Irodio Photo & Video Studio” image viewing and editing software (for Windows only) is also included with the camera. For how to use Irodio Photo & Video Studio, see the displayed “Help”.

For more information on Irodio Photo & Video Studio, contact the Customer Support Center below.

North America (U.S.)

TEL: (Toll Free) +1-800-458-4029

Europe

UK, Germany, France and Spain:

TEL: (Toll Free) +800-1532-4865

Other Countries:

TEL: +44-1489-564-764

Asia

TEL: +63-2-438-0090

China

TEL: +86-21-5385-3786

Business hours: 9:00 AM to 5:00 PM

Contents

Safety Precautions	1
Using the Manuals	4
Contents	5

Basic Operations

11

If you are using the camera for the first time, read this section.

Packing List	12
Optional Accessories	14
Names of Parts	15
How to Use the Mode Dial	17
Picture Display	18
Getting Ready	22
About the Battery	22
About the SD Memory Card (available in stores).....	23
Charging the Rechargeable Battery	25
Loading the Rechargeable Battery and SD Memory Card.....	26
Turning the Power On/Off	28
Setting the Language	30
Setting the Date and Time	31
Basic Shooting	32
Holding the Camera	32
Shooting with Auto Shooting Mode	34
Shooting with Easy Shooting Mode	37
Using the Zoom Function	39
Shooting Close-Ups (Macro Shooting).....	41
Using the Flash	43
Using the Self-Timer	45
Playing Back Images	46
Viewing Your Images	46
Thumbnail View	48
Enlarging Images	50
Deleting Files	52
Deleting a File	52
Specifying Multiple Files Separately	53
Specifying a Range of Multiple Files	54
Deleting All Files	55
Changing the Display with the DISP. Button	56
About the Electronic Level	58
About the Histogram Display	60

Read this section when you want to learn more about the different camera functions.

1 ADJ. Button Functions 62

Assigning Functions from the Shooting Menu	62
Shifting the AE and AF Targets	64

2 Using the Fn (Function) Button 66

Shifting the AF Target for Macro Shooting	67
Locking the Exposure	68
AF/Cont. AF	69
AF/M-trgt AF	70
AF/MF	71
AF/Snap	72
Switching Between On and Off for Various Functions	73

3 Shooting Mode Types 74

Scene Mode (SCENE)	74
Using Portrait Mode	77
Shooting in Zoom Macro Mode	78
Shooting in Miniaturization Mode	79
Using Skew Correction Mode	81
Changing the Text Density	82
My Settings Mode (MY1/MY2)	83
Dynamic Range Double Shot Mode (DR)	84
Dynamic Range Expansion Effect	85
Dynamic Range Expansion Plus Normal Shooting	86
Continuous Mode (C)	87
Normal Continuous Mode	87
M-Cont Plus (9M)	88
M-Cont Plus (2M)	90
Speed Cont	92
Movie Mode (M)	94
Shooting Movies	94
Setting the Frame Rate	95

4 Shooting Menu 97

About the Shooting Menu	97
Using the Menu	100
Picture Quality Mode/Image Size	101

Focusing Modes	103
Multi-Target AF	104
Manual Focus (MF)	105
Pre-AF	107
Exposure Metering Modes	108
Picture Quality and Color	109
Custom Settings	110
Flash Exposure Compensation	111
Bracket Shooting	112
Auto Bracketing	112
White Balance Bracketing	113
Color Bracketing	114
Focus Bracketing	115
Long Time Exposure	117
Shooting Several Pictures with the Custom Self-Timer	118
Shooting Pictures Automatically at Set Intervals	119
Camera Shake Correction	121
Limiting the Shutter Speed	122
Imprinting the Date on Images	123
Exposure Compensation	124
White Balance	126
Manual Settings	127
ISO Sensitivity	128
Restoring the Shooting Menu Settings to their Defaults	130
5 Playback Functions	131
Playing Back Movies	131
Playing Back MP Files	132
Exporting MP Files	134
6 Playback Menu	138
About the Playback Menu	138
Using the Menu	139
Saving Images You Want to Quickly Display (Flag Function Setting)	140
Setting/Canceling One File at a Time	140
Setting/Canceling Multiple Files at One Time	141
Displaying an Image Set to Flag Function Setting (Flag Function Display)	142
Resizing Images	143
Trimming Images	144

Correcting the Image Brightness and Contrast	147
Correcting Images Automatically	147
Correcting Images Manually	148
Correcting the White Balance	150
Correcting Skewed Images	152
Preventing the Deletion of Files	154
Displaying Slide Shows	157
Copying the Contents of the Internal Memory to an SD Memory Card	158
Using a Printing Service (DPOF)	159
Setting/Canceling DPOF for a File	159
Setting/Canceling DPOF for All Files	160
Setting DPOF for Multiple Files	160
Restoring Deleted Files	162
Viewing on a Television	163

7 Setup Menu 165

About the Setup Menu	165
Using the Menu	166
Formatting the SD Memory Card	168
Formatting the Internal Memory	169
Adjusting the Picture Display Brightness	170
Registering My Settings	171
Fixing the Focal Length of the Zoom	173
Fn (Function) Button Settings	174
ADJ. Button Settings	176
ISO Auto-High Settings	178
AF Auxiliary Light	179
Operation Sound Settings	180
Adjusting/Muting the Operation Sound Volume	181
LCD Image Confirmation Time	182
Auto Power Off	183
LCD Auto Dimmer Mode	184
Auto Resize Zoom	185
Level Confirmation	187
Grid Guide Display Options	188
Shooting Information Display Frame	189
Minimum Shooting Distance Display	190
Automatic Rotation of Playback Images	191
File Name Settings	193
Date and Time Settings	194

Language Settings	195
TV Playback Method	196
8 Direct Printing	197
<hr/>	
About the Direct Print Function	197
Connecting the Camera to a Printer	198
Printing Still Images.....	199
Printing One or All Still Images	199
Printing Several Still Images	202
9 Downloading Images to Your Computer	204
<hr/>	
For Windows	204
System Requirements for Using the Supplied CD-ROM.....	205
CD-ROM Setup.....	206
When [Installing the software] Is Clicked	206
When [Browse User's Manual (Software Version)] Is Clicked	210
When [Browse CD-ROM Content] Is Clicked.....	210
Uninstalling the Software	211
Downloading Images Using DL-10	212
Downloading Images Without Using DL-10	213
Disconnecting the Camera from Your Computer	216
For Macintosh.....	217
Downloading Images to Your Computer	217
Disconnecting the Camera from Your Computer	218
Using the MP File Viewer.....	219
10 Appendices	221
<hr/>	
Troubleshooting.....	221
Error Messages.....	221
Camera Troubleshooting	222
Software and Computer Troubleshooting	228
Specifications	230
Number of Images That Can Be Stored.....	232
Defaults Settings/Functions Whose Defaults Are Restored When the Camera Is Turned Off.....	234
Using Your Camera Abroad	236
Cautions on Use.....	237
Care and Storage	239
Warranty and Servicing	240
Index	242

Basic Operations

If you are using the camera for the first time, read this section.

Packing List.....	12
Names of Parts.....	15
How to Use the Mode Dial.....	17
Picture Display.....	18
Getting Ready.....	22
Basic Shooting.....	32
Playing Back Images.....	46
Deleting Files.....	52
Changing the Display with the DISP. Button.....	56

Packing List

Open the package and make sure all the items are included.

* The actual appearance of items included may differ.

CX2

The serial number of the camera is provided on the bottom face of the camera.

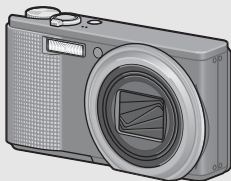

Rechargeable Battery

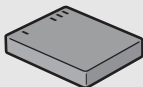

Battery Charger

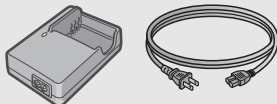

USB Cable (Mini B cable)

Used to connect the camera to a computer or Direct Print-compatible printer.



AV Cable

Used to view your images on a TV



Handstrap



Warranty

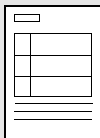

If you are using the camera for the first time, read this section.

Camera User Guide

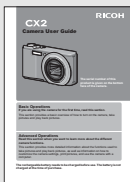

(This booklet)

CD-ROM (P.204)

Contains software and “Software User Guide”. VM-1 software and “Software User Guide” available for Macintosh; see P.219 for installation instructions. Acrobat Reader is required to view the “Software User Guide” in Mac OS 9.



Caution

The CD-ROM supports the following languages. Operations are not guaranteed on operating systems with languages other than those listed below.

Japanese, English, French, German, Spanish, Italian, Chinese (Traditional, Simplified), Korean



Note

Attaching the handstrap to the camera

Thread the small end of the strap through the strap eyelet on the camera and loop the ends as shown.

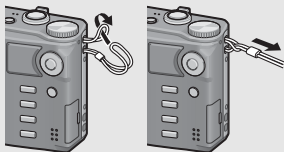

If you are using the camera for the first time, read this section.

Optional Accessories

Soft Case (SC-90)

Used to store your camera.

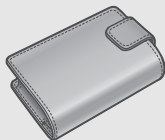

Rechargeable Battery (DB-70)

Rechargeable battery for use with this camera.

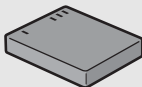

Neck Strap (ST-2)

A double-loop neck strap with embroidered RICOH logo.

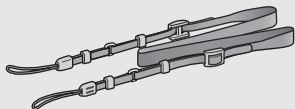

Battery Charger (BJ-7)

Used to charge the rechargeable battery (DB-70).

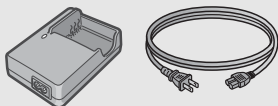

Cable Switch (CA-1)

A switch that connects to the camera's USB terminal to operate the shutter.

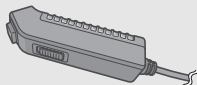

Note

Attaching the neck strap to the camera

Remove the end of the neck strap from the connector and attach it as shown in the figure.

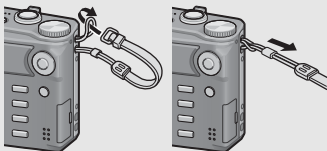

- For the latest information on optional accessories, see the Ricoh website (<http://www.ricohpmmc.com/>).

Names of Parts

Camera

Front View

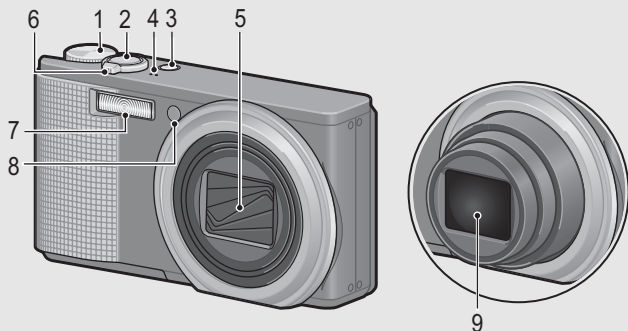

	Item Name	Refer to
1	Mode Dial	P.17, 34, 37, 74, 83, 84, 87, 94
2	Shutter Release Button	P.32
3	POWER Button	P.28
4	Microphone	P.94
5	Lens Cover	-
6	Zoom Lever [A] (Telephoto)/[W] (Wide-angle) Q (Enlarged View)/[T] (Thumbnail View)	P.39, 48, 50
7	Flash	P.43
8	AF Auxiliary Light/Self-Timer Lamp	P.45, 179
9	Lens	-

If you are using the camera for the first time, read this section.

Rear View

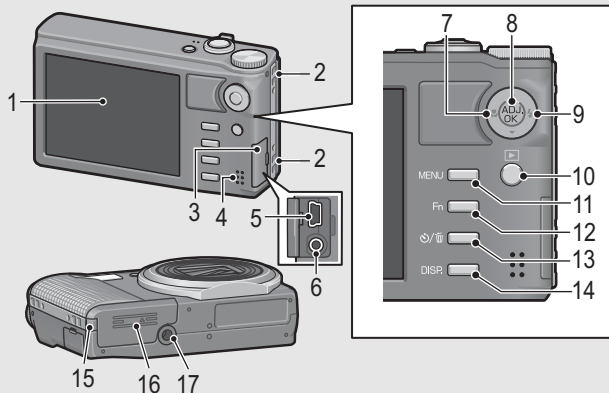

	Item Name	Refer to
1	Picture Display	P.18
2	Strap Eyelet	P.13
3	Terminal Cover	P.163, 198, 212, 213, 217
4	Speaker	P.131
5	USB Terminal	P.198, 212, 213, 217
6	AV Output Terminal	P.163
7	📷 (Macro)	P.41
8	ADJ./OK Button ^(*)	P.62
9	⚡ (Flash)	P.43
10	▶ (Playback) Button	P.46
11	MENU Button	P.76, 100, 139, 166
12	Fn (Function) Button	P.66
13	⌚ (Self-timer)/🗑️ (Delete) Button	P.52, 45
14	DISP. Button	P.56, 58
15	Power (DC input) Cable Cover	-
16	Battery/Card Cover	P.26
17	Tripod Screw Hole	P.231

^(*) Instructions in this manual to “Press the ADJ./OK button ▲▼◀▶” (or toward 📷 or ⚡) indicate that you should press the ADJ./OK button in the up, down, left or right direction. Instructions to “Press the ADJ./OK button” indicate that you should press directly down on the button.



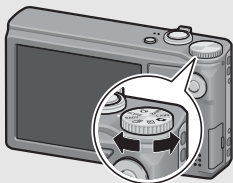

How to Use the Mode Dial

Set the mode dial to the desired mode before shooting still images or movies.

- 1** Turn the mode dial to the symbol of the function you want to use.



Mode Dial Symbols and Descriptions

Symbol	Function	Description	Refer to
	Auto Shooting Mode	Automatically sets the optimal aperture value and shutter speed depending on the subject.	P.34
MY1, MY2	My Settings Mode	You can shoot using the settings registered in [Reg. My Settings].	P.83
	Movie Mode	Allows you to shoot movies.	P.94
SCENE	Scene Mode	Allows you to shoot with settings optimized for the shooting scene.	P.74
EASY	Easy Shooting Mode	This allows you to shoot with easy operations and without having to make any complicated settings. The settings of some shooting functions cannot be changed when using this mode.	P.37
	Continuous Mode	You can shoot with various continuous shooting functions.	P.87
	Dynamic Range Double-shot Mode	Allows you to shoot images that look natural even in the dark areas and bright areas of scenes with high contrast.	P.84

If you are using the camera for the first time, read this section.

Picture Display

Example of Picture Display when Shooting Pictures

If you are using the camera for the first time, read this section.

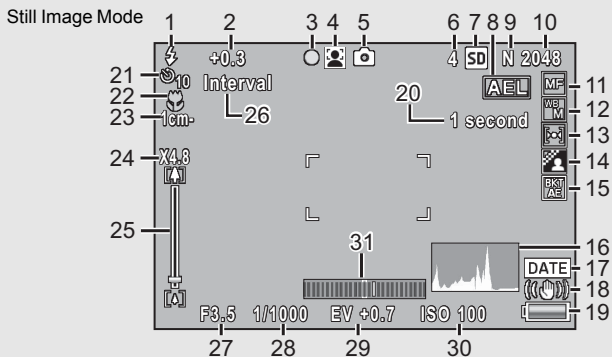

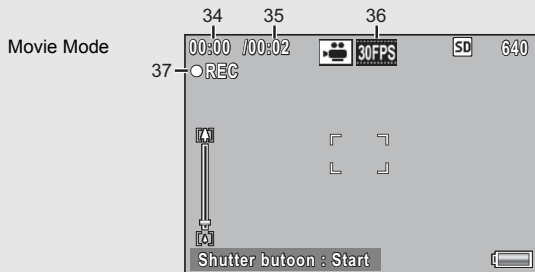

If you are using the camera for the first time, read this section.

	Item Name	Refer to		Item Name	Refer to
1	Flash Mode	P.43	18	Camera Shake Correction	P.121
2	Flash Exposure Compensation	P.111	19	Battery Symbol	P.21
			20	Time Exposure	P.117
3	Muti-Target AF Focus mark	P.104	21	Self-timer	P.45
			22	Macro Shooting	P.41
4	Scene Modes/ Continuous Mode/ Plus Normal Shooting	P.74 P.87 P.86	23	Minimum Shooting Distance	P.190
5	Shooting Mode Types	P.17	24	Digital Zoom Magnification/Auto Resize Zoom	P.40, 185
6	Remaining Number of Still Images	P.232	25	Zoom Bar	P.39
7	Recording Destination	P.23	26	Interval Shooting	P.119
8	AE Lock	P.68	27	Aperture	P.230
9	Picture Quality	P.101	28	Shutter Speed	P.122
10	Image Size	P.101	29	Exposure Compensation	P.124
11	Focus Mode	P.103	30	ISO Setting	P.128
12	White Balance	P.126	31	Level Indicator	P.59
13	Exposure Metering	P.108	32	Camera Shake Warning Symbol	P.33
14	Image Settings	P.109			
15	Bracket Shooting	P.112, 113, 115, 114	33	Overexposure Mark	P.124
			34	Recording Time	P.232
			35	Remaining Recording Time	P.232
16	Histogram	P.60	36	Frame Rate	P.95
17	Date Imprint	P.123	37	Movie Recording Indicator	P.94

**Note**

- The number of remaining shots available may differ from the actual number of shots, depending on the subject.
- Movie recording time and the maximum number of still pictures may vary depending on the capacity of the recording destination (internal memory or SD memory card), shooting conditions, and the type and manufacturer of the SD memory card.
- When the number of remaining shots is 10,000 or more, "9999" is displayed.

If you are using the camera for the first time, read this section.

Example of Picture Display During Playback

Still Image Mode

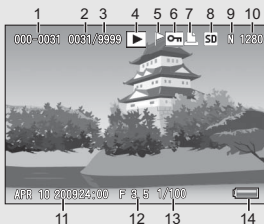

Movie Mode



	Item Name	Refer to		Item Name	Refer to
1	File No.	-	10	Image Size	P.101
2	Number of Playback Files	-	11	Date at Shooting	P.194
3	Total Number of Files	-	12	Aperture	P.230
4	Mode Types	-	13	Shutter Speed	P.122
5	Flag Function Setting	P.140	14	Battery Symbol	P.21
6	Protect	P.154	15	Recording Time or Lapsed Time	-
7	DPOF	P.159	16	Indicator	-
8	Playback Data Source	P.47			
9	Picture Quality	P.101			



Note

- The picture display may display messages to inform you of operational instructions or the camera's status while in use.
- Additional information can be viewed by pressing the DISP. button (P.57).

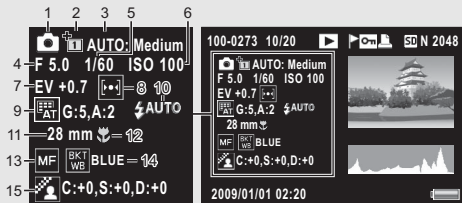

	Item Name	Refer to		Item Name	Refer to
1	Shooting Mode	-	9	White Balance / White Balance Compensation	P.126 P.150
2	Plus Normal Shooting	P.86			
3	Dynamic Range Expansion	P.85	10	Flash Mode	P.43
4	Aperture	P.230	11	Focal Length of the Zoom	P.39
5	Shutter Speed	P.122	12	Macro Shooting	P.41
6	ISO Setting	P.128	13	Focus Mode	P.103
7	Exposure Compensation	P.124	14	Auto Bracket	P.112
8	Exposure Metering	P.108	15	Image Settings	P.109

Battery Level Indication

A battery symbol appears at the lower right of the picture display to indicate the battery level. Recharge the battery before it is depleted.

Battery Symbol	Description
Green	Battery is sufficiently charged.
	Battery partially discharged. Recharging is recommended.
	Battery level is low. Recharge the battery.



Caution

- may be displayed when the camera is powered by an AC adapter. This is normal and does not indicate a malfunction.

Getting Ready

Turn the power on and get ready to shoot.



Note

- Be sure the camera is off before removing the battery.
- For information on how to turn the camera off, see P.28.

About the Battery

This camera uses the Rechargeable Battery DB-70, a dedicated lithium-ion battery supplied with the camera. It is economical because you can recharge it using the battery charger and use it over and over again. The rechargeable battery needs to be charged before use. The battery is not charged at the time of purchase.

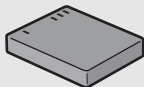

Number of shots you can take

Approximate number of shots you can take on a single charge: Approx. 290

- * When [LCD Auto Dim] (P.184) is set to [On]
- Based on CIPA standard (Temperature: 23 degrees Celsius, picture display on, 30 seconds between shots, changing the zoom setting from telephoto to wide-angle or wide-angle to telephoto for each shot, 50% flash usage, turning the power off after each 10 shots).
- You can take approximately 270 shots when [LCD Auto Dim] is set to [Off].
- Set the camera to synchro-monitor mode to increase the number of shots you can take. (P.56)
- The number of shots is for reference only. If the camera is used for long periods of time for setting and playback, the shooting time (the number of shots) will decrease. If you intend to use the camera for a long period of time, we recommend carrying a spare battery.



Caution

- The battery may become very hot immediately after operation. Turn the camera off and leave it to cool down sufficiently before removing the battery.
- Please remove the battery if you are not going to use the camera for a long period of time.
- When using a lithium-ion battery, use only the specified rechargeable lithium-ion battery (DB-70). Do not use other rechargeable lithium-ion batteries.

About the SD Memory Card (available in stores)

You can store images you have taken either in the camera's internal memory or on an SD memory card (available in stores). The internal memory capacity is approximately 88 MB. To record a lot of still images or movies at high resolutions, use a high-capacity SD memory card.



About Formatting

Before using a new SD memory card, be sure to format it with this camera. If an error message such as [Card Error] is displayed when an SD memory card is loaded in the camera or the card has been used with a computer or other digital camera, you must format the card with this camera prior to use. (P.168)



Where images are recorded

When no SD memory card is loaded, the camera records images to the internal memory; when an SD memory card is loaded, it records images to the SD memory card.

When no SD memory card is loaded

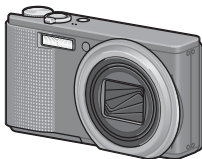

Records to the internal memory

When an SD memory card is loaded

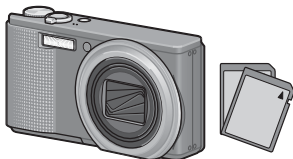

Records to the SD memory card



Caution

- If an SD memory card is loaded, the camera does not record to the internal memory, even if the card is full.
- Take care not to get the contacts of the card dirty.



Write-protecting your images -----

Move the write-protection switch on the SD memory card to LOCK to prevent your still images from being accidentally erased or the card from being formatted. If you unlock the card (by returning the switch to its original position), it is once again possible to erase images and format the card.

It is recommended to move the write-protection switch to LOCK when you have some important data recorded.

Note that you cannot shoot images on a locked card because no data can be recorded to the card. Unlock the card before shooting.

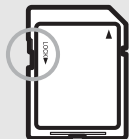

Note -----

- For information on switching between the SD memory card and internal memory during playback, see P.47.
- Movie recording time and the maximum number of still pictures varies depending on the capacity of the SD memory card. (☞ P.232)
- You can copy images recorded in the internal memory to the SD memory card. (☞ P.158)

Charging the Rechargeable Battery

The rechargeable battery needs to be charged before use. The battery is not charged at the time of purchase.

1 Insert the battery into the battery charger, making sure that the \oplus and \ominus markings on the battery match those on the battery charger.

- The battery label should face up.



Caution

Be careful not to reverse the \oplus and \ominus sides.

2 Plug the power cable into an outlet.

- Use the battery charger (BJ-7) to recharge the battery.
- Charging starts, and the charger lamp indicates the progress, as shown below. Once charging has finished, unplug the power cable from the power outlet.

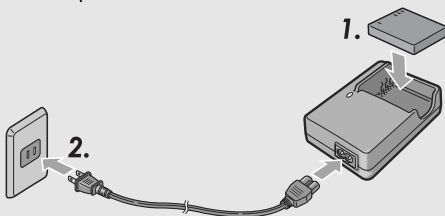

Charger Lamp	Description
Lit	Charging started
Off	Charging complete
Flashing	The battery charger terminal may be soiled or the battery charger/battery may be faulty. (After unplugging the power cable from the power outlet and wiping the battery charger terminal with a dry cloth or cotton swab, plug it in again. If the charger lamp continues to flash, it is possible that the battery charger or battery is faulty. Unplug the power cable from the power outlet, and remove the battery.)

- The estimated battery charging time is shown below. Depending on the battery level, the charging time differs.

Rechargeable battery charging time	
DB-70	Approx. 100 min. (25°C)

Loading the Rechargeable Battery and SD Memory Card

After recharging the rechargeable battery, load the rechargeable battery and the SD memory card. Be sure the camera is off before removing the battery or SD memory card.

- 1** Open the battery/card cover.

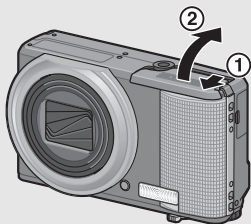

- 2** Make sure the SD memory card is facing the right way and then push the card all the way in until it clicks.

- The rechargeable battery may be inserted first.

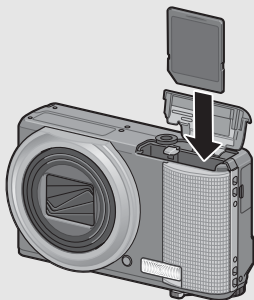

If you are using the camera for the first time, read this section.

3 Insert the rechargeable battery.

- When the rechargeable battery is loaded in place, it is locked with the hook shown in the figure.

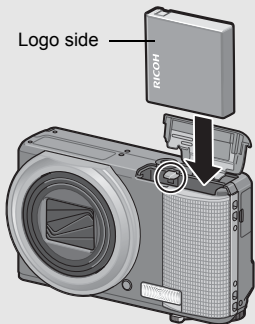

4 Close the battery/card cover and slide it back into place.

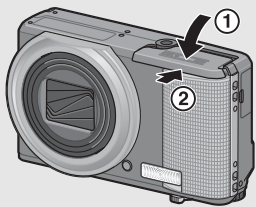

If you are using the camera for the first time, read this section.

Removing the Rechargeable Battery

Open the battery/card cover. Release the hook that locks the rechargeable battery. The battery is ejected. Pull the battery out of the camera. Be careful not to drop the battery when removing it from the camera.

Removing the SD Memory Card

Open the battery/card cover. Push in the SD memory card and gently release to eject it. Pull the card out of the camera.



Caution

Remove the battery if you are not going to use the camera for a long period of time. Store the removed battery in a dry cool place.

Turning the Power On/Off



- To turn the power on:

1 Press the POWER button.

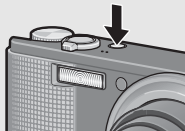
- After the start sound, the picture display turns on.



Using the Camera in Playback Mode

- Pressing and holding the  (Playback) button turns on the camera in playback mode, allowing you to start playback at once.
- When the camera has been turned on with the  button, pressing the  button again switches playback mode to shooting mode.

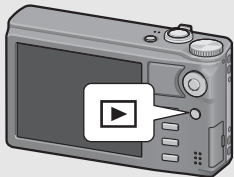

Caution

After the camera is turned on, it may take longer for the camera to become ready for shooting when using the flash than when not using the flash.

- To turn the power off:

1 Press the POWER button.

- The number of files recorded on that day is displayed, and then the camera turns off.
- If the date is not set, the number of files recorded is displayed as [0].
- If the date is changed, only the number of files recorded after the date change is displayed.

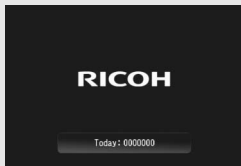



About Auto Power Off-----

- If the camera goes unused for a set period of time, it automatically turns itself off to save power. (Auto Power Off)
- The auto power off setting can be changed. (☞ P.183)



About LCD Auto Dimmer Mode-----

When [LCD Auto Dim] is set to [On] on the setup menu (☞ P.184), the picture display dims to conserve battery power if the camera is not moved for approximately five seconds. Move the camera or press any button to return to the original picture display brightness.

If you are using the camera for the first time, read this section.

Setting the Language

When the power is turned on for the first time, the language setting screen appears (for the picture display language). After setting the language, go on to the date/time setting (for printing the date and time on your photos).

You can shoot without these settings. However, be sure to set the language, and the date/time later. Use the setup menu for these settings.

If you are using the camera for the first time, read this section.

1 Turn the power on for the first time after purchase.

- The language selection screen appears.
- To skip language setting, press the DISP. button.
- When the DISP. button is pressed, the language setting is canceled and the date/time setting screen appears.

2 Press ADJ./OK button ▲▼◀▶ to select a language.

3 Press the ADJ./OK button.

- The display language is set, and the date/time setting screen appears.



Note

For how to set the display language and date/time on the setup menu, see "Language Settings" (📖 P.195) and "Date and Time Settings" (📖 P.194) in this guide.

Setting the Date and Time

When the power is turned on for the first time, the date/time setting screen appears.

1 Press the ADJ./OK button ▲▼◀▶ to set the year, month, date, time and format.

- Change the setting with ▲▼ and move the item with ◀▶.
- You can cancel the setting by pressing the DISP. button.

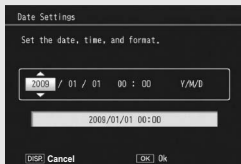

Setting at shipping

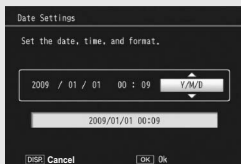

2 Check the display and then press the ADJ./OK button.

- The confirmation screen appears.

3 Press the ADJ./OK button.

- The date and time are set.



Note

- If the battery is removed for more than one week, the date and time settings will be lost. These settings must be made again.
- To retain the date and time settings, load a battery with adequate remaining power for more than two hours.
- The set date and time can be changed later. (☞ P.194)
- The date and time can be inserted into images. (☞ P.123)

If you are using the camera for the first time, read this section.

Basic Shooting

Now you are ready.

Holding the Camera

Hold the camera as shown below for best results.

- 1** Hold the camera with both hands and lightly press both elbows against your body.



- 2** Put your finger on the shutter release button.



Caution

- When you are shooting, be careful not to obstruct the lens or flash with your fingers, hair, or the strap.
- Do not hold the lens unit. Zoom and focusing will not be performed properly.



Preventing Camera Shake

If you move the camera when pressing the shutter release button, the still image might not come out clearly due to camera shake.

Camera shake tends to occur in the following cases:

- When shooting in a dark place without using the flash
- When using the zoom function
- When shooting using time exposure (👉 P.117)

When the 📷 symbol appears on the picture display, this indicates that camera shake may occur. To prevent camera shake, try any of the following.

- Using the camera shake correction function (👉 P.121)
- Setting the flash to [Auto] or [Flash On] (👉 P.43)
- Raising the ISO setting (👉 P.128)
- Using the self-timer (👉 P.45)

If you are using the camera for the first time, read this section.

Shooting with Auto Shooting Mode

Turn the mode dial to  to shoot with auto shooting mode. The shutter release button works in two steps. When you press the shutter release button halfway (Half-press), the auto-focus function is triggered to determine the focal distance. Next, press it all the way down (Full-press) to shoot. When your subject is not in the center of your composition, compose your photo after focusing. (Focus Lock)

If you are using the camera for the first time, read this section.

- 1** Press the **POWER** button to turn the camera on, and turn the mode dial to .

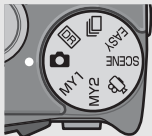

- 2** Put the subject of your photo in the center of the screen and press the shutter release button halfway.



- The camera focuses on the subject and the exposure and white balance are fixed.
- If automatic focusing fails, a red frame is displayed in the center of the picture display.
- The focal distance is measured at a maximum of nine points. Green frames appear to indicate the positions that are in focus.

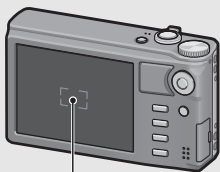

Frame

3 To take a picture with the subject in the foreground in focus against a background, half-press the shutter release button to focus on the subject, and then compose your shot.

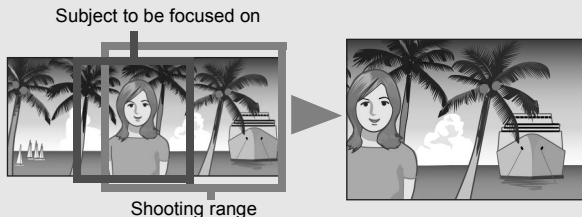

4 Gently press the shutter release button all the way.

- The still image you have taken appears momentarily on the picture display and is recorded to the internal memory or SD memory card.



About Focusing

The color of the frame in the center of the picture display indicates whether the subject is in or out of focus.

Focus Status	Frame Color
Before focusing	White
Subject in focus	Green
Subject not in focus	Red (Flashing)

It may be impossible to bring the following subjects into focus, or they may not be in focus even when the frame color is green.

- Objects that lack contrast, such as the sky, a wall that is only one color, or the hood of a car.
- Flat two-dimensional objects with only horizontal lines and no significant protrusions.
- Quickly moving objects.
- Things in poorly lit places.
- Areas with strong backlighting, or reflections.
- Things that flicker, such as fluorescent lights.
- Point light sources, such as light bulbs, spotlights, or LEDs.

When you want to shoot subjects like this, first focus on an object the same distance as your subject and then shoot.



Note

- Press the shutter release button gently to prevent camera shake.
- The  symbol indicates that camera shake may occur. Hold the camera still and focus the camera again. You can also turn on the camera shake correction function to minimize blurring. (P.121)
- The auxiliary flash fires to increase the AE accuracy.

If you are using the camera for the first time, read this section.

Shooting with Easy Shooting Mode

Turning the mode dial to EASY limits the shooting functions that can be changed and allows you to shoot with easy operations and without having to make any complicated settings.

With this mode, even first-time users can comfortably use the camera without worrying about the settings. This is useful when sharing the camera with other family members or asking someone to take your picture while on vacation.

If the camera detects a face anywhere in the frame, it will set focus, exposure, and white balance for the detected face.

- 1** Turn the mode dial to EASY.
- 2** Press the shutter release button to shoot the picture.

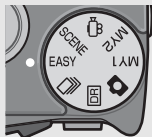

If you are using the camera for the first time, read this section.

**Note**

- The shooting menu can only be used to set [Picture Quality/Size] and [Date Imprint]. For the operating procedure, see P.101 and P.123. The other shooting menu items are fixed at their default settings (☞ P.234), except for [ISO Setting] which is fixed at [Auto] or [Auto-Hi] depending on the flash mode.
- When the mode dial is set to easy shooting mode, the quantity and order of the items in the setup menu are different from other shooting modes. The contents of the settings are the same as other modes.
- Flash, macro, and self-timer settings that are changed in another mode return to their default settings when easy shooting mode is selected.
- Macro mode can not be selected with the ADJ./OK button in easy shooting mode. Instead, the camera automatically enters macro mode when the subject is close to the camera and a  icon is displayed. The minimum distance to the subject and the dimensions of the area photographed at this distance are shown below.

Zoom Position	Focal Length ^(*)	Minimum Shooting Distance (from the front of the lens)	Shooting Range
Wide-angle	28 mm	Approx. 8 cm	Approx. 111 mm × 83 mm
Telephoto	300 mm	Approx. 27 cm	Approx. 45 mm × 34 mm (when digital zoom is not used)
	1440 mm	Approx. 27 cm	Approx. 9.4 mm × 7.0 mm (when 4.8× digital zoom is used)

^(*) Equivalent to that on a 35 mm camera

Using the Zoom Function

Turning the zoom lever toward [A] (Telephoto) allows you to take a close-up picture of the subject.

Turning the zoom lever toward [W] (Wide-angle) allows you to take a wide-angle picture.

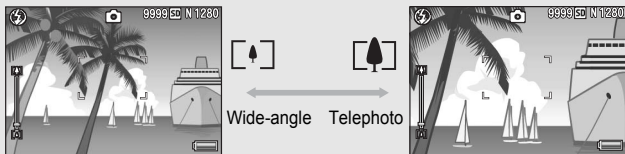

1 With the camera ready to shoot, turn the zoom lever toward [A] or [W].

- You can check the zoom status on the zoom bar of the picture display.
- Low speed zooming and high speed zooming are available. Turning the zoom lever just slightly toward [A] operates the zoom at low speed. Hold the zoom lever at [A] to activate to high-speed zoom.

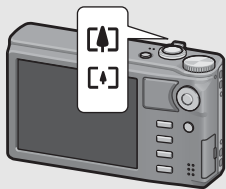

2 Compose your picture and half-press the shutter release button.

3 Full-press the shutter release button.

If you are using the camera for the first time, read this section.



Using the Digital Zoom -----

While you can use the normal zoom to enlarge the subject up to 10.7 \times , digital zooming allows you to enlarge the subject still further (up to another 4.8 \times for still images or 4.0 \times for movies).

To use digital zooming, turn and hold the zoom lever toward **[A]** until the maximum magnification is reached on the zoom bar, then momentarily release the zoom lever, and then turn the zoom lever again toward **[A]**.

If [Picture Quality/Size] is set to 3456 \times 2592, you can also set [Digital Zoom Image] to [Auto Resize]. (☞ P.185)



Note -----



- You can also set the focal length of the zoom so that it stops at eight levels. (☞ P.173)
- The digital zoom cannot be used with dynamic range double-shot or multi-target AF.

Shooting Close-Ups (Macro Shooting)

The macro shooting function lets you take shots of subjects that are very close to the lens.

This is good for shooting small subjects because you can shoot up to approximately 1 cm (0.4 in.) away from the front of the lens.

1 Press the ADJ./OK button toward (Macro).

-  is displayed momentarily at the center of the picture display and then  is displayed at the top of the screen.

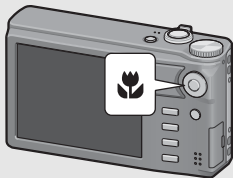

2 Compose your picture and half-press the shutter release button.

3 Full-press the shutter release button.

- To cancel macro mode, press the ADJ./OK button toward  again.

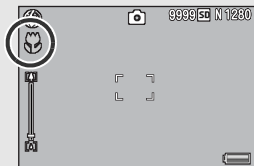

If you are using the camera for the first time, read this section.

**Note**

- If macro mode is selected when the zoom position is set to the wide-angle side (28 mm focal length*), the zoom position is automatically fixed at 31 mm*. (* Equivalent to that on a 35 mm camera)
- The minimum shooting distance and shooting range when using the zoom are shown below.

Zoom Position	Focal Length ^(*)	Minimum Shooting Distance (from the front of the lens)	Shooting Range
Wide-angle	31 mm	Approx. 1 cm	Approx. 28 mm × 21 mm
Telephoto	300 mm	Approx. 27 cm	Approx. 45 mm × 34 mm (when digital zoom is not used)
	1440 mm	Approx. 27 cm	Approx. 9.4 mm × 7.0 mm (when 4.8× digital zoom is used)

^(*) Equivalent to that on a 35 mm camera

- During macro shooting, the minimum shooting distance changes depending on the zoom position. To display the minimum shooting distance on the screen, set [Minimum Distance] to [Show]. (P.190)
- To take a further close-up picture during macro shooting, use [Zoom Macro] in scene mode. (P.74)
- In macro mode, [Focus] (P.103) functions according to the [Spot AF] setting even if it is set to [Multi AF], [Snap], or [∞]. (Not applicable for easy shooting mode.)
- The availability of macro shooting for each scene mode is shown below.

Scene Mode	Macro Shooting
Portrait	Disabled
Sports	Disabled
Night. Port.	Disabled
Landscape	Disabled
Nightscape	Disabled
High Sens	Enabled
Discreet Mode	Enabled
Zoom Macro	Macro shooting only
High Contrast B&W	Enabled
Miniaturize	Enabled
Skew Correct Mode	Enabled
Text Mode	Enabled

Using the Flash





You can select the flash mode that best suits your shot. At the time of purchase, the camera is set to [Auto].

Flash Range

* When ISO Setting (P.128) is set to [Auto] or [ISO 800]

Wide-angle	Approx. 20 cm to 3.0 m (from the front of the lens)
Telephoto	Approx. 28 cm to 4.0 m (from the front of the lens)

Flash Modes

	Flash Off	The flash will not fire.
	Auto	The flash fires automatically when the subject is poorly lit or backlit.
	Red-Eye Flash	Reduces the red-eye phenomenon, in which people's eyes appear red in pictures.
	Flash On ^(*)	The flash fires regardless of the lighting conditions.
	Flash Synchro. ^(*)	The flash fires with the shutter speed slowed. This is useful when taking portrait pictures in a nightscape. Camera shake may occur, so the use of a tripod is recommended.

^(*) This function is not available in easy shooting mode.

1 Press the ADJ./OK button toward (flash).

- The list of the flash modes symbol is displayed on the picture display.

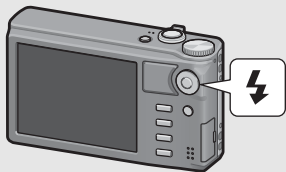

2 Press the ADJ./OK button to select the flash mode.

- The flash mode symbol is displayed at the upper left of the picture display.
- The flash mode symbol blinks at the upper left of the picture display when the flash is charging. Once the flash is charged, the symbol stops blinking and lights steadily and the camera is ready to shoot.

**Note**

- The flash mode setting is retained until you press the ADJ./OK button toward  (Flash) again.
- The flash does not fire when shooting movies, in continuous mode, in multi-target AF, in dynamic range double-shot, and in bracket shooting.
- You can adjust the light intensity of the flash. (🔧 P.111)
- The auxiliary flash fires to increase the AE accuracy.
- The flash mode setting for each scene mode is shown below.

Scene Mode	Flash Mode
Portrait	Initial setting: [Flash Off]
Sports	Initial setting: [Flash Off]
Night. Port.	Only [Red-Eye Flash] or [Flash Synchro.] can be selected. Initial setting: [Flash Synchro.]
Landscape	Fixed at [Flash Off]
Nightscape	Only [Flash Off], [Auto] or [Flash Synchro.] can be selected. Initial setting: [Auto]
High Sens	Initial setting: [Flash Off]
Discreet Mode	Fixed at [Flash Off]
Zoom Macro	Initial setting: [Flash Off]
High Contrast B&W	Initial setting: [Flash Off]
Miniaturize	Initial setting: [Flash Off]
Skew Correct Mode	Initial setting: [Flash Off]
Text Mode	Initial setting: [Flash Off]

Using the Self-Timer

You can set the self-timer to shoot after either two or ten seconds, or you can select [Custom] to customize the self-timer setting. With [Custom], you can take a set number of pictures at a set interval. Use [Custom Self-Timer] on the shooting menu to set the shooting interval and number of pictures for [Custom]. (P.118)

1 With the camera ready to shoot, press the (Self-timer) button.

- A list of self-timer mode settings appears on the picture display.

2 Press the ADJ./OK button to select a mode.

- The Self-timer symbol appears on the screen.
- The [10] to the right of the symbol indicates the number of seconds. In this case, if you press the shutter release button, the camera shoots after 10 seconds.

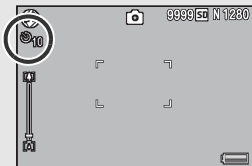

3 Press the shutter release button.

- When set to [10], the self-timer lamp lights for 8 seconds when the self-timer starts and then blinks for the final 2 seconds before the picture is taken.
- When set to [Custom], the self-timer lamp blinks for 2 seconds before each picture is taken, and pictures are taken at the set shooting interval. The focus position is set for the first shot.
- When set to [Custom], press the MENU button to cancel the self-timer during shooting.



Note





- The camera remains in self-timer mode even after the image is shot. To cancel the self-timer, press the  button and change the self-timer setting to [Self-Timer Off].
- When the self-timer is set to 2 seconds, the self-timer lamp does not light or blink.
- You can only select [10] in easy shooting mode.
- When the self-timer is set, the [Interval Shooting] setting is disabled.
- [Custom] is not available when [Focus] is set to [Multi-trgt AF].
- If [Focus] is set to [Multi-trgt AF] while [Custom] is selected, [Custom] is canceled and the self-timer is turned off.

Playing Back Images

Viewing Your Images

In playback mode, you can check still images you have taken. You can also delete or zoom in on the images.

1 Press the (Playback) button.

- The camera switches to playback mode and the last image taken is displayed.
- If the camera is off, press the  button for about a second to turn the camera on and start playback.
- Pressing the ADJ./OK button    displays the files in the following order.

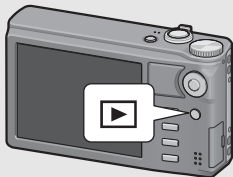

10 files backward



1 file backward



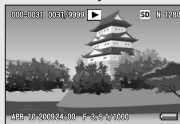

1 file forward

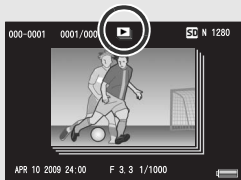

10 files forward

- Files displayed with the  symbol are images taken with M-Cont Plus, Speed Cont, or Multi-trgt AF. See P.132 for more information on playing back images.



- To switch the camera from playback mode to shooting mode, press the  button again.



Note-----

Setting your favorite image files to [Flag Function Setting] on the playback menu allows you to easily display these files. (☞ P.140)



Checking the image in shooting mode-----



In shooting mode, immediately after you take a still image, the still image is displayed on the screen for a moment so you can check it. You can change the image display time using [LCD Confirmation Time] on the setup menu. (☞ P.182)

When [LCD Confirmation Time] is set to [Hold], the image remains displayed until the next time you half-press the shutter release button. When [LCD Confirmation Time] is set to [Hold], the displayed image can also be enlarged or deleted. (☞ P.50, 52)



Turning on the camera in playback mode-----

When the camera is off, pressing and holding the  (Playback) button turns the camera on. (The camera starts up in playback mode.)

When the camera has been turned on with the  button, pressing the  button again switches playback mode to shooting mode.



Where images are played back from-----

When no SD memory card is loaded, the camera plays back from the internal memory. When an SD memory card is loaded, it plays back from the SD memory card.

Thumbnail View

When playing back images on the picture display, the playback screen can be divided into 20 frames or 81 frames.

If you are using the camera for the first time, read this section.

1 Press the (Playback) button.

- The last file recorded is displayed.

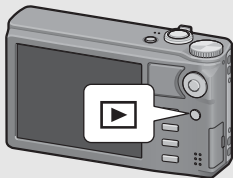

2 Turn the zoom lever toward (Thumbnail View).

- The screen is divided into 20 frames and thumbnails are displayed.

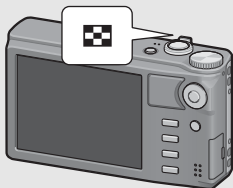

3 Turn the zoom lever toward again.

- The screen is divided into 81 frames and thumbnails are displayed.

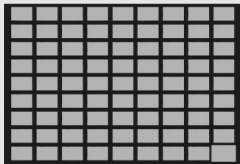

Switching to Single-Picture Display

- 1** Press the ADJ./OK button ▲▼◀▶ to select a file.
- 2** Press the ADJ./OK button or turn the zoom lever once or twice toward 🔍 (Enlarged View).

If you are using the camera for the first time, read this section.

Enlarging Images

You can enlarge a still image displayed on the picture display.

Image Size	Enlarged View (maximum magnification)
640 × 480	3.4×
1280 × 960	6.7×
Image sizes other than those above	16×

1 Press the (Playback) button.

- The last file recorded is displayed.

2 Press the ADJ./OK button to display the still image you want to enlarge.

3 Turn the zoom lever toward (Enlarged View).

- The still image is enlarged.
- Pressing the ADJ./OK button in enlarged view changes the magnification as follows.

If [Picture Quality/Size] is N2048(3M) or larger:

In enlarged view at magnifications of less than 8×, the magnification increases to 8×. In enlarged view at magnifications of 8× or more, the magnification increases to 16×.

If [Picture Quality/Size] is N1280(1M) or smaller:

The magnification increases to the maximum magnification.

- Pressing the DISP. button at this point changes the display as follows.



DISP. button



Pressing the ADJ./OK button
▲▼◀▶ at this point moves
the area displayed.

Pressing the ADJ./OK button
▲▼◀▶ at this point moves
the area displayed.

Pressing and
holding the
DISP. button



Pressing and
holding the
DISP. button

Pressing the ADJ./OK button ◀▶
at this point displays the previous
or next image enlarged.
When an MP file or a movie is
displayed, the display returns to
the normal size.

4 Turn the zoom lever toward (Thumbnail View) to return to the original size.



Note

- When [LCD Confirmation Time] is set to [Hold] on the setup menu ( P.182), the image displayed on the screen after being taken can be enlarged.
- Movies cannot be enlarged.
- For information on how to enlarge MP files, see P.132 - 133.

If you are using the camera for the first time, read this section.

Deleting Files

You can delete unwanted or failed shooting files from the SD memory card or internal memory.



Note

- You can use the [Recover File] function to restore needed files that you accidentally deleted. (P.162)
- When [LCD Confirmation Time] is set to [Hold] on the setup menu (P.182), the image displayed on the screen after being taken can be deleted.

1 Press the (Playback) button.

2 Press the ADJ./OK button to display the file you want to delete.

- To delete multiple files, you can also turn the zoom lever toward (Thumbnail View) to display thumbnail view, and then go to Step 3.

3 Press the (Delete) button.

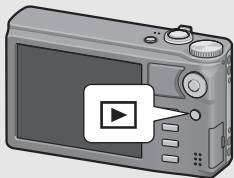

Deleting a File

4 Press the ADJ./OK button to select [Delete One].

- You can change the image for deletion with the button .

5 Press the ADJ./OK button.

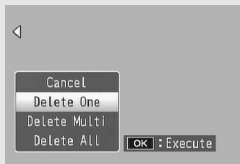

Specifying Multiple Files Separately

4 Press the ADJ./OK button ▲▼ to select [Delete Multi] and then press the ADJ./OK button.

- If thumbnail view was displayed in Step 2 on P.52, skip Step 4.

5 Press the button ▲▼ to select [Sel. Individ.] and then press the ADJ./OK button.

6 Press the ADJ./OK button ▲▼◀▶ to select the file you want to delete and press the ADJ./OK button.

- The trash symbol is displayed in the upper left corner of the file.
- Press the MENU button to switch to the display for specifying a range of files. See Step 6 and beyond on P.54.

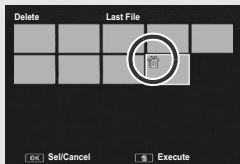

7 Repeat Step 6 to select all the files you want to delete.

- If you selected a file by mistake, you can deselect it by selecting the file and pressing the ADJ./OK button.

8 Press the  (Delete) button.

9 Press the ADJ./OK button ◀▶ to select [Yes] and then press the ADJ./OK button.

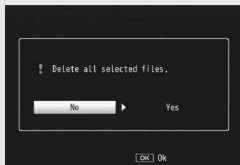

If you are using the camera for the first time, read this section.

Specifying a Range of Multiple Files

4 Press the ADJ./OK button ▲▼ to select [Delete Multi] and then press the ADJ./OK button.

- If thumbnail view was displayed in Step 2 on P.52, skip Step 4.

5 Press the ADJ./OK button ▲▼ to select [Sel. Range] and then press the ADJ./OK button.

6 Press the button ▲▼◀▶ to select the starting point of the range of files you want to delete and press the ADJ./OK button.

- If you make a mistake when selecting the starting point for the range of files, press the DISP. button to return to the screen for selecting the starting point.
- Press the MENU button to switch to the display for specifying files separately. See Step 6 and beyond on P.53.

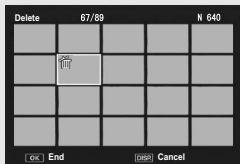

7 Press the button ▲▼◀▶ to select the ending point of the range of files you want to delete and press the ADJ./OK button.

- The trash symbol is displayed in the upper left corner of the specified files.

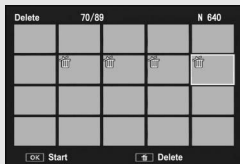

8 Repeat Steps 6 and 7 to specify all the ranges of files you want to delete.

9 Press the  (Delete) button.

- 10** Press the ADJ./OK button ◀▶ to select [Yes] and then press the ADJ./OK button.

Deleting All Files

- 4** Press the ADJ./OK button ▲▼ to select [Delete All] and then the ADJ./OK button.
- 5** Press the button ◀▶ to select [Yes] and then press the ADJ./OK button.

If you are using the camera for the first time, read this section.

Changing the Display with the DISP. Button

Pressing the DISP. button allows you to change the screen display mode and toggle the information displayed on the picture display.

● During Shooting Mode

Normal Symbol Display



Histogram Display



Grid Guide Display

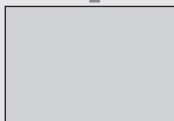

Picture Display Off
(Synchro-Monitor Mode)

Press the DISP. button to
change the display.



No Display

If you are using the camera for the first time, read this section.



Grid Guide Display-----

- This displays auxiliary lines on the picture display to help you compose your picture. These lines are not recorded with images.
- See P.188 for information on choosing a grid guide.



Synchro-Monitor Mode-----

This turns the picture display off except when the camera is operated. This is effective for saving power consumption. In this mode, pressing the shutter release button halfway turns the picture display on. Subsequently, pressing the shutter release button fully displays the shot image on the picture display and then turns the picture display off.

(This setting is different from [LCD Auto Dim] in the setup menu.)



Note-----

- When [Shooting Info. Display Frame] is set to [On] in the setup menu, the shooting information display frame can be displayed for normal symbol display and histogram display. (P.189)
- In easy shooting mode, the display cannot be changed using the DISP. button.

- Histograms are not displayed in movie mode. A blinking [● REC] icon, the recording time, and the time available are displayed during recording even when indicators are hidden or the grid guide is displayed.
- When [Level Setting] is set to [Display] or [Display+Sound] (☞ P.187), the level indicator is displayed during normal symbol display and histogram. (☞ P.58)
- If any of the following operations is performed, the picture display turns on even when it is turned off.
 - When the ADJ./OK button, MENU button, DISP. button, or [▶] (Playback) button is pressed.
 - When the zoom lever is turned.
 - When the ADJ./OK button is pressed toward ▲▼ during manual focus. (☞ P.105)

● During Playback Mode

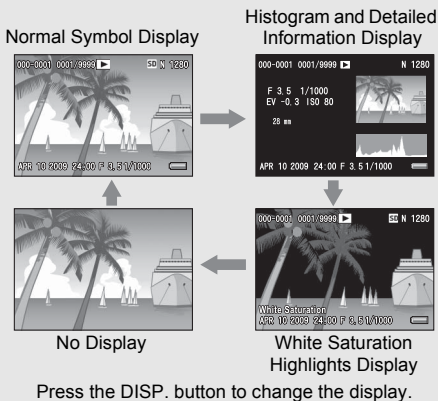

White Saturation Highlights Display

The white saturation areas of the image flash in black. White saturation is the loss of tone that indicates the color shading in an image in which very bright areas of the subject are rendered in white. An image with a loss of image tone cannot be edited later. It is recommended that you shoot another image by changing the composition or by setting the exposure level lower (-). (☞ P.124)



Note

The white saturation highlights display is for reference only.

About the Electronic Level

When [Level Setting] is turned on in the setup menu or by pressing and holding the DISP. button (☞ P.187), the camera uses a level indicator and level sound to let you know whether the image is level during shooting. The level indicator is displayed during normal symbol display and histogram.

This is useful for keeping the image level when taking pictures of scenery or buildings. This is also very useful for taking pictures with the horizon visible.

For information on how to set [Level Setting], see P.187.

- **With [Level Setting] set to [Display]:**

The level indicator appears on the picture display. The level sound will not emit.

- **With [Level Setting] set to [Display+Sound]:**

The level indicator appears on the picture display. When the camera is level, the level sound is continually emitted at a set interval.

- **With [Level Setting] set to [Sound]:**

When the camera is level, a level sound is continually emitted at a set interval and the level indicator is not displayed.

If you are using the camera for the first time, read this section.

Level indicator display

When level:

The level indicator becomes green, indicating that the scale is in the middle.

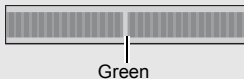

When tilted to the right or left:

The mark on the level indicator becomes orange, indicating the opposite side of the direction in which the camera is tilted.



When the camera is tilted too far to the right or left:

Half of the level indicator on the opposite side of the direction in which the camera is tilted becomes red. The mark on the level indicator is not displayed.

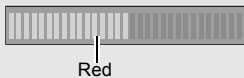

When the camera is tilted too far forward or backward, or it cannot be determined whether the camera is level:

The top and bottom of the level indicator become red. The mark on the level indicator is not displayed.

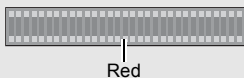

When the camera is held vertically:

When shooting with the camera positioned vertically, the level function can be used to determine whether the image is vertically level.



Caution

- During grid guide display, no display, or when the picture display is turned off (P.56), the level sound is emitted, but the level indicator is not displayed. When [Level Setting] is set to [Display+Sound], only the level sound is emitted.
- The level function is not available if the camera is held upside down, when recording movies, and during interval shooting.
- The level function becomes less accurate when the camera is moving or when shooting in an environment subject to moving, such as on an amusement ride.
- No level sound is emitted when [Level Setting] is set to [Display+Sound] or [Sound] and [Volume Settings] is set to [] (Mute) (P.187).
- Use this function as a reference to see if images are level when shooting images. The accuracy of the level when using the camera as a level cannot be guaranteed.

About the Histogram Display

When Histogram is on, a histogram appears in the lower right corner on the picture display. A histogram is a graph indicating the number of pixels on the vertical axis and the brightness on the horizontal axis (from left to right, shadows (dark areas), midtones, and highlights (bright areas)).

By using the histogram, you can determine the brightness of an image without being affected by the brightness around the picture display. This also helps you correct for areas that are overly bright or dark.

If the histogram has only peaks on the right side, this picture is overexposed with too many pixels only for highlight sections.

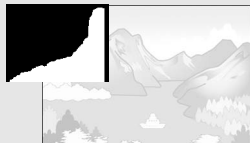

If the histogram has only peaks on the left side without anything else, this picture is underexposed with too many pixels only for shadow sections. Refer to this histogram when correcting the exposure.



Note

- The histogram displayed on the picture display is for reference only.
- After taking a picture, you can correct its brightness and contrast by making adjustments to the histogram. (P.147)
- Depending on the shooting conditions (use of the flash, dark surrounding light, etc.), the exposure level indicated in the histogram may not correspond to the brightness of the shot image.
- Exposure compensation has its limitation. It does not necessarily achieve the best possible result.
- A histogram with peaks in the center may not necessarily provide the best result to suit your particular requirements.
For example, an adjustment is required if you want to underexpose or overexpose the image.
- For information on how to correct the exposure compensation, see P.124.

Advanced Operations

Read this section when you want to learn more about the different camera functions.

1	ADJ. Button Functions	62
2	Using the Fn (Function) Button	66
3	Shooting Mode Types	74
4	Shooting Menu	97
5	Playback Functions	131
6	Playback Menu	138
7	Setup Menu	165
8	Direct Printing	197
9	Downloading Images to Your Computer	204
10	Appendices	221

1

2

3

4

5

6

7

8

9

10

1 ADJ. Button Functions

Instructions in this manual to “Press the ADJ./OK button ▲▼◀▶” indicate that you should press the ADJ./OK button in the up, down, left or right direction. Instructions to “Press the ADJ./OK button” indicate that you should press directly down on the button.

1

ADJ. Button Functions

The ADJ./OK button has the following functions. For the operating procedure of each function, see the corresponding reference page.

- ① Assigning four functions from the shooting menu (👉 P.62)
- ② Shifting the AE and AF targets (👉 P.64)

Assigning Functions from the Shooting Menu

You can assign four functions from the shooting menu to the ADJ./OK button. The fifth function is fixed to AE/AF target shift (👉 P.64) and cannot be changed.

By using the ADJ./OK button, you can make settings with fewer button operations and without displaying the shooting menu. This is convenient for frequently used functions.

1 Set the functions you want to assign to the ADJ./OK button with [ADJ Button Setting 1/2/3/4] on the setup menu.

- At the time of purchase, four of the functions are assigned. You can change the assigned functions. For the operating procedure, see P.176.

2 In shooting mode, press the ADJ./OK button.

- The ADJ. mode screen appears.

3 Press the ADJ./OK button ◀▶ to select the desired item.

- The screenshots below are examples of the screen display when [Exposure Comp.], [White Balance], [ISO], and [Quality] are assigned to [ADJ Button Setting 1] to [ADJ Button Setting 4] with the setup menu.
- The fifth icon (AE/AF target shift) is fixed and cannot be changed in the setup menu.

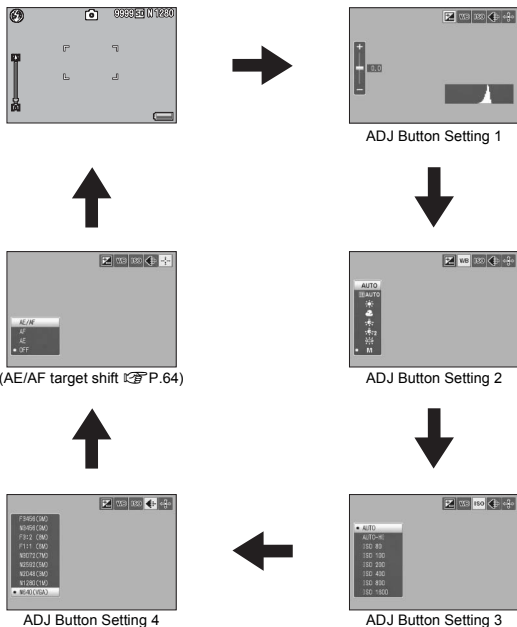

4 Press the ADJ./OK button ▲▼ to select the desired setting.

5 Press the ADJ./OK button to confirm the setting.



Note

For functions that can be assigned to the ADJ./OK button and instructions on how to assign them, see P.176.

Shifting the AE and AF Targets

When you are taking a picture, you can use the ADJ./OK button to shift the target for the automatic exposure (AE) and/or the auto focus (AF) without having to move the camera. This is particularly useful when you are using a tripod to take pictures.

Available Setting	Description
AE/AF	AE and AF are set to Spot AE and Spot AF respectively and the target can be moved for both simultaneously. (The targets for Spot AE and Spot AF occupy the same position.)
AF	The AF is set to Spot AF and the target can be moved. The exposure metering is set to the mode selected in [Exposure Metering] in the shooting menu. (☞ P.108)
AE	The AE is set to Spot AE and the target can be moved. The focus is set to the mode selected in [Focus] in the shooting menu. (☞ P.103)

1

ADJ. Button Functions

1 Turn the mode dial to , or .

2 Press the ADJ./OK button in shooting mode.

3 Press the ADJ./OK button to select .

4 Press the button to select the setting and then press the ADJ./OK button.

- The target shift screen appears.



5 Press the button to move the cross-mark to the desired target position.

- Pressing the DISP. button returns the display to the screen in Step 3.

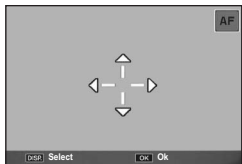

6 Press the ADJ./OK button.

7 Half-press the shutter release button.

- If [AE/AF] is selected, the Spot AE/Spot AF position is displayed.
- If [AF] is selected, the Spot AF position is displayed.
- If [AE] is selected, the Spot AE position and focusing frame are displayed.

8 Gently press the shutter release button all the way.



Note

- In scene mode and movie mode, the macro target can be shifted by pressing the ADJ./OK button and selecting . See Step 3 and beyond on P.67 for the operating procedure after selecting .
- If the macro target shift function is activated using the Fn button (P.67) and not canceled, will not be displayed even if the ADJ./OK button is pressed.
- You cannot use the AE/AF target shift function if [Focus] (P.103) is set to [Continuous AF], [Multi-trgt AF], or [MF].
- If the following operations are performed after shifting the target, the shifted target returns to the center.
 - The [AE], [AF], or [AE/AF] settings are changed.
 - [Focus] is set to [Continuous AF], [Multi-trgt AF], or [MF].

2 Using the Fn (Function) Button

When a function is assigned to the Fn (Function) button with [Set Fn Button] on the setup menu (P.174), you can easily switch from one function to another simply by pressing the Fn button.

The following functions can be assigned to the Fn button. For the operating procedure of each function, see the corresponding reference page.

Available Setting	Description	Refer to
Macro Target *Default setting	Moves the AF target without moving the camera to shoot close-ups.	P.67
AE Lock	Locks the exposure.	P.68
AF/Cont. AF	Switches between auto focus (*) and continuous AF.	P.69
AF/M-trgt AF	Switches between auto focus (*) and multi-target AF.	P.70
AF/MF	Switches between auto focus (*) and manual focus.	P.71
AF/Snap	Switches between auto focus (*) and snap mode.	P.72
Step Zoom, AT-BKT, WB-BKT, CL-BKT, FOCUS-BKT	Switches between on and off for each function.	P.73

(*) [Multi AF] or [Spot AF]



Note

- For information on the items that can be assigned in each shooting mode, see P.177.
- The Fn button can not be used as described above when [Miniaturize] is selected in scene mode.
- Pressing the Fn button in playback mode displays the image assigned with [Flag Function Setting]. For the operating procedure, see P.140-142.
- Selecting [Trim], [Level Compensation] (when [Manual] is selected), or [White Balance Compensation] on the playback menu, and pressing the Fn button displays the screen that describes the operating procedure. (P.144, 148, 150)

Shifting the AF Target for Macro Shooting

You can shift the AF target without moving the camera to take a close-up picture. You can lock the focus (👉 P.34) at the position where the macro target is shifted and shoot the picture. This is particularly useful when you are using a tripod to take pictures.

1 Set [Set Fn Button] to [Macro Target] on the setup menu.

- For the operating procedure, see P.174.

2 With the camera ready to shoot, press the Fn button.

- The macro target shift screen appears.

3 Press the ADJ./OK button ▲▼◀▶ to move the cross-mark to the desired target position.



4 Press the ADJ./OK button.

- Pressing the DISP. button cancels the macro target shift function.

5 Half-press the shutter release button.

- The camera focuses on the area at the position of the cross-mark.

6 Gently press the shutter release button all the way.

- Pressing the ADJ./OK button toward 📷 (Macro) cancels the macro target shift function.





Note

If the AE/AF target shift function is activated using the ADJ./OK button (👉 P.64) and not canceled, the AE/AF target shift function cannot be used by pressing the Fn button.

Locking the Exposure

Assigning [AE Lock] to the Fn (Function) button (☞ P.174) and then pressing the Fn button during shooting allows you to lock or cancel the exposure.

- 1** Turn the mode dial to , **SCENE**,  or .
- 2** Set [Set Fn Button] to [AE Lock] on the setup menu.
 - For the operating procedure, see P.174.
- 3** Check that the camera is ready to shoot.
- 4** Put the subject of your photo in the center of the picture display and press the Fn button.
 - The exposure is locked and the AEL mark, aperture value, and shutter speed appear on the screen.
 - Pressing the Fn button again cancels the AE lock.

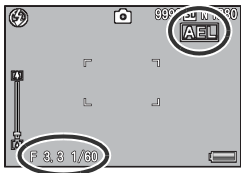

Note

- The AE lock function can only be used when [Time Exposure] is set to [Off].
- AE lock is not available when [AUTO] is selected for [Dynamic Range Expansion].

AF/Cont. AF

If [AF/Cont. AF] is assigned to the Fn (Function) button (☞ P.174), the Fn button can be used to toggle between [Continuous AF] and whichever of [Multi AF] and [Spot AF] is currently selected for [Focus] (or, if [Continuous AF] is selected for [Focus], between [Continuous AF] and whichever of [Multi AF] and [Spot AF] was last selected for [Focus] before [Continuous AF]).

[Focus] setting	Press the Fn button
Multi AF	Switches between [Continuous AF] and [Multi AF].
Spot AF	Switches between [Continuous AF] and [Spot AF].
Continuous AF	Switches between [Continuous AF] and whichever of [Multi AF] and [Spot AF] was last selected for [Focus].

2

Using the Fn (Function) Button

1 Set [Set Fn Button] to [AF/Cont. AF] on the setup menu.

- For the operating procedure, see P.174.

2 With the camera ready to shoot, press the Fn button.

- When the focus mode changes to [Continuous AF], the symbol appears on the screen.

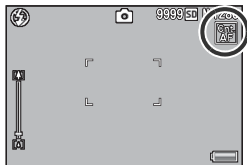

⚠ Caution

When [Focus] is set to [M-trgt AF], [Snap], [MF] or [∞] (☞ P.103), pressing the Fn button does not switch between AF and Continuous AF.

📌 Note

You can also use the shooting menu to make the [Focus] setting. (☞ P.103)

AF/M-trgt AF

If [AF/M-trgt AF] is assigned to the Fn (Function) button (☞ P.174), the Fn button can be used to toggle between [Multi-trgt AF] and the AF mode currently selected for [Focus] (or, if [Multi-trgt AF] is selected for [Focus], between [Multi-trgt AF] and whatever AF mode was last selected for [Focus] before [Multi-trgt AF]).

[Focus] setting	Press the Fn button
Multi AF	Switches between [Multi-trgt AF] and [Multi AF].
Spot AF	Switches between [Multi-trgt AF] and [Spot AF].
Continuous AF	Switches between [Multi-trgt AF] and [Continuous AF].
Multi-trgt AF	Switches between [Multi-trgt AF] and the AF mode last selected for [Focus].

2

Using the Fn (Function) Button

1 Set [Set Fn Button] to [AF/M-trgt AF] on the setup menu.

- For the operating procedure, see P.174.

2 With the camera ready to shoot, press the Fn button.

- When the focus mode changes to [Multi-trgt AF], the symbol appears on the screen.

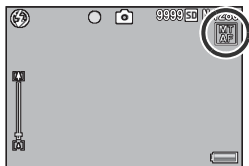

Caution

When [Focus] is set to [Snap], [MF] or [∞] (☞ P.103), pressing the Fn button does not switch between AF and multi-target AF.



Note

- For information on how to use multi-target AF, see P.104.
- You can also use the shooting menu to make the [Focus] setting. (☞ P.103)

AF/MF

If [AF/MF] is assigned to the Fn (Function) button (☞ P.174), the Fn button can be used to toggle between [MF] and the AF mode currently selected for [Focus] (or, if [MF] is selected for [Focus], between [MF] and whatever AF mode was last selected for [Focus] before [MF]).

[Focus] setting	Press the Fn button
Multi AF	Switches between [MF] and [Multi AF].
Spot AF	Switches between [MF] and [Spot AF].
Continuous AF	Switches between [MF] and [Continuous AF].
MF	Switches between [MF] and the AF mode last selected for [Focus].

1 Set [Set Fn Button] to [AF/MF] on the setup menu.

- For the operating procedure, see P.174.

2 With the camera ready to shoot, press the Fn button.

- When the focus mode changes to manual focus, the [MF] symbol appears at the upper right of the screen.



Caution

When [Focus] is set to [Multi-trgt AF], [Snap] or [∞] (☞ P.103), pressing the Fn button does not switch between AF and MF.

Note

- For information on how to use manual focus, see P.105.
- You can also use the shooting menu to make the [Focus] setting. (☞ P.103)



Locking the focus at the focus lock position -----

You can press the Fn button to switch AF/MF and lock the focus at the focus lock position (AF Lock). Use the following operating procedure.

- 1 With the camera set to auto focus, half-press the shutter release button to focus on the subject. (Focus Lock)
- 2 Release the shutter release button and press the Fn button.
 - The camera is set to MF and the shooting distance is fixed at the focus lock position.
 - To return to auto focus mode, press the Fn button again.

AF/Snap

2

Using the Fn (Function) Button

If [AF/Snap] is assigned to the Fn (Function) button (☞ P. 174), the Fn button can be used to toggle between [Snap] and the AF mode currently selected for [Focus] (or, if [Snap] is selected for [Focus], between [Snap] and whatever AF mode was last selected for [Focus] before [Snap]).

[Focus] setting	Press the Fn button
Multi AF	Switches between [Snap] and [Multi AF].
Spot AF	Switches between [Snap] and [Spot AF].
Continuous AF	Switches between [Snap] and [Continuous AF].
Snap	Switches between [Snap] and the AF mode last selected for [Focus].

1 Set [Set Fn Button] to [AF/Snap] on the setup menu.

- For the operating procedure, see P. 174.

2 With the camera ready to shoot, press the Fn button.

- When the focus mode changes to snap mode, the symbol appears at the upper right of the screen.

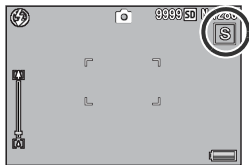

Caution -----

When [Focus] is set to [Multi-trgt AF], [MF] or [∞] (☞ P. 103), pressing the Fn button does not switch between AF and Snap.





Note -----

You can also use the shooting menu to make the [Focus] setting. (☞ P. 103)

Switching Between On and Off for Various Functions

Assigning one of the following functions to the Fn button (☞ P.174) and then pressing the Fn button allows you to switch between on and off for that function.

Step Zoom, AT-BKT, WB-BKT, CL-BKT, FOCUS-BKT

- 1 Turn the mode dial to , SCENE,  or .**
- 2 Set [Set Fn Button] to one of the above items on the setup menu.**
 - For the operating procedure, see P.174.
- 3 With the camera ready to shoot, press the Fn button.**
 - This switches between on and off for the selected function.



Note









The settings of the functions can be changed using the shooting menu. (☞ P.97)





3 Shooting Mode Types

Scene Mode (SCENE)

You can use scene mode to select from among twelve still image modes, and shoot with settings automatically optimized for shooting conditions.

Scene Modes

 Portrait	Use for portraits. The camera automatically detects, and adjusts focus, exposure, and white balance, for the subject's face. For detailed operations, see P.77.
 Sports	Use when taking pictures of moving objects.
 Night. Port.	Use when taking portrait pictures against a nightscape. The flash fires automatically. The shutter speed slows down, so be careful of camera shake.
 Landscape	Use when taking scenery pictures with abundant greenery or blue sky.
 Nightscape	Use when shooting night scenes. In nightscape mode, the flash fires when all of the following conditions are satisfied: <ul style="list-style-type: none">• The flash is set to [Auto].• The flash is determined to be necessary because it is dark.• There is a figure or another object nearby.
 High Sens	Use when taking pictures in dimly lit places. The picture display also becomes brighter.
 Discreet Mode	Use in museums and in other situations in which lights or sounds emitted by the camera may be unwelcome. The flash, AF auxiliary light, and speaker turn off and flash, AF auxiliary light, and sound settings can not be adjusted.
 Zoom Macro	Automatically optimizes the zoom position to shoot the subject larger than with normal macro shooting. The optical zoom cannot be used in this mode. For detailed operations, see P.78.

 High Contrast B&W	Use to create black-and-white images with higher contrast than those normally produced using black and white (P.109). Produces grainy images similar to those taken with highly sensitive film or high gain film processing.
 Miniaturize	Use to create pictures that appear to be photos of dioramas. For detailed information, see P.79.
 Skew Correct Mode	<p>Use to straighten a rectangular object, such as a message board or business card, shot at an angle to make it look as if it were shot squarely. For detailed operations, see P.81.</p> <div data-bbox="401 404 801 540" data-label="Image"> </div> <p>In skew correction mode, choose from [N1280] or [N640] for [Picture Quality/Size]. (P.101)</p>
 Text Mode	<p>Use when capturing text images, for example notes written on a whiteboard at a meeting. Images are captured in black and white. You can also change the shading of text. (P.82)</p> <p>You can set the image size to either 3456 × 2592 or 2048 × 1536 pixels. (P.101)</p>



Caution

In [Discreet Mode], the camera does not beep, flash mode can not be selected with the ADJ./OK button, and the self-timer lamp and beep indicator are disabled in self-timer mode.



Note

For information on the shooting menu items in scene mode, see P.99.

1 Turn the mode dial to SCENE.

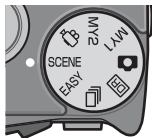

- The camera is ready to shoot and the selected scene mode is displayed at the top of the picture display.

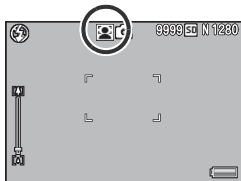

2 Press the MENU button to change the scene mode.

- The scene mode selection screen appears.

3 Press the ADJ./OK button ▲▼◀▶ to select the scene mode.

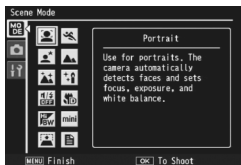

4 Press the ADJ./OK button.

- The scene mode type is displayed at the top of the picture display.

5 Press the shutter release button to shoot the picture.



Changing the shooting menu or setup menu setting in scene mode -----

Press the MENU button in shooting mode and then press the ADJ./OK button ▲▼◀▶ to select the [MODE] tab. Now press the ADJ./OK button ▼ once to display the shooting menu or twice to display the setup menu. See P.100 or P.166 for more information on specifying menu settings.

Using Portrait Mode

1 Turn the mode dial to SCENE.

- The camera is ready to shoot and the selected scene mode is displayed at the top of the picture display.

2 Press the MENU button.

- The scene mode selection screen appears.

3 Press the ADJ./OK button ▲▼◀▶ to select [Portrait].

4 Press the ADJ./OK button.

5 Compose your picture.

- When a face is recognized, a frame with the size of the recognized face is displayed in blue.
- Up to eight frames can be displayed.

6 Half-press the shutter release button.

- Even if several faces are recognized, the camera selects the optimal focus. When a recognized face is focused, the frame for that face is displayed in green. If the camera cannot focus on a recognized face, the frame for that face disappears.
- The exposure and white balance are locked.

7 Gently press the shutter release button all the way.

Caution-----

The camera may not be able to recognize faces in the following cases:

- When the face is side-view, tilted, or moving
- When the camera is tilted or upside down (the shutter release button is facing down)
- When part of the face is hidden
- When the face is not clearly visible because of dark surroundings
- When the subject is too far away (Make sure that the face appearing in the picture display is vertically longer than 1 block marked by the grid guide  P.56)
- When the face is at the edge of the picture display

Shooting in Zoom Macro Mode

1 Turn the mode dial to SCENE.

- The camera is ready to shoot and the selected scene mode is displayed at the top of the picture display.

2 Press the MENU button.

- The scene mode selection screen appears.

3 Press the ADJ./OK button $\blacktriangle \blacktriangledown \blacktriangleleft \blacktriangleright$ to select [Zoom Macro].

4 Press the ADJ./OK button.

5 Turn the zoom lever toward $[\blacktriangle]$ (Telephoto) or $[\blacktriangledown]$ (Wide-angle).

- The zoom level appears on the picture display.

6 Compose your picture and half-press the shutter release button.

7 Full-press the shutter release button.

Caution-----

- If zoom macro mode is selected when the zoom position is set to the wide-angle side (28 mm focal length*), the zoom position is automatically fixed at 70 mm*. (* Equivalent to that on a 35 mm camera)
- When using the zoom macro, you can shoot close-ups within the following distances:

Focal Length ^(*)	Minimum Shooting Distance (from the front of the lens)	Shooting Range
70 mm	Approx. 1 cm	Approx. 19 mm × 14 mm (when digital zoom is not used)
335 mm	Approx. 1 cm	Approx. 4.0 mm × 3.0 mm (when 4.8× digital zoom is used)

^(*) Equivalent to that on a 35 mm camera

- If [Picture Quality/Size] is set to 3456 × 2592 and [Digital Zoom Image] is set to [Auto Resize], the auto resize zoom is activated. (P.185)

Shooting in Miniaturization Mode

This mode creates pictures that appear to be photos of dioramas. It is most effective when pictures are taken from a high vantage point.

1 Turn the mode dial to SCENE.

- The camera is ready to shoot and the selected scene mode is displayed at the top of the picture display.

2 Press the MENU button.

- The scene mode selection screen appears.

3 Press the ADJ./OK button ▲▼◀▶ to select [Miniaturize].

4 Press the ADJ./OK button.

5 Press the Fn button.

- Miniaturization settings will be displayed, with the areas that will not be in focus in the final photograph shown in gray.
- Press the DISP. button to exit without taking a picture.

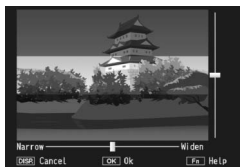

Note

When taking pictures in tall orientation, press the  button to re-orient the area that will be in focus.

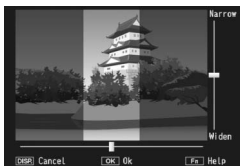

6 Press ADJ./OK button ▲▼ to reposition the area that will be in focus.

- For help, press the Fn button. Press the Fn button again to clear help from the display.

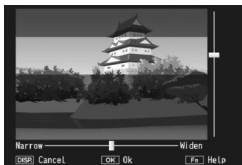

7 Press ADJ./OK button ◀▶ to choose the width of the area that will be in focus.

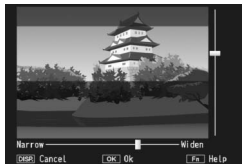

8 Press the ADJ./OK button.

9 Compose your picture and half-press the shutter release button.

10 Press the shutter release button all the way to shoot the picture.



Caution-----

- [Image Settings] is not available in miniaturization mode.
- The focus of the final image differs slightly from that in the image displayed immediately after shooting.

Using Skew Correction Mode

1 Turn the mode dial to SCENE.

- The camera is ready to shoot and the selected scene mode is displayed at the top of the picture display.



2 Press the MENU button.

- The scene mode selection screen appears.

3 Press the ADJ./OK button to select [Skew Correct Mode].

4 Press the ADJ./OK button.

5 Press the shutter release button to shoot the picture.

- The display indicates that the image is being processed, and then the area recognized as the correction range is displayed with an orange frame. Up to five areas can be recognized.
- If the target area cannot be detected, an error message appears. The original image remains unchanged.
- To select another correction area, move the orange frame to the target area by pressing the ADJ./OK button .
- To cancel skew correction, press the ADJ./OK button . Even if you cancel skew correction, the original image remains unchanged.

6 Press the ADJ./OK button.

- The display indicates that the image is being corrected, and then the corrected image is recorded. The original image remains unchanged.

Caution-----

When [Skew Correct Mode] is selected, note the following:

- To shoot the subject as large as possible, position it so that the entire portion of the subject is visible on the picture display.
- The camera may fail to recognize the subject in the following cases:
 - When the image is out of focus
 - When four edges of the subject are not clearly visible
 - When it is hard to distinguish between the subject and background
 - When the background is complicated
- Two images, one before correction and the other after correction, are recorded. If the number of remaining shots is less than two, you cannot shoot the subject.
- The correction area may not be detected properly if the [Date Imprint] function is activated.

Note-----

You can also correct the skew of a previously shot still image. (P.152)

Changing the Text Density

If you are shooting with [Text Mode] in scene mode, you can use the ADJ./OK button to change the shading of text. You can select from [Deep], [Normal] and [Light].

To change the setting, use the shooting menu or the ADJ./OK button. This section explains easy ways to change the setting with the ADJ./OK button. To use the shooting menu, see "Using the Menu" (P.100).

1 Turn the mode dial to SCENE.

2 Press the MENU button.

- The scene mode selection screen appears.

3 Press the ADJ./OK button ▲▼◀▶ to select [Text Mode] and then press the ADJ./OK button.

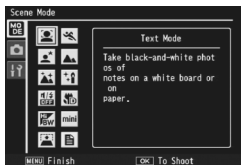

4 Press the ADJ./OK button.

- The text density menu appears.

5 Press the ADJ./OK button ▲▼ to select the desired density setting.

- You can also press the shutter release button to take the picture.



6 Press the ADJ./OK button.

- The text density setting does not appear on the screen.

My Settings Mode (MY1/MY2)

Setting the mode dial to MY1 or MY2 allows you to shoot with preset settings. Use [Reg. My Settings] on the setup menu to make the MY1 and MY2 settings. (☞ P.171)

1 Turn the mode dial to MY1 or MY2.

- Turn the mode dial to MY1 to make the settings for [MY1] in [Reg. My Settings].
- Turn the mode dial to MY2 to make the settings for [MY2] in [Reg. My Settings].

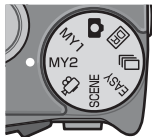

2 Press the shutter release button.



Note

You can change the camera settings even in My Settings mode. Changing the mode or turning the camera off returns the changed settings to the original MY1 and MY2 settings.

Dynamic Range Double Shot Mode (DR)

The “dynamic range” of a digital camera refers to the range of brightness that can be processed by the camera.

When you shoot a scene with high contrast, such as both a subject in sunlight and a subject in a shaded area, the bright areas appear overly bright and the image does not look natural. This is because the range of brightness that can be processed by the camera is narrower than that of the human eye.

When you set the mode dial to DR and shoot, the scene is reproduced with a smooth transition from the bright areas to the dark areas, allowing you to capture a more natural-looking image.

3

Shooting Mode Types



Note

With Dynamic Range Double Shot, two consecutive pictures are taken with different exposures and then the areas with the appropriate exposure are combined together. This mode uses a longer shooting time than other modes, so be careful of camera shake when taking pictures. The  symbol is always displayed.

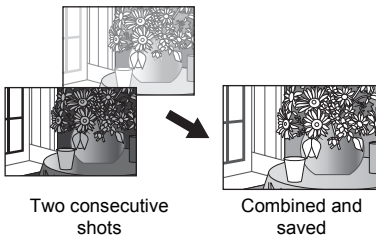

- 1 Turn the mode dial to DR.
- 2 Press the shutter release button to shoot the picture.

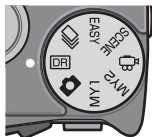



Caution

- The digital zoom is disabled.
- The flash cannot be used.
- [Continuous AF] is not available for [Focus] (P.103).
- Dynamic range double shot may not be effective if the shooting location is overly bright or dark.
- [Multi] metering is recommended.
- When shooting a fast-moving subject, the subject may be distorted in the recorded image.
- Flicker from fluorescent lights may appear as horizontal bands. Fluorescent lighting may also affect colors and brightness.

Dynamic Range Expansion Effect

You can select from five dynamic range expansion effects, from [AUTO], [Very Weak], [Weak], [Medium], or [Strong]. The stronger the expansion effect, the wider the range of brightness that can be processed by the camera.

- 1 Turn the mode dial to [DR].**
- 2 Display the shooting menu.**
 - For the operating procedure, see P.100.
- 3 Press the ADJ./OK button ▼ to select [Dynamic Range Expansion] and press the button ►.**
- 4 Press the button ▲▼ to select the setting and then press the ADJ./OK button.**

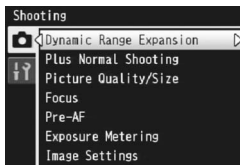

Caution

If [AE Lock] is assigned to the Fn button, exposure can not be locked when [AUTO] is selected for [Dynamic Range Expansion].

Dynamic Range Expansion Plus Normal Shooting

This records two images, an image taken with expanded dynamic range and an image taken with normal shooting.

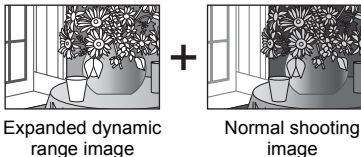

1 Turn the mode dial to **[DR]**.

2 Display the shooting menu.

- For the operating procedure, see P.100.

3 Press the **ADJ./OK** button **▼** to select **[Plus Normal Shooting]** and press the button **▶**.

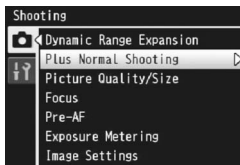

4 Press the button **▲▼** to select **[On]** and then press the **ADJ./OK** button.

5 Press the shutter release button to shoot the picture.

- The confirmation screen displays a comparison of the image taken with normal shooting and the image taken with expanded dynamic range.

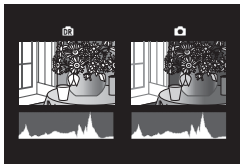

Note

The histogram display for both images is displayed on the confirmation screen in Step 5. When **[LCD Confirmation Time]** is set to **[Hold]** (P.182), the confirmation screen remains displayed so you can confirm the histograms and easily compare the images.

Continuous Mode (📷)

Turn the mode dial to 📷 to use the various continuous shooting functions.



Caution

The time until image recording is complete may be longer when using the internal memory.



Note

- The flash cannot be used.
- The camera shake correction function cannot be used in continuous mode. If you set the mode dial to 📷 while the camera shake correction function is enabled, 📷 disappears from the picture display.
- The focus, exposure value, and white balance are locked in continuous mode.
- ISO sensitivity is raised in continuous shooting mode.
- When [Card Sequence No.] is set to [On] (📷 P.193) and the last four digits of the file number exceed "9999" during continuous shooting, a separate folder is created in the SD memory card and successive pictures taken in continuous mode are stored in this folder.



Changing settings on the shooting menu or setup menu during continuous mode

Press the MENU button in shooting mode and then press the ADJ./OK button ▲▼◀▶ to select the [MODE] tab. Now press the ADJ./OK button ▼ once to display the shooting menu or twice to display the setup menu. See P.100 or P.166 for more information on specifying menu settings.

Normal Continuous Mode

This is the normal continuous mode. Pictures continue to be taken for as long as you hold down the shutter release button. Images are recorded one at a time, just as in normal shooting.

1 Turn the mode dial to 📷.

2 Press the MENU button.

- The continuous mode selection screen appears.

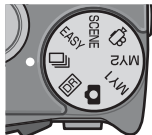

- 3** Press the ADJ./OK button ▲▼ to select [Continuous Mode] and then press the ADJ./OK button.

- The symbol appears on the screen.

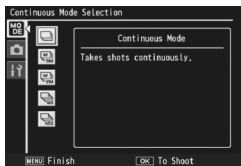

- 4** Compose your picture and then press and hold the shutter release button.

- Pictures continue to be taken for as long as you hold down the shutter release button.

- 5** Release your finger from the shutter release button to stop shooting continuously.

Caution-----

The maximum number of images that can be shot in continuous mode is 999. Even if there is space in the memory for 1,000 or more images, [999] is displayed on the screen.

Note-----

The number of images that can be shot in continuous mode depends on the image size setting. (☞ P.232)

M-Cont Plus (9M)

In this mode, the camera shoots while the shutter-release button is pressed, but only the last 15 frames (about the last three seconds of shooting) are recorded to create a single multi-picture (MP) file.

(2) ...the camera records the frames taken in the last three seconds.

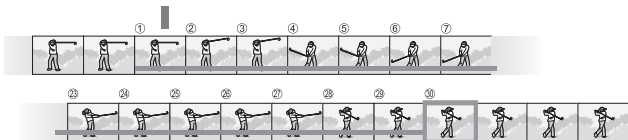

(1) When you remove your finger from the shutter release button...

1 Turn the mode dial to .

2 Press the MENU button.

- The continuous mode selection screen appears.

3 Press the ADJ./OK button   to select [M-Cont Plus (9M)].

4 Press the ADJ./OK button.

- The symbol appears on the screen.

5 Compose your picture and then press and hold the shutter release button.

- The camera memorizes the scene while you hold down the shutter release button.



6 Release your finger from the shutter release button.

- Shooting ends and the last 15 shots (about the last three seconds of shooting) are recorded in a single MP file.
- If you remove your finger from the shutter-release button before 15 shots are recorded, the MP file will contain all the shots taken while the shutter-release button was pressed.



Caution

The time needed to record 15 frames may increase if lighting is poor.



Note

- Image size is fixed at N3456 (9M).
- The date and orientation of each shot in the sequence are recorded separately.



MP file

MP is a file format for recording a set of still images.

M-Cont Plus (2M)

In this mode, the camera shoots while the shutter-release button is pressed, but only the last 30 frames (about the last second of shooting) are recorded to create a single multi-picture (MP) file.

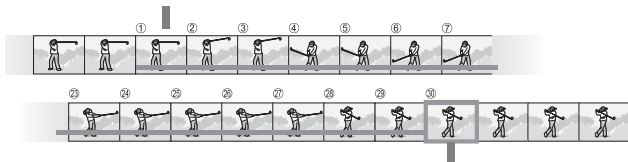

(2) ...the camera records the frames taken in the last second.



(1) When you remove your finger from the shutter release button...

3

Shooting Mode Types

- 1 Turn the mode dial to .
- 2 Press the MENU button.
 - The continuous mode selection screen appears.
- 3 Press the ADJ./OK button   to select [M-Cont Plus (2M)].
- 4 Press the ADJ./OK button.
 - The symbol appears on the screen.
- 5 Compose your picture and then press and hold the shutter release button.



- 6 Release your finger from the shutter release button.
 - Shooting ends and the last 30 shots (about the last second of shooting) are recorded in a single MP file.
 - If you remove your finger from the shutter-release button before 30 shots are recorded, the MP file will contain all the shots taken while the shutter-release button was pressed.



Caution

- When shooting a fast-moving subject, the subject may be distorted in the recorded image.
- Flickering may be recorded as a horizontal band when shooting under fluorescent lights.
- Date imprint is not available.



Note

- The image size is fixed at N1728 (2M).
- The date and orientation of the last shot in the sequence are also used for the remaining frames.







MP file

MP is a file format for recording a set of still images.

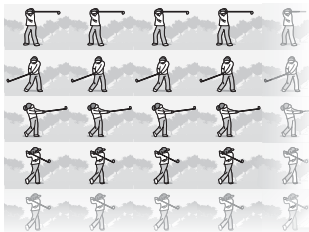
Speed Cont

Speed Cont allows you to record 120 consecutive images in the (approx.) 1 second (120 frames per second) or 120 consecutive images in the (approx.) 2 seconds (60 frames per second) from when the shutter release button is pressed. The consecutively shot still images are grouped together as a set and are recorded as one MP file.



- 1 Turn the mode dial to .
- 2 Press the MENU button.
 - The continuous mode selection screen appears.
- 3 Press the ADJ./OK button   to select either of the following.

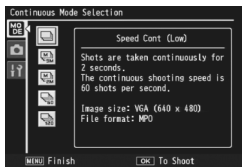

- [Speed Cont (Low)] :
120 consecutive images are recorded in 2 seconds.
- [Speed Cont (High)] :
120 consecutive images are recorded in 1 second.

- 4 Press the ADJ./OK button.
 - The symbol appears on the screen.
- 5 Compose your picture and then press the shutter release button.
 - 120 consecutive images are taken automatically.
 - If you remove your finger from the shutter-release button before 120 shots are recorded, the MP file will contain all the shots taken while the shutter-release button was pressed.



Caution

- When shooting a fast-moving subject, the subject may be distorted in the recorded image.
- Flickering may be recorded as a horizontal band when shooting under fluorescent lights.



Note

- The image size is fixed at N640 (VGA).
- The date and orientation of the last shot in the sequence are also used for the remaining frames.



MP file

MP is a file format for recording a set of still images.

Movie Mode (📹)

Shooting Movies

You can shoot movies with sound.

You can set the image size to either 640 × 480 or 320 × 240 pixels. You can set the number of frames shot per second (frame rate) to either 30 or 15.

Each movie you shoot is recorded as an AVI file.

1 Turn the mode dial to 📹.

2 Press the shutter release button to start recording the movie.

- A blinking [● REC] icon, the recording time, and the time available are displayed during recording.

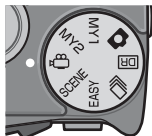

3 Press the shutter release button to finish recording the movie.

⚠ **Caution**-----





- While shooting movies, operation sounds may be recorded.
- The maximum recording time per shooting depends on the size of your SD memory card (📖 P.96). Even if you are within the maximum recording time, recording may end depending on your card.
- The maximum recording time per shooting is 90 minutes or the equivalent of 4 GB.
- The camera shake correction function does not work in movie mode. If you set the mode dial to 📹 while the camera shake correction function is enabled, 📷 disappears from the picture display.
- When shooting a fast-moving subject, the subject may be distorted in the recorded image.
- Flickering may be recorded as a horizontal band when shooting under fluorescent lights.

**Note**

- The flash cannot be used.
- While shooting movies, only digital zoom can be used (up to 4.0×). (☞ P.40)
- When the shutter release button is pressed in Step 2, the camera focuses on the subject.
- The remaining recording time may not change uniformly because it is recalculated from the remaining memory capacity during movie recording.
- Use the shooting menu to set the image size and frame rate of movies.
- The shooting menu items for movie mode differ from those in still image mode. (☞ P.98)
- Depending on the remaining battery level, the battery may become depleted during movie shooting. Use of a battery with adequate remaining power is recommended.
- Use of a high speed SD memory card with sufficient memory is recommended when shooting for long periods.

Setting the Frame Rate

You can select the number of shot frames per second (frame rate) in movie mode.

- 1 Turn the mode dial to .**
- 2 Press the MENU button.**
 - The shooting menu is displayed.
- 3 Press the ADJ./OK button  to select [Frame Rate] and press the button .**
- 4 Press the button  to select [30 Frames/Sec] or [15 Frames/Sec].**
- 5 Press the ADJ./OK button.**
 - The setting appears on the screen.

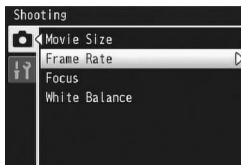
**Movie Frames**

Movies consist of many frames whose images appear to be moving when displayed at high speed.

**Note**







- Movie recording time may vary depending on the capacity of the recording destination (internal memory or SD memory card), shooting conditions, and the type and manufacturer of the SD memory card.
- The estimated total recording time is shown below. The maximum recording time per shooting is 90 minutes or the equivalent of 4 GB.

	Internal Memory	1 GB	2 GB	4 GB	8 GB	16 GB	32 GB
640 × 480 (15 Frames/Sec)	1 min	18 min	37 min	76 min	149 min	299 min	601 min
	42 s	20 s	17 s	41 s	40 s	50 s	28 s
640 × 480 (30 Frames/Sec)	51 s	9 min	18 min	38 min	75 min	151 min	303 min
		15 s	49 s	41 s	31 s	18 s	31 s
320 × 240 (15 Frames/Sec)	4 min	46 min	94 min	193 min	378 min	757 min	1519 min
	19 s	19 s	11 s	41 s	2 s	18 s	7 s
320 × 240 (30 Frames/Sec)	2 min	23 min	48 min	99 min	193 min	387 min	777 min
	12 s	42 s	13 s	8 s	30 s	39 s	37 s

4 Shooting Menu

About the Shooting Menu

Press the MENU button in shooting mode to display the shooting menu. The shooting menu can be used to set the following shooting settings.

Setting	Options [Default Settings]	Refer to
Dynamic Range Expansion	[AUTO], Very Weak, Weak, Medium, Strong	P.84
Plus Normal Shooting	[Off], On	P.86
Picture Quality/Size	F3456(9M), [N3456(9M)], F3:2(8M), F1:1(6M), N3072(7M), N2592(5M), N2048(3M), N1280(1M), N640(VGA)	P.101
Movie Size	[640], 320	P.101
Frame Rate	[30 Frames/Sec], 15 Frames/Sec	P.95
Density	Deep, [Normal], Light	P.82
Size	[3456(9M)], 2048(3M)	P.101
Focus	[Multi AF], Spot AF, Continuous AF, Multi-trgt AF, MF, Snap, ∞	P.103
Pre-AF	[Off], On	P.107
Exposure Metering	[Multi], Center, Spot	P.108
Image Settings	Vivid, [Standard], Cust. Settings, Black & White, Sepia	P.109
Flash Exposure Compensation	+2.0, +1.7, +1.3, +1.0, +0.7, +0.3, [0.0], -0.3, -0.7, -1.0, -1.3, -1.7, -2.0 (1/3EV increments)	P.111
Auto Bracket	[Off], On, WB-BKT, CL-BKT, FOCUS-BKT	P.112
Time Exposure	[Off], 1 second, 2 seconds, 4 seconds, 8 seconds	P.117
Custom Self-Timer	Pictures (1 to 10 pictures [2 Pics]), Interval (5 to 10 seconds [5 Sec.])	P.118
Interval Shooting	[0 Sec.], 5 seconds to 1 hour	P.119
Camera Shake Correction	Off, [On]	P.121
Slow Shutter Limit	[Off], 1/2Sec., 1/4Sec., 1/8Sec.	P.122
Date Imprint	[Off], Date, Date and Time	P.123
Exposure Compensation	+2.0, +1.7, +1.3, +1.0, +0.7, +0.3, [0.0], -0.3, -0.7, -1.0, -1.3, -1.7, -2.0 (1/3EV increments)	P.124
White Balance	Auto, [Multi-P AUTO],  (Outdoors),  (Cloudy),  (Incandescent Lamp),  (Incandescent Lamp 2),  (Fluorescent Lamp),  (Manual Settings)	P.126

Setting	Options [Default Settings]	Refer to
ISO Setting	[Auto], Auto-Hi, ISO 80, ISO 100, ISO 200, ISO 400, ISO 800, ISO 1600	P.128
Restore Defaults	_____	P.130



Available Settings for Each Shooting Mode -----

T displayed items vary depending on the shooting mode. See the following table. Refer to P.99 for more information on the items that can be set for each scene mode.

Setting		SCENE	EASY		DR	
Picture Quality/Size	○	○	○	○	○	-
Movie Size	-	-	-	-	-	○
Frame Rate	-	-	-	-	-	○
Focus	○	○	-	○	○	○
Pre-AF	○	○	-	○	○	○
Density	-	○	-	-	-	-
Size	-	○	-	-	-	-
Exposure Metering	○	○	-	○	○	-
Image Settings	○	○	-	○	○	-
Flash Exposure Compensation	○	○	-	-	-	-
Auto Bracket	○	○	-	-	-	-
Dynamic Range Expansion	-	-	-	-	○	-
Plus Normal Shooting	-	-	-	-	○	-
Time Exposure	○	○	-	-	-	-
Custom Self-Timer	○	○	-	-	○	-
Interval Shooting	○	-*	-	-	○	-
Camera Shake Correction	○	○	-	-	○	-
Slow Shutter Limit	○	○	-	○	-	-
Date Imprint	○	○	○	○	○	-
Exposure Compensation	○	○	-	○	○	-
White Balance	○	○	-	○	○	○
ISO Setting	○	○	-	○	-	-
Restore Defaults	○	-*	-	-	-	-

* [Discreet Mode] only.



When Mode Dial is Set to SCENE-----

When the mode dial is set to SCENE, the displayed items differ depending on the selected scene mode. See the following table.

Setting	Portrait	Sports	Night. Port.	Landscape	Nightscape	High Sens	Discreet Mode	Zoom Macro	High Contrast B&W	Miniaturize	Skew Correct Mode	Text Mode	Refer to
Picture Quality/Size	O	O	O	O	O	O	O	O	O	O	O	-	P.101
Density	-	-	-	-	-	-	-	-	-	-	-	O	P.82
Size	-	-	-	-	-	-	-	-	-	-	-	O	P.101
Focus	-	O	O	-	O	O	O	O	O	O	O	-	P.103
Pre-AF	-	O	O	-	O	O	O	O	O	O	O	-	P.107
Exposure Metering	-	-	-	-	-	-	O	O	-	-	O	-	P.108
Image Settings	-	-	-	-	-	-	O	O	-	-	O	-	P.109
Flash Exposure Compensation	O	O	-	-	O	O	O	O	O	O	O	-	P.111
Auto Bracket	-	-	-	-	-	-	O	O	-	-	-	-	P.112
Time Exposure	-	-	-	-	-	-	O	O	-	-	-	-	P.117
Custom Self-Timer	O	O	O	O	O	O	O	O	O	O	-	O	P.118
Interval Shooting	-	-	-	-	-	-	O	-	-	-	-	-	P.119
Camera Shake Correction	O	O	O	O	O	O	O	O	O	O	O	O	P.121
Slow Shutter Limit	O	O	O	O	O	O	O	O	O	O	O	O	P.122
Date Imprint	O	O	O	O	O	O	O	O	O	O	O	O	P.123
Exposure Compensation	O	O	O	O	O	O	O	O	O	O	O	-	P.124
White Balance	-	O	O	O	O	O	O	O	-	O	O	-	P.126
ISO Setting	O	-	-	-	-	-	O	O	-	-	O	-	P.128
Restore Defaults	-	-	-	-	-	-	O	-	-	-	-	-	P.130

O Available, - Not available



Note-----

The setup menu can be accessed from within the shooting menu. (P.165)

Using the Menu

In the instructions of this manual, the menu selection is confirmed when you “Press the ADJ./OK button” (as in Step 5 below), but you can also confirm the setting and return to the menu screen by pressing the ADJ./OK button ◀.

1 Press the MENU button in shooting mode.

- The shooting menu is displayed.
- In scene mode or continuous mode, press the ADJ./OK button ▲▼◀▶ to select the [MODE] tab, and then press the ADJ./OK button ▼. The shooting menu appears.

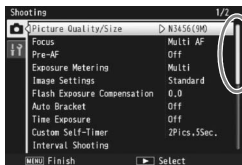

Indicates the range of displayed screens.

2 Press the ADJ./OK button ▲▼ to select the desired menu item.

- If the DISP. button is pressed at this point, the cursor moves to the shooting menu tab.
- Press the ADJ./OK button ▼ at the bottom item to display the next screen.

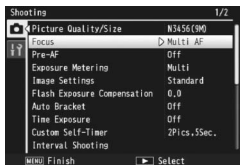

3 Press the ADJ./OK button ▶.

- The menu item settings are displayed.

4 Press the ADJ./OK button ▲▼ to select the setting.

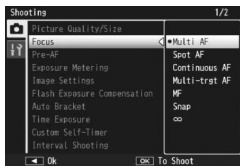

5 Press the ADJ./OK button.

- The setting is confirmed, the shooting menu disappears and the camera is ready to shoot.
- Pressing the ADJ./OK button ◀ in Step 5 confirms the setting and the display returns to the screen shown in Step 2.

Picture Quality Mode/Image Size

The file size of a shot still image depends on the picture quality mode and image size settings. For movies, choose the movie size. Figures inside the bold frame indicate those shown on the screen.

Still Images

Image Size	Picture Quality Mode	Picture Quality/Size	Remarks
3456 × 2592	F (Fine) N (Normal)	F3456(9M) N3456(9M)	<ul style="list-style-type: none">• For creating large prints.• For downloading to a computer for trimming and other processes.
3456 × 2304	F (Fine)	F3:2(8M)	
2592 × 2592	F (Fine)	F1:1(6M)	
3072 × 2304	N (Normal)	N3072(7M)	
2592 × 1944	N (Normal)	N2592(5M)	<ul style="list-style-type: none">• For creating prints.
2048 × 1536	N (Normal)	N2048(3M)	
1280 × 960	N (Normal)	N1280(1M)	<ul style="list-style-type: none">• For shooting a large number of pictures.• For shooting a large number of pictures.• For attaching to e-mail.• For posting on a website.
640 × 480	N (Normal)	N640(VGA)	

- When scene mode is set to [Skew Correct Mode], you can select 1280 × 960 or 640 × 480.
- When scene mode is set to [Text Mode], you can select 3456 × 2592 or 2048 × 1536.

Movies

Image Size	Movie Size
640 × 480	640
320 × 240	320

- You can also choose the number of frames for movies. (🔍 P.95)

**Note**

- For picture quality mode, select normal mode (N) or fine mode (F), depending on the desired compression ratio.
Normal mode: The compression ratio is high, resulting in a small file. Normally, shooting is done in this mode.
Fine mode: The compression ratio is low, resulting in a large file, but the picture quality is better than in Normal.
- The number of images that can be stored in the internal memory or SD memory card depends on the [Picture Quality/Size] setting. (P.232)

1 Display the shooting menu.

- For information on using the menu, see P.100.

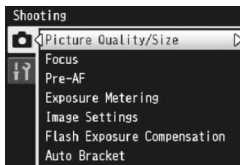
2 Check that [Picture Quality/Size] is selected and press the ADJ./OK button ►.**3 Press the button ▲▼ to select the desired setting.**

Still Images

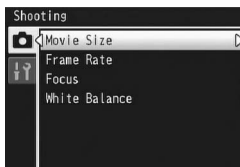

Movies





4 Press the ADJ./OK button.

- The setting appears on the screen.

Focusing Modes

If you shoot the subject in the default focusing mode, the camera focuses automatically with Auto Focus (AF). Select from the following 7 focusing modes.

Focusing Modes

Symbol	Mode	Description
None	Multi AF	Measures the distances from 9 AF areas and focuses to the nearest AF area. This prevents the center of the picture display from becoming out of focus and enables you to shoot with a minimum number of out-of-focus pictures.
None	Spot AF	Selects one AF area at the center of the picture display to allow the camera to focus on this area automatically.
	Continuous AF	Measures the distance from the center AF area and focuses on the subject in the center area. If the subject moves while the shutter-release button is pressed halfway, the camera will track the subject while focusing continuously.
	Multi-trgt AF	Takes 7 consecutive pictures while shifting the focus to multiple positions. (P.104)
	MF (Manual Focus)	Enables you to adjust the focus manually. (P.105)
	Snap	Fixes the shooting distance to a short distance (approx. 2.5 m (8.2 ft.)).
	∞ (Infinity)	Fixes the shooting distance to infinity. Infinity is useful for shooting distant scenes.

1 Display the shooting menu.

- For information on using the menu, see P.100.

2 Press the ADJ./OK button ▼ to select [Focus] and press the button ►.

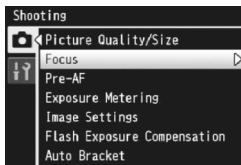

3 Press the button ▲▼ to select the desired setting.

4 Press the ADJ./OK button.

- If you select a setting other than [Multi AF] or [Spot AF], a symbol appears on the screen.



Note

- If [Focus] is set to [Multi AF] when using the digital zoom, [Focus] functions according to the [Spot AF] setting.
- [Continuous AF] is not available in dynamic range double shot mode.

Multi-Target AF





When you half-press the shutter release button, the camera automatically determines multiple focus positions. When you then press the shutter release button all the way down, the camera shifts among the different focus positions, taking 7 consecutive pictures. The 7 still images are grouped together as a set and are recorded as an MP file.

This function is especially useful for telephoto shooting and shooting with macro mode.





4

Shooting Menu

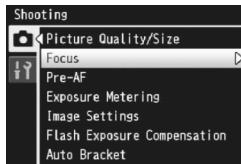
- 1** Turn the mode dial to .
- 2** Display the shooting menu.
 - For information on using the menu, see P.100.
- 3** Press the ADJ./OK button  to select [Focus] and press the button .
- 4** Press the button  to select [Multi-trgt AF] and then press the ADJ./OK button.
 - The symbol appears on the screen.



5 Compose your picture and half-press the shutter release button.

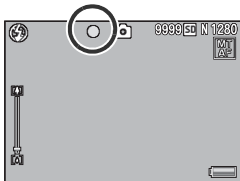

- The camera automatically detects multiple focus positions.
- The  symbol appears on the screen when a focus position is detected.
- The determined focus positions are displayed only during playback. (P.134)
- If the focus position cannot be detected, the  symbol blinks on the screen.



6 Press the shutter release button all the way down.

- Consecutive shooting starts, and when the 7 frames are shot, they are recorded as one MP file.

Caution

- This function is only available in auto shooting mode.
- The flash cannot be used.
- The [Time Exposure] setting is disabled. (P.117)
- The camera shake correction function cannot be used. If [Multi-trgt AF] is set while the camera shake correction function is turned on,  changes to .

Note

- If this function is turned on when using the digital zoom, the digital zoom is disabled and shooting is performed at the maximum magnification for the optical zoom (10.7×).
- [White Balance] functions according to the [Auto] setting even if it is set to [Multi-P AUTO].

MP file

MP is a file format for recording a set of still images.

Manual Focus (MF)

If the camera fails to focus automatically, you can focus manually (MF: Manual Focus).

Manual focus enables shooting at a fixed distance.

1 Display the shooting menu.

- For information on using the menu, see P.100.

2 Press the ADJ./OK button ▼ to select [Focus] and press the button ►.

3 Press the button ▲▼ to select [MF].

4 Press the ADJ./OK button.

- [MF] and the focus bar are displayed on the screen.

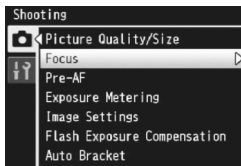

5 Press and hold the ADJ./OK button as required.

- Pressing and holding the ADJ./OK button increases the magnification only at the center of the screen.
- Pressing and holding the ADJ./OK button again returns from enlarged view to normal view.

6 Adjust the zoom position with the zoom lever as required.

- The zoom bar is displayed only when operating the zoom lever.

7 Press the ADJ./OK button ▲▼ to adjust the focus.

- Pressing the ADJ./OK button ▲ adjusts the focus to farther objects.
- Pressing the ADJ./OK button ▼ adjusts the focus to closer objects.

8 Press the shutter release button to shoot the picture.

Note-----

- In scene mode, manual focus can be used when [Discreet Mode], [Zoom Macro], or [Skew Correct Mode] is selected.
- You can also use manual focus to focus on objects within the macro shooting range.

Pre-AF

If [On] is selected when [Multi AF], [Spot AF], [Continuous AF], or [Multi-trgt AF] is selected for [Focus] (☞ P.103), the camera will continue to focus even when the shutter-release button is not pressed halfway. This may decrease the time needed to focus when a picture is taken, potentially improving shutter response.

1 Display the shooting menu.

- For information on using the menu, see P.100.

2 Press the ADJ./OK button ▼ to select [Pre-AF] and press the button ►.

3 Press the button ▲▼ to select the desired setting.

4 Press the ADJ./OK button.

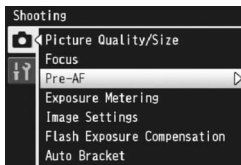

Caution



Pre-AF is not available when [MF], [Snap], or [∞] is selected for [Focus].

Exposure Metering Modes

You can change the metering method (the range to use for metering) used to determine the exposure value.

There are three light metering modes.

Exposure Metering Modes

Symbol	Mode	Description
(None)	Multi	The entire shooting range is divided into 256 partitions, and each is metered to determine the overall exposure value.
	Center	The entire image is metered, with emphasis on the center, to determine the exposure value. Use this when the brightness of the center and surroundings are different.
	Spot	Only the center of the image is metered to determine the exposure value. Use this setting when you want to use the brightness at the center. This is useful if there is a marked difference in contrast or backlighting.

4

Shooting Menu

1 Display the shooting menu.

- For information on using the menu, see P.100.

2 Press the ADJ./OK button ▼ to select [Exposure Metering] and press the button ►.

3 Press the button ▲▼ to select the desired setting.

4 Press the ADJ./OK button.

- If you select a setting other than [Multi], a symbol appears on the screen.

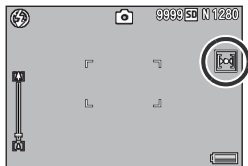
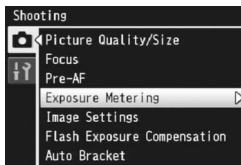

Picture Quality and Color

You can change the picture quality of an image, including the contrast, sharpness, color and vividness.

You can select from the following picture quality settings.

Picture Quality Modes

Type	Description
Vivid	Take strong, vivid photos with higher contrast and sharpness and maximum vividness.
Standard	Creates an image with normal picture quality.
Cust. Settings	You can select from five [Contrast], [Sharpness], and [Vividness] levels. (☞ P.110)
Black & White	Creates a black and white picture.
Sepia	Creates a sepia-toned picture.

1 Display the shooting menu.

- For the operating procedure, see P.100.

2 Press the ADJ./OK button ▼ to select [Image Settings] and press the button ►.

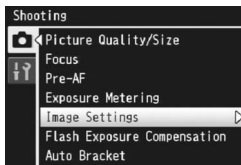

3 Press the button ▲▼ to select the desired picture quality.

- You can set values for [Cust. Settings] (☞ P.110). If the values are already set, you can set the picture quality by simply selecting [Cust. Settings].

4 Press the ADJ./OK button.

- If you selected a setting other than [Standard], the symbol appears on the screen.

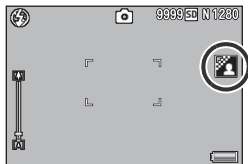

Note

[Color], [Black & White], and [Sepia] can be selected in dynamic range double-shot mode.

Custom Settings

- 1 Display the shooting menu.**
 - For the operating procedure, see P.100.
- 2 Press the ADJ./OK button ▼ to select [Image Settings] and press the button ►.**
- 3 Press the button ▲▼ to select [Cust. Settings] and press the button ►.**
 - The [Image Settings] screen appears.
 - If the values are already set, you can set the picture quality by selecting [Cust. Settings].
- 4 Press the ADJ./OK button ▲▼ to select [Contrast], [Sharpness], and [Vividness], and press the button ◀► to adjust the settings.**
- 5 Press the ADJ./OK button.**
 - The [Cust. Settings] setting is saved, and the display returns to the shooting menu.
- 6 Press the ADJ./OK button.**
 - The symbol appears on the screen.

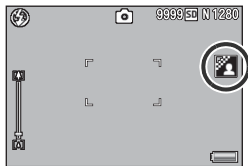
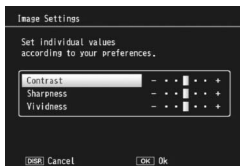

Flash Exposure Compensation

You can adjust the light intensity of the flash. You can set the light intensity from -2.0 EV to +2.0 EV in increments of 1/3 EV.

1 Display the shooting menu.

- For the operating procedure, see P.100.

2 Press the ADJ./OK button ▼ to select [Flash Exposure Compensation] and press the button ►.

- The flash exposure compensation bar appears.

3 Press the button ▲▼ to make the setting.



4 Press the ADJ./OK button.

- The setting appears on the screen except when the flash mode is set to [Flash Off].

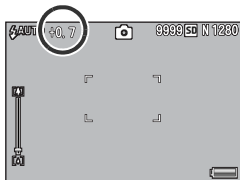

Note

For information on how to use the flash, see P.43.



Caution

Flash exposure compensation may not work outside the flash range (👉 P.43).

Bracket Shooting

Bracket shooting is the function for performing automatic consecutive shooting while changing the exposure, white balance, color, or focus position.



Note

- This function is not available in dynamic range double-shot mode, easy shooting mode, and continuous mode.
- Bracket shooting is not available when [Focus] is set to [Multi-trgt AF].
- The flash cannot be used.
- The [Time Exposure] setting is disabled. (P.117)
- Assigning [AT-BKT], [WB-BKT], [CL-BKT], or [FOCUS-BKT] to the Fn (Function) button with [Set Fn Button] (P.174) allows you to switch between on and off by pressing the Fn button. (P.66)

Auto Bracketing

4

Shooting Menu

When the auto bracketing function is set to [On], the camera automatically shoots three consecutive shots at three exposure levels (-0.5EV, ±0, and +0.5EV) based on the set exposure level.

1 Display the shooting menu.

- For information on using the menu, see P.100.

2 Press the ADJ./OK button ▼ to select [Auto Bracket] and press the button ►.

3 Press the button ▲▼ to select [On].

4 Press the ADJ./OK button.

- The symbol appears on the screen.

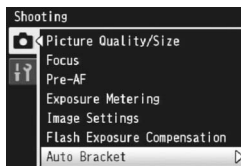

5 Press the shutter release button to shoot the picture.

- Three consecutive shots are taken at ± 0 , -0.5EV , and $+0.5\text{EV}$ based on the set exposure compensation setting. When shooting is completed, three still images are displayed on the picture display. They are, from left to right, at -0.5EV (darker), standard exposure compensation setting, and $+0.5\text{EV}$ (brighter).

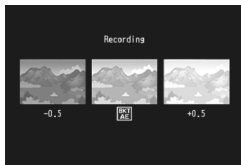

Note

- The exposure compensation can be changed using the shooting menu. (P.124)
- [White Balance] functions according to the [Auto] setting even if it is set to [Multi-P AUTO].

White Balance Bracketing

The white balance bracket function automatically records three images - a reddish image, a bluish image, and an image of the current white balance.

This is useful if you cannot determine the appropriate white balance.

1 Display the shooting menu.

- For information on using the menu, see P.100.

2 Press the ADJ./OK button ▼ to select [Auto Bracket] and press the button ►.

3 Press the button ▲▼ to select [WB-BKT].

4 Press the ADJ./OK button.

- The symbol appears on the screen.

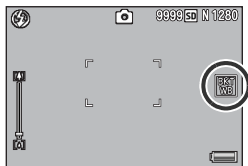
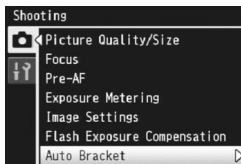

5 Press the shutter release button to shoot the picture.

- Three images (a reddish image, an image equal to the current white balance, and a bluish image) are automatically recorded.

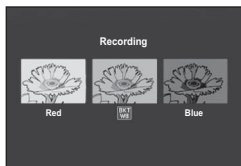

Note

- The white balance can be changed using the shooting menu. (P.126)
- If [Image Settings] is set to [Black & White] or [Sepia], the white balance bracket function can be set but it does not operate.

Color Bracketing

With color bracketing, three images, a black-and-white, a color, and a sepia image, are recorded.

4

Shooting Menu

1 Display the shooting menu.

- For information on using the menu, see P.100.

2 Press the ADJ./OK button ▼ to select [Auto Bracket] and press the button ►.

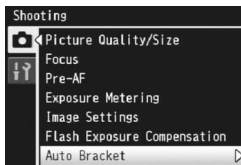

3 Press the button ▲▼ to select [CL-BKT].



4 Press the ADJ./OK button.

- The symbol appears on the screen.

5 Press the shutter release button to shoot the picture.

- Three images, a black-and-white, a color, and a sepia image, are recorded.

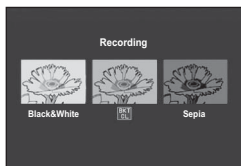



Contrast, Sharpness and Vividness During

Color Bracket Shooting

During color bracket shooting, the contrast, sharpness, and vividness values set in [Image Settings] are applied. However, the values for [Standard] in [Image Settings] apply when [Image Settings] is set to [Black & White] or [Sepia].

Focus Bracketing

Choose this option to automatically vary focus by a selected amount over a series of five photographs.

1 Display the shooting menu.

- For the operating procedure, see P.100.

2 Press the ADJ./OK button ▼ to select [Auto Bracket] and press the button ►.

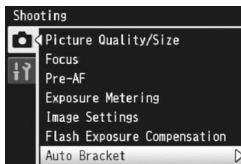

3 Press the button ▲▼ to select [FOCUS-BKT] and press the button ►.

4 Press the ADJ./OK button ◀► to set the interval of the focus position.

5 Press the ADJ./OK button.

- The symbol appears on the screen.

6 Half-press the shutter release button.

- The camera focuses according to the [Focus] setting.



7 Press the shutter release button all the way down.

- The camera takes 5 consecutive pictures based on the focus position in Step 6.

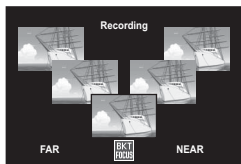

**Note**

- When [Focus] is set to [MF], the first picture is taken at the set focus position without being measured.
- [White Balance] functions according to the [Auto] setting even if it is set to [Multi-P AUTO].
- Photographs are taken and recorded in the following order:

Focus position	Fore		Center *		Back
Shooting order	2	3	1	4	5
Recording order	1	2	3	4	5

*Focus set using the option currently selected for [Focus] (P.103).

Long Time Exposure

You can select [1 second], [2 seconds], [4 seconds], or [8 seconds] for time exposure.

By using long time exposure, you can capture the movement of moving subjects such as the trail of fireworks and car lights when shooting a night scene.

1 Display the shooting menu.

- For information on using the menu, see P.100.

2 Press the ADJ./OK button ▼ to select [Time Exposure] and press the button ►.

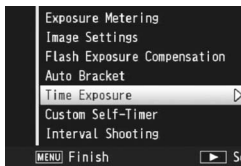

3 Press the button ▲▼ to select the desired setting.

4 Press the ADJ./OK button.



- The setting appears on the screen.



4



Note

- When using long time exposure, the shutter speed may slow down and images may be blurred. Hold the camera steady by using a tripod when shooting.
- The camera shake correction function cannot be used when using long time exposure. If long time exposure is set while the camera shake correction function is turned on,  changes to .
- While shooting with long time exposure, the picture display turns off.
- This function is not available for bracket shooting, multi-target AF, dynamic range double-shot, easy shooting mode, or continuous mode.
- Long time-exposures are processed to reduce noise. The time required for processing is roughly equivalent to the exposure time.
- The maximum ISO sensitivity for long time-exposures is ISO 400. If the value currently selected by the user is between ISO 800 and ISO 1600, the camera will automatically set ISO sensitivity to ISO 400 ( P.128).

Shooting Several Pictures with the Custom Self-Timer

Set the shooting interval and the number of pictures as indicated below when you want to shoot several pictures with the self-timer.

Available Setting	Description
Pictures	Set this between 1 and 10 pictures. The default setting is [2 Pics].
Interval	Set this between 5 and 10 seconds. The default setting is [5 Sec.].

1 Display the shooting menu.

- For the operating procedure, see P.100.

2 Press the ADJ./OK button ▼ to select [Custom Self-Timer] and press the button ►.

- The setting screen appears.

3 Press the button ◀► to select [Pictures] and [Interval], and press the button ▲▼ to make the settings.

4 Press the ADJ./OK button.

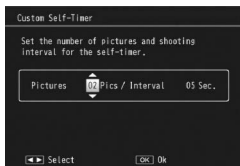

Note

After setting [Custom Self-Timer], with the camera ready to shoot, press the  (Self-Timer) button and change the self-timer setting to [Custom]. For information on how to shoot with this function, see P.45.

Shooting Pictures Automatically at Set Intervals

You can set the camera to automatically take pictures at fixed intervals.

You can set the shooting interval from 5 seconds to 1 hour in increments of 5 seconds.

1 Display the shooting menu.

- For information on using the menu, see P.100.

2 Press the ADJ./OK button ▼ to select [Interval Shooting] and press the button ►.

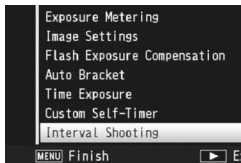

3 Press the button ▲▼ to set the hours.

- To cancel interval shooting, press the DISP. button to return to the shooting menu.

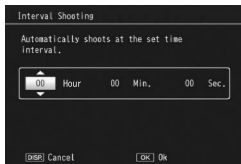

4 Press the button ► to move to the minutes setting, then press the button ▲▼ to set the minutes.

- You can press and hold the button ▲▼ to quickly raise or lower the minute setting.

5 Press the button ► to move to the seconds setting, then press the button ▲▼ to set the seconds.

6 Press the ADJ./OK button.

- [Interval] appears on the screen.

7 Press the shutter release button to shoot the picture.

- A picture is taken every time the fixed interval elapses.



8 To stop shooting, press the MENU button.



Caution

- The interval shooting setting is cleared when the camera is turned off.
- The time until the next picture can be taken according to the shooting menu setting may be longer than the time set for interval shooting. In this case, the shooting interval becomes longer than the set time.



Note

- Interval shooting is not available when [Focus] is set to [Multi-trgt AF].
- Depending on the remaining battery level, the battery may become depleted during movie shooting. Use of a battery with adequate remaining power is recommended.
- If you press the shutter release button during interval shooting, the camera shoots as usual. However, the interval shooting setting is unaffected. After shooting, once the time specified in interval shooting elapses, the next shot is taken.
- A high speed memory card or a SD memory card with sufficient memory is recommended.
- When Interval is set, the self-timer setting is disabled.

Camera Shake Correction

You can prevent camera shake by turning on the camera shake correction function.

At the time of purchase, the camera shake correction function is turned on.

1 Display the shooting menu.

- For information on using the menu, see P.100.

2 Press the ADJ./OK button ▼ to select [Camera Shake Correction] and press the button ►.

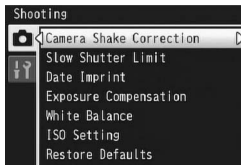

3 Press the button ▲▼ to select [On].

4 Press the ADJ./OK button.

- The symbol appears on the screen.

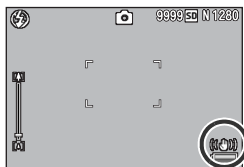

4

Shooting Menu

Caution

- The camera shake correction function is not available for movie mode, continuous mode, multi-target AF and long time exposure. If multi-target AF, or long time exposure is set while the camera shake correction function is turned on, the camera shake correction symbol changes to a symbol with a lightning bolt. The symbol disappears when the mode dial is set to or .
- The camera shake correction function cannot prevent movement of the shooting subject (caused by wind, etc.).
- Effects of the camera shake correction function vary depending on the surroundings.

Note

The symbol appears when camera shake is likely to occur. (P.33)

Limiting the Shutter Speed

The maximum shutter speed can be limited to the following:

1/8 second, 1/4 second, and 1/2 second.

When this function is set to [Off], the maximum shutter speed varies depending on the ISO setting.

1 Display the shooting menu.

- For information on using the menu, see P.100.

2 Press the ADJ./OK button ▼ to select [Slow Shutter Limit] and press the button ►.

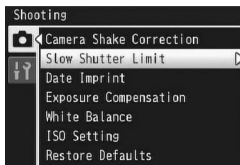

3 Press the button ▲▼ to select the desired setting.

4 Press the ADJ./OK button.



Note

- When time exposure is set, priority is given to time exposure.
- When scene mode is set to [Nightscape] or [Night. Port.], the maximum shutter speed for [Nightscape] or [Night. Port.] is given priority.
- When the flash is set to [Flash Synchro.], the longest shutter speed is one second.
- When using the slow shutter limit, the light quantity may be insufficient depending on the brightness of the subject, resulting in a dark image. In this case, try the following:
 - Selecting a greater slow shutter limit.
 - Raising the ISO setting. (P.128)
 - Using the flash. (P.43)

Imprinting the Date on Images

You can insert the date (YY/MM/DD) or the date and time (YY/MM/DD hh:mm) at the lower right of a still image.

1 Display the shooting menu.

- For information on using the menu, see P.100.

2 Press the ADJ./OK button ▼ to select [Date Imprint] and press the button ►.

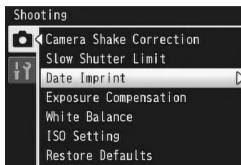

3 Press the button ▲▼ to select the desired setting.

4 Press the ADJ./OK button.

- The symbol appears on the screen.

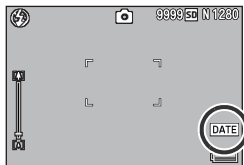

Note

- Make the date and time settings in advance. (☞ P.194)
- [Date Imprint] cannot be used with movies.
- The date imprinted in an image cannot be deleted.

Exposure Compensation

The exposure setting enables you to select the brightness level for your picture. Normally, if your subject is centered, backlight compensation is automatically activated, and you can shoot with the correct exposure.

In the following cases, or when you intentionally want to change the exposure, you can adjust the exposure setting. Exposure can be specified in the range from -2.0 to +2.0. Setting the level higher (+) makes the picture brighter and lower (-) makes the picture darker.

For backlighting

When the background is particularly bright, the subject will appear dark (underexposed). In this case, set the exposure level higher (+).

When your subject is whitish

The entire picture will turn out dark (underexposed). Set the exposure level higher (+).

When your subject is darkish

The entire picture will turn out bright (overexposed). Set the exposure level lower (-).

The same happens when you take a photo of a subject in a spotlight.

To change the setting, use the shooting menu or the ADJ./OK button. This section explains easy ways to change the setting with the ADJ./OK button.

To use the shooting menu, see "Using the Menu" (P.100).

- 1 Press the ADJ./OK button in shooting mode.**
- 2 Press the ADJ./OK button ◀▶ until the exposure compensation bar appears.**
- 3 Press the button ▲▼ to set the exposure value.**
 - You can also press the shutter release button to take a picture.
- 4 Press the ADJ./OK button.**
 - The setting appears on the screen.

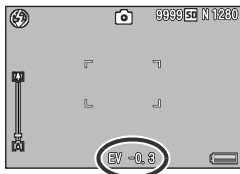







**Note**

If the subject is very bright or very dark, [!AE] will be displayed and exposure compensation will not be available.

White Balance

Adjust the white balance so that a white subject will appear white. At purchase, the white balance mode is set to [Multi-P AUTO]. Change the setting in situations where the white balance is difficult to adjust effectively, such as when shooting an object of a single color or when shooting under multiple light sources.

White Balance Modes

Symbol	Mode	Description
AUTO	Auto	Adjusts the white balance automatically.
	Multi-P AUTO	The camera automatically selects the optimal white balance according to the conditions of sun and shade or the flash illumination range.
	Outdoors	Select this when shooting outdoors (sunny) and white balance fails to adjust properly.
	Cloudy	Select this when shooting in cloudy weather or shade and the white balance fails to adjust properly.
	Incandescent Lamp	Select this when shooting under incandescent light and white balance fails to adjust properly.
	Incandescent Lamp 2	Select this when shooting under incandescent light (more reddish, compared with [Incandescent Lamp]).
	Fluorescent Lamp	Select this when shooting under fluorescent light and white balance fails to adjust properly.
	Manual Settings	Adjust the white balance manually. (P.127)

To change the setting, use the shooting menu or the ADJ./OK button. This section explains easy ways to change the setting with the ADJ./OK button.

To use the shooting menu, see "Using the Menu" (P.100).

- 1 Press the ADJ./OK button in shooting mode.**
- 2 Press the ADJ./OK button ◀▶ until the white balance menu appears.**
- 3 Press the button ▲▼ to select a setting other than [M].**
 - You can also press the shutter release button to take a picture.
- 4 Press the ADJ./OK button.**
 - The symbol appears on the screen.

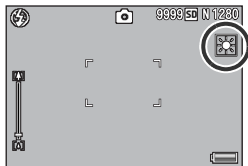



Caution

- White balance is not available when [Black & White] or [Sepia] is selected for [Image Settings] or when [Portrait], [High Contrast B&W] or [Text Mode] is selected in scene mode.
- [Multi-P AUTO] is not available in continuous mode and movie mode.



Note

- The white balance may not be adjusted correctly for a subject that is mostly dark. In this case, add something white to the subject.
- When shooting with the flash, the white balance may not be adjusted correctly if [AUTO] is not selected. In this case, switch to [AUTO] to shoot with the flash.

Manual Settings

- 1 Press the ADJ./OK button in shooting mode.
- 2 Press the ADJ./OK button ◀▶ until the white balance menu appears.
- 3 Press the button ▲▼ to select [M].
- 4 Point the camera at a piece of paper or something white under the lighting conditions for your picture.



- 5 Press the DISP. button.

- The white balance is set.

- 6 Press the ADJ./OK button.

- The symbol appears on the screen.
- The screen is displayed with the white balance set in Step 5. If the result is not as expected, repeat the steps to change the settings as many times as required.

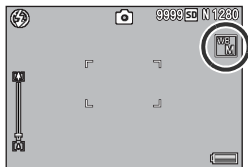

Note

To cancel [Manual Settings], select a setting other than [M] in Step 3.

ISO Sensitivity

ISO sensitivity indicates how sensitive film is to light. A greater value means higher sensitivity. High sensitivity is suitable for shooting an object in a dark place or a fast-moving object while minimizing blurring.

You can select from the following ISO settings:

Auto, Auto-Hi, ISO 80, ISO 100, ISO 200, ISO 400, ISO 800, and ISO 1600.

When ISO setting is set to [Auto], the camera automatically changes the sensitivity according to the distance, brightness, zoom, macro settings, and picture quality/size. Usually, use the camera in the [Auto] mode.

When the ISO setting is set to [Auto-Hi] (auto high sensitivity), the sensitivity is automatically set according to the shooting conditions but a higher upper limit than in [Auto] can be set. When shooting a dark subject, the shutter speed set in [Auto-Hi] is faster than in [Auto], which may reduce camera shake or blurring of the subject. The maximum ISO setting for [Auto-Hi] is specified in the setup menu. (👉 P.178)

If you do not want to allow the camera to change the ISO sensitivity, select an ISO setting other than [Auto] or [Auto-Hi].

To change the setting, use the shooting menu or the ADJ./OK button. This section explains easy ways to change the setting with the ADJ./OK button.

To use the shooting menu, see "Using the Menu" (👉 P.100).

- 1 Press the ADJ./OK button in shooting mode.**
- 2 Press the ADJ./OK button ◀▶ until the ISO setting menu appears.**
- 3 Press the button ▲▼ to select the setting.**
- 4 Press the ADJ./OK button.**
 - The setting appears on the screen.

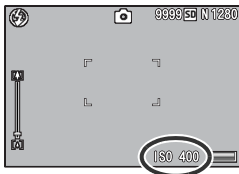



Note

- When the ISO setting is set to [Auto], the maximum sensitivity is equivalent to ISO 800 if the flash is used. When the ISO setting is [Auto] and the flash is not fired, the ISO setting is between 80 and 200.
- Images shot with a higher sensitivity may appear grainy.
- When the ISO sensitivity is set to [Auto] or [Auto-Hi], the ISO sensitivity that displays when half-pressing the shutter release button may differ from the actual ISO sensitivity in some cases (when using the flash, etc.).

Restoring the Shooting Menu Settings to their Defaults

To return the shooting menu settings to their defaults, follow the steps below.

1 Display the shooting menu.

- For information on using the menu, see P.100.

2 Press the ADJ./OK button ▼ to select [Restore Defaults] and press the button ►.

- A confirmation message appears.

3 Make sure that [Yes] is selected, and then press the ADJ./OK button.

- The display indicates the camera is restoring the initial settings. Once it is finished, the display returns to the shooting mode screen.

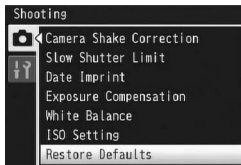

Note

For a list of functions whose settings are saved when the camera is turned off, see "Appendices". (P.234)

5 Playback Functions

Instructions in this manual to “Press the ADJ./OK button ▲▼◀▶” indicate that you should press the ADJ./OK button in the up, down, left or right direction. Instructions to “Press the ADJ./OK button” indicate that you should press directly down on the button.

Playing Back Movies

To play back movies, follow the steps below.

1 Press the (Playback) button.

- The last movie shot is displayed.
- The first frame of the movie is displayed as a still image.







2 Press the ADJ./OK button ▲▼◀▶ to select the movie you want to view.

- Press the button ▶ to display the next file.
- Press the button ◀ to display the previous file.
- Press the button ▲ to display the file 10 frames forward.
- Press the button ▼ to display the file 10 frames backward.



3 Press the ADJ./OK button.

- Playback begins.
The elapsed playback indicator or the elapsed time is displayed on the screen.

Fast Forward	Turn the zoom lever toward  during playback.
Rewind	Turn the zoom lever toward  during playback.
Pause/Playback	Press the ADJ./OK button.
Slow Playback	Turn and hold the zoom lever toward  during pause.
Slow Rewind	Turn and hold the zoom lever toward  during pause.
Next Frame	Turn the zoom lever toward  during pause.
Previous Frame	Turn the zoom lever toward  during pause.
Volume Adjustment	Press the ADJ./OK button ▲▼ during playback.

Playing Back MP Files

When you shoot one still image with M-Cont Plus, Speed Cont, or Multi-trgt AF, the image is recorded as one MP file. Use the following method to play back MP files.



Note

- Images shot in normal continuous mode can be played back in the same way as normal still images.
- The focus position is displayed for multi-target AF shooting.

1 Press the (Playback) button.

2 Press the ADJ./OK button to display the MP file you want to play back.

- The MP file is displayed with the symbol.



5

Playback Functions

3 The display changes as follows.

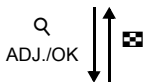

Display for Step 2

- Press the DISP. button to change between "Normal" and "No Display".
- The images cannot be enlarged even if the zoom lever is turned toward (Enlarged View). The images are displayed in thumbnail view.
- The other operations are the same as those for normal still images.

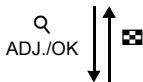

Thumbnail view

- The MP file images are displayed in thumbnail view.
- Press the ADJ./OK button to select a frame.
- The DISP. button is disabled.



Single frame view

- This displays the frame selected on the thumbnail view.
- Turn the zoom lever toward \mathcal{Q} (Enlarged View) to display enlarged view.

ADJ./OK



Slide Show

- Images are displayed automatically in the order they were consecutively shot, starting with the displayed frame.

- The operations during slide show are shown below.

Pause/Playback	Press the ADJ./OK button.
Fast Forward	Turn and hold the zoom lever toward \mathcal{Q} during playback.
Rewind	Turn and hold the zoom lever toward \mathcal{P} during playback.
Slow Playback	Turn and hold the zoom lever toward \mathcal{Q} during pause.
Slow Rewind	Turn and hold the zoom lever toward \mathcal{P} during pause.
Next Frame	Turn the zoom lever toward \mathcal{Q} during pause.
Previous Frame	Turn the zoom lever toward \mathcal{P} during pause.
First Frame	Press the ADJ./OK button \blacktriangleleft .
Last Frame	Press the ADJ./OK button \blacktriangleright .

4 To play back files other than MP files, return to Step 2 and press the ADJ./OK button $\blacktriangle\blacktriangledown\blacktriangleleft\blacktriangleright$.



Caution

- The [DPOF], [Trim], [Resize], [Skew Correction] (playback mode), [Level Compensation], and [White Balance Compensation] functions are not available for MP files.
- [Flag Function Setting] and [Protect] cannot be set for individual frames in an MP file. If [Flag Function Setting] or [Protect] is set when the thumbnail view or single image view is displayed, the setting will be applied to the MP file instead of an individual frame.
- The individual images in a MP file can not be deleted separately.



MP file

MP is a file format for recording a set of still images.

Exporting MP Files

You can extract specific frames from an MP file shot using M-Cont Plus, Speed Cont, or Multi-trgt AF and save each frame as an individual still image.



Note

- The images are saved in the same sizes used for shooting.
- The original files will be retained after extraction.
- The focus positions for images shot using multi-target AF will not be displayed on extracted images.

1 Press the (Playback) button.

2 Press the ADJ./OK button to display the MP file you want to export.

- The MP file is displayed with the symbol.
- To export multiple frames, you can also turn the zoom lever toward (Enlarged View) to display thumbnail view, and then go to Step 3.



3 Press the MENU button.

- The playback menu appears.

4 Press the ADJ./OK button to select [Export Still Images] and then press the button .

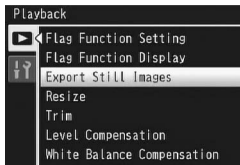

Selecting One Frame

5 Press the button **▲▼** to select [1 Frame].

- Press the button **◀▶** to select the frame.

6 Press the **ADJ./OK** button.



Specifying Multiple Frames Separately

5 Press the button **▲▼** to select [Sel Mult] and then press the **ADJ./OK** button.

- If thumbnail view was displayed in Step 2 on P.134, skip Step 5.

6 Press the button **▲▼** to select [Sel. Individ.] and then press the **ADJ./OK** button.



7 Press the button **▲▼◀▶** to select the frame and then press the **ADJ./OK** button.

- Press the MENU button to switch to the display for specifying a range of frames. See Step 7 and beyond on P.136.

8 Repeat Step 7 to select all the frames.

- If you selected a frame by mistake, you can deselect it by selecting the frame and pressing the **ADJ./OK** button.

9 Press the **Fn (Function)** button.

10 Press the **ADJ./OK** button **◀▶** to select [Yes] and then press the **ADJ./OK** button.

Specifying a Range of Multiple Frames

5 Press the button **▲▼** to select [Sel. Mult] and then press the ADJ./OK button.

- If thumbnail view was displayed in Step 2 on P.134, skip Step 5.

6 Press the button **▲▼** to select [Sel. Range] and then press the ADJ./OK button.

7 Press the button **▲▼◀▶** to select the starting point for the range of frames you want to specify and press the ADJ./OK button.

- If you make a mistake when selecting the starting point for the range of frames, press the ADJ./OK button to return to the screen for selecting the starting point.
- Press the MENU button to switch to the display for specifying frames separately. See Step 7 and beyond on P.135.

8 Press the button **▲▼◀▶** to select the ending point for the range of frames you want to specify and press the ADJ./OK button.

9 Repeat Steps 7 and 8 to specify all ranges.

10 Press the Fn (Function) button.

11 Press the ADJ./OK button **◀▶** to select [Yes] and then press the ADJ./OK button.

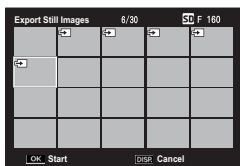

Selecting All Frames

- 5** Press the button ▲▼ to select [All Frames] and press the button ►.
- 6** Press the button ◀▶ to select [Yes] and then press the ADJ./OK button.



6 Playback Menu

Instructions in this manual to “Press the ADJ./OK button ▲▼◀▶” indicate that you should press the ADJ./OK button in the up, down, left or right direction. Instructions to “Press the ADJ./OK button” indicate that you should press directly down on the button.

About the Playback Menu

Press the MENU button in playback mode to display the playback menu. The playback menu allows you to make the settings for the following functions.

Setting	Options	Refer to
Flag Function Setting	_____	P.140
Flag Function Display	_____	P.142
Export Still Images	Cancel, 1 Frame, Sel Mult, All Frames	P.134
Resize	1280, 640	P.143
Trim	_____	P.144
Level Compensation	Auto, Manual	P.147
White Balance Compensation	_____	P.150
Skew Correction	_____	P.152
Protect	Cancel, 1 File, Sel Mult, Select All, Cancel All	P.154
Slide Show	_____	P.157
Copy to Card from Internal Memory	_____	P.158
DPOF	Cancel, 1 File, Select All, Cancel All	P.159
Recover File	_____	P.162



Note

The setup menu can be accessed from within the playback menu. (☞ P.165)

Using the Menu

1 Press the **▶** (Playback) button to select the playback mode.

2 Press the **MENU** button.

- The playback menu appears.

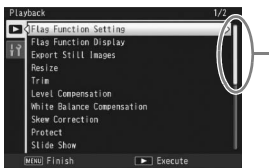

Indicates the range of displayed screens.

3 Press the **ADJ./OK** button **▲▼** to select the desired item.

- If the **DISP.** button is pressed at this point, the cursor moves to the playback menu tab.
- Press the **ADJ./OK** button **▼** at the bottom item to display the next screen.

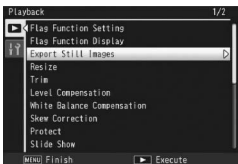





4 Press the **ADJ./OK** button **▶**.

- The screen for the selected menu item appears.

Saving Images You Want to Quickly Display (Flag Function Setting)

You can set useful image files, such as a train time table or a map, to [Flag Function Setting], and then press the Fn (Function) button during playback to easily display these files whenever you like. Up to 20 files can be saved with [Flag Function Setting].

Setting/Canceling One File at a Time

- 1 Press the  (Playback) button.
- 2 Press the ADJ./OK button    to display the file you want to set or cancel.
- 3 Press the MENU button.
 - The playback menu appears.
- 4 Check that [Flag Function Setting] is selected and press the ADJ./OK button .
 - The [Flag Function Setting] screen appears.
- 5 Make sure that [Set] is selected to save a file or [Cancel] is selected to cancel a file, and then press the ADJ./OK button.
 - When a file is set, the symbol appears on the screen.
 - If 20 files have already been set, no more files can be set.

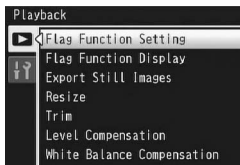

Note

If an enlarged still image is set, the magnification ratio and magnified area are saved and the enlarged image can be displayed as is.

Setting/Canceling Multiple Files at One Time

- 1 Press the **▶** (Playback) button.
- 2 Turn the zoom lever toward **☒** (Thumbnail View).
 - The screen is divided into 20 frames and thumbnails are displayed.
- 3 Press the ADJ./OK button **▲▼◀▶** to select the first file you want to set or cancel.
- 4 Press the MENU button.
 - The playback menu appears.
- 5 Check that [Flag Function Setting] is selected and press the ADJ./OK button **▶**.
 - When a file is set, the symbol appears on the file.
 - If 20 files have already been set, no more files can be set.
- 6 Press the button **▲▼◀▶** to select the next file you want to set or cancel and press the ADJ./OK button.
- 7 Repeat Step 6 to select all the files you want to set or cancel.
 - If you selected a file by mistake, select the file and press the ADJ./OK button again.
- 8 Press the DISP. button.

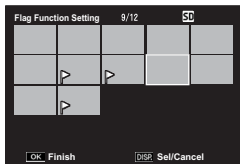



- ⚠ Caution**-----
- If the name of the file set to [Flag Function Setting] is changed using a computer, the file is canceled from [Flag Function Setting].
 - When the contents of the internal memory are copied to an SD memory card, the files set to [Flag Function Setting] in the internal memory are canceled.
 - When a file in an SD memory card is set to [Flag Function Setting], [CLIPINFO] folder and CLIP.CLI file are created on the SD memory card. If these are deleted, the corresponding file is canceled from [Flag Function Setting].
 - If the name of an image file is changed using a computer, the file may not be able to be set to [Flag Function Setting].
 - Only images taken using this camera can be set to [Flag Function Setting].

Displaying an Image Set to Flag Function Setting (Flag Function Display)

1 Press the  (Playback) button.

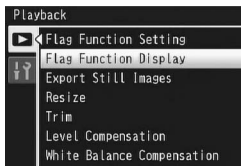
2 Press the Fn (Function) button, or select [Flag Function Display] from the playback menu, and press the ADJ./OK button .



- The file set to [Flag Function Setting] with the smallest file number is displayed.
- You can use the zoom lever to change the size of still images. You can also press the ADJ./OK button  to move the displayed image. Changes to the magnification ratio and magnified area are saved, and the image is displayed as is the next time.
- You can press the shutter release button or the  button to switch to shooting mode.
- If no files are set to [Flag Function Setting], a message appears and you are returned to the playback menu.

6 **3** Press the Fn button as required.

- If multiple files are set to [Flag Function Setting], pressing the Fn button displays the image with the smallest file number.



Note

When a file set to [Flag Function Setting] is displayed at normal magnification, pressing the ADJ./OK button  displays the previous or next image.

Resizing Images

You can reduce the image size of a shot still image to create a new file with a different image size.

Original	Resized	
F3456/N3456/F3:2/F1:1/N3072/N2592/N2048/N1728	N1280	N640
N1280	N640	



Caution

You can resize only still images. Movies or MP files cannot be resized.



Note

- The ratio of width to height of [F3:2] images is 3:2. When an image of this type is resized, it is reduced to a 4:3 image with black borders at the top and bottom.
- In [F1:1] images, the height and width are the same. When an image of this type is resized, it is reduced to a 4:3 image with black borders added on the left and right sides.
- You can also change the image size during shooting. (P.101)

1 Press the (Playback) button.

2 Press the ADJ./OK button to display the file with the image size you want to change.

3 Press the MENU button.

- The playback menu appears.

4 Press the ADJ./OK button to select [Resize] and press the button .

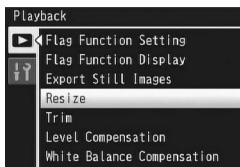

5 Press the button to select [1280] or [640].





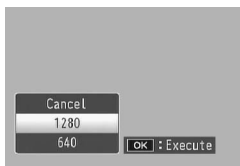

6 Press the ADJ./OK button.



- The display indicates that the image is being resized, and then the resized image is recorded. The original image remains unchanged.



Trimming Images

This function allows you to trim a still image you have shot and then save it as a separate file.

- 1** Press the  (Playback) button.
- 2** Press the ADJ./OK button    to display the file you want to trim.
- 3** Press the MENU button.
 - The playback menu appears.
- 4** Press the ADJ./OK button  to select [Trim] and press the button .
- The [Trim] screen appears.
- To cancel trimming, press the DISP. button.

- 5** Turn the zoom lever toward  or  to set the size of the trimming frame.

- Pressing the Fn (Function) button at this point displays the screen for describing the operating procedure. Pressing the Fn button again returns the display to the previous screen.



- Press the  button to choose between aspect ratios of 4 : 3 and 1 : 1.

- 6** Press the ADJ./OK button    to set the position of the trimming frame.

- 7** Press the ADJ./OK button.

- The trimmed image is recorded. The original image remains unchanged.

Caution-----

- You can only trim still images shot using this camera.
- You cannot trim movies or MP files.
- With the exception of images with an aspect ratio of 1 : 1 and a size, after cropping, of 2592 x 2592, images can be cropped repeatedly. The compression applied when a copy is saved results in a drop in image quality.

**Note**

- If an image is trimmed, the compression ratio changes to Normal.
- The available settings for the trimming frame size differ depending on the original image size. Each time you turn the zoom lever toward \mathcal{Q} , the trimming frame decreases in size by one level. You can decrease the frame size through 13 levels down to the smallest size.
- The size of the image after cropping depends on the size of the original and the size of the crop (the first crop shown in the trimming display is the second largest crop; to display the largest crop, select \boxtimes with the zoom lever).

Aspect ratio 4:3

Original image size	Trimming level	Trimmed image size
3456 × 2592	1	3072 × 2304
	2, 3	2592 × 1944
	4, 5	2048 × 1536
	6 to 9	1280 × 960
	10 to 13	640 × 480
3456 × 2304	1	3072 × 2304
	2	2592 × 1944
	3 to 5	2048 × 1536
	6 to 9	1280 × 960
	10 to 13	640 × 480
2592 × 2592	1	2592 × 1944
	2 to 4	2048 × 1536
	5 to 8	1280 × 960
	9 to 12	640 × 480
3072 × 2304	1, 2	2592 × 1944
	3, 4	2048 × 1536
	5 to 8	1280 × 960
	9 to 12	640 × 480
2592 × 1944	1	2592 × 1944
	2, 3	2048 × 1536
	4 to 7	1280 × 960
	8 to 12	640 × 480
2048 × 1536	1, 2	2048 × 1536
	3 to 6	1280 × 960
	7 to 10	640 × 480
1728 × 1296	1	1728 × 1296
	2 to 5	1280 × 960
	6 to 9	640 × 480
1280 × 960	1 to 3	1280 × 960
	4 to 8	640 × 480
640 × 480	1 to 4	640 × 480

Aspect ratio 1:1

Original image size	Trimming level	Trimmed image size
3456 × 2592	1	2592 × 2592
	2	2304 × 2304
	3 to 5	1536 × 1536
	6 to 9	960 × 960
	10 to 13	480 × 480
3456 × 2304	1, 2	2304 × 2304
	3, 4	1536 × 1536
	5 to 9	960 × 960
	10 to 12	480 × 480
2592 × 2592	1, 2	2592 × 2592
	3 to 5	1536 × 1536
	6 to 9	960 × 960
	10 to 12	480 × 480
3072 × 2304	1, 2	2304 × 2304
	3, 4	1536 × 1536
	5 to 8	960 × 960
	9 to 12	480 × 480
2592 × 1944	1 to 3	1536 × 1536
	4 to 7	960 × 960
	8 to 11	480 × 480
2048 × 1536	1, 2	1536 × 1536
	3 to 6	960 × 960
	7 to 10	480 × 480
1728 × 1296	1 to 4	960 × 960
	5 to 8	480 × 480
1280 × 960	1 to 3	960 × 960
	4 to 8	480 × 480
640 × 480	1 to 4	480 × 480

Correcting the Image Brightness and Contrast

You can use either [Auto] or [Manual] mode to correct the brightness and contrast in still images you have shot and then record the corrected images. [Manual] mode allows you to correct the image by adjusting the histogram.



Note

See P.60 for more information on the histogram display.

- 1 Press the (Playback) button.
- 2 Press the ADJ./OK button to display the file you want to correct.
- 3 Press the MENU button.
 - The playback menu appears.
- 4 Press the ADJ./OK button to select [Level Compensation] and press the button .

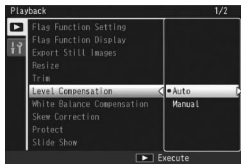

Correcting Images Automatically

- 5 Press the ADJ./OK button to select [Auto] and press the button .
 - The original image appears at the upper left of the screen and the corrected image is shown on the right.
 - If you select a file that cannot use level compensation, an error message appears and you are returned to the playback menu.
 - To cancel level compensation, press the DISP. button.
- 6 Press the ADJ./OK button.
 - Messages appear during the correction process, and then the corrected image is recorded. The original image remains unchanged.



Correcting Images Manually

5 Press the ADJ./OK button ▲▼ to select [Manual] and press the button ►.

- The original image appears at the upper left of the screen, the histogram is at the lower left, and the corrected image is shown on the right.
- If you select a file that cannot use level compensation, an error message appears and you are returned to the playback menu.
- To cancel level compensation, press the DISP. button.

6 Press the MENU button to switch between points on the histogram.

- A histogram shows the number of pixels on the vertical axis and the brightness on the horizontal axis, ranging from shadows (dark areas) on the left through midtones to highlights (bright areas) on the right. Each time you press the MENU button, the selected point switches from the left point, to the middle point and then to the right point.
- Pressing the Fn (Function) button at this point displays the screen for describing the operating procedure. Pressing the Fn button again returns the display to the previous screen.

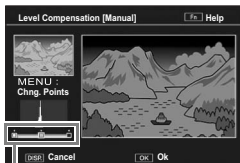

Points

7 Press the ADJ./OK button ◀▶ to correct the image by adjusting the location of the selected point.

- Moving the left or right point moves the middle point also.



Sample correction methods

- Example 1)
To adjust the overall image brightness:
Select the middle point and move it to the left to brighten the entire image.
Selecting the middle point and moving it to the right darkens the entire image.



- Example 2)
To correct an overexposed or underexposed image:
If the image is overexposed, move the left point to the right so that it is aligned with the left end of the histogram peaks.
If the image is underexposed, move the right point to the left so that it is aligned with the right end of the histogram peaks.
You can then adjust the overall image brightness by moving the middle point left or right.



Overexposed image

- Example 3)
To boost the contrast in an image:
If an image is lacking in contrast, the histogram peaks are concentrated toward the center. By aligning the left and right points with the respective ends of the histogram peaks, you can create an image with clearly defined bright and dark areas.
You can then adjust the overall image brightness by moving the middle point left or right.

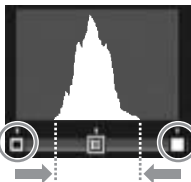

8 Press the ADJ./OK button.

- Messages appear during the correction process, and then the corrected image is recorded. The original image remains unchanged.







Caution

- You can only use level compensation for still images shot using this camera.
- You cannot use level compensation for movies or MP files.
- This function may not have any effect for images shot using [Text Mode] in scene mode, or images shot when [Image Settings] is set to [Black & White] or [Sepia].
- While you can use level compensation repeatedly, the image is recompressed each time and there will be some decline in image quality.

Correcting the White Balance

This function allows you to correct the green, magenta, blue and amber color tones in still images you have taken and then record the corrected images.

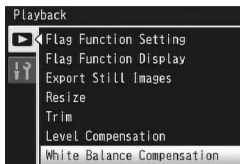

- 1 Press the  (Playback) button.
- 2 Press the ADJ./OK button  to display the file you want to correct.
- 3 Press the MENU button.
 - The playback menu appears.
- 4 Press the ADJ./OK button  to select [White Balance Compensation] and press the button .

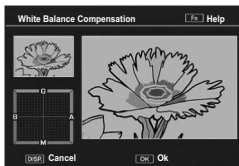

- The original image appears at the upper left of the screen, the white balance compensation map is at the lower left, and the corrected image is shown on the right.
- If you select a file that cannot use white balance compensation, an error message appears and you are returned to the playback menu.

- 5 Press the button  to move the point around the white balance compensation map and adjust the color tones.



- Press the button  to move the point around the white balance compensation map. [G] denotes green, [A] denotes amber, [M] denotes magenta and [B] denotes blue, and the color tones change toward the respective colors depending on the location of the point.
- To cancel white balance compensation, press the DISP. button.
- Press the  button to reset the color tone while correcting.
- Pressing the Fn (Function) button at this point displays the screen for describing the operating procedure. Pressing the Fn button again returns the display to the previous screen.

6 Press the ADJ./OK button.

- Messages appear during the correction process, and then the corrected image is recorded. The original image remains unchanged.







Caution-----



- You can only use white balance compensation for still images shot using this camera.
- You cannot correct the white balance for movies or MP files.
- This function may not have any effect for images shot using [Text Mode] in scene mode, or images shot when [Image Settings] is set to [Black & White] or [Sepia].
- While you can use white balance compensation repeatedly, the image is recompressed each time and there will be some decline in image quality.

Correcting Skewed Images

You can straighten rectangular objects, such as a message board or business card, shot at an angle, to make them look as if they were shot squarely.

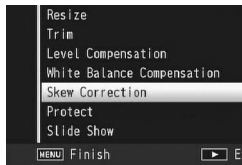
- 1** Press the  (Playback) button.
- 2** Press the ADJ./OK button    to display the file you want to straighten.
- 3** Press the MENU button.
 - The playback menu appears.
- 4** Press the ADJ./OK button  to select [Skew Correction] and press the button .



- The display indicates that the image is being processed, and then the area recognized as the correction range is displayed with an orange frame. Up to five areas can be recognized.
- If the target area cannot be detected, an error message appears. The original image remains unchanged.
- To select another correction area, move the orange frame to the target area by pressing the ADJ./OK button .
- To cancel skew correction, press the ADJ./OK button . Even if you cancel skew correction, the original image remains unchanged.

- 5** Press the ADJ./OK button.
 - The display indicates that the image is being corrected, and then the corrected image is recorded. The original image remains unchanged.
-  **Caution**-----
- You can use skew correction for still images shot with this camera.
 - You cannot use skew correction for movies or MP files.

**Note**-----

- The image size does not change for skew corrected images.
- If the image size is large, skew correction will take time. Resize the image (P.143) before performing skew correction to speed up the process.
- The following table shows the approximate time required for skew correction.

Image Size	Correction time
3456 × 2592	Approx. 20 seconds
3072 × 2304	Approx. 15 seconds
2592 × 1944	Approx. 12 seconds
2048 × 1536	Approx. 8 seconds
1728 × 1296	Approx. 7 seconds
1280 × 960	Approx. 6 seconds
640 × 480	Approx. 2 seconds

- When scene mode is set to [Skew Correct Mode], you can shoot an image and then immediately correct any skew in the image. (P.75)

Preventing the Deletion of Files

You can protect files from being accidentally deleted.



Caution

Protected files cannot be deleted normally. However, they will be deleted if you format the memory where the files are stored.

1 Press the (Playback) button.

- The last file recorded is displayed.

2 Press the ADJ./OK button to display the file you want to protect or unprotect.

- To protect or unprotect multiple frames, you can also turn the zoom lever toward  (Thumbnail View) to display thumbnail view, and then go to Step 3.

3 Press the MENU button.

- The playback menu appears.

4 Press the ADJ./OK button to select [Protect] and press the button .

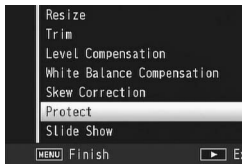

Protecting/Unprotecting a File

5 Press the button to select [1 File].

- Press the button  to select the file.

6 Press the ADJ./OK button.

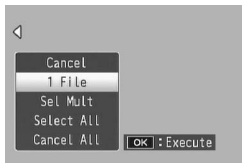

Protecting Multiple Files Separately

5 Press the button ▲▼ to select [Sel Mult] and then press the ADJ./OK button.

- If thumbnail view was displayed in Step 2 on P.154, skip Step 5.

6 Press the button ▲▼ to select [Sel. Individ.] and then press the ADJ./OK button.

7 Press the ADJ./OK button ▲▼◀▶ to select the frames and then press the ADJ./OK button.

- Press the MENU button to switch to the display for specifying a range of files. See Step 7 and beyond for “Specifying a Range of Multiple Files”.

8 Repeat Step 7 to select all the files.

- If you selected a file by mistake, you can deselect it by selecting the file and pressing the ADJ./OK button.

9 Press the Fn (Function) button.

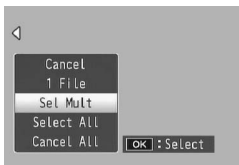

Specifying a Range of Multiple Files

5 Press the button ▲▼ to select [Sel Mult] and then press the ADJ./OK button.

- If thumbnail view was displayed in Step 2 on P.154, skip Step 5.

6 Press the button ▲▼ to select [Sel. Range], and then press the ADJ./OK button.

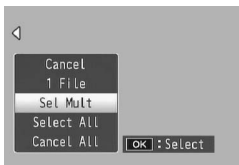

7 Press the button ▲▼◀▶ to select the starting point for the range of files you want to specify and press the ADJ./OK button.

- If you make a mistake when selecting the starting point for the range of files, press the DISP. button to return to the screen for selecting the starting point.
- Press the MENU button to switch to the display for specifying files separately. See Step 7 and beyond for “Protecting Multiple Files Separately”.

8 Press the button ▲▼◀▶ to select the ending point for the range of files you want to specify and press the ADJ./OK button.



9 Repeat Steps 7 and 8 to specify all ranges.

10 Press the Fn (Function) button.

Protecting/Unprotecting All Files

5 Press the button ▲▼ to select [Select All] or [Cancel All] and press the ADJ./OK button ▶.

6 Press the ADJ./OK button ◀▶ to select [Yes] and then press the ADJ./OK button.

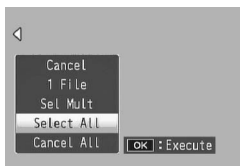

Displaying Slide Shows



You can display the recorded still images and movie files sequentially on the screen. This is called a slide show. To view a slide show, follow the steps below.

1 Press the  (Playback) button.

- The last file recorded is displayed.

2 Press the MENU button.

- The playback menu appears.

3 Press the ADJ./OK button  to select [Slide Show] and press the button .

- The slide show starts and files are played back in order.
- If you want to stop the slide show in progress, press any button on the camera.

The slide show repeats itself until stopped.

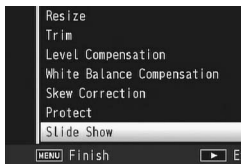



Note-----

- Each still image is displayed for three seconds.
- For movies and MP files, all the images you shot are played back.

Copying the Contents of the Internal Memory to an SD Memory Card

You can copy all movies, still images, and sound data stored in the internal memory onto an SD memory card at once.

- 1** Turn the camera off.
- 2** Insert an SD memory card.
- 3** Turn the camera on.
- 4** Press the  (Playback) button.
- 5** Press the MENU button.
 - The playback menu appears.
- 6** Press the ADJ./OK button  to select [Copy to Card from Internal Memory] and press the button .

- The display indicates copying is in progress; once finished, the display returns to the playback screen.

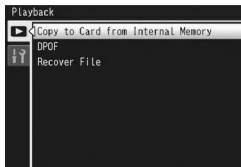

Note







- If the capacity of the SD memory card to which you are copying is insufficient, a message will be displayed indicating there is not enough capacity. To copy only the number of shots that will fit into the available capacity, select [Yes] and then press the ADJ./OK button. To cancel copying, select [No] and then press the ADJ./OK button.
- It is not possible to copy the contents of an SD memory card to the internal memory.
- When the contents of the internal memory are copied to an SD memory card, the files saved to [Flag Function Setting] in the internal memory are canceled.

Using a Printing Service (DPOF)



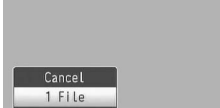

The still images recorded on an SD memory card can be printed out if you take them to a store that offers a digital camera print service. To use a print service, you must make print settings on your camera. These settings are called Digital Print Order Format (DPOF) settings.

The DPOF setting specifies one print per still image. You can also select multiple images for the DPOF setting and specify the number of copies to print.

Setting/Canceling DPOF for a File

- 1** Press the  (Playback) button.
 - 2** Press the ADJ./OK button  to display the still image for which you want to make the DPOF setting.
 - 3** Press the MENU button.
 - The playback menu appears.
 - 4** Press the ADJ./OK button  to select [DPOF] and press the button .
- 
- 5** Press the button  to select [1 File].
 - Press the button  to select a file.
 - 6** Press the ADJ./OK button.
- 



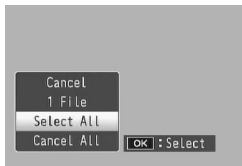
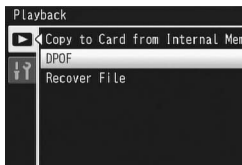

Setting/Canceling DPOF for All Files

- 1** Press the  (Playback) button.
- 2** Press the MENU button.
 - The playback menu appears.
- 3** Press the ADJ./OK button  to select [DPOF] and press the button .
- 4** Press the button  to select [Select All] or [Cancel All].
- 5** Press the ADJ./OK button.
 - Once the DPOF setting is made, the DPOF symbol appears on the screen.



Setting DPOF for Multiple Files

To make the DPOF settings for selected still images all at once, follow the steps below.

- 1** Press the  (Playback) button.
- 2** Turn the zoom lever toward  (Thumbnail View).
 - The files are displayed in thumbnail view.
- 3** Press the ADJ./OK button   to select the first still image for which you want to make the DPOF setting.
- 4** Press the MENU button.
 - The playback menu appears.

5 Press the ADJ./OK button ▼ to select [DPOF] and press the button ►.

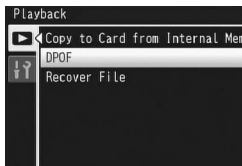

6 Press the button ▲▼ to set the number of copies to print.

- Press the button ▲ to increase the number of copies, or press the button ▼ to decrease the number of copies.

7 Press the button ◀▶ to select the next still image for which you want to make the DPOF setting.

8 Press the button ▲▼ to set the number of copies to print.

- Press the button ▲ to increase the number of copies, or press the button ▼ to decrease the number of copies.

9 Repeat Steps 7 and 8 to select all the still images for which you want to make the DPOF setting.

10 Press the ADJ./OK button.

- The display indicates that the selected images are being processed; once finished, the display returns to the thumbnail view.



Note-----

- To remove the DPOF settings for multiple still images, follow the same steps described above to set the number of copies to print to [0] for each image, and then press the ADJ./OK button.
- You can also cancel the DPOF settings for all still images at once. (👉 P.160)

Restoring Deleted Files

You can restore all deleted files.

Deleted files cannot be restored after performing any of the following operations.

- Turning the camera off
- Switching from playback mode to shooting mode
- Using DPOF, Resize, Copy to Card from Internal Memory, Skew Correction, Level Compensation, White Balance Compensation or Trim.
- Files with DPOF settings are deleted
- Internal memory or SD memory card is initialized
- Setting or canceling files for [Flag Function Setting]
- Changing the magnification ratio or magnified area of files set to [Flag Function Setting]
- Exporting MP files using [Export Still Images]

1 Press the  (Playback) button.

2 Press the MENU button.

- The playback menu appears.

3 Press the ADJ./OK button  to select [Recover File] and press the button .

- A screen appears to confirm whether to restore all files.
- If there are no restorable files, a confirmation message appears.

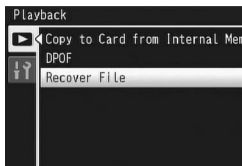

4 Press the button  to select [Yes] and then press the ADJ./OK button.

- All deleted files are restored.

Viewing on a Television

You can view files you have taken on a TV screen. The camera displays everything on the TV screen just as it would on the picture display.

To use your television for viewing, connect your camera to the television with the AV cable that came with your camera. To view files on a television, follow the steps below.

1 Securely connect the AV cable to the Video In terminal on the television.

- Connect the white plug of the AV cable to the audio input terminal (white) of the TV unit and the yellow plug to the video input terminal (yellow).

Video input terminal (yellow)

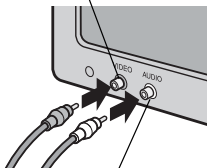

Audio input terminal (white)

2 Make sure that the camera is off.

3 Securely connect the AV cable to the AV output terminal on the camera.

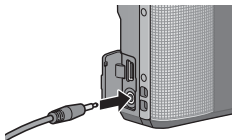

4 Set the television to Video mode. (Set the input to Video)

- For details, see the documentation that came with the television.

5 Press the POWER button, or press and hold the (Playback) button to turn the camera on.

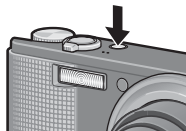



Caution

- When the AV cable is connected to the camera, the picture display and the speaker output turn off.
- Do not force the AV cable into the terminal.
- Do not apply excessive force with the AV cable connected.
- When using the AV cable, do not move the camera with the AV cable.





Note



- You can connect the AV cable to the Video In terminal on your video recorder and record what you have shot to a video recorder.
- Your camera is set to NTSC playback format (used in North America and other countries/regions) for use with television equipment and other audiovisual equipment. If the equipment you want to connect to uses PAL format (used in Europe and elsewhere), then switch your camera to PAL format in the setup menu before connecting. (☞ P.196)

7 Setup Menu

Instructions in this manual to “Press the ADJ./OK button 

About the Setup Menu

You can change the camera settings by displaying the setup menu from the shooting menu ( P.97) or playback menu ( P.138). The setup menu enables you to set the items listed in the table below.

Setting	Options [Default Settings]	Refer to
Format [Card]	_____	P.168
Format [Internal Memory]	_____	P.169
LCD Brightness	_____	P.170
Reg. My Settings	MY1, MY2	P.171
Step Zoom	On, [Off]	P.173
Set Fn Button	Off, [Macro Target], AE Lock, AF/Cont. AF AF/M-trgt AF, AF/MF, AF/Snap, AT-BKT, WB-BKT, CL-BKT, FOCUS-BKT	P.174
ADJ Button Setting 1 ^{*1} ADJ Button Setting 2 ^{*2} ADJ Button Setting 3 ^{*3} ADJ Button Setting 4 ^{*4}	Off, [Exposure Comp] ^{*1} , [White Balance] ^{*2} , [ISO] ^{*3} , [Quality] ^{*4} , Focus, Image, Expo. Metering, Auto Bracket, Flash Comp.	P.176
ISO Auto-High Settings	[AUTO 400], AUTO 800, AUTO 1600	P.178
AF Auxiliary Light	[On], Off	P.179
Operation Sounds	[All], Level Sound, Shutter Sounds	P.180
Volume Settings	<input type="checkbox"/> <input type="checkbox"/> <input type="checkbox"/> (Mute), <input checked="" type="checkbox"/> <input type="checkbox"/> <input type="checkbox"/> (Small), <input checked="" type="checkbox"/> <input checked="" type="checkbox"/> <input type="checkbox"/> (Medium), <input checked="" type="checkbox"/> <input checked="" type="checkbox"/> <input checked="" type="checkbox"/> (Large)	P.181
LCD Confirmation Time	Off, [0.5 seconds], 1 second, 2 seconds, 3 seconds, Hold	P.182
Auto Power Off	Off, 1 minute, [5 minutes], 30 minutes	P.183
LCD Auto Dim	[On], Off	P.184
Digital Zoom Image	[Normal], Auto Resize	P.185
Level Setting	Off, [Display], Display+Sound, Sound	P.187
Grid Guide Display Options	[ ,  , ]	P.188
Shooting Info. Display Frame	On, [Off]	P.189

Setting	Options [Default Settings]	Refer to
Minimum Distance	[Show], Hide	P.190
Auto Rotate	[On], Off	P.191
Card Sequence No.	On, [Off]	P.193
Date Settings	_____	P.194
Language/言語(*)	日本語, English, Deutsch, Français, Italiano, Español, Русский, 简体中文, 繁体中文, 한국어, ភាសាខ្មែរ	P.195
Video Out Mode(*)	NTSC, PAL	P.196

(*) The default setting varies depending on where you purchased the camera.



Note

- In easy shooting mode, the quantity and order of the items in the setup menu are different from other shooting modes. The contents of the settings are the same as other modes.
- The items that can be set with [Set Fn Button] and [ADJ Button Setting 1/2/3/4] differ depending on the shooting mode. See the corresponding reference page for details.

Using the Menu

In the instructions of this manual, the menu selection is confirmed when you “Press the ADJ./OK button” (as in Step 8 below), but you can also confirm the setting and return to the menu screen by pressing the ADJ./OK button ◀.

1 Press the MENU button.

- The shooting menu (or the playback menu) appears.

2 Press the ADJ./OK button ◀.

- In scene mode or continuous mode, press the ADJ./OK button ▲▼◀▶ to select the [MODE] tab, and then press the ADJ./OK button ▼ twice. The setup menu appears.

3 Press the ADJ./OK button ▼.

- The setup menu appears.

4 Press the ADJ./OK button ▶.

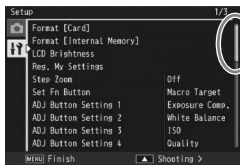

Indicates the range of displayed screens.

5 Press the ADJ./OK button ▲▼ to select the desired item.

- If the DISP. button is pressed at this point, the display returns to the screen shown in Step 3.
- Press the ADJ./OK button ▼ at the bottom item to display the next screen.



6 Press the ADJ./OK button ►.

- The menu item settings are displayed.

7 Press the ADJ./OK button ▲▼ to select the setting.

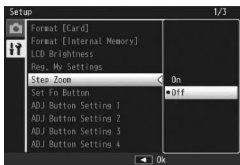

8 Press the ADJ./OK button.

- The setup menu disappears and the camera is ready for shooting or playback.
- The setup menu may appear depending on the setting. In this case, press the MENU button or the ADJ./OK button to return to the shooting or playback screen.
- Pressing the ADJ./OK button ◀ in Step 8 confirms the setting and the display returns to the screen shown in Step 5.



Note-----

For some functions, the setting selection method may differ from what is explained here. For detailed operation, see the explanation of each function.

Formatting the SD Memory Card

If the error message [Card Error] is displayed when an SD memory card is loaded into the camera or the card has been used with a computer or other digital camera, you must format the card prior to use with this camera.

Formatting is the process of preparing a card so image data can be written on it.



Caution

If you format a card that still has images stored on it, the images will be lost.

1 Display the setup menu.

- For the operating procedure, see P.166.

2 Check that [Format [Card]] is selected and press the ADJ./OK button ▶.

- A screen appears to confirm formatting.

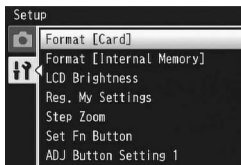

3 Press the button ◀▶ to select [Yes] and then press the ADJ./OK button.

- Formatting starts. When it is done, the display returns to the setup menu.
- If no SD memory card is loaded, a message will be displayed. After turning the power off, load an SD memory card and repeat the formatting process again.

4 Press the MENU button or the ADJ./OK button.



Protecting your images from being deleted

Move the write-protection switch on the SD memory card to "LOCK" to prevent your still images from being accidentally erased or the card from being formatted (P.24). If you unlock the card (by returning the switch to its original position), it is once again possible to add and erase images and format the card.

Formatting the Internal Memory

If the error message [Format internal memory.] is displayed, you must format the internal memory prior to use.



Caution

Formatting the internal memory deletes all of the images recorded in the memory. If you have images in the internal memory that you do not want to delete, copy the images to the SD memory card before formatting the internal memory. (P.158)

1 Display the setup menu.

- For the operating procedure, see P.166.

2 Press the ADJ./OK button ▼ to select [Format [Internal Memory]] and press the button ►.

- A screen appears to confirm formatting.

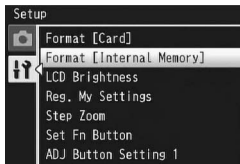

3 Press the button ◀► to select [Yes] and then press the ADJ./OK button.

- Formatting starts. When it is done, the display returns to the setup menu.

4 Press the MENU button or the ADJ./OK button.

Adjusting the Picture Display Brightness

To adjust the brightness of the picture display, follow the steps below.

1 Display the setup menu.

- For the operating procedure, see P.166.

2 Press the ADJ./OK button ▼ to select [LCD Brightness] and press the button ►.

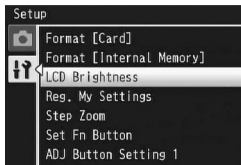

3 Press the button ▲▼ to adjust the brightness.

- Move the slider on the LCD brightness adjustment bar down to make the picture display darker and up to make it brighter. The brightness of the picture display changes as the slider is moved along the bar.
- To cancel brightness adjustment, press the DISP. button to cancel the setting and return to the shooting menu.



4 When you reach the desired brightness, press the ADJ./OK button.

- The display returns to the setup menu.

5 Press the MENU button or the ADJ./OK button.



Note

- When [LCD Auto Dim] is set to [On] on the setup menu (P.184), the picture display dims to conserve battery power if the camera is not moved for approximately five seconds. Move the camera or press any button to return to the original picture display brightness.
- The brightness display shows the view through the lens (shooting mode) or the most recently viewed picture (playback mode; if no picture is available for playback, no image will be shown in the brightness display).

Registering My Settings

The My Settings function allows you to easily shoot with your desired settings.

You can register two groups of settings as “My Settings”. Setting the mode dial to MY1 allows you to shoot with the settings registered in [MY1]. Setting the mode dial to MY2 allows you to shoot with the settings registered in [MY2]. (👉 P.83)

To register the current camera settings as My Settings, follow the steps below.

1 Change the camera settings to the settings to be registered as My Settings.

2 Display the setup menu.

- For the operating procedure, see P.166.

3 Press the ADJ./OK button ▼ to select [Reg. My Settings] and press the button ►.

- A confirmation message appears.

4 Press the button ◀▶ to select [MY1] or [MY2] and press the ADJ./OK button.

- The current camera settings are registered and the display returns to the setup menu.
- If you do not want to register them, press the DISP. button.

5 Press the MENU button or the ADJ./OK button.

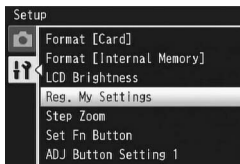

Settings Saved in [Reg. My Settings]

Shooting mode (📷/📷/📷/📷/📷/📷/📷/📷/📷/📷)
Picture Quality/Size
Focus
Pre-AF
Focal distance used in Manual
Exposure Metering
Image Settings
Flash Exposure Compensation
Dynamic Range Expansion
Plus Normal Shooting
Auto Bracket
CL-BKT
FOCUS-BKT
WB-BKT
Time Exposure
Custom Self-Timer
Camera Shake Correction
Slow Shutter Limit
Date Imprint
Exposure Compensation
White Balance
ISO Setting
Zoom position
Macro
Flash mode
Scene mode
Self-timer
DISP. mode
Step Zoom
Digital Zoom Image
Level Setting
Grid Guide Display Options
Minimum Distance
Density
Frame Rate

Fixing the Focal Length of the Zoom

Step zooming allows you to set the focal length of the zoom so that it stops at eight levels (28, 35, 50, 85, 105, 135, 200, 300 mm*).

* Equivalent to that on a 35 mm camera

Available Settings

On (Step zooming on)

Off (Step zooming off) *Default setting

- 1 Display the setup menu.**
 - For the operating procedure, see P.166.
- 2 Press the ADJ./OK button ▼ to select [Step Zoom] and press the button ►.**
- 3 Press the button ▲▼ to select [On].**
- 4 Press the ADJ./OK button.**

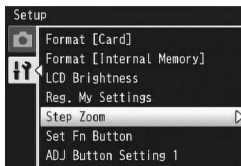

Note

- In Macro mode, the step zoom focal lengths are roughly equivalent to 31, 35, 50, 85, 105, 135, 200 and 300 mm on a 35 mm camera.
- Assigning [Step Zoom] to the Fn (Function) button with [Set Fn Button] (P.174) allows you to switch between on and off for step zoom by pressing the Fn button. (P.73)

Fn (Function) Button Settings

When a function is assigned to the Fn button, you can easily switch from one function to another simply by pressing the Fn button. The following functions can be assigned to the Fn button. For information on how to use the Fn button, see the corresponding reference page.

Available Setting	Description	Refer to
Macro Target ^(*1)	Moves the AF target without moving the camera to shoot close-ups.	P.67
AE Lock	Locks the exposure.	P.68
AF/Cont. AF	Switches between auto focus ^(*2) and continuous AF.	P.69
AF/M-trgt AF	Switches between auto focus ^(*3) and multi-target AF.	P.70
AF/MF	Switches between auto focus ^(*3) and manual focus.	P.71
AF/Snap	Switches between auto focus ^(*3) and snap mode.	P.72
Step Zoom, AT-BKT, WB-BKT, CL-BKT, FOCUS-BKT	Switches between on and off for each function.	P.73

(*1) Default setting

(*2) [Multi AF] or [Spot AF]

(*3) [Multi AF], [Spot AF] or [Continuous AF]



Note

The items that can be set for each shooting mode are shown below.^{(*)1}

Available Settings		SCENE ^{(*)2}									^{(*)2}
		Portrait / Landscape	High Sens	Discreet Mode	Zoom Macro	Skew Correct Mode	Text Mode	Other Modes			
Macro Target	<input type="radio"/>	-	<input type="radio"/>	-	<input type="radio"/>	<input type="radio"/>	<input type="radio"/>	-	<input type="radio"/>	<input type="radio"/>	<input type="radio"/>
Step Zoom	<input type="radio"/>	<input type="radio"/>	<input type="radio"/>	<input type="radio"/>	<input type="radio"/>	<input type="radio"/>	<input type="radio"/>	<input type="radio"/>	<input type="radio"/>	<input type="radio"/>	<input type="radio"/>
AE Lock	<input type="radio"/>	<input type="radio"/>	<input type="radio"/>	<input type="radio"/>	<input type="radio"/>	<input type="radio"/>	<input type="radio"/>	<input type="radio"/>	<input type="radio"/>	<input type="radio"/>	-
AF/Cont. AF	<input type="radio"/>	<input type="radio"/>	<input type="radio"/>	<input type="radio"/>	<input type="radio"/>	<input type="radio"/>	<input type="radio"/>	<input type="radio"/>	<input type="radio"/>	-	<input type="radio"/>
AF/M-trgt AF	<input type="radio"/>	-	-	<input type="radio"/>	-	-	-	-	-	-	-
AF/MF	<input type="radio"/>	-	-	<input type="radio"/>	<input type="radio"/>	<input type="radio"/>	-	-	<input type="radio"/>	<input type="radio"/>	<input type="radio"/>
AF/Snap	<input type="radio"/>	-	<input type="radio"/>	<input type="radio"/>	-	<input type="radio"/>	-	<input type="radio"/>	<input type="radio"/>	<input type="radio"/>	<input type="radio"/>
AT-BKT	<input type="radio"/>	-	-	<input type="radio"/>	<input type="radio"/>	-	-	-	-	-	-
WB-BKT	<input type="radio"/>	-	-	<input type="radio"/>	<input type="radio"/>	-	-	-	-	-	-
CL-BKT	<input type="radio"/>	-	-	<input type="radio"/>	<input type="radio"/>	-	-	-	-	-	-
FOCUS-BKT	<input type="radio"/>	-	-	<input type="radio"/>	<input type="radio"/>	-	-	-	-	-	-

^{(*)1} The Fn button can not be used for the selected function when [Miniaturize] is selected in scene mode.

^{(*)2} The functions not marked with a circle (O) can also be assigned to the Fn button, but they will not operate if the button is pressed in scene mode or movie mode.

1 Display the setup menu.

- For the operating procedure, see P.166.

2 Press the ADJ./OK button ▼ to select [Set Fn Button] and press the button ►.

3 Press the button ▲▼ to select the settings.

4 Press the ADJ./OK button.



ADJ. Button Settings

When functions are assigned to the ADJ./OK button, you can display various shooting setting screens with fewer button operations and without displaying the shooting menu.

You can use [ADJ Button Setting 1] to [ADJ Button Setting 4] to assign camera functions that can be activated by pressing the ADJ./OK button.

For information on how to use the ADJ. mode, see P.62.

The following functions can be assigned to the ADJ./OK button.

Available Settings	Refer to
Off	-
Exposure Comp	*Default setting for [ADJ Button Setting 1] P.124
White Balance	*Default setting for [ADJ Button Setting 2] P.126
ISO	*Default setting for [ADJ Button Setting 3] P.128
Quality	*Default setting for [ADJ Button Setting 4] P.101
Focus	P.103
Image	P.109
Expo. Metering	P.108
Auto Bracket	P.112
Flash Comp.	P.111
Density	P.82

**Note**

- The items that can be set for each shooting mode are shown below.

Available Settings		SCENE				EASY ^(*)				
		Text Mode ^(*)	Discreet Mode	Portrait / High Contrast B&W ^(*)	Other Modes ^(*)		Continuous Mode	M-Cont Plus Speed Cont		
Exposure Comp.	<input type="radio"/>	<input type="radio"/>	<input type="radio"/>	<input type="radio"/>	<input type="radio"/>	-	<input type="radio"/>	<input type="radio"/>	<input type="radio"/>	-
White Balance	<input type="radio"/>	<input type="radio"/>	<input type="radio"/>	<input type="radio"/>	<input type="radio"/>	-	<input type="radio"/>	<input type="radio"/>	<input type="radio"/>	<input type="radio"/>
ISO	<input type="radio"/>	<input type="radio"/>	<input type="radio"/>	<input type="radio"/>	<input type="radio"/>	-	<input type="radio"/>	<input type="radio"/>	<input type="radio"/>	<input type="radio"/>
Quality	<input type="radio"/>	<input type="radio"/>	<input type="radio"/>	<input type="radio"/>	<input type="radio"/>	<input type="radio"/>	<input type="radio"/>	<input type="radio"/>	<input type="radio"/>	<input type="radio"/>
Focus	<input type="radio"/>	<input type="radio"/>	<input type="radio"/>	<input type="radio"/>	<input type="radio"/>	-	<input type="radio"/>	<input type="radio"/>	<input type="radio"/>	<input type="radio"/>
Image	<input type="radio"/>	<input type="radio"/>	<input type="radio"/>	<input type="radio"/>	<input type="radio"/>	-	<input type="radio"/>	<input type="radio"/>	<input type="radio"/>	<input type="radio"/>
Expo. Metering	<input type="radio"/>	<input type="radio"/>	<input type="radio"/>	<input type="radio"/>	<input type="radio"/>	-	<input type="radio"/>	<input type="radio"/>	<input type="radio"/>	<input type="radio"/>
Auto Bracket	<input type="radio"/>	<input type="radio"/>	<input type="radio"/>	<input type="radio"/>	<input type="radio"/>	-	-	-	-	-
Flash Comp.	<input type="radio"/>	<input type="radio"/>	<input type="radio"/>	<input type="radio"/>	<input type="radio"/>	-	-	-	-	-
Density	-	<input type="radio"/>	<input type="radio"/>	<input type="radio"/>	<input type="radio"/>	-	-	-	-	-

^(*) The function assigned to the ADJ./OK button can not be changed.

1 Display the setup menu.

- For the operating procedure, see P.166.

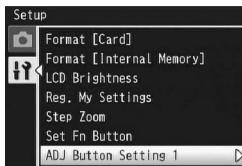
2 Press the ADJ./OK button ▼ to select [ADJ Button Setting 1], [ADJ Button Setting 2], [ADJ Button Setting 3], or [ADJ Button Setting 4], and then press the button ►.**3 Press the button ▲▼ to select the desired setting.****4 Press the ADJ./OK button.**

ISO Auto-High Settings

You can change the upper limit of the ISO setting for [Auto-Hi] (Auto high sensitivity setting) (☞ P.128) in [ISO Setting] on the shooting menu.

Available Settings

AUTO 400 *Default setting

AUTO 800

AUTO 1600

- 1** Display the setup menu.
 - For the operating procedure, see P.166.
- 2** Press the ADJ./OK button ▼ to select [ISO Auto-High Settings] and press the button ►.
- 3** Press the button ▲▼ to select the desired setting.
- 4** Press the ADJ./OK button.



Note

Images shot with a higher sensitivity may appear grainy.

AF Auxiliary Light

You can set whether to use the AF auxiliary light when shooting with auto focus.

When [AF Auxiliary Light] is set to [On], the AF auxiliary light lights when it is difficult to measure the distance with auto focus when shooting in dark surroundings, and the auto focus distance is measured.

- 1 Display the setup menu.**
 - For the operating procedure, see P.166.
- 2 Press the ADJ./OK button ▼ to select [AF Auxiliary Light] and press the button ►.**
- 3 Press the button ▲▼ to select the desired setting.**
- 4 Press the ADJ./OK button.**

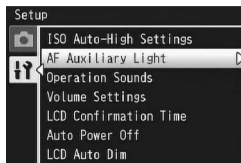

Operation Sound Settings

The following five operation sounds are made during camera operation.

- Start sound : Sound when the camera is turned on.
- Shutter sound : Sound when the shutter release button is pressed.
- Focus sound : Sound when the shutter release button is half-pressed and the camera focuses on the subject.
- Beep sound : Error sound indicating an operation that cannot be performed.
- Level sound : When [Level Setting] is set to [Sound] or [Display+Sound] (P.187), the sound is continually emitted at a set interval when the camera is level in shooting mode.

Available Settings	Description
All *Default setting	All sounds on
Level Sound	Only the level sound is emitted.
Shutter Sounds	Only the shutter sound and level sound are emitted.



Note

- If you try to perform an operation that cannot be performed, the beep sound is emitted regardless of the [Operation Sounds] setting.
- Regardless of the option selected, no sound is emitted when [Discreet Mode] is selected in scene mode.

1 Display the setup menu.

- For the operating procedure, see P.166.

2 Press the ADJ./OK button ▼ to select [Operation Sounds] and press the button ►.

3 Press the button ▲▼ to select the desired setting.

4 Press the ADJ./OK button.

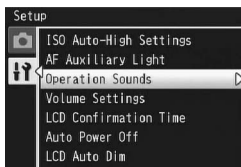

Adjusting/Muting the Operation Sound Volume

The operation sound volume can be changed.

Available Settings

(Mute)

(Small)

(Medium) *Default setting

(Large)

- 1** Display the setup menu.
 - For the operating procedure, see P.166.
- 2** Press the ADJ./OK button ▼ to select [Volume Settings] and press the button ►.
- 3** Press the button ▲▼ to select the desired setting.
- 4** Press the ADJ./OK button.

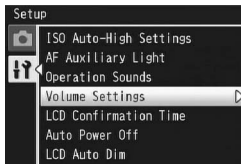

Note

- When [Volume Settings] is set to [] (Mute), the level sound is not emitted even when [Level Setting] is set to [Display+Sound] or [Sound]. (P.187)
- Regardless of the option selected, no sound is emitted when [Discreet Mode] is selected in scene mode.

LCD Image Confirmation Time

Immediately after you press the shutter release button, the still image taken is displayed on the screen for a moment so you can check it. By default, the image confirmation time is set to 0.5 second, but this can be changed.

Available Settings

Off (The image is not displayed for confirmation.)

0.5 seconds *Default setting

1 second

2 seconds

3 seconds

Hold (The image remains displayed until the next time you half-press the shutter release button.)

1 Display the setup menu.

- For the operating procedure, see P.166.

2 Press the ADJ./OK button ▼ to select [LCD Confirmation Time] and press the button ►.

3 Press the button ▲▼ to select the desired setting.

4 Press the ADJ./OK button.

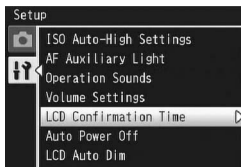

Note

When [LCD Confirmation Time] is set to [Hold], the displayed image can also be enlarged (P.50) or deleted (P.52).

Auto Power Off

If you do not operate the camera for a set period of time, it shuts off automatically to conserve battery power (Auto Power Off). By default, auto power off is set to five minutes, but you can change this setting.

Available Settings

Off (Auto Power Off is turned off)

1 Min.

5 Min. *Default setting

30Min.

1 Display the setup menu.

- For the operating procedure, see P.166.

2 Press the ADJ./OK button ▼ to select [Auto Power Off] and press the button ►.

3 Press the button ▲▼ to select the desired setting.

4 Press the ADJ./OK button.

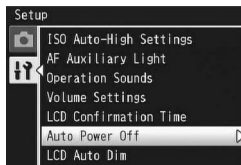

Note

- To continue using the camera after auto power off turned the camera off, press the POWER button to turn the camera on again. You can also press and hold the  (Playback) button to turn the camera on in playback mode.
- Auto power off function does not work when the camera is connected to a computer or printer.
- When using interval shooting, the [Auto Power Off] setting is disabled and the auto power off function does not work.

LCD Auto Dimmer Mode

When [LCD Auto Dim] is set to [On], the picture display dims to conserve battery power if the camera is not moved for approximately five seconds. Move the camera or press any button to return to the original picture display brightness. The default setting is [On].

1 Display the setup menu.

- For the operating procedure, see P.166.

2 Press the ADJ./OK button ▼ to select [LCD Auto Dim] and press the button ►.

3 Press the button ▲▼ to select [On].

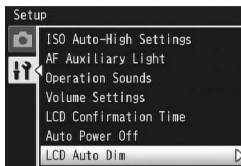

Caution

The [LCD Auto Dim] setting is disabled in synchro monitor mode. (P.56)

Auto Resize Zoom

To record pictures taken with digital zoom at actual size, select [Auto Resize]. This function allows you to crop and record a shot image. Conventional digital zoom enlarges a portion of an image to a set magnification. In contrast, auto resize records pictures taken with digital zoom at actual size, avoiding the drop in image quality that occurs when the image is enlarged. The image recording size changes depending on the auto resize zoom magnification.

Auto resize zoom is available only when [Picture Quality/Size] is set to 3456 × 2592. (P.101)

Available Settings

Available Settings	Description
Normal *Default setting	Normal digital zoom. Records the image at the image size set with [Picture Quality/Size].
Auto Resize	Automatically resizes and then records the image.



Note

The digital zoom is enabled when [Picture Quality/Size] is set to a size other than 3456 × 2592.

Zoom Magnification and Recorded Image Size

Picture Quality/Size	Zoom Magnification	Focal Length ^(*)
3456 × 2592(9M)	1.0 ×	300 mm
3072 × 2304(7M)	1.1 ×	330 mm
2592 × 1944(5M)	1.3 ×	400 mm
2048 × 1536(3M)	1.7 ×	500 mm
1280 × 960(1M)	2.7 ×	810 mm
640 × 480(VGA)	5.4 ×	1620 mm

(*) Equivalent to that on a 35 mm camera

1 Display the setup menu.

- For the operating procedure, see P.166.

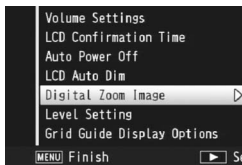
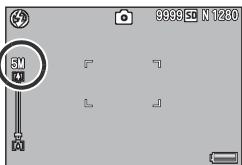
2 Press the ADJ./OK button ▼ to select [Digital Zoom Image] and press the button ►.**3** Press the button ▲▼ to select [Auto Resize].**4** Press the ADJ./OK button.**5** Turn and hold the zoom lever toward [▲] (Telephoto) until the maximum magnification is reached on the zoom bar, then momentarily release the zoom lever, and then turn the zoom lever again toward [▲].

- Each time you turn the zoom lever toward [▲], the image is resized by one setting.
- The size at which the image is recorded is displayed above the zoom bar.

Caution-----

- This function is not available when scene mode is set to [Skew Correct Mode]. If [Auto Resize] is set in these situations, the digital zoom is activated instead.
- If the picture quality is set to Fine mode and the auto resize zoom is used, the compression ratio changes to Normal when recording.

Level Confirmation

When [Level Setting] is turned on, the camera uses a level indicator and sounds to let you know whether the image is level. You can select from the following level confirmation settings. For information on how to use the level function during shooting, see P.58.

Available Settings	Description
Off	The level indicator will not display. The level sound will not emit.
Display *Default setting	The level indicator will display. The level sound will not emit.
Display+Sound	The level indicator appears on the screen and a level sound is emitted when the camera is level.
Sound	The level indicator will not display. A level sound is emitted when the camera is level.

1 Display the setup menu.

- For the operating procedure, see P.166.
- You can also press and hold the DISP. button in shooting mode to display the setting menu. If you pressed and held the DISP. button, skip to Step 3.

2 Press the ADJ./OK button ▼ to select [Level Setting] and press the button ►.



3 Press the button ▲▼ to select the desired setting.

4 Press the ADJ./OK button.



Note

- For information on how to use the level function during shooting, see P.58.
- The level function is not available when recording movies or during interval shooting.
- When [Volume Settings] is set to [□ □ □] (Mute), the level sound is not emitted even when [Level Setting] is set to [Display+Sound] or [Sound].

Grid Guide Display Options

Choose the type of framing grid available in shooting mode.

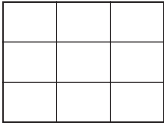
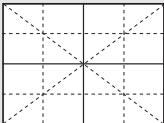
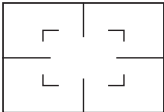
Available Settings	Description
 *Default setting	A three-by-three grid for "rule of thirds" composition.
	A four-by-four grid with diagonal lines running from corner to corner makes it easy to find the center of the subject. Use for architectural photography or photographing products for display.
	A two-by-two grid with the center of the frame left clear to make it easier to view the subject. Use if your subject is in motion.

1 Display the setup menu.

- For the operating procedure, see P.166.

2 Press the ADJ./OK button ▼ to select [Grid Guide Display Options] and press the button ▶.

3 Press the button ▲▼ to select the desired setting.

4 Press the ADJ./OK button.

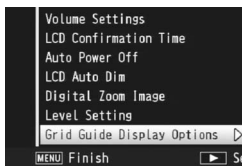

Shooting Information Display Frame

When [Shooting Info. Display Frame] is set to [On], you can display the shooting information display frame for normal symbol display or histogram display (☞ P.56). With the shooting information display frame, the shooting information is not displayed over the subject, so you can more easily compose your shot.

1 Display the setup menu.

- For the operating procedure, see P.166.

2 Press the ADJ./OK button ▼ to select [Shooting Info. Display Frame] and press the button ►.

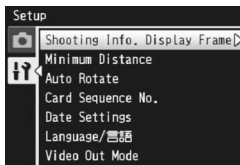

3 Press the button ▲▼ to select [On].

4 Press the ADJ./OK button.

5 Press the DISP. button to change the display.

- The shooting information display frame can be used with normal symbol display and histogram display. (☞ P.56)

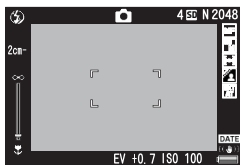

Note

- In easy shooting mode, the display cannot be changed using the DISP. button.
- Shooting information display frame cannot be used in movie mode.

Minimum Shooting Distance Display

During shooting, the minimum shooting distance changes depending on the zoom position. To display the minimum shooting distance on the screen, set [Minimum Distance] to [Show].

1 Display the setup menu.

- For the operating procedure, see P.166.

2 Press the ADJ./OK button ▼ to select [Minimum Distance] and press the button ►.

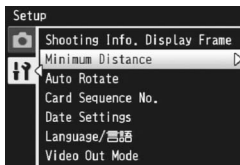

3 Press the button ▲▼ to select [Show].

4 Press the ADJ./OK button.

- The minimum shooting distance is displayed on the screen.

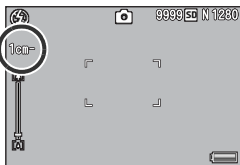

Automatic Rotation of Playback Images

You can set the camera to automatically rotate the image during playback according to the position of the camera.

Available Settings	Description
On *Default setting	The playback image is automatically rotated.
Off	The playback image is not automatically rotated.

When [Auto Rotate] is set to [On], the direction of the playback image will be as follows.

When you play back images with the camera held horizontally:

Images shot with the camera held horizontally will appear with the same horizontal orientation. Images shot with the camera held vertically will automatically be rotated to a vertical orientation.

When you play back images with the camera held vertically:

Images shot with the camera held vertically will appear with the same vertical orientation. Images shot with the camera held horizontally will automatically be rotated to a horizontal orientation.

When the camera is rotated during playback, the image is automatically rotated according to the camera position.

1 Display the setup menu.

- For the operating procedure, see P.166.

2 Press the ADJ./OK button ▼ to select [Auto Rotate] and press the button ►.

3 Press the button ▲▼ to make the setting.

4 Press the ADJ./OK button.

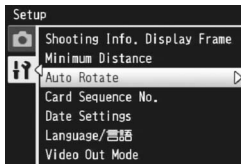



Caution

- The playback image is not automatically rotated, even when [Auto Rotate] is set to [On], in the following cases.
 - When playing back images shot in movie mode.
 - In thumbnail view (📖 P.48)
 - When playing back images shot with the camera tilted too far forward or backward.
 - When playing back images upside-down (with the shutter release button facing down)
 - When changing the camera position during magnified playback.
 - When the image is going through skew correction (the correction area is displayed in playback mode (📖 P.152))
- When playing back a slide show or viewing camera images on a TV, the camera is detected as being in the horizontal position even when [Auto Rotate] is set to [On]. In this case, when you play back images with the camera positioned vertically, images shot horizontally are not automatically rotated. The playback images are not automatically rotated even if you rotate the camera during playback.



Note

The following types of images are automatically rotated according to the orientation of the first image.

- Images shot using dynamic range double shot with [Plus Normal Shooting] set to [On].
- Images shot using bracket shooting, normal continuous mode, M-Cont Plus, Speed Cont or Multi-trgt AF.

File Name Settings

When you shoot a still image, it is stored on an SD memory card or in the internal memory with a consecutively numbered file name that is automatically assigned.

When you switch SD memory cards, you can set your camera to continue consecutive numbering from the previously loaded card.

Available Settings	Description
On (Continue numbering)	File names are automatically assigned to still images you take, in the format of "R" followed by seven digits, from R0010001.jpg to R9999999.jpg. With this setting, file numbering is continued even when the SD memory card is exchanged.
Off (Do not continue numbering) *Default setting	File numbering is assigned, from RIMG0001.jpg to RIMG9999.jpg, for each SD memory card. When the file name reaches RIMG9999, no more data can be recorded to that card.

1 Display the setup menu.

- For the operating procedure, see P.166.

2 Press the ADJ./OK button ▼ to select [Card Sequence No.] and press the button ►.

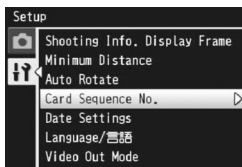

3 Press the button ▲▼ to select the desired setting.

4 Press the ADJ./OK button.



Note

- When data is recorded to the internal memory, files are assigned consecutively numbered file names, just as if [Card Sequence No.] is set to [Off].
- When images are transferred to a computer using DL-10 (P.212), the file being transferred is renamed and saved. The file is saved with the name "RIMG****.jpg" (where **** indicates a number) even if [Card Sequence No.] is set to [On].



Caution

When the file name reaches RIMG9999 or R9999999, no more files can be saved. In this case, move image data from the SD memory card to the memory of the computer or a storage medium, and then format the SD memory card.

Date and Time Settings

You can shoot still images with the time or date stamped onto the picture.

The date/time setting on the setup menu is explained here.

1 Display the setup menu.

- For the operating procedure, see P.166.

2 Press the ADJ./OK button ▼ to select [Date Settings] and press the button ►.

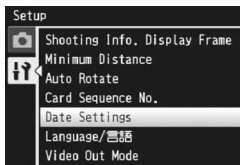

3 Press the button ▲▼◀▶ to set the year, month, date, time and format.

- Change the setting with ▲▼ and move the item with ◀▶.

4 Check the information on the screen and then press the ADJ./OK button.

- The confirmation screen appears.

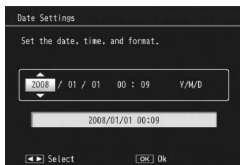

5 Press the ADJ./OK button.

- Once you have set the date and time, the display returns to the setup menu.

6 Press the MENU button or the ADJ./OK button.



Note

- If the battery is removed for more than one week, the date and time settings will be lost. These settings must be made again.
- To retain the date and time settings, load a battery with adequate remaining power for more than two hours.

Language Settings

You can change the language displayed on the screen. The default setting varies depending on where you purchased the camera.

Available Settings	
日本語 (Japanese)	Русский (Russian)
English	简体中文 (Simplified Chinese)
Deutsch (German)	繁体中文 (Traditional Chinese)
Français (French)	한국어 (Korean)
Italiano (Italian)	ไทย (Thai)
Español (Spanish)	_____

1 Display the setup menu.

- For the operating procedure, see P.166.

2 Press the ADJ./OK button ▼ to select [Language/言語] and press the button ►.

- The language selection screen appears.

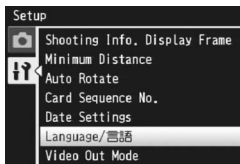

3 Press the button ▲▼◀▶ to select the desired setting.

4 Press the ADJ./OK button.

- Once you have set the language, the display returns to the setup menu.

5 Press the MENU button or the ADJ./OK button.



TV Playback Method

You can view your still images and movies on a television screen by connecting your camera to a television with the AV cable that came with your camera. (P.163)

Your camera is set to NTSC video format (used in North America and other countries/regions) for use with television equipment and other audiovisual equipment. If the equipment you want to connect to uses PAL format (used in Europe and elsewhere), then switch your camera to PAL format before connecting.

The default setting varies depending on where you purchased the camera.

Available Settings

NTSC

PAL

1 Display the setup menu.

- For the operating procedure, see P.166.

2 Press the ADJ./OK button ▼ to select [Video Out Mode] and press the button ►.

3 Press the button ▲▼ to select the desired setting.

4 Press the ADJ./OK button.

- Once you have set the video format, the display returns to the Setup menu.

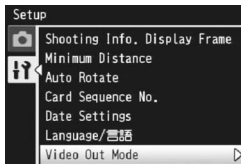

Note

This camera is not compatible with SECAM format.

Instructions in this manual to “Press the ADJ./OK button ▲▼◀▶” indicate that you should press the ADJ./OK button in the up, down, left or right direction. Instructions to “Press the ADJ./OK button” indicate that you should press directly down on the button.

About the Direct Print Function

The Direct Print standard enables direct printing from a camera to a printer by connecting them via a USB cable. Photos can be printed quickly and easily from your digital camera without using a computer.



Caution

You cannot print AVI files (movies) or MP files with this function.



Note

- This camera uses PictBridge, an industry standard for Direct Printing.
- Your printer must be compatible with PictBridge to use the Direct Print function. For support information, see the documentation that came with the printer.

Connecting the Camera to a Printer

Connect your camera to a printer using the USB cable provided.

1 Make sure that the camera is off.

2 Connect your camera to a printer using the USB cable provided.

- Your camera turns on automatically.
- Turn on the printer if it is not already on.

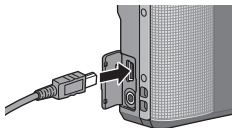

Note

To disconnect the camera from the printer, check that the camera is turned off after printing is finished, and disconnect the USB cable.



Caution

- Do not force the USB cable into the terminal.
- Do not apply excessive force with the USB cable connected.
- When using the USB cable, do not move the camera with the USB cable.

Printing Still Images

You can print still images from the camera with a PictBridge-compatible printer.

Still images are sent from the internal memory when no SD memory card is loaded or from an SD memory card when one is loaded.



Caution

Do not disconnect the USB cable during printing.



Note

- If a [Printer Error.] message appears during image transfer, check the printer status and take the appropriate action.
- If a computer connection message appears even though the camera is connected to the printer, reconnect the camera and press the ADJ./OK button within 2 seconds.

Printing One or All Still Images

1 Check that the printer is ready to print.

- The [Connecting...] screen appears.



2 Press the ADJ./OK button.

- The Direct Print playback mode screen appears.

3 Press the ADJ./OK button ▲▼◀▶ to select an image for printing.

4 Press the ADJ./OK button.

5 Press the ADJ./OK button ▲▼ to select [1 File] or [All Files].

6 Press the ADJ./OK button.

- The Direct Print menu appears.

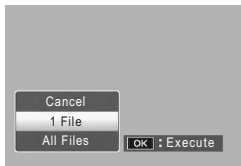

7 Press the ADJ./OK button ▲▼ to select an item, and then press the button ► to display the detailed options screen.

- When [Connecting...] is displayed, the connection to the printer is not yet established. When a connection is established, [Connecting...] disappears and [Direct Print] appears. Proceed with this step after the connection is established.
- The following items can be selected. Each item is available only when supported by the printer connected to the camera.

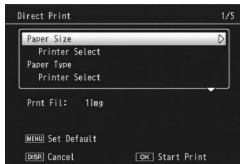

Item Name	Description
Paper Size	Sets the paper size.
Paper Type	Sets the paper type.
Layout	Sets the number of images printed on a sheet of paper. The number of images that can be laid out on a sheet of paper varies depending on the connected printer.
Date Print	Selects whether to print the date (shooting date). The date format can be set using the date/time option in the setup menu. If the picture was taken using [Date Imprint] (P.123), only the imprinted date will be printed.
File Name Print	Selects whether to print the file name.
Optimize Image	Selects whether to optimize the image data (still image) prior to printing on the printer.
Print Size	Sets the print image size.
Print Quality	Sets the print quality.
Report Print ^(*)	Prints on forms.
Printing Quantity	Sets the print quantity.
Toner Saving ^(*)	Selects whether to conserve toner by using less ink during printing.
1-Side/2-Sides ^(*)	Selects whether to print on both sides of the paper. During duplex printing, one copy is printed for each still image. Only one copy is printed even if you selected more than one copy to print in Step 6 on P.202.

^(*) Each item is available only when supported by the Ricoh printer connected to the camera.

8 Press the ADJ./OK button ▲▼ to select the setting, and then press the ADJ./OK button.

- The display returns to the Direct Print menu.

9 Repeat Steps 7 and 8 to change other settings as required.



Note

- To specify the settings as the default settings next time the camera is connected to the printer, press the MENU button when the screen in Step 7 is displayed. When the screen at the right appears, press the ADJ./OK button ◀▶ to select [Yes] and press the ADJ./OK button.
- To use the settings last set the next time the camera is connected to the printer, select [No].

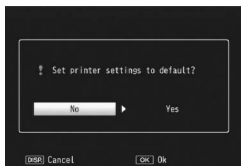

10 Press the ADJ./OK button.

- The selected still images are sent to the printer and the [Sending...] screen appears.
- Pressing the DISP. button cancels the operation.
- When the images have been sent to the printer, the display returns to the Direct Print playback mode screen and printing starts.

Printing Several Still Images

1 Check that the printer is ready to print.

- The [Connecting...] screen appears.

2 Press the ADJ./OK button.

- The Direct Print playback mode screen appears.







3 Turn the zoom lever toward  (Thumbnail View).

- The screen is divided into 20 frames and thumbnails are displayed.

4 Press the ADJ./OK button     to select a still image for printing.

5 Press the ADJ./OK button.

6 Press the ADJ./OK button   to set the number of copies to print.

- Press the button  to increase the number of copies, or press the button  to decrease the number of copies.

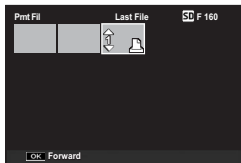

7 Press the button   to select the next still image for printing.

8 Press the button   to set the number of copies to print.

9 Repeat Steps 7 and 8 to select all the still images to be printed and the number of copies for each.

10 Press the ADJ./OK button.

- The Direct Print menu appears.

11 Press the ADJ./OK button ▲▼ to select an item, and then press the button ► to display the detailed options screen.

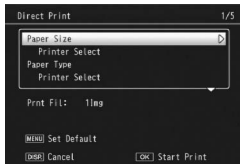

- When [Connecting...] is displayed, the connection to the printer is not yet established. When a connection is established, [Connecting...] disappears and [Direct Print] appears. Proceed with this step after the connection is established.
- For available settings, see P.200.

12 Press the ADJ./OK button ▲▼ to select the setting, and then press the ADJ./OK button.

- The display returns to the Direct Print menu.

13 Repeat Steps 11 and 12 to change other settings as required.

14 Press the ADJ./OK button.

- The selected still images are sent to the printer and the [Sending...] screen appears.
- Pressing the DISP. button cancels the operation.
- When all the selected still images have been sent from the camera to the printer, the camera display returns to the Direct Print playback mode screen.



Note-----

- Only images with a printer symbol () are printed. If you cancel printing and then try to print again, make sure that the printer symbol is on the images you want to print.
- The same still image can also be printed several times on a single sheet.
- The available items vary depending on the functions of the printer.
- To print images using the printer's default settings, select [Printer Select] on the detailed options screen.

9 Downloading Images to Your Computer

The screen images shown here may differ from the images displayed on your computer depending on your computer OS.

For Windows

Refer to P.217 for Macintosh.

You can download images to a computer using either of the following methods.

1 Download images using DL-10 or other image download software. (👉 P.212)

To use DL-10, you must install the software from the supplied CD-ROM (👉 P.206).

2 Download images without using DL-10 or other image download software. (👉 P.213)



Caution

Pictures can not be copied from the camera to computers running Windows 98 or Windows 98SE. Use a card reader to copy pictures from a memory card (👉 P.215).



Note

For details on how to download images from the camera to your computer, see the "Software User Guide" available from the supplied CD-ROM. For how to display the "Software User Guide", see P.210.

System Requirements for Using the Supplied CD-ROM

The following environments are necessary for using the supplied CD-ROM.

Please check your computer, or the computer's user manual.

Operating Systems Supported	Windows 2000 Professional Service Pack 4 Windows XP Home Edition Service Pack 3/Professional Service Pack 3 Windows Vista Service Pack 2
CPU	Windows 2000/Windows XP: Pentium® III 500 MHz or faster Windows Vista: Pentium® III 1 GHz or faster
Memory	Windows 2000/Windows XP: 256 MB or more Windows Vista: 512 MB or more
Hard drive space required for installation	160 MB or more
Display Resolution	1024 × 768 pixels or greater
Display Colors	65,000 colors or greater
CD-ROM Drive	A CD-ROM drive compatible with the above-mentioned computer
USB Port	A USB port compatible with the above-mentioned computer



Caution

- The supplied CD-ROM is not supported on 64-bit versions of the Windows operating system.
- The supplied CD-ROM is not supported on Windows 98/Windows 98 SE and Windows Me.
- If your computer has an upgraded OS, the USB function may not work normally, so it cannot be supported.
- The provided software may not operate properly if changes are made to the operating system, such as with patches and service package releases.
- The camera does not support connection to a USB port added by using an extension function (PCI bus or other).
- If used in conjunction with a hub or other USB devices, the software may not work properly.
- When dealing with movies and other large files, a larger memory environment is recommended.

CD-ROM Setup

Once you insert the supplied CD-ROM in the CD-ROM drive, the installer screen appears automatically.



Item Name	Description	Refer to
Installing the software	Use this button to install software required for batch downloading and editing of images.	P.206
Browse User's Manual (Software Version)	Click this to display the "Software User Guide" (PDF).	P.210
Browse CD-ROM Content	Click this to display the list of files contained on the CD-ROM.	P.210

When [Installing the software] Is Clicked

The following software will be installed:

Software	Description
DL-10	Downloads images collectively to your computer.
Irodio Photo & Video Studio	Shot images can be displayed, managed, or edited.
USB Driver	Used to connect an earlier model Ricoh camera to a computer running Windows 98/Windows 98 SE/Windows Me/Windows 2000. Not available with this camera.
WIA Driver	Used to connect an earlier model Ricoh camera to a computer running Windows XP/Windows Vista. Not available with this camera.



Caution

- Do not install the software when the camera is connected to your computer with a USB cable.
- The names for DC Software items differ from the names for Caplio Software items provided with previous models as shown below.

Caplio Software	DC Software
RICOH Gate La	DL-10
Caplio Viewer	DU-10 ^(*)
Caplio Server	SR-10 ^(*)
Caplio Setting	ST-10 ^(*)

^(*) Not used with this camera.

If Caplio Software from a CD-ROM supplied with a previous model is already installed on your computer, a message asking you to uninstall the Caplio Software before installing DC Software will appear when you try to install the new software. Please follow the instructions in the message.

If Caplio Viewer, Caplio Server, or Caplio Setting is already installed on your computer, it will be replaced with the new software and you will be able to continue using the software as before.

If you have already uninstalled the Caplio Software before the message appears (P.211), DU-10, SR-10, or ST-10 will not be installed even if you install DC Software.

- Note that uninstalling the software for earlier Ricoh cameras may reset user preferences for DL-10 or RICOH Gate La.
- Administrator privileges are required for installation.
- DL-10 is not network-compatible. Use as a stand-alone application.



Note

The camera is provided with Irodio Photo & Video Studio software that allows you to display and edit images from your computer. For how to use Irodio Photo & Video Studio, see the displayed "Help".

For the latest information about Irodio Photo & Video Studio, access the Web page of Pixela Co., Ltd. (http://www.pixela.co.jp/oem/irodio/e/irodio_digitalphoto_videostudio/).

Here is an example of the Windows XP screen.

1 Start your computer and insert the supplied CD-ROM in the CD-ROM drive.

Operating systems other than Windows Vista

- The installer screen appears automatically.

Windows Vista

- The Autorun screen appears automatically.
- Select [Run Autorun.exe]. The installer screen appears automatically.



2 Click [Installing the software].

Operating systems other than Windows Vista

- After a while, the [Choose Setup Language] screen appears.

Windows Vista

- A screen appears to confirm user account management.
- Select [Allow] for the access request to the computer. After a while, the [Choose Setup Language] screen appears.

3 Confirm the language, and then click [OK].

- The [Welcome to the InstallShield Wizard for DC Software] screen appears.

4 Click [Next].

- The [Choose Destination Location] screen appears.

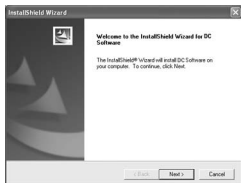

5 Confirm where you want to install and then click [Next].

- The [Select Program Folder] screen appears.

6 Confirm the destination location and then click [Next].

- The Irodio Photo & Video Studio installer starts. Install Irodio Photo & Video Studio following the messages displayed on the screen. Depending on your computer, it may take some time until the next screen is displayed.

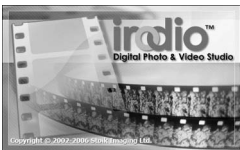
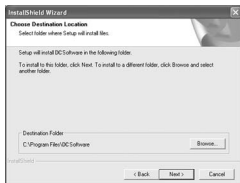

- When installation of Irodio Photo & Video Studio is completed, a dialog box appears, indicating that all software applications have been installed.

7 Click [Finish].

- A dialog box indicating that installation of DC Software is complete appears.



8 When a message appears asking you to restart your computer, select [Yes, I want to restart my computer now.] and then click [Finish].

- Your computer will restart automatically.
- After your computer restarts, a Windows security warning message appears.

9 Click [Unblock] for DL-10.



Note

You can remove (uninstall) the software. (P.211)

When [Browse User's Manual (Software Version)] Is Clicked

The "Software User Guide" (PDF file) on the CD-ROM is displayed on your computer screen.

If you have Acrobat Reader or Adobe Reader installed on your computer, simply click [Browse User's Manual (Software Version)]. Adobe Reader must be installed to view the PDF file.

When [Browse CD-ROM Content] Is Clicked

You can check folders and files on the CD-ROM. The CD-ROM contains not only the software installed by clicking [Installing the software] but also Adobe Reader software.

Adobe Reader

Adobe Reader is required to display the operation manual (PDF file). If the computer is running under Windows, Adobe Reader can be installed. Acrobat Reader or Adobe Reader need not be installed if already installed on your computer.



Caution

- Do not install the software when the camera is connected to your computer with a USB cable.
- Administrator privileges are required for installation.



Note

- For details about Adobe Reader, see Help for Adobe Reader.
- To install Irodio Photo & Video Studio alone, double-click "Irodio Photo & Video Studio.exe" in the Irodio Photo & Video Studio folder.
- Installation of Adobe Reader 9.1 requires MSI (Microsoft Windows Installer) version 3.1 or later and either Microsoft Internet Explorer 6.0 or later or Firefox 2.0 or later. Microsoft Internet Explorer and Microsoft Windows Installer are available via Microsoft Update.

- 1 Start your computer, and insert the supplied CD-ROM into the CD-ROM drive.

Operating systems other than Windows Vista

- The installer screen appears automatically.

Windows Vista

- The Autorun screen appears automatically.
- Select [Run Autorun.exe]. The installer screen appears automatically.



- 2 Click [Browse CD-ROM Content].

- The files on the CD-ROM are listed.

- 3 Double-click the [Adobe Reader] folder.

- 4 Double-click the [English] folder.

- 5 Double-click [AdbeRdr910_en_US_Std] (AdbeRdr910_en_US_Std.exe).

- A screen appears to confirm user account management for Windows Vista. Select [Continue].

- 6 Install Adobe Reader by following the messages displayed.

Uninstalling the Software

Caution

- Administrator privileges are required.
- If any other program is active or unsaved data remains, save the data and terminate the program before uninstalling.

DC Software

- 1 Click [Start] on the Windows task bar.

- 2 Select [Settings]-[Control Panel] ([Control Panel] for Windows XP/Windows Vista).

- 3 Double-click the [Add/Remove Programs] icon (or the [Add or Remove Programs] icon in Windows XP).

- 4** Select [DC Software], and then click the [Change/Remove] button.
- 5** Confirm file deletion and click [OK].
 - The [Shared File Detected] dialog box appears.
- 6** Select the [Don't display this message again.] check box, and then click [Yes].
 - The uninstallation process begins. When it is finished, close the displayed window.

Irodio Photo & Video Studio

- 1** Click [Start] on the Windows task bar.
- 2** Select [Settings]-[Control Panel] ([Control Panel] for Windows XP/Windows Vista).
- 3** Double-click the [Add/Remove Programs] icon (or the [Add or Remove Programs] icon in Windows XP).
- 4** Select [Irodio Photo & Video Studio] and then click [Change/Remove].
- 5** Confirm file deletion and click [OK].
 - The uninstallation process begins. When it is finished, close the displayed window.
- 6** Restart your computer.

Downloading Images Using DL-10

After installing the software on your computer, connect your camera to the computer.

- 1** Make sure the camera power is off.
- 2** Connect the USB cable to the USB port of your computer.

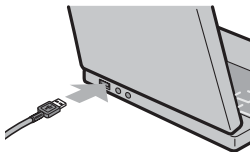

3 Connect the USB cable to the USB terminal of your camera.

- Your camera turns on and the computer automatically reads the necessary files.

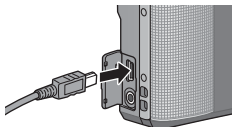

4 DL-10 starts and image transfer begins automatically.

- DL-10 automatically creates a folder called [Digital Camera] inside your [My Documents] folder. Downloaded images are saved in folders with the date of each shot, inside the [Digital Camera] folder. (The files will continue to be saved in the [Caplio] folder if you were previously using Caplio Software.) Set the correct date and time on the camera before shooting.

5 When image transfer is completed, disconnect the camera and the computer. (☞ P.216)



Note-----

If image transfer does not begin, please try the following procedures.

- Click the [Save] button in the DL-10 window.
- Restart your computer and perform Steps 1 to 5 again.
- Confirm that the [Saves automatically when connected to USB] checkbox in the [Option Settings] dialog box for DL-10 is selected.



Caution-----

- Do not force the USB cable into the terminal.
- Do not apply excessive force with the USB cable connected.
- When using the USB cable, do not move the camera with the USB cable.

Downloading Images Without Using DL-10

You can download images from the camera to a computer without having to use software.

1 Make sure that the camera power is off.

2 Connect the accessory USB cable to a USB port of your computer.

3 Connect the USB cable to the USB terminal of your camera.



- Your camera turns on.
- Your computer automatically reads a file necessary for recognizing the camera as a drive.
- After this preparation, the camera is displayed as a drive under [My Computer].

Example of the display in Windows XP

4 From the displayed drive, copy a file to the desired location.

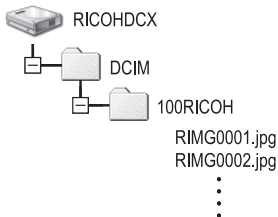

Example of the display in Windows XP

⚠ Caution

- Do not turn off the camera or disconnect the USB cable during image transfer.
- If a file with the same name already exists at the destination, it is overwritten. If you do not want the file to be overwritten, transfer data to another folder, or change the file name of the file at the destination.

📄 Note

When an SD memory card is loaded, its files are displayed. Otherwise, files in the internal memory are displayed.



Downloading Images from an SD Memory Card-----

It is possible to download images from an SD memory card to the computer via a PC card slot or card reader. Depending on the type of PC card slot or card reader, a memory card adapter may be required when using an SD memory card. If the SD memory card can be used in the PC card slot, no memory card adapter is required.

- Images are stored in an SD memory card in the hierarchy shown below.

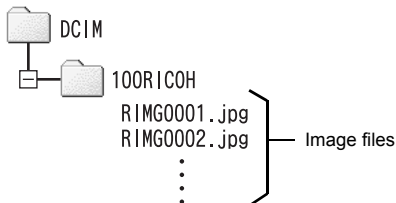

Example of the display in Windows XP

Card Reader

This is a device connected to a computer to read the contents of cards. In addition to the memory card adapter-type, there are card readers compatible with various types of cards, into which you can directly load an SD memory card.

Use a card reader that is compatible with your computer's operating system and the size of the SD memory card.



Caution-----

If you connect the camera or a card reader to a computer and then directly display, edit or save SD memory card images on the computer, you may no longer be able to play back the images on the camera. Download the images to the computer before displaying, editing or saving them.

Disconnecting the Camera from Your Computer

Before disconnecting the camera from the computer, click the [Safely Remove Hardware] or [Unplug or Eject Hardware] icon in the taskbar (the illustration above shows the icon for Windows XP) and select [Safely Remove USB Mass Storage Device] or [Stop USB Mass Storage Device] from the menu that appears. You can then disconnect the USB cable.



Note

- If the USB cable is disconnected without disabling the connection, the Unsafe Removal of Device screen may be displayed. Be sure to stop the connection before removing the USB cable.
- Do not disconnect the USB cable during image downloading. Make sure that downloading has completed, disable the connection, and then disconnect the cable.

For Macintosh

Refer to P.204 for Windows.

This camera supports the following Macintosh operating systems.

- Mac OS 9.0 to 9.2.2
- Mac OS X 10.1.2 to 10.5.7



Caution

VM-1 software can be installed on Macintosh computers as described on P.219. More information is available in the "Software User Guide" (note that Acrobat Reader is required to view the "Software User Guide" under Mac OS 9).

Downloading Images to Your Computer

1 Make sure that the camera power is off.

2 Connect the accessory USB cable to a USB port of your computer.

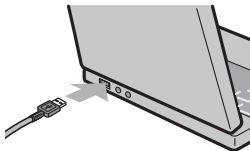

3 Connect the USB cable to the USB terminal of your camera.

- Your camera turns on.
- Your computer automatically reads the file necessary for recognizing the camera as a drive.
- After this preparation, the camera is displayed as a drive on the Desktop.

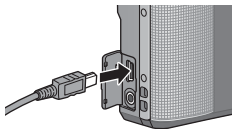

4 From the displayed drive, copy a file to the desired location.

- The figure below shows the folder configuration in the drive.
- When the contents of the internal memory are displayed, the drive name is [RICOHDCI].

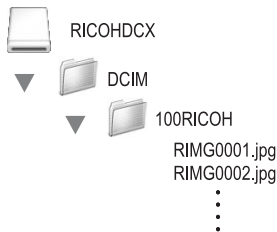

Caution

- Do not force the USB cable into the terminal.
- Do not apply excessive force with the USB cable connected.
- When using the USB cable, do not move the camera with the USB cable.

Disconnecting the Camera from Your Computer

1 Drag and drop the displayed drive or the volume icon to the "Trash".

- If a screen appears prompting you to enter the administrator's password, enter the password.

2 Disconnect the USB cable.

Note

- You can also click [Eject] on the [Special] menu in Mac OS 9 or the [File] menu in Mac OS X to cancel the connection.
- If the USB cable is disconnected without disabling the connection, the Unsafe Removal of Device screen may be displayed. Be sure to stop the connection before removing the USB cable.
- Do not disconnect the USB cable during image downloading. Make sure that downloading has completed, disable the connection, and then disconnect the cable.
- When you connect your camera to a Macintosh computer, a file called "FINDER.DAT" or ".DS_Store" may be created in your SD memory card, which will appear as [Unmatched File] on your camera. You can delete this file from the SD memory card if you wish.

Using the MP File Viewer

When you shoot one still image with M-Cont Plus, Speed Cont, or Multi-trgt AF, the image is recorded as one MP file.

By using the VM-1 MP file viewer, you can play back MP files on your Macintosh computer and export still images.

This section explains how to install and uninstall the VM-1 software included on the supplied CD-ROM. For details on how to play back MP files on your computer or export still images from MP files using the MP file viewer, see the “Software User Guide” available from the supplied CD-ROM.

System Requirements for Using the Supplied CD-ROM

The following environments are necessary for using the supplied CD-ROM.

Please check your computer, or the computer’s user manual.

Operating Systems Supported	Mac OS X 10.4 to 10.5.7
Macintosh computer	Apple Inc. Macintosh Series
Internal Memory	Mac OS X 10.4 256 MB or more Mac OS X 10.5 512 MB or more
Hard Disk Available Memory	5 MB or more
CD-ROM Drive	A CD-ROM drive compatible with the above-mentioned Macintosh computer



Note

VM-1 supports Japanese, English, French and Chinese (Simplified).

Installing VM-1

- 1 Start your Macintosh computer and insert the supplied CD-ROM in the CD-ROM drive.**
- 2 Double-click the [RICOH] icon.**
- 3 Double-click the [VM-1] folder.**
- 4 Double-click the [VM-1 Installer.pkg] icon.**
 - The [Install VM-1] window is displayed.
- 5 Click [Continue].**
 - The window for selecting the installation location appears.

6 Select the disk for installation, and then click [Continue].

7 Click [Install].

- To change the installation location, click [Change Install Location...].
- To upgrade VM-1, click [Upgrade].
- The window for entering your name and password appears.

8 Enter your name and password, and then click [OK].

- A message appears to notify you that the installation is complete.

9 Click [Close].

Deleting (Uninstalling) VM-1

⚠ Caution-----

- If you have any other software applications running or data that has not been saved, quit the other software applications and save the data before uninstalling VM-1.
- If an error occurs during the uninstallation process, update your Mac OS to the latest version.

1 Open the [Applications] folder.

2 Open the [Utilities] folder.

3 Open the [VM-1 Utility] folder.

4 Double-click the [VM-1 Uninstaller] icon.

- The uninstall confirmation window appears.

5 Click [OK].

- The window for entering your name and password appears.

6 Enter your name and password, and then click [OK].

- A message appears to notify you that the uninstallation is complete.

7 Click [OK].

Troubleshooting

Error Messages

If an error message is displayed on the screen, check the information on the reference page and take the corresponding action.



Error Message		Refer to
Insert card.	No card is loaded. Insert a card.	P.26
Set date.	The date is not set. Set the date.	P.194
The file number limit has been exceeded.	The file number limit has been exceeded. Use another card.	P.193
Unmatched File	This file cannot be displayed on the camera. Check the file contents on your computer, and then delete the file.	-
Insufficient memory. Continue?	All the files cannot be copied because there is insufficient memory on the card. Use another card.	P.23
Protected	The file selected for deletion is protected.	P.154
Card Is Write-Protected.	The card is locked (write-protected). Unlock the card.	P.24
Print settings cannot be applied to this file.	This file (movie or other file) cannot be selected for printing.	-
Insufficient Memory	Files cannot be stored. Make sure there is sufficient memory or delete unwanted files.	P.52 P.168 P.169
	The image print number limit has been exceeded. Select an image and set the number to 0.	P.202
Format internal memory.	The internal memory requires formatting.	P.169
Format card.	The card is not formatted. Format the card with this camera.	P.168
Card Error	Reformat the card. If the error message still appears after that, the card may be faulty. Do not use the card.	P.168
Writing Data	Writing file to memory. Wait until writing finishes.	-
File not found	There are no files that can be played back.	-
Out of memory. cannot record.	The number of remaining shots is 0. Switch to another card or the internal memory.	P.23
No files to restore.	There are no files to restore.	P.162

Camera Troubleshooting

Power Supply

Problem	Cause	Solution	Refer to
The camera does not turn on.	Battery is not loaded or is exhausted.	Load the rechargeable battery correctly or charge the battery as required.	P.26 P.25
	An unacceptable battery is used.	Use the dedicated rechargeable battery. Never use any other battery.	P.22
	The camera is automatically turned off by auto power off.	Turn the camera back on.	P.28
	The battery is loaded in wrong direction.	Load correctly.	P.26
	Because the camera overheated the power was automatically turned off.	Wait until the temperature of the camera returns to normal. Do not attempt to cool the camera suddenly.	-
The camera turns off during use.	The camera was left unattended and unused, so auto power off turned it off.	Turn the camera back on.	P.28
	Battery is running low.	Charge the rechargeable battery.	P.25
	An unacceptable battery is used.	Use the dedicated rechargeable battery. Never use any other battery.	P.22
The camera does not turn off.	Camera malfunction.	Remove the battery and load it again.	P.26
The battery has been fully charged, but: <ul style="list-style-type: none">The battery symbol is displayed, indicating a low battery level.The camera turns off.	A (manganese dry cell or other) unacceptable battery is used.	Use the dedicated rechargeable battery. Never use any other battery.	P.22
Cannot charge the battery.	Battery has reached the end of its useful life.	Replace with a new rechargeable battery.	P.26
Battery runs out quickly.	It is being used at extreme high or low temperatures.	-	-
	Many shots are being taken in dark places or other location requiring extensive use of flash.	-	-

Shooting

Problem	Cause	Solution	Refer to
The camera does not shoot even if you press the shutter release button.	Battery is exhausted.	Charge the rechargeable battery.	P.25
	The camera is not on.	Press the POWER button to turn the camera on.	P.28
	The camera is in playback mode.	Press the  (Playback) button to select the shooting mode.	P.46
	The shutter release button is not pressed all the way.	Press the shutter release button all the way.	P.34
	The SD memory card is not formatted.	Format the card.	P.168
	The SD memory card is full.	Load a new card, or delete unwanted files.	P.26 P.52
	The SD memory card has reached the end of its useful life.	Load a new SD memory card.	P.26
	The flash is charging.	Wait until the flash mode symbol stops blinking.	P.43
	The SD memory card is locked.	Unlock the card.	P.24
The contact surface of the SD memory card is dirty.		Wipe with a soft, dry cloth.	-
Unable to view the shot image.	The image confirmation time is too short.	Lengthen the image confirmation time.	P.182
Images do not appear on the picture display.	The camera is not on or the picture display is dark.	Turn the camera on or adjust the brightness of the picture display.	P.28 P.170
	The VIDEO/AV cable is connected.	Disconnect the VIDEO/AV cable.	-
	The screen display is in synchro-monitor mode.	Press the DISP. button to change the display.	P.56
Although the camera is set to auto focus, it is unable to focus.	The lens is dirty.	Wipe clean with a soft, dry cloth.	-
	The subject is not in the center of the shooting range.	Shoot with focus lock.	P.34
	It is a hard-to-focus subject.	Shoot with focus lock or manual focus.	P.34 P.105
Although the camera is not in focus, the green frame appears in the center of the picture display.	The camera incorrectly focused because the distance to the subject is too close.	Shoot with macro mode or move away from the subject.	P.41
The picture is blurred. (The  symbol appears.)	You moved the camera when pressing the shutter release button.	Hold the camera with your elbows pressed against your body. Use a tripod. Use the camera shake correction function.	P.32 P.121
	When shooting in a dark place (such as indoors), the shutter speed slows down and pictures become easily blurred.	Use the flash. Raise the ISO setting. Use the camera shake correction function.	P.43 P.128 P.121

Problem	Cause	Solution	Refer to
The flash does not fire or the flash cannot charge.	The flash cannot be used in the following cases: <ul style="list-style-type: none"> • In bracket shooting • In continuous mode • In movie mode • In discreet mode In some scene modes, the flash is disabled by default.	To shoot with the flash, change the settings or mode.	P.43 P.112 P.108 P.87 P.94 P.74
	The flash is set to flash off.	Cancel Flash Off.	P.43
	Battery is running low.	Charge the rechargeable battery.	P.25
Even though the flash fired, the picture is dark.	The distance to the subject exceeds the flash range.	Get closer to your subject and shoot. Change the flash mode or the ISO setting.	P.43 P.128
	The subject is dark.	Correct the exposure. (Exposure compensation also changes the light intensity of the flash.)	P.124
	The light intensity of the flash is not appropriate.	Adjust the light intensity of the flash.	P.111
The image is too bright.	The light intensity of the flash is not appropriate.	Adjust the light intensity of the flash. Alternatively, move a little away from the subject or illuminate the subject with another light source instead of using the flash.	P.43 P.111
	Subject is overexposed. (The [!AE] symbol appears.)	Correct the exposure. Cancel exposure time.	P.124 P.117
	The brightness of the picture display is not appropriate.	Adjust the brightness of the picture display.	P.170
The image is too dark.	The shot was taken in a dark place while set to flash off.	Cancel Flash Off.	P.43
	The subject is underexposed.	Correct the exposure. Set to long exposure time.	P.122 P.117
	The brightness of the picture display is not appropriate.	Adjust the brightness of the picture display.	P.170
The image lacks natural color.	The picture was shot in conditions that made it difficult for auto white balance to adjust the white balance.	Add a white object to the composition or use a white balance setting other than auto.	P.126
The date or recording information does not appear on the screen.	The screen display function is set to no display.	Press the DISP. button to change the display.	P.56
The brightness of the picture display changes during AF.	You are using AF in a dark place or when the auto focus range and surrounding brightness are different.	This is normal.	-

Problem	Cause	Solution	Refer to
The level indicator is not displayed.	[Level Setting] is set to [Off] or [Sound].	Set [Level Setting] to [Display] or [Display+Sound].	P.187
	The display is set to a setting other than normal symbol display or histogram.	Press the DISP. button to change the display to normal symbol display or histogram.	P.56
	The camera is upside down (shutter release button is on the bottom).	Hold the camera correctly.	-
The image is tilted even though it was shot with the level indicator in the middle or while the level sound was sounding.	You shot the image while moving, such as on an amusement ride.	Shoot in an environment that is not moving.	-
	The subject is not level.	Check the subject.	-
Self timer lamp does not light.	[Discreet Mode] is selected in scene mode.	Choose another mode.	P.74

Playback/Deleting

Problem	Cause	Solution	Refer to
Cannot play back, or the playback screen does not appear.	The camera is not in playback mode.	Press the  (Playback) button.	P.46
	The VIDEO/AV cable is not connected properly.	Reconnect it properly.	P.163
	The Video Out Mode setting is incorrect.	Set it to the correct format.	P.196
The contents of the SD memory card cannot be played back, or the playback screen does not appear.	No SD memory card is loaded, or an SD memory card with no stored images is loaded.	Load a card with stored images.	-
	You played back an SD memory card that was not formatted with this device.	Load a card that was formatted and recorded with this device.	P.26 P.168
	You played back an SD memory card that was not recorded normally.	Load a normally recorded card.	-
	The contact surface of the SD memory card is dirty.	Wipe with a soft, dry cloth.	-
	There is something wrong with the SD memory card.	Play back images from another card and if there is nothing wrong with the card, the camera is okay. There may be something wrong with the card, so do not use it.	-
The picture display turned off.	Battery is running low.	Charge the rechargeable battery.	P.25
	The camera was left unattended and unused, so auto power off turned it off.	Turn the camera back on.	P.28
Part of the screen flashes in black.	The screen is highlighted due to an overly bright area.	It is recommended that you shoot another image while avoiding direct sunlight and setting the exposure level lower (-).	P.57 P.124
A file cannot be deleted.	The file is protected.	Unprotect the file.	P.154
	The SD memory card is locked.	Unlock the card.	P.24
Cannot format the SD memory card.	The SD memory card is locked.	Unlock the card.	P.24

Other Problems

Problem	Cause	Solution	Refer to
Cannot load the SD memory card.	The card is facing the wrong way.	Load correctly.	P.26
The camera does not operate even when the buttons are pressed.	Battery is running low.	Charge the rechargeable battery.	P.25
	Camera malfunction.	Press the POWER button to turn the camera off, and then press the POWER button to turn the camera on again.	P.28
		Remove the battery and load it again.	P.26
The date is incorrect.	The correct date/time are not set.	Set the correct date/time.	P.194
The set date disappeared.	The battery was removed.	If the battery is removed for more than one week, the date setting will be lost. Make the settings again.	P.194
Auto power off does not work.	Auto power off is set to [Off].	Set the time for auto power off.	P.183
The operation sound cannot be heard.	[Discreet Mode] is selected in scene mode.	Choose another mode.	P.74
	The operation sound volume is turned off.	Use [Volume Settings] to set the volume to a setting other than mute.	P.181
Images do not appear on the TV.	The [Video Out Mode] setting is incorrect.	Set it to the correct format.	P.196
	The AV cable is not connected.	Connect the AV cable properly.	P.163
	The TV is not correctly set to VIDEO IN.	Check that the TV is correctly set to VIDEO IN.	-

Software and Computer Troubleshooting

For details about the software, refer to the “Software User Guide” (PDF file).

Warning Messages Under Windows XP Service Pack 3 and Windows Vista Service Pack 2

When software for your Ricoh digital camera is used on a computer with Windows XP Service Pack 3 or Windows Vista Service Pack 2 installed, the following warning message may appear at software activation or USB connection. With this in mind, refer to the following.

Here is an example of the Windows XP screen.

When this warning message is displayed:

- 1 Check the information provided on the message screen to make sure that it comes from a reputable source, and then click the [Unblock] button.

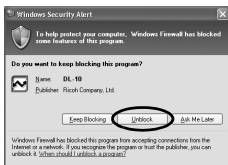

Caution

If you do not recognize the program, you should block it because it may be a virus. Click the [Keep Blocking] button to prevent the program from connecting to the Internet.

If you clicked the [Keep Blocking] button:

Follow the steps below to check the Windows Firewall settings.

- 1 Open the [Windows Firewall] Control Panel.

- Open the [Start] menu and select [Control Panel], then double-click [Windows Firewall] (if Windows Firewall is not listed, click [Switch to Classic View] at the top left corner of the Control Panel window).



2 Allow the Ricoh application Internet access.

- In the [Windows Firewall] dialog, click the [Exceptions] tab and check whether DL-10 is listed under [Programs and Services]. If it is, place a check in the check box next to DL-10 and click OK. If it is not listed, click [Add Program...] to add DL-10 to the list of exceptions.

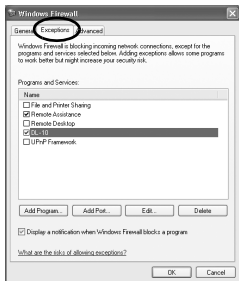

If you clicked the [Ask Me Later] button:

Each time the program is activated, the [Windows Security Alert] dialog box appears. Then you can select [Unblock].

Specifications

No. of effective pixels (camera)		Approx. 9.29 million effective pixels
Image Sensor		1/2.3" CMOS (Approx. 10.29 total million pixels)
Lens	Focal Length	4.9 mm to 52.5 mm (equivalent to 28 mm to 300 mm on a 35-mm camera)
	F-aperture	F3.5 to F5.6
	Shooting Distance	Normal shooting: Approx. 30 cm to ∞ (Wide-angle) or 1.5 m to ∞ (Telephoto) (from the front of the lens) Macro shooting: Approx. 1 cm to ∞ (Wide-angle), 28 cm to ∞ (Telephoto) or 1 cm to ∞ (Zoom macro mode) (from the front of the lens)
	Lens Construction	10 elements in 7 groups (4 aspherical lens elements with 5 surfaces)
Zoom Magnification		Optical zoom at 10.7×, Digital zoom at 4.8×, Auto resize zoom at approx. 5.4× (VGA image)
Focus Modes		Multi AF (Contrast AF method)/Spot AF (Contrast AF method)/Continuous AF/Multi-trgt AF/MF/Snap/∞ (with AF Auxiliary Light)
Antibblur Function		Image Sensor Shift Image Stabilizer
Shutter Speed	Still Image	8, 4, 2, 1 to 1/2000 seconds (The upper and lower limits differ for each shooting mode and flash mode.)
	Movie	1/30 to 1/2000 seconds
Exposure Control	Exposure Metering Mode	Multi Light Metering (256 segments)/Center-weighted Light Metering/Spot Metering
	Exposure Mode	Program AE
	Exposure Compensation	Manual exposure compensation (+2.0 to -2.0 EV in 1/3 EV Steps), Auto bracket function (-0.5 EV, ±0, +0.5 EV)
ISO Sensitivity (Standard Output Sensitivity)		Auto/Auto-Hi/ISO 80/ISO 100/ISO 200/ISO 400/ISO 800/ISO 1600
White Balance Mode		Auto/Multi-pattern Auto/Outdoors/Cloudy/Incandescent Lamp/Incandescent Lamp 2/Fluorescent Lamp/Manual Settings, White balance bracket function
Flash	Flash Mode	Auto flash (fires automatically in low-light conditions and when the subject is backlit)/Red-eye Flash/Flash On/Flash Synchro./Flash Off
	Built-in flash Range	Approx. 20 cm to 3.0 m (Wide-angle), approx. 28 cm to 4.0 m (Telephoto) (ISO Auto/ISO 800, from the front of the lens)
	Flash Compensation	±2.0EV (1/3 EV Steps)
Picture Display		3.0" Transmissive LCD, approx. 920,000 dots
Shooting Mode		Auto shooting mode/Easy shooting mode/Scene mode (Portrait/Sports/Night. Port./Landscape/Nightscape/High Sens/Discreet Mode/Zoom Macro/High Contrast B&W/Miniaturize/Skew Correct Mode/Text Mode)/My Settings Mode/Movie Mode/Dynamic Range Double Shot Mode/Continuous Mode
Picture Quality Mode*1		F (Fine), N (Normal)
Number of Recorded Pixels	Still Image	3456 × 2592, 3456 × 2304, 2592 × 2592, 3072 × 2304, 2592 × 1944, 2048 × 1536, 1280 × 960, 640 × 480
	Multi-Picture	3456 × 2592, 3456 × 2304, 2592 × 2592, 3072 × 2304, 2592 × 1944, 2048 × 1536, 1728 × 1296, 1280 × 960, 640 × 480
	Movie	640 × 480, 320 × 240
	Text	3456 × 2592, 2048 × 1536

Recording Media		SD memory card, SDHC memory card (up to 32 GB), Internal Memory (approx. 88 MB)
Recording Data Capacity	3456 × 2592	N: approx. 1959 KB/Screen, F: approx. 3376 KB/Screen
	3456 × 2304	F: approx. 3002 KB/Screen
	2592 × 2592	F: approx. 2538 KB/Screen
	3072 × 2304	N: approx. 1573 KB/Screen
	2592 × 1944	N: approx. 1155 KB/Screen
	2048 × 1536	N: approx. 767 KB/Screen
	1728 × 1296	N: approx. 581 KB/Screen
	1280 × 960	N: approx. 452 KB/Screen
Recording File Format	640 × 480	N: approx. 110 KB/Screen
	Still Image	JPEG (Exif Ver. 2.21)*2
	Multi-Picture	Compliant with CIPA DC-007-2009 Multi Picture Format
	Movie	AVI (Open DML Motion JPEG Format Compliant)
	Compression Format	JPEG Baseline Format Compliant (Still image, movie)
Other Major Shooting Functions		Continuous mode, Self-timer (operation time: approx. 10 seconds, approx. 2 seconds, Custom), Interval shooting (shooting interval: 5 seconds to 1 hour, in increments of 5 seconds)*3, Color bracket, Focus bracket, AE/AF target shift, Histogram display, Grid guide display, Electronic level
Other Major Playback Functions		Thumbnail view, Enlarged view (maximum ×16), Resize, Level Compensation, White Balance Compensation, Skew Correction, Trim, Flag Function, Slideshow, DPOF
Interface		USB2.0 (High-Speed USB) Mini-B, Mass storage-compatible*4, AV output 1.0Vp-p (75 Ω)
Video Signal Format		NTSC, PAL
Power Supply		Rechargeable Battery (DB-70): 3.6 V
Battery Consumption*5		Usage time of DB-70: approx. 290 pictures (When [LCD Auto Dim] is set to [On])*6)
Dimensions		101.5 mm (W) × 58.3 mm (H) × 29.4 mm (D) (excluding projecting parts)
Weight		Camera: approx. 185 g (excluding battery, SD memory card, and strap) Accessories: approx. 23 g (battery and strap)
Tripod Hole Shape		1/4-20UNC
Date Maintain Time		Approx. 1 week
Operating Temperature		0°C to 40°C
Operating Humidity		85% or less
Storage Temperature		-20°C to 60°C

*1 The picture quality mode that can be set varies depending on the image size.

*2 Compatible with DCF and DPOF. DCF is the abbreviation for "Design rule for Camera File system," a JEITA standard. (Full compatibility with other devices is not guaranteed.)

*3 When the flash is set to [Flash Off].









*4 Mass storage mode is supported by Windows 2000, Windows XP, Windows Vista, Mac OS 9.0 - 9.2.2, and Mac OS X 10.1.2 - 10.5.7.

*5 The number of remaining shots is based on the CIPA standard and may vary depending on usage conditions. This is for reference only.

*6 You can take approximately 270 shots when [LCD Auto Dim] is set to [Off].

Number of Images That Can Be Stored

The following table shows the approximate number of images that can be recorded in the internal memory and onto an SD memory card at various image size and picture quality settings.

Mode	Picture Quality/ Size	Internal Memory	1 GB	2 GB	4 GB	8 GB	16 GB	32 GB
 SCENE (other than Text Mode) EASY  (Continuous Mode) 	F3456(9M)	24	266	539	1058	2163	4335	8695
	N3456(9M)	42	457	931	1828	3737	7487	15020
	F3:2(8M)	27	299	608	1195	2442	4893	9815
	F1:1(6M)	33	353	714	1403	2868	5746	11527
	N3072(7M)	53	570	1159	2277	4654	9324	18704
	N2592(5M)	72	775	1576	3094	6325	12671	25418
	N2048(3M)	109	1184	2363	4640	9486	19005	38125
	N1280(1M)	175	1888	3840	7541	15415	30882	61951
	N640(VGA)	705	7553	15359	30159	61643	123489	247716
 (When [Focus] is set to [Multi- trgt AF])	F3456(9M)	23	255	516	1014	2073	4152	8330
	N3456(9M)	39	425	865	1699	3474	6960	13962
	F3:2(8M)	26	285	579	1138	2327	4662	9352
	F1:1(6M)	31	333	675	1326	2710	5430	10893
	N3072(7M)	48	521	1059	2080	4253	8520	17091
	N2592(5M)	64	686	1397	2743	5606	11231	22529
	N2048(3M)	90	974	1981	3892	7956	15940	31976
	N1280(1M)	133	1438	2926	5746	11745	23530	47202
	N640(VGA)	312	3357	6827	13407	27404	54898	110125
SCENE (Text Mode)	3456 × 2592	42	457	931	1828	3737	7487	15020
	2048 × 1536	109	1184	2363	4640	9486	19005	38125
	640 × 480 (15 Frames/Sec)	1 min 42 s	18 min 20 s	37 min 17 s	76 min 41 s	149min 40 s	299min 50 s	601min 28 s
	640 × 480 (30 Frames/Sec)	51 s	9 min 15 s	18 min 49 s	38 min 41 s	75 min 31 s	151min 18 s	303min 31 s
	320 × 240 (15 Frames/Sec)	4 min 19 s	46 min 19 s	94 min 11 s	193min 41 s	378min 2 s	757min 18 s	1519 min 7 s
	320 × 240 (30 Frames/Sec)	2 min 12 s	23 min 42 s	48 min 13 s	99 min 8 s	193min 30 s	387min 39 s	777min 37 s
 (M-Cont Plus(9M))	N3456(9M)	42	457	931	1828	3737	7487	15020
 (M-Cont Plus(2M))	N1728(2M)	143	1548	3072	6033	12332	24706	49561
 (Speed Cont)	N640(VGA)	705	7553	15359	30159	61643	123489	247716



Note

- The maximum recording time is the estimated total recording time. The maximum recording time per shooting is 90 minutes or the equivalent of 4 GB.
- The maximum number of consecutive shots that can be taken using continuous mode is 999. When the number of remaining shots is 1000 or more, "999" is displayed on the picture display.
- The maximum numbers of shots for M-Cont Plus (2M)/M-Cont Plus (9M) and Speed Cont are the estimated total numbers of shots that can be recorded. The maximum number of shots that can be taken consecutively at one time is 30 for M-Cont Plus (2M) and 15 for M-Cont Plus (9M) and 120 for Speed Cont.
- The maximum number of shots for Multi-trgt AF is the estimated total number of shots that can be recorded. The number of shots that can be recorded at one time is 7. When the number of remaining shots is 9999 or more, "9999" is displayed on the picture display.
- The number of remaining shots displayed on the picture display may differ from the actual number of shots, depending on the subject.
- Movie recording time and the maximum number of still pictures may vary depending on the capacity of the recording destination (internal memory or SD memory card), shooting conditions, and the type and manufacturer of the SD memory card.
- A high speed memory card is recommended when shooting for long periods.

Defaults Settings/Functions Whose Defaults Are Restored When the Camera Is Turned Off

Turning the camera off may reset some function settings to their defaults.

The table below indicates whether or not the function is reset to its default when the camera is turned off.

O : setting is saved × : setting is reset

	Function		Default Settings
Shooting	Picture Quality/Size	O	N3456(9M)
	Density	O	Normal
	Size (Text Mode)	O	3456 (9M)
	Movie Size	O	640
	Frame Rate	O	30 Frames/Sec
	Focus	O	Multi AF
	Pre-AF	O	Off
	Exposure Metering	O	Multi
	Image Settings	O	Standard
	Flash Exposure Compensation	O	0.0
	Dynamic Range Expansion	O	AUTO
	Plus Normal Shooting	O	Off
	Auto Bracket	O	Off
	Time Exposure	O	Off
	Custom Self-Timer	O	Pictures: 2 Pics, Interval: 5 Sec
	Interval Shooting	×	0 Sec.
	Camera Shake Correction	O	On
	Slow Shutter Limit	O	Off
	Date Imprint	O	Off
	Exposure Compensation	O	0.0
	White Balance	O	Multi-P AUTO
ISO Setting	O	Auto	
Macro	O	Macro Off	
Flash	O	Auto	
Self-Timer	×	Self-Timer Off	
Playback	Volume Adjustment	O	-

O : setting is saved × : setting is reset

	Function		Default Settings
Setup	LCD Brightness	O	-
	Reg. My Settings	O	-
	Step Zoom	O	Off
	Set Fn Button	O	Macro Target
	ADJ Button Setting 1	O	Exposure Comp.
	ADJ Button Setting 2	O	White Balance
	ADJ Button Setting 3	O	ISO
	ADJ Button Setting 4	O	Quality
	ISO Auto-High Settings	O	AUTO 400
	AF Auxiliary Light	O	On
	Operation Sounds	O	All
	Volume Settings	O	■ ■ □ (Medium)
	LCD Confirmation Time	O	0.5 seconds
	Auto Power Off	O	5 Min.
	LCD Auto Dim	O	On
	Digital Zoom Image	O	Normal
	Grid Guide Display Options	O	
	Level Setting	O	Display
	Shooting Info. Display Frame	O	Off
	Minimum Distance	O	Show
	Auto Rotate	O	On
Card Sequence No.	O	Off	
Date Settings	O	-	
Language/言語	O	^(*)	
Video Out Mode	O	^(*)	

^(*) The default setting varies depending on where you purchased the camera.

Using Your Camera Abroad

Battery Charger (Model BJ-7)

The battery charger can be used in regions with a current of 100-240V, 50Hz/60Hz. If you are going to travel to a country that uses a different shaped wall outlet/plug, please consult your travel agent on a plug adapter suitable for wall outlets in your country of destination.

Do not use electrical transformers. It may damage the camera.

Warranty

This product was manufactured for use in the country in which it was purchased. The warranty is only valid in the country in which the camera was purchased.

Should the product fail or malfunction while you are abroad, the manufacturer assumes no responsibility for servicing the product locally or bearing the expenditure incurred therefore.

Playback on Television in Other Regions

Playback is possible on televisions (or monitors) equipped with a video input terminal. Please use the AV cable provided.

This camera is compatible with both NTSC and PAL television formats. Set the video format on the camera to match that of the television you are using.

When you go abroad, set your camera to the local video format.

Cautions on Use

Cautions on Use

- This product was manufactured for use in the country in which it was purchased. The warranty is only valid in the country in which the camera was purchased.
- Should the product fail or malfunction while you are abroad, the manufacturer assumes no responsibility for servicing the product locally or bearing the expenditure incurred therefore.
- Be sure not to drop or apply any sudden force to the camera.
- While you are carrying the camera, be careful not to hit it against other objects. Take special care to not hit the lens and picture display.
- Firing the flash consecutively may heat the firing unit. Do not fire it consecutively more than necessary.
- Do not touch the flash and keep foreign objects away from the firing unit. Doing so can cause burns and fires.
- Do not fire the flash near eyes. It could cause visual impairment (particularly for infants).
- Do not fire the flash near the driver of a vehicle to avoid causing accidents.
- The battery may become hot after extended use. Touching the battery immediately after use could result in burns to your fingers.
- If the picture display or panel is exposed to sunlight, they may become washed out and images may become hard to view.
- The picture display and panel may contain some pixels that do not remain lit up continually in part or at all. Also, the brightness may become uneven because of the characteristics of LCDs. These are not failures.
- Do not forcefully press the surface of the picture display.
- In an environment where the temperature changes suddenly, condensation may occur in the camera, resulting in troubles such as fogging of the glass surface or malfunctions of the camera. If this occurs, place the camera in a bag to slow the temperature change as much as possible. Take it out of the bag after the temperature difference from the atmosphere has decreased to a fairly small amount. If condensation occurs, remove the battery and memory card, and wait until the moisture has dried before using the camera.
- To avoid damaging the connectors, do not put any objects into the camera's microphone or speaker holes.
- Do not get the camera wet. Do not operate the camera with wet hands. This can result in malfunction or an electrical shock.
- Before taking any important pictures (such as at weddings, on trips abroad, etc.), test the camera to check operation and ensure proper functioning. We recommend that you keep this manual and spare battery on hand.



Conditions in which condensation may easily occur:-----

- When the camera is moved to an environment where the temperature differs greatly.
- In humid places.
- In a room immediately after being heated, or when the camera is exposed directly to cooled air from an air-conditioner or another similar appliance.

Care and Storage

Care

- Please note that if fingerprints, dirt, etc. get onto the lens, picture quality will suffer.
- When dust or dirt does get on the lens, do not touch it directly with your fingers, and either use a blower (available in stores) to blow it off, or a soft cloth to gently dust it off.
- After use at the beach or around chemicals, wipe it off particularly carefully.
- In the unlikely event that your camera fails to work properly, please consult your Ricoh Repair Center.
- There are high voltage circuits in this camera. As this is dangerous, do not dismantle this camera under any circumstances.
- Do not get volatile substances, such as thinner, benzene, or pesticides on your camera. This may cause a change in quality, paint to peel, etc.
- As the surface of the picture display is easily scratched, do not rub hard objects against it.
- Clean the surface of the picture display by wiping gently with a soft cloth containing a small amount of display cleaner (that does not contain organic solvents) sold in stores.

Use and Storage

- Please avoid using or storing your camera in the following kinds of places, as this may damage the camera.
 - In high heat and humidity, or where there is severe change in temperature or humidity.
 - Places with a lot of dust, dirt or sand.
 - Places with severe vibration.
 - Places where it is in direct contact with vinyl or rubber products or chemicals, including mothballs or other insect repellent, for long periods of time.
 - Places with strong magnetic fields (near a monitor, transformer, magnet, etc.).
- Remove the battery if you are not going to use the camera for a long period of time.

Precautions regarding care of your camera

1. Be sure to turn the power off.
2. Remove the batteries before caring for your camera.

Warranty and Servicing

1. This product is backed by a limited warranty. During the warranty period mentioned in the Warranty supplied with your camera, any defective parts will be repaired free of charge. In the event of a camera malfunction, contact the dealer from which you purchased the camera or your nearest Ricoh Repair Center. Please note that you will be not be reimbursed for the cost of bringing the camera to the Ricoh Repair Center.
2. This warranty does not cover any damage resulting from:
 - ① failure to follow the instructions in the instruction manual;
 - ② repair, modification or overhaul not conducted by an authorized service center listed in the instruction manual;
 - ③ fire, natural disaster, act of God, lightning, abnormal voltage, etc.;
 - ④ improper storage (noted in the "Camera User Guide"), leaking of battery and other fluids, mold, or otherwise insufficient care of the camera.
 - ⑤ submergence in water (flooding), exposure to alcohol or other beverages, infiltration of sand or mud, physical shock, dropping of the camera, or pressure on the camera, and other unnatural causes.
3. After the warranty period has passed, you will be liable for all repair fees, including those incurred at an authorized service center.
4. You will be liable for all repair fees, even within the warranty period, if the warranty card is not attached or if the distributor's name or the purchase date have been changed or are not indicated on the card.
5. Expenses for overhaul and thorough inspection by special request of the customer will be charged to the customer, whether or not they are incurred during the warranty period.
6. This warranty only applies to the camera and not to the accessories, such as the case and strap, nor does it apply to the battery and other consumables provided.
7. Any consequential damages arising from failure of the camera, such as expenses incurred in taking pictures or loss of expected profit, will not be reimbursed whether they occur during the warranty period or not.
8. The warranty is only valid in the country in which the camera was purchased.
 - * The above provisions refer to repairs offered free of charge, and do not limit your legal rights.
 - * The intention of the above provisions is also described in the warranty card provided with this camera.
9. Parts essential to the servicing of the camera (that is, components required to maintain the functions and quality of the camera) will be available for a period of five years after the camera is discontinued.
10. Please note that if the camera is seriously damaged by flooding, submergence, infiltration of sand or mud, violent shocks or dropping, it may not be repairable, and restoration to its original condition may be impossible.



Note

- Before sending the camera in for repair, check the battery and read the instruction manual again to ensure proper operation.
- Some repairs require a significant amount of time to be completed.
- When sending the camera to a service center, please include a note which describes the defective part and the problem as precisely as possible.
- Remove all accessories not related to the problem before sending the camera to the service center.
- This warranty does not apply to data stored on an SD memory card or in internal memory.

INFORMATION TO THE USER

USA FCC Part15 Class B

The equipment has been tested and found to comply with the limits for a Class B digital device, pursuant to part 15 of the FCC Rules. These limits are designed to provide reasonable protection against harmful interference in a residential installation. This equipment generates, uses, and can radiate radio frequency energy and if not installed and used in accordance with the instructions, may cause harmful interference to radio communications. However, there is no guarantee that interference will not occur in a particular installation. If this equipment does cause harmful interference to radio or television reception, which can be determined by turning the equipment off and on, then user is encouraged to try to correct the interference by one or more of the following measures:

- Reorient or relocate the receiving antenna.
- Increase the separation between the equipment and receiver.
- Connect the equipment to an outlet on a circuit different from that to which the receiver is connected.
- Consult the dealer or an experienced radio/TV technician for help. (FCC 15.105B)

Changes or modifications not expressly approved by the party responsible for compliance could void the user's authority to operate the equipment. (FCC 15.21)

Properly shielded and grounded cables and connectors must be used for connection to a host computer in order to comply with FCC emission limits. (FCC 15.27)

An AC adapter with a ferrite core must be used for RF interference suppression.

COMPLIANCE INFORMATION STATEMENT

Product Name: DIGITAL CAMERA

Model Number: CX2

This device complies with Part 15 of the FCC Rules.

Operation is subject to the following two conditions:

- (1) This device may cause harmful interference, and
- (2) This device must accept any interference received, including interference that may cause undesired operation.

RICOH AMERICAS CORPORATION

5 Dedrick Place, West Caldwell NJ, 07006 Tel.: 1-800-225-1899

Note to Users in Canada

Note: This Class B digital apparatus complies with Canadian ICES-003

Remarque Concernant les Utilisateurs au Canada

Avertissement : Cet appareil numérique de la classe B est conforme à la norme NMB-003 du Canada

IMPORTANT SAFETY INSTRUCTIONS-SAVE THESE INSTRUCTIONS
DANGER-TO REDUCE THE RISK OF FIRE OR ELECTRIC SHOCK, CAREFULLY
FOLLOW THESE INSTRUCTIONS.

Index

A

ADJ Button Setting 1, 2, 3, 4	176
ADJ./OK Button	16, 62, 131
AE Lock	68
AE/AF Target Shift	64
AF Auxiliary Light	15, 179
Auto Bracket	112
Auto Focus (AF)	103
Auto Power Off	29, 183
Auto Resize	185
Auto Rotate	191
Auto Shooting Mode	34
AV Cable	12, 163
AV Output Terminal	16, 163
AVI file	94

B

Backlighting	124
Battery	22
Battery Charger	12, 25
Battery Level Indication	21
Battery/Card Cover	16, 26

C

Camera shake	33, 121
Camera Shake Correction	121
Card Reader	215
Card Sequence No.	193
CD-ROM	13, 206
Charging	25
Color Bracket (CL-BKT)	114
Continuous Mode	87
Copy to Card from Internal Memory	158
Custom Self-Timer	118

D

Date Imprint	123
Date Settings	31, 194
DC Software	211
Delete	52
Delete Button	16, 52

Density	82
Digital Zoom	40
Digital Zoom Image	185
Direct Print	197
Discreet Mode	74
DISP. Button	16, 56
DL-10	204, 206
DPOF	159
Dynamic Range Double Shot Mode	84
Dynamic Range Expansion	85

E

Easy Shooting Mode (EASY)	37
Enlarged View	50
Error Messages	221
Export Still Images	134
Exposure Compensation	124
Exposure Metering	108

F

Flag Function Display	142
Flag Function Setting	140
Flash	15, 16, 43
Flash Exposure Compensation	111
Fn (Function) Button	16, 66
Focus	103
Focus Bracket (FOCUS-BKT)	115
Format [Card]	168
Format [Internal Memory]	169
Frame Rate	95

G

Grid Guide Display	56
Grid Guide Display Options	188

H

Handstrap	12
High Contrast B&W	75
High Sens	74
Histogram Display	60

I

Image Settings	109
Internal Memory	23, 47

Interval Shooting	119
Irodio Photo & Video Studio	206, 210, 212
ISO Auto-High Settings	178
ISO Setting	128

L

Landscape	74
Language/言語	30, 195
LCD Auto Dim	184
LCD Brightness	170
LCD Confirmation Time	182
Lens	15
Lens Cover	15
Level Compensation	147
Level Indicator	58, 187
Level Setting	58, 187

M

Macro	16, 41
Macro Target	66, 67, 174
Manual Focus (MF)	105
M-Cont Plus (2M)	90
M-Cont Plus (9M)	88
MENU Button	16, 100, 139, 166
Microphone	15
Miniaturize	75, 79
Minimum Distance	190
Mode Dial	15, 17
Movie Mode	94
Movie Size	101
MP File	92, 104, 132
Multi-trgt AF	104
My Settings Mode (MY)	83

N

Night. Port.	74
Nightscape	74
Number of images that can be stored	232
Number of shots you can take	22

O

Operation Sounds	180
------------------------	-----

P

PictBridge	197
Picture display	16, 18
Picture Quality/Size	101
Playback Button	16, 46
Playback Menu	138
Playback Mode	28, 46
Plus Normal Shooting	86
Portrait	74, 77
POWER Button	15
Pre-AF	107
Printing	197
Protect	154

R

Rechargeable Battery	12, 22, 25, 26
Recover File	162
Reg. My Settings	171
Resize	143
Restore Defaults	130

S

Scene Mode (SCENE)	74
SD Memory Card	23, 26, 47
Self-Timer	45
Self-timer Button	16, 45
Self-Timer Lamp	15, 45
Set Fn Button	174
Setup Menu	165
Shooting Info. Display Frame	189
Shooting Menu	97
Shutter Release Button	15, 32
Skew Correct Mode	75, 81
Skew Correction	152
Slide Show	157
Slow Shutter Limit	122
Speaker	16, 131
Speed Cont	92
Sports	74
Step Zoom	173
Synchro-Monitor Mode	56

T

Text Mode	75
-----------------	----

Thumbnail View	48
Time Exposure	117
Trim	144
Tripod Screw Hole	16

U

USB Cable	12, 198, 212, 213, 217
USB Driver	206
USB Terminal	16, 198, 213, 214, 217

V

Video Out Mode	196
VM-1	219, 220
Volume Settings	181

W

White Balance	126
White Balance Bracket (WB-BKT)	113
White Balance Compensation ...	150
White Saturation Highlights Display	57
WIA Driver	206

Z

Zoom	39
Zoom Lever	15, 39
Zoom Macro	74, 78

Telephone Support Numbers in Europe

UK	(from within the UK)	02073 656 580
	(from outside of the UK)	+44 2073 656 580
Deutschland	(innerhalb Deutschlands)	06331 268 438
	(außerhalb Deutschlands)	+49 6331 268 438
France	(à partir de la France)	0800 88 18 70
	(en dehors de la France)	+33 1 60 60 19 94
Italia	(dall'Italia)	02 696 33 451
	(dall'estero)	+39 02 696 33 451
España	(desde España)	91 406 9148
	(desde fuera de España)	+34 91 406 9148

<http://www.service.riohpmmc.com/>

From environmental friendliness to environmental conservation and to environmental management

Ricoh is aggressively promoting environment-friendly activities and also environment conservation activities to solve the great subject of management as one of the citizens on our precious earth.



To reduce the environmental loads of digital cameras, Ricoh is also trying to solve the great subjects of "Saving energy by reducing power consumption" and "Reducing environment-affecting chemical substances contained in products".

If a problem arises

First of all, see "Troubleshooting" (☞ P.221) in this manual. If the issues still persist, please contact a Ricoh office.

Ricoh Offices	
RICOH COMPANY, LTD.	3-2-3, Shin-Yokohama Kouhoku-ku, Yokohama City, Kanagawa 222-8530, Japan http://www.ricoh.com/r_dc/
RICOH AMERICAS CORPORATION	5 Dedrick Place, West Caldwell, New Jersey 07006, U.S.A. 1-800-22RICOH http://www.ricoh-usa.com/
RICOH INTERNATIONAL B.V. (EPMCM)	Oberrather Str. 6, 40472 Düsseldorf, GERMANY (innerhalb Deutschlands) 06331 268 438 (außerhalb Deutschlands) +49 6331 268 438 http://www.ricohpmcm.com/
RICOH UK LTD. (PMMC UK)	(from within the UK) 02073 656 580 (from outside of the UK) +44 2073 656 580
RICOH FRANCE S.A.S. (PMMC FRANCE)	(à partir de la France) 0800 88 18 70 (en dehors de la France) +33 1 60 60 19 94
RICOH ESPANA, S.A. (PMMC SPAIN)	(desde España) 91 406 9148 (desde fuera de España) +34 91 406 9148
RICOH ITALIA S.p.A. (PMMC ITALY)	(dall'Italia) 02 696 33 451 (dall'estero) +39 02 696 33 451
RICOH ASIA PACIFIC OPERATIONS LIMITED	21/F, One Kowloon, 1 Wang Yuen Street, Kowloon Bay, Hong Kong
About Irodio Photo & Video Studio	
North America (U.S.)	(Toll Free) +1-800-458-4029
Europe	UK, Germany, France and Spain: (Toll Free) +800-1532-4865 Other Countries: +44-1489-564-764
Asia	+63-2-438-0090
China	+86-21-5385-3786
Business hours: 9:00 AM to 5:00 PM	

Ricoh Company, Ltd.
Ricoh Building, 8-13-1, Ginza, Chuo-ku, Tokyo
104-8222, Japan
2009 September



* L 7 5 5 2 9 7 1 C *



EN (USA) GB (GB) AE (AE)

Printed in China