



# DVD Player

## DVD-1080P8



[www.samsung.com](http://www.samsung.com)

AK68-01503A-01

# Important Safety Instructions

- 1) Read these instructions.
- 2) Keep these instructions.
- 3) Heed all warnings.
- 4) Follow all instructions.
- 5) Do not use this apparatus near water.
- 6) Clean only with dry cloth.
- 7) Do not block any ventilation openings, Install in accordance with the manufacturer's instructions.
- 8) Do not install near any heat sources such as radiators, heat registers, stoves, or other apparatus (including amplifiers) that produce heat.
- 9) Do not defeat the safety purpose of the polarized or grounding- type plug. A polarized plug has two blades with one wider than the other. A grounding type plug has two blades and a third grounding prong. The wide blade or the third prong are provided for your safety. If the provided plug does not fit into your outlet, consult an electrician for replacement of the obsolete outlet.
- 10) Protect the power cord from being walked on or pinched particularly at plugs, convenience receptacles, and the point where they exit from the apparatus.
- 11) Only use attachments/accessories specified by the manufacturer.
- 12) Use only with cart, stand, tripod, bracket, or table specified by the manufacturer, or sold with the apparatus. When a cart is used, use caution when moving the cart/apparatus combination to avoid injury from tip-over.
- 13) Unplug this apparatus during lightning storms or when unused for long periods of time.
- 14) Refer all servicing to qualified service personnel. Servicing is required when the apparatus has been damaged in any way, such as the power-supply cord or plug is damaged, liquid has been spilled or objects have fallen into the apparatus. Service is also required if the apparatus has been exposed to rain or moisture, does not operate normally, or has been dropped.



# Precautions

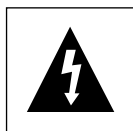
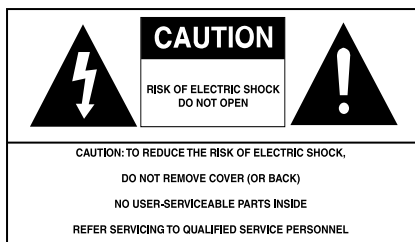

This symbol indicates that dangerous voltage consisting a risk of electric shock is present within this unit.



This symbol indicates that there are important operating and maintenance instructions in the literature accompanying this unit.

Do not install this equipment in a confined space such as a bookcase or similar unit.

**WARNING :** TO REDUCE THE RISK OF FIRE OR ELECTRIC SHOCK, DO NOT EXPOSE THIS APPARATUS TO RAIN OR MOISTURE.

**Note to CATV system installer :** This reminder is provided to call CATV system installer’s attention to Article 820-40 of the National Electrical Code (Section 54 of Canadian Electrical Code, Part I) that provides guidelines for proper grounding and, in particular, specifies that the cable ground shall be connected to the grounding system of the building as close to the point of cable entry as practical.

**Caution :** FCC regulations state that any unauthorized changes or modifications to this equipment may void the user’s authority to operate it.

- Apparatus shall not be exposed to dripping or splashing and no objects filled with liquids, such as vases, shall be placed on the apparatus.
- If this power supply is used at 240V ac, a suitable plug adapter should be used.

### FCC NOTE (for U.S.A):

This equipment has been tested and found to comply with the limits for a Class B digital device, pursuant to Part 15 of the FCC rules. These limits are designed to provide reasonable protection against harmful interference in a residential installation. This equipment generates, uses and can radiate radio frequency energy and, if not installed and used in accordance with the instructions, may cause harmful interference to radio or television reception, which can be determined by turning the equipment off and on.

The user is encouraged to try to correct the interference by one or more of the following measures.

- Reorient or relocate the receiving antenna.
- Increase the separation between the equipment and receiver.
- Connect this equipment into an outlet on a circuit different from that to which the receiver is connected.
- Consult the dealer or an experienced radio/TV technician for help.

This class B digital apparatus meets all requirements of the Canadian Interference -- Causing Equipment Regulations.

### CALIFORNIA USA ONLY :

This Perchlorate warning applies only to primary CR (Maganese Dioxide) Lithium coin cells in the product sold or distributed ONLY in California USA “Perchlorate Material - special handling may apply , See [www.dtsc.ca.gov/hazardouswaste/perchlorate](http://www.dtsc.ca.gov/hazardouswaste/perchlorate).

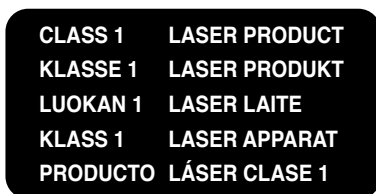

## **CAUTION**

THIS PRODUCT UTILIZES A LASER. USE OF CONTROLS OR ADJUSTMENTS OR PERFORMANCE OF PROCEDURES OTHER THAN THOSE SPECIFIED HEREIN MAY RESULT IN HAZARDOUS RADIATION EXPOSURE. DO NOT OPEN COVER AND DO NOT REPAIR YOURSELF. REFER SERVICING TO QUALIFIED PERSONNEL.

### **Note:**

- This unit can be used only where the power supply is AC 120V, 60Hz. It cannot be used elsewhere.
- This DVD player is designed and manufactured to respond to the Region Management Information. If the Region number of a DVD disc does not correspond to the Region number of this DVD player, the DVD player cannot play the disc.
- The product unit accompanying this user manual is licensed under certain intellectual property rights of certain third parties. In particular, this product is licensed under the following US patents:  
5,060,220 5,457,669 5,561,649 5,705,762 5,987,417 6,043,912 6,222,983 6,272,096 6,377,524  
6,377,531 6,385,587 6,389,570 6,408,408 6,466,532 6,473,736 6,477,501 6,480,829 6,556,520  
6,556,521 6,556,522 6,578,163 6,594,208 6,631,110 6,658,588 6,674,697 6,674,957 6,687,455  
6,697,307 6,707,985 6,721,243 6,721,493 6,728,474 6,741,535 6,744,713 6,744,972 6,765,853  
6,765,853 6,771,890 6,771,891 6,775,465 6,778,755 6,788,629 6,788,630 6,795,637 6,810,201  
6,862,256 6,868,054 6,894,963 6,937,552.

This license is limited to private non-commercial use by end-user consumers for licensed contents.

No rights are granted for commercial use. The license does not cover any product unit other than this product unit and the license does not extend to any unlicensed product unit or process conforming to ISO/IEC 11172-3 or ISO/IEC 13818-3 used or sold in combination with this product unit.

The license only covers the use of this product unit to encode and/or decode audio files conforming to the ISO/IEC 11172-3 or ISO/IEC 13818-3. No rights are granted under this license for product features or functions that do not conform to the ISO/IEC 11172-3 or ISO/IEC 13818-3.

### **Handling Cautions**

- Before connecting other components to this player, be sure to turn them all off.
- Do not move the player while a disc is being played, or the disc may be scratched or broken, and the player's internal parts may be damaged.
- Do not put a flower vase filled with water or any small metal objects on the player.
- Be careful not to put your hand into the disc tray.
- Do not place anything other than the disc in the disc tray.
- Exterior interference such as lightning and static electricity can affect normal operation of this player. If this occurs, turn the player off and on again with the POWER button, or disconnect and then reconnect the AC power cord to the AC power outlet. The player will operate normally.
- Be sure to remove the disc and turn off the player after use.
- Disconnect the AC power cord from the AC outlet when you don't intend to use the player for long periods of time.
- Clean the disc by wiping in a straight line from the inside to the outside of the disc.
- The Main plug is used as a disconnect device and shall stay readily operable at any time.

### **Disc Storage**

Be careful not to harm the disc because the data on these discs is highly vulnerable to the environment.

- Do not keep under direct sunlight.
- Keep in a cool ventilated area.
- Store vertically.
- Keep in a clean protection jacket.

### **Maintenance of Cabinet**

For safety reasons, be sure to disconnect the AC power cord from the AC outlet.

- Do not use benzene, thinner, or other solvents for cleaning.
- Wipe the cabinet with a soft cloth.

# Before you start

## Accessories

---



Remote Control  
(AK59-00084J)



Batteries for Remote Control  
(AAA Size)  
(AC43-12002H)

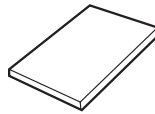

User's Manual  
(AK68-01503A)

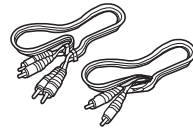

RCA Phone Cable  
(AC39-42001U &  
AC39-22017Z)

---

## Install Batteries in the Remote control

**1**

Open the battery cover on the back of the remote control.

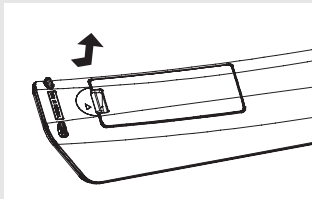

**2**

Insert two AAA batteries. Make sure that the polarities (+ and -) are aligned correctly.

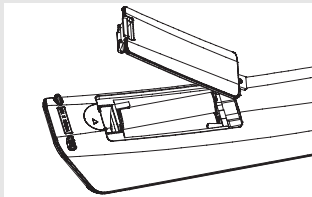

**3**

Replace the battery cover.

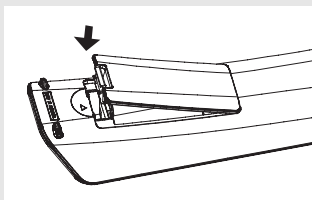

### If the remote control doesn't operate properly:

- Check the polarity + - of the batteries.
- Check if the batteries are drained.
- Check if the remote control sensor is blocked by obstacles.
- Check if there is any fluorescent lighting nearby.

# TABLE OF CONTENTS

Important Safety Instructions .....	2
Precautions .....	3
Before you start .....	5
<b>Chapter 1: Setup</b>	
General Features .....	7
Disc Type and Characteristics .....	8
Description .....	9
Tour of the Remote Control .....	11
<b>Chapter 2: Connections</b>	
Connecting to a TV with an HDMI Jack .....	12
Connecting to a TV with a DVI Jack .....	12
Connecting to a TV (Progressive) .....	14
Connecting to a TV (Interlace) .....	15
Connecting to a TV (Video) .....	16
Connecting to an Audio System (2 Channel Amplifier) .....	17
Connecting to an Audio System (Dolby Digital, MPEG2 or DTS Amplifier) ..	18
<b>Chapter 3: Basic Functions</b>	
Playing a Disc .....	19
Using the Search and Skip Functions .....	21
Using the Display Function .....	22
Using the Disc and Title Menu .....	23
Using the Function Menu .....	24
Repeat Play .....	25
Slow Play .....	26
<b>Chapter 4: Advanced Functions</b>	
Adjusting the Aspect Ratio (EZ View) .....	27
Selecting the Audio Language .....	29
Selecting the Subtitle Language .....	30
Changing the Camera Angle .....	31
Using the Instant Replay/Skip Function .....	32
Using the Bookmark Function .....	33
Using the Zoom Function .....	35
Clips Menu for MP3/WMA/JPEG/MPEG4/CD Audio .....	36
Folder Selection .....	36
MP3/WMA/CD Audio Playback .....	37
MPEG4 Playback .....	39
Picture CD Playback .....	41
<b>Chapter 5: Navigating the Setup Menu</b>	
Using the Setup Menu .....	43
Setting Up the Language Features .....	44
Setting Up the Audio Options .....	49
Setting Up the Display Options .....	51
Setting Up the Parental Control .....	54
Setting Up Anynet+(HDMI-CEC) .....	56
<b>Chapter 6: Reference</b>	
Firmware Upgrade .....	58
Troubleshooting .....	59
Specifications .....	61

# Chapter 1

## SETUP

### General Features

#### Excellent Sound

Dolby Digital, a technology developed by Dolby Laboratories, provides crystal clear sound reproduction.

#### Screen

Both regular and widescreen(16:9) pictures can be viewed.

#### Slow Motion

An important scene can be viewed in slow motion.

#### 1080p Playback

This player upconverts regular DVDs for playback on 1080p TVs.

#### Parental Control (DVD)

The parental control allows users to set the level necessary to prohibit children from viewing harmful movies such as those with violence, adult subject matter, etc.

#### Various On-Screen Menu Functions

You can select various languages (Audio/Subtitle) and screen angles while enjoying movies.

#### Progressive Scan

Progressive scanning creates an improved picture with double the scan lines of a conventional interlaced picture.

#### EZ VIEW (DVD)

Easy View enables picture adjustment to match your TV's screen size (16:9 or 4:3).

#### Digital Photo Viewer (JPEG)

You can view Digital Photos on your TV.

#### Repeat

You can repeat a song or movie simply by pressing the REPEAT button.

#### MP3/WMA

This unit can play discs created from MP3/WMA files.

#### Instant Replay (DVD)

This function is used to replay the previous 10 seconds of a movie from the current position.

#### Instant Skip (DVD)

This function skips playback ahead 10 seconds.

#### MPEG4

This unit can play MPEG4 formats within an avi file.

#### HDMI (High Definition Multimedia Interface)

HDMI reduces picture noise by allowing a pure digital video/audio signal path from the player to your TV.

#### Note

- Discs which cannot be played with this player.
  - DVD-ROM
  - DVD-RAM
  - CD-ROM
  - CDV
  - CDI
  - CVD
  - Super Audio CD(except CD layer)
  - CDGs play audio only, not graphics.
- Ability to play back may depend on recording conditions.
  - DVD-R, +R
  - CD-RW
  - DVD+RW, -RW (V mode)
- The unit may not play certain CD-R, CD-RW and DVD-R due to the disc type or recording conditions.

---

### COPY PROTECTION

Many DVD discs are encoded with copy protection. Because of this, you should only connect your DVD player directly to your TV, not to a VCR. Connecting to a VCR results in a distorted picture from copy-protected DVD discs.

This product incorporates copyright protection technology that is protected by methods claims of certain U.S. patents and other intellectual property rights owned by Macrovision Corporation and other rights owners. Use of this copyright protection technology must be authorized by Macrovision Corporation, and is intended for home and other limited viewing uses only unless otherwise authorized by Macrovision Corporation. Reverse engineering or disassembly is prohibited.

---



### PROGRESSIVE SCAN OUTPUTS (480p, 720p, 1080p)

"CONSUMERS SHOULD NOTE THAT NOT ALL HIGH DEFINITION TELEVISION SETS ARE FULLY COMPATIBLE WITH THIS PRODUCT AND MAY CAUSE ARTIFACTS TO BE DISPLAYED IN THE PICTURE, IF PROGRESSIVE SCAN PICTURE PROBLEMS OCCUR, IT IS RECOMMENDED THAT THE USER SWITCH THE CONNECTION TO THE 'STANDARD DEFINITION' (VIDEO) OUTPUT. IF THERE ARE QUESTIONS REGARDING YOUR TV SET COMPATIBILITY WITH THIS DVD PLAYER, PLEASE CONTACT SAMSUNG'S CUSTOMER SERVICE CENTER."





# SETUP

## Disc Type and Characteristics

This DVD player is capable of playing the following types of discs with the corresponding logos:

Disc Types (Logos)	Recording Types	Disc Size	Max. Playing Time	Characteristics
<b>DVD</b> 	Audio + Video	5"	Single-sided 240 min. Double-sided 480 min.	<ul style="list-style-type: none"> <li>- DVD contains excellent sound and video due to Dolby Digital and MPEG-2 system.</li> <li>- Various screen and audio functions can be easily selected through the on-screen menu.</li> </ul>
		3 1/2"	Single-sided 80 min. Double-sided 160 min.	
<b>AUDIO-CD</b> 	Audio	5"	74 min.	<ul style="list-style-type: none"> <li>- CD contains Digital content with better audio quality, less distortion and less deterioration of audio quality over time.</li> </ul>
		3 1/2"	20 min.	

### Disc Markings

	Play Region Number
	NTSC broadcast system in U.S.A, Canada, Korea, Japan, etc.
	Dolby Digital disc
	Stereo disc
	Digital Audio disc
	DTS disc
	MP3 disc

**You must only insert one DVD disc at a time. Inserting two or more discs will not allow playback and may cause damage to the DVD player.**

### Region Number

Both the DVD player and the discs are coded by region. These regional codes must match in order for the disc to play. If the codes do not match, the disc will not play.

The Region Number for this player is described on the rear panel of the player.

### DivX Certification

DivX, DivX Certified, and associated logos are trademarks of DivXNetworks, Inc and are used under license





## Description

### Front Panel Controls

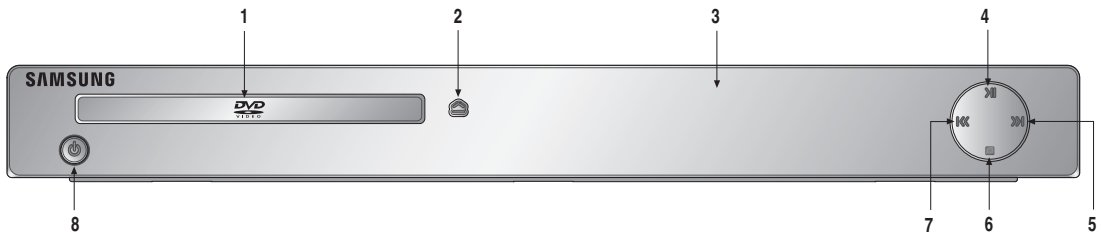

- |  |   |
|--|---|
| <ol style="list-style-type: none"> <li><b>1. DISC TRAY</b><br/>Place the disc here.</li> <li><b>2. OPEN/CLOSE (⏏)</b><br/>Press to open and close the disc tray.</li> <li><b>3. DISPLAY</b><br/>Operation indicators are displayed here.</li> <li><b>4. PLAY/PAUSE (⏮)</b><br/>Begin or pause disc play.</li> <li><b>5. SKIP (⏭) / SEARCH</b><br/>Use to forward skip a scene or music.</li> </ol> | <ol style="list-style-type: none"> <li><b>6. STOP (⏹)</b><br/>Stops disc play.</li> <li><b>7. SKIP (⏮) / SEARCH</b><br/>Use to reverse skip a scene or music.</li> <li><b>8. STANDBY/ON (⏻)</b><br/>When STANDBY/ON is pressed on, the indicator goes out and the player is turned on.</li> </ol> |
|--|---|

### Front Panel Display

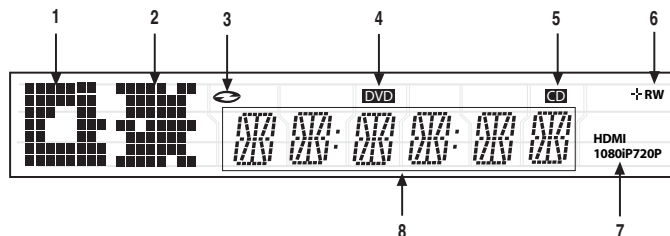

- |   |   |
|---|---|
| <ol style="list-style-type: none"> <li><b>1. STOP, PAUSE and OPEN/CLOSE indicator</b></li> <li><b>2. PLAYBACK, SKIP/SEARCH indicator</b></li> <li><b>3. Disc Indicator : DVD Video, Audio CD, CD-R/RW, DVD-R/RW/RAM, DVD+R/RW</b></li> <li><b>4. DVD VIEW indicator</b></li> <li><b>5. CD indicator</b></li> <li><b>6. Disc Media indicator : DVD-R, DVD-RW, DVD+R, DVD+RW</b></li> </ol> | <ol style="list-style-type: none"> <li><b>7. HDMI indicator :</b><br/>HDMI 480P → "HDMI",<br/>HDMI 720P → "HDMI + 720P",<br/>HDMI 1080i → "HDMI + 1080i",<br/>HDMI 1080P → "HDMI + 1080P"</li> <li><b>8. Displays the Total playing time and various messages concerning operations such as PLAY, STOP, LOAD ...</b><br/>NOdSC: No disc loaded.<br/>OPEn: The disc tray is open.<br/>LOAD: Player is loading disc information.</li> </ol> |
|---|---|

# SETUP

## Rear Panel

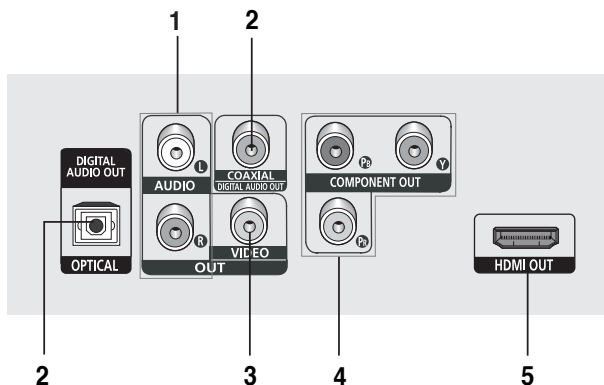

### 1. AUDIO OUT JACKS

- Use audio cables to connect to the Audio input jacks of your television or audio/video receiver

### 2. DIGITAL AUDIO OUT JACKS

- Use either an optical or coaxial digital cable to connect to a compatible Dolby Digital receiver.
- Use either an optical or coaxial digital cable to connect to an A/V Amplifier that contains a Dolby Digital, MPEG2 or DTS decoder.

### 3. VIDEO OUT JACK

- Use a video cable to connect to the Video input jack on your television.

### 4. COMPONENT VIDEO OUT JACKS

- Use these jacks if you have a TV with Component Video in jacks. These jacks provide Pb, Pr and Y video.
- If P-SCAN is set to "ON" in Video Output of the Setup Menu, progressive scan mode will work.
- If I-SCAN is set to "ON" in Video Output of the Setup Menu, interlaced scan mode will work.

### 5. HDMI OUT JACK

- Use an HDMI cable to connect this jack to the HDMI jack on your television for the best quality picture.
- If an HDMI cable is connected to an HDMI-compatible TV, HDMI will be output automatically from the player about 10 seconds later.

## Note

- Consult your TV User's Manual to find out if your TV supports Progressive Scan (P-SCAN). If Progressive Scan is supported, follow the TV User's Manual regarding Progressive Scan settings in the TV's menu system.
- The HDMI output of this unit can be connected to a DVI jack on a TV or other device using a conversion adapter. In this case, it is necessary to use a TV or display with an HDCP-compatible DVI input.
- Refer to the TV's instruction manual for detailed information regarding the TV's HDMI input jack.
- See pages 51~ 53 to get more information on how to use the setup menu.

## Tour of the Remote Control

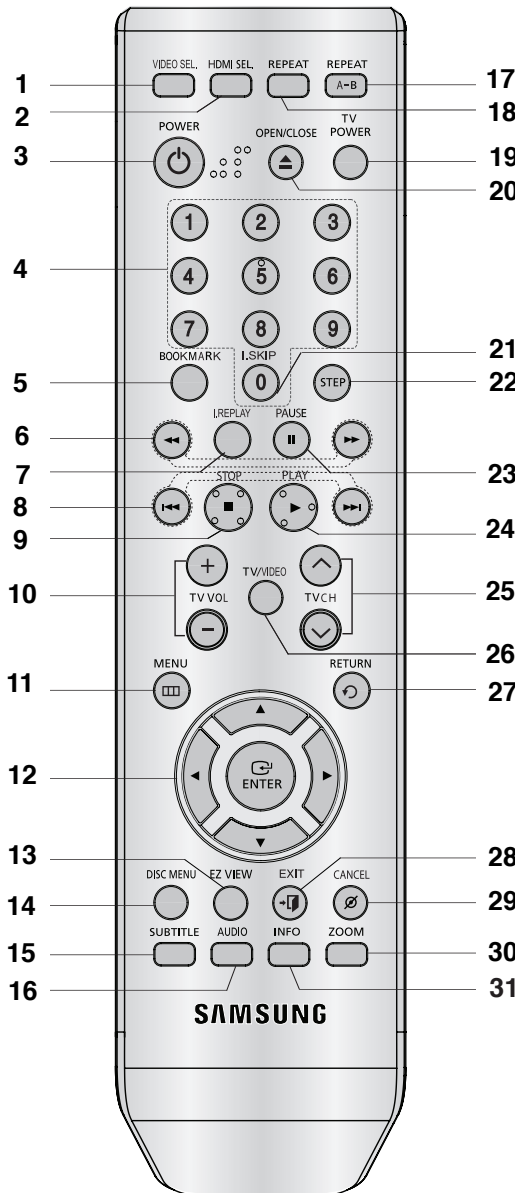

1. **VIDEO SEL. Button**  
Changes video output mode
2. **HDMI SEL. Button**  
HDMI Output resolution setup.
3. **DVD POWER Button**  
Turns the power on or off.
4. **NUMBER Buttons**
5. **BOOKMARK Button**
6. **SEARCH Buttons (◀/▶)**  
Allow you to search forward/backward through a disc.

7. **INSTANT REPLAY Button**  
This function is used to replay the previous 10 seconds of a movie from the current position
8. **SKIP Buttons (◀◀/▶▶)**  
Use to skip the title, chapter or track.
9. **STOP Button (■)**
10. **TV VOL (+, -) Buttons**  
Control volume.
11. **MENU Button**  
Brings up the DVD player's menu.
12. **ENTER/▲/▼, ◀/▶ Buttons**  
This button functions as a toggle switch.
13. **EZ VIEW Button**  
The aspect ratio of a picture can easily be adjusted according to the screen size of your TV (16:9 or 4:3).
14. **DISC MENU Button**  
Brings up the Disc menu.
15. **SUBTITLE Button**
16. **AUDIO Button**  
Use this button to access various audio functions on a disc.
17. **REPEAT A-B Button**  
Allows you to repeat play a chosen section (A-B) on a disc.
18. **REPEAT Button**  
Allows you to repeat play a title, chapter, track, or disc.
19. **TV POWER Button**  
Turns the TV's power on or off.
20. **OPEN/CLOSE (▲) Button**  
To open and close the disc tray.
21. **INSTANT SKIP Button**  
This function skips playback ahead 10 seconds.
22. **STEP Button**  
Advances play one frame at a time.
23. **PAUSE Button (||)**  
Pause disc play.
24. **PLAY Button (▶)**  
Begins disc play.
25. **TV CH (^, v) Buttons**  
Channel selection.
26. **TV/VIDEO Button**  
Press to display all of the available video sources (i.e., TV, Cable, Video)
27. **RETURN Button**  
Returns to a previous menu.
28. **EXIT Button**  
Exit the on-screen menu.
29. **CANCEL Button**  
Use to remove menus or status displays from the screen.
30. **ZOOM Button**  
Enlarges the DVD Picture
31. **INFO Button**  
Displays the current disc mode.

# Chapter 2

## CONNECTIONS

### Choosing a Connection

The following shows examples of connections commonly used to connect the DVD player with a TV and other components.

#### Before Connecting the DVD Player

- Always turn off the DVD player, TV, and other components before you connect or disconnect any cables.
- Refer to the user's manual of the additional components (such as a TV) you are connecting for more information on those particular components.

#### Connecting to a TV with HDMI Jack

HDMI provides the best picture quality of all the connections.

##### 1

Using an HDMI-HDMI cable (not included) connect the **HDMI OUT** jack on the rear of the DVD player to the **HDMI IN** jack of your TV.

##### 2

Press the input selector button on your TV remote control until the HDMI signal from the DVD player appears on your TV screen.

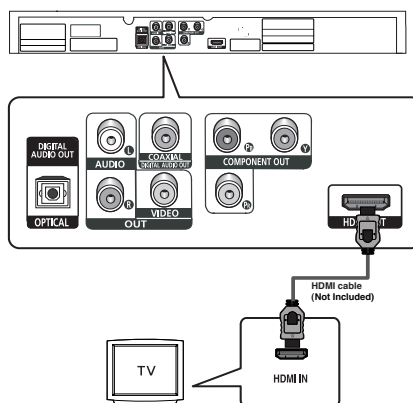

#### Connecting to a TV with DVI Jack

##### 1

Using an HDMI-DVI cable (not included), connect the **HDMI OUT** jack on the rear of the DVD player to the **DVI IN** jack of your TV.

##### 2

Using the audio cables, connect the **AUDIO (red and white) OUT** jacks on the rear of the DVD player to the **AUDIO (red and white) IN** jacks of your TV. Turn on your DVD player and TV.

##### 3

Press the input selector button on your TV remote control until the DVI signal from the DVD player appears on your TV screen.

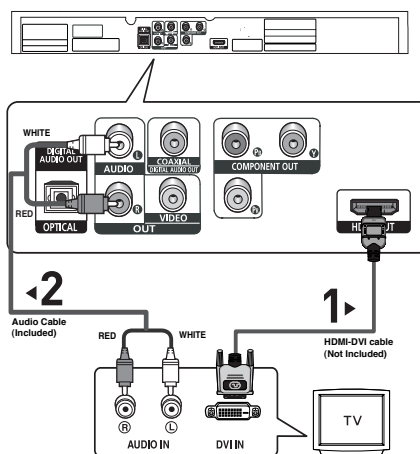

## HDMI VIDEO Specifications

When you press the **HDMI SEL.** button, the 480p, 720p, 1080i and 1080p resolutions are selected in order.

The first press of the **HDMI SEL.** button, brings up the current resolution.

The second press allows you to change the HDMI output resolution.

- Depending on your TV, certain HDMI output resolutions may not work.
- Please refer to the user's manual of your TV.
- If an HDMI or HDMI-DVI cable is plugged into TV, the DVD player's output is set to HDMI automatically about 10 seconds later.
- For better picture quality, set the HDMI output resolution to 720p, 1080i or 1080p (see page 52)
- This player upconverts regular DVDs for playback on 1080p TVs. It does not play HD DVDs or Blu-Ray discs.
- If you connect an HDMI cable between Samsung TV and this DVD player, you can operate this DVD player using your TV remote control. This is only available with Samsung TVs that support Anynet+(HDMI-CEC).(see page 56-57)
- If your TV has an  logo, then it supports the Anynet+ function.

### • HDMI (High Definition Multimedia Interface)

HDMI enables you to make a digital video and audio connection with a single cable.

Using HDMI, the DVD player transmits a digital video and audio signal which displays a vivid picture on a TV having an HDMI input jack.

### • HDMI connection description

HDMI connector - Video and audio are transferred digitally without compression (LPCM or Bit Stream data).

- The player outputs a pure digital signal to the TV through an HDMI cable.
- If your TV does not support HDCP (High-bandwidth Digital content protection), snow noise appears on the screen.

### • Why does Samsung use HDMI?

Analog TVs require an analog video/audio signal. However, when playing a DVD, the signal transmitted to a TV is digital. Therefore either a digital-to-analog converter (in the DVD player) or an analog-to-digital converter (in the TV) is required. During this conversion, the picture quality is degraded due to noise and signal loss. HDMI technology is superior because it requires no D/A conversion and is a pure digital signal from the player to your TV.

### • What is HDCP?

HDCP (High-bandwidth Digital Content Protection) is a system for protecting DVD content output via HDMI/DVI from being copied. It provides a secure digital link between a video source (PC, DVD. etc) and a display device (TV, projector, etc). Content is encrypted at the source device to prevent unauthorized copies from being made.

## CONNECTIONS

### Connecting to a TV (Progressive)

- Connecting to your TV using Component video cables. The 480p resolution is possible with this connection.
- What is "Progressive Scan"?  
Progressive scan has twice as many scanning lines as the interlace output method and provides better and clearer picture quality.

#### 1

Using Component video cables (not included), connect the **COMPONENT VIDEO OUT** jacks on the rear of the DVD player to the **COMPONENT IN** jacks of your TV.

#### 2

Using the audio cables, connect the **AUDIO (red and white) OUT** jacks on the rear of the DVD player to the **AUDIO (red and white) IN** jacks of your TV. Turn on the DVD player and TV.

#### 3

Set the Video Output to **P-SCAN** in the Display Setup menu. (See pages 51 to 53)  
You can also use the **VIDEO SEL.** button to change the Video Output mode. (See page 16)

#### 4

Press the input selector button on your TV remote control until the Component signal from the DVD player appears on the TV screen.

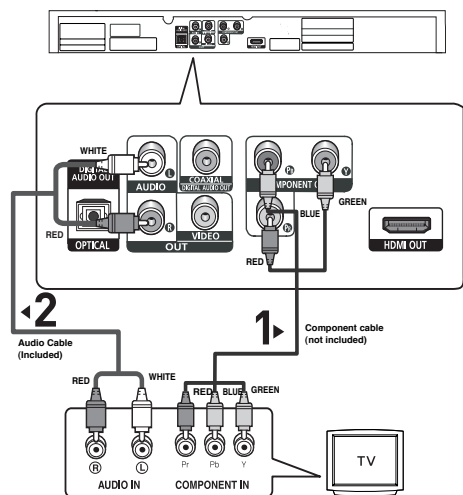

### To see the progressive video output,

- Consult your TV User's Manual to find out if your TV supports Progressive Scan. If Progressive Scan is supported, follow the TV User's Manual regarding Progressive Scan settings in the TV's menu system.
- Depending on your TV, the connection method may differ from the illustration above.

## CONNECTIONS

### Connecting to a TV (Interlace)

- Connecting to your TV using Component video cables. The 480i resolution is possible with this connection.
- This is the best available connection if your TV is not capable of receiving a Progressive Scan signal.
- You will enjoy excellent quality and accurate color reproduction images. Component video separates the picture element into black and white(Y), blue(P<sub>B</sub>), red(P<sub>R</sub>) signals to present clear and clean images. (Audio signals are delivered through the audio output.)

#### 1

Using Component video cables (not included), connect the **COMPONENT VIDEO OUT** jacks on the rear of the DVD player to the **COMPONENT IN** jacks of your TV.

#### 2

Using the audio cables, connect the **AUDIO (red and white) OUT** jacks on the rear of the DVD player to the **AUDIO (red and white) IN** jacks of your TV. Turn on your DVD player and TV.

#### 3

Set the Video Output to **I-SCAN** in the Display Setup menu. (See pages 51 to 53)  
You can also use the **VIDEO SEL.** button to change the Video Output mode. (See page 16)

#### 4

Press the input selector on your TV remote control until the Component signal from the DVD player appears on the TV screen.

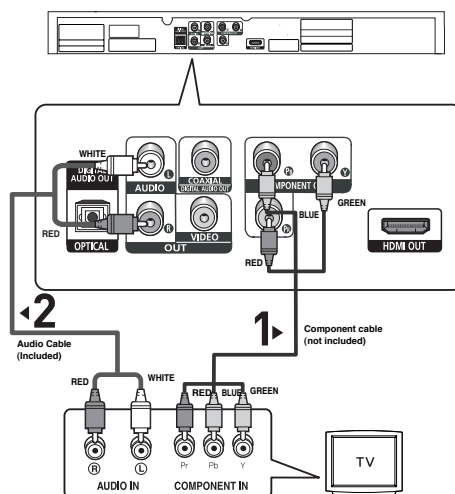

### Note

- If you want to connect to an Amplifier, please refer to the Amplifier connection page. (See pages 17 to 18)
- The Component jacks of your TV may be marked "R-Y, B-Y, Y" or "Cr, Cb, Y" instead of "P<sub>R</sub>, P<sub>B</sub>, Y" depending on the manufacturer. The number and position of the jacks may vary depending on the TV set. Please refer to the user's manual of your TV.

# CONNECTIONS

## Connecting to a TV (Video)

**1**

Using Video/Audio cables, connect the **VIDEO (yellow)/AUDIO (red and white) OUT** jacks on the rear of the DVD player to the **VIDEO (yellow)/AUDIO (red and white) IN** jacks of your TV.

**2**

Turn on your DVD player and TV.

**3**

Set the Video Output to **I-SCAN** in the Display Setup menu. (See pages 51 to 53).  
You can also use the **VIDEO SEL.** button to change the Video Output mode. (See page 16)

**4**

Press the input selector button on your TV remote control until the Video signal from the DVD player appears on the TV screen.

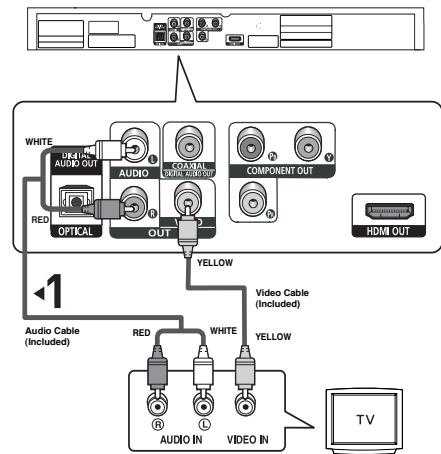

### Note

- **Noise may be generated if the audio cable placed too close to the power cable.**
- If you want to connect to an Amplifier, please refer to the Amplifier connection page. (See pages 17 to 18)
- The number and position of the jacks may vary depending on your TV set. Please refer to the user's manual of your TV.
- If there is one audio input terminal on the TV, connect it to the [AUDIO OUT][left] (white) jack of the DVD player.
- If you press the VIDEO SEL. button when the DVD Player is in stop mode or no disc is inserted, the Video Output mode changes in the following sequence: (I-SCAN → P-SCAN).



## CONNECTIONS

### Connecting to an Audio System (2 Channel Amplifier)

**1**

Using the audio cables, connect the **AUDIO (red and white) OUT** jacks on the rear of the DVD player to the **AUDIO (red and white) IN** jacks of the Amplifier.

**2**

Using the video signal cable(s), connect the **HDMI, COMPONENT** or **VIDEO OUT** jacks on the rear of the DVD player to the **VIDEO, COMPONENT** or **HDMI-DVI IN** jack of your TV as described on pages 14 to 16.

**3**

Turn on your DVD player, TV, and Amplifier.

**4**

Press the input select button of the Amplifier to select the audio input your DVD player is connected to in order to hear sound. Refer to your Amplifier's user manual to set the Amplifier's audio input.

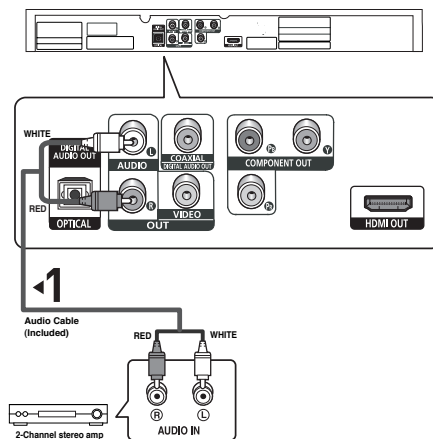

#### Note

- **Please turn the volume down when you turn on the Amplifier. Sudden loud sound may cause damage to the speakers and your ears.**
- Please set the audio in the menu screen according to the Amplifier. (See pages 49 to 50)
- The position of jacks may vary depending on the Amplifier. Please refer to the user's manual of the Amplifier.

## CONNECTIONS

### Connecting to an Audio System (Dolby digital, MPEG2 or DTS Amplifier)

#### 1

If using an Optical cable (not included), connect the **DIGITAL AUDIO OUT (OPTICAL)** jack on the rear of the DVD player to the **DIGITAL AUDIO IN (OPTICAL)** jack of the Amplifier.  
If using a Coaxial cable (not included), connect the **DIGITAL AUDIO OUT (COAXIAL)** jack on the rear of the DVD player to the **DIGITAL AUDIO IN (COAXIAL)** jack of the Amplifier.

#### 2

Using the video signal cable(s), connect the **HDMI**, **COMPONENT** or **VIDEO OUT** jacks on the rear of the DVD player to the **VIDEO**, **COMPONENT** or **HDMI-DVI IN** jacks of your TV as described on pages 14 to 16.

#### 3

Turn on your DVD player, TV, and Amplifier.

#### 4

Press the input select button of the Amplifier to select the audio input your DVD player is connected to in order to hear sound. Refer to your Amplifier's user manual to set the Amplifier's audio input.

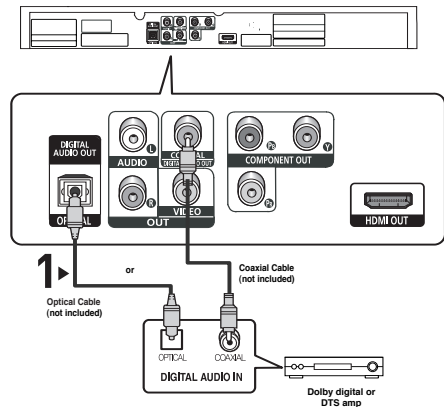

#### Note

- Please turn the volume down when you turn on the Amplifier. Sudden loud sound may cause damage to the speakers and your ears.

- Please set the audio in the menu screen according to the Amplifier you have connected. (See pages 49 to 50)
- The position of jacks may vary depending on the Amplifier. Please refer to the user's manual of the Amplifier.
- Please remove the dust cover before using the optical cable (not included) and put the cover on the cable again when it's not used.

# Chapter 3

## BASIC FUNCTIONS

### Playing a Disc

#### Before Play

- Turn on your TV and set it to the Video Input your DVD player is connected to with your TV's remote control.
- If you connected the DVD player to an external Audio System, turn on your Audio System and set it to the correct Audio Input.

After plugging in the player, the first time you press the DVD **POWER** button, the screen to the right appears: If you want to select a language, press a **NUMBER** button.

(This screen will only appear when you plug in the player for the first time.)

If the language for the startup screen is not set, the settings may change whenever you turn the power on or off. Therefore, make sure that you select the language you want to use.

Once you select a menu language, you can change it by pressing the **»** button on the front panel of the unit for more than 5 seconds with no disc in the unit. Then the **SELECT MENU LANGUAGE** window appears again where you can reset your preferred language.



#### Playback

1

Press the **OPEN/CLOSE** (**▲**) button. The **STANDBY** indicator light goes out and the tray opens.

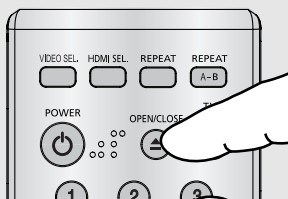

2

Place a disc gently into the tray with the disc's label facing up.



3

Press the **PLAY** (**▶**) button or **OPEN/CLOSE** (**▲**) button to close the disc tray.



#### ◀ RESUME function

When you stop disc play, the player remembers where you stopped, so when you press the **PLAY** (**▶**) button again, it will pick up where you left off.

## BASIC FUNCTIONS

### 4

#### Stopping Play

Press the **STOP** (■) button during play.

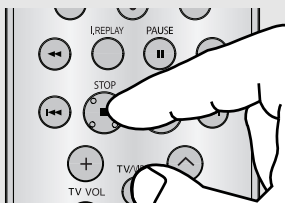

#### Note

- If the player is left in the stop mode for more than one minute without pressing any buttons, a screen saver will be activated. Press the **PLAY** (▶) button to resume normal play.
- If the player is left in the stop mode for more than 30 minutes, the power will automatically turn off.

### 5

#### Removing the Disc

Press the **OPEN/CLOSE** (▲) button.



### 6

#### Pausing Play

Press the **PAUSE** (||) or **STEP** button on the remote control during play.

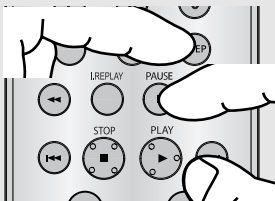

- ◀ Screen stops, no sound.  
To resume, press the **PLAY** (▶) button once again.

#### Note

If the player is left for about 5 minutes in pause mode, it will stop.

### 7

#### Step Motion Play (Except CD)

Press the **STEP** button on the remote control during play.

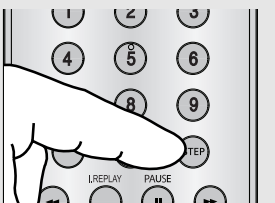

- ◀ Each time the button is pressed, a new frame will appear.  
No sound is heard during STEP mode.  
Press the **PLAY** (▶) button to resume normal play.  
You can only perform step motion play in the forward direction.

### 8

#### Slow Motion Play

Press the **SEARCH** (◀/▶) button to choose the play speed between 1/8, 1/4 and 1/2 of normal speed during **PAUSE** or **STEP** mode.



- ◀ No sound is heard during slow mode.  
Press the **PLAY** (▶) button to resume normal play.

#### Note

- The (⊙) icon indicates an invalid button press.
- This player does not play HD DVDs or Blu-Ray discs.

## BASIC FUNCTIONS

### Using the Search and Skip Functions

During play, you can search quickly through a chapter or track, and use the skip function to jump to the next selection.

#### Searching through a Chapter or Track

During play, press the **SEARCH** (◀◀ or ▶▶) button on the remote control for more than 1 second.



◀ If you want to search at a faster speed on the DVD or CD, press and hold the button.

DVD	2X, 4X, 64X, 128X
CD	2X, 4X, 8X

#### Note

- The speed marked in this function may be different from the actual playback speed.
- No sound is heard during search mode (Except CD).

#### Skipping Tracks

During play, press the **SKIP** (◀◀ or ▶▶) button.



- When playing a DVD, if you press the SKIP (▶▶) button, it moves to the next chapter. If you press the SKIP (◀◀) button, it moves to the beginning of the chapter. Pressing the Skip button twice makes the DVD move to the beginning of the previous chapter.
- When playing a CD, if you press the SKIP (▶▶) button, it moves to the next track. If you press the SKIP (◀◀) button, it moves to the beginning of the track. Pressing the Skip button twice makes the CD move to the beginning of the previous track.

## BASIC FUNCTIONS

### Using the Display Function

#### When Playing a DVD/MPEG4

**1**

During play, press the **INFO** button on the remote control.

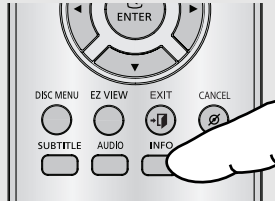

◀ You can select Info in the function menu by pressing the MENU button.

**2**

Press the ▲/▼ buttons to select the desired item.



MPEG4



**3**

Press the ◀/▶ buttons to make the desired setup and then press the **ENTER** button.

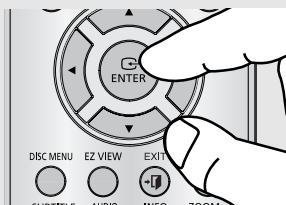

◀ You may use the number buttons of the remote control to directly access a title, chapter or to start the playback from a desired time.





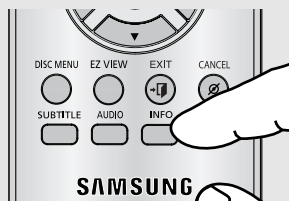

**4**

To make the screen disappear, press the **INFO** button again.



## BASIC FUNCTIONS

### Note

 Title	To access the desired title when there is more than one in the disc. For example, if there is more than one movie on a DVD, each movie will be identified.
 Chapter  Track	Most DVD discs are recorded in chapters so that you can quickly find a specific passage (similar to tracks on an audio CD).
 Time	Allows playback of the film from a desired time. You must enter the starting time as a reference. The time search function does not operate on some discs.
 Audio	Refers to the film's soundtrack language. In the example, the soundtrack is played in English 5.1CH. A DVD disc can have up to eight different soundtracks.
 Subtitle	Refers to the subtitle languages available in the disc. You will be able to choose the subtitle languages or, if you prefer, turn them off from the screen. A DVD disc can have up to 32 different subtitles.

## Using the Disc and Title Menu

### Using the Disc Menu

1

During the playback of a DVD disc, press the **MENU** button on the remote control.

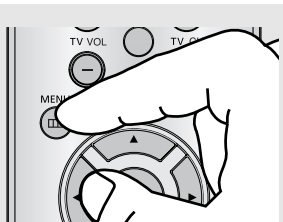

2

Press the **▲/▼** buttons to select **Disc Menu**, then press the **▶** or **ENTER** button.

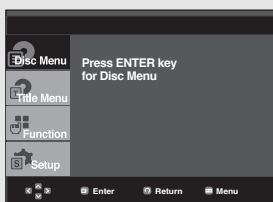

### Note

- Depending on a disc, the Disc Menu may not work.
- You can also select the Disc Menu, using the DISC MENU button on the remote control.

# BASIC FUNCTIONS

## Using the Title Menu

**1**

During the playback of a DVD disc, press the **MENU** button on the remote control.

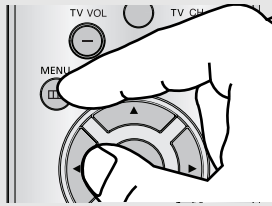

**2**

Press the **▲/▼** buttons to select **Title Menu**, then press the **▶** or **ENTER** button.

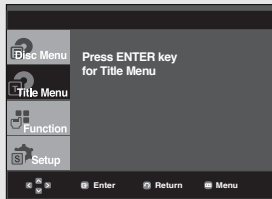

### Note

- Depending on a disc, the Title Menu may not work.
- Title Menu will only be displayed if there are at least two titles in the disc.

## Using the Function Menu

### Using the Function Menu (DVD)

**1**

Press the **MENU** button during playback.

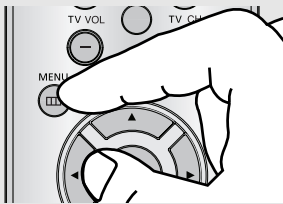

**2**

Press the **▲/▼** buttons to select **Function**, then press the **▶** or **ENTER** button.

- Info (See pages 22 to 23)
- Zoom (See page 35)
- Bookmark (See pages 33 to 34)
- Repeat (See pages 25)
- EZ View (See pages 27 to 28)
- Angle (See pages 31)

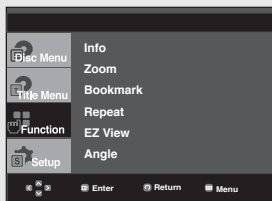

**3**

Press the **▲/▼** buttons to select one of the six functions. Then press the **▶** or **ENTER** button to access the function.

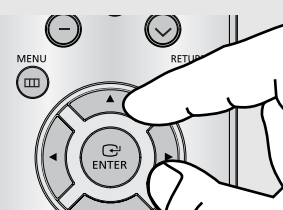

◀ You can also directly select these functions using their respective buttons on the remote control.

- INFO
- ZOOM
- EZ VIEW
- BOOKMARK
- REPEAT



## Repeat Play

Repeat the current track, chapter, title, a chosen section (A-B), or all of the disc.

### When playing a DVD

**1**

Press the **REPEAT** button on the remote control. Repeat screen appears.

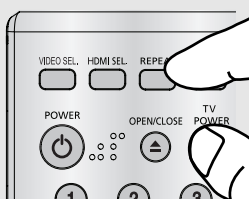

**2**

Press the ◀/▶ buttons to select **Chapter**, **Title** or **A-B**, then press the **ENTER** button.



- ◀ A DVD repeats play by chapter or title.
- Chapter (📀): repeats the chapter that is playing.
- Title (📀): repeats the title that is playing.
- A-B: repeats a segment of the disc that you select.

### Using the A-B Repeat function

1. Press the **REPEAT** button on the remote control.
2. Press the ◀/▶ button to select A-B button in the on screen display.
3. Press the **ENTER** button at the point where you want repeat play to start (A). B is automatically highlighted.
4. Press the **ENTER** button at the point where you want the repeat play to stop (B).
  - To return to normal play, press the **CANCEL** button.

### Note

A-B REPEAT does not allow you to set point (B) until at least 5 seconds of playback time has elapsed after point (A) has been set.

**3**

To return to normal play, press the **REPEAT** button again, then press the ◀/▶ buttons to select **Off** and press the **ENTER** button.

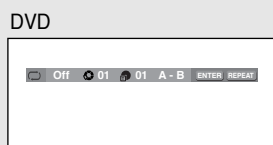

### Note

- Depending on the disc, the Repeat function may not work.

## BASIC FUNCTIONS

### Slow Play

This feature allows you slowly to repeat scenes containing sports, dancing, musical instruments being played etc., so you can study them more closely.

#### When playing a DVD

**1**

During play, press the **PAUSE (||)** button.



**2**

Press the **SEARCH (◀▶)** button to choose the play speed between 1/8, 1/4 and 1/2 of normal speed during PAUSE or STEP mode.



# Chapter 4

## ADVANCED FUNCTIONS

### Adjusting the Aspect Ratio (EZ View)

The Aspect ratio is the relation between the width and height of a picture. The two most common are 4:3 (Standard) and 16:9 (Widescreen). Follow the instructions below for the best aspect ratio setting for your TV.

#### Changing the aspect ratio (DVD)

Press the **EZ VIEW** button.

- The screen size changes when the button is pressed repeatedly.
- The screen zoom mode operates differently depending on the screen setting in the Display Setup menu.
- To ensure correct operation of the **EZ VIEW** button, you should set the correct aspect ratio in the Display Setup menu. (See pages 51 to 53).

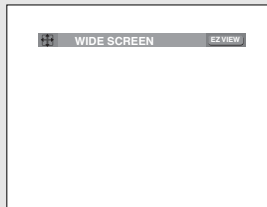
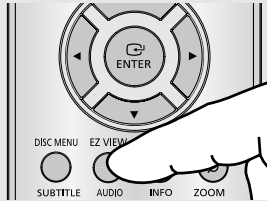

◀ To make the aspect ratio bar disappear, press the **CANCEL** button.

Here are some examples of possible screen sizes by adjusting the aspect ratio :

- 4:3 Letter Box



- 4:3 Pan&Scan



- 16:9 Wide



#### Note

This function may behave differently depending on the type of disc.

## ADVANCED FUNCTIONS

### If you are using a 16:9 TV

#### For 16:9 aspect ratio discs

- **WIDE SCREEN**

Displays the content of the DVD title in 16:9 aspect ratio.

- **SCREEN FIT**

The top and bottom portions of the screen are cut off. When playing a 2.35:1 aspect ratio disc, the black bars at the top and bottom of the screen will disappear. The picture will look vertically stretched. (Depending on a type of disc, the black bars may not disappear completely.)

- **ZOOM FIT**

The top, bottom, left and right of the screen are cut off and the central portion of the screen is enlarged.

#### For 4:3 aspect ratio discs

- **Normal Wide**

Displays the content of the DVD title in 16:9 aspect ratio. The picture will look horizontally stretched.

- **SCREEN FIT**

The top and bottom portions of the screen are cut off and the full screen appears. The picture will look vertically stretched.

- **ZOOM FIT**

The top, bottom, left and right portions of the screen are cut off and the central portion of the screen is enlarged.

- **Vertical Fit**

When a 4:3 DVD is viewed on a 16:9 TV, black bars will appear at the left and right of the screen in order to prevent the picture from looking horizontally stretched.

### If you are using a 4:3 TV

#### For 16:9 aspect ratio discs

- **4:3 Letter Box**

Displays the content of the DVD title in 16:9 aspect ratio. The black bars will appear at the top and bottom of the screen.

- **4:3 Pan&Scan**

The left and right portions of the screen are cut off and the central portion of the 16:9 screen is displayed.

- **SCREEN FIT**

The top and bottom portions of the screen are cut off and a full screen appears. The picture will look vertically stretched.

- **ZOOM FIT**

The top, bottom, left and right of the screen are cut off and the central portion of the screen is enlarged.

#### For 4:3 aspect ratio discs

- **Normal Screen**

Displays the content of the DVD title in 4:3 aspect ratio.

- **SCREEN FIT**

The top and bottom portions of the screen are cut off and the full screen appears. The picture will look vertically stretched.

- **ZOOM FIT**

The top, bottom, left and right portions of the screen are cut off and the central portion of the screen is enlarged.

## Selecting the Audio Language

You can select a desired audio language available on a disc quickly and easily with the AUDIO button.

### Using the AUDIO button (DVD/MPEG4)

#### 1

Press the **AUDIO** button. The Audio changes when the button is pressed repeatedly.

- The audio languages are represented by abbreviations.



#### DVD

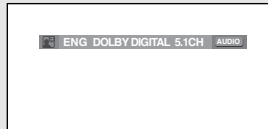

#### MPEG4



Press the **AUDIO** button on the remote control repeatedly to select the desired Audio (MP3, PCM, WMA, AC3 and MPEG) on MPEG4 discs then press the **ENTER** button .

- ◀ MPEG4 is a compressed video format designed to deliver DVD quality video at lower data rates and smaller file sizes. Types of MPEG4 files are DivX or Xdiv. These files have an .avi extension.

#### 2

To remove the **AUDIO** icon, press the **CANCEL** or **RETURN** button.

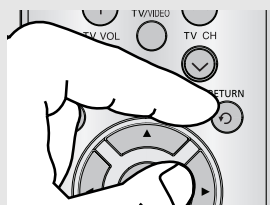

#### Note

- This function depends on audio languages that are encoded on the disc. This function may not work with all DVDs.
- A DVD disc can contain up to 8 audio languages.
- To have the same audio language come up whenever you play a DVD; refer to “Using the Audio Language” on page 46.

## Selecting the Subtitle Language

You can select a desired subtitle quickly and easily with the SUBTITLE button.

### Using the SUBTITLE button (DVD/MPEG4)

**1**

Press the **SUBTITLE** button.  
The subtitle changes when the button is pressed repeatedly.  
The subtitle languages are represented by abbreviations.



DVD



MPEG4

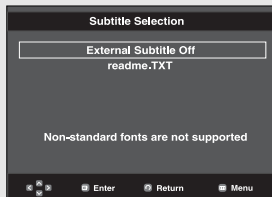

An External subtitle option will appear, depending on the DivX Disc.

Press the Subtitle button on the remote control repeatedly to select the desired subtitle language on an MPEG4 disc.

MPEG4



**2**

To remove the **SUBTITLE** icon, press the **CANCEL** or **RETURN** button.

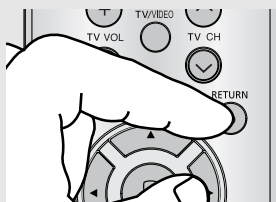
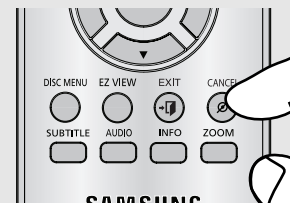

#### Note

- Depending on the DVD, you may have to select the desired subtitle in the DVD's Disc Menu. Press the DISC MENU button.
- This function depends on what subtitles are encoded on the disc. This function may not work with all DVDs.
- A DVD disc can contain up to 32 subtitle languages.
- To have the same subtitle language come up whenever you play a DVD; Refer to "Using the Subtitle Language" on page 47.

## Changing the Camera Angle

When a DVD contains multiple angles of a particular scene, you can use the ANGLE function.

### Using the ANGLE function (DVD)

If the disc contains multiple angles, the ANGLE mark appears on the screen.

**1**

During play, press the **MENU** button on the remote control.

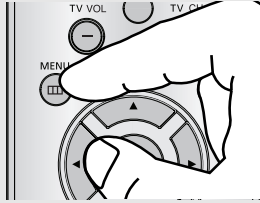

**2**

Press the ▲/▼ buttons to select **Function**, then press the ► or ENTER button.

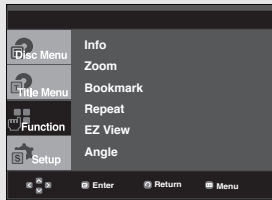

**3**

Press the ▲/▼ buttons to select **Angle**, then press the ► or ENTER button.

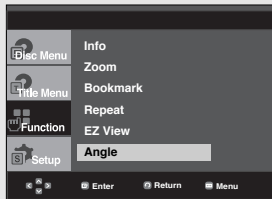

**4**

Press the ◀/▶ buttons on the remote control to select the desired angle.

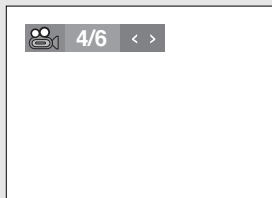

#### Note

- If the disc has only one angle, this feature won't work. Currently, very few discs have this feature.

## ADVANCED FUNCTIONS

### Using the Instant Replay/Skip Function

#### Using the Instant Replay function (DVD)

If you miss a scene, you can see it again using this function.

Press the **INSTANT REPLAY** button.

- The current scene moves backward about 10 seconds, and plays back.



#### Using the Instant Skip function (DVD)

Use this function to skip playback about 10 seconds ahead of the current scene.

Press the **INSTANT SKIP** button.

- Playback will skip ahead 10 seconds.



#### **Note**

Depending on the disc, these functions may not work.



## Using the Bookmark Function

This feature lets you bookmark sections of a DVD, so you can quickly find them at a later time.

### Using the Bookmark Function (DVD)

**1**

During play, press the **MENU** button on the remote control.

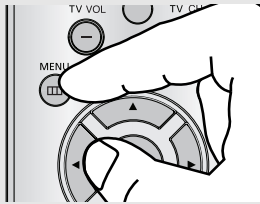

**2**

Press the ▲/▼ buttons to select **Function**, then press the ► or **ENTER** button.

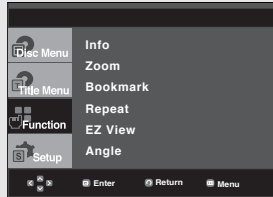

**3**

Press the ▲/▼ buttons to select **Bookmark**, then press the ► or **ENTER** button.

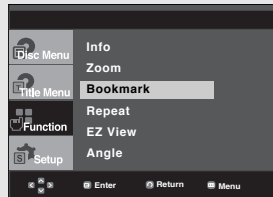

**4**

When you reach the scene you want to mark, press the **ENTER** button. Up to three scenes may be marked at a time.

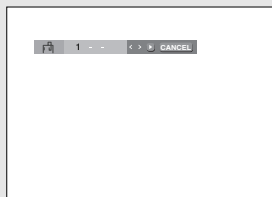

#### Note

- Depending on the disc, the Bookmark function may not work.

## ADVANCED FUNCTIONS

### Recalling a Marked Scene

#### 1~3

The first 1~3 steps are the same as those for "Using the Bookmark Function" on page 33.

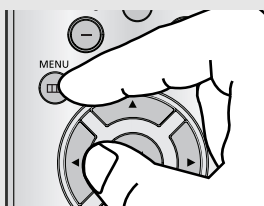

#### 4

Press the ◀/▶ buttons to select a marked scene.

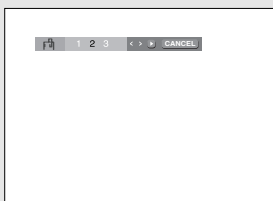

#### 5

Press the **PLAY** (▶) button to skip to the marked scene.



### Clearing a Bookmark

#### 1~3

The first 1~3 steps are the same as those for "Using the Bookmark Function" on page 33.

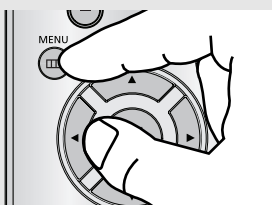

#### 4

Press the ◀/▶ buttons to select the bookmark number you want to delete.

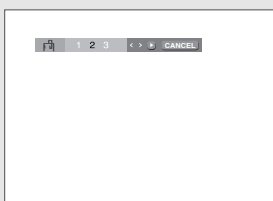

#### 5

Press the **CANCEL** button to delete a bookmark number.

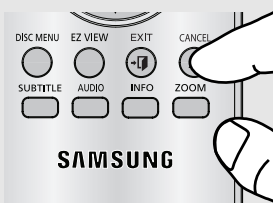

## Using the Zoom Function

### Using the Zoom Function (DVD)

**1**

During play, press the **MENU** button on the remote control.

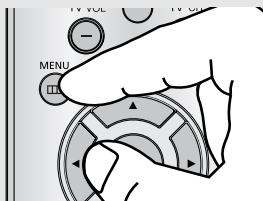

**2**

Press the ▲/▼ buttons to select **Function**, then press the ► or **ENTER** button.

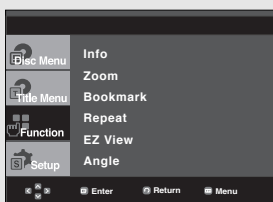

**3**

Press the ▲/▼ buttons to select **Zoom**, then press the ► or **ENTER** button.

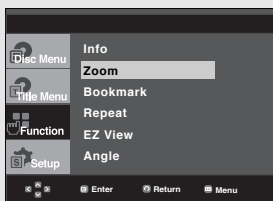

**4**

Press the ▲/▼ or ◀/▶ buttons to select the part of the screen you want to zoom in on. Press the **ENTER** button.

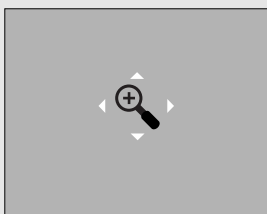

◀ During DVD play, press ENTER to zoom in the following order. 2X → 4X → 2X → Normal.











## ADVANCED FUNCTIONS

### Clips Menu for MP3/WMA/JPEG/MPEG4/CD Audio

CD Audio or discs with MP3/WMA/JPEG/MPEG4 contain individual songs and/or pictures that will be organized into folders on this unit as shown below. They are similar to how you use your computer to put files into different folders.

Open the disc tray.  
Place the disc on the tray.  
Close the tray.  
The tray closes and this screen displays.



-  : Name of currently playing file.
-  : Current Playback Time.
-  : Current Playback Mode : There are four modes. They can be selected in order by pressing the **REPEAT** button.
  - Off: Normal Playback
  - Track: Repeats the current track.
  - Folder: Repeats the current folder.
  - Random: Files in the disc will be played in random order.
-  : MP3 file icon.
-  : WMA file icon.
-  : JPEG file icon.
-  : AVI file icon.
-  : CD Audio file icon.
-  : Folder icon.
-  : Current Folder icon.

#### Note

- When playing MP3, WMA, or JPEG file, the Picture Quality and the HDMI Resolution (see pages 53-54) cannot be set.
- When playing an MPEG4 file, the VIDEO SEL. will only work in the stop mode,

### Folder Selection

The folder can be selected in Stop or Play mode.

- **To select the Parent Folder**  
Press the **RETURN** button to go to the parent folder, or press the **▲/▼** buttons to select “..” and press **ENTER** to go to the parent folder.
- **To select the Peer Folder**  
Press the **▲/▼** buttons to select the desired folder, then press **ENTER**.
- **To select the Sub-Folder**  
Press the **▲/▼** buttons to select the desired folder, then press **ENTER**.

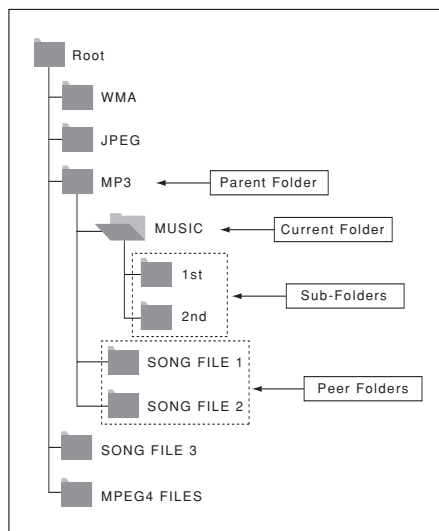

## ADVANCED FUNCTIONS

### MP3/WMA/CD Audio Playback

**1**

Open the disc tray.  
Place the disc on the tray.  
Close the tray.



**2**

Press the ▲/▼ buttons to select a song file.  
Press **ENTER** to begin playback of the song file.

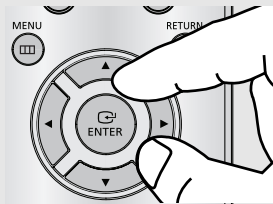

### Repeat/Random playback

**1**

Press the **REPEAT** button to change the playback mode. There are four modes; **Off**, **Track**, **Folder** and **Random**.

- Off: Normal Playback
- Track: Repeats the current song file.
- Folder: Repeats the song files which have the same extension in the current folder.
- Random: Song files which have the same extension will be played in random order.

To resume normal play, press the **CANCEL** button.

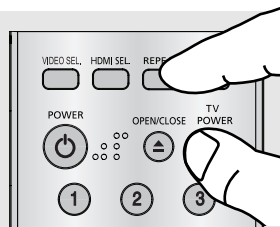

## CD-R MP3/WMA file

When you record MP3 or WMA files on a CD-R for playback in this unit, please refer to the following.

**- Your MP3 or WMA files should be ISO 9660 or JOLIET format.**

ISO 9660 format and Joliet MP3 or WMA files are compatible with Microsoft's DOS and Windows, and with Apple's Mac. This format is the most widely used.

**- When naming your MP3 or WMA files, do not exceed 8 characters, and enter ".mp3, .wma" as the file extension.**

General name format : Title.mp3. or Title.wma. When composing your title, make sure that you use 8 characters or less, have no spaces in the name, and avoid the use of special characters including: (,.,/,=,+).

**- Use a decompression transfer rate of at least 128 Kbps when recording MP3 files.**

Sound quality with MP3 files basically depends on the rate of compression/decompression you choose. Getting CD audio sound requires an analog/digital sampling rate, that is conversion to MP3 format, of at least 128 Kbps and up to 160 Kbps. However, choosing higher rates, like 192 Kbps or more, only rarely give better sound quality. Conversely, files with decompression rates below 128 Kbps will not be played properly.

**- Use a decompression transfer rate of at least 64Kbps when recording WMA files.**

Sound quality with WMA files basically depends on the rate of compression/decompression you choose.

Getting CD audio sound requires an analog/digital sampling rate, that is conversion to WMA format, of at least 64Kbps and up to 192Kbps.

Conversely, files with decompression rates below 64Kbps or over 192Kbps will not be played properly.

Sampling rate that can be supported for WMA files is >30 KHz.

**- Do not try recording copyright protected MP3 files.**

Certain "secured" files are encrypted and code protected to prevent illegal copying. These files are of the following types: Windows Media™ (registered trade mark of Microsoft Inc) and SDMI™ (registered trade mark of The SDMI Foundation). You cannot copy such files.

**- Important:**

The above recommendations cannot be taken as a guarantee that the DVD player will play MP3 recordings, or as an assurance of sound quality. You should note that certain technologies and methods for MP3 file recording on CD-Rs prevent optimal playback of these files on your DVD player (degraded sound quality and in some cases, inability of the player to read the files).

- This unit can play a maximum of 500 files and 500 folders per disc.

## MPEG4 Playback

### MPEG4 Play Function

MPEG4 is a compressed video format designed to deliver DVD quality video at lower data rates and smaller file sizes. Types of MPEG4 files are DivX or Xdiv. These files have an .avi extension. AVI files are used to contain the audio and video data. Only AVI format files with the “.avi” extensions can be played.

**1**

Open the disc tray.  
Place the disc on the tray.  
Close the tray.



**2**

Press the ▲/▼ or ◀/▶ buttons to select an avi file (DivX/XiviD) and then press the **ENTER** button.

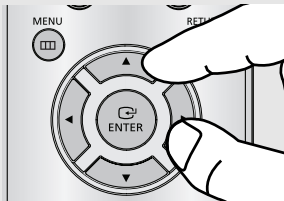

### Repeat and Repeat A-B Playback

Press the REPEAT button to change playback mode. There are 3 modes  
Off, Folder, Title.

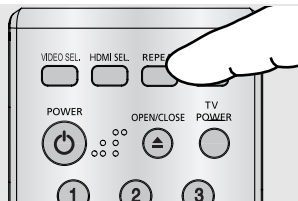

- Folder : repeats the AVI files which have the same extension in the current folder.
- Title : repeats the title that is playing.
- Off : No Repeat mode.

Press the REPEAT A-B button to set the point where you want repeat play to start (A).  
Press the REPEAT A-B button again at the point where you want the repeat play to stop (B).

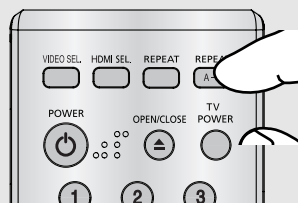

◀ To return to normal play, press the REPEAT A-B button until the display shows Repeat:Off.

#### Note

A-B REPEAT does not allow you to set point (B) until at least 5 seconds of playback time has elapsed after point (A) has been set.

# ADVANCED FUNCTIONS

## MPEG4 Function Description

Function	Description	Reference page
Skip (◀◀ or ▶▶)	During play, press the ◀◀ or ▶▶ button, it moves forward or backward 5 minutes.	-
Search (◀◀ or ▶▶)	During play, press the SEARCH (◀◀ or ▶▶) button and press again to search at a faster speed. Allows you to search at a faster speed in an AVI file. (2X, 4X, 8X)	-
Slow Motion Play	Allows you to search at a slower speed in an AVI file. (1/8X, 1/4X, 1/2X)	P 20
Step Motion Play	Each time the STEP button is pressed, a new frame will appear.	P 20
ZOOM	Will zoom in 2X/4X/2X/Normal	P 35

- Depending on the MPEG4 file, these functions may not work.

### CD-R AVI file

This unit can play the following video compression formats within the AVI file format:

- DivX 3.11 contents
- DivX 4 contents (Based on MPEG-4 Simple Profile)
- DivX 5 contents (MPEG-4 simple profile plus additional features such as bi-directional frames. Qpel and GMC are also supported.)
- XviD MPEG-4 compliant contents.

### DVD-RW & DVD+R

Supported DivX file formats :

- Basic DivX format DivX3.11 / 4.12/ 5.x
- Xvid (MPEG-4 compliant video codec) and DivX Pro
- File format : \*.avi, \*.div, \*.divx.

This unit supports all resolutions up to maximum below.

DivX3.11 & DivX4 & XviD	DivX5
Bitrate may fluctuate: Device may skip decoding the high bitrate portions and begin decoding again when Bitrate returns to normal.	720 x 480 @30fps 720 x 576 @25fps : Maximum bitrate : 4Mbps

### Note

- The DVD-1080P8 can support resolutions up to 720 x 480 @30 frames/ 720 x 576 @25 frames for DivX discs.
- This unit supports CD-R/RWs written in MPEG4 in accordance with the "ISO9660 format".

Possible warning messages that may appear when trying to play DivX/AVI files are :

#### 1. No Authorization

- File with bad registration code.

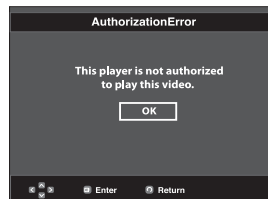

#### 2. Unsupported Codec

- Files with certain Codec Types, Versions (ex. MP4, AFS and other proprietary codecs) are not supported by this player.



#### 3. Unsupported Resolution

- Files containing resolutions higher than the player's specification are not supported.





## Picture CD Playback

**1**

Select the desired folder.  
(See page 37)



**2**

Press the ▲/▼ buttons to select a Picture file in the clips menu and then press the **ENTER** button.

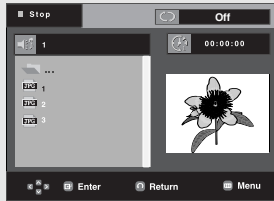

**3**

Press the **INFO** button to display the menu. Press the ◀/▶ buttons to select the menu you want to view, then press the **ENTER** button.

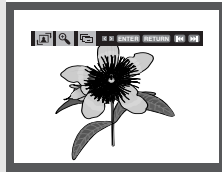

### Note

- Press the **STOP** button to return to the clips menu.
- When playing a Kodak Picture CD, the unit displays the Photo directly, not the clips menu.

### Rotation

 : Each time the **ENTER** button is pressed, the picture rotates 90 degrees clockwise.

### Zoom



 : Press the ▲/▼ buttons to select the part of the screen you want to zoom in on. Press the **ENTER** button. Each time the **ENTER** button is pressed, the picture is enlarged up to 2X.

### Slide Show

-  : The unit enters slide show mode.
- Before beginning the Slide Show, the picture interval must be set.

### Note

- Depending on the file size, the amount of time between each picture may be different from the set interval time.
- If you don't press any button, the slide show will start automatically in about 10 seconds by default.

-  : The pictures change automatically with about a 6 second interval.
-  : The pictures change automatically with about a 12 second interval.
-  : The pictures change automatically with about a 18 second interval.

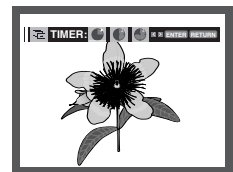

## ADVANCED FUNCTIONS

### MP3-JPEG Playback

You can play a JPEG photo file using music as a background.

**1**

Press the ▲/▼ buttons to select an MP3 file in the clips menu and then press the **ENTER** button.

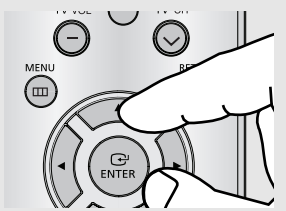

**2**

Press the ▲/▼ buttons to select a JPEG file in the clips menu and then press the **ENTER** button.

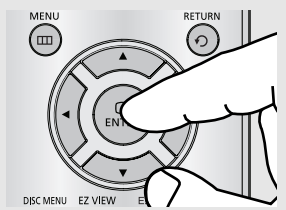

◀ Music will play from the beginning.

**3**

Press the **STOP** button when you want to stop the playback.

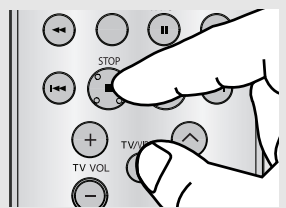

#### Note

MP3 and JPEG files have to be on the same disc.

### CD-R JPEG Discs

- Only files with the ".jpg" and ".JPG" extensions can be played.
- If the disc is not closed, it will take longer to start playing and not all of the recorded files may be played.
- Only CD-R discs with JPEG files in ISO 9660 or Joliet format can be played.
- The name of the JPEG file may not be longer than 8 characters and should contain no blank spaces or special characters (. / = +).
- Only a consecutively written multi-session disc can be played. If there is a blank segment in the multi-session disc, the disc can be played only up to the blank segment.
- A maximum of 3000 images can be stored on a single CD.
- Kodak Picture CDs are recommended.
- When playing a Kodak Picture CD, only the JPEG files in the pictures folder can be played.
- Kodak Picture CD: The JPEG files in the pictures folder can be played automatically.
- Konica Picture CD: If you want to see the Picture, select the JPEG files in the clips menu.
- Fuji Picture CD: If you want to see the Picture, select the JPEG files in the clips menu.
- QSS Picture CD: The unit may not play QSS Picture CD.
- If the number of files in 1 Disc is over 500, only the first 500 JPEG files can be played.
- If the number of folders in 1 Disc is over 500, only the first JPEG files in 500 folders can be played.

# Chapter 5

## NAVIGATING THE SETUP MENU

### Using the Setup Menu

The Setup menu lets you customize your DVD player by allowing you to select various language preferences, set up parental levels, and even adjust the player to the type of television screen you have.

#### 1

With the unit in Stop mode, press the **MENU** button on the remote control.

Press the **▲/▼** buttons to select **Setup**, then press the **▶** or **ENTER** button.

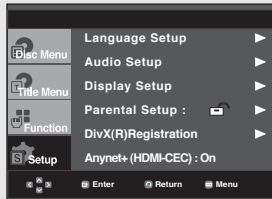

- ❶ Language Setup : Setup of the Language.
- ❷ Audio Setup : Setup of the Audio Options.
- ❸ Display Setup : Setup of the Display Options. Use to select which type of screen you want to watch and several display options.
- ❹ Parental Setup : Setup of the Parental Level. Allows users to set the level necessary to prevent children from viewing unsuitable movies such as those with violence, adult subject matter, etc.
- ❺ Divx(R) Registration : Please use the Registration code to register this player with the DivX(R) Video On Demand format. To learn more go to [www.divx.com/vod](http://www.divx.com/vod).
- ❻ Anynet+(HDMI-CEC) : Setup of the Anynet+(HDMI-CEC) Options.

#### 2

Press the **▲/▼** buttons to access the different features. Press the **▶** or **ENTER** button to access the sub features.

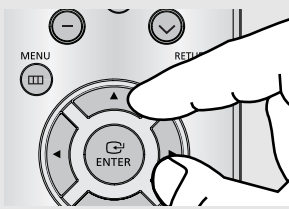

#### 3

To make the setup screen disappear after setting up, press the **MENU** button again.

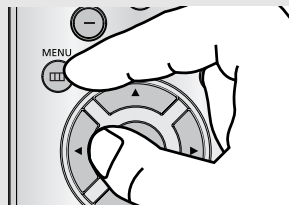

#### Note

Depending on the disc, some Setup menu selections may not work.

## Setting Up the Language Features

If you set the player menu, disc menu, audio and subtitle language in advance, they will come up automatically every time you watch a movie.

### Using the Player Menu Language

**1**

With the unit in Stop mode, press the **MENU** button.

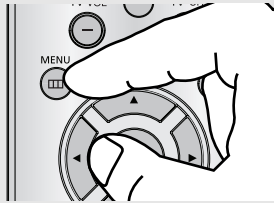

**2**

Press the **▲/▼** buttons to select **Setup**, then press the **▶** or **ENTER** button.

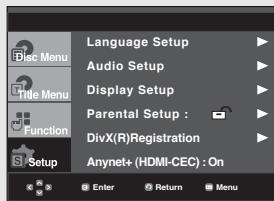

**3**

Press the **▲/▼** buttons to select **Language Setup**, then press the **▶** or **ENTER** button.

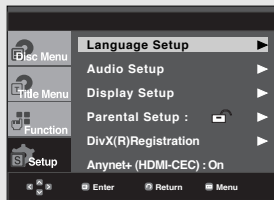

**4**

Press the **▲/▼** buttons to select **Player Menu**, then press the **▶** or **ENTER** button.



**5**

Press the **▲/▼** buttons to select the desired language, then press the **▶** or **ENTER** button.



- ◀ - The language is selected and the screen returns to the Language Setup menu.
- To make the setup menu disappear, press the **MENU** button.

# NAVIGATING THE SETUP MENU

## Using the Disc Menu Language

This function changes the text language only on the disc menu screens.

**1**

With the unit in Stop mode, press the **MENU** button.

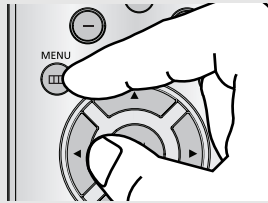

**2**

Press the **▲/▼** buttons to select **Setup**, then press the **▶** or **ENTER** button.

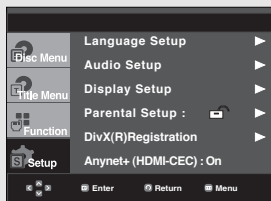

**3**

Press the **▲/▼** buttons to select **Language Setup**, then press the **▶** or **ENTER** button.

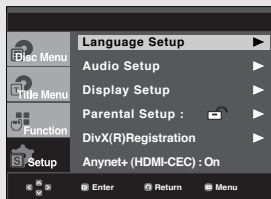

**4**

Press the **▲/▼** buttons to select **Disc Menu**, then press the **▶** or **ENTER** button.



**5**

Press the **▲/▼** buttons to select the desired language, then press the **▶** or **ENTER** button.



- ◀ - If the selected language is not recorded on the disc, the original pre-recorded language is selected.
- The language is selected and the screen returns to the Language Setup menu.
- To make the setup menu disappear, press the MENU button.

# NAVIGATING THE SETUP MENU

## Using the Audio Language

**1**

With the unit in Stop mode, press the **MENU** button.

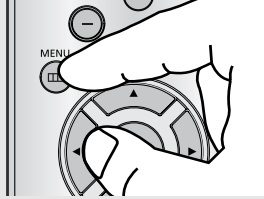

**2**

Press the ▲/▼ buttons to select **Setup**, then press the ► or **ENTER** button.

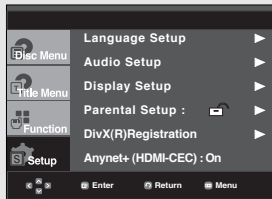

**3**

Press the ▲/▼ buttons to select **Language Setup**, then press the ► or **ENTER** button.

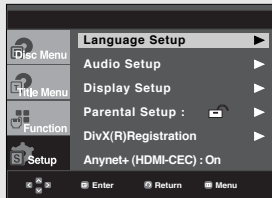

**4**

Press the ▲/▼ buttons to select **Audio**, then press the ► or **ENTER** button.

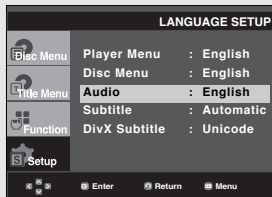

**5**

Press the ▲/▼ buttons to select the desired language, then press the ► or **ENTER** button.



- ◀ - Select "Original" if you want the default soundtrack language to be the original language the disc is recorded in.
- If the selected language is not recorded on the disc, the original pre-recorded language is selected.
- The language is selected and the screen returns to the Language Setup menu.
- To make the setup menu disappear, press the **MENU** button.

# NAVIGATING THE SETUP MENU

## Using the Subtitle Language

**1**

With the unit in Stop mode, press the **MENU** button.

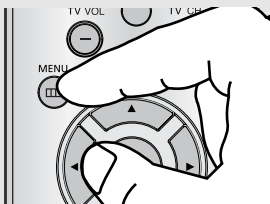

**2**

Press the **▲/▼** buttons to select **Setup**, then press the **▶** or **ENTER** button.

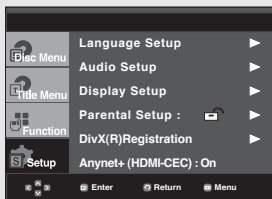

**3**

Press the **▲/▼** buttons to select **Language Setup**, then press the **▶** or **ENTER** button.



**4**

Press the **▲/▼** buttons to select **Subtitle**, then press the **▶** or **ENTER** button.

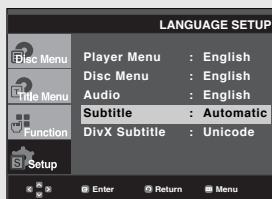

**5**

Press the **▲/▼** buttons to select the desired language, then press the **▶** or **ENTER** button.



- ◀ - Select "Automatic" if you want the subtitle language to be the same as the language selected as the audio language.
- Some discs may not contain the language you select ; in that case the disc will use its original language setting.
- The language is selected and the screen returns to the setup menu.
- To make the setup menu disappear, press the **MENU** button.

## NAVIGATING THE SETUP MENU

### Using the DivX Subtitle Language

**1**

With the unit in Stop mode, press the **MENU** button.

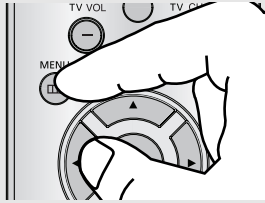

**2**

Press the ▲/▼ buttons to select **Setup**, then press the ► or **ENTER** button.

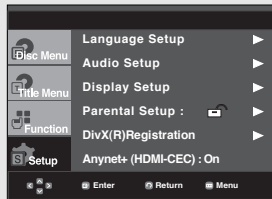

**3**

Press the ▲/▼ buttons to select **Language Setup**, then press the ► or **ENTER** button.

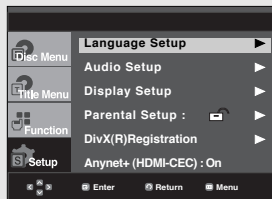

**4**

Press the ▲/▼ buttons to select **DivX Subtitle**, then press the ► or **ENTER** button.

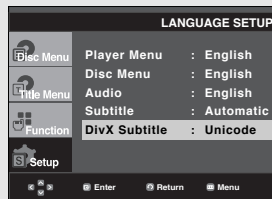

**5**

Press the ▲/▼ buttons to select the desired language, then press the ► or **ENTER** button.



- ◀ - The language is selected and the screen returns to the setup menu.
- To make the setup menu disappear, press the **MENU** button.



## Setting Up the Audio Options

Audio Options allow you to set up the audio device and sound status settings depending on the audio system in use.

**1**

With the unit in Stop mode, press the **MENU** button.

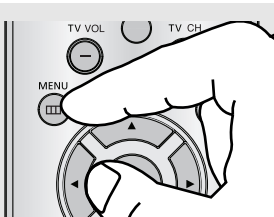

**2**

Press the ▲/▼ buttons to select **Setup**, then press the ► or **ENTER** button.

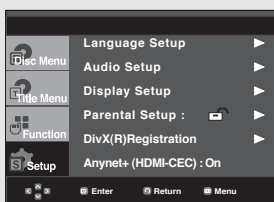

**3**

Press the ▲/▼ buttons to select **Audio Setup**, then press the ► or **ENTER** button.

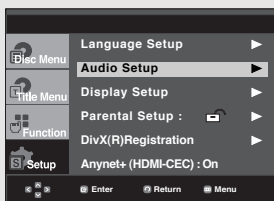

**4**

Press the ▲/▼ buttons to select the desired item, then press the ► or **ENTER** button.

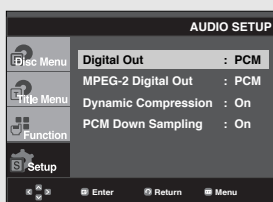

◀ To make the setup menu disappear, press the **MENU** button.

## NAVIGATING THE SETUP MENU

The following describes each option found in the Audio Setup Menu.

### ① Digital Out

- PCM : Converts to PCM(2CH) audio.
- Bitstream : Outputs Dolby Digital via digital output.  
Select Bitstream when connecting to a Dolby Digital Decoder.

### ② MPEG-2 Digital Out

- PCM : Converts to PCM(2CH) audio.
- Bitstream : Converts to MPEG-2 Digital Bitstream (5.1 or 7.1 CH). Select Bitstream when using the Digital Audio Output.

### ③ Dynamic Compression

- On : To select dynamic compression. This is useful for watching movies late at night, as it balances the loud and quiet portions of a disc.
- Off : To select the standard range.

### ④ PCM Down Sampling

- On : Select this when the Amplifier connected to the player is not 96KHZ compatible. In this case, the 96KHZ signals will be down converted to 48KHZ.
- Off : Select this when the Amplifier connected to the player is 96KHZ compatible. In this case, all signals will be output without any changes.

### Note

Even when PCM Down sampling is Off, some discs will only output down-sampled audio through the digital outputs.

### HDMI

- **If your TV is not compatible with compressed multi-channel formats (Dolby Digital, DTS, MPEG), you should set Digital Audio to PCM.**
- **If your TV is not compatible with LPCM sampling rates over 48kHz, you should set PCM Down sampling to On.**

### Note

- To make the Setup menu disappear, press the MENU button.
- There is no analog audio output when you play a DTS disc.  
You must make a Digital audio connection (Optical or Coaxial).

Manufactured under license from Dolby Laboratories. "Dolby" and the double-D symbol are trademarks of Dolby Laboratories.

"DTS" and "DTS Digital Out" are trademarks of Digital Theater Systems, Inc.

## NAVIGATING THE SETUP MENU

### Setting Up the Display Options

Display options enable you to set various video functions of the player.

**1**

With the unit in Stop mode, press the **MENU** button.

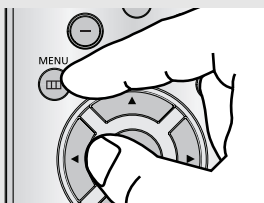

**2**

Press the ▲/▼ buttons to select **Setup**, then press the ► or **ENTER** button.

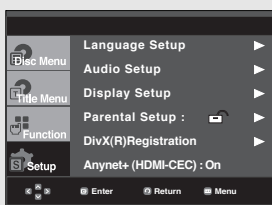

**3**

Press the ▲/▼ buttons to select **Display Setup**, then press the ► or **ENTER** button.

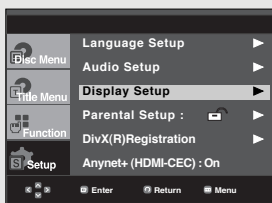

**4**

Press the ▲/▼ buttons to select the desired item, then press the ► or **ENTER** button.

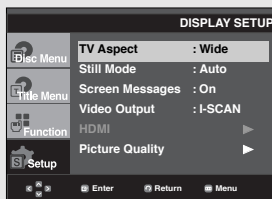

◀ To make the setup menu disappear, press the **MENU** button.

## NAVIGATING THE SETUP MENU

The following describes each option found in the Display Setup Menu.

### ① TV Aspect

Depending on a type of television you have, you may want to adjust the screen setting (aspect ratio).

- **4:3 Letter Box** : Select when you want to see the total 16:9 ratio screen DVD supplies, even though you have a TV with a 4:3 ratio screen. Black bars will appear at the top and bottom of the screen.
- **4:3 Pan&Scan** : Select this for conventional size TVs when you want to see the central portion of the 16:9 screen. (Extreme left and right side of movie picture will be cut off.)
- **16:9 Wide** : You can view the full 16:9 picture on your widescreen TV.

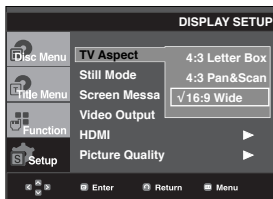

### ② Still Mode

These options will help prevent picture shake in still mode and display small text clearer.

- **Auto** : When selecting Auto, Field/Frame mode will be automatically adjusted.
- **Field** : Select this feature to minimize screen shaking.
- **Frame** : Select this feature when you want to read text more clearly on the screen .

### ③ Screen Messages

Use to turn on-screen messages On or Off.

### ④ Video Output

Select Video Output.

- **I-SCAN** : Select when you want to use Video and Component 480i(Interlace) Out.
- **P-SCAN** : Select when you want to use Component 480p(Progressive) Out or HDMI.
  - If you press the VIDEO SEL. button with no disc inserted, the Video output mode is changed in the following order:  
(I-SCAN → P-SCAN)
- If the Yes/No selection in the Display Setup sub Menu is not made within 10 seconds,

the screen returns to the previous menu.

### ⑤ HDMI

This setting is used when the unit is connected by HDMI to Display devices (TV, Projector, etc.).

#### - Resolution Setting

The resolution setting is dependent on the capability of your TV or Monitor.

- Auto : Auto resolution setting
- Manual : Manual resolution setting

#### - Resolution

- 480p : 720 x 480
- 720p : 1280 x 720
- 1080i : 1920 x 1080
- 1080p : 1920 x 1080

For the best video performance, check your TV's user manual for proper resolution setting.

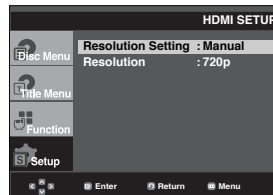

If your TV does not support the resolution that has been chosen, the following warning message may appear and the resolution will be returned to the previous setting.

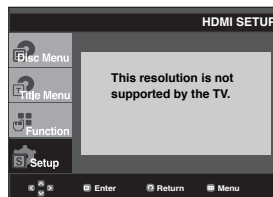

## NAVIGATING THE SETUP MENU

### ⑥ Picture Quality

- Black Level : Adjusts the brightness of the screen (On or Off). It does not function in Progressive mode.
- Brightness : Level 1 ~ Level 5
- Contrast : Level 1 ~ Level 5
- Color Saturation : Level 1 ~ Level 5

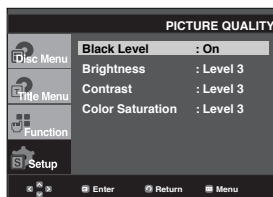

- Consult your TV User's Manual to find out if your TV supports Progressive Scan. If Progressive Scan is supported, follow the TV User's Manual regarding Progressive Scan settings in the TV's menu system.
- If Video Output is set incorrectly, the TV screen may be blank.
- The resolutions available for HDMI output depend on the connected TV or projector. For details, see the user's manual of your TV or projector.
- When the resolution is changed during playback, it may take a few seconds for a normal image to appear.
- If you have HDMI connected, better picture quality will be provided when the output resolution is set to 720p, 1080i or 1080p.

## Setting Up the Parental Control

The Parental Control function works in conjunction with DVDs that have been assigned a rating, which helps you control the types of DVDs that your family watches. There are up to 8 rating levels on a disc.

### Setting Up the Rating Level

**1**

With the unit in Stop mode, press the **MENU** button.

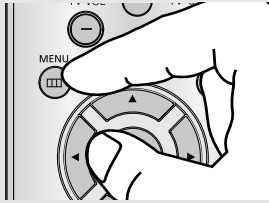

**2**

Press the **▲/▼** buttons to select **Setup**, then press the **▶** or **ENTER** button.

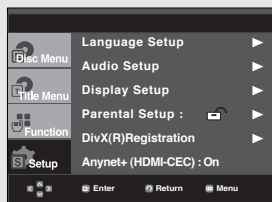

**3**

Press the **▲/▼** buttons to select **Parental Setup**, then press the **▶** or **ENTER** button.

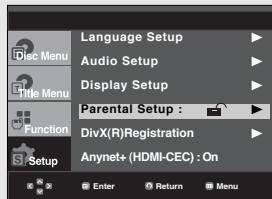

**4**

Press the **▲/▼** buttons to select **Rating Level**, then press the **▶** or **ENTER** button.

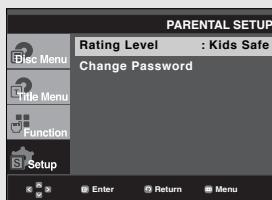

**5**

Enter your password. By default, password is set to 0000. Please change password to other than 0000 to activate parental control function.

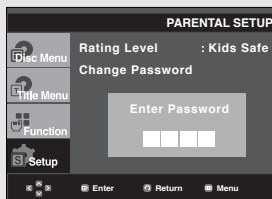

**6**

Press the **▲/▼** buttons to select the Rating Level you want, then press the **▶** or **ENTER** button.  
e.g) Setting up in **Kids Safe**.

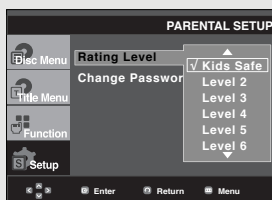

◀ To make the setup menu disappear, press the **MENU** button.

For example, if you select the Kids Safe level, discs that contain level 2 or higher will not play.

# NAVIGATING THE SETUP MENU

## Changing the Password

**1**

With the unit in Stop mode, press the **MENU** button.

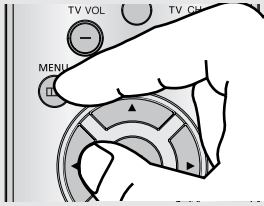

**2**

Press the **▲/▼** buttons to select **Setup**, then press the **▶** or **ENTER** button.

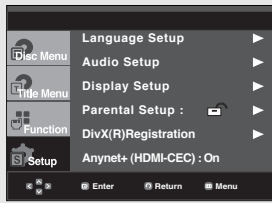

**3**

Press the **▲/▼** buttons to select **Parental Setup**, then press the **▶** or **ENTER** button.

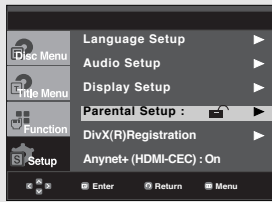

**4**

Press the **▲/▼** button to select **Change Password**, then press the **▶** or **ENTER** button. Enter your new password. Re-enter the new password again.

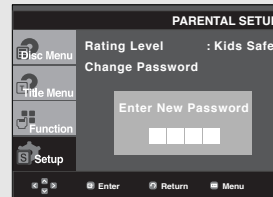
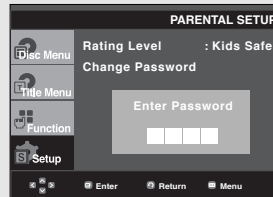
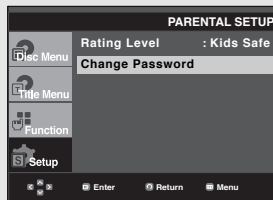

◀ To make the setup menu disappear, press the **MENU** button.

### Note

If you have forgotten your password, see "Forgot Password" in the Troubleshooting Guide.

## Setting Up Anynet+(HDMI-CEC)

Anynet+ is a function that can be used to operate this DVD Player using a Samsung TV remote control. This is done by connecting the DVD player to a SAMSUNG TV using an HDMI Cable. (see pages 12-13) This is only available with SAMSUNG TVs that support Anynet+.

To operate Anynet+, you must turn Anynet+(HDMI-CEC) On in the Setup Menu.

**1**

With the unit in Stop mode, press the **MENU** button.

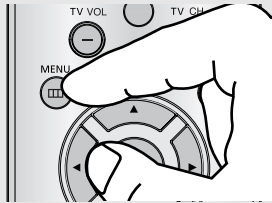

**2**

Press the **▲/▼** buttons to select **Setup**, then press the **▶** or **ENTER** button.

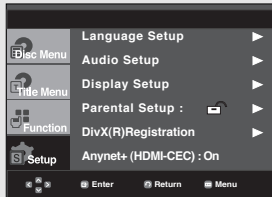

**3**

Press the **▲/▼** buttons to select **Anynet+(HDMI-CEC)**, then press the **▶** or **ENTER** button.

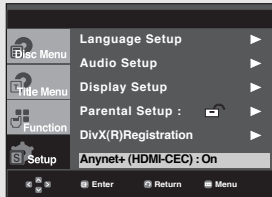

**4**

Set the Anynet+(HDMI-CEC) to **"On"** on your DVD Player., then press the **▶** or **ENTER** button.

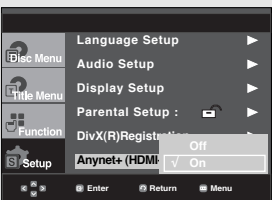

◀ To make the setup menu disappear, press the **MENU** button.

**5**

Set the Anynet+ function on your Samsung TV. (See your TV instruction manual for more information.)

- When you press Anynet+ button on the TV remote control, the OSD to the right will appear.



**TV Menu**



## NAVIGATING THE SETUP MENU

You can operate the DVD Player by using the TV remote control. These TV remote buttons can be used to operate the DVD Player:

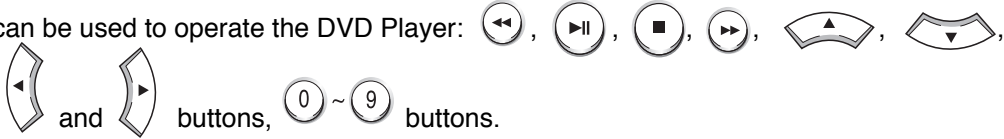

- **Select Device** : Use this option to select device which you want to connect to your TV.
- **Menu on Device** : Same as MENU button on the DVD Player remote control.
- **Device Operation** : Same as INFO button on the DVD Player remote control.

### Note

- While watching TV, your TV screen will change to the play screen when you press the **PLAY** button of the DVD player.
- If you play a DVD when the TV power is off, the TV will power On.
- If you turn the TV off, the DVD Player will power off automatically.
- If you change from HDMI to other sources (Composite, Component, ... etc) while playing a DVD disc, the DVD Player will stop playing.

# Chapter 6

## REFERENCE

### Firmware upgrade

#### Introduction

Upgrading the Firmware will keep your DVD player up to date.

The latest firmware version for this unit is provided on the Samsung Website.([www.samsung.com](http://www.samsung.com)).

#### How to make an upgrade disc

You must burn the latest firmware version onto a blank CD-R or CD-RW disc:

1. Download a new file from Samsung's website ([www.samsung.com](http://www.samsung.com)) Download Center.
2. Write the file to Disc using the CD-RW drive of your computer.

#### Note

The CD should be burned following the specs below.

- File System CD-ROM ISO Level.
- Character set ISO 9660.
- The burned CD has to be Finalized.
- Please burn the CD at a low speed.

#### Upgrade procedure

1. Open the disc tray of your DVD1080P8. Place the burned disc on the tray. Close the tray. The Firmware upgrade screen will appear.

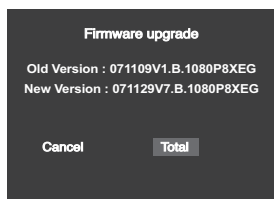

Firmware upgrade menu appears

2. Press the ◀/▶ buttons to select **Total**, then press the ENTER button.

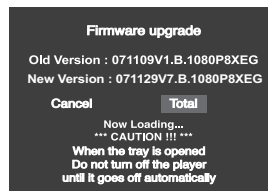

Firmware upgrade starts

- During the firmware upgrade process, the tray will open. Please remove the disc and wait for about 2 minutes.
  - If the DVD player was successfully updated, the disc tray will close and the unit will turn off and on. When the unit turns on, the Select Menu Language screen will appear.
3. Press the number buttons to select the desired language.





#### Note

- If the "Select Menu Language" doesn't appear, please contact Samsung Customer Service.
- Do not press any button or unplug the power cord during the upgrade.
- The upgrade procedure may change, refer to the web site ([www.samsung.com](http://www.samsung.com)).
- When software is upgrade, video and audio settings you have made will return to their default (factory) settings. We recommend you write down your settings so that you can easily reset them after the upgrade.

## Troubleshooting

Before requesting service, please check the following.

Problem	Action	Page
No operations can be performed with the remote control.	<ul style="list-style-type: none"> <li>• Check the batteries in the remote control. They may need replacing.</li> <li>• Operate the remote control at a distance of no more than 20 feet.</li> <li>• Remove batteries and hold down one or more buttons for several minutes to drain the microprocessor inside the remote control to reset it. Reinstall batteries and try to operate the remote control again.</li> </ul>	P5
Disc does not play.	<ul style="list-style-type: none"> <li>• Ensure that the disc is installed with the label side facing up.</li> <li>• Check the region number of the DVD.</li> </ul>	P8
5.1 channel sound is not being reproduced.	<ul style="list-style-type: none"> <li>• 5.1 channel sound is reproduced only when the following conditions are met :                             <ol style="list-style-type: none"> <li>1) The DVD player is connected with the proper Amplifier</li> <li>2) The disc is recorded with 5.1 channel sound.</li> </ol> </li> <li>• Check whether the disc being played has the "5.1 ch" mark on the outside.</li> <li>• Check if your audio system is connected and working properly.</li> <li>• In a SETUP Menu, is the Audio Output set to Bitstream?</li> </ul>	P18  P49-50
The  icon appears on screen.	<ul style="list-style-type: none"> <li>• The features or action cannot be completed at this time because:                             <ol style="list-style-type: none"> <li>1. The DVD's software restricts it.</li> <li>2. The DVD's software doesn't support the feature (e.g., angles).</li> <li>3. The feature is not available at the moment.</li> <li>4. You've requested a title or chapter number or search time that is out of range.</li> </ol> </li> </ul>	
Disc Menu doesn't appear.	<ul style="list-style-type: none"> <li>• Check if the disc has a Menu.</li> </ul>	
Play mode differs from the Setup Menu selection.	<ul style="list-style-type: none"> <li>• Some of the functions selected in the Setup Menu may not work properly if the disc is not encoded with the corresponding function.</li> </ul>	P43-57
The screen ratio cannot be changed.	<ul style="list-style-type: none"> <li>• The Screen Ratio is fixed on your DVDs.</li> </ul>	P51-53
No audio.	<ul style="list-style-type: none"> <li>• Make sure you have selected the correct Digital Output in the Audio Options Menu.</li> </ul>	P49-50
The screen is blocked	<ul style="list-style-type: none"> <li>• Press the  button (on the front panel) for more than 5 seconds with no disc inside. All settings will revert to the factory settings.</li> </ul>	P19
Forgot password	<ul style="list-style-type: none"> <li>• Press the  button (on the panel) for more than 5 seconds with no disc inside. All settings including the password will revert to the factory settings. Don't use this unless absolutely necessary.</li> </ul>	P54
If you experience other problems.	<ul style="list-style-type: none"> <li>• Go to the contents and find the section of the instruction book that contains the explanations regarding the current problem, and follow the procedure once again.</li> <li>• If the problem still cannot be solved, please contact your nearest Samsung authorized service center.</li> </ul>	
The picture is noisy or distorted	<ul style="list-style-type: none"> <li>• Make sure that the disc is not dirty or scratched.</li> <li>• Clean the disc.</li> </ul>	P4

## REFERENCE

<b>Problem</b>	<b>Action</b>	<b>Page</b>
No HDMI output.	<ul style="list-style-type: none"><li>• Check the if the Video output is set to HDMI.</li><li>• Check the connection between the TV and the HDMI jack of DVD player.</li><li>• See if the TV supports this 480p/720p/1080i/1080p DVD player.</li></ul>	P12~13
Abnormal HDMI output screen.	<ul style="list-style-type: none"><li>• If snow noise appears on the screen, it means that TV does not support HDCP (High-bandwidth Digital Content Protection).</li></ul>	P12~13
HDMI output Jitter	<ul style="list-style-type: none"><li>• Check if your TV is setup correctly.</li><li>• Screen Jitter may occur when frame rate is converted from 50Hz to 60Hz for 720P/1080i/1080p HDMI (High Definition Multimedia Interface) Output.</li><li>• Please refer to the user's manual of your TV.</li></ul>	P51~53

# REFERENCE

## Specifications

General	Power Requirements	AC 120V ~ 60 Hz
	Power Consumption	9W (ON condition), 1W (OFF condition)
	Weight	0.77 lbs 0.048 oz
	Dimensions	17.2" (W) X 18" (D) X 1.8" (H)
	Operating Temperature Range	+41°F to +95°F
	Operating Humidity Range	10 % to 75 %
Disc	DVD (DIGITAL VERSATILE DISC)	Reading Speed : 3.49 ~ 4.06 m/sec. Approx. Play Time (Single Sided, Single Layer Disc) : 135 min.
	CD : 5" (COMPACT DISC)	Reading Speed : 4.8 ~ 5.6 m/sec. Maximum Play Time : 74 min.
	CD : 3 1/2" (COMPACT DISC)	Reading Speed : 4.8 ~ 5.6 m/sec. Maximum Play Time : 20 min.
Video Output	Composite Video	1 channel : 1.0 Vp-p (75 Ω load)
	Component Video	Y : 1.0 Vp-p (75 Ω load) Pr : 0.70 Vp-p (75 Ω load) Pb : 0.70 Vp-p (75 Ω load)
	HDMI	480p, 720p, 1080i, 1080p
Audio Output	2 Channel	L(1/L), R(2/R)
	*Frequency Response	48 kHz Sampling : 4 Hz to 22 kHz 96 kHz Sampling : 4 Hz to 44 kHz
	*S/N Ratio	110 dB
	*Dynamic Range	100 dB
	*Total Harmonic Distortion	0.004 %

\*: Nominal specification

- Samsung Electronics Co., Ltd reserves the right to change the specifications with out notice.
- Weight and dimensions are approximate.

## Contact SAMSUNG WORLD WIDE

If you have any questions or comments relating to Samsung products, please contact the SAMSUNG customer care center.

Region	Country	Customer Care Center ☎	Web Site
North America	CANADA	1-800-SAMSUNG(726-7864)	www.samsung.com/ca
	MEXICO	01-800-SAMSUNG(726-7864)	www.samsung.com
	U.S.A	1-800-SAMSUNG(726-7864)	www.samsung.com
Latin America	ARGENTINE	0800-333-3733	www.samsung.com/ar
	BRAZIL	0800-124-421 , 4004-0000	www.samsung.com
	CHILE	800-SAMSUNG(726-7864)	www.samsung.com/cl
	NICARAGUA	00-1800-5077267	
	HONDURAS	800-7919267	
	COSTA RICA	0-800-507-7267	www.samsung.com/latin
	ECUADOR	1-800-10-7267	www.samsung.com/latin
	EL SALVADOR	800-6225	www.samsung.com/latin
	GUATEMALA	1-800-299-0013	www.samsung.com/latin
	JAMAICA	1-800-234-7267	www.samsung.com/latin
	PANAMA	800-7267	www.samsung.com/latin
	PUERTO RICO	1-800-682-3180	www.samsung.com/latin
	REP. DOMINICA	1-800-751-2676	www.samsung.com/latin
	TRINIDAD & TOBAGO	1-800-SAMSUNG(726-7864)	www.samsung.com/latin
VENEZUELA	0-800-100-5303	www.samsung.com/latin	
COLOMBIA	01-8000112112	www.samsung.com.co	
Europe	BELGIUM	0032 (0)2 201 24 18	www.samsung.com/be
	CZECH REPUBLIC	844 000 844 Distributor pro Českou republiku: Samsung Zrt., česká organizační složka Vyskočilova 4, 14000 Praha 4	www.samsung.com/cz
	DENMARK	70 70 19 70	www.samsung.com/dk
	FINLAND	030-6227 515	www.samsung.com/fi
	FRANCE	3260 SAMSUNG (€ 0,15/Min), 08 25 08 65 65 (€ 0,15/Min)	www.samsung.com
	GERMANY	01805 - SAMSUNG(726-7864) (€ 0,14/Min)	www.samsung.com
	HUNGARY	06-80-SAMSUNG(726-7864)	www.samsung.com
	ITALIA	800-SAMSUNG(726-7864)	www.samsung.com
	LUXEMBURG	0035 (0)2 261 03 710	www.samsung.com/be
	NETHERLANDS	0900-SAMSUNG(726-7864) (€ 0,10/Min)	www.samsung.com/nl
	NORWAY	815-56 480	www.samsung.com/no
	POLAND	0 801 801 881 , 022-607-93-33	www.samsung.com/pl
	PORTUGAL	80820-SAMSUNG(726-7864)	www.samsung.com/pt
	SLOVAKIA	0800-SAMSUNG(726-7864)	www.samsung.com/sk
	SPAIN	902 10 11 30	www.samsung.com
	SWEDEN	0771-400 200	www.samsung.com/se
	U.K	0845 SAMSUNG (7267864)	www.samsung.com
	EIRE	0818 717 100	www.samsung.com/ie
	AUSTRIA	0800-SAMSUNG(726-7864)	www.samsung.com/at
	SWITZERLAND	0800-SAMSUNG(726-7864)	www.samsung.com/ch
CIS	RUSSIA	8-800-555-55-55	www.samsung.com
	KAZAHSTAN	8-10-800-500-55-500	www.samsung.kz
	UZBEKISTAN	8-10-800-500-55-500	www.samsung.uz
	KYRGYZSTAN	00-800-500-55-500	
	TADJIKISTAN	8-10-800-500-55-500	
	UKRAINE	8-800-502-0000	www.samsung.com
	LITHUANIA	8-800-77777	www.samsung.lt
	LATVIA	800-7267	www.samsung.com/lv
	ESTONIA	800-7267	www.samsung.ee
	Asia Pacific	AUSTRALIA	1300 362 603
NEW ZEALAND		0800SAMSUNG(726-7864)	www.samsung.com/nz
CHINA		800-810-5858 , 010-6475 1880	www.samsung.com
HONG KONG		3698-4698	www.samsung.com/hk
INDIA		3030 8282 , 1800 110011	www.samsung.com
INDONESIA		0800-112-8888	www.samsung.com
JAPAN		0120-327-527	www.samsung.com/jp
MALAYSIA		1800-88-9999	www.samsung.com/my
PHILIPPINES		1800-10-SAMSUNG(726-7864)	www.samsung.com/ph
SINGAPORE		1800-SAMSUNG(726-7864)	www.samsung.com
THAILAND		1800-29-3232 , 02-689-3232	www.samsung.com
TAIWAN		0800-329-999	www.samsung.com/tw
VIETNAM		1 800 588 889	www.samsung.com
Middle East & Africa	TURKEY	444 77 11	www.samsung.com
	SOUTH AFRICA	0860-SAMSUNG(726-7864 )	www.samsung.com
	U.A.E	800-SAMSUNG (726-7864), 8000-4726	www.samsung.com

# Warranty

---

## LIMITED WARRANTY TO ORIGINAL PURCHASER

This SAMSUNG brand product, as supplied and distributed by SAMSUNG ELECTRONICS AMERICA, INC. (SAMSUNG) and delivered new, in the original carton to the original consumer purchaser, is warranted by SAMSUNG against manufacturing defects in materials and workmanship for the following limited warranty period:

### **One (1) Year Parts / Ninety days (90) Labor**

This limited warranty begins on the original date of purchase, and is valid only on products purchased and used in the United States, and does not include transportation, installation, removal or reinstallation. Warranty repairs must be performed by SAMSUNG's authorized service center. To receive warranty service, the original dated bill of sale must be presented upon request as proof of purchase to SAMSUNG or SAMSUNG's authorized service center. Transportation to and from the service center is the responsibility of the purchaser.

SAMSUNG will repair or replace this product, at our option and at no charge with new or reconditioned parts, if found to be defective during the limited warranty period specified above. The product must be returned during the warranty period with transportation charges prepaid to SAMSUNG's designated service center. Prior to returning any product for warranty service, the purchaser must contact SAMSUNG for problem determination and service procedures. SAMSUNG does not warrant uninterrupted or error-free operation of the product. All replaced parts and products become the property of SAMSUNG and must be returned to SAMSUNG. Replacement parts and products assume the remaining original warranty, or ninety (90) days, whichever is longer.

This limited warranty covers manufacturing defects in materials and workmanship encountered in normal, noncommercial use of this product and shall not apply to the following, including, but not limited to: damage which occurs in shipment; applications and uses for which this product was not intended; failures or problems which are caused by products or equipment not supplied by SAMSUNG; accidents, misuse, abuse, neglect, misapplication, fire, water, lightning or other acts of nature; incorrect electrical line voltage, fluctuations or surges; damage caused by improper or faulty installation; improper connection with any peripheral; product alteration or modification; improper or unauthorized repair; cosmetic damage or exterior finish; product with altered serial numbers; failure to follow operating instructions, customer adjustments, maintenance and environmental instructions that are covered and prescribed in the instruction book; use of non-SAMSUNG or unauthorized parts, supplies, accessories or equipment which damage this product or result in service problems; failures or problems due to incompatibility with other equipment.



**Contact SAMSUNG WORLDWIDE**

If you have any questions or comments relating to Samsung products,  
please contact the SAMSUNG customer care center.

☎ 1-800-SAMSUNG (7267864)/[www.samsung.com](http://www.samsung.com)

Samsung Electronics America, Inc.

105 Challenger Road

Ridgefield Park, NJ 07660-0511

1-800-SAMSUNG (7267864)

[www.samsung.com](http://www.samsung.com)