

HT-BD7200

# 2.1CH Blu-ray Home Theater System user manual

imagine the possibilities

Thank you for purchasing this Samsung product.

To receive more complete service,  
please register your product at

[www.samsung.com/register](http://www.samsung.com/register)



# Key features of your new Blu-ray Home Theater

---

## PLAYER FEATURES

---

### **Playback of many disc types, plus an FM Tuner**

The HT-BD7200 allows you to play various discs, including BD-ROM, DVD-VIDEO, DVD-RW/-R(V mode), CD, MP3-CD, DivX and CD-R/RW, with a sophisticated FM tuner, all in a single player.

### **Full HD Audio Decoding Support (DD,DD+,DOLBY TRUE-HD,DTS,DTS-HD HRA, DTS-HD MA Essential)**

Please refer to [www.DOLBY.COM](http://www.DOLBY.COM) and [DTS.COM](http://DTS.COM) for more detail.

### **TV Screen Saver Function**

If the main unit remains in stop mode for 10 minutes, the logo appears on TV screen. The HT-BD7200 automatically switches itself into the power saving mode after 30 minutes in the Screen Saver mode.

### **Power Saving Function**

The HT-BD7200 automatically shuts itself off after 40 minutes in Stop mode.

### **USB Host support**

You can connect and play files from external USB storage devices such as MP3 players, USB flash memory, etc. using the Home Theater's USB HOST function.

### **HDMI**

HDMI transmits Blu-Ray/DVD video and audio signals simultaneously, and provides a clearer picture. The 1080p(Full HD) resolution provides even clearer pictures.

### **AV SYNC Function**

Video may lag behind the audio if the unit is connected to a digital TV. To compensate for this, you can adjust the audio delay time to sync up with the video.

### **Anynet+(HDMI-CEC) Function**

Anynet+ is a function that can be used to operate the main unit of this system using a Samsung TV remote control, by connecting the Blu-ray Home Theater to a SAMSUNG TV using an HDMI Cable. (This is only available with SAMSUNG TVs that support Anynet+.)

### **Bluetooth Function**

You can use a Bluetooth device to enjoy music with high quality stereo sound, all without wires!



### **iPod & iPhone support**

You can enjoy music files by connecting your iPod to the home theater with the supplied iPod dock.

### **BD Wise**

BD Wise automatically adjusts BD Wise-compliant Samsung products to the optimal settings between them. This feature is enabled only if BD Wise-compliant Samsung products are connected to each other using an HDMI cable.

## BLU-RAY DISC FEATURES

Blu-ray Discs support the highest quality HD video available in the industry - Large capacity means no compromise on video quality. Furthermore, a Blu-ray Disc has the same familiar size and look as a DVD.

\* The following Blu-ray Disc features are disc dependant and will vary. Appearance and navigation of features will also vary from disc to disc. Not all discs will have the features described below.

### Video highlights

The BD-ROM format for movie distribution supports three highly advanced video codecs, including AVC, VC-1, and MPEG-2.

HD video resolutions are also available:

- 1920 x 1080 HD
- 1280 x 720 HD

### For High-Definition Playback

To view high-definition contents on a Blu-ray disc, an HDTV (High Definition Television) is required. Some discs may require using the player's HDMI OUT to view high-definition content. The ability to view high-definition content on Blu-ray disc may be limited depending on the resolution of your TV.

### Subtitles

Depending on what is contained on the Blu-ray Disc, you may be able to select different font styles, sizes and colors for the subtitles. Subtitles may also be animated, scrolled or faded in and out.

### BD-LIVE

You can use a Blu-ray Disc supporting BD-LIVE through network connection to enjoy various contents provided by the disc manufacturer.

### NETFLIX

This Blu-ray Home Theater enables you to enjoy movies on-demand provided by Netflix through a network connection.

### PANDORA

This Blu-ray Home Theater enables you to enjoy Internet Radio provided by Pandora through a network connection.

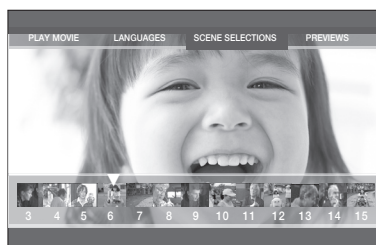

© 2005-2009 Pandora Media, Inc., All Rights Reserved Pandora and the Music Genome Project are registered trademarks of Pandora Media, Inc.

# Key features of your new Blu-ray Home Theater

## WHAT'S INCLUDED

Check for the supplied accessories below.

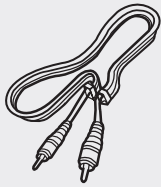

Video Cable  
(AH39-40001V)



FM Antenna  
(AH42-00017A)

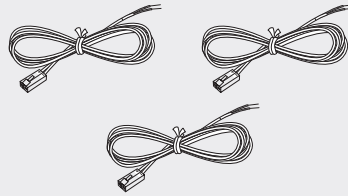

Speaker Wire (3 EA)

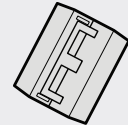

Toroidal Ferrite Core  
(3301-000144)

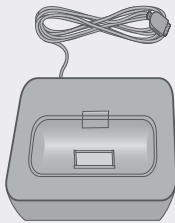

iPod Dock  
(AH96-00051A)



User's Manual  
(AH68-02196R)





Remote Control  
(AH59-02195A)  
/ Batteries (AAA size)  
(4301-000116)

# Safety information

## SAFETY WARNINGS

TO REDUCE THE RISK OF ELECTRIC SHOCK, DO NOT REMOVE THE COVER(OR BACK). NO USER-SERVICEABLE PARTS ARE INSIDE. REFER SERVICING TO QUALIFIED SERVICE PERSONNEL.

	<p style="text-align: center;"><b>CAUTION</b></p> <p style="text-align: center;">RISK OF ELECTRIC SHOCK DO NOT OPEN</p>	
<p>The lightning flash and Arrowhead within Triangle is a warning sign alerting you of dangerous voltage Inside the product</p>	<p>CAUTION: TO REDUCE THE RISK OF ELECTRIC SHOCK, DO NOT REMOVE COVER (OR BACK) NO USER SERVICEABLE PARTS INSIDE. REFER SERVICING TO QUALIFIED SERVICE PERSONNEL.</p>	<p>The explanation point within the triangle is a warning sign alerting you of important instructions accompanying the product.</p>

**CLASS 1 LASER PRODUCT**  
**KLASSE 1 LASER PRODUKT**  
**LUOKAN 1 LASER LAITE**  
**KLASS 1 LASER APPARAT**  
**PRODUCTO LASER CLASE 1**

### CLASS 1 LASER PRODUCT

This Compact Disc player is classified as a CLASS 1 LASER product. Use of controls, adjustments or performance of procedures other than those specified herein may result in hazardous radiation exposure.

#### CAUTION :

- TO REDIVISIBLE LASER RADIATION WHEN OPEN AND INTERLOCKS DEFEATED, AVOID EXPOSURE TO BEAM.
- THIS PRODUCT UTILIZES A LASER. USE OF CONTROLS OR ADJUSTMENTS OR PERFORMANCE OF PROCEDURES OTHER THAN THOSE SPECIFIED HEREIN MAY RESULT IN HAZARDOUS RADIATION EXPOSURE. DO NOT OPEN COVER AND DO NOT REPAIR YOURSELF. REFER SERVICING TO QUALIFIED PERSONNEL.

#### WARNING

- To reduce the risk of fire or electric shock, do not expose this appliance to rain or moisture.
- To prevent injury, this apparatus must be securely attached to the floor/wall in accordance with the installation instructions.

#### CAUTION

- Apparatus shall not be exposed to dripping or splashing and no objects filled with liquids, such as vases, shall be placed on the apparatus.
- The Mains plug is used as a disconnect device and shall stay readily operable at any time.

This product satisfies FCC regulations when shielded cables and connectors are used to connect the unit to other equipment. To prevent electromagnetic interference with electric appliances, such as radios and televisions, use shielded cables and connectors for connections.

#### FCC NOTE (for U.S.A):

This equipment has been tested and found to comply with the limits for a Class B digital device, pursuant to Part 15 of the FCC Rules. These limits are designed to provide reasonable protection against harmful interference in a residential installation.

This equipment generates, uses and can radiate radio frequency energy and, if not installed and used in accordance with the instructions, may cause harmful interference to radio communications. However, there is no guarantee that interference will not occur in a particular installation.

If this equipment does cause harmful interference to radio or television reception, which can be determined by turning the equipment off and on, the user is encouraged to try to correct the interference by one or more of the following measures:

- Reorient or relocate the receiving antenna.
- Increase the separation between the equipment and receiver.
- Connect the equipment into an outlet on a circuit different from that to which the receiver is connected.
- Consult the dealer or an experienced radio/TV technician for help.

Caution : FCC regulations state that any unauthorized changes or modifications to this equipment may void the user's authority to operate it.

### Important Safety Instructions

Read these operating instructions carefully before using the unit. Follow all the safety instructions listed below. Keep these operating instructions handy for future reference.

- 1) Read these instructions.
- 2) Keep these Instructions.
- 3) Heed all warnings.
- 4) Follow all instructions.
- 5) Do not use this apparatus near water.
- 6) Clean only with dry cloth.
- 7) Do not block any ventilation openings. Install in accordance with the manufacturer's instructions.
- 8) Do not install near any heat sources such as radiators, heat registers, stoves, or other apparatus (including amplifiers) that produce heat.
- 9) Do not defeat the safety purpose of the polarized or grounding-type plug. A polarized plug has two blades with one wider than the other. A grounding type plug has two blades and a third grounding prong. The wide blade or the third prong are provided for your safety. If the provided plug does not fit into your outlet, consult an electrician for replacement of the obsolete outlet.
- 10) Protect the power cord from being walked on or pinched particularly at plugs, convenience receptacles, and the point where they exit from the apparatus.
- 11) Only use attachment/accessories specified by the manufacturer.
- 12) Use only with the cart, stand, tripod, bracket, or table specified by the manufacturer, or sold with the apparatus. When a cart is used, use caution when moving the cart/apparatus combination to avoid injury from tip-over.
- 13) Unplug this apparatus during lightning storms or when unused for long periods of time.
- 14) Refer all servicing to qualified service personnel. Servicing is required when the apparatus has been damaged in any way, such as power-supply cord or plug is damaged, liquid has been spilled or objects have fallen into the apparatus, the apparatus has been exposed to rain or moisture, does not operate normally, or has been dropped.



# PRECAUTIONS

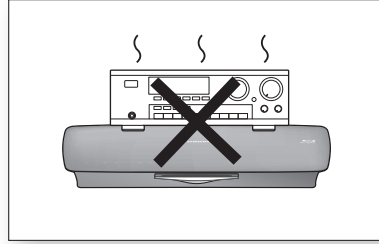
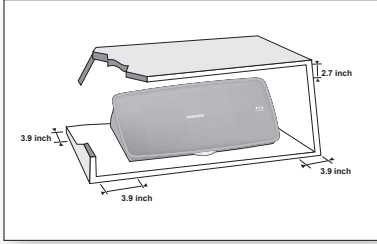

Ensure that the AC power supply in your house complies with the identification sticker located on the back of your player. Install your player horizontally, on a suitable base (furniture), with enough space around it for ventilation (3~4 inches). Make sure the ventilation slots are not covered. Do not stack anything on top of the player. Do not place the player on amplifiers or other equipment which may become hot. Before moving the player, ensure the Disc Insert slot is empty. This player is designed for continuous use. Switching off the Blu-ray Home Theater to the stand-by mode does not disconnect the electrical supply. In order to disconnect the player completely from the power supply, remove the main plug from the wall outlet, especially when left unused for a long period of time.

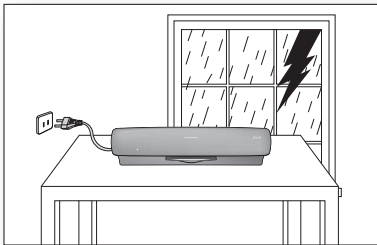

During thunderstorms, disconnect the AC main plug from the wall outlet. Voltage peaks due to lightning could damage the unit.

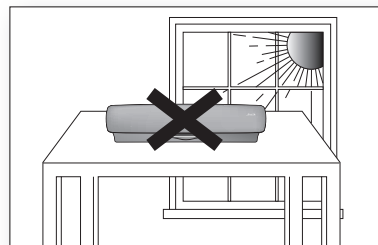

Do not expose the unit to direct sunlight or other heat sources. This could lead to overheating and malfunction of the unit.

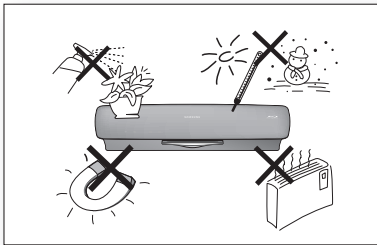

Protect the player from moisture (i.e. vases), and excess heat (e.g. fireplace) or equipment creating strong magnetic or electric fields (i.e. speakers...). Disconnect the power cable from the AC supply if the player malfunctions. Your player is not intended for industrial use. Use of this product is for personal use only.

Condensation may occur if your player or disc has been stored in cold temperatures. If transporting the player during the winter, wait approximately 2 hours until the unit has reached room temperature before using.

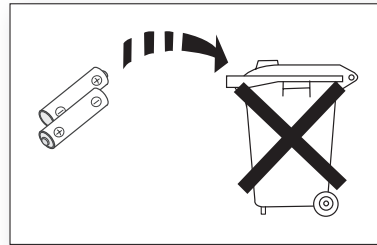

The batteries used with this product contain chemicals that are harmful to the environment. Do not dispose of batteries in the general household trash.

## This product is covered by one or more of the following U.S. patents:

5,060,220	5,457,669	5,561,649	5,705,762	6,043,912	6,438,099	6,467,061	6,556,521	6,578,163	6,697,307	6,728,474
6,771,891	6,894,963	6,895,593	6,937,815	6,996,327	7,009,926	7,085,221	7,088,649	7,092,327	7,099,566	7,123,564
7,142,493	7,142,495	7,145,861	7,146,624	7,151,729	7,161,879	7,164,647	7,167,437	7,173,891	7,177,250	7,194,187
7,203,891	7,209,423	7,210,067	7,228,062	7,245,566	7,245,567	7,257,065	7,263,045	7,269,110	7,272,086	7,272,106
7,280,460	7,283,729	7,286,454	7,304,938							

## This device is protected by U.S. Patent Nos.

6,836,549; 6,381,747; 7,050,698; 6,516,132; and 5,583,936.

## This product is covered by the following U.S. patents:

US4,930,158 US4,930,160

# Contents

## KEY FEATURES OF YOUR NEW BLU-RAY HOME THEATER

2

- 2 Player Features
- 3 Blu-ray Disc Features
- 4 What's Included

## SAFETY INFORMATION

5

- 5 Safety Warnings
- 6 Precautions

## GETTING STARTED

10

- 10 Before Reading the User's Manual
- 11 Disc Type and Characteristics

## DESCRIPTION

14

- 14 Front Panel
- 15 Rear Panel

## REMOTE CONTROL

16

- 16 Tour of the Remote Control
- 18 Setting the Remote Control

## CONNECTIONS

20

- 20 Connecting the Speakers
- 22 Connecting the Video Out to Your TV
- 24 Connecting an iPod
- 26 Connecting Audio from External Components
- 28 Connecting to the Network
- 30 Connecting the FM Antenna
- 30 Cooling Fan
- 30 Attaching the Toroidal Ferrite Core to the Power Cord of the Main Unit

## BASIC FUNCTIONS OF YOUR BLU-RAY HOME THEATER

31

- 31 Before Playing
- 32 On-Screen Menu Navigation
- 32 Playing a Disc
- 33 Setting the Sound
- 33 Using the Search and Skip Functions
- 34 Slow Motion Play/Step Motion Play

## SYSTEM SETUP

35

- 35 Setting the Clock

## LANGUAGE SETUP

36

- 36 Setting up the Language Options

# Contents

---

<b>AUDIO SETUP</b>	37	Setting up the Speaker Options
37		
<b>DISPLAY SETUP</b>	40	Setting up the Display Options
40		
42		Setting up the Video Display/Output Options
<b>HDMI SETUP</b>	44	Setting up the HDMI Setup Options
44		
<b>PARENTAL SETUP</b>	47	Setting up the Parental Lock
47		
<b>NETWORK SETUP</b>	49	Setting up the Network Setup Options
49		
<b>BD DATA MANAGEMENT</b>	54	System Device Management
54		
<b>SYSTEM UPGRADE</b>	55	Firmware Upgrade
55		57 System Information
		57 Firmware Upgrade Notification
		57 DivX (R) Registration
<b>WATCHING A MOVIE</b>	58	Using the Display Function
58		59 Using the Disc Menu & Popup/Title Menu
		60 Repeat Play
		61 Selecting the Audio Language
		61 Selecting the Subtitle Language
		62 Changing the Camera Angle
		63 PIP (Picture In Picture) Settings
		63 BD-LIVE™
		64 Using the Instant Streaming Feature Provided by Netflix
		66 DivX Playback



**LISTENING TO MUSIC**

68

- 68 Buttons on the Remote Control Used for Audio CD(CD-DA)/ MP3 Disc Playback
- 68 Repeat Audio CD(CD-DA) & MP3
- 69 Playing an Audio CD(CD-DA)/MP3
- 71 Using the Internet Radio Feature Provided by Pandora

**VIEWING A PICTURE**

73

- 73 Viewing a Picture
- 73 Slide Show/Speed
- 73 Rotate
- 74 Zoom
- 74 Go To Photo List

**USING THE USB FUNCTION**

75

- 75 Playing Media Files Using the USB Host Feature

**RADIO**

77

- 77 Listening to Radio
- 77 Presetting Stations

**USING BLUETOOTH**

78

- 78 What is Bluetooth?
- 78 To connect the Blu-ray Home Theater to a Bluetooth device

**USING AN iPod**

80

- 80 Listening to Music
- 82 Watching a Movie

**CONVENIENT FUNCTION**

83

- 83 Sleep Timer Function
- 83 Adjusting Display Brightness
- 83 Mute Function

**TROUBLESHOOTING**

84

**APPENDIX**

86













- 86 Cautions on Handling and Storing Discs
- 87 Specifications

# Getting started

## BEFORE READING THE USER'S MANUAL

Make sure to check the following terms before reading the user manual.

### Icons that will be used in manual

Icon	Term	Definition
	BD-ROM	This involves a function available on a BD-ROM.
	BD-RE	This involves a function available on the BD-RE.
	BD-R	This involves a function available on the BD-R.
	DVD-VIDEO	This involves a function available on DVD-Video or DVD-RW/-R discs that have been recorded and finalized in Video Mode.
	DVD-RW	This involves a function available on DVD-RW. (V mode and finalized only)
	DVD-R	This involves a function available on DVD-R. (V mode and finalized only)
	Audio CD	This involves a function available on an audio CD-RW/CD-R (CD-DA format).
	MP3	This involves a function available on DVD-RW/-R, CD-RW/CD-R discs and USB storage devices.
	JPEG	This involves a function available on DVD-RW/-R, CD-RW/CD-R discs and USB storage devices.
	DivX	This involves a function available with MPEG4 discs. (DVD-R/RW, CD-R/RW)
	USB storage device	This involves a function available on USB storage device.
	Caution	This involves a case where a function does not operate or settings may be cancelled.
	Note	This involves tips or instructions on the page that help each function operate.

### About the use of this user's manual

- 1) Be sure to be familiar with Safety Information before using this product. (See pages 5~6)
- 2) If a problem occurs, check the Troubleshooting. (See pages 84 ~85)







### Copyright

©2009 Samsung Electronics Co.,Ltd.

All rights reserved; No part or whole of this user's manual may be reproduced or copied without the prior written permission of Samsung Electronics Co.,Ltd.











## DISC TYPE AND CHARACTERISTICS

### Disc types that can be played

Disc Types	Disc Logo	Recorded content	Disc Shape	Max. Playing minute
BD-ROM BD-RE/BD-R		AUDIO + VIDEO	Single sided	Playing time depends on the Title
DVD-VIDEO		AUDIO + VIDEO	Single sided(5 inches)	240
			Double sided(5 inches)	480
			Single sided(3 1/2 inches)	80
			Double sided(3 1/2 inches)	160
AUDIO-CD		AUDIO	Single sided(5 inches)	74
			Single sided(3 1/2 inches)	20
DivX		AUDIO + VIDEO	12 cm	—
			8 cm	—
DVD-RW (V mode and finalized only)		AUDIO + VIDEO	5 inches (4.7GB)	480 (EX : Extended Play)
DVD-R (V mode and finalized only)		AUDIO + VIDEO	5 inches (4.7GB)	480 (EX : Extended Play)

- This player is compatible with the NTSC color system only.
- PAL discs will not play.

### Logos of Discs that can be played

				
Blu-ray Disc	Dolby Digital Plus	DTS-HD High Resolution Audio		
				
NTSC broadcast system in U.S.A, Canada, Korea, Japan	Dolby TrueHD	DTS-HD Master Audio   Essential		
				
Digital Audio	MP3	Stereo	Java	BD-LIVE

- 
 Manufactured under license from Dolby Laboratories. "Dolby" and the double-D symbol are trademarks of Dolby Laboratories.
- Manufactured under license under U.S. Patent #'s: 5,451,942; 5,956,674; 5,974,380; 5,978,762; 6,226,616; 6,487,535; 7,392,195; 7,272,567; 7,333,929; 7,212,872 & other U.S. and worldwide patents issued & pending. DTS is a registered trademark and the DTS logos, Symbol, DTS-HD and DTS-HD Master Audio | Essential are trademarks of DTS, Inc. © 1996-2008 DTS, Inc. All Rights Reserved.

# Getting started

## Discs that cannot be played

- HD DVD Disc
- DVD-RAM
- 3.9 GB DVD-R Disc for Authoring.
- DVD-RW(VR mode)
- DVD-ROM/PD/MV-Disc, etc
- CVD/CD-ROM/CDV/CD-G/CD-I/LD
- 3 1/2 inch MD (mini disc)



- Some commercial discs and DVD discs purchased outside your region may not be playable with this product. When these discs are played, either “No disc.” or “Please check the regional code of the disc.” will be displayed.
- If a DVD-R/-RW disc has not been recorded properly in DVD video format, it will not be playable.

## Region code

Both the Blu-ray Home Theater and the discs are coded by region. These regional codes must match in order to play the disc. If the codes do not match, the disc will not play. The Region Number for this Blu-ray Home Theater is described on the rear panel of the Blu-ray Home Theater.

BD Region Code	Area
A	North America, Central America, South America, Korea, Japan, Taiwan, Hong Kong and South East Asia.
B	Europe, Greenland, French territories, Middle East, Africa, Australia and New Zealand.
C	India, China, Russia, Central and South Asia.

DVD-Video Region Code	Area	DVD-Video Region Code	Area
1	USA, Canada	6	China
2	Japan, Europe, South Africa, Middle East, Greenland	7	Unspecified Special Use
3	Korea, Taiwan, Hong Kong, parts of South East Asia	8	Airlines/Cruise Ships (including Mexico)
4	Australia, New Zealand, Latin America (including Mexico)	9	Region free
5	Eastern Europe, Russia, India, Africa		

## Blu-ray Disc Compatibility

Blu-ray Disc is a new and evolving format. Accordingly, disc compatibility issues are possible. Not all discs are compatible and not every disc will play back. For additional information, refer to the Compliance and Compatibility Notice section of this Manual. If you encounter compatibility problems, please contact the SAMSUNG customer care center at 1-800 SAMSUNG.



- Playback may not work for some types of discs, or when specific operations, such as angle change and aspect ratio adjustment, are being performed. Information about the discs is written in detail on the box. Please refer to this if necessary.
- Do not allow the disc to become dirty or scratched. Fingerprints, dirt, dust, scratches or deposits of cigarette smoke on the recording surface may make it impossible to use the disc for playback.
- Discs with PAL programs recorded on them cannot be played using this product.
- When a BD-Java title is played, loading may take longer than a normal title, or some functions may perform slowly.

## Disc Types

---

### ❖ BD-RE/BD-R

Blu-ray Disc Rewritable/Blu-ray Disc Recordable. BD-RE/BD-R is the ideal format for making backups, or recording personal video.

### ❖ BD-ROM

Blu-ray Disc Read Only Memory. A BD-ROM disc contains pre-recorded data. Although a BD-ROM may contain any form of data, most BD-ROM discs will contain movies in High Definition format, for playback on Blu-ray Home Theaters. This unit can play back pre-recorded commercial BD-ROM discs.

### ❖ DVD-Video

- A digital versatile disc (DVD) can contain up to 135-minutes of images, 8 audio languages and 32 subtitle languages. It is equipped with MPEG-2 picture compression and Dolby Digital surround, allowing you to enjoy vivid and clear theatre quality images.
- When switching from the first layer to the second layer of a dual-layered DVD Video disc, there may be momentary distortion in the image and sound. This is not a malfunction of the unit.
- Once a DVD-RW/-R recorded in Video Mode is finalized, it becomes DVD-Video. Pre-recorded (pre-stamped) commercial DVDs with movies are also referred to as DVD-Videos. This unit can play back pre-recorded commercial DVD discs (DVD-Video discs) with movies.

### ❖ Audio CD

- An audio disc on which 44.1kHz PCM Audio is recorded.
- This unit can play back CD-DA format audio CD-R and CD-RW discs.
- The unit may not be able to play some CD-R or CD-RW discs due to the condition of the recording.

### ❖ CD-R/-RW

- Use a 700MB(80 minutes) CD-R/-RW disc. If possible, do not use a 800MB(90 minutes) or above disc, as the disc may not play back.
- If the CD-R/-RW disc was not recorded as a closed session, you may experience delays when playing back the beginning of the disc or all recorded files may not play.
- Some CD-R/-RW discs may not be playable with this unit, depending on the device which was used to burn them. For contents recorded on CD-R/-RW media from CDs for your personal use, playability may vary depending on contents and discs.

### ❖ DVD-R Disc Playback

- Once a DVD-R recorded in Video Mode is finalized, it becomes DVD-Video.
- This unit can play back DVD-R discs recorded and finalized with a Samsung DVD video recorder. It may not be able to play some DVD-R discs depending on the disc and the condition of the recording.

### ❖ DVD-RW Disc Playback

- Playback can be performed with DVD-RW discs in the Video Mode and finalized only.
- Once a DVD-RW recorded in Video Mode is finalized, it becomes DVD-Video. Ability to play back may depend on recording conditions.

## Disc Format

---

### ❖ Using MP3 disc

- CD-R/-RW, DVD-RW/-R recorded with UDF, ISO9660 or JOLIET format can be played back.
- Only MP3 files with the ".mp3" or ".MP3" extension can be played.
- Playable bit-rate range is from 56 Kbps to 320 Kbps.
- Playable sample-rate is 32KHz to 48KHz.
- The unit can handle a maximum of 1500 files and folders under a parent folder. For MP3 files recorded with a VBR(Variable Bit Rates), the sound may cut in and out.

### ❖ Using JPEG disc

- CD-R/-RW, DVD-RW/-R recorded with UDF, ISO9660 or JOLIET format can be played back.
- Only JPEG files with the ".jpg", ".JPG", ".jpeg" or ".JPEG" extension can be displayed.
- Progressive JPEG is supported.

### ❖ DVD-RW/-R (V)

- This is a format that is used for recording data on a DVD-RW or DVD-R disc. The disc can be played by this Blu-ray Home Theater once it has been finalized.
- If a disc that has been recorded in Video Mode by a different maker's recorder but has not been finalized, it cannot be played by this Blu-ray Home Theater.

# Description

## FRONT PANEL

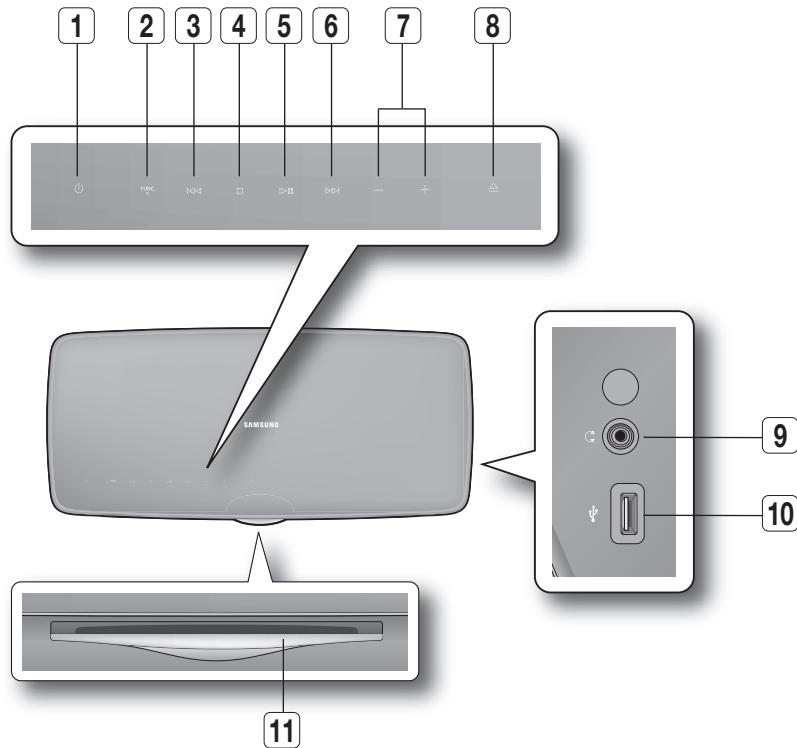

<b>1</b>	<b>POWER BUTTON</b>	Turns the Blu-ray Home Theater on and off.
<b>2</b>	<b>FUNCTION BUTTON</b>	The mode switches as follows : BD/DVD → D.IN → AUX → BT AUDIO → FM.
<b>3</b>	<b>TUNING DOWN &amp; SKIP (◀◀) BUTTON</b>	Goes back to the previous title/chapter/track. Tunes down the FM frequency band.
<b>4</b>	<b>STOP BUTTON</b>	Stops disc playback.
<b>5</b>	<b>PLAY/PAUSE BUTTON</b>	Plays a disc or pauses playback.
<b>6</b>	<b>TUNING UP &amp; SKIP (▶▶) BUTTON</b>	Goes to the next title/chapter/track. Tunes up the FM frequency band.
<b>7</b>	<b>Volume Control BUTTON</b>	Volume adjustment.
<b>8</b>	<b>EJECT BUTTON</b>	Eject a disc.
<b>9</b>	<b>HEADPHONE JACK</b>	Connect a headphone.
<b>10</b>	<b>USB HOST</b>	A USB storage device can be connected here and used as storage when connected to BD-LIVE. It can also be used for firmware upgrades and MP3/JPEG playback.
<b>11</b>	<b>DISC SLOT</b>	Accept a disc.



■ You must use the USB HOST on the rear panel of the Blu-ray Home Theater to connect a wireless LAN Adapter.

# REAR PANEL

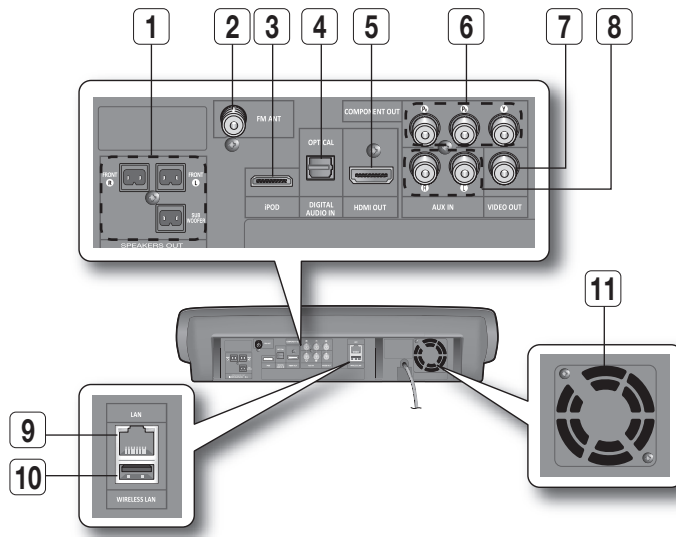

<b>1</b>	<b>2.1 CHANNEL SPEAKER OUTPUT CONNECTORS</b>	Connect the front, subwoofer speakers.
<b>2</b>	<b>FM 75Ω COAXIAL JACK</b>	Connect the FM antenna.
<b>3</b>	<b>iPod JACK</b>	Connect the iPod dock connector here.
<b>4</b>	<b>EXTERNAL DIGITAL OPTICAL INPUT JACK</b>	Use this to connect external equipment capable of digital output.
<b>5</b>	<b>HDMI OUT JACK</b>	Use the HDMI cable, connect this HDMI output terminal to the HDMI input terminal on your TV for the best quality picture.
<b>6</b>	<b>COMPONENT VIDEO OUTPUT JACKS</b>	Connect a TV with Component video inputs to these jacks.
<b>7</b>	<b>VIDEO OUTPUT JACK</b>	Connect your TV's Video Input jack (VIDEO IN) to the VIDEO OUT Jack on this unit.
<b>8</b>	<b>AUX IN JACKS</b>	Connect to the 2CH analog output of an external device (such as a VCR)
<b>9</b>	<b>LAN TERMINAL</b>	Can be used for connection to BD-LIVE, Netflix and Pandora. It can be also used for firmware upgrades.
<b>10</b>	<b>WIRELESS LAN JACK</b>	A USB storage device can be connected here and used as storage when connected to BD-LIVE. It can also be used for firmware upgrades and MP3/JPEG playback, as well as for connecting to BD-Live with a wireless LAN adapter.
<b>11</b>	<b>COOLING FAN</b>	The fan always revolves when the power is on. Ensure a minimum of 4 inches of clear space on all sides of the fan when installing the product.







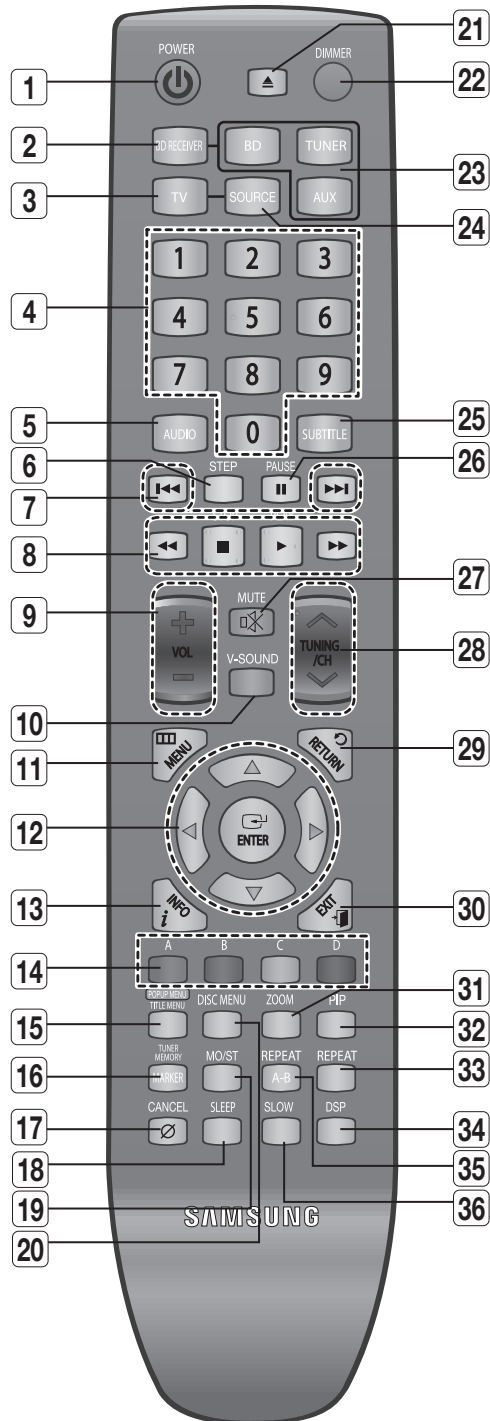

■ Oversized USB drives may not be able to be inserted when a LAN or HDMI cable is connected.

# Remote control

## TOUR OF THE REMOTE CONTROL





<b>1</b>	POWER button	<b>19</b>	MO/ST button
<b>2</b>	BD RECEIVER button	<b>20</b>	DISC MENU button
<b>3</b>	TV button	<b>21</b>	EJECT button
<b>4</b>	Number (0~9) buttons	<b>22</b>	DIMMER button
<b>5</b>	AUDIO button	 BD button	
<b>6</b>	STEP button	<b>23</b>	 TUNER button
<b>7</b>	Tuning Preset/CD Skip buttons	 AUX button	
<b>8</b>	 PLAY button  STOP button  SEARCH buttons	<b>24</b>	SOURCE button
<b>9</b>	VOLUME button	<b>25</b>	SUBTITLE button
<b>10</b>	V-SOUND button	<b>26</b>	PAUSE button
<b>11</b>	MENU button	<b>27</b>	MUTE button
<b>12</b>	Cursor/ENTER button	<b>28</b>	TUNING/CH button
<b>13</b>	INFO button	<b>29</b>	RETURN button
<b>14</b>	COLOR Buttons : RED(A), GREEN (B), YELLOW(C), BLUE(D)	<b>30</b>	EXIT button
<b>15</b>	POPUP MENU, TITLE MENU button	<b>31</b>	ZOOM button
<b>16</b>	TUNER MEMORY, MARKER button	<b>32</b>	PIP button
<b>17</b>	CANCEL button	<b>33</b>	REPEAT button
<b>18</b>	SLEEP button	<b>34</b>	DSP button
		<b>35</b>	REPEAT A-B button
		<b>36</b>	SLOW button

### Installing batteries in the Remote Control

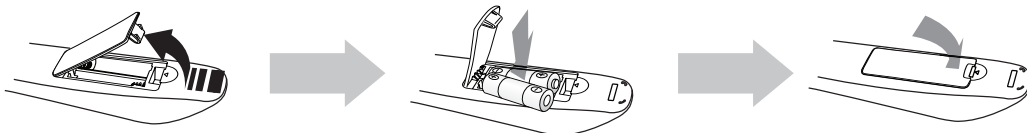

**1. Lift the cover at the back of the remote control upward as shown.**

**2. Install two AAA size batteries.**  
Make sure to match the "+" and "-" ends of the batteries with the diagram inside the compartment.

**3. Replace the cover.**  
Assuming typical TV usage, the batteries last for about one year.

# Remote control

## SETTING THE REMOTE CONTROL

You can control certain functions of your TV with this remote control.

### When operating a TV with the remote control

1. Press the **TV** button to set the remote to TV mode.
2. Press the **POWER** button to turn on the TV.
3. While holding down the **POWER** button, enter the code corresponding to your brand of TV.
  - If there is more than one code listed for your TV in the able, enter one at a time to determine which code works.

#### Example : For a Samsung TV

While holding down the **POWER** button, use the **number** buttons to enter 00, 15, 16, 17 and 40.

4. If the TV turns off, the setting is complete.
  - You can use the TV **POWER**, **VOLUME**, **CHANNEL**, and **Numeric** buttons (0-9).

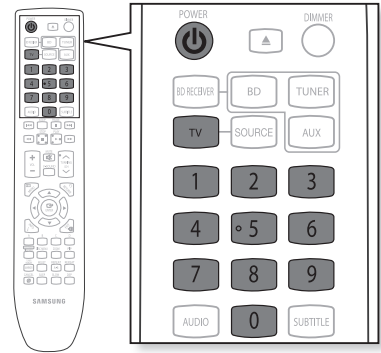

- The remote control may not work on some brands of TVs. Also, some operations may not be possible depending on your brand of TV.
- If you do not set the remote control with the code for your brand of TV, the remote control will work on a Samsung TV by default.

## Operation Range of the Remote Control

The remote control can be used up to approximately 23 feet (7 meters) in a straight line. It can also be operated at a horizontal angle of up to 30° from the remote control sensor.



## TV Brand Code List

No.	Brand	Code	No.	Brand	Code
1	Admiral (M.Wards)	56, 57, 58	44	MTC	18
2	A Mark	01, 15	45	NEC	18, 19, 20, 40, 59, 60
3	Anam	01, 02, 03, 04, 05, 06, 07, 08, 09, 10, 11, 12, 13, 14	46	Nikei	03
			47	Onking	03
4	AOC	01, 18, 40, 48	48	Onwa	03
5	Bell & Howell (M.Wards)	57, 58, 81	49	Panasonic	06, 07, 08, 09, 54, 66, 67, 73, 74
6	Brocsonic	59, 60	50	Penney	18
7	Candle	18	51	Philco	03, 15, 17, 18, 48, 54, 59, 62, 69, 90
8	Cetronic	03	52	Philips	15, 17, 18, 40, 48, 54, 62, 72
9	Citizen	03, 18, 25	53	Pioneer	63, 66, 80, 91
10	Cinema	97	54	Portland	15, 18, 59
11	Classic	03	55	Proton	40
12	Concerto	18	56	Quasar	06, 66, 67
13	Contec	46	57	Radio Shack	17, 48, 56, 60, 61, 75
14	Coronado	15	58	RCA/Proscan	18, 59, 67, 76, 77, 78, 92, 93, 94
15	Craig	03, 05, 61, 82, 83, 84	59	Realistic	03, 19
16	Croslex	62	60	Sampo	40
17	Crown	03	61	Samsung	00, 15, 16, 17, 40, 43, 46, 47, 48, 49, 59, 60, 98
18	Curtis Mates	59, 61, 63			
19	CXC	03	62	Sanyo	19, 61, 65
20	Daewoo	02, 03, 04, 15, 16, 17, 18, 19, 20, 21, 22, 23, 24, 25, 26, 27, 28, 29, 30, 32, 34, 35, 36, 48, 59, 90	63	Scott	03, 40, 60, 61
			64	Sears	15, 18, 19
21	Daytron	40	65	Sharp	15, 57, 64
22	Dynasty	03	66	Signature 2000 (M.Wards)	57, 58
23	Emerson	03, 15, 40, 46, 59, 61, 64, 82, 83, 84, 85	67	Sony	50, 51, 52, 53, 55
24	Fisher	19, 65	68	Soundesign	03, 40
25	Funai	03	69	Spectricon	01
26	Futuretech	03	70	SSS	18
27	General Electric (GE)	06, 40, 56, 59, 66, 67, 68	71	Sylvania	18, 40, 48, 54, 59, 60, 62
28	Hall Mark	40	72	Symphonic	61, 95, 96
29	Hitachi	15, 18, 50, 59, 69	73	Tatung	06
30	Inkel	45	74	Techwood	18
31	JC Penny	56, 59, 67, 86	75	Teknika	03, 15, 18, 25
32	JVC	70	76	TMK	18, 40
33	KTV	59, 61, 87, 88	77	Toshiba	19, 57, 63, 71
34	KEC	03, 15, 40	78	Vidtech	18
35	KMC	15	79	Videch	59, 60, 69
36	LG (Goldstar)	01, 15, 16, 17, 37, 38, 39, 40, 41, 42, 43, 44	80	Wards	15, 17, 18, 40, 48, 54, 60, 64
37	Luxman	18	81	Yamaha	18
38	LXI (Sears)	19, 54, 56, 59, 60, 62, 63, 65, 71	82	York	40
39	Magnavox	15, 17, 18, 48, 54, 59, 60, 62, 72, 89	83	Yupiteru	03
40	Marantz	40, 54	84	Zenith	58, 79
41	Matsui	54	85	Zonda	01
42	MGA	18, 40	86	Dongyang	03, 54
43	Mitsubishi/MGA	18, 40, 59, 60, 75			

# Connections

This section involves various methods of connecting the Blu-ray Home Theater to other external components. Before moving or installing the product, be sure to turn off the power and disconnect the power cord.

## CONNECTING THE SPEAKERS

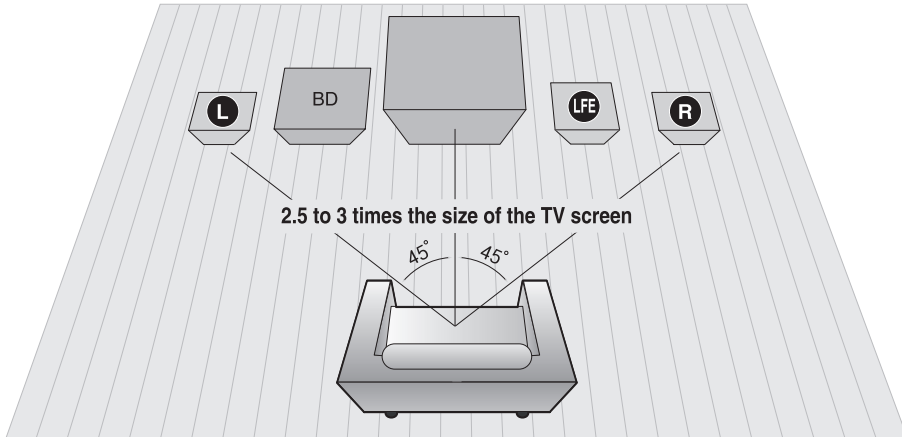

### Position of the Blu-ray Home Theater

Place it on a stand or cabinet shelf, or under the TV stand.

### Selecting the Listening Position

The listening position should be located about 2.5 to 3 times the distance of the TV's screen size away from the TV.

Example : For 32" TVs 6~8feet (2~2.4m)

For 55" TVs 11~13feet (3.5~4m)

### Front Speakers **L** **R**

Place these speakers in front of your listening position, facing inwards (about 45°) toward you.

Place the speakers so that their tweeters will be at the same height as your ear.

### Subwoofer **LFE**

The position of the subwoofer is not so critical. Place it anywhere you like.

## Connecting The Speakers

1. Press down the terminal tab on the back of the speaker.
2. Insert the black wire into the black terminal (-) and the red wire into the red (+) terminal, and then release the tab.
3. Connect the connecting plugs to the back of the Blu-ray Home Theater by matching the colors of the speaker plugs to the speaker jacks.

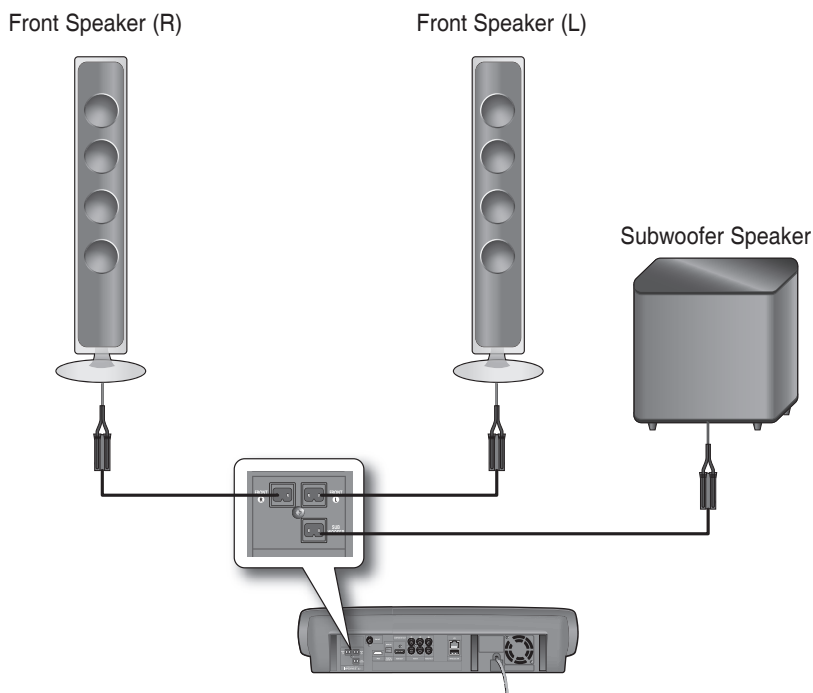
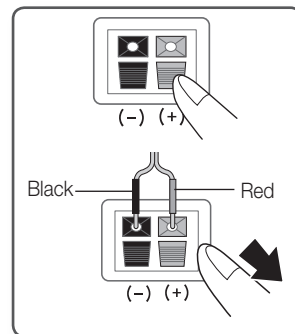

- !
  - Do not let children play with or near the speakers. They could get hurt if a speaker falls.
  - When connecting the speaker wires to the speakers, make sure that the polarity (+/-) is correct.
  - Keep the subwoofer speaker out of reach of children so as to prevent children from inserting their hands or alien substances into the duct (hole) of the subwoofer speaker.
  - Do not hang the subwoofer on the wall through the duct (hole).
- ✍
  - If you place a speaker near your TV set, screen color may be distorted because of the magnetic field generated by the speaker. If this occurs, place the speaker away from your TV set.

# Connections

## CONNECTING THE VIDEO OUT TO YOUR TV

Choose one of the three methods for connecting to a TV.

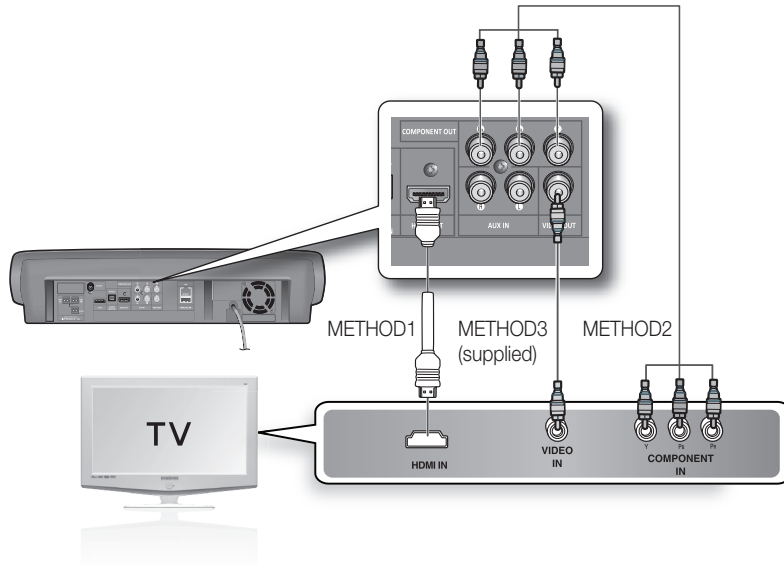

### METHOD 1 : HDMI (BEST)

Connect the HDMI cable (not supplied) from the HDMI OUT jack on the back of the Blu-ray Home Theater to the HDMI IN jack on your TV.



- Depending on your TV, certain HDMI output resolutions may not work.
- If an HDMI cable is connected from the player to a TV, the Blu-ray Home Theater's output is set to HDMI automatically within 10 seconds.
- If you are using the Anynet+ feature (see page 44) and Component and HDMI are both connected, HDMI mode is automatically selected.
- When you connect the player to the TV using the HDMI cable for the first time or to a new TV, the HDMI output resolution will automatically be set to the highest provided by the TV.
- If you connect a Samsung TV to the Blu-ray Home Theater using an HDMI cable, the player can be easily operated using the TV remote control. (This is only available with Samsung TVs that support the Anynet+ feature.) (See page 44)
- After making the video connection, set the Video input source on your TV to match the corresponding Video output (HDMI, Component or Composite) on your Blu-ray Home Theater. See your TV owner's manual for more information on how to select the TV's Video Input source.

### HDMI Auto Detection Function

The player's video output will automatically change to HDMI mode when connecting an HDMI cable while power is on. For possible HDMI resolutions, see page 41.

#### • HDMI (High Definition Multimedia Interface)

HDMI is an interface that enables the digital transmission of video and audio data with just a single connector.

Using HDMI, the Blu-ray Home Theater transmits a digital video and audio signal and displays a vivid picture on a TV having an HDMI input jack.

- **HDMI connection description**

HDMI connector - Supports video and digital audio data.

- HDMI outputs only a pure digital signal to the TV.

- If your TV does not support HDCP (High-bandwidth Digital Content Protection), random noise appears on the screen.

- **Why does Samsung use HDMI?**

Analog TVs require an analog video/audio signal. However, when playing a BD/DVD, the data transmitted to a TV is digital. Therefore either a digital-to-analog converter (in the Blu-ray Home Theater) or an analog-to-digital converter (in the TV) is required. During this conversion, the picture quality is degraded due to noise and signal loss. HDMI technology is superior because it requires no D/A conversion and is a pure digital signal from the player to your TV.

- **What is the HDCP?**

HDCP (High-band width Digital Content Protection) is a system for protecting BD/DVD content outputted via HDMI from being copied. It provides a secure digital link between a video source (PC, DVD, etc) and a display device (TV, projector, etc). Content is encrypted at the source device to prevent unauthorized copies from being made.

- **What is Anynet+?**

Anynet+ is a convenient function that offers linked operation of this unit through Samsung TVs with the Anynet+ feature.

- If your Samsung TV has an **Anynet+** logo, then it supports the Anynet+ function.

- If you turn on the player and insert a disc, the player will start playing the disc, and the TV will turn on automatically and switch to HDMI mode.

- If you turn on the player and press the **PLAY** button with a disc already inserted, the TV will immediately turn on and switch to HDMI mode.

- **What is BD Wise?**

BD Wise is Samsung's latest inter-connectivity feature.

- When you connect Samsung products with BD-Wise to each other via HDMI, the optimum resolution will be set automatically.

## METHOD 2 : Component Video (BETTER)

If your television is equipped with Component Video inputs, connect a Component video cable (not supplied) from the Component Video Output (Pr, Pb and Y) Jacks on the back of the Blu-ray Home Theater to the Component Video Input Jacks on your TV.



- You can select from a variety of resolution settings such as 1080i, 720p, 480p and 480i, depending on the disc type. (See page 42)
- The actual resolution may differ from the setting in the SETUP menu if both Component and HDMI cables are connected. The resolution may also be different depending on the disc. (See page 42)
- After making the video connection, set the Video input source on your TV to match the corresponding Video output (HDMI, Component or Composite) on your Blu-ray Home Theater. See your TV owner's manual for more information on how to select the TV's Video Input source.
- In DVD playback, if both HDMI and Component jacks are connected and you select the Component 1080p, 1080i or 720p mode, the Display Setup menu will show the output resolution as 1080p, 1080i or 720p in the menu. The resolution is actually 480i.

## METHOD 3 : Composite Video (GOOD)

Connect the supplied Video cable from the VIDEO OUT jack on the back of the Blu-ray Home Theater to the VIDEO IN jack on your TV.



- The VIDEO source is always output in 480i resolution regardless of the resolution set in the SETUP menu. (See page 42)
- After making the video connection, set the Video input source on your TV to match the corresponding Video output (HDMI, Component or Composite) on your Blu-ray Home Theater. See your TV owner's manual for more information on how to select the TV's Video Input source.
- Do not connect the unit through a VCR. Video signals fed through VCRs may be affected by copyright protection systems and the picture will be distorted on the television.

# Connections

---

## CONNECTING AN iPod

---

You can enjoy music, video files from an iPod through the main unit. For iPod operation with this Blu-ray home theater, see pages 25 and 80 ~ 82.

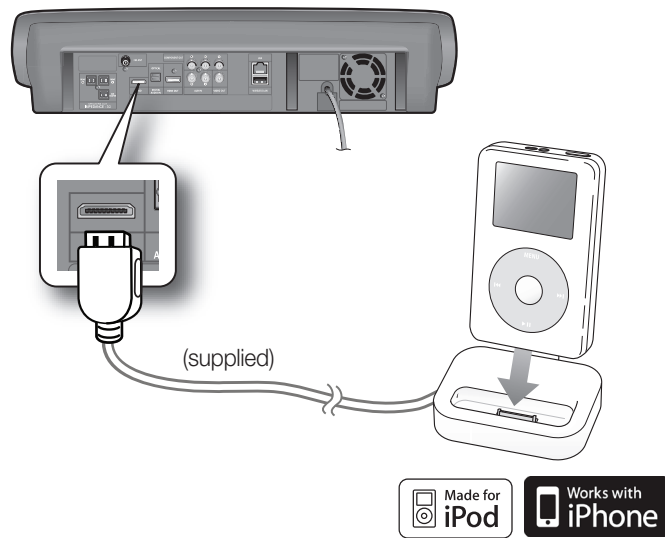















1. Connect the iPod Dock to the iPod Jack on the rear side of the main unit.
2. Place the iPod in the dock.
  - "iPod Connected" message appears on the TV screen.



- You must have the VIDEO output connected to your TV to view iPod video (See page 25).
- As the cable ports are close together, be sure to remove the USB memory drive before disconnecting the ipod docking cable.
- Adjust the volume to a moderate level before you connect your iPod and Blu-ray home theater.
- When the unit is powered on and you connect an iPod, the unit will charge your iPod's battery.
- Make sure to connect the dock connector so that the label "**SAMSUNG**" faces upward.
- "Made for iPod" means that an electronic accessory has been designed to connect specifically to iPod and has been certified by the developer to meet Apple performance standards.



## iPod models that can be used with the HT-BD7200

 <b>iPod 1st+2nd generation</b> 5GB 10GB 20GB	 <b>iPod 5th generation (video)</b> 30GB 60GB 80GB	 <b>iPod 3rd generation</b> 10GB 15GB 20GB 30GB 40GB
 <b>iPod nano 2nd generation (aluminum)</b> 2GB 4GB 8GB	 <b>iPod mini</b> 4GB 6GB	 <b>iPod 4th generation</b> 20GB 40GB
 <b>iPod nano 3rd generation (video)</b> 4GB 8GB	 <b>iPod 4th generation (color display)</b> 20GB 30GB 40GB 60GB	 <b>iPod classic</b> 80GB 120GB 160GB
 <b>iPod touch 1st generation</b> 4GB 16GB 32GB	 <b>iPod nano 4th generation (video)</b> 8GB 16GB	 <b>iPod nano 1st generation</b> 1GB 2GB 4GB
 <b>iPod touch 2nd generation</b> 8GB 16GB 32GB	 <b>iPhone</b> 4GB 8GB 16GB	 <b>iPhone 3G</b> 8GB 16GB



- “Made for iPod” means that an electronic accessory has been designed to connect specifically to iPod and has been certified by the developer to meet Apple performance standards.
- “Works with iPhone” means that an electronic accessory has been designed to connect specifically to an iPhone and has been certified by the developer to meet Apple performance standards.
- Apple is not responsible for the operation of this device or its compliance with safety and regulatory standards.

**iPod is a trademark of Apple Inc., registered in the U.S. and other countries. iPhone is a trademark of Apple Inc.**

# Connections

## CONNECTING AUDIO FROM EXTERNAL COMPONENTS

### OPTICAL : Connecting an External Digital Component

Digital signal components such as a Cable Box/Satellite receiver (Set-Top Box).

1. Connect the Digital Input (OPTICAL) on the main unit to the Digital Output of the external digital component.
2. Press the **FUNCTION** button on the main unit to select **D.IN** input.
  - The mode switches as follows : **BD/DVD** → **D.IN** → **AUX** → **BT AUDIO** → **FM**.

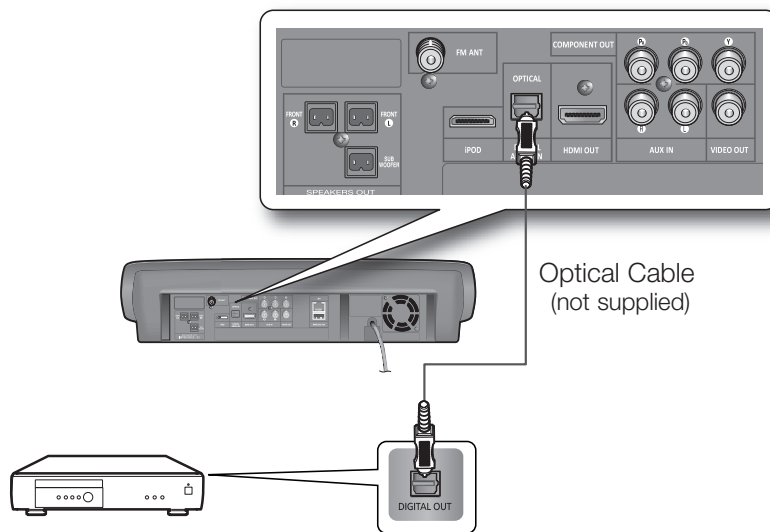

- To see video from your Cable Box/Satellite receiver, you must connect it's video output to a TV.
- This system supports Digital sampling frequencies of 32 kHz or higher from external digital components.
- This system supports only DTS and Dolby digital audio, MPEG audio which is bitstream cannot be supported.

## AUX : Connecting an External Analog Component

Analog signal components such as a VCR.

1. Connect AUX IN (Audio) on the main unit to the Audio Out of the external analog component.
  - Be sure to match connector colors.
2. Press the **AUX** button on the remote control to select **AUX** input.
  - You can also use the **FUNCTION** button on the main unit.  
The mode switches as follows : **BD/DVD** → **D.IN** → **AUX** → **BT AUDIO** → **FM**.

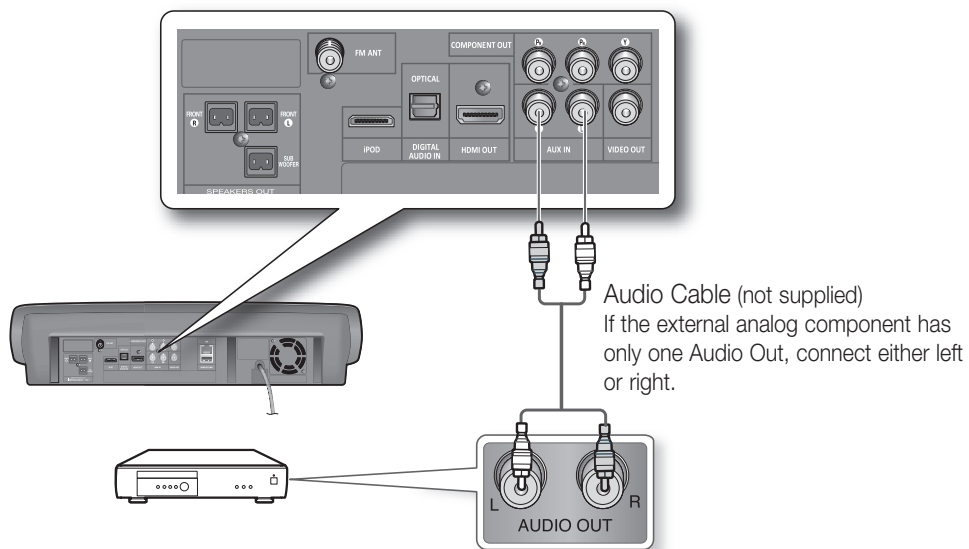

-  You can connect the Video Output jack of your VCR to the TV, and connect the Audio Output jacks of the VCR to this product.

# Connections

## CONNECTING TO THE NETWORK

To access network service or upgrade the current firmware, you must make one of the following connections.

By connecting to a network, you can access the BD-LIVE, Netflix, Pandora services and software upgrades from Samsung's update server.

### Case 1 : Connecting a Direct LAN Cable to your Modem

1. Using the Direct LAN Cable (UTP cable, not supplied), connect the LAN terminal of the Blu-ray Disc Player to the LAN terminal of your modem.

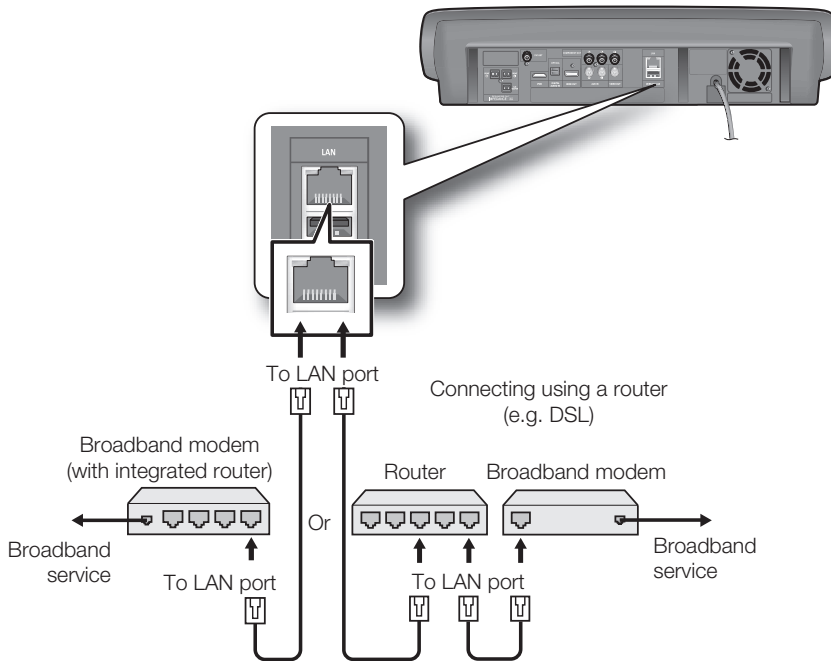

- Internet access to Samsung's update server may not be allowed, depending on the router you use or the ISP's policy. For more information, contact your ISP (Internet Service Provider).
- For DSL users, please use a router to make a network connection.

## Case 2 : Connecting to a Wireless IP sharer

You can connect to network with a Wireless IP sharer. See page 50 for Wireless Network Setup.

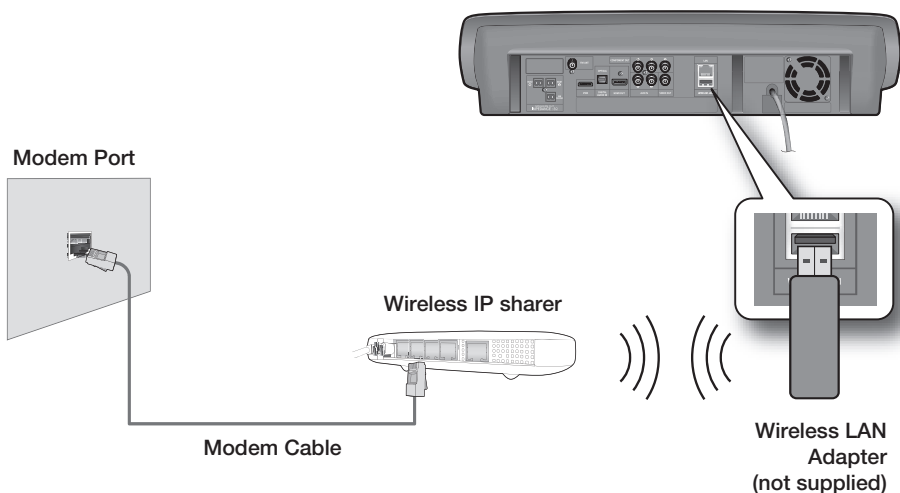

- ✎
  - This unit is compatible with only Samsung Wireless LAN Adapter. (not supplied) (Model name: WIS09ABGN).
    - The Samsung Wireless LAN Adapter is sold separately.
    - Contact a Samsung Electronics agent or service center for purchasing.
  - You must use a wireless IP sharer that supports IEEE 802.11 a/b/g/n. (n is recommended for stable operation of the wireless network.)
  - Wireless LAN, in its nature, may cause interference, depending on the use condition (AP performance, distance, obstacle, interference by other radio devices, etc).
  - Set the wireless IP sharer to Infrastructure mode. Ad-hoc mode is not supported.
  - When applying the security key for the AP (wireless IP sharer), only the following is supported.
    - 1) Authentication Mode : WEP, WPAPSK, WPA2PSK
    - 2) Encryption Type : WEP, TKIP, AES

# Connections

---

## CONNECTING THE FM ANTENNA

---

1. Connect the FM antenna supplied to the FM 75Ω COAXIAL Jack.
2. Slowly move the antenna wire around until you find a location where reception is good, then fasten it to a wall or other rigid surface.

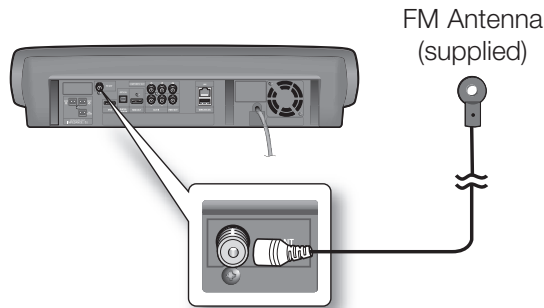

- 
-  This unit does not receive AM broadcasts.

## COOLING FAN

---

The cooling fan supplies cool air to the unit to prevent overheating. Please observe the following cautions for your safety.

- Make sure the unit is well-ventilated. If the unit has poor ventilation, the temperature inside the unit may rise and may damage it.
- Do not obstruct the cooling fan or ventilation holes. (If the cooling fan or ventilation holes are covered with a newspaper or cloth, heat may build up inside the unit and fire may result.)

## ATTACHING THE TOROIDAL FERRITE CORE TO THE POWER CORD OF THE MAIN UNIT

---

If you attach a Toroidal ferrite core to the power cord of the main unit, it will prevent help to prevent RF interference from radio signals.

1. Pull the fixing tab of the Toroidal ferrite core to open it.
2. Make a loop twice in the main unit power cord.
3. Attach the Toroidal ferrite core to the main unit power cord as the figure shows and press it until it clicks.

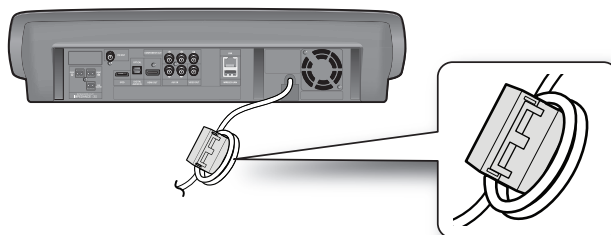

# Basic functions of your Blu-ray Home Theater

This section introduces basic playback functions and playback by disc type.

## BEFORE PLAYING

- Turn on your TV and set it to the correct Video Input (the input the Blu-ray Home Theater is connected to).
- If you connected an external Audio System, turn on your Audio System and set it to the correct Audio Input.

After plugging in the player, the first time you press the **POWER** button, this screen comes up:

If you want to select a language, press a **NUMBER** button. (This screen will only appear when you plug in the player for the first time.) If the language for the startup screen is not set, the settings may change whenever you turn the power on or off. Therefore, make sure that you select the language you want to use. Once you select a menu language, you can change it by pressing the **STOP** (■) button on the front panel of the unit for more than 5 seconds with no disc in the unit. Then the MENU LANGUAGE SELECTION window appears again where you can reset your preferred language.

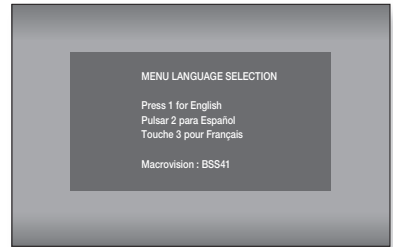

- Discs which can be played on this player (For the following discs, the ability to play back may depend on recording conditions.)
  - BD-ROM
  - BD-RE
  - BD-R
  - DVD-R
  - DVD-RW (V mode)
  - CD-RW/CD-R
  - The unit may not play certain CD-RW/CD-R and DVD-R due to the disc type or recording conditions.
- Discs which cannot be played on this player.
  - HD DVD
  - DVD+RW
  - DVD+R
  - DVD-ROM
  - DVD-RAM
  - CDV
  - CD-ROM
  - CVD
  - CD-I
  - Super Audio CD(except CD layer)
  - CDGs play audio only, not graphics.
- Blu-ray is a new and evolving format. Accordingly, disc compatibility issues with new and existing format discs are possible. Not all discs are compatible and not every disc will playback.

For additional information, refer to the Disc Type and Characteristics and Compliance and Compatibility Notice sections of this Manual. If you encounter compatibility problems, please contact SAMSUNG customer care center.

# Basic functions of your Blu-ray Home Theater

## ON-SCREEN MENU NAVIGATION

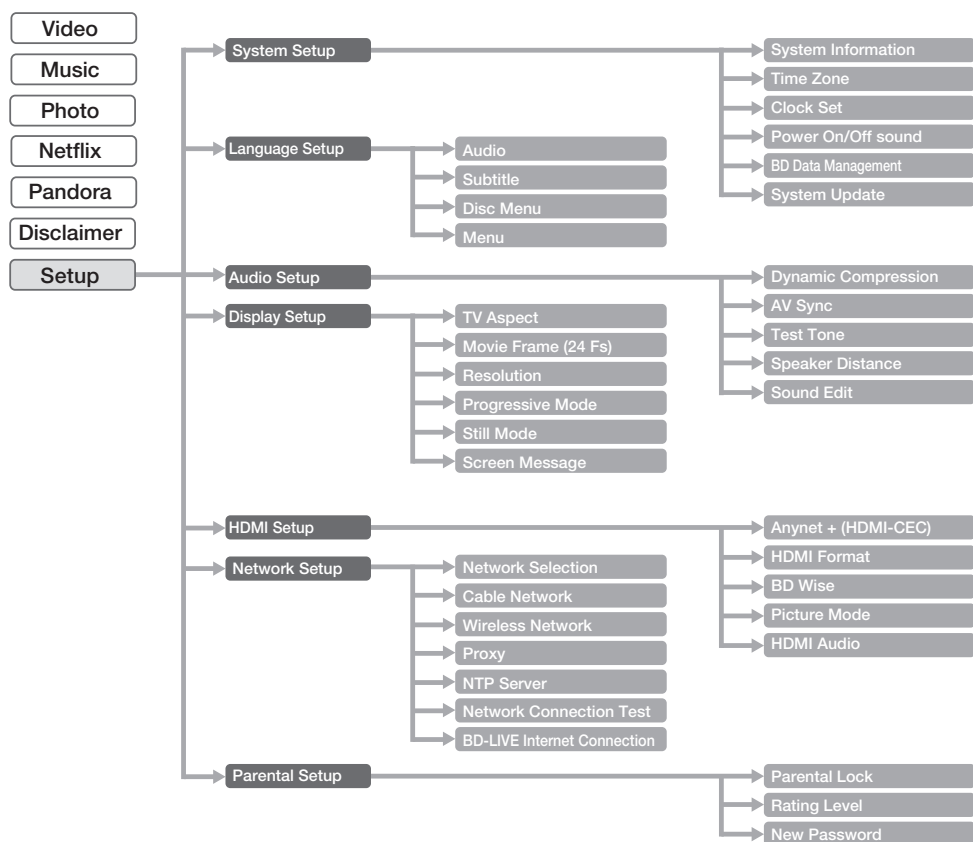

## PLAYING A DISC

1. Load a disc.
  - Place a disc gently into the tray with the disc's label facing up.
2. Close the compartment by pressing the **PLAY** button.
  - Playback starts automatically.



- When you stop disc play, the player remembers where you stopped, so when you press **PLAY** button again, it will pick up where you left off. This is called the "Resume" function. With some Blu-ray discs(BD-J), this function may not work.
- Press the **STOP** button twice during playback to disable the Resume function.
- To pause the playback, press the **PAUSE** button during playback. To resume, press the **PLAY** button.
- If the player is left in the stop mode more than 5 minutes without any user interface, a screen saver will appear on your TV. If the player is left in the screen saver mode for more than 30 minutes, the power will automatically turn off except during playback of an CD-DA (Automatic Power-Off Function).
- If no buttons are pressed on the unit or remote control for more than 5 minutes when the unit is in Pause mode, operation will stop (except for some Blu-ray Discs).



## SETTING THE SOUND

### Setting the Power On / Off Melody Sound

A Melody sound can be set so it is heard each time you turn the player on or off.

1. With the unit in Stop mode, press the **MENU** button.
2. Press the **▲▼** buttons to select **Setup**, then press the **ENTER** or **▶** button.
3. Press the **▲▼** buttons to select **System Setup**, then press the **ENTER** or **▶** button.
4. Press the **▲▼** buttons to select **Power On/Off sound**, then press the **ENTER** or **▶** button.
5. Press the **▲▼** buttons to select **On** or **Off**, then press the **ENTER** or **▶** button.
6. Press the **MENU** button to exit the setup menu.

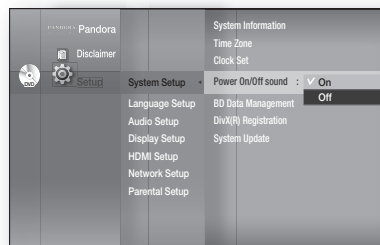

## USING THE SEARCH AND SKIP FUNCTIONS

During play, you can search quickly through a chapter or track, and use the skip function to jump to the next selection.

### Searching through a Chapter or Track



During playback, press the **SEARCH** (**◀▶**) button.

Each time you press the **SEARCH** button, the playback speed will change as follows.

BD-ROM, BD-RE, BD-R, DVD-VIDEO, DVD-RW, DVD-R	▶▶ X 2 → ▶▶ X 4 → ▶▶ X 8 → ▶▶ X 16 → ▶▶ X 32 → ▶▶ X 128 ◀◀ X 2 → ◀◀ X 4 → ◀◀ X 8 → ◀◀ X 16 → ◀◀ X 32 → ◀◀ X 128
--	--

- You can scan the program in reverse.
- To return to normal speed playback, press the **PLAY** button.



- No sound is heard during search mode.

### Skipping Tracks



During playback, press the **SKIP** (**⏮⏭**) button.

When playing a Blu-ray Disc/DVD, if you press the **SKIP** (**⏭**) button, it moves to the next chapter.

If you press the **SKIP** (**⏮**) button, it moves to the beginning of the chapter. One more press makes it move to the beginning of the previous chapter.

# Basic functions of your Blu-ray Home Theater

## SLOW MOTION PLAY/STEP MOTION PLAY

### Slow Motion Play



In pause or step mode, press the **SLOW** button on the remote control for Slow Motion play.

- If you press the **SLOW** button, **▶ 1/8 ▶ 1/4 ▶ 1/2**
- To return to normal speed playback, press the **PLAY** () button.

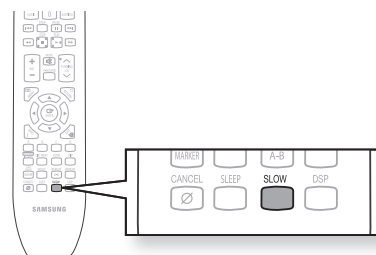

- This (⊘) icon indicates an invalid button press.
- No sound is heard during slow mode.
- Slow motion operates only in the forward direction.

### Step Motion Play



Press the **STEP** button on the remote control during play for Step Motion play.

- Each time the button is pressed a new frame will appear.
- When the **STEP** button is pressed, the next frame will be activated.
- Press the **PLAY** () button to resume normal play.

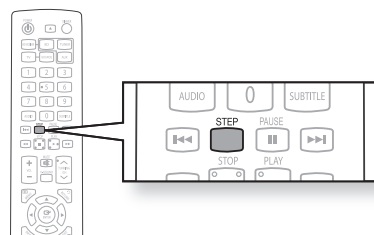

- No sound is heard during step mode.
- Step motion operates only in the forward direction.

# System setup

## SETTING THE CLOCK

### Choose your time zone

1. With the unit in Stop mode, press the **MENU** button.
2. Press the **▲▼** buttons to select **Setup**, then press the **ENTER** or **▶** button.
3. Press the **▲▼** buttons to select **System Setup**, then press the **ENTER** or **▶** button.
4. Press the **▲▼** buttons to select **Time Zone**, then press the **ENTER** or **▶** button.
5. Use the **◀▶** button to place the cursor to the appropriate time zone for your area and press the **ENTER** button.

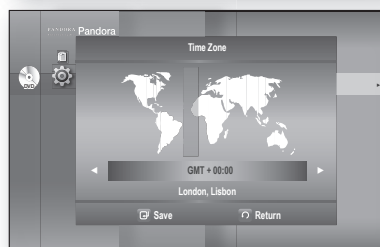
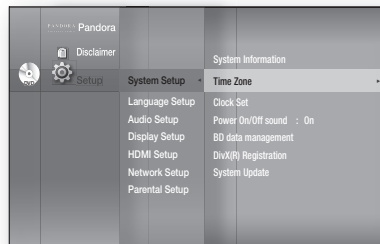

■ To set the time automatically, set the NTP server to **On** (see page 53).

### Set the clock

To setup, follow steps 1 through 3 above.

4. Press the **▲▼** buttons to select **Clock Set**, then press the **ENTER** or **▶** button.
5. Press the **◀▶** buttons to move to **“da.”**(date), **“hr”** (hour), **“min”** (minute) and **“am/pm”**. Set the date and time by pressing the **▲▼** buttons, then press the **ENTER** button.

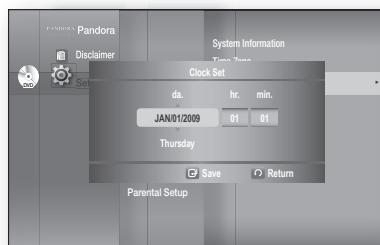
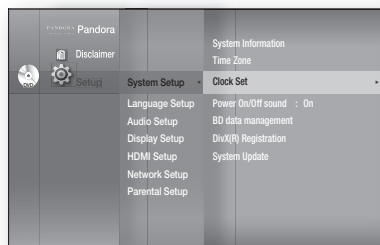

# Language setup

## SETTING UP THE LANGUAGE OPTIONS

Once you set the audio, subtitle, disc menu and player menu language options, they will be applied automatically every time you watch a movie.

- ✍ If you want to choose a different audio and subtitle language while playing a disc, you can also use the disc menu to make the selection.

1. With the unit in Stop mode, press the **MENU** button.
2. Press the **▲▼** buttons to select **Setup**, then press the **ENTER** or **▶** button.

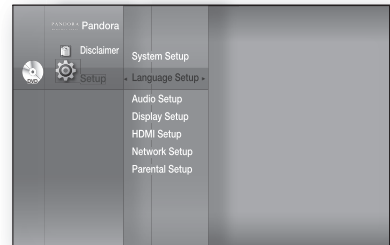

3. Press the **▲▼** buttons to select **Language Setup**, then press the **ENTER** or **▶** button.  
Language setup menu will be displayed.

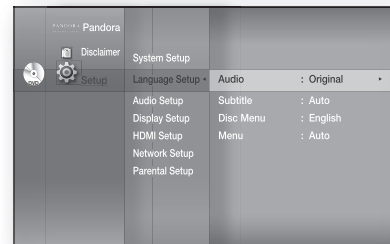

4. Press the **▲▼** buttons to select the desired language option, press the **ENTER** or **▶** button.
  - **Audio** : For the disc audio language.
  - **Subtitle** : For the disc subtitles.
  - **Disc Menu** : For the disc menu contained on the disc
  - **Menu** : For the on-screen menu of your Blu-ray Home Theater.

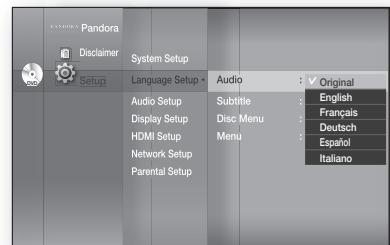

5. Press the **▲▼** buttons to select the desired language, then press the **ENTER** button.

- ✍ Press the **RETURN** or **◀** button to return to the previous menu. Press the **MENU** button to exit the menu.
  - The selected language will only appear if it is supported on the disc.

# Audio setup

## SETTING UP THE SPEAKER OPTIONS

### Dynamic Compression

This is only active when a Dolby Digital signal is detected.

- **On** : When Movie soundtracks are played at low volume or from smaller speakers, the system can apply appropriate compression to make low-level content more intelligible and prevent dramatic passages from getting too loud.
- **Off** : You can enjoy the movie with the standard Dynamic Range.

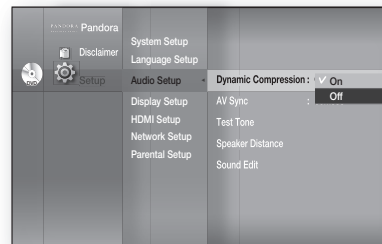

### AV Sync

Video may look slower than the audio when the player is connected to a digital TV. If this occurs, adjust the audio delay time to match the video.

- You can set the audio delay time between 0 ms and 300 ms. Set it to the optimal status.

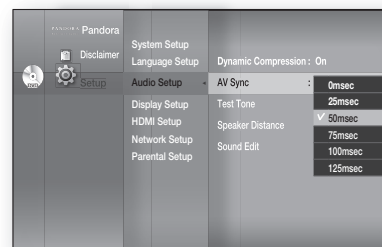

### Setting the Test Tone

Use the Test Tone feature to check the speaker connections.

1. With the unit in Stop mode, press the **MENU** button.
2. Press the **▲▼** buttons to select **Setup**, then press the **ENTER** or **▶** button.
3. Press the **▲▼** buttons to select **Audio Setup**, then press the **ENTER** or **▶** button.
  - Audio setup menu will be displayed.
4. Press the **▲▼** buttons to select **Test Tone**, then press the **ENTER** or **▶** button.
5. Press the **RED(A)** button
  - A test tone will be sent to **L → R → LFE** in order so you can make sure the speakers are set up correctly.
6. To end the test tone, press the **RED (A)** button again.

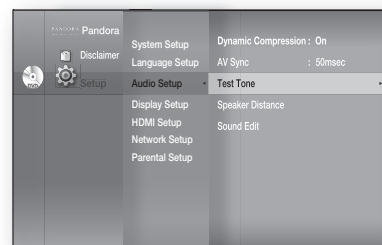
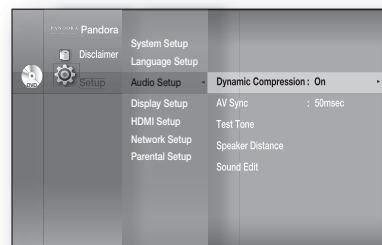

- Press the **RETURN** button to return to the previous menu.
- When playing a BD/DVD or CD, this will work only in Stop mode.
- Use this function to check that each speaker is correctly connected and that there is no problem.
- When HDMI AUDIO is on (audio is produced through TV speakers), the TEST TONE function is not available.

# Audio setup

## SETTING UP THE SPEAKER OPTIONS

### Setting the Speaker Distance

If the speakers cannot be placed at equal distances from the listening position, you can adjust the delay time of the audio signals from the front, subwoofer speakers.

1. With the unit in Stop mode, press the **MENU** button.
2. Press the **▲▼** buttons to select **Setup**, then press the **ENTER** or **▶** button.
3. Press the **▲▼** buttons to select **Audio Setup**, then press the **ENTER** or **▶** button.
  - Audio setup menu will be displayed.

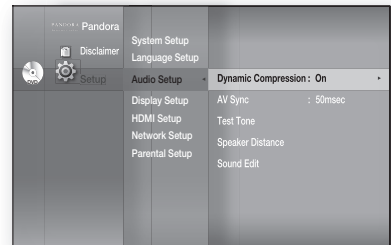

4. Press the **▲▼** buttons to select **Speaker Distance**, then press the **ENTER** or **▶** button.
5. Press the **▲▼** buttons to select the desired Speaker, then press the **◀▶** buttons to set the Speaker Distance.
  - You can set the Speaker Distance between 1ft(0.3m) and 30ft(9m).
6. When done, use the **▲▼◀▶** buttons to select **Save**, then press the **ENTER** button.

If you don't want to save your settings, use the **▲▼◀▶** buttons to select **Cancel**, then press the **ENTER** button.

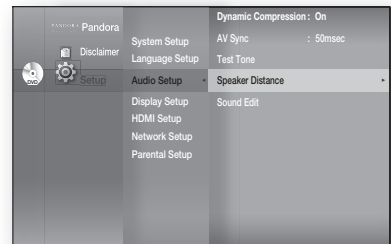

 ■ Press the **RETURN** button to return to the previous menu.

### Setting the Sound Edit

You can adjust the balance and level for each speaker.

1. With the unit in Stop mode, press the **MENU** button.
2. Press the **▲▼** buttons to select **Setup**, then press the **ENTER** or **▶** button.
3. Press the **▲▼** buttons to select **Audio Setup**, then press the **ENTER** or **▶** button.
  - Audio setup menu will be displayed.

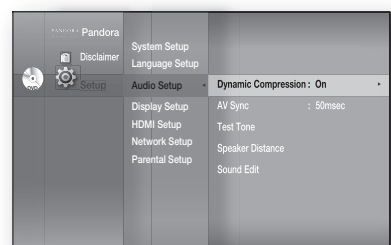

## Setting the Sound Edit

- Press the ▲▼ buttons to select **Sound Edit**, then press the **ENTER** or ► button.
- Press the ▲▼ buttons to select the desired Speaker, then press the ◀▶ button to adjust the settings.
- When done, use the ▲▼◀▶ buttons to select **Save**, then press the **ENTER** button.  
If you don't want to save your settings, use the ▲▼◀▶ buttons to select **Cancel**, then press the **ENTER** button.

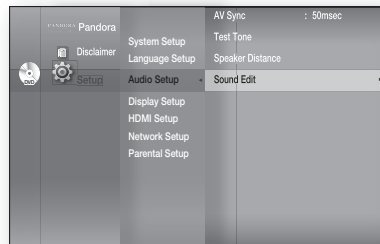

- Press the **RETURN** button to return to the previous menu.

### Adjusting Front Speaker Balance

- You can select between 0, -6, and OFF.
- The volume decreases as you move closer to -6.

### Adjusting Subwoofer Speaker Level

- The volume level can be adjusted in steps from +6dB to 6dB.
- The sound gets louder as you move closer to +6dB and quieter as you get closer to -6dB.

## V-SOUND (Virtual Sound)

Produces realistic sound through 2-channel audio with the aid of virtual effects, this gives the user the feeling they are listening to 5.1 channel audio.

Press the **V-SOUND** button.

- Each time the button is pressed, the selection changes as follows :

**V.SOUND ON** → **V.SOUND OFF**

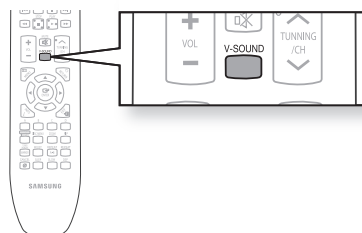

## DSP Function

Press the **DSP** button.

- Each time the button is pressed, the selection changes as follows:

**SMART SOUND** → **AUDIO UPSCALE**

→ **POWER BASS** → **DSP MODE OFF**

- SMART SOUND** : This will regulate and stabilize the volume level against a drastic volume change when changing channels or during a scene transition.
- AUDIO UPSCALE** : This also helps enhance your sound experience (ex. mp3 music). You can upscale your MP3 level sound(24 kHz, 8bit) to CD level sound(44.1 kHz, 16bit).
- POWER BASS** : POWER BASS function stresses low tones providing thudding sound effects.

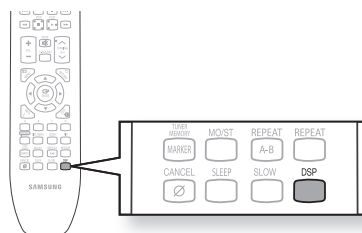

# Display setup

## SETTING UP THE DISPLAY OPTIONS

This function allows you to setup the TV screen settings. This function depends on the disc or TV type. It may not work with some discs or TVs.

1. With the unit in Stop mode, press the **MENU** button.
2. Press the **▲▼** buttons to select **Setup**, then press the **ENTER** or **▶** button.
3. Press the **▲▼** buttons to select **Display Setup**, then press the **ENTER** or **▶** button. Video setup menu will be displayed.
4. Press the **▲▼** buttons to select the desired display option from the options on the following pages.
5. Press the **▲▼** buttons to select the desired sub-menu item from a video display option, then press the **ENTER** button.
6. Each video option is described in detail below.



- Press the **RETURN** or **◀** button to return to the previous menu. Press the **MENU** button to exit the menu.

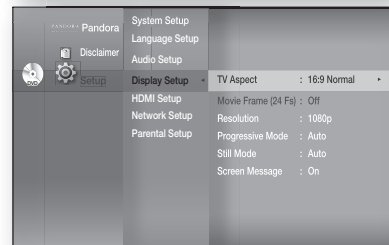
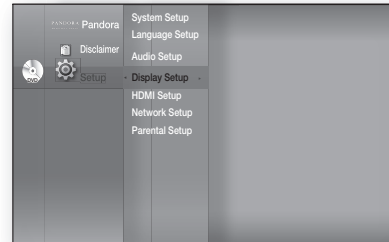

## TV Aspect

Depending on the type of television you have, you may want to adjust the screen setting. (aspect ratio)



- **4:3 Letter Box :**  
Select when you want to see the total 16:9 ratio screen a Blu-ray Disc/DVD supplies, even though you have a TV with a 4:3 ratio screen. Black bars will appear at the top and bottom of the screen.



- **4:3 Pan-Scan :**  
Select when you want to see the 16:9 video supplied by the Blu-ray Disc/DVD without the black bars on top and bottom, even though you have a TV with a 4:3 ratio screen (extreme left and right portion of the movie picture will be cut off).



- **16:9 Wide :**  
You can view the full 16:9 picture on your widescreen TV.



- **16:9 Normal :**  
Certain movies (4:3 source) will be displayed in 4:3 Pillarbox (black bars on sides of picture) if 16:9 normal is selected.

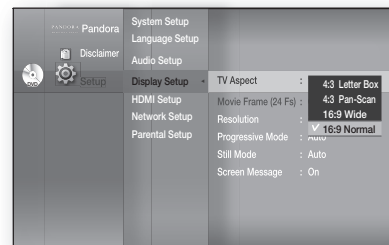

- Depending on the disc type, some aspect ratios may not be available.
- If you select an aspect ratio which is different than the aspect ratio of your TV screen, then the picture might appear to be distorted.



## Movie Frame (24 Fs)

Movies are usually filmed at 24 frames per second. Some Blu-ray Discs have the capability of playing back at this frame rate. Setting the Movie Frame (24Fs) feature to ON allows you to adjust the Blu-ray Home Theater's HDMI output to 24 frames per second for improved picture quality.

You can enjoy the Movie Frame (24Fs) feature only on a TV supporting this frame rate.

This menu can only be selected in 1080i or 1080p HDMI output resolution modes.

Depending on the disc, two types of frame rates may be included: Movie material (24 frame) and Video material (30 frame). When the setting switches between Movie (24 frame) and Video (30 frame), the screen may blink for a few seconds.

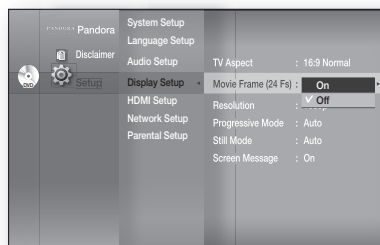

## Resolution

Sets the output resolution of the HDMI and Component video signal.

- The number in 480i, 480p, 720p, 1080p and 1080i indicates the number of lines of video. The i and p indicate interlace and progressive scan, respectively.
  - BD Wise : Automatically sets the optimal resolution when connected via HDMI to a TV with the BD Wise feature. (The BD Wise menu item appears only if BD Wise is set to On.)
  - 1080p : Outputs 1080 lines of progressive video (HDMI only).
  - 1080i : Outputs 1080 lines of interlaced video.
  - 720p : Outputs 720 lines of progressive video.
  - 480p : Outputs 480 lines of progressive video.
  - 480i : Outputs 480 lines of interlaced video (Component only).

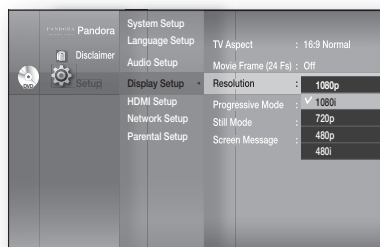

If the connected TV does not support Movie Frame or the selected resolution, you will see the following message:

If you select **Yes** and the resolution is not supported, the TV's screen will be blank. Please wait for 15 seconds and the resolution will revert to the previous value automatically.

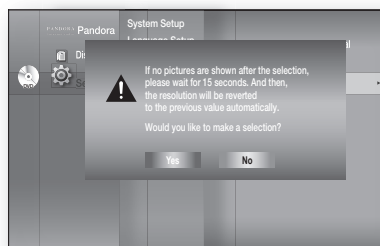

- If the screen is blank, press and hold the **STOP** (■) button on the front of the player for more than 5 seconds (no disc inserted). All settings are restored to the factory default. Follow the steps on the previous page to access each mode and select the Display Setup that your TV will support.
- When the factory default settings are restored, all the user data stored in the BD data will be deleted.

# Display setup

## SETTING UP THE VIDEO DISPLAY/OUTPUT OPTIONS

### Resolution according to the output mode

#### • Blu-ray Disc playback

Setup \ Output	HDMI	Component (HDMI&Comp. connected / Comp. connected only)	VIDEO
1080p, Movie Frame(24Fs) off	1080p@60F	1080i	480i
1080p/1080i, Movie Frame (24Fs) on	1080p@24F	480i / 1080i	480i
1080i, Movie Frame (24Fs) off	1080i	1080i	480i
720p	720p	720p	480i
480p	480p	480p	480i
480i	480p	480i	480i

#### • DVD playback

Setup \ Output	HDMI	Component (HDMI&Comp. connected / Comp. connected only)	VIDEO
1080p	1080p@60F	480i / 480p	480i
1080i	1080i	480i / 480p	480i
720p	720p	480i / 480p	480i
480p	480p	480i / 480p	480i
480i	480p	480i	480i



- In DVD playback, if both HDMI and Component jacks are connected and you select the Component 1080p, 1080i or 720p mode, the Display Setup menu will show the output resolution as 1080p, 1080i or 720p in the menu. The resolution is actually 480i.
- This player has the HDMI Auto Detect Feature. When the player is first connected to a TV via HDMI, the player's output will be set automatically to HDMI.
- If the HDMI Auto Detection feature does not work, you can't select the 1080p resolution or Movie Frame (24Fs).
- The Blu-ray Disc must have the 24 frame feature in order to use the Movie Frame (24Fs) mode.

## Progressive Mode

The Progressive Mode helps to improve picture quality when viewing 480i resolution DVD discs.

- **Auto** : Select this to have the player automatically set the best picture for the DVD you're watching.
- **Video** : Select this for the best picture from Concert or TV show DVDs.

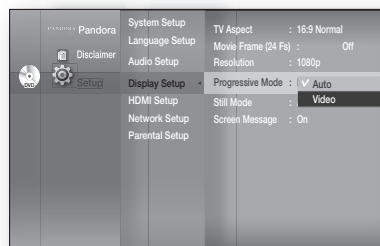

## Frame & Field bar

### Still Mode

Set the Auto, Field or Frame setting for the best possible still picture (pause mode) from a DVD.

- **Auto**: Select this setting to have the player automatically display the best Still picture depending on the content.
- **Field Mode**: Select this when pausing a scene with a lot of action.
- **Frame Mode**: Select this to increase the resolution of the Still picture.

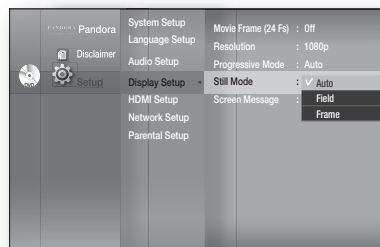

### Screen Message

- **On** : Displays messages related to operation mode.
- **Off** : Does not display messages related to operation mode.

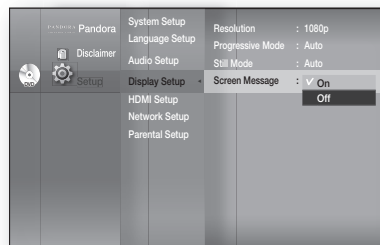

# HDMI setup

## SETTING UP THE HDMI SETUP OPTIONS

1. With the unit in Stop mode, press the **MENU** button.
2. Press the **▲▼** buttons to select **Setup**, then press the **ENTER** or **▶** button.
3. Press the **▲▼** buttons to select **HDMI Setup**, then press the **ENTER** or **▶** button.  
HDMI setup menu will be displayed.
4. Press the **▲▼** buttons to select the desired display option, then press the **ENTER** or **▶** button.

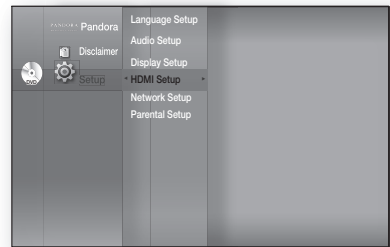

- Press the **RETURN** or **◀** button to return to the previous menu. Press the **MENU** button to exit the menu.

## Anynet+ (HDMI-CEC)

**Samsung products only**

### What is Anynet+?

Anynet+ is a convenient function that offers linked operations with other Samsung products with the Anynet+ feature.

You can operate this unit using a Samsung TV remote control or power on your Samsung TV and Home theater and start disc playback simply by pressing the **PLAY** button on the TV's remote.



- This function is not available if the HDMI cable does not support CEC.

### To use Anynet+

1. Connect the Blu-ray Home Theater to a Samsung TV with an HDMI cable. (See pages 22~23)
2. Set the Anynet+ function on your TV. (See the TV instruction manual for more information.)

### Anynet+ Functions

- One touch play  
You can power on your Samsung TV and Home Theater, and play the disc in this unit simply by pressing the **PLAY** button on the TV's remote.
- One touch watching  
Select "Watching Blu-ray Home Theater" or "Connected to Blu-ray Home Theater" (depending on your TV's menu) in the Anynet+ menu on the TV. The Blu-ray Home Theater will automatically turn on and the TV will be switched to HDMI mode.
- Remote control Link  
You can operate this player with your Samsung TV remote control.
- Available buttons on the Samsung TV remote: These buttons work the same as this Blu-ray Home Theater's remote control.

- Playback control buttons :

- Menu operation button :

- Numeric buttons :

- Color buttons :

## TV Anynet+ Menu

When you press the Anynet+ button on your Samsung TV's remote control, the following On-Screen Display (OSD) will be shown.

- Blu-ray Home Theater Menu
  - When playing a movie : brings up the disc's menu (same as **DISC MENU** button on the Blu-ray Home Theater's remote control)
  - In Stop mode : brings up the SETUP menu (same as the **MENU** button on the Blu-ray Home Theater's remote control.)
- Blu-ray Home Theater Operation Menu
  - When playing a DVD VIDEO, DVD-RW/-R, BD-ROM, BD-RE : shows INFO OSD (same as **INFO** button on the player's remote control)



- These menus may look different depending on your Samsung TV.

## HDMI Format

You can optimize the HDMI output for connection to a TV or Monitor.

- **TV** : Select if connected to a TV via HDMI.
- **Monitor** : Select if connected to a Monitor via HDMI.  
If the player is connected to a TV, the Monitor option is unavailable.

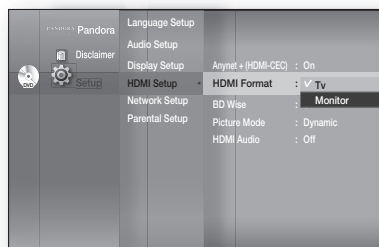

- TV or monitor has to be connected to the player before you select this option.

## BD Wise

### Samsung products only

BD Wise is Samsung's latest inter-connectivity feature. When you connect Samsung products with BD-Wise to each other via HDMI, the optimum resolution will be set automatically.

- **On** : The original resolution of the BD/DVD disc will be output to the TV direct.
- **Off** : The output resolution will be fixed according to the Resolution previously set, regardless of the resolution of the disc.

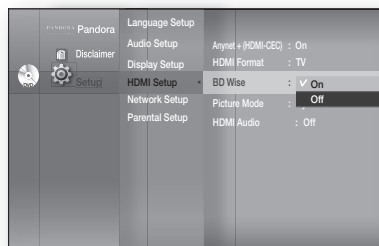

- If you want to change the resolution when you set BD Wise on, you must set BD Wise to Off in advance.
- If you set BD Wise to off, the resolution of the connected TV will be automatically adjusted to its maximum resolution.
- If the player is connected to a device that does not support BD Wise, you can not use the BD wise function.
- For a proper operation of BD Wise, set BD Wise to ON in the menus of the player and the TV.

# HDMI setup

## SETTING UP THE HDMI SETUP OPTIONS

### Picture Mode

This function enables you to adjust video quality when you are connected to a TV via HDMI.

- **Dynamic** : Choose this setting to increase Sharpness.
- **Normal** : Choose this setting for most viewing applications.
- **Movie** : This is the best setting for watching movies.

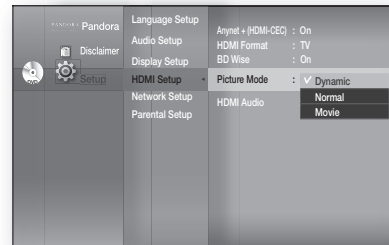

### HDMI Audio

The audio signals transmitted over the HDMI Cable can be toggled ON/OFF.

- **On** : Both video and audio signals are transmitted over the HDMI connection cable, and audio is output through your TV speakers only.
- **Off** : Video is transmitted over the HDMI connection cable only, and audio is output through the Blu-ray Home Theater speakers only.

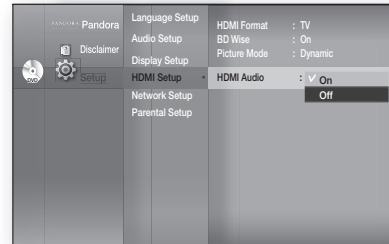

- The default setting of this function is HDMI Audio Off.
- HDMI AUDIO is automatically down-mixed to 2ch for TV speakers.

# Parental setup

## SETTING UP THE PARENTAL LOCK

The Parental Lock function works in conjunction with Blu-ray Disc/DVDs that have been assigned a rating which helps you control the types of Blu-ray Disc/DVDs that your family watches. There are up to 8 rating levels on a disc.



1. With the unit in Stop mode, press the **MENU** button.
2. Press the **▲▼** buttons to select **Setup**, then press the **ENTER** or **▶** button.

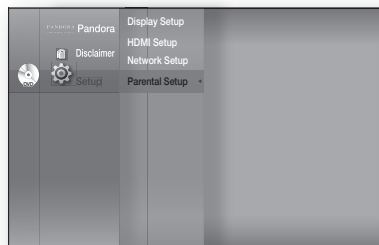

3. Press the **▲▼** buttons to select **Parental Setup**, then press the **ENTER** or **▶** button.  
When you operate your Blu-ray Home Theater for the first time, the "Enter New password." message will be displayed.

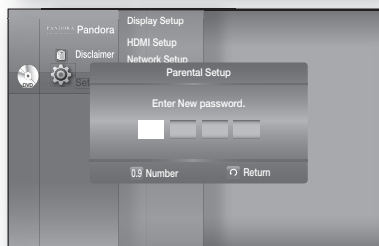

4. Enter the 4-digit password using the number buttons on the remote control.  
The "Confirm the password." message will be displayed.  
Enter your password again.

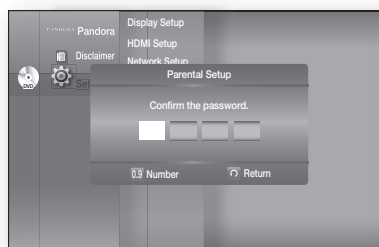

5. Press the **ENTER** or **▶** button to select Parental Lock.
6. Press the **▲▼** buttons to select **On** or **Off**, then press the **ENTER** button.

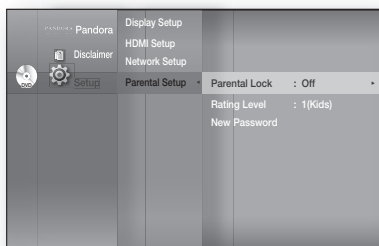

-  Press the **RETURN** or **◀** button to return to the previous menu. Press the **MENU** button to exit the menu.

# Parental setup

## SETTING UP THE PARENTAL LOCK

### If you forgot your password

1. Remove the disc.
2. Press and hold the **STOP** (■) button on the front panel for 5 seconds or more.
  - All settings will revert to the factory settings.



- When the factory default settings are restored, all the user data stored in the BD data will be deleted.

### Setting the Rating Level

1. Press the ▲▼ buttons to select **Rating Level**, then press the **ENTER** or ► button.
2. Press the ▲▼ buttons to select the rating level you want, then press the **ENTER** button. For example, if you select up to Level 6, discs that contain Level 7, 8 will not play. A larger number indicates that the program is intended for adult use only. Level 1 is the most restrictive and Level 8 is the least.

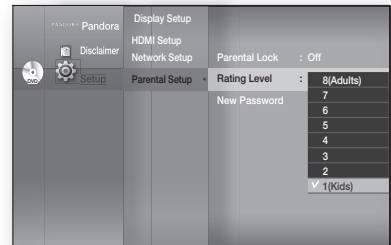

### Changing the Password

1. Press the ▲▼ buttons to select **New Password**, then press the **ENTER** or ► button.
2. Enter the 4-digit password using the number buttons on the remote control. The “Enter New password.” message will be displayed.
3. Enter your password again using the number buttons on the remote control.

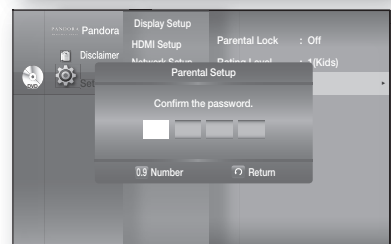
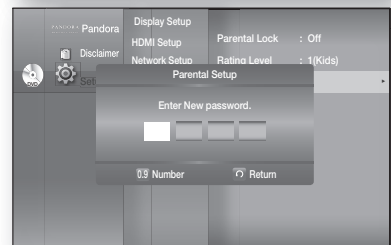
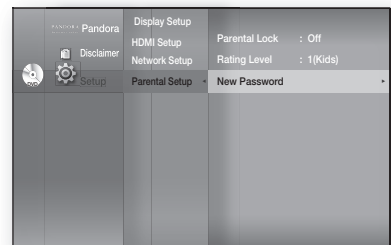



## SETTING UP THE NETWORK SETUP OPTIONS

To obtain information on the proper settings, check the network settings on your computer or contact your Internet provider.

To set the network of your Blu-ray Home Theater, follow the steps below.

1. With the unit in Stop mode/No Disc mode, press the **MENU** button.
2. Press the **▲▼** buttons to select **Setup**, then press the **ENTER** or **▶** button.
3. Press the **▲▼** buttons to select **Network Setup**, then press the **ENTER** or **▶** button.
4. Press the **▲▼** buttons to select the desired network option from the options described below, then press the **ENTER** or **▶** button.
5. Press the **▲▼** buttons to select the desired item, then press the **ENTER** button. Each network option is described in detail below.

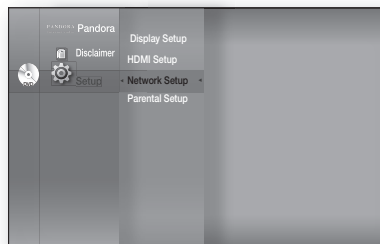

### Network Selection

Select Cable or Wireless as the method to connect to network.

To setup, follow steps 1~3 above.

4. Press the **▲▼** buttons to select **Network Selection**, then press the **ENTER** or **▶** button.
  - **Cable** : Select this to connect to the network using a cable. (see page 28)
  - **Wireless** : Select this to connect to the network wirelessly. (see page 29)

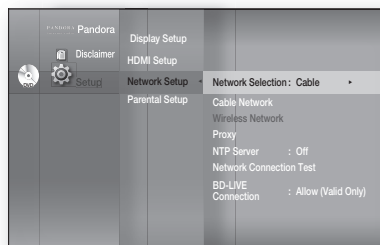

### Cable Network

To setup, follow steps 1~3 above.

4. Press the **▲▼** buttons to select **Cable Network**, then press the **ENTER** or **▶** button.
5. Press the **▲▼** buttons to select **DHCP**, then press the **ENTER** button.

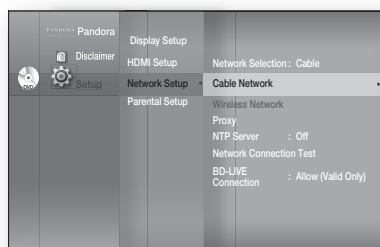

- If DHCP is set to **On**, you can't select IP Address, Subnet Mask or Gateway.
- If DNS is set to **Auto**, you can't select Primary/Secondary DNS.

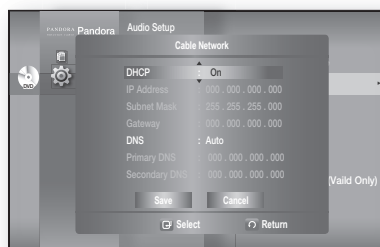

# Network setup

## SETTING UP THE NETWORK SETUP OPTIONS

6. Press the ▲▼ buttons to select a desired item, then press the **ENTER** button.

- If DHCP is set to **Off** and, DNS to Manual, enter your IP Address, Subnet Mask, Gateway and Primary DNS settings (Secondary DNS is optional).

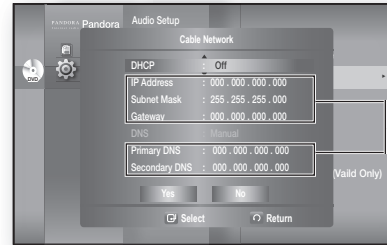

Setup available

- If DHCP is set to **On** and, DNS to Manual, enter your Primary DNS setting (Secondary DNS is optional).

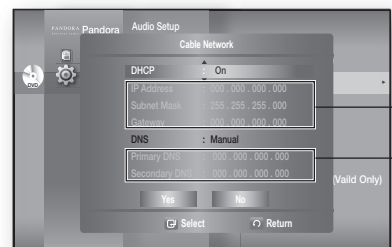

Setup available  
Setup not available

- If DHCP is set to **On** and, DNS to Auto, you don't need further or additional settings.

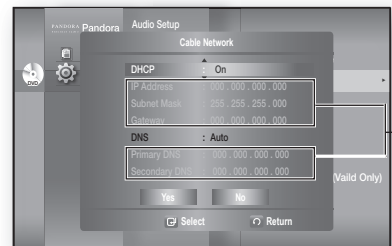

Setup not available

- When you select an item, use the number and ▲▼◀▶ buttons.
- If the automatic settings don't work, contact your ISP.

7. When done, use the ▲▼ buttons to select **Save**, then press the **ENTER** button.

8. If you don't want to save your work, use the ▲▼◀▶ buttons to select **Cancel**, then press the **ENTER** button.

- The IP address used in this manual is for illustrative purposes only. You must refer to your network settings for the actual IP address.
- To obtain settings for IP address, Subnet mask, Gateway and Primary DNS, check the network settings in your computer or contact your internet service provider.

## Wireless Network

To setup, follow steps 1~3 on page 49.

4. Press the ▲▼ buttons to select **Wireless Network**, then press the **ENTER** or ▶ button.

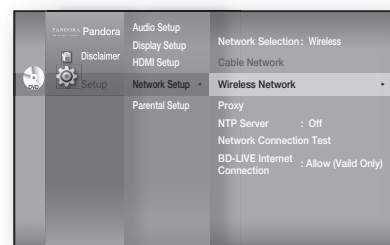

5. Press the ▲▼ buttons to select **DHCP**, then press the **ENTER** button.



- If DHCP is set to **On**, you can't select IP Address, Subnet Mask or Gateway.
- If DNS is set to **Auto**, you can't select Primary/Secondary DNS.

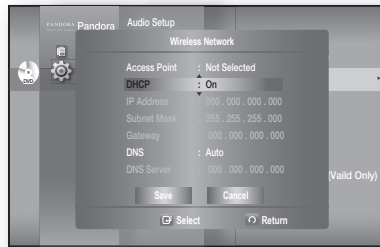

6. Press the ▲▼ buttons to select a desired item, then press the **ENTER** button.

- Select an Access Point, and then press the **ENTER** button to display available list of APs. (It may take several seconds to search.)

- When you select an AP and press the **ENTER** button, it tries to connect to the designated AP.
- If successful, a notification appears. (If selected AP shows a Lock icon, you may need to provide security authentication.)

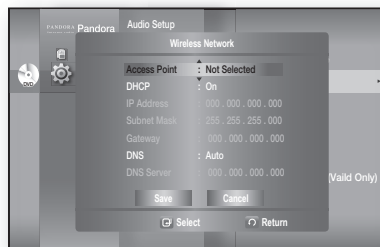

- Select your appropriate Security Access Point if it is known. If it is not, select WEP, WPAPSK or WPA2PSK from the list below and enter in the password. Keep trying each Security Access Point and enter the Password until a connection is made.

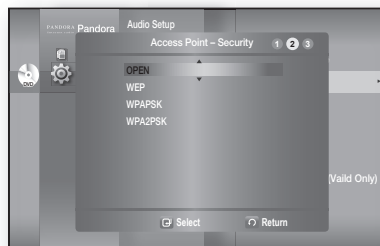

- Enter in the Password then press the **BLUE (D)** button to connect to your access point (Router).

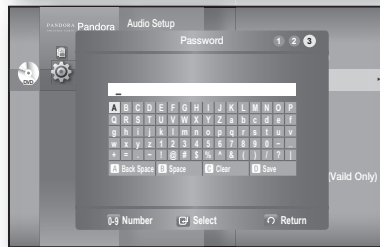

For further details on AP security, refer to the AP's (Router) user manual.

- If DHCP is set to **Off** and, DNS to Manual, enter your IP Address, Subnet Mask, Gateway and DNS Server.

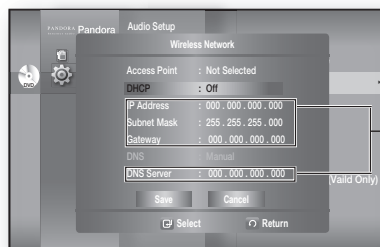

Setup available

# Network setup

## SETTING UP THE NETWORK SETUP OPTIONS

- If DHCP is set to **On** and, DNS to Manual, enter your DNS Server.

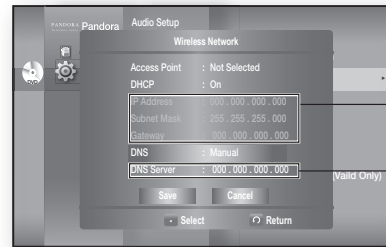

Setup available  
Setup not available

- If DHCP is set to **On** and, DNS to Auto, you don't need further or additional settings.



- When you select an item, use the number and ▲▼◀▶ buttons.
- If the automatic settings don't work, contact your ISP.

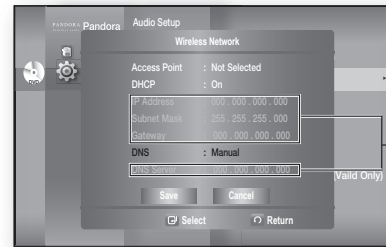

Setup not available

7. When done, use the ▲▼ buttons to select **Save**, then press the **ENTER** button.
8. If you don't want to save your work, use the ▲▼◀▶ buttons to select **Cancel**, then press the **ENTER** button.



- The IP address used in this manual is for illustrative purposes only. You must refer to the your network settings for the actual IP address.
- To obtain settings for IP address, Subnet mask, Gateway and DNS Server, check the network settings in your computer or contact your internet service provider.

## Proxy Setting

A proxy server services requests by forwarding them to other servers.

If you are required to configure the proxy setting, enter the settings specified by the ISP.

To setup, follow steps 1~3 on page 49.

4. Press the ▲▼ buttons to select **Proxy**, then press the **ENTER** or ▶ button.
  - **Server**
  - **Port**
  - **User**
  - **Password**

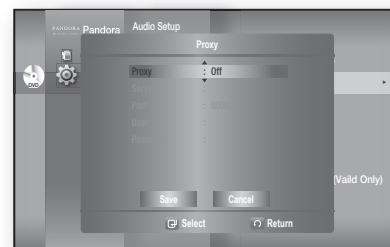

- For more information, contact your ISP (Internet Service Provider).

## NTP Server (Used to Retrieve Time Information from NTP Server)

To setup, follow steps 1~3 on page 49.

- Press the ▲▼ buttons to select **NTP Server**, then press the **ENTER** or ► button.
  - On** : the player automatically connects to the Internet server in order to adjust the time setting.
  - Off** : the player does not connect to the Internet server to adjust the time setting.

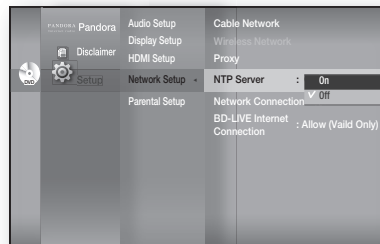

## Network Connection Test

Use this menu to check whether your network connection is working or not.

To setup, follow steps 1~3 on page 49.

- Press the ▲▼ buttons to select **Network Connection Test**, then press the **ENTER** or ► button.

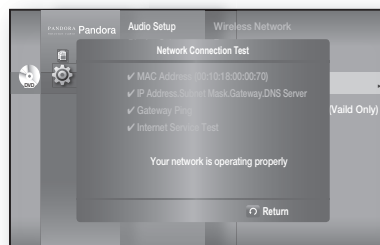

## BD-LIVE Internet Connection

The Blu-ray Home Theater supports BD-LIVE which enables you to enjoy a variety of interactive service contents provided by the disc manufacturer through a network connection. To enjoy this feature, you must first perform the LAN connection (see page 28) or Wireless Lan adapter connection to the USB slot.

\* You must have a minimum 1 GB USB Memory device inserted in one of the USB slots in order to download content from BD-LIVE.

The Internet connection may be restricted while you are using BD-LIVE contents.

To setup, follow steps 1~3 on page 49.

- Press the ▲▼ buttons to select **BD-LIVE Internet Connection**, then press the **ENTER** or ► button.
  - Allow (All)** : The Internet connection will be allowed for all BD-LIVE contents.
  - Allow (Valid Only)** : The Internet connection will be allowed only for BD-LIVE contents containing a valid certificate.
  - Prohibit** : No Internet connection will be allowed for any BD-LIVE content.

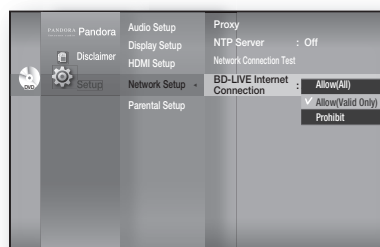

- What is a valid certificate?** When the Blu-ray Home Theater uses BD-LIVE to send the disc data and request to the server to certify the disc, the server uses the transferred data to check if the disc is valid and sends the certificate back to the player.
- The Internet connection may be restricted while you are using BD-LIVE contents.

# BD data management

BD Data (stored in external USB flash memory) is Blu-ray Disc content such as trailers and other special features downloaded from the BD-LIVE service or Blu-ray Discs.

\* You must have a minimum 1GB USB Memory device inserted in one of the USB slots in order to download content from BD-LIVE.

## SYSTEM DEVICE MANAGEMENT

You can manage user data stored in BD data.

1. With the unit in Stop mode, press the **MENU** button.
2. Press the **▲▼** buttons to select **Setup**, then press the **ENTER** or **▶** button.
3. Press the **▲▼** buttons to select **System Setup**, then press the **ENTER** or **▶** button.
4. Press the **▲▼** buttons to select **BD Data Management**, then press the **ENTER** or **▶** button.

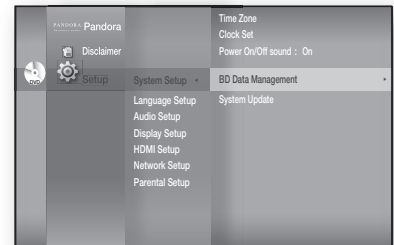

### - To delete the flash memory -

1. Press the **ENTER** button to select BD Data Delete.  
The message "All BD data will be deleted. Do you want to continue?" will be displayed.
2. Press the **◀▶** button to select Yes, then press the **ENTER** button.

### Description of Device(Storage) Information on the Player

- Total Size : Total size of the Device(Storage).
- Available Size : Available size of the Device(Storage).

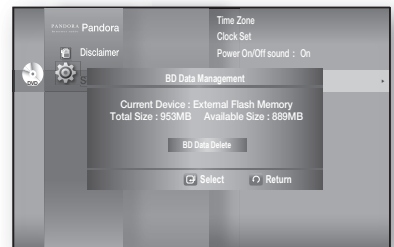

- Memory size information on the current device(storage) is located to the right of the BD Data Management menu.
- In the external memory mode, disc playback will be stopped if you disconnect the USB device in the middle of the playback.
- We recommend using an USB device that supports USB 2.0 protocols, FAT32 format and 4MB or more read /write speed.
- The Resume Play function may not work after formatting the storage device.

# System upgrade

Samsung may offer upgrades to your Blu-ray Home Theater's firmware in the future. To upgrade this firmware you must :

1. Go to [samsung.com](http://samsung.com) and refer to the 'SUPPORT' page to download the latest firmware.

You can use a CD-R or a USB flash drive to perform the firmware upgrade. For more information, see "Upgrade Manual" at the website mentioned above.

or

2. Connect the network (see pages 28~29) and follow the steps below.

## FIRMWARE UPGRADE

1. With the unit in Stop mode/No Disc mode, press the **MENU** button.
2. Press the **▲▼** buttons to select **Setup**, then press the **ENTER** or **▶** button.
3. Press the **▲▼** buttons to select **System Setup**, then press the **ENTER** or **▶** button.
4. Press the **▲▼** buttons to select **System Update**, then press the **ENTER** or **▶** button.
5. The player will check the cable or network connection status automatically. The connection checking window will be displayed.

■ If the upgrade is possible : You will see information on the current and new versions of firmware in a message box.

■ If the upgrade is not possible : You will see the following description in the message box.

- If the cable is not connected :  
"Ethernet cable is not connected. Please, check the Ethernet cable"
- If the network connection has failed :  
"This system can not connect to internet for update. Please, check the network setup"
- If no latest version is released (the latest version has been already installed) :  
"The latest version of the firmware is already installed. There is no need to update."
- If there is a disc in the player :  
"Please maintain "No Disc" state for network update."  
This indicates that you must remove all discs from the unit to perform the update.
- If the server service is not available :  
" Update Server is under maintenance. Please try again later."

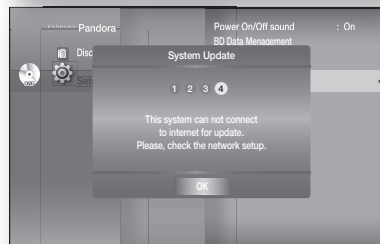
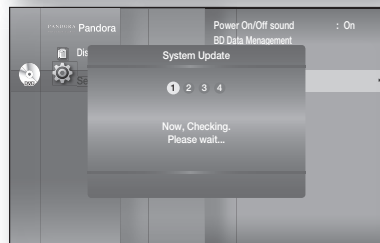
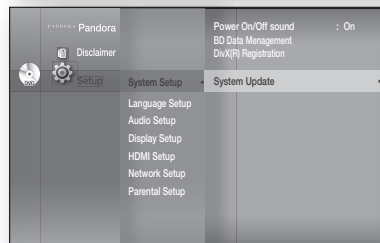
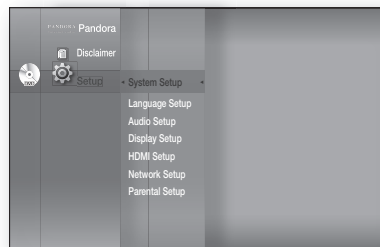

# System upgrade

## FIRMWARE UPGRADE

6. To perform the system upgrade, press the ◀ ▶ buttons to select **Start** and then press the **ENTER** button.

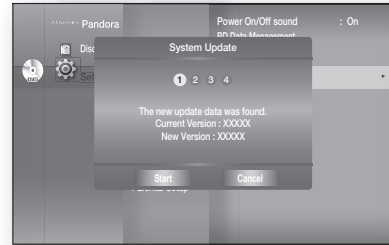

7. The system update gets started.

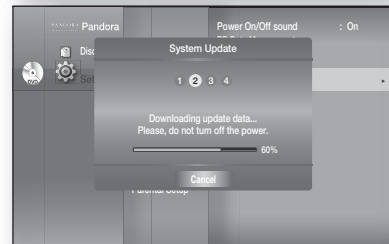

8. If you select Cancel during the download process, you are prompted to confirm your selection in a message box. If you want to cancel the download, select **Yes** and press the **ENTER** button.

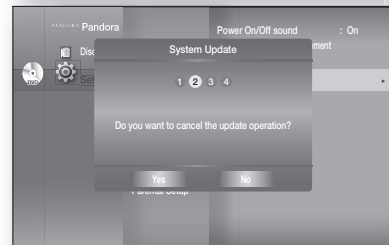

9. Verification will proceed. When download is done, the firmware update process will begin automatically.

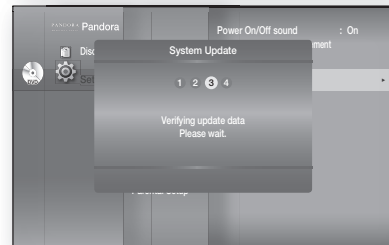

10. When the installation is done, the player will automatically turn off in 5 seconds. All settings will revert to the factory settings. The next time you start the system and you will see the menu language selection window.

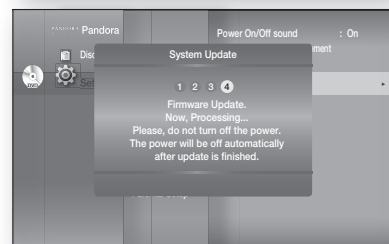

- If you want to cancel the upgrade in the process of downloading the upgrade data, press the **ENTER** button. You will see a confirmation message. Selecting **Yes** will end the upgrade process, and selecting **No** will continue the upgrade process.
- When the system upgrade is done, check the firmware details in the System Upgrade menu.
- Do not turn off the player during the System Upgrade, as it may cause the player to not work properly.
- You must use a USB Flash Drive to do software upgrades using the USB Host jack. Other USB devices(ex. MP3 player) are not guaranteed to work.
- There should be only one firmware upgrade file in USB flash drive for the player to properly perform an upgrade.
- Oversized USB drives may not be able to be inserted when a LAN or HDMI cable is connected.



## SYSTEM INFORMATION

When the firmware upgrade is done, check the firmware details by following the steps below.

1. With the unit in Stop mode/No Disc mode, press the **MENU** button.
2. Press the **▲▼** buttons to select **Setup**, then press the **ENTER** or **▶** button.
3. Press the **▲▼** buttons to select **System Setup**, then press the **ENTER** or **▶** button.
4. Press the **▲▼** buttons to select **System Information**, then press the **ENTER** or **▶** button.  
You can see detailed information about the current firmware.
5. Press the **ENTER** button to select **OK**.  
System Setup menu will be displayed.

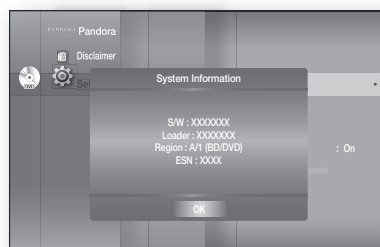
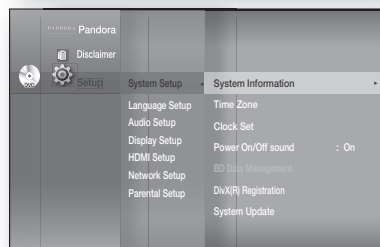
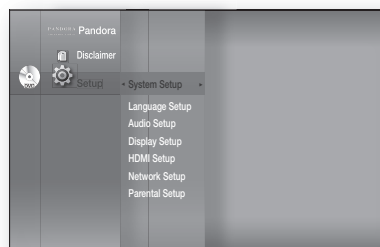

## FIRMWARE UPGRADE NOTIFICATION

This popup menu appears when a newer firmware version is available from SAMSUNG's update server than what is currently on the Blu-ray Home Theater.

- **Yes** : Select this to upgrade now.
- **No** : Select this if you plan to upgrade later.

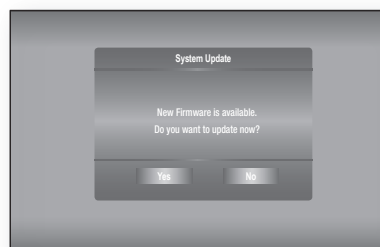

## DIVX (R) REGISTRATION

Please use the Registration code to register this Home Theater System with the DivX(R) Video On Demand format. For more information, visit [www.divx.com/vod](http://www.divx.com/vod)

# Watching a movie

## USING THE DISPLAY FUNCTION



1. During playback, press the **INFO** button on the remote control.
  - If the Blu-ray Disc has the PIP feature, press the **INFO** button in the PIP section to display PIP-related information.
2. Press the **▲▼** buttons to select the desired item.
3. Press the **◀▶** buttons to make the desired setup change and then press the **ENTER** button.
  - You may use the number buttons of the remote control to directly access a title, chapter or to start the playback from a desired time.
4. To make the screen disappear, press the **INFO** button again.



<INFO menu for the PIP section>

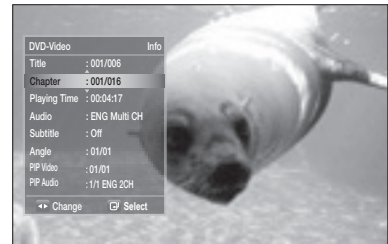

- If you are playing contents from the info menu, some functions may not be enabled depending on the disc.
- Title : To access the desired title when there is more than one in the disc. For example, if there is more than one movie on a Blu-ray Disc/DVD, each movie will be identified as a Title.
- Chapter: Most Blu-ray Disc/DVD discs are recorded in chapters so that you can quickly find a specific chapter.
- Audio : Refers to the film's soundtrack language. A Blu-ray Disc can contain up to 32 audio languages and a DVD up to 8.
- Playing Time : Allows playback of the film from a desired time. You must enter the starting time as a reference. The time search function does not operate on some discs.
- Subtitle : Refers to the subtitle languages available in the disc. You will be able to choose the subtitle languages or, if you prefer, turn them off from the screen. A Blu-ray Disc can contain up to 255 subtitle languages, and a DVD up to 32.
- Angle : When a Blu-ray Disc/DVD contains multiple angles of a particular scene, you can use the ANGLE function.
- PIP Video/ PIP Audio : You can make PIP Video or PIP Audio settings if the current title of a Blu-ray Disc appears in the PIP section. The PIP Video / PIP Audio options, however, will be disabled with a Blu-ray Disc that does not support the PIP feature.

# USING THE DISC MENU & POPUP/TITLE MENU

## Using the Disc Menu



1. During playback, press the **DISC MENU** button on the remote control.
2. Press the **▲▼◀▶** buttons to make the desired selection, then press the **▶** or **ENTER** button.
  - The Disc menu setup items may vary from disc to disc.



 ■ Depending on the disc, the Disc Menu may not be available.

## Using the Title Menu



1. During playback, press the **TITLE MENU** button on the remote control.
2. Press the **▲▼◀▶** buttons to make the desired selection, then press the **ENTER** button.
  - The Title menu setup options may vary from disc to disc.

 ■ Depending on the disc, the Title Menu may not be available.  
■ Title Menu will only be displayed if there are at least two titles on the disc.

## Playing the Title List



1. With the unit in Stop mode/Playback mode, press the **DISC MENU** or **TITLE MENU** button.
2. Press the **▲▼** buttons to select an entry you want to play from Title List, then press the **▶** or **ENTER** button.  
The selected entry (title) will be played back.

- Go to Playlist -  
To go to the Playlist, press the **RED(A)** button.

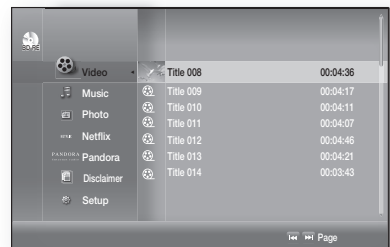

## Using the Popup Menu



1. During playback, press the **POPUP MENU** button on the remote control.
2. Press the **▲▼◀▶** buttons or **ENTER** button to select the desired menu.
  - The Popup menu setup options may vary from disc to disc.

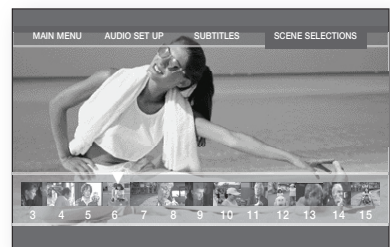

 ■ Depending on the disc, the Popup Menu may not be available.

# Watching a movie

## REPEAT PLAY

Repeat the current chapter or title.

### Repeat playback



1. During playback, press the **REPEAT** button on the remote control. Repeat screen appears.
2. Press the **▲▼** buttons to select **Chapter** or **Title**.
  - Blu-ray Disc/DVD repeats play by chapter or title.
3. To return to normal play, press the **REPEAT** button again, then press the **▲▼** buttons to select **Off**.

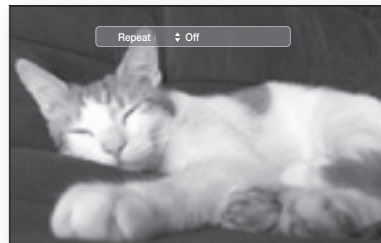

-  ■ Depending on the disc, the Repeat function may not be available.

### Using the A-B Repeat function



1. Press the **REPEAT A-B** button on the remote control during playback.
2. Press the **REPEAT A-B** button at the point where you want repeat play to start (A).
3. Press the **REPEAT A-B** button at the point where you want repeat play to stop (B).
4. To return to normal play, press the **CANCEL** button.

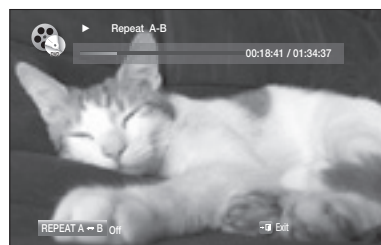

-  ■ Point B cannot be set until 5 seconds of playback has elapsed from point A.

## SELECTING THE AUDIO LANGUAGE



You can select a desired audio language quickly and easily with the **AUDIO** button.

### Using the AUDIO button

1. Press the **AUDIO** button during playback. The Audio changes when the button is pressed repeatedly.
  - The audio languages are represented by abbreviations.
2. To remove the **Audio** bar, press the **CANCEL** or **RETURN** button.

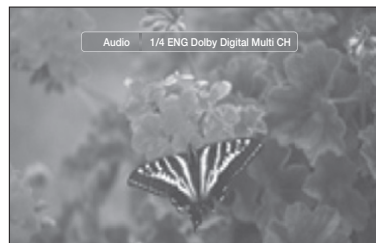

### Using the INFO button

1. During playback, press the INFO button on the remote control.
2. Press the ▲▼ buttons to select Audio language.
3. Press the ◀▶ buttons on the remote control to select the desired audio language.



- This function depends on what audio languages are encoded on the disc and may not be available.
- A Blu-ray Disc can contain up to 32 audio languages and a DVD up to 8.
- Depending on the disc type, you can use the **AUDIO** button to change the audio soundtrack as well as the audio language. Some Blu-ray Discs may allow you to select either the multi-channel LPCM or Dolby digital audio soundtrack in English.
- Information about the primary / secondary mode will be also displayed if the Blu-ray Disc has a PIP section. Use the ◀▶ button to switch between primary and secondary audio modes.
- The ◀▶ indicator will not be displayed on the screen if the PIP section does not contain any PIP audio settings.

## SELECTING THE SUBTITLE LANGUAGE

You can select a desired subtitle quickly and easily with the **SUBTITLE** button.

### Using the SUBTITLE button



1. Press the **SUBTITLE** button. The subtitle changes when the button is pressed repeatedly. The subtitle languages are represented by abbreviations.
2. To remove the **Subtitle** bar, press the **CANCEL** or **RETURN** button.

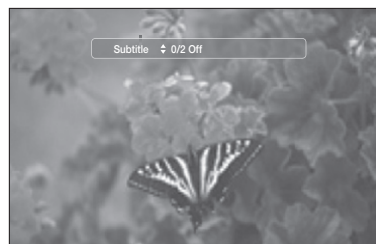

# Watching a movie

---

## SELECTING THE SUBTITLE LANGUAGE

---

### Using the INFO button

1. During playback, press the INFO button on the remote control.
2. Press the ▲▼ buttons to select Subtitle.
3. Press the ◀▶ buttons on the remote control to select the desired subtitle language.



- Depending on the Blu-ray Disc / DVD, you may be able to change the desired subtitle in the Disc Menu. Press the **DISC MENU** button.
- This function depends on what subtitles are encoded on the disc and may not be available on all Blu-ray Discs/DVDs.
- A Blu-ray Disc can contain up to 255 subtitle languages and a DVD up to 32.
- Information about the primary / secondary mode will be also displayed if the Blu-ray Disc has a PIP section.
- This function changes both the primary and secondary subtitles at the same time.
- The total number of subtitles is the sum of the primary and secondary ones.

## CHANGING THE CAMERA ANGLE

---

When a Blu-ray Disc/DVD contains multiple angles of a particular scene, you can use the ANGLE function.

### Using the ANGLE function



1. During playback, press the **INFO** button on the remote control.
2. Press the ▲▼ buttons to select **Angle**.
3. Press the ◀▶ buttons or you can use the number buttons on the remote control to select the desired angle.



- If the disc has only one angle, this feature won't work. Currently, very few discs have this feature.
- Depending on the disc, these functions may not work.

## PIP (PICTURE IN PICTURE) SETTINGS

The PIP feature allows you to view additional content (such as commentaries) in a small screen window while the movie is playing.



### Using the PIP button

1. If the current Blu-ray Disc features the PIP function, you can use the **PIP** button to turn **PIP On** or **Off**.
2. Each time you press the **PIP** button, you can toggle between **PIP On** and **PIP Off**.



- 
  - You can change detailed settings of the PIP feature in the INFO menu (see page 58: selection of secondary audio, video stream and subtitle etc.).
  - If you switch from PIP Video, PIP Audio will change automatically in accordance with PIP Video.
  - If the Blu-ray Disc supports only PIP Audio, you can just press the PIP button to turn the secondary audio on or off.

## BD-LIVE™

The Blu-ray Home Theater supports BD-LIVE which enables you to enjoy a variety of interactive service contents provided by the disc manufacturer through network connection.

### Using the BD-LIVE Disc

1. Connect the network (see pages 30~31) and check the network setup (see pages 53~57).
2. Insert a Blu-ray disc that supports BD-LIVE.
3. Select the contents provided by the disc manufacturer to enjoy the BD-LIVE.

- 
  - The way you use BD-LIVE and the features may differ, depending on the disc.
  - To use BD-LIVE, you must insert a minimum 1GB USB memory device into one of the USB slots.

# Watching a movie

## USING THE INSTANT STREAMING FEATURE PROVIDED BY NETFLIX

This Blu-ray Home Theater supports the Netflix streaming service which enables you to enjoy various movies via network connection. Before enjoying this feature, you must perform the LAN connection (see page 28).

1. With the unit in Stop mode/No Disc mode, press the **MENU** button.
2. Press the **▲▼** buttons to select **Netflix**, then press the **ENTER** or **▶** button.
3. If you don't have an account, select "no-start my FREE trial" and subscribe to <http://netflix.com/samsung> from your computer. A user with existing account can select the "yes-activate instant streaming from Netflix".

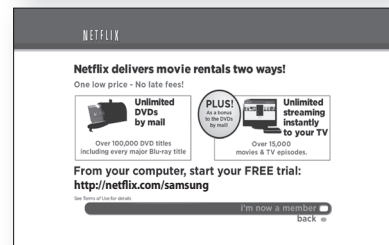
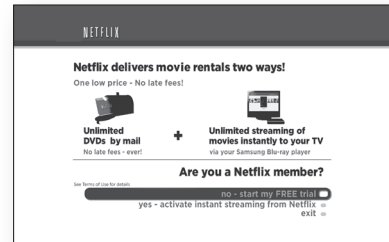

4. If you have an existing account, you will see the next window if **Yes** was selected. Select "I'm now a member".

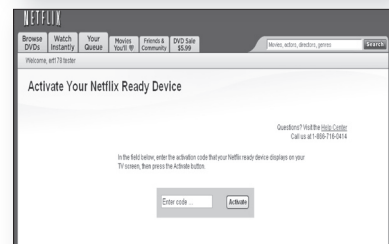
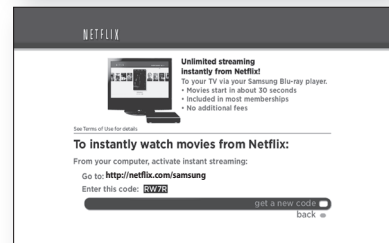

- You can also start Netflix streaming by pressing the **RED(A)** button on your remote control while the Samsung logo screen is displayed.
- Video quality of the Netflix contents (SD or HD) depends on the network speed and the original bit rate of the Netflix contents
- When you use the Netflix streaming service with this Blu-ray Home Theater, refer to the LAN connection. (See pages 28~29)
- In order to activate your Blu-ray Home Theater with Netflix with the code provided, you will need an active LAN connection to both a PC and your player. To connect the network with Blu-ray Home Theater, refer to the pages 28~29.



5. To add a movie to the Instant Queue list of this Blu-ray Home Theater, select the "Add to Instant" button on the Netflix "Watch Instantly" web page using your PC.
6. Movies you added to the Instant Queue from the web are listed.
 

Press the **ENTER** button of the remote control and select a movie to display the next screen.

  - To add the movie in Instant Queue list of this Blu-ray Home Theater, you can select "Add to Instant" button on "Watch Instantly" page of Netflix web site using your PC.



7. Press the **PLAY** button to start the playback, and the initial buffering of the streamed data is shown.

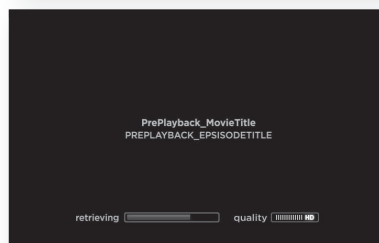

8. Press the **SCAN** button to select a scene of your choice.
  - To stop the movie or go to the instant movie list, press the upper arrow or Stop button.

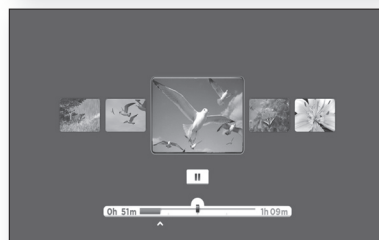

- For more information on the Netflix Instant Streaming feature visit <http://www.netflix.com/help/tv> or login to your Netflix account and click "Help" at the top of the page.

# Watching a movie

## DIVX PLAYBACK

The functions discussed on this page apply to DivX disc playback only.

### Skip Forward/Back



During playback, press the **⏮, ⏭** button.

- Goes to the next file whenever you press the **⏭** button, if there are over 2 files on the disc.
- Goes to the previous file whenever you press the **⏮** button, if there are over 2 files on the disc.

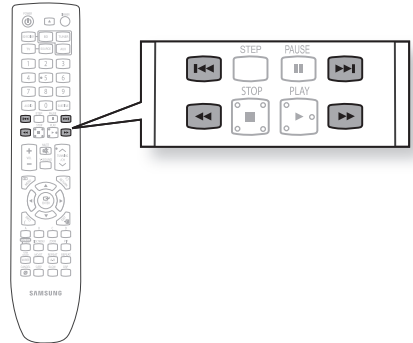

### Fast Playback



During playback, press the **⏪, ⏩** button.

To play back the disc at a faster speed, press the **⏪** or **⏩** button during playback.

- Each time you press either button, the playback speed will change as follows:  
**2x → 4x → 8x.**

### Audio Display



Press the **AUDIO** button.

- If there are multiple audio languages on a disc, you can toggle between them.
- Each time you press the button, your selection will toggle between **AUDIO (1/N, 2/N ...)**.

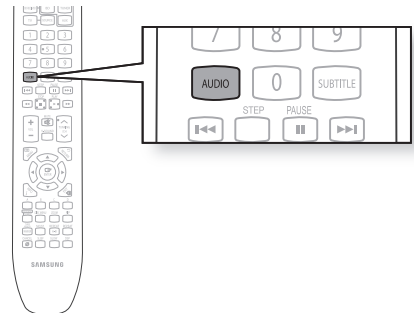

### Subtitle Display



Press the **SUBTITLE** button.

- Each time you press the button, your selection will toggle between **SUBTITLE (1/N, 2/N ...)** and **SUBTITLE OFF**.
- If the disc has only one subtitle file, it will be played automatically.
- See number 2 (Caption Function) below for more details concerning Subtitle usage with DivX discs.

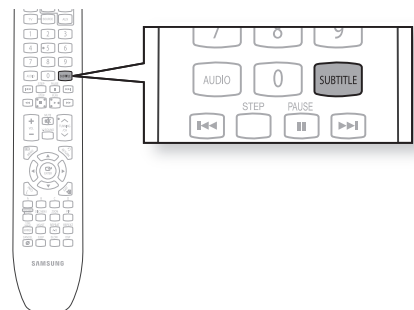



# Listening to music

## BUTTONS ON THE REMOTE CONTROL USED FOR AUDIO CD (CD-DA)/ MP3 DISC PLAYBACK

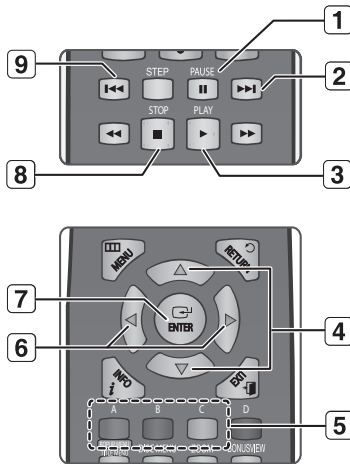

1. PAUSE button : Pauses playback.
2. SKIP ( ) button : During playback, moves to the next page in the Music List or moves to the next track in the Playlist.
3. PLAY button : Plays the currently selected track.
4. ▲▼ buttons : Selects a track(song) in the Music List or Playlist.
5. COLOR buttons
  - RED(A) button : Selects the Play Mode(Repeat) during playback.
  - GREEN(B) button : Go to Playlist from Music List.
  - YELLOW(C) button : Playlist play.
6. ◀▶ buttons
  - ◀ : Plays the applicable track, according to the current position.
  - ▶ : Moves to the menu.
7. ENTER button : Plays the selected track (song).
8. STOP button : Stops a track(song).
9. SKIP ( ) button : If you pressed this button after three seconds of playback, the current track will be replayed from the beginning. But, if you pressed this button within three seconds after playback starts, the previous track will be played. Used to move to the previous page in the Music List or Playlist.

## REPEAT AUDIO CD(CD-DA) & MP3

During playback, press the **REPEAT** or **RED(A)** button repeatedly to select the repeat mode you want.

When playing an Audio CD(CD-DA) : → → →

When playing an MP3 disc : → → →

- Normal (Audio CD(CD-DA)/MP3): Tracks on a disc are played in the order in which they were recorded on the disc.
- Repeat Track (Audio CD(CD-DA)/MP3)
- Repeat Folder (MP3)
- Random (Audio CD(CD-DA)/MP3)
  - When playing an Audio CD(CD-DA): The random option plays a disc's tracks in random order.
  - When playing an MP3 disc : The random option plays a folder's file in random order.
- Repeat All (Audio CD(CD-DA)): All tracks are repeated.

- To return to normal playback -

Press the **REPEAT** or **RED(A)** button repeatedly to return to normal playback.

# PLAYING AN AUDIO CD(CD-DA)/MP3



1. Insert an Audio CD(CD-DA) or an MP3 Disc into the disc tray.
  - For an Audio CD, the first track will be played automatically.
  - For an MP3 disc, press the ▲▼ buttons to select **Music**, then press the **ENTER** button.  
(You can listen to mp3 files using a USB storage device)
2. To move to the Music List, press the **STOP** or **RETURN** button.  
The Music List screen is displayed on your TV.
3. Press the ▲▼ buttons to select the track you want to play, then press the **ENTER** button.

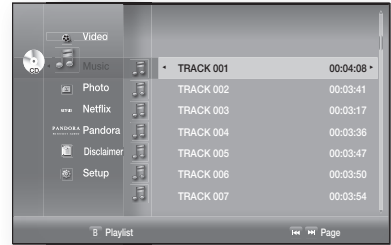
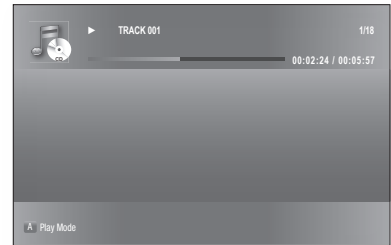

## ❖ Audio CD(CD-DA)/MP3 Screen Elements

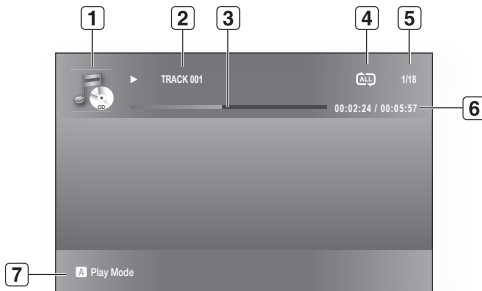

1	Displays the media type.
2	Current track (song) Displays the number of the track currently being played.
3	Play Status Bar.
4	Displays the repeat status.
5	Displays the current play index, total track number.
6	Current /Total Play Time.
7	Displays available <b>COLOR</b> buttons.

# Listening to music

## Playlist



You can create a playlist with up to 99 tracks.

1. Insert an Audio CD(CD-DA) or an MP3 Disc into the disc tray.
  - For an Audio CD, the first track will be played automatically.
  - For an MP3 disc, press the ▲▼ buttons to select **Music**, then press the **ENTER** button.  
(You can listen to mp3 files using a USB storage device)
2. To move to the Music List, press the **GREEN(B)** or **RETURN** button.  
The Music List screen is displayed.
3. Press the **GREEN(B)** button to go to the Playlist.
4. Press the ▲▼ buttons to select a track, then press the **ENTER** button to add it to the Playlist. Repeat this procedure to add additional tracks.
5. If there is an undesired track in the playlist, press the ►▲▼ button to select that track, and then press the **ENTER** button.
  - The selected track will be deleted.
6. Press the **YELLOW(C)** button to play the selected tracks.  
When the track is finished, the next track will automatically play.
7. To edit the Playlist, press the **STOP** or **RETURN** button.
8. To go to the Music List, press the **RETURN** button.

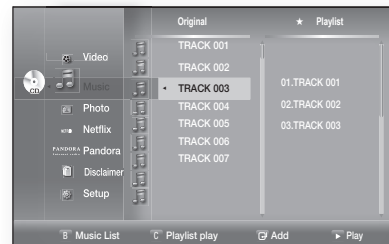
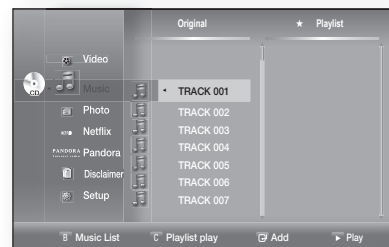
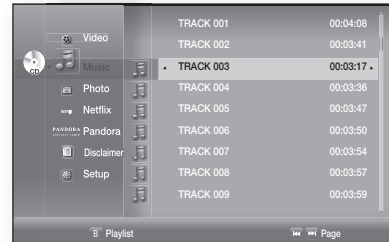

# USING THE INTERNET RADIO FEATURE PROVIDED BY PANDORA

Pandora provides music personalized to your taste.

1. With the unit in Stop mode/No Disc mode, press the **MENU** button.
2. Press the **▲▼** buttons to select **Pandora**, then press the **ENTER** or **▶** button.  
Pandora's initial screen appears.



3. To run Pandora, you need to input the activation code at <http://www.pandora.com/samsung> page with your PC. After inputting the activation code, you may have to create a new account if you don't have one yet. If you already have an account, you can use the existing account.

4. It automatically shows the list of stations created from the web or player, and plays music.
5. Press the **RED(A)** button while the highlight is on the station list to display the create station window.

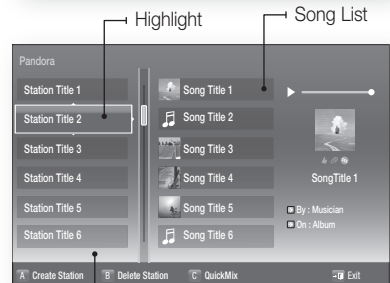

6. Enter the keyword and press the **BLUE(D)** button to display the search result.  
(The station keyword entered should be a music genre, artist, music title, etc.)

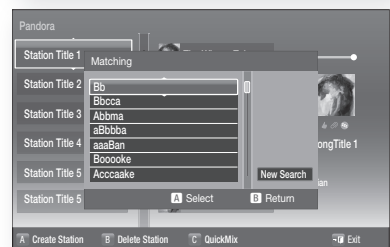
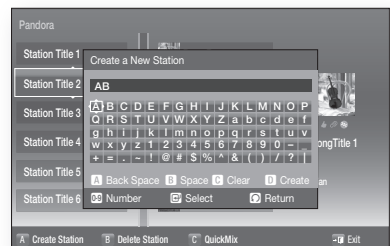

# Listening to music

## USING THE INTERNET RADIO FEATURE PROVIDED BY PANDORA

7. Press the **GREEN(B)** button while the highlight is on the station list to delete the selected station.

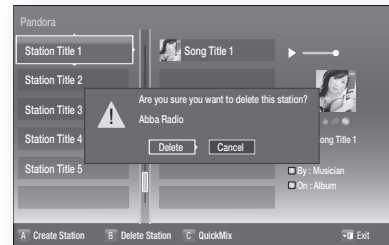

8. You can edit your song list by using color buttons of the remote control while the highlight is on the song list.

- **RED(A)** : Thumbs Up. By indicating your preference to the server, it plays more songs you love.
- **GREEN(B)** : Thumbs Down. By indicating your dislike to the server, it plays fewer songs you don't like.
- **YELLOW(C)** : Bookmark. It bookmarks the selected song.
  - The bookmarked songs can be found on your PC by visiting [www.pandora.com](http://www.pandora.com) and viewing "My Profile".
- **BLUE(D)** : Sleep Song. It excludes the selected song from the station for a month.

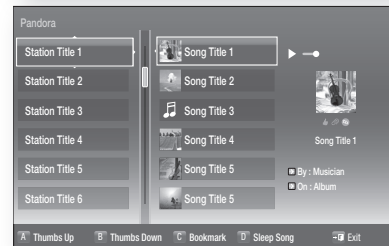

- The [www.pandora.com](http://www.pandora.com) server reflects the changes made on your player.
- In order to activate your Blu-ray Home Theater with Pandora music with the code provided, you will need an active LAN connection to both a PC and your player. To connect the network with Blu-ray Home Theater, refer to the pages 28~29.
- For further information on Pandora service or to unsubscribe the Pandora service, email "[samsung-support@pandora.com](mailto:samsung-support@pandora.com)".



# Viewing a picture

## VIEWING A PICTURE

1. Insert a JPEG disc into the Disc Slot .
  - The Menu screen is displayed.
2. Press the ▲▼ buttons to select **Photo**, then press the **ENTER** button.
  - The Photo List is displayed.
3. Press the ▲▼ buttons to select a picture.
  - To see the next page, press the SKIP (▶▶) button.
  - To see the previous page, press the SKIP (◀◀) button.

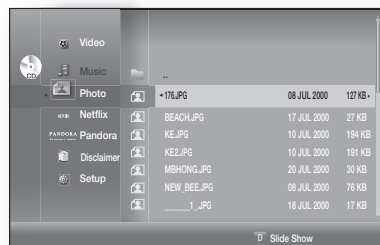

## SLIDE SHOW/SPEED

To setup, follow steps 1 and 2 above.

3. Press the **BLUE(D)** button.
  - The slide show starts.
4. When the SlideShow starts, press the **BLUE(D)** button to adjust the play speed.
  - Each time you press the button, the play speed will increase accordingly.



- To stop the Slide Show -

Press the **STOP** or **RETURN** button.

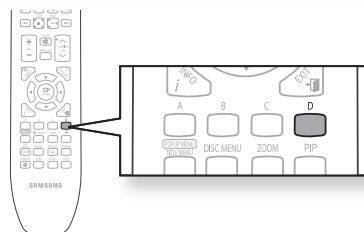
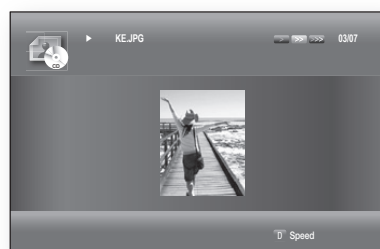

## ROTATE

To setup, follow steps 1 and 3 above.

4. Press the **ENTER** button.
5. Use the **RED(A)** and **GREEN(B)** buttons to rotate the image in a desired direction.

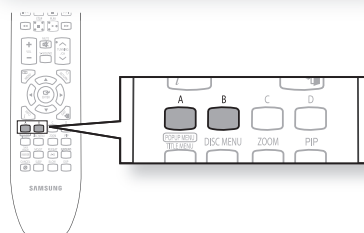
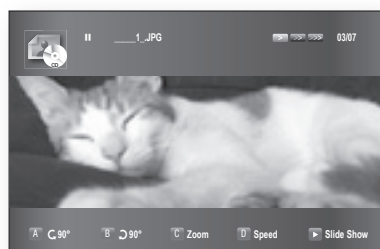

# Viewing a picture

## ZOOM

To setup, follow steps 1 to 3 in "Viewing a Picture" on page 73.

4. Press the **ENTER** button.

5. Press the **YELLOW(C)** button.

6. Use the **YELLOW(C)** or **ENTER** button to zoom the image in/out.

- To move the area -

Press the **▲▼◀▶** buttons to the area you want to enlarge.

- To stop the Zoom -

Press the **YELLOW(C)** button.

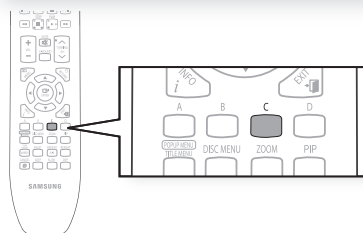

## GO TO PHOTO LIST

To setup, follow steps 1 to 3 in "Viewing a Picture" on page 73.

4. Press the **ENTER** button.

5. To go Photo List, press the **RETURN** or **STOP** button.

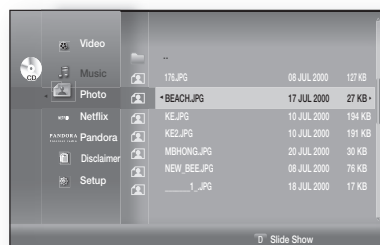
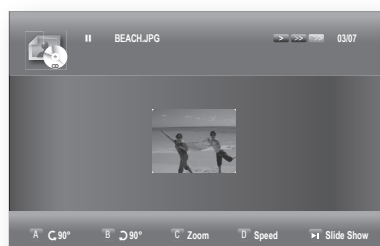

# Using the USB function

## PLAYING MEDIA FILES USING THE USB HOST FEATURE

You can enjoy media files such as pictures and music saved on an MP3 player, USB memory stick or digital camera.

1. Connect the USB device to the USB port on the side of the unit.
2. **USB Connected** appears on the display screen and then disappears.
3. USB icon is displayed on the Setup Menu.

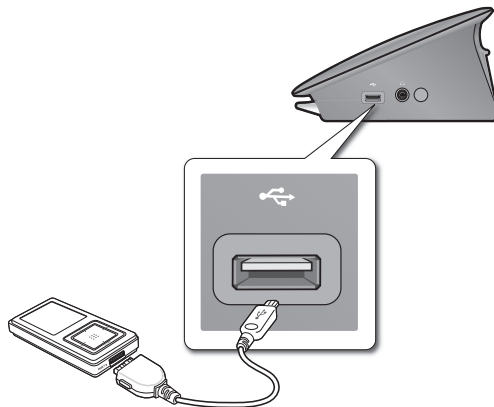

## Safe USB Removal

To prevent damage to the data stored in the USB device, perform safe removal before disconnecting the USB cable.

- Press the **YELLOW(C)** button. The display will show **Now**. You can remove USB safely.
- Remove the USB cable.

## Skip Forward/Back

During playback, press the **⏮**, **⏭** button.

- When there is more than one file and you press the **⏭** button, the next file is selected.
- When there is more than one file and you press the **⏮** button, the previous file is selected.

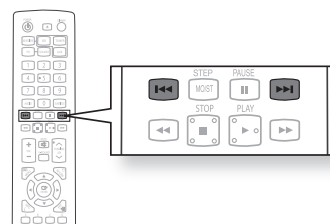

# Using the USB function

## USB Host Specification

<b>USB Host Specification</b>	<ul style="list-style-type: none"><li>• Supports USB 1.1 or USB 2.0 compliant devices.</li><li>• Supports devices connected using the USB A type cable.</li><li>• Supports UMS (USB Mass Storage Device) V1.0 compliant devices.</li><li>• Supports the device of which the connected drive is formatted in the FAT(FAT, FAT16, FAT32) file system.</li></ul>
<b>Non-compliance</b>	<ul style="list-style-type: none"><li>• Does not support a device that requires installing a separate driver on the PC (Windows).</li><li>• Does not support connection to a USB hub.</li><li>• A USB device that is connected using the USB extension cable may not be recognized.</li><li>• A USB device requiring a separate power source needs to be connected to the player with the separate power connection.</li></ul>
<b>Operational Limitations</b>	<ul style="list-style-type: none"><li>• If the connected device has multiple drives (or partitions) installed, only one drive (or partition) can be connected.</li><li>• A device supporting USB 1.1 alone may cause a difference in the picture quality, depending on the device.</li></ul>

## USB Devices that can be used with the Home Theater

1. USB Storage Device
2. MP3 Player
3. Digital Camera
4. Removable HDD
  - Removable HDDs equipped with less than 160 Gbytes are supported. Removable HDDs equipped with 160Gbytes or more may not be recognized, depending on the device.
  - If the connected device does not work due to insufficient power supply, you can use a separate power cable to supply power so that it can work properly. The connector of the USB cable may differ, depending on the manufacturer of the USB device.
5. USB card Reader: One slot USB card reader and Multi slot USB card reader.
  - Depending on the manufacturer. the USB card reader may not be supported.
  - If you install multiple memory devices into a multi card reader, you may experience problems.

## Supported file Formats

Format	File name	File extension	Bit rate	Version	Pixel	Sampling Frequency
<b>Still Picture</b>	JPG	JPG .JPEG	–	–	640x480	–
<b>Music</b>	MP3	.MP3	80~384kbps	–	–	44.1kHz

- CBI (Control/Bulk/Interrupt) is not supported.
- Digital Cameras that use PTP protocol or require additional program installation when connected to a PC are not supported.
- A device using NTFS file system is not supported. (Only FAT 16/32 (File Allocation Table 16/32) file system is supported.)
- Does not operate with Janus enabled MTP (Media Transfer Protocol) devices.

## LISTENING TO RADIO

1. Press the **TUNER** button to select the FM band.
2. Tune in to the desired station.
  - Automatic Tuning 1 : When the **SKIP** (⏮ ⏭) button is pressed, a preset broadcast station is selected.
  - Automatic Tuning 2 : Press and hold the **TUNING/CH** (↶ ↷) button to automatically search for active broadcasting stations.
  - Manual Tuning : Briefly press the **TUNING/CH** (↶ ↷) button to increase or decrease the frequency incrementally.

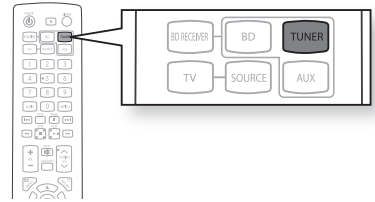

### Main Unit

1. Press the **FUNCTION** button to select the FM band.
2. Select a broadcast station.
  - Automatic Tuning 1 : Press the **STOP** (■) button to select **PRESET** and then press the **SKIP** (⏮ ⏭) button to select the preset station.
  - Automatic Tuning 2 : Press the **STOP** (■) button to select **MANUAL** and then press and hold the **SKIP** (⏮ ⏭) button to automatically search the band.
  - Manual Tuning : Press the **STOP** (■) button to select **MANUAL** and then briefly press the **SKIP** (⏮ ⏭) button to tune in to a lower or higher frequency.

### Mono/Stereo

Press the **MO/ST** button to listen in Mono/Stereo.

- Each time the button is pressed, the sound switches between **STEREO** and **MONO**.
- In a poor reception area, select **MONO** for a clear, interference-free broadcast.

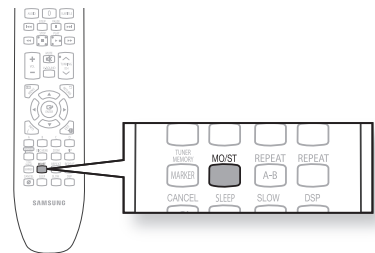

## PRESETTING STATIONS

Example : Presetting FM 89.10 in the memory

1. Press the **TUNER** button to select the FM band.
2. Press the **TUNING/CH** (↶ ↷) button to select <89.10>.
3. Press the **TUNER MEMORY** button.
  - **PRGM** flashes in the display.
4. Press the **SKIP** (⏮ ⏭) button to select preset number.
  - You can select between 1 and 15 presets.
5. Press the **TUNER MEMORY** button again.
  - Press the **TUNER MEMORY** button before **PRGM** disappears from the display.
  - **PRGM** disappears from the display and the station is stored in memory.
6. To preset another station, repeat steps 2 to 5.
  - To tune in to a preset station, press the **SKIP** (⏮ ⏭) button on the remote control to select a channel.

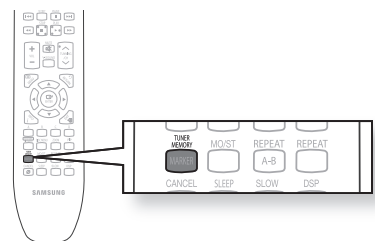

# Using BLUETOOTH

You can use a Bluetooth device to enjoy music with high quality stereo sound, all without wires!

## WHAT IS BLUETOOTH?

Bluetooth is a new technology that enables Bluetooth-compliant devices to easily interconnect with each other using a short wireless connection.

- A Bluetooth device may cause a noise or malfunction, depending on usage.
  - When a part of the body is in contact with the receiving/transmitting system of the Bluetooth device or the Blu-ray Home Theater.
  - Electrical variation from obstructions caused by a wall, corner or office partitioning.
  - Electrical interference from same frequency-band devices including medical equipment, microwave oven and wireless LAN.
- Pair the Blu-ray Home Theater with the Bluetooth device while maintaining a close distance.
- The further the distance is between Blu-ray Home Theater and Bluetooth device, the worse the quality is. If the distance exceeds the Bluetooth operational range, the connection is lost.
- The Blu-ray Home Theater supports Middle Quality SBC data(237kbps@48kHz) and High Quality SBC data(328kbps@44.1kHz).
- In poor reception-sensitivity areas, the Bluetooth connection may not work properly.
- The Blu-ray Home Theater has an effective reception range of up to 10 meters in all directions if there are no obstacles. The connection will be automatically cut off if the distance is out of this range. Even within this range, the sound quality may be deteriorated by obstacles such as walls or doors.

## TO CONNECT THE BLU-RAY HOME THEATER TO A BLUETOOTH DEVICE

Check if the Bluetooth device supports the Bluetooth-compliant stereo headset function.

1. Press the **FUNCTION** button on the front panel of the Blu-ray Home Theater repeatedly until "BT AUDIO" appears.
  - The mode switches as follows :  
**BD/DVD → D.IN → AUX → BT AUDIO → FM.**
  - "READY" appears on the front display.
2. Select the Bluetooth menu on Bluetooth device you want to connect. (refer to Bluetooth device's user manual)
3. Select the Stereo headset menu on the Bluetooth device.
  - You will see a list of scanned devices.
4. Select "Samsung BD Theater" from the searched list.
  - When the Blu-ray Home Theater is connected to the Bluetooth device, the Blu-ray Home Theater will display "Connect" on the front display, followed by the device name of the connected Bluetooth device.
  - The Blu-ray Home Theater connection is complete.
5. Play music on the connected device.
  - You can listen to the music playing on the connected Bluetooth device over the Blu-ray Home Theater.

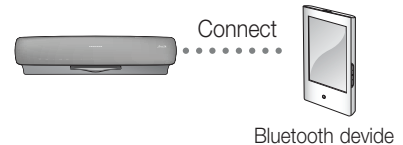
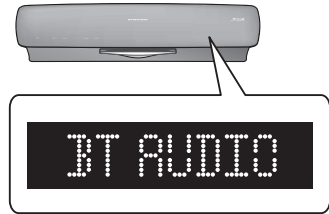

- You may be required to enter a PIN code(password) when connecting the Bluetooth device to the Blu-ray Home Theater. If the PIN code input window appears, enter <0000>.
- The Blu-ray Home Theater may control play related function only when connected device supports the function.
- The Blu-ray Home Theater supports Middle Quality SBC data(237kbps@48kHz) and High Quality SBC data(328kbps@44.1kHz).

### To disconnect the Bluetooth device from the Blu-ray Home Theater

You can disconnect the Blu-ray Home Theater from the Bluetooth device. (refer to Bluetooth device's user's manual)

- The Blu-ray Home Theater will be disconnected.
- When the Blu-ray Home Theater is disconnected from the Bluetooth device, the Blu-ray Home Theater will display "READY" on the front display.

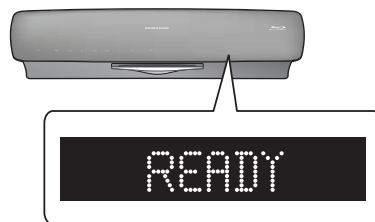

### To disconnect the Blu-ray Home Theater from the Bluetooth device

Press the **FUNCTION** button on the front panel of the Blu-ray Home Theater to switch from "BT AUDIO" to another mode.

- The connected Bluetooth device will wait a certain time for response from the Blu-ray Home Theater before terminating the connection. (Disconnection time may differ, depending on the Bluetooth device)
- The currently connected device will be disconnected.



- In Bluetooth connection mode, the Bluetooth connection will be lost if the distance between the Blu-ray Home Theater and the Bluetooth device exceeds (33 feet). If the distance is returned to the effective range or you restart the Bluetooth device, the Bluetooth connection can be restored.
- With some Bluetooth devices, some functions may not work properly.
- Operational specifications for corresponding devices such as mobile phones and MP3 players may differ when pressing the buttons -play, pause, stop, ff, rew, next, back- on the remote controller.

# Using an iPod

You can enjoy playback of your iPod using the supplied remote control.

## LISTENING TO MUSIC

You can play music files stored in the iPod player by connecting it to the Blu-ray Home Theater.

1. Connect the iPod dock connector to the iPod jack on the Blu-ray Home Theater.
2. Place the iPod in the Dock.
  - Your iPod is automatically turned on.
  - "iPod Connected" message appears on the TV screen.
3. Press the **MENU** button on the remote control.
4. Press the **◀, ▼** buttons on the remote control to select iPod mode.
5. Press the **▶, ▲, ▼** buttons on the remote control to select **Music** and press the **ENTER** button.
  - The **Music** categories appear.
6. Press the **▲, ▼** buttons desired category and press the **ENTER** button.
  - The music list appears on your TV.
7. Press the **▲, ▼** buttons to select the music file to play and press the **ENTER** button.
  - The music will start with a new screen which shows the song title, time, artist, and progress bar.
8. You can use the remote control or main unit to control simple playback functions such as **PLAY, PAUSE, STOP, ⏮ / ⏭**, **⏪ / ⏩** and **REPEAT**.
  - Press the **RED(A)** button to select a desired play mode.

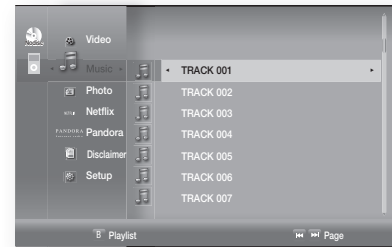
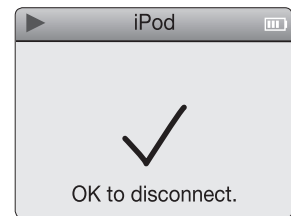

### ❖ iPod Playback Screen Elements

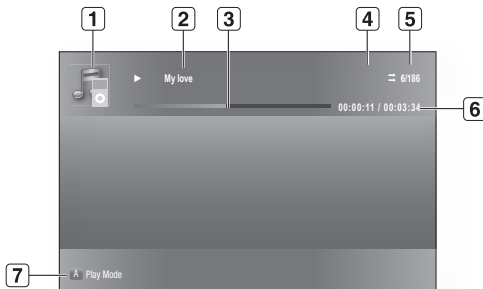

- |   |  |
|---|--|
| 1 | Displays the media type.   |
| 2 | Current track (song)<br>Displays the number of the track currently being played. |
| 3 | Play Status Bar.   |
| 4 | Displays the repeat status.  |
| 5 | Displays the current play index, total track number.                             |
| 6 | Current /Total Play Time.  |
| 7 | Displays available <b>COLOR</b> buttons.   |



To move to the Music List and select a track:

1. Press the **MENU** or **STOP** button.
  - It stops playing and returns to the music list.
2. Press the **▲**, **▼** buttons to select the file you want to play and press the **ENTER** button.
  - Press the **RETURN** or **◀** button to return to the parent menu.

## iPod Music categories

File information including the artist name, album name, music title and genre will be displayed according to the ID3 Tag information on the appropriate music file.

**Now Playing** : Plays a recently played file or moves to the playback screen of the current file.

**Artists** : To play by artist.

**Songs** : To play in numeric or alphabetical order

**Playlists** : To play by Playlist.

**Albums** : To play by album.

**Genres** : To play by genre.

**Composer** : To play by composer.



- See page 24 for compatible iPods.  
Compatibility depends on the software version of your iPod.
- The category list may differ, depending on the iPod model.
- **What is an ID3 Tag?**  
This is what is attached to an MP3 to carry information relevant to the file such as the title, artist, album, year, genre and a comment field.

# Using an iPod

## WATCHING A MOVIE

You can play video files stored in the iPod player by connecting it to the Blu-ray Home Theater.

1. Connect the iPod dock connector to the iPod jack on the Blu-ray Home Theater.
2. In the iPod screen, move to **Videos > Settings** and set the **TV Out** option to **On**.
3. Place the iPod in the Dock.
  - “iPod Connected” message appears on the TV screen.
4. Press the ◀, ▼ buttons on the remote control to select iPod mode.
5. Press the ▶, ▲, ▼ buttons on the remote control to select **Video** and press the **ENTER** button.
6. Press the ▲, ▼ buttons on the remote control to select **Movies** and press the **ENTER** button.
  - The video list appears on your TV.
7. Press the ▲, ▼ buttons to select the video file to play and press the **ENTER** button.
  - Video file of the iPod player will be played on the TV screen.
8. You can use the remote control or main unit to control simple playback functions such as **PLAY, PAUSE, STOP, ⏮ / ⏭** and **⏪ / ⏩**.
  - If you press the **PREV** button within 2 seconds after the playback, the player will play previous file.  
If you press the **PREV** button 2 seconds or later after the playback, the player will move to the start screen of the current file.
  - Press the **NEXT** button to play next file.

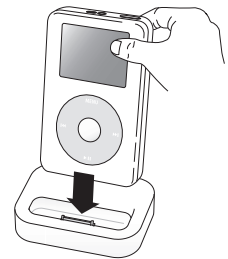
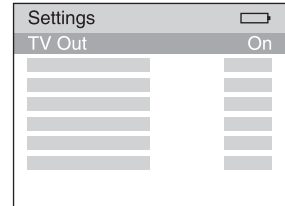

To move to the Video List and select a file:

1. Press the **MENU** or **STOP** button.
  - It stops playing and returns to the video list.
2. Press the ▲, ▼ buttons to select the file you want to play and press the **ENTER** button.
  - Press the **RETURN** or ◀ button to return to the parent menu.

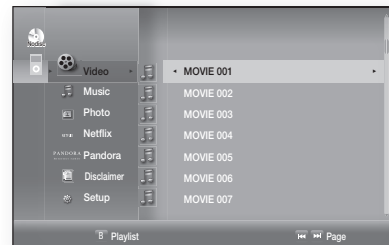

- See page 24 for compatible iPods. Compatibility depends on the software version of your iPod.
- You must have the VIDEO output connected to your TV to view iPod video (See page 23).
- If you want to iPod video via VIDEO output, if HDMI CEC is set to on, turn it off.
- When the current file is played to the end, the next file will be played automatically. To play the next file, select a file to play in the list screen of the iPod player.
- No other screen than the playback one will appear on the TV screen. Check other screens on the iPod player.
- If connected iPod does not support video playback, “Cannot play video files saved on this iPod” message appears when you select the Video menu.

# Convenient function

## SLEEP TIMER FUNCTION

You can set the time that the Blu-ray Home Theater will shut itself off.

Press the **SLEEP** button.

- Each time the button is pressed, the preset time changes as follows :  
SLP 10 → 20 → 30 → 60 → 90 → 120 → 150 → OFF.

To confirm the sleep timer setting, press the **SLEEP** button.

- The remaining time before the Blu-ray Home Theater will shut itself off is displayed.
- Pressing the button again changes the sleep time from what you have set earlier.

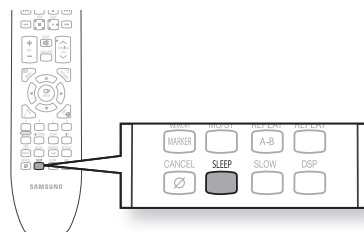

To cancel the sleep timer, press the **SLEEP** button until **OFF** appears on the display.

## ADJUSTING DISPLAY BRIGHTNESS

You can adjust the brightness of the display on the main unit so it won't interfere with your movie viewing.

Press the **DIMMER** button.

- Each time the button is pressed, the brightness of front display will be adjusted.

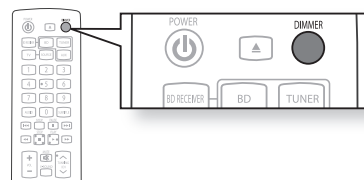

## MUTE FUNCTION

This is useful when answering a doorbell or telephone call.

Press the **MUTE** button.

- **MUTE** appears in the display.
- To restore the sound, press the **MUTE** button again.

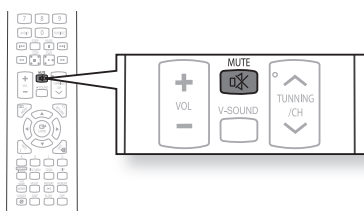

# Troubleshooting

Refer to the chart below when this unit does not function properly. If the problem you are experiencing is not listed below or if the instruction below does not help, turn off the unit, disconnect the power cord, and contact Samsung Electronics at 1-800-SAMSUNG.

SYMPTOM	Check/Remedy
<b>I cannot eject the disc.</b>	<ul style="list-style-type: none"> <li>• Is the power cord plugged securely into the outlet?</li> <li>• Turn off the power and then turn it back on.</li> </ul>
<b>The iPod fails to connect.</b>	<ul style="list-style-type: none"> <li>• Check the condition of the iPod connector and Dock.</li> <li>• Keep the iPod S/W version up to date.</li> </ul>
<b>Playback does not start.</b>	<ul style="list-style-type: none"> <li>• Check the region number of the BD/DVD. BD/DVD discs purchased from abroad may not be playable.</li> <li>• CD-ROMs and DVD-ROMs cannot be played on this Blu-ray Home Theater.</li> <li>• Make sure that the rating level is correct.</li> </ul>
<b>Playback does not start immediately when the Play/Pause button is pressed.</b>	<ul style="list-style-type: none"> <li>• Are you using a deformed disc or a disc with scratches on the surface?</li> <li>• Wipe the disc clean.</li> </ul>
<b>Sound is not produced.</b>	<ul style="list-style-type: none"> <li>• No sound is heard during fast playback, slow playback, and step motion playback.</li> <li>• Are the speakers connected properly? Is the speaker setup correctly customized?</li> <li>• Is the disc severely damaged?</li> </ul>
<b>Sound can be heard only from a few speakers and not all 3.</b>	<ul style="list-style-type: none"> <li>• On certain BD/DVD discs, sound is output from the front speakers only.</li> <li>• Check if the speakers are connected properly.</li> <li>• Adjust the volume.</li> <li>• When listening to a CD or radio, sound is output to the front speakers only.</li> </ul>
<b>The remote control does not work.</b>	<ul style="list-style-type: none"> <li>• Is the remote control being operated within its operation range of angle and distance?</li> <li>• Are the batteries drained?</li> <li>• Have you selected the mode(TV/BD) functions of the remote control (TV or BD) correctly?</li> </ul>
<ul style="list-style-type: none"> <li>• Disc is rotating but no picture is produced.</li> <li>• Picture quality is poor and picture is shaking.</li> </ul>	<ul style="list-style-type: none"> <li>• Is the TV power on?</li> <li>• Are the video cables connected properly?</li> <li>• Is the disc dirty or damaged?</li> <li>• A poorly manufactured disc may not be playable.</li> </ul>
<b>Audio language and subtitles do not work.</b>	<ul style="list-style-type: none"> <li>• Audio language and subtitles will not work if the disc does not contain them.</li> </ul>
<b>Menu screen does not appear even when the menu function is selected.</b>	<ul style="list-style-type: none"> <li>• Are you using a disc that does not contain menus?</li> </ul>

SYMPTOM	Check/Remedy
Aspect ratio cannot be changed.	<ul style="list-style-type: none"> <li>You can play 16:9 BD/DVDs in 16:9 Wide mode, 4:3 Letter Box mode, or 4:3 Pan - Scan mode, but 4:3 BD/DVDs can be seen in 4:3 ratio only. Refer to the Blu-ray Disc jacket and then select the appropriate function.</li> </ul>
<ul style="list-style-type: none"> <li>The main unit is not working. (Example: The power goes out or a strange noise is heard.)</li> <li>The Blu-ray Home Theater is not working normally.</li> </ul>	<ul style="list-style-type: none"> <li>Turn off the power and hold the <b>STOP</b> (■) button on the main unit for longer than 5 seconds.</li> </ul> <p>Using the RESET function will erase all stored settings. Do not use this unless necessary.</p>
The password for rating level has been forgotten.	<ul style="list-style-type: none"> <li>While (NO DISC) message appears on the display of main unit, hold the main unit's <b>STOP</b> (■) button for longer than 5 seconds. <b>INITIAL</b> appears on the display and all settings will return to the default values.</li> <li>Press the <b>POWER</b> button.</li> </ul> <p>Using the RESET function will erase all stored settings. Do not use this unless necessary.</p>
Can't receive radio broadcasts.	<ul style="list-style-type: none"> <li>Is the antenna connected properly?</li> <li>If the antenna's input signal is weak, install an external FM antenna in an area with good reception.</li> </ul>
While listening to TV audio through the Blu-ray Home Theater, no sound is heard.	<ul style="list-style-type: none"> <li>If the EJECT button is pressed while listening to TV audio using the D.IN or AUX functions, the BD/DVD functions are turned on and this mutes the TV audio.</li> </ul>
The ⓪ icon appears on screen.	<ul style="list-style-type: none"> <li>The features or action cannot be completed at this time because:             <ol style="list-style-type: none"> <li>The BD/DVD's software restricts it.</li> <li>The BD/DVD's software doesn't support the feature (e.g., angles)</li> <li>The feature is not available at the moment.</li> <li>You've requested a title or chapter number or search time that is out of range.</li> </ol> </li> </ul>
If the HDMI output is set to a resolution your TV cannot support (for example, 1080p), you may not see a picture on your TV.	<ul style="list-style-type: none"> <li>Press the <b>STOP</b> (■) button (in front panel) for more than 5 seconds with no disc inside. All settings will revert to the factory settings.</li> </ul>
No HDMI output.	<ul style="list-style-type: none"> <li>Check the connection between the TV and the HDMI jack of the Blu-ray Home Theater.</li> <li>Check if your TV supports 480p/720p/1080i/1080p HDMI input resolution.</li> </ul>
Abnormal HDMI output screen.	<ul style="list-style-type: none"> <li>If random noise appears on the screen, it means that TV does not support HDCP (High-bandwidth Digital Content Protection).</li> </ul>
Cannot search for other access points using USB wireless	<ul style="list-style-type: none"> <li>Check the Proxy is Off(Setup -&gt; Network Setup -&gt; Proxy)</li> </ul>

# Appendix

## CAUTIONS ON HANDLING AND STORING DISCS

Small scratches on the disc may reduce sound and picture quality or cause skipping.  
Be especially careful not to scratch discs when handling them.

### Handling discs

Do not touch the playback side of the disc.  
Hold the disc by the edges so that fingerprints will not get on the surface.  
Do not stick paper or tape on the disc.

### Disc Storage

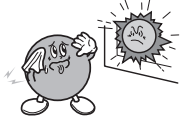
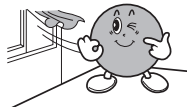
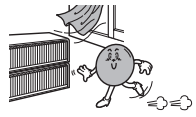
Do not keep in direct sunlight	Keep in a cool ventilated area	Keep in a clean Protection jacket. Store vertically.
		

-  Do not allow the discs to become contaminated with dirt.
- Do not load cracked or scratched discs.

### Handling and Storing Discs

When you get fingerprints or dirt on the disc, clean it with a mild detergent diluted in water and wipe with a soft cloth.

- When cleaning, wipe gently from the inside to the outside of the disc

-  Condensation may form if warm air comes into contact with cold parts inside the player. When condensation forms inside the player, the player may not operate correctly. If this occurs, remove the disc and let the player stand for 1 or 2 hours with the power on.

# SPECIFICATIONS

General	Power Requirements	AC 120V, 60Hz		
	Power Consumption	100 W		
	Weight	7.0 lbs		
	Dimensions	18.1 (W) x 7.6 (D) x 4.3 (H) inches		
	Operating Temperature Range	+41°F to +95°F		
	Operating Humidity Range	10 % to 75 %		
Disc	BD (Blu-ray Disc)	Reading Speed : 4.917m/sec		
	DVD (Digital Versatile Disc)	Reading Speed : 3.49 ~ 4.06 m/sec. Approx. Play Time (Single Sided, Single Layer Disc) : 135 min.		
	CD : 5 inches (COMPACT DISC)	Reading Speed : 4.8 ~ 5.6 m/sec. Maximum Play Time : 74 min.		
	CD : 3 1/2 inches (COMPACT DISC)	Reading Speed : 4.8 ~ 5.6 m/sec. Maximum Play Time : 20 min.		
Video Output	Composite Video	1 channel : 1.0 Vp-p (75 Ω load) Blu-ray Disc : 480i DVD : 480i		
	Component Video	Y : 1.0 Vp-p (75 Ω load) Pr : 0.70 Vp-p (75 Ω load) Pb : 0.70 Vp-p (75 Ω load) Blu-ray Disc : 1080i, 720p, 480p, 480i DVD : 480p, 480i		
Video/Audio	HDMI	1080p, 1080i, 720p, 480p PCM multichannel audio, Bitstream audio, PCM audio		
Amplifier	Front speaker output	133W x 2(3Ω)		
	Subwoofer speaker output	134W(3Ω)		
	Frequency response	Analog input	20Hz~20kHz (±3dB)	
		Digital input	20Hz~44kHz (±3dB)	
	S/N Ratio	70dB		
	Channel separation	60dB		
Input sensitivity	(AUX)500mV			
Speaker	Speaker system	2.1CH speaker system		
		Front	Subwoofer	
	Impedance	3 Ω	3 Ω	
	Frequency range	140Hz~20kHz	40Hz~160Hz	
	Output sound pressure level	88dB/W/M	90dB/W/M	
	Rated input	133W	134W	
	Maximum input	266W	268W	
	Dimensions (W x H x D)	Front : 7.3 x 24.6 x 7.3 inches Subwoofer : 10.1 x 10.1 x 11.7 inches		
	Weights	Front : 4 lbs		
		Subwoofer : 9.7 lbs		

\*: Nominal specification

- Samsung Electronics Co., Ltd reserves the right to change the specifications without notice.
- Weight and dimensions are approximate.

- ❖ This product uses parts of the software from the Independent JPEG Group.
  - ❖ This product uses parts of the software owned by the Freetype Project ([www.freetype.org](http://www.freetype.org)).
  - ❖ This product uses some software programs which are distributed under the GPL/LGPL license.
  - ❖ This Product uses some software programs which are distributed under the OpenSSL license.
- Accordingly, the following GPL and LGPL software source codes that have been used in this product can be provided after asking to [vdswmanager@samsung.com](mailto:vdswmanager@samsung.com).  
GPL software: Linu Kernel, Busybox, Binutils  
LGPL software: uClibc, directfb

## The GNU General Public License (GPL)

### Version 2, June 1991

Copyright (C) 1989, 1991 Free Software Foundation, Inc.  
59 Temple Place, Suite 330, Boston, MA 02111-1307 USA

Everyone is permitted to copy and distribute verbatim copies of this license document, but changing it is not allowed.

#### Preamble

The licenses for most software are designed to take away your freedom to share and change it. By contrast, the GNU General Public License is intended to guarantee your freedom to share and change free software--to make sure the software is free for all its users. This General Public License applies to most of the Free Software Foundation's software and to any other program whose authors commit to using it. (Some other Free Software Foundation software is covered by the GNU Library General Public License instead.) You can apply it to your programs, too.

When we speak of free software, we are referring to freedom, not price. Our General Public Licenses are designed to make sure that you have the freedom to distribute copies of free software (and charge for this service if you wish), that you receive source code or can get it if you want it, that you can change the software or use pieces of it in new free programs; and th at you know you can do these things.

To protect your rights, we need to make restrictions that forbid anyone to deny you these rights or to ask you to surrender the rights. These restrictions translate to certain responsibilities for you if you distribute copies of the software, or if you modify it.

For example, if you distribute copies of such a program, whether gratis or for a fee, you must give the recipients all the rights that you have. You must make sure that they, too, receive or can get the source code. And you must show them these terms so they know their rights.

We protect your rights with two steps: (1) copyright the software, and (2) offer you this license which gives you legal permission to copy, distribute and/or modify the software.

Also, for each author's protection and ours, we want to make certain that everyone understands that there is no warranty for this free software. If the software is modified by someone else and passed on, we want its recipients to know that what they have is not the original, so that any problems introduced by others will not reflect on the original authors' reputations.

Finally, any free program is threatened constantly by software patents. We wish to avoid the danger that redistributors of a free program will individually obtain patent licenses, in effect making the program proprietary. To prevent this, we have made it clear that any patent must be licensed for everyone's free use or not licensed at all.

The precise terms and conditions for copying, distribution and modification follow.

#### TERMS AND CONDITIONS FOR COPYING, DISTRIBUTION AND MODIFICATION

**0.** This License applies to any program or other work which contains a notice placed by the copyright holder saying it may be distributed under the terms of this General Public License. The "Program", below, refers to any such program or work, and a "work based on the Program" means either the Program or any derivative work under copyright law: that is to say, a work containing the Program or a portion of it, either verbatim or with modifications and/or translated into another language. (Hereinafter, translation is included without limitation in the term "modification".) Each licensee is addressed as "you".

Activities other than copying, distribution and modification are not covered by this License; they are outside its scope. The act of running the Program is not restricted, and the output from the Program is covered only if its contents constitute a work based on the Program (independent of having been made by running the Program). Whether that is true depends on what the Program does.



Activities other than copying, distribution and modification are not covered by this License; they are outside its scope. The act of running the Program is not restricted, and the output from the Program is covered only if its contents constitute a work based on the Program (independent of having been made by running the Program). Whether that is true depends on what the Program does.

**1. You may copy and distribute verbatim copies of the Program's source code as you receive it, in any medium, provided that you conspicuously and appropriately publish on each copy an appropriate copyright notice and disclaimer of warranty; keep intact all the notices that refer to this License and to the absence of any warranty; and give any other recipients of the Program a copy of this License along with the Program.**

You may charge a fee for the physical act of transferring a copy, and you may at your option offer warranty protection in exchange for a fee.

**2. You may modify your copy or copies of the Program or any portion of it, thus forming a work based on the Program, and copy and distribute such modifications or work under the terms of Section 1 above, provided that you also meet all of these conditions:**

- a) You must cause the modified files to carry prominent notices stating that you changed the files and the date of any change.
- b) You must cause any work that you distribute or publish, that in whole or in part contains or is derived from the Program or any part thereof, to be licensed as a whole at no charge to all third parties under the terms of this License.
- c) If the modified program normally reads commands interactively when run, you must cause it, when started running for such interactive use in the most ordinary way, to print or display an announcement including an appropriate copyright notice and a notice that there is no warranty (or else, saying that you provide a warranty) and that users may redistribute the program under these conditions, and telling the user how to view a copy of this License. (Exception: if the Program itself is interactive but does not normally print such an announcement, your work based on the Program is not required to print an announcement.)

These requirements apply to the modified work as a whole. If identifiable sections of that work are not derived from the Program, and can be reasonably considered independent and separate works in themselves, then this License, and its terms, do not apply to those sections when you distribute them as separate works. But when you distribute the same sections as part of a whole which is a work based on the Program, the distribution of the whole must be on the terms of this License, whose permissions for other licensees extend to the entire whole, and thus to each and every part regardless of who wrote it.

Thus, it is not the intent of this section to claim rights or contest your rights to work written entirely by you; rather, the intent is to exercise the right to control the distribution of derivative or collective works based on the Program.

In addition, mere aggregation of another work not based on the Program with the Program (or with a work based on the Program) on a volume of a storage or distribution medium does not bring the other work under the scope of this License.

**3. You may copy and distribute the Program (or a work based on it, under Section 2) in object code or executable form under the terms of Sections 1 and 2 above provided that you also do one of the following:**

- a) Accompany it with the complete corresponding machine-readable source code, which must be distributed under the terms of Sections 1 and 2 above on a medium customarily used for software interchange; or,
- b) Accompany it with a written offer, valid for at least three years, to give any third party, for a charge no more than your cost of physically performing source distribution, a complete machine-readable copy of the corresponding source code, to be distributed under the terms of Sections 1 and 2 above on a medium customarily used for software interchange; or,
- c) Accompany it with the information you received as to the offer to distribute corresponding source code. (This alternative is allowed only for noncommercial distribution and only if you received the program in object code or executable form with such an offer, in accord with Subsection b above.)

The source code for a work means the preferred form of the work for making modifications to it. For an executable work, complete source code means all the source code for all modules it contains, plus any associated interface definition files, plus the scripts used to control compilation and installation of the executable. However, as a special exception, the source code distributed need not include anything that is normally distributed (in either source or binary form) with the major components (compiler, kernel, and so on) of the operating system on which the executable runs, unless that component itself accompanies the executable.

If distribution of executable or object code is made by offering access to copy from a designated place, then offering equivalent access to copy the source code from the same place counts as distribution of the source code, even though third parties are not compelled to copy the source along with the object code.

**4. You may not copy, modify, sublicense, or distribute the Program except as expressly provided under this License. Any attempt otherwise to copy, modify, sublicense or distribute the Program is void, and will automatically terminate your rights under this License. However, parties who have received copies, or rights, from you under this License will not have their licenses terminated so long as such parties remain in full compliance.**

**5. You are not required to accept this License, since you have not signed it. However, nothing else grants you permission to modify or distribute the Program or its derivative works. These actions are prohibited by law if you do not accept this License. Therefore, by modifying or distributing the Program (or any work based on the Program), you indicate your acceptance of this License to do so, and all its terms and conditions for copying, distributing or modifying the Program or works based on it.**

**6. Each time you redistribute the Program (or any work based on the Program), the recipient automatically receives a license from the original licensor to copy, distribute or modify the Program subject to these terms and conditions. You may not impose any further restrictions on the recipients' exercise of the rights granted herein. You are not responsible for enforcing compliance by third parties to this License.**

**7. If, as a consequence of a court judgment or allegation of patent infringement or for any other reason (not limited to patent issues), conditions are imposed on you (whether by court order, agreement or otherwise) that contradict the conditions of this License, they do not excuse you from the conditions of this License. If you cannot distribute so as to satisfy simultaneously your obligations under this License and any other pertinent obligations, then as a consequence you may not distribute the Program at all. For example, if a patent license would not permit royalty-free redistribution of the Program by all those who receive copies directly or indirectly through you, then the only way you could satisfy both it and this License would be to refrain entirely from distribution of the Program.**

If any portion of this section is held invalid or unenforceable under any particular circumstance, the balance of the section is intended to apply and the section as a whole is intended to apply in other circumstances.

It is not the purpose of this section to induce you to infringe any patents or other property right claims or to contest validity of any such claims; this section has the sole purpose of protecting the integrity of the free software distribution system, which is implemented by public license practices. Many people have made generous contributions to the wide range of software distributed through that system in reliance on consistent application of that system; it is up to the author/donor to decide if he or she is willing to distribute software through any other system and a licensee cannot impose that choice.

This section is intended to make thoroughly clear what is believed to be a consequence of the rest of this License.

**8. If the distribution and/or use of the Program is restricted in certain countries either by patents or by copyrighted interfaces, the original copyright holder who places the Program under this License may add an explicit geographical distribution limitation excluding those countries, so that distribution is permitted only in or among countries not thus excluded. In such case, this License incorporates the limitation as if written in the body of this License.**

**9. The Free Software Foundation may publish revised and/or new versions of the General Public License from time to time. Such new versions will be similar in spirit to the present version, but may differ in detail to address new problems or concerns.**

Each version is given a distinguishing version number. If the Program specifies a version number of this License which applies to it and "any later version", you have the option of following the terms and conditions either of that version or of any later version published by the Free Software Foundation. If the Program does not specify a version number of this License, you may choose any version ever published by the Free Software Foundation.

**10. If you wish to incorporate parts of the Program into other free programs whose distribution conditions are different, write to the author to ask for permission. For software which is copyrighted by the Free Software Foundation, write to the Free Software Foundation; we sometimes make exceptions for this. Our decision will be guided by the two goals of preserving the free status of all derivatives of our free software and of promoting the sharing and reuse of software generally.**

## NO WARRANTY

11. BECAUSE THE PROGRAM IS LICENSED FREE OF CHARGE, THERE IS NO WARRANTY FOR THE PROGRAM, TO THE EXTENT PERMITTED BY APPLICABLE LAW. EXCEPT WHEN OTHERWISE STATED IN WRITING THE COPYRIGHT HOLDERS AND/OR OTHER PARTIES PROVIDE THE PROGRAM "AS IS" WITHOUT WARRANTY OF ANY KIND, EITHER EXPRESSED OR IMPLIED, INCLUDING, BUT NOT LIMITED TO, THE IMPLIED WARRANTIES OF MERCHANTABILITY AND FITNESS FOR A PARTICULAR PURPOSE. THE ENTIRE RISK AS TO THE QUALITY AND PERFORMANCE OF THE PROGRAM IS WITH YOU. SHOULD THE PROGRAM PROVE DEFECTIVE, YOU ASSUME THE COST OF ALL NECESSARY SERVICING, REPAIR OR CORRECTION.

12. IN NO EVENT UNLESS REQUIRED BY APPLICABLE LAW OR AGREED TO IN WRITING WILL ANY COPYRIGHT HOLDER, OR ANY OTHER PARTY WHO MAY MODIFY AND/OR REDISTRIBUTE THE PROGRAM AS PERMITTED ABOVE, BE LIABLE TO YOU FOR DAMAGES, INCLUDING ANY GENERAL, SPECIAL, INCIDENTAL OR CONSEQUENTIAL DAMAGES ARISING OUT OF THE USE OR INABILITY TO USE THE PROGRAM (INCLUDING BUT NOT LIMITED TO LOSS OF DATA OR DATA BEING RENDERED INACCURATE OR LOSSES SUSTAINED BY YOU OR THIRD PARTIES OR A FAILURE OF THE PROGRAM TO OPERATE WITH ANY OTHER PROGRAMS), EVEN IF SUCH HOLDER OR OTHER PARTY HAS BEEN ADVISED OF THE POSSIBILITY OF SUCH DAMAGES.

END OF TERMS AND CONDITIONS

### How to Apply These Terms to Your New Programs

If you develop a new program, and you want it to be of the greatest possible use to the public, the best way to achieve this is to make it free software which everyone can redistribute and change under these terms.

To do so, attach the following notices to the program. It is safest to attach them to the start of each source file to most effectively convey the exclusion of warranty; and each file should have at least the "copyright" line and a pointer to where the full notice is found.

One line to give the program's name and a brief idea of what it does.

Copyright (C) <year> <name of author>

This program is free software; you can redistribute it and/or modify it under the terms of the GNU General Public License as published by the Free Software Foundation; either version 2 of the License, or (at your option) any later version.

This program is distributed in the hope that it will be useful, but WITHOUT ANY WARRANTY; without even the implied warranty of MERCHANTABILITY or FITNESS FOR A PARTICULAR PURPOSE. See the GNU General Public License for more details.

You should have received a copy of the GNU General Public License along with this program; if not, write to the Free Software Foundation, Inc., 59

Temple Place, Suite 330, Boston, MA 02111-1307 USA

Also add information on how to contact you by electronic and paper mail.

If the program is interactive, make it output a short notice like this when it starts in an interactive mode:

Gnomovision version 69, Copyright (C) year name of author Gnomovision comes with ABSOLUTELY NO WARRANTY; for details type `show w'. This is free software, and you are welcome to redistribute it under certain conditions; type `show c' for details.

The hypothetical commands `show w' and `show c' should show the appropriate parts of the General Public License. Of course, the commands you use may be called something other than `show w' and `show c'; they could even be mouse-clicks or menu items--whatever suits your program.

You should also get your employer (if you work as a programmer) or your school, if any, to sign a "copyright disclaimer" for the program, if necessary. Here is a sample; alter the names:

Yoyodyne, Inc., hereby disclaims all copyright interest in the program 'Gnomovision' (which makes passes at compilers) written by James Hacker.

signature of Ty Coon, 1 April 1989

Ty Coon, President of Vice

This General Public License does not permit incorporating your program into proprietary programs. If your program is a subroutine library, you may consider it more useful to permit linking proprietary applications with the library. If this is what you want to do, use the GNU Library General Public License instead of this License.

# GNU Lesser General Public License (LGPL)

Version 2.1, February 1999

Copyright (C) 1991, 1999 Free Software Foundation, Inc. 59 Temple Place, Suite 330, Boston, MA 02111-1307 USA Everyone is permitted to copy and distribute verbatim copies of this license document, but changing it is not allowed.

[This is the first released version of the Lesser GPL. It also counts as the successor of the GNU Library Public License, version 2, hence the version number 2.1.]

## Preamble

The licenses for most software are designed to take away your freedom to share and change it. By contrast, the GNU General Public Licenses are intended to guarantee your freedom to share and change free software--to make sure the software is free for all its users.

This license, the Lesser General Public License, applies to some specially designated software packages--typically libraries--of the Free Software Foundation and other authors who decide to use it. You can use it too, but we suggest you first think carefully about whether this license or the ordinary General Public License is the better strategy to use in any particular case, based on the explanations below.

When we speak of free software, we are referring to freedom of use, not price. Our General Public Licenses are designed to make sure that you have the freedom to distribute copies of free software (and charge for this service if you wish); that you receive source code or can get it if you want it; that you can change the software and use pieces of it in new free programs; and that you are informed that you can do these things.

To protect your rights, we need to make restrictions that forbid distributors to deny you these rights or to ask you to surrender these rights. These restrictions translate to certain responsibilities for you if you distribute copies of the library or if you modify it.

For example, if you distribute copies of the library, whether gratis or for a fee, you must give the recipients all the rights that we gave you. You must make sure that they, too, receive or can get the source code. If you link other code with the library, you must provide complete object files to the recipients, so that they can relink them with the library after making changes to the library and recompiling it. And you must show them these terms so they know their rights.

We protect your rights with a two-step method: (1) we copyright the library, and (2) we offer you this license, which gives you legal permission to copy, distribute and/or modify the library.

To protect each distributor, we want to make it very clear that there is no warranty for the free library. Also, if the library is modified by someone else and passed on, the recipients should know that what they have is not the original version, so that the original author's reputation will not be affected by problems that might be introduced by others.

Finally, software patents pose a constant threat to the existence of any free program. We wish to make sure that a company cannot effectively restrict the users of a free program by obtaining a restrictive license from a patent holder. Therefore, we insist that any patent license obtained for a version of the library must be consistent with the full freedom of use specified in this license.

Most GNU software, including some libraries, is covered by the ordinary GNU General Public License. This license, the GNU Lesser General Public License, applies to certain designated libraries, and is quite different from the ordinary General Public License. We use this license for certain libraries in order to permit linking those libraries into non-free programs.

When a program is linked with a library, whether statically or using a shared library, the combination of the two is legally speaking a combined work, a derivative of the original library. The ordinary General Public License therefore permits such linking only if the entire combination fits its criteria of freedom.

The Lesser General Public License permits more lax criteria for linking other code with the library.

We call this license the "Lesser" General Public License because it does Less to protect the user's freedom than the ordinary General Public License. It also provides other free software developers Less of an advantage over competing non-free programs. These disadvantages are the reason we use the ordinary General Public License for many libraries. However, the Lesser license provides advantages in certain special circumstances.

For example, on rare occasions, there may be a special need to encourage the widest possible use of a certain library, so that it becomes a de-facto standard. To achieve this, non-free programs must be allowed to use the library. A more frequent case is that a free library does the same job as widely used non-free libraries. In this case, there is little to gain by limiting the free library to free software only, so we use the Lesser General Public License.

In other cases, permission to use a particular library in non-free programs enables a greater number of people to use a large body of free software. For example, permission to use the GNU C Library in non-free programs enables many more people to use the whole GNU operating system, as well as its variant, the GNU/Linux operating system. Although the Lesser General Public License is less protective of the users' freedom, it does ensure that the user of a program that is linked with the Library has the freedom and the wherewithal to run that program using a modified version of the Library.

The precise terms and conditions for copying, distribution and modification follow. Pay close attention to the difference between a "work based on the library" and a "work that uses the library". The former contains code derived from the library, whereas the latter must be combined with the library in order to run.

## **TERMS AND CONDITIONS FOR COPYING, DISTRIBUTION AND MODIFICATION**

**0.** This License Agreement applies to any software library or other program which contains a notice placed by the copyright holder or other authorized party saying it may be distributed under the terms of this Lesser General Public License (also called "this License"). Each licensee is addressed as "you".

A "library" means a collection of software functions and/or data prepared so as to be conveniently linked with application programs (which use some of those functions and data) to form executables.

The "Library", below, refers to any such software library or work which has been distributed under these terms. A "work based on the Library" means either the Library or any derivative work under copyright law: that is to say, a work containing the Library or a portion of it, either verbatim or with modifications and/or translated straightforwardly into another language. (Hereinafter, translation is included without limitation in the term "modification".)

"Source code" for a work means the preferred form of the work for making modifications to it. For a library, complete source code means all the source code for all modules it contains, plus any associated interface definition files, plus the scripts used to control compilation and installation of the library.

Activities other than copying, distribution and modification are not covered by this License; they are outside its scope. The act of running a program using the Library is not restricted, and output from such a program is covered only if its contents constitute a work based on the Library (independent of the use of the Library in a tool for writing it). Whether that is true depends on what the Library does and what the program that uses the Library does.

**1. You may copy and distribute verbatim copies of the Library's complete source code as you receive it, in any medium, provided that you conspicuously and appropriately publish on each copy an appropriate copyright notice and disclaimer of warranty; keep intact all the notices that refer to this License and to the absence of any warranty; and distribute a copy of this License along with the Library.**

You may charge a fee for the physical act of transferring a copy, and you may at your option offer warranty protection in exchange for a fee.

**2. You may modify your copy or copies of the Library or any portion of it, thus forming a work based on the Library, and copy and distribute such modifications or work under the terms of Section 1 above, provided that you also meet all of these conditions:**

- a) The modified work must itself be a software library.
- b) You must cause the files modified to carry prominent notices stating that you changed the files and the date of any change.
- c) You must cause the whole of the work to be licensed at no charge to all third parties under the terms of this License.
- d) If a facility in the modified Library refers to a function or a table of data to be supplied by an application program that uses the facility, other than as an argument passed when the facility is invoked, then you must make a good faith effort to ensure that, in the event an application does not supply such function or table, the facility still operates, and performs whatever part of its purpose remains meaningful.

(For example, a function in a library to compute square roots has a purpose that is entirely well-defined independent of the application. Therefore, Subsection 2d requires that any application-supplied function or table used by this function must be optional: if the application does not supply it, the square root function must still compute square roots.)

These requirements apply to the modified work as a whole. If identifiable sections of that work are not derived from the Library, and can be reasonably considered independent and separate works in themselves, then this License, and its terms, do not apply to those sections when you distribute them as separate works. But when you distribute the same sections as part of a whole which is a work based on the Library, the distribution of the whole must be on the terms of this License, whose permissions for other licensees extend to the entire whole, and thus to each and every part regardless of who wrote it.

Thus, it is not the intent of this section to claim rights or contest your rights to work written entirely by you; rather, the intent is to exercise the right to control the distribution of derivative or collective works based on the Library.

In addition, mere aggregation of another work not based on the Library with the Library (or with a work based on the Library) on a volume of a storage or distribution medium does not bring the other work under the scope of this License.

**3. You may opt to apply the terms of the ordinary GNU General Public License instead of this License to a given copy of the Library. To do this, you must alter all the notices that refer to this License, so that they refer to the ordinary GNU General Public License, version 2, instead of to this License. (If a newer version than version 2 of the ordinary GNU General Public License has appeared, then you can specify that version instead if you wish.) Do not make any other change in these notices.**

Once this change is made in a given copy, it is irreversible for that copy, so the ordinary GNU General Public License applies to all subsequent copies and derivative works made from that copy.

This option is useful when you wish to copy part of the code of the Library into a program that is not a library.

**4. You may copy and distribute the Library (or a portion or derivative of it, under Section 2) in object code or executable form under the terms of Sections 1 and 2 above provided that you accompany it with the complete corresponding machine-readable source code, which must be distributed under the terms of Sections 1 and 2 above on a medium customarily used for software interchange.**

If distribution of object code is made by offering access to copy from a designated place, then offering equivalent access to copy the source code from the same place satisfies the requirement to distribute the source code, even though third parties are not compelled to copy the source along with the object code.

**5. A program that contains no derivative of any portion of the Library, but is designed to work with the Library by being compiled or linked with it, is called a “work that uses the Library”. Such a work, in isolation, is not a derivative work of the Library, and therefore falls outside the scope of this License.**

However, linking a “work that uses the Library” with the Library creates an executable that is a derivative of the Library (because it contains portions of the Library), rather than a “work that uses the library”. The executable is therefore covered by this License. Section 6 states terms for distribution of such executables.

When a “work that uses the Library” uses material from a header file that is part of the Library, the object code for the work may be a derivative work of the Library even though the source code is not. Whether this is true is especially significant if the work can be linked without the Library, or if the work is itself a library. The threshold for this to be true is not precisely defined by law.

If such an object file uses only numerical parameters, data structure layouts and accessors, and small macros and small inline functions (ten lines or less in length), then the use of the object file is unrestricted, regardless of whether it is legally a derivative work. (Executables containing this object code plus portions of the Library will still fall under Section 6.)

Otherwise, if the work is a derivative of the Library, you may distribute the object code for the work under the terms of Section 6. Any executables containing that work also fall under Section 6, whether or not they are linked directly with the Library itself.

**6. As an exception to the Sections above, you may also combine or link a “work that uses the Library” with the Library to produce a work containing portions of the Library, and distribute that work under terms of your choice, provided that the terms permit modification of the work for the customer’s own use and reverse engineering for debugging such modifications.**

You must give prominent notice with each copy of the work that the Library is used in it and that the Library and its use are covered by this License. You must supply a copy of this License. If the work during execution displays copyright notices, you must include the copyright notice for the Library among them, as well as a reference directing the user to the copy of this License. Also, you must do one of these things:

- a) Accompany the work with the complete corresponding machine-readable source code for the Library including whatever changes were used in the work (which must be distributed under Sections 1 and 2 above); and, if the work is an executable linked with the Library, with the complete machinereadable “work that uses the Library”, as object code and/or source code, so that the user can modify the Library and then relink to produce a modified executable containing the modified Library. (It is understood that the user who changes the contents of definitions files in the Library will not necessarily be able to recompile the application to use the modified definitions.)
- b) Use a suitable shared library mechanism for linking with the Library. A suitable mechanism is one that (1) uses at run time a copy of the library already present on the user’s computer system, rather than copying library functions into the executable, and (2) will operate properly with a modified version of the library, if the user installs one, as long as the modified version is interface-compatible with the version that the work was made with.
- c) Accompany the work with a written offer, valid for at least three years, to give the same user the materials specified in Subsection 6a, above, for a charge no more than the cost of performing this distribution.
- d) If distribution of the work is made by offering access to copy from a designated place, offer equivalent access to copy the above specified materials from the same place.
- e) Verify that the user has already received a copy of these materials or that you have already sent this user a copy.

For an executable, the required form of the “work that uses the Library” must include any data and utility programs needed for reproducing the executable from it. However, as a special exception, the materials to be distributed need not include anything that is normally distributed (in either source or binary form) with the major components (compiler, kernel, and so on) of the operating system on which the executable runs, unless that component itself accompanies the executable.

It may happen that this requirement contradicts the license restrictions of other proprietary libraries that do not normally accompany the operating system. Such a contradiction means you cannot use both them and the Library together in an executable that you distribute.

**7. You may place library facilities that are a work based on the Library side-by-side in a single library together with other library facilities not covered by this License, and distribute such a combined library, provided that the separate distribution of the work based on the Library and of the other library facilities is otherwise permitted, and provided that you do these two things:**

- a) Accompany the combined library with a copy of the same work based on the Library, uncombined with any other library facilities. This must be distributed under the terms of the Sections above.
- b) Give prominent notice with the combined library of the fact that part of it is a work based on the Library, and explaining where to find the accompanying uncombined form of the same work.

**8. You may not copy, modify, sublicense, link with, or distribute the Library except as expressly provided under this License. Any attempt otherwise to copy, modify, sublicense, link with, or distribute the Library is void, and will automatically terminate your rights under this License. However, parties who have received copies, or rights, from you under this License will not have their licenses terminated so long as such parties remain in full compliance.**

**9. You are not required to accept this License, since you have not signed it. However, nothing else grants you permission to modify or distribute the Library or its derivative works. These actions are prohibited by law if you do not accept this License. Therefore, by modifying or distributing the Library (or any work based on the Library), you indicate your acceptance of this License to do so, and all its terms and conditions for copying, distributing or modifying the Library or works based on it.**

**10. Each time you redistribute the Library (or any work based on the Library), the recipient automatically receives a license from the original licensor to copy, distribute, link with or modify the Library subject to these terms and conditions. You may not impose any further restrictions on the recipients’ exercise of the rights granted herein. You are not responsible for enforcing compliance by third parties with this License.**

**11. If, as a consequence of a court judgment or allegation of patent infringement or for any other reason (not limited to patent issues), conditions are imposed on you (whether by court order, agreement or otherwise) that contradict the conditions of this License, they do not excuse you from the conditions of this License. If you cannot distribute so as to satisfy simultaneously your obligations under this License and any other pertinent obligations, then as a consequence you may not distribute the Library at all. For example, if a patent license would not permit royalty-free redistribution of the Library by all those who receive copies directly or indirectly through you, then the only way you could satisfy both it and this License would be to refrain entirely from distribution of the Library.**

If any portion of this section is held invalid or unenforceable under any particular circumstance, the balance of the section is intended to apply, and the section as a whole is intended to apply in other circumstances.

It is not the purpose of this section to induce you to infringe any patents or other property right claims or to contest validity of any such claims; this section has the sole purpose of protecting the integrity of the free software distribution system which is implemented by public license practices. Many people have made generous contributions to the wide range of software distributed through that system in reliance on consistent application of that system; it is up to the author/donor to decide if he or she is willing to distribute software through any other system and a licensee cannot impose that choice.

This section is intended to make thoroughly clear what is believed to be a consequence of the rest of this License.

**12. If the distribution and/or use of the Library is restricted in certain countries either by patents or by copyrighted interfaces, the original copyright holder who places the Library under this License may add an explicit geographical distribution limitation excluding those countries, so that distribution is permitted only in or among countries not thus excluded. In such case, this License incorporates the limitation as if written in the body of this License.**

**13. The Free Software Foundation may publish revised and/or new versions of the Lesser General Public License from time to time. Such new versions will be similar in spirit to the present version, but may differ in detail to address new problems or concerns.**

Each version is given a distinguishing version number. If the Library specifies a version number of this License which applies to it and “any later version”, you have the option of following the terms and conditions either of that version or of any later version published by the Free Software Foundation. If the Library does not specify a license version number, you may choose any version ever published by the Free Software Foundation.

**14. If you wish to incorporate parts of the Library into other free programs whose distribution conditions are incompatible with these, write to the author to ask for permission. For software which is copyrighted by the Free Software Foundation, write to the Free Software Foundation; we sometimes make exceptions for this. Our decision will be guided by the two goals of preserving the free status of all derivatives of our free software and of promoting the sharing and reuse of software generally.**

#### **NO WARRANTY**

**15. BECAUSE THE LIBRARY IS LICENSED FREE OF CHARGE, THERE IS NO WARRANTY FOR THE LIBRARY, TO THE EXTENT PERMITTED BY APPLICABLE LAW. EXCEPT WHEN OTHERWISE STATED IN WRITING THE COPYRIGHT HOLDERS AND/OR OTHER PARTIES PROVIDE THE LIBRARY “AS IS” WITHOUT WARRANTY OF ANY KIND, EITHER EXPRESSED OR IMPLIED, INCLUDING, BUT NOT LIMITED TO, THE IMPLIED WARRANTIES OF MERCHANTABILITY AND FITNESS FOR A PARTICULAR PURPOSE. THE ENTIRE RISK AS TO THE QUALITY AND PERFORMANCE OF THE LIBRARY IS WITH YOU. SHOULD THE LIBRARY PROVE DEFECTIVE, YOU ASSUME THE COST OF ALL NECESSARY SERVICING, REPAIR OR CORRECTION.**

**16. IN NO EVENT UNLESS REQUIRED BY APPLICABLE LAW OR AGREED TO IN WRITING WILL ANY COPYRIGHT HOLDER, OR ANY OTHER PARTY WHO MAY MODIFY AND/OR REDISTRIBUTE THE LIBRARY AS PERMITTED ABOVE, BE LIABLE TO YOU FOR DAMAGES, INCLUDING ANY GENERAL, SPECIAL, INCIDENTAL OR CONSEQUENTIAL DAMAGES ARISING OUT OF THE USE OR INABILITY TO USE THE LIBRARY (INCLUDING BUT NOT LIMITED TO LOSS OF DATA OR DATA BEING RENDERED INACCURATE OR LOSSES SUSTAINED BY YOU OR THIRD PARTIES OR A FAILURE OF THE LIBRARY TO OPERATE WITH ANY OTHER SOFTWARE), EVEN IF SUCH HOLDER OR OTHER PARTY HAS BEEN ADVISED OF THE POSSIBILITY OF SUCH DAMAGES.**

## **END OF TERMS AND CONDITIONS**

### **How to Apply These Terms to Your New Libraries**

If you develop a new library, and you want it to be of the greatest possible use to the public, we recommend making it free software that everyone can redistribute and change. You can do so by permitting redistribution under these terms (or, alternatively, under the terms of the ordinary General Public License).

To apply these terms, attach the following notices to the library. It is safest to attach them to the start of each source file to most effectively convey the exclusion of warranty; and each file should have at least the “copyright” line and a pointer to where the full notice is found.



<one line to give the library's name and an idea of what it does.> Copyright (C) <year> <name of author>

This library is free software; you can redistribute it and/or modify it under the terms of the GNU Lesser General Public License as published by the Free Software Foundation; either version 2.1 of the License, or (at your option) any later version.

This library is distributed in the hope that it will be useful, but WITHOUT ANY WARRANTY; without even the implied warranty of MERCHANTABILITY or FITNESS FOR A PARTICULAR PURPOSE. See the GNU Lesser General Public License for more details.

You should have received a copy of the GNU Lesser General Public License along with this library; if not, write to the Free Software Foundation, Inc., 59

Temple Place, Suite 330, Boston, MA 02111-1307 USA

Also add information on how to contact you by electronic and paper mail.

You should also get your employer (if you work as a programmer) or your school, if any, to sign a "copyright disclaimer" for the library, if necessary. Here is a sample; alter the names:

Yoyodyne, Inc., hereby disclaims all copyright interest in the library 'Frob' (a library for tweaking knobs) written by James Random Hacker.

signature of Ty Coon, 1 April 1990

Ty Coon, President of Vice

That's all there is to it!

## OpenSSL License

Copyright (c) 1998-2007 The OpenSSL Project. All rights reserved.

Redistribution and use in source and binary forms, with or without modification, are permitted provided that the following conditions are met:

- 1. Redistributions of source code must retain the above copyright notice, this list of conditions and the following disclaimer.**
- 2. Redistributions in binary form must reproduce the above copyright notice, this list of conditions and the following disclaimer in the documentation and/or other materials provided with the distribution.**
- 3. All advertising materials mentioning features or use of this software must display the following acknowledgment:**  
"This product includes software developed by the OpenSSL Project for use in the OpenSSL Toolkit. (<http://www.openssl.org/>)"
- 4. The names "OpenSSL Toolkit" and "OpenSSL Project" must not be used to endorse or promote products derived from this software without prior written permission. For written permission, please contact [openssl-core@openssl.org](mailto:openssl-core@openssl.org).**
- 5. Products derived from this software may not be called "OpenSSL" nor may "OpenSSL" appear in their names without prior written permission of the OpenSSL Project.**
- 6. Redistributions of any form whatsoever must retain the following acknowledgment: "This product includes software developed by the OpenSSL Project for use in the OpenSSL Toolkit (<http://www.openssl.org/>)"**

THIS SOFTWARE IS PROVIDED BY THE OpenSSL PROJECT "AS IS" AND ANY EXPRESSED OR IMPLIED WARRANTIES, INCLUDING, BUT NOT LIMITED TO, THE IMPLIED WARRANTIES OF MERCHANTABILITY AND FITNESS FOR A PARTICULAR PURPOSE ARE DISCLAIMED. IN NO EVENT SHALL THE OpenSSL PROJECT OR ITS CONTRIBUTORS BE LIABLE FOR ANY DIRECT, INDIRECT, INCIDENTAL, SPECIAL, EXEMPLARY, OR CONSEQUENTIAL DAMAGES (INCLUDING, BUT NOT LIMITED TO, PROCUREMENT OF SUBSTITUTE GOODS OR SERVICES; LOSS OF USE, DATA, OR PROFITS; OR BUSINESS INTERRUPTION) HOWEVER CAUSED AND ON ANY THEORY OF LIABILITY, WHETHER IN CONTRACT, STRICT LIABILITY, OR TORT (INCLUDING NEGLIGENCE OR OTHERWISE) ARISING IN ANY WAY OUT OF THE USE OF THIS SOFTWARE, EVEN IF ADVISED OF THE POSSIBILITY OF SUCH DAMAGE.

# WARRANTY

---

## LIMITED WARRANTY TO ORIGINAL PURCHASER

This SAMSUNG brand product, as supplied and distributed by Samsung Electronics America, Inc. (SAMSUNG) and delivered new, in the original carton to the original consumer purchaser, is warranted by SAMSUNG against manufacturing defects in materials and workmanship for a limited warranty period of:

### **One (1) Year Parts and Labor\***

#### **(\*90 Days Parts and Labor for Commercial Use)**

This limited warranty begins on the original date of purchase, and is valid only on products purchased and used in the United States. To receive warranty service, the purchaser must contact SAMSUNG for problem determination and service procedures. Warranty service can only be performed by a SAMSUNG authorized service center. The original dated bill of sale must be presented upon request as proof of purchase to SAMSUNG or SAMSUNG's authorized service center. Transportation of the product to and from the service center is the responsibility of the purchaser.

SAMSUNG will repair or replace this product, at our option and at no charge as stipulated herein, with new or reconditioned parts or products if found to be defective during the limited warranty period specified above. All replaced parts and products become the property of SAMSUNG and must be returned to SAMSUNG. Replacement parts and products assume the remaining original warranty, or ninety (90) days, whichever is longer.

SAMSUNG's obligations with respect to software products distributed by SAMSUNG under the SAMSUNG brand name are set forth in the applicable end user license agreement. Non-SAMSUNG hardware and software products, if provided, are on an "AS IS" basis. Non-SAMSUNG manufacturers, suppliers, publishers, and service providers may provide their own warranties.

This limited warranty covers manufacturing defects in materials and workmanship encountered in normal, and except to the extent otherwise expressly provided for in this statement, noncommercial use of this product, and shall not apply to the following, including, but not limited to: damage which occurs in shipment; delivery and installation; applications and uses for which this product was not intended; altered product or serial numbers; cosmetic damage or exterior finish; accidents, abuse, neglect, fire, water, lightning or other acts of nature; use of products, equipment, systems, utilities, services, parts, supplies, accessories, applications, installations, repairs, external wiring or connectors not supplied and authorized by SAMSUNG, or which damage this product or result in service problems; incorrect electrical line voltage, fluctuations and surges; customer adjustments and failure to follow operating instructions, cleaning, maintenance and environmental instructions that are covered and prescribed in the instruction book; product removal or reinstallation; reception problems and distortion related to noise, echo, interference or other signal transmission and delivery problems. SAMSUNG does not warrant uninterrupted or error-free operation of the product.

THERE ARE NO EXPRESS WARRANTIES OTHER THAN THOSE LISTED AND DESCRIBED ABOVE, AND NO WARRANTIES WHETHER EXPRESS OR IMPLIED, INCLUDING, BUT NOT LIMITED TO, ANY IMPLIED WARRANTIES OF MERCHANTABILITY OR FITNESS FOR A PARTICULAR PURPOSE, SHALL APPLY AFTER THE EXPRESS WARRANTY PERIODS STATED ABOVE, AND NO OTHER EXPRESS WARRANTY OR GUARANTY GIVEN BY ANY PERSON, FIRM OR CORPORATION WITH RESPECT TO THIS PRODUCT SHALL BE BINDING ON SAMSUNG. SAMSUNG SHALL NOT BE LIABLE FOR LOSS OF REVENUE OR PROFITS, FAILURE TO REALIZE SAVINGS OR OTHER BENEFITS, OR ANY OTHER SPECIAL, INCIDENTAL OR CONSEQUENTIAL DAMAGES CAUSED BY THE USE, MISUSE OR INABILITY TO USE THIS PRODUCT, REGARDLESS OF THE LEGAL THEORY ON WHICH THE CLAIM IS BASED, AND EVEN IF SAMSUNG HAS BEEN ADVISED OF THE POSSIBILITY OF SUCH DAMAGES. NOR SHALL RECOVERY OF ANY KIND AGAINST SAMSUNG BE GREATER IN AMOUNT THAN THE PURCHASE PRICE OF THE PRODUCT SOLD BY SAMSUNG AND CAUSING THE ALLEGED DAMAGE. WITHOUT LIMITING THE FOREGOING, PURCHASER ASSUMES ALL RISK AND LIABILITY FOR LOSS, DAMAGE OR INJURY TO PURCHASER AND PURCHASER'S PROPERTY AND TO OTHERS AND THEIR PROPERTY ARISING OUT OF THE USE, MISUSE OR INABILITY TO USE THIS PRODUCT SOLD BY SAMSUNG NOT CAUSED DIRECTLY BY THE NEGLIGENCE OF SAMSUNG. THIS LIMITED WARRANTY SHALL NOT EXTEND TO ANYONE OTHER THAN THE ORIGINAL PURCHASER OF THIS PRODUCT, IS NONTRANSFERABLE AND STATES YOUR EXCLUSIVE REMEDY.

Some states do not allow limitations on how long an implied warranty lasts, or the exclusion or limitation of incidental or consequential damages, so the above limitations or exclusions may not apply to you. This warranty gives you specific legal rights, and you may also have other rights which vary from state to state.

To obtain warranty hardware service, please contact SAMSUNG at:

Samsung Electronics America, Inc.  
105 Challenger Road Ridgefield Park, NJ 07660-0511  
1-800-SAMSUNG (726-7864) and [www.samsung.com/us](http://www.samsung.com/us)

## Contact SAMSUNG WORLD WIDE

If you have any questions or comments relating to Samsung products, please contact the SAMSUNG customer care center.

Region	Country	Customer Care Center ☎	Web Site
North America	CANADA	1-800-SAMSUNG(726-7864)	www.samsung.com/ca
	MEXICO	01-800-SAMSUNG(726-7864)	www.samsung.com/mx
	U.S.A	1-800-SAMSUNG(726-7864)	www.samsung.com/us
Latin America	ARGENTINE	0800-333-3733	www.samsung.com/ar
	BRAZIL	0800-124-421, 4004-0000	www.samsung.com/br
	CHILE	800-SAMSUNG(726-7864)	www.samsung.com/cl
	NICARAGUA	00-1800-5077267	www.samsung.com/latin
	HONDURAS	800-7919267	www.samsung.com/latin
	COSTA RICA	0-800-507-7267	www.samsung.com/latin
	ECUADOR	1-800-10-7267	www.samsung.com/latin
	EL SALVADOR	800-6225	www.samsung.com/latin
	GUATEMALA	1-800-299-0013	www.samsung.com/latin
	JAMAICA	1-800-234-7267	www.samsung.com/latin
	PANAMA	800-7267	www.samsung.com/latin
	PUERTO RICO	1-800-682-3180	www.samsung.com/latin
	REP. DOMINICA	1-800-751-2676	www.samsung.com/latin
	TRINIDAD & TOBAGO	1-800-SAMSUNG(726-7864)	www.samsung.com/latin
VENEZUELA	0-800-100-5303	www.samsung.com/latin	
COLOMBIA	01-8000112112	www.samsung.com.co	
Europe	BELGIUM	02 201 2418	www.samsung.com/be (Dutch) www.samsung.com/be_fr (French)
	CZECH REPUBLIC	800-SAMSUNG(800-726786)	www.samsung.com/cz
	DENMARK	8-SAMSUNG(7267864)	www.samsung.com/dk
	FINLAND	30-6227 515	www.samsung.com/fi
	FRANCE	01 4863 0000	www.samsung.com/fr
	GERMANY	01805 - SAMSUNG(726-7864 € 0,14/Min)	www.samsung.de
	HUNGARY	06-80-SAMSUNG(726-7864)	www.samsung.com/hu
	ITALIA	800-SAMSUNG(726-7864)	www.samsung.com/it
	LUXEMBURG	02 261 03 710	www.samsung.com/lu
	NETHERLANDS	0900-SAMSUNG (0900-7267864) (€ 0,10/Min)	www.samsung.com/nl
	NORWAY	3-SAMSUNG(7267864)	www.samsung.com/no
	POLAND	0 801 1SAMSUNG(172678), 022-607-93-33	www.samsung.com/pl
	PORTUGAL	80820-SAMSUNG(726-7864)	www.samsung.com/pt
	SLOVAKIA	0800-SAMSUNG(726-7864)	www.samsung.com/sk
	SPAIN	902-1-SAMSUNG (902 172 678)	www.samsung.com/es
	SWEDEN	075-SAMSUNG(726 78 64)	www.samsung.com/se
	U.K	0845 SAMSUNG (7267864)	www.samsung.com/uk
	EIRE	0818 717 100	www.samsung.com/ie
	AUSTRIA	0810-SAMSUNG(7267864, € 0.07/min)	www.samsung.com/at
SWITZERLAND	0848-SAMSUNG(7267864, CHF 0.08/min)	www.samsung.com/ch	
CIS	RUSSIA	8-800-555-55-55	www.samsung.ru
	KAZAKHSTAN	8-10-800-500-55-500	www.samsung.com/kz_ru
	UZBEKISTAN	8-10-800-500-55-500	www.samsung.com/kz_ru
	KYRGYZSTAN	00-800-500-55-500	
	TADJIKISTAN	8-10-800-500-55-500	
	UKRAINE	8-800-502-0000	www.samsung.ua
	LITHUANIA	8-800-77777	www.samsung.com/lt
	LATVIA	8000-7267	www.samsung.com/lv
	ESTONIA	800-7267	www.samsung.com/ee
Asia Pacific	AUSTRALIA	1300 362 603	www.samsung.com/au
	NEW ZEALAND	0800 SAMSUNG (0800 726 786)	www.samsung.com/nz
	CHINA	800-810-5858, 400-810-5858, 010-6475 1880	www.samsung.com/cn
	HONG KONG	3698-4698	www.samsung.com/hk
	INDIA	3030 8282, 1800 110011, 1-800-3000-8282	www.samsung.com/in
	INDONESIA	0800-112-8888	www.samsung.com/id
	JAPAN	0120-327-527	www.samsung.com/jp
	MALAYSIA	1800-88-9999	www.samsung.com/my
	PHILIPPINES	1-800-10-SAMSUNG(726-7864) 1-800-3-SAMSUNG(726-7864), 02-5805777	www.samsung.com/ph
	SINGAPORE	1800-SAMSUNG(726-7864)	www.samsung.com/sg
	THAILAND	1800-29-3232, 02-689-3232	www.samsung.com/th
	TAIWAN	0800-329-999	www.samsung.com/tw
	VIETNAM	1 800 588 889	www.samsung.com/vn
Middle East & Africa	TURKEY	444 77 11	www.samsung.com/tr
	SOUTH AFRICA	0860-SAMSUNG(726-7864)	www.samsung.com/za
	U.A.E	800-SAMSUNG (726-7864), 8000-4726	www.samsung.com/ae



QUESTIONS OR COMMENTS?

COUNTRY	CALL	OR VISIT US ONLINE AT	WRITE
IN THE US	1-800-SAMSUNG (7267864)	<a href="http://www.samsung.com/us">www.samsung.com/us</a>	Samsung Electronics America, Inc. 105 Challenger Road Ridgefield Park, NJ 07660-0511

