

HT-X810

Digital Home Theater System user manual

imagine the possibilities

Thank you for purchasing this Samsung product.
To receive more complete service,
please register your product at
www.samsung.com/global/register

SAMSUNG

features

Playback of many disc types

This Home Theater System allows you to play back various discs, including DVD-AUDIO, DVD-VIDEO, CD, MP3-CD, WMA-CD, DivX, CD-R/RW, and DVD±R/RW.

DVD-Audio compatible

Experience the super high-quality audio performance of DVD-Audio. The on-board 24-bit/192kHz DAC enables this player to deliver exceptional sound quality in terms of dynamic range, low-level resolution and high-frequency detail.

USB Host support

You can connect and play files from external USB storage devices such as MP3 players, USB flash memory, etc. using the Home Theater's USB HOST function.

TV Screen Saver Function

If the main unit remains in Stop mode for 3 minutes, Samsung logo appears on the TV screen.

The HT-X810 automatically switches itself into the power saving mode after 20 minutes in the Screen Saver mode.

Power Saving Function

The HT-X810 automatically shuts itself off after 20 minutes in Stop mode.

Customized TV Screen Display

The HT-X810 allows you to select your favorite image during JPEG, DVD playback and set it as your background wallpaper.

HDMI

HDMI transmits DVD video and audio signals simultaneously, and provides a clearer picture.

AV SYNC Function

Video may lag behind the audio if the unit is connected to a digital TV.

To compensate for this, you can adjust the audio delay time to sync up with the video.

Anynet+(HDMI-CEC) Function

Anynet+ is a function that can be used to operate the main unit using a Samsung TV remote control, by connecting the Home Theater to a SAMSUNG TV using an HDMI Cable. (This is only available with SAMSUNG TVs that support Anynet+.)

Bluetooth Function

You can use a Bluetooth device to enjoy music with high quality stereo sound, all without wires!

Wireless Subwoofer

You can hear powerful sound from the subwoofer without having to use speaker cables.

WHAT'S INCLUDED

Check for the supplied accessories below.



Video Cable
(AH39-40001V)



FM Antenna
(AH42-00017A)



User's Manual
(AH68-02062R)

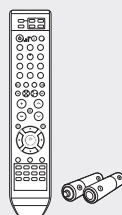

Remote Control
(AH59-01907T)
/ Batteries (AAA size)
(4301-000116)

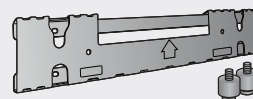

Bracket-Wall Mount
(AH61-02574A)
/ Mounting Studs (2EA)
(AH97-02638A)

safety information

SAFETY WARNINGS

TO REDUCE THE RISK OF ELECTRIC SHOCK, DO NOT REMOVE THE COVER(OR BACK). NO USER-SERVICEABLE PARTS ARE INSIDE. REFER SERVICING TO QUALIFIED SERVICE PERSONNEL.

	<div style="border: 1px solid black; padding: 5px; text-align: center;"> CAUTION <small>RISK OF ELECTRIC SHOCK DO NOT OPEN</small> </div>	
<p>The lightning flash and Arrowhead within Triangle Is a warning sign alerting you of dangerous voltage inside the product</p>	<p>CAUTION: TO REDUCE THE RISK OF ELECTRIC SHOCK, DO NOT REMOVE COVER (OR BACK) NO USER SERVICEABLE PARTS INSIDE. REFER SERVICING TO QULAIFIED SERVICE PERSONNEL.</p>	<p>The explanation point within the triangle is a warning sign alerting you of important instructions accompanying the product.</p>

**CLASS 1 LASER PRODUCT
 KLASSE 1 LASER PRODUKT
 LUOKAN 1 LASER LAITE
 KLASS 1 LASER APPARAT
 PRODUCTO LASER CLASE 1**

CLASS 1 LASER PRODUCT

This Compact Disc player is classified as a CLASS 1 LASER product. Use of controls, adjustments or performance of procedures other than those specified herein may result in hazardous radiation exposure.

CAUTION : INVISIBLE LASER RADIATION WHEN OPEN AND INTERLOCKS DEFEATED, AVOID EXPOSURE TO BEAM.

WARNING

- To reduce the risk of fire or electric shock, do not expose this appliance to rain or moisture.
- To prevent injury, this apparatus must be securely attached to the floor/wall in accordance with the installation instructions.
- If this power supply is used at 240V ac, a suitable plug adapter should be used.

CAUTION

- Apparatus shall not be exposed to dripping or splashing and no objects filled with liquids, such as vases, shall be placed on the apparatus.
- The Mains plug is used as a disconnect device and shall stay readily operable at any time.

This product satisfies FCC regulations when shielded cables and connectors are used to connect the unit to other equipment. To prevent electromagnetic interference with electric appliances, such as radios and televisions, use shielded cables and connectors for connections.

FCC NOTE (for U.S.A):

This equipment has been tested and found to comply with the limits for a Class B digital device, pursuant to Part 15 of the FCC Rules. These limits are designed to provide reasonable protection against harmful interference in a residential installation.

This equipment generates, uses and can radiate radio frequency energy and, if not installed and used in accordance with the instructions, may cause harmful interference to radio communications. However, there is no guarantee that interference will not occur in a particular installation.

If this equipment does cause harmful interference to radio or television reception, which can be determined by turning the equipment off and on, the user is encouraged to try to correct the interference by one or more of the following measures:

- Reorient or relocate the receiving antenna.
- Increase the separation between the equipment and receiver.
- Connect the equipment into an outlet on a circuit different from that to which the receiver is connected.
- Consult the dealer or an experienced radio/TV technician for help.

Caution : FCC regulations state that any unauthorized changes or modifications to this equipment may void the user's authority to operate it.

safety information

IMPORTANT SAFETY INSTRUCTIONS

This device complies with part 15 of the FCC Rules.

Operation is subject to the following two conditions: (1) This device may not cause harmful interference, and (2) this device must accept any interference received, including interference that may cause undesired operation.

IMPORTANT NOTE:

FCC Radiation Exposure Statement

This equipment complies with FCC radiation exposure limits set forth an uncontrolled environment.

This equipment should be installed and operated with minimum distance 20cm between the radiator and your body.

This transmitter must not be co-located or operating in conjunction with any other antenna or transmitter.

Canadian Department of Communications Radio Interference Regulations

This digital apparatus (Wireless Internet Radio) does not exceed the Class B limits for radio-noise emissions from digital apparatus as set out in the Radio Interference Regulations of the Canadian Department of Communications.

Read these operating instructions carefully before using the unit. Follow all the safety instructions listed below. Keep these operating instructions handy for future reference.

- 1) Read these instructions.
- 2) Keep these Instructions.
- 3) Heed all warnings.
- 4) Follow all instructions.
- 5) Do not use this apparatus near water.
- 6) Clean only with dry cloth.
- 7) Do not block any ventilation openings. Install in accordance with the manufacturer's instructions.
- 8) Do not install near any heat sources such as radiators, heat registers, stoves, or other apparatus (including amplifiers) that produce heat.
- 9) Do not defeat the safety purpose of the polarized or grounding-type plug. A polarized plug has two blades with one wider than the other. A grounding type plug has two blades and a third grounding prong. The wide blade or the third prong are provided for your safety. If the provided plug does not fit into your outlet, consult an electrician for replacement of the obsolete outlet.
- 10) Protect the power cord from being walked on or pinched particularly at plugs, convenience receptacles, and the point where they exit from the apparatus.
- 11) Only use attachment/accessories specified by the manufacturer.
- 12) Use only with the cart, stand, tripod, bracket, or table specified by the manufacturer, or sold with the apparatus. When a cart is used, use caution when moving the cart/apparatus combination to avoid injury from tip-over.
- 13) Unplug this apparatus during lightning storms or when unused for long periods of time.
- 14) Refer all servicing to qualified service personnel. Servicing is required when the apparatus has been damaged in any way, such as power-supply cord or plug is damaged, liquid has been spilled or objects have fallen into the apparatus, the apparatus has been exposed to rain or moisture, does not operate normally, or has been dropped.



PRECAUTIONS

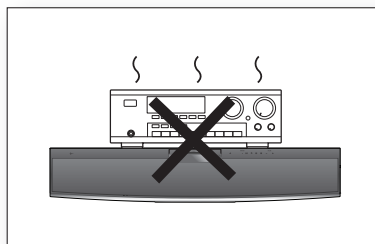
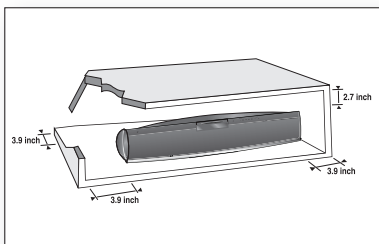

Ensure that the AC power supply in your house complies with the identification sticker located on the back of your player. Install your player horizontally, on a suitable base (furniture), with enough space around it for ventilation (3~4 inches). Make sure the ventilation slots are not covered. Before moving the player, ensure the disc tray is empty. This player is designed for continuous use. Switching off the DVD player to the stand-by mode does not disconnect the electrical supply. In order to disconnect the player completely from the power supply, remove the main plug from the wall outlet, especially when left unused for a long period of time.

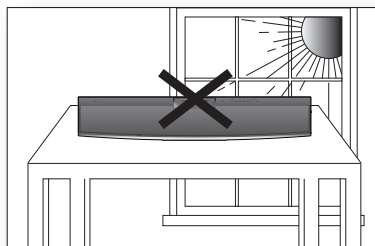
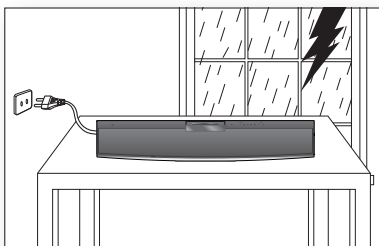

During thunderstorms, disconnect the AC main plug from the wall outlet. Voltage peaks due to lightning could damage the unit.

Do not expose the unit to direct sunlight or other heat sources. This could lead to overheating and malfunction of the unit.

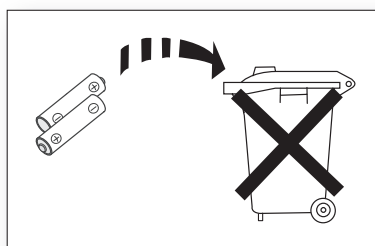
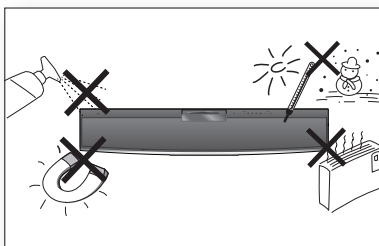

Protect the player from moisture (i.e. vases), and excess heat (e.g. fireplace) or equipment creating strong magnetic or electric fields (i.e. speakers...). Disconnect the power cable from the AC supply if the player malfunctions. Your player is not intended for industrial use. Use of this product is for personal use only.

The batteries used with this product contain chemicals that are harmful to the environment. Do not dispose of batteries in the general household trash.

Condensation may occur if your player or disc has been stored in cold temperatures. If transporting the player during the winter, wait approximately 2 hours until the unit has reached room temperature before using.

This product is covered by one or more of the following U.S. patents:

5,060,220	5,457,669	5,561,649	5,705,762	6,043,912	6,438,099	6,467,061	6,556,521	6,578,163	6,697,307	6,728,474
6,771,891	6,894,963	6,895,593	6,937,815	6,996,327	7,009,926	7,085,221	7,088,649	7,092,327	7,099,566	7,123,564
7,142,493	7,142,495	7,145,861	7,146,624	7,151,729	7,161,879	7,164,647	7,167,437	7,173,891	7,177,250	7,194,187
7,203,891	7,209,423	7,210,067	7,228,062	7,245,566	7,245,567	7,257,065	7,263,045	7,269,110	7,272,086	7,272,106
7,280,460	7,283,729	7,286,454	7,304,938							

This device is protected by U.S. Patent Nos.

6,836,549; 6,381,747; 7,050,698; 6,516,132; and 5,583,936.

This product is covered by the following U.S. patents:

US4,930,158 US4,930,160

contents

FEATURES	2	What's included
2		
SAFETY INFORMATION	3	Safety Warnings
	4	Important Safety Instructions
	5	Precautions
3		
GETTING STARTED	8	Before Reading the User's Manual
	9	Playable Discs
	9	Do not use the following types of discs!
	9	Copy Protection
	10	Disc Type and Characteristics
8		
DESCRIPTION	11	Front Panel
	12	Rear Panel
11		
REMOTE CONTROL	13	Setting the Remote Control
	14	Tour of the Remote Control
13		
CONNECTIONS	17	Connecting the Wireless Subwoofer
	18	Installing the Wall Mount
	19	Connecting the Video Out to your TV
	21	HDMI Function
	22	Connecting Audio from External Components
	24	Connecting the FM Antenna
17		
BEFORE USING YOUR HOME THEATER	25	Before Using Your Home Theater
25		
PLAYBACK	26	Disc Playback
	27	MP3/WMA-CD Playback
	28	JPEG File Playback
	29	DivX Playback
	31	Using the Playback Function
	39	Using Bluetooth
	41	Playing Media Files using the USB Host Feature
26		

SYSTEM SETUP	43	Setting the Language
43	44	Setting TV Screen Type
	45	Setting Parental Controls (Rating Level)
	45	Setting the Password
	46	Setting the Wallpaper
	46	To Select One of the 3 Wallpaper Settings You've Made
	47	DVD Playback Mode
	47	Setting the DRC (Dynamic Range Compression)
	48	Setting the AV SYNC
	48	Setting the HDMI Audio
	48	Setting the Audio

RADIO	49	Listening to Radio
49	49	Presetting Stations

CONVENIENT FUNCTION	50	Sleep Timer Function
50	50	Adjusting Display Brightness
	50	Mute Function
	51	V-SOUND (Virtual Sound)
	51	S.VOL (Smart Volume)
	51	P.BASS/Audio Upscaling

TROUBLESHOOTING	52	Troubleshooting
------------------------	----	-----------------

LANGUAGE CODE LIST	54	Language Code List
---------------------------	----	--------------------

USB HOST FEATURE SUPPORTED PRODUCTS	55	Digital Camera
55	55	USB Flash Disc
	55	MP3 Player







APPENDIX	56	Cautions on Handling and Storing Discs
56	57	Specifications
	58	Warranty

getting started

BEFORE READING THE USER'S MANUAL

Make sure to check the following terms before reading the user manual.

Icons that will be used in manual

Icon	Term	Definition
	DVD	This involves a function available with DVD or DVD-R/DVD-RW discs that have been recorded and finalized in Video Mode.
	CD	This involves a function available with a data CD (CD-R or CD-RW).
	MP3	This involves a function available with CD-R/-RW discs.
	JPEG	This involves a function available with CD-R/-RW discs.
	DivX	This involves a function available with MPEG4 discs. (DVD±R/RW, CD-R or CD-RW)
	Caution	This involves a case where a function does not operate or settings may be cancelled.
	Note	This involves tips or instructions on the page that help each function operate.



- In this manual, the instructions marked with "DVD ()" are applicable to DVD-VIDEO, DVD-AUDIO and DVD-R/-RW discs that have been recorded in Video Mode and then finalized. Where a particular DVD type is mentioned, it is indicated separately.
 - If a DVD-R/-RW disc has not been recorded properly in DVD Video format, it will not be playable.

About the use of this user's manual

- 1) Be sure to be familiar with Safety Instructions before using this product. (See pages 3~4)
- 2) If a problem occurs, check the Troubleshooting. (See pages 52~53)

Copyright

©2008 Samsung Electronics Co.,Ltd.

All rights reserved; No part or whole of this user's manual may be reproduced or copied without the prior written permission of Samsung Electronics Co.,Ltd.



DVD (Digital Versatile Disc) offers fantastic audio and video, thanks to Dolby Digital surround sound and MPEG-2 video compression technology. Now you can enjoy these realistic effects in the home, as if you were in a movie theater or concert hall.



DVD players and the discs are coded by region. These regional codes must match in order for the disc to play. If the codes do not match, the disc will not play.

The Region Number for this player is given on the rear panel of the player.

(Your DVD player will only play DVDs that are labeled with identical region codes.)

PLAYABLE DISCS

Disc Type	Mark (Logo)	Recorded Signals	Disc Size	Max. Playing Time
DVD-AUDIO DVD-VIDEO		AUDIO + VIDEO	5 inches	Approx. 240 min. (single-sided)
				Approx. 480 min. (double-sided)
			3 1/2 inches	Approx. 80 min. (single-sided)
				Approx. 160 min. (double-sided)
AUDIO-CD		AUDIO	5 inches	74 min.
			3 1/2 inches	20 min.
DivX		AUDIO + VIDEO	5 inches	—
			3 1/2 inches	—

DO NOT USE THE FOLLOWING TYPES OF DISCS !

- LD, CD-G, CD-I, CD-ROM, DVD-RAM and DVD-ROM discs cannot be played on this player. If such discs are played, a <WRONG DISC FORMAT> message appears on the TV screen.
- DVD discs purchased abroad may not play on this player. If such discs are played, a <CAN'T PLAY THIS DISC PLEASE, CHECK REGION CODE> message appears on the TV screen.

COPY PROTECTION

- Many DVD discs are encoded with copy protection. Because of this, you should only connect your DVD player directly to your TV, not to a VCR. Connecting to a VCR results in a distorted picture from copy-protected DVD discs.
- This product incorporates copyright protection technology that is protected by methods claims of certain U.S. patents and other intellectual property rights owned by Macrovision Corporation and other rights owners. Use of this copyright protection technology must be authorized by Macrovision Corporation, and is intended for home and other limited viewing uses only unless otherwise authorized by Macrovision Corporation. Reverse engineering or disassembly is prohibited.

getting started

DISC TYPE AND CHARACTERISTICS

This product does not support Secure (DRM) Media files.

❖ CD-R Discs

- Some CD-R discs may not be playable depending on the disc recording device (CD-Recorder or PC) and the condition of the disc.
- Use a 650MB/74 minute CD-R disc.
Do not use CD-R discs over 700MB/80 minute as they may not be played back.
- Some CD-RW (Rewritable) media, may not be playable.
- Only CD-Rs that are properly "closed" can be fully played. If the session is closed but the disc is left open, you may not be able to fully play the disc.

❖ CD-R MP3 Discs

- Only CD-R discs with MP3 files in ISO 9660 or Joliet format can be played.
- MP3 file names should be 8 characters or less in length and contain no blank spaces or special characters (. / = +).
- Use discs recorded with a compression/decompression data rate greater than 128Kbps.
- Only files with the ".mp3" and ".MP3" extensions can be played.
- Only a consecutively written multisession disc can be played. If there is a blank segment in the Multisession disc, the disc can be played only up to the blank segment.
- If the disc is not closed, it will take longer to begin playback and not all of the recorded files may be played.
- For files encoded in Variable Bit Rate (VBR) format, i.e. files encoded in both low bit rate and high bit rate (e.g., 32Kbps ~ 320Kbps), the sound may skip during playback.
- A maximum of 500 tracks can be played per CD.
- A maximum of 300 folders can be played per CD.

❖ CD-R JPEG Discs

- Only files with the ".jpg" extensions can be played.
- If the disc is not closed, it will take longer to start playing and not all of the recorded files may be played.
- Only CD-R discs with JPEG files in ISO 9660 or Joliet format can be played.
- JPEG file names should be 8 characters or less in length and contain no blank spaces or special characters (. / = +).
- Only a consecutively written multisession disc can be played. If there is a blank segment in the multisession disc, the disc can be played only up to the blank segment.
- A maximum of 9,999 images can be stored on a single CD.
- When playing a Kodak/Fuji Picture CD, only the JPEG files in the picture folder can be played.
- Picture discs other than Kodak/Fuji Picture CDs may take longer to start playing or may not play at all.

❖ DVD±R/RW, CD-R/RW DivX Discs

- Since this product only provides encoding formats authorized by DivX Networks, Inc., a DivX file created by the user might not play.
- Software updates for incompatible formats are not supported.
(Example : QPEL, GMC, resolution higher than 800 x 600 pixels, etc.)
- Sections with a high frame rate might not be played while playing a DivX file.
- For more information about the formats authorized by DivX Networks, Inc., please visit "www.divxnetworks.net".

description

FRONT PANEL

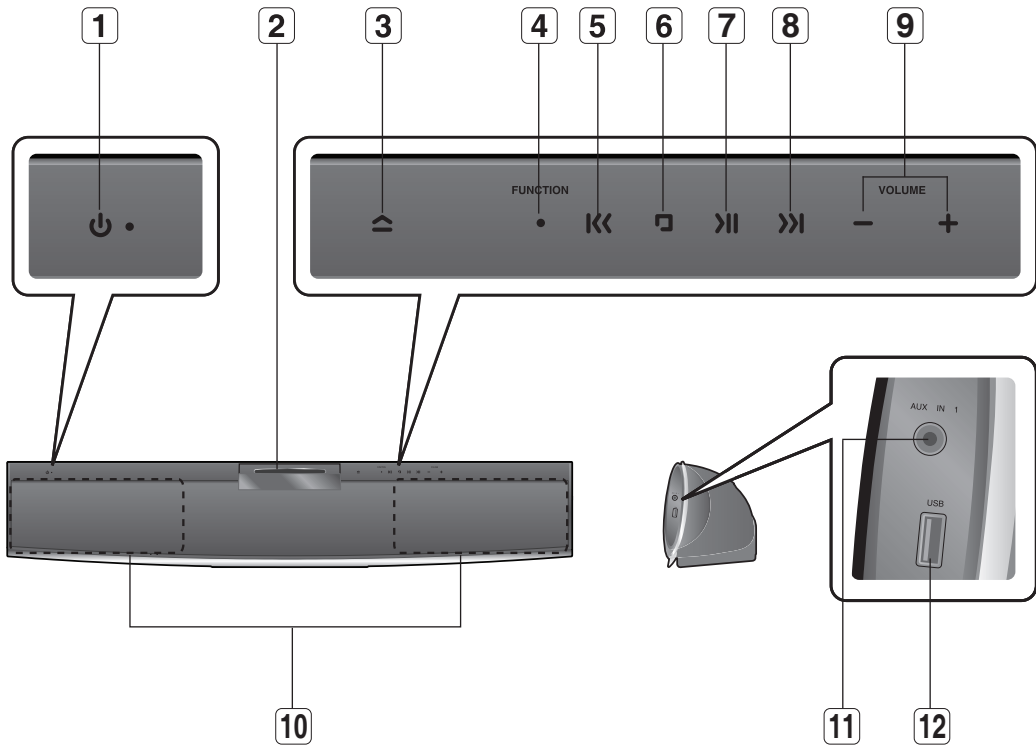

1 POWER(⏻) BUTTON	5 TUNING DOWN & SKIP (⏮) BUTTON	9 Volume Control
2 DISC SLOT (behind cover)	6 STOP (■) BUTTON	10 SPEAKERS
3 EJECT BUTTON	7 PLAY/PAUSE (⏮) BUTTON	11 AUX IN 1 Jack
4 FUNCTION BUTTON	8 TUNING UP & SKIP (⏭) BUTTON	12 USB Port

description

REAR PANEL

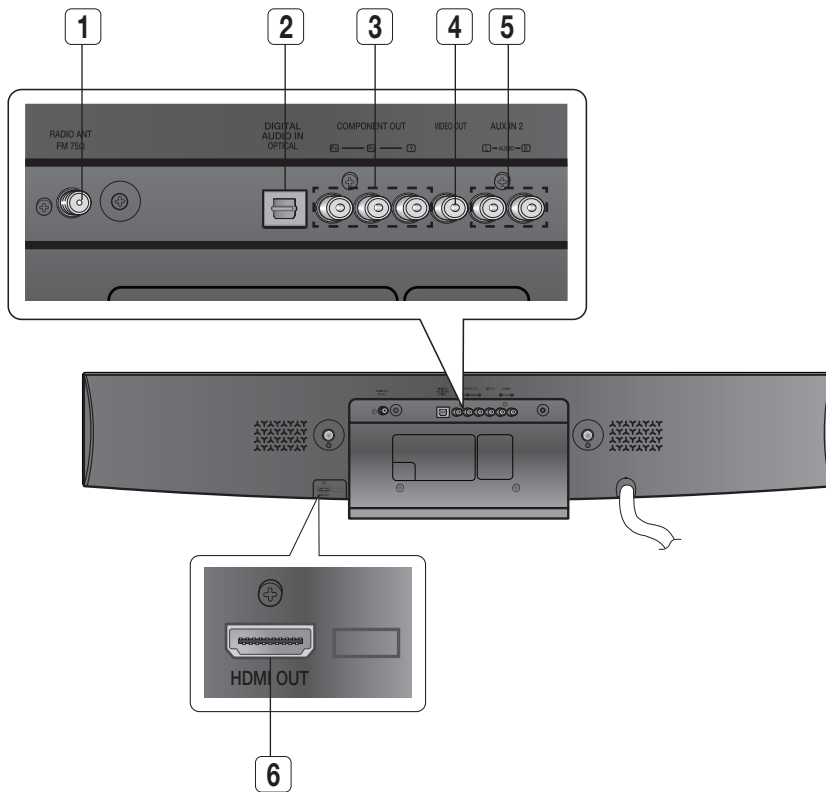

1	FM 75Ω COAXIAL JACK	Connect the FM antenna.
2	EXTERNAL DIGITAL OPTICAL INPUT JACK	Use this to connect external equipment capable of digital output.
3	COMPONENT VIDEO OUTPUT JACKS	Connect a TV with Component video inputs to these jacks.
4	VIDEO OUTPUT JACK	Connect the TV's Video Input jack (VIDEO IN) to the VIDEO OUT jack.
5	AUX IN 2 JACKS	Connect to the 2CH analog output of an external device (such as a VCR)
6	HDMI OUT JACK	Using an HDMI cable, connect this HDMI output terminal to the HDMI input terminal on your TV for the best quality picture.

remote control

SETTING THE REMOTE CONTROL

You can control certain functions of your TV with this remote control.

When operating a TV with the remote control

1. Press the **TV** button to set the remote to TV mode.
2. Press the **POWER** button to turn on the TV.
3. While holding down the **POWER** button, enter the code corresponding to your brand of TV.
 - If there is more than one code listed for your TV in the able, enter one at a time to determine which code works.

Example : For a Samsung TV

While holding down the **POWER** button, use the **number** buttons to enter 00, 15, 16, 17 and 40.

4. If the TV turns off, the setting is complete.
 - You can use the TV POWER, VOLUME, CHANNEL, and Numeric buttons (0~9).

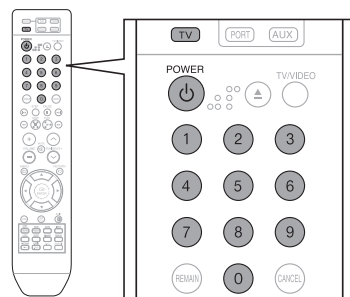

- The remote control may not work on some brands of TVs. Also, some operations may not be possible depending on your brand of TV.
- If you do not set the remote control with the code for your brand of TV, the remote control will work on a Samsung TV by default.

Operation Range of the Remote Control



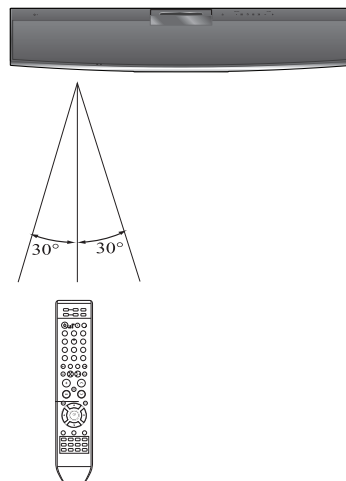



The remote control can be used up to approximately 23 feet (7 meters) in a straight line. It can also be operated at a horizontal angle of up to 30° from the remote control sensor.

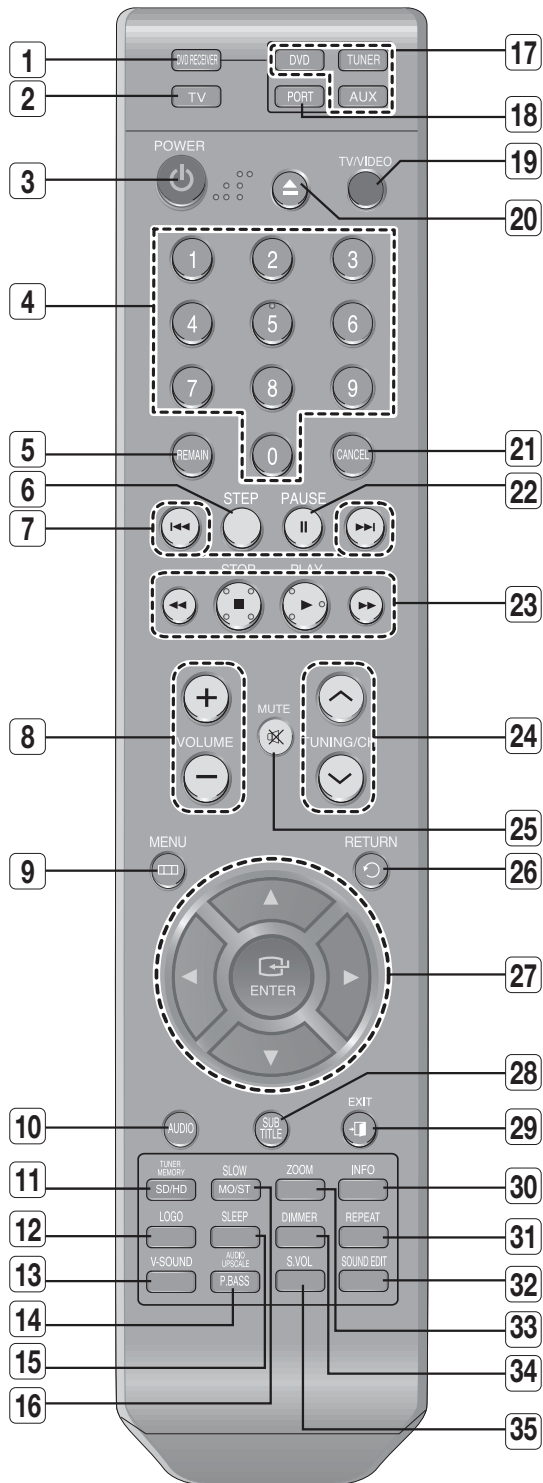

remote control

TOUR OF THE REMOTE CONTROL



1	DVD RECEIVER button
2	TV button
3	POWER button
4	Number (0-9) buttons
5	REMAIN button
6	STEP button
7	Tuning Preset/CD Skip buttons
8	VOLUME button
9	MENU button
10	AUDIO button
11	TUNER MEMORY, SD(Standard Definition)/HD(High Definition) button
12	LOGO button
13	V-SOUND(Virtual Sound) button
14	AUDIO UPSCALE/P.BASS button
15	SLEEP button
16	SLOW, MO/ST button
17	 DVD button  TUNER button  AUX button
18	PORT button
19	TV/VIDEO button
20	 EJECT button
21	CANCEL button
22	PAUSE button
23	 PLAY button  STOP button  SEARCH buttons
24	TUNING/CH button
25	MUTE button
26	RETURN button
27	Cursor/ENTER button
28	SUBTITLE button
29	EXIT button
30	INFO button
31	REPEAT button
32	SOUND EDIT button
33	ZOOM button
34	DIMMER button
35	S.VOL(Smart Volume) button

Insert Remote Batteries

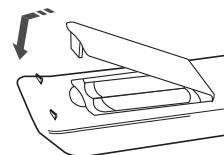
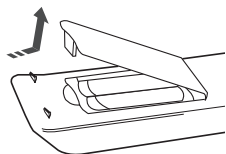

1. Remove the battery cover in the direction of the arrow.

2. Insert two 1.5V AAA batteries, paying attention to the correct polarities (+ and -).

3. Replace the battery cover.



Follow these precautions to avoid leaking or cracking cells:

- Place batteries in the remote control so they match the polarity : (+) to (+) and (-) to (-).
- Use the correct type of batteries. Batteries that look similar may differ in voltage.
- Always replace both batteries at the same time.
- Do not expose the batteries to heat or a flame.

remote control

TV Brand Code List

No.	Brand	Code	No.	Brand	Code
1	Admiral (M.Wards)	56, 57, 58	44	MTC	18
2	A Mark	01, 15	45	NEC	18, 19, 20, 40, 59, 60
3	Anam	01, 02, 03, 04, 05, 06, 07, 08, 09, 10, 11, 12, 13, 14	46	Nikei	03
			47	Onking	03
4	AOC	01, 18, 40, 48	48	Onwa	03
5	Bell & Howell (M.Wards)	57, 58, 81	49	Panasonic	06, 07, 08, 09, 54, 66, 67, 73, 74
6	Brocsonic	59, 60	50	Penney	18
7	Candle	18	51	Philco	03, 15, 17, 18, 48, 54, 59, 62, 69, 90
8	Cetronic	03	52	Philips	15, 17, 18, 40, 48, 54, 62, 72
9	Citizen	03, 18, 25	53	Pioneer	63, 66, 80, 91
10	Cinema	97	54	Portland	15, 18, 59
11	Classic	03	55	Proton	40
12	Concerto	18	56	Quasar	06, 66, 67
13	Contec	46	57	Radio Shack	17, 48, 56, 60, 61, 75
14	Coronado	15	58	RCA/Proscan	18, 59, 67, 76, 77, 78, 92, 93, 94
15	Craig	03, 05, 61, 82, 83, 84	59	Realistic	03, 19
16	Croslex	62	60	Sampo	40
17	Crown	03	61	Samsung	00, 15, 16, 17, 40, 43, 46, 47, 48, 49, 59, 60, 98
18	Curtis Mates	59, 61, 63			
19	CXC	03	62	Sanyo	19, 61, 65
20	Daewoo	02, 03, 04, 15, 16, 17, 18, 19, 20, 21, 22, 23, 24, 25, 26, 27, 28, 29, 30, 32, 34, 35, 36, 48, 59, 90	63	Scott	03, 40, 60, 61
			64	Sears	15, 18, 19
21	Daytron	40	65	Sharp	15, 57, 64
22	Dynasty	03	66	Signature 2000 (M.Wards)	57, 58
23	Emerson	03, 15, 40, 46, 59, 61, 64, 82, 83, 84, 85	67	Sony	50, 51, 52, 53, 55
24	Fisher	19, 65	68	Soundesign	03, 40
25	Funai	03	69	Spectricon	01
26	Futuretech	03	70	SSS	18
27	General Electric (GE)	06, 40, 56, 59, 66, 67, 68	71	Sylvania	18, 40, 48, 54, 59, 60, 62
28	Hall Mark	40	72	Symphonic	61, 95, 96
29	Hitachi	15, 18, 50, 59, 69	73	Tatung	06
30	Inkel	45	74	Techwood	18
31	JC Penny	56, 59, 67, 86	75	Teknika	03, 15, 18, 25
32	JVC	70	76	TMK	18, 40
33	KTV	59, 61, 87, 88	77	Toshiba	19, 57, 63, 71
34	KEC	03, 15, 40	78	Vidtech	18
35	KMC	15	79	Videch	59, 60, 69
36	LG (Goldstar)	01, 15, 16, 17, 37, 38, 39, 40, 41, 42, 43, 44	80	Wards	15, 17, 18, 40, 48, 54, 60, 64
37	Luxman	18	81	Yamaha	18
38	LXI (Sears)	19, 54, 56, 59, 60, 62, 63, 65, 71	82	York	40
39	Magnavox	15, 17, 18, 48, 54, 59, 60, 62, 72, 89	83	Yupiteru	03
40	Marantz	40, 54	84	Zenith	58, 79
41	Matsui	54	85	Zonda	01
42	MGA	18, 40	86	Dongyang	03, 54
43	Mitsubishi/MGA	18, 40, 59, 60, 75			

connections

This section involves various methods of connecting the Digital Home Theater to other external components. Before moving or installing the product, be sure to turn off the power and disconnect the power cord.

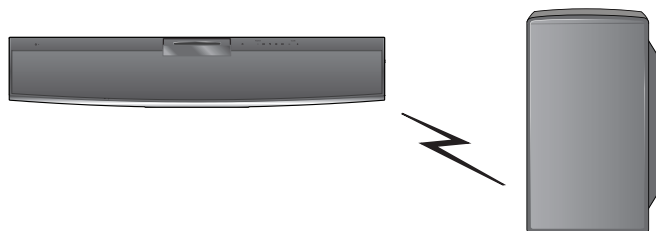

CONNECTING THE WIRELESS SUBWOOFER

Press the **POWER** button on the rear of the subwoofer to turn it on.

- If the main unit is turned on
The subwoofer will be automatically connected to the product and the Link LED on its front will blink blue for a few seconds.
- If the main unit is turned off
The Link LED on the front of the subwoofer will blink blue for about 30 seconds, then will change to red as the sub switches to STANDBY mode.

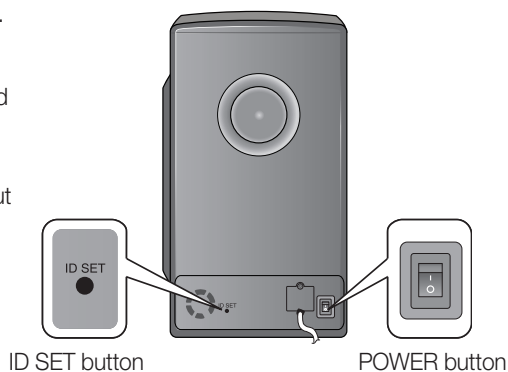

- If the subwoofer is turned off, you will see **S/W CHECK** on the display panel of the main unit.
- Place the wireless subwoofer under the main unit.
- If you use a device such as a microwave oven, wireless LAN Card, Bluetooth equipment, or any other device that uses the same frequency (5.8GHz) near the system, some sound interruption may be heard due to interference.
- The transmission distance of radio wave is about 32 feet, 9.7 inches, but may vary depending on your operating environment. If a steel-concrete wall or metallic wall is between the main unit and the wireless subwoofer, the system may not operate at all, because the radio wave cannot penetrate metal.
- If the main unit doesn't make wireless connection, the system needs ID Setting between the main unit and wireless subwoofer. With the main unit turned off, press the remote control's "0"→"1"→"3"→"5" number buttons and the unit will turn on. With the wireless subwoofer turned on, press **ID SET** button on the back of the unit for 5 seconds.



- The wireless receiving antenna is built into the wireless subwoofer. Keep the unit away from water and moisture.
- For optimal listening performance, make sure that the area around the wireless subwoofer location is clear of any obstructions.

connections

INSTALLING THE WALL MOUNT

1. Place the Mounting Studs on the rear of the product and turn them clockwise to fix.

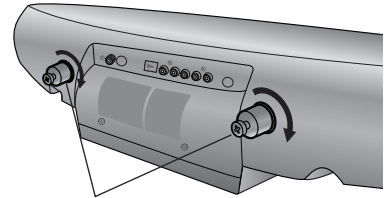

Mounting Studs (2EA)
(supplied)

2. Place the wall mount bracket on a wall surface so that the arrow on it points upward, and then secure it with four screws (not supplied).

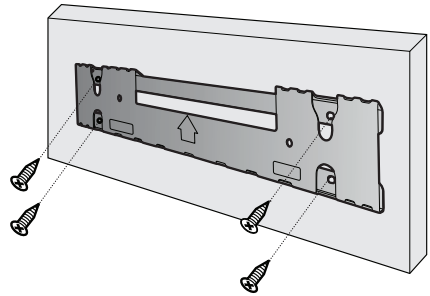

3. Then, fit the product (Mounting Studs installed) into the corresponding hole of the wall mount bracket. For secure installation, make sure the mounting studs go down to the bottom of the hole.

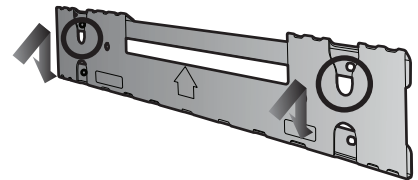

4. This is the completion of the wall mount installation.

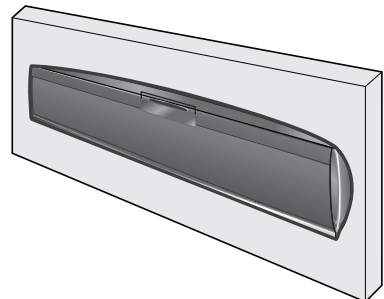

- Secure the Home Theater firmly to the wall so that it does not fall off. If the Home theater falls off, it may result in an injury or damage to the product.
- When the Home Theater is installed on wall, please make sure that a child does not pull any of connecting cables. as it may cause it to fall.

CONNECTING THE VIDEO OUT TO YOUR TV

Choose one of the three methods for connecting to a TV.

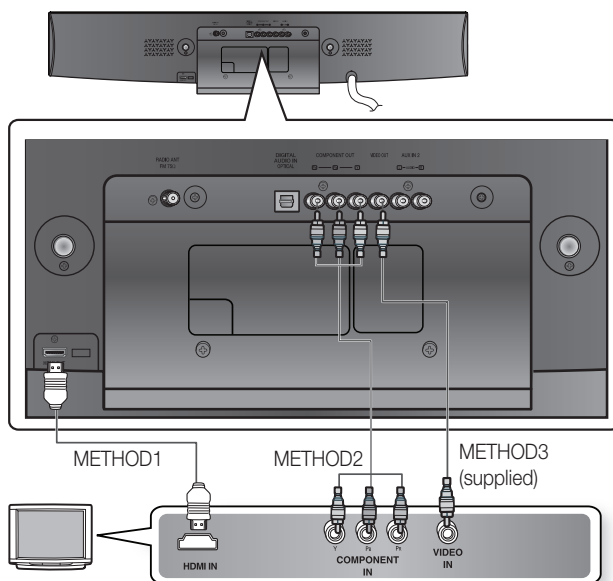

METHOD 1 : HDMI (BEST QUALITY)

Connect the HDMI cable (not supplied) from the HDMI OUT jack on the back of the DVD Player to the HDMI IN jack on your TV.



METHOD 2 : Component Video (BETTER QUALITY)

If your television is equipped with Component Video inputs, connect a Component video cable(not supplied) from the Component Video Output (Pr, Pb and Y) jacks on the back of the DVD Player to the Component Video Input jacks on your TV.

METHOD 3 : Composite Video (GOOD QUALITY)

Connect the supplied Video cable from the VIDEO OUT jack on the back of the DVD Player to the VIDEO IN jack on your TV.



- This product operates in Interlace scan mode (480i) for Component output.
- If you use an HDMI cable to connect a Samsung TV to the DVD Player, you can operate the Home Theater using the TV's remote control. This is only available with SAMSUNG TVs that support Anynet+(HDMI-CEC).
- Please check the  logo (If your TV has an  logo, then it supports the Anynet+ function.)

connections

CONNECTING THE VIDEO OUT TO YOUR TV (CON'T)

HDMI Auto Detection Function

The player's video output will automatically change to HDMI mode when connecting an HDMI cable while power is on.

- **HDMI (High Definition Multimedia Interface)**

HDMI is an interface that enables the digital transmission of video and audio data with just a single connector. Using HDMI, the DVD Home Theater transmits a digital video and audio signal and displays a vivid picture on a TV having an HDMI input jack.

- **HDMI connection description**

HDMI connector - Supports video and digital audio data.

- HDMI outputs only a pure digital signal to the TV.

- If your TV does not support HDCP (High-bandwidth Digital Content Protection), random noise appears on the screen.

- **Why does Samsung use HDMI?**

Analog TVs require an analog video/audio signal. However, when playing a DVD, the data transmitted to a TV is digital. Therefore either a digital-to-analog converter (in the DVD Home Theater) or an analog-to-digital converter (in the TV) is required. During this conversion, the picture quality is degraded due to noise and signal loss. HDMI technology is superior because it requires no D/A conversion and is a pure digital signal from the player to your TV.

- **What is the HDCP?**

HDCP (High-band width Digital Content Protection) is a system for protecting DVD content outputted via HDMI from being copied. It provides a secure digital link between a video source (PC, DVD, etc) and a display device (TV, projector, etc). Content is encrypted at the source device to prevent unauthorized copies from being made.

- **What is Anynet+?**

Anynet+ is a convenient function that offers linked operation of this unit through Samsung TVs with the Anynet+ feature.

- If your Samsung TV has an  logo, then it supports the Anynet+ function.

- If you turn on the player and insert a disc, the player will start playing the disc, and the TV will turn on automatically and switch to HDMI mode.

- If you turn on the player and press the Play button with a disc already inserted, the TV will immediately turn on and switch to HDMI mode.

HDMI FUNCTION

Resolution Selection

This function allows the user to select the screen resolution for HDMI output.

In Stop mode, press and hold the **SD/HD** (Standard Definition/High Definition) button on the remote control.

- Resolutions available for the HDMI output are 480p, 720p, 1080i/1080p.
- SD(Standard Definition) resolution is 480p and HD (High Definition) resolution is 720p, 1080i/1080p. The default value of HDMI output is 480p.

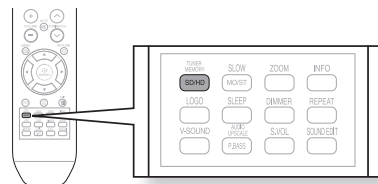

- If the TV does not support the configured resolution, you will not be able to see the picture properly.
- When an HDMI cable is connected, composite and component video signals are not output.
- See your TV owner's manual for more information on how to select the TV's Video Input source.

Why use HDMI (High Definition Multimedia Interface)?

This device transmits a DVD video signal digitally without the process of converting to analog. You will get sharper digital pictures when using an HDMI connection.

Using Anynet+(HDMI-CEC)

Anynet+ is a function that enables you to control other Samsung Devices with your Samsung TV's remote control. Anynet+ can be used by connecting this Home Theater to a SAMSUNG TV using an HDMI Cable. This is only available with SAMSUNG TVs that support Anynet+.

1. Connect the main unit of the Home Theater to a Samsung TV with an HDMI cable. (See page 19)
2. Set the Anynet+ function on your TV. (See the TV instruction manual for more information.)
 - You can operate the Home Theater by using the TV remote control. (Available TV buttons : ◀, ■, ▶, ▶▶, ▲, ▼ and ◀▶ buttons, 0 ~ 9 button)

With Anynet+

You can operate this unit, power on your TV, or watch a movie by pressing the Play button on your Samsung TV's remote control.

If you select the TV

Set the Anynet+(HDMI-CEC) to On by pressing the Anynet+ button on your TV remote control.

- **Receiver : On** : You can listen to audio through the Home Theater.
- **Receiver : Off** : You can listen to audio through the TV.

If you select the THEATER

Select **THEATER to connect** and set the option of each item below.

- **View TV** : If Anynet+(HDMI CEC) is set to on and you select View TV, the home theater will automatically switch to digital in mode.
- **Theater Menu** : you can access and control the Home theater menu.
- **Theater Operation** : The Home Theater disc playback information will be displayed. You can control the Disc operation of the Home Theater such as title, chapter and subtitle change.
- **Receiver : On** : You can listen to audio through the Home Theater.
- **Receiver : Off** : You can listen to audio through the TV.

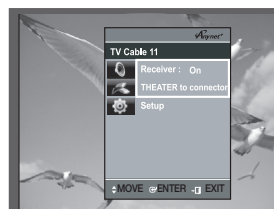

- If you chose "View TV" and you want to listen to TV sound through Digital In of the Home theater, you have to connect an optical cable between the TV and the Home Theater.

connections

CONNECTING AUDIO FROM EXTERNAL COMPONENTS

AUX1 : Connecting an External Component/MP3 player

Components such as an MP3 Player

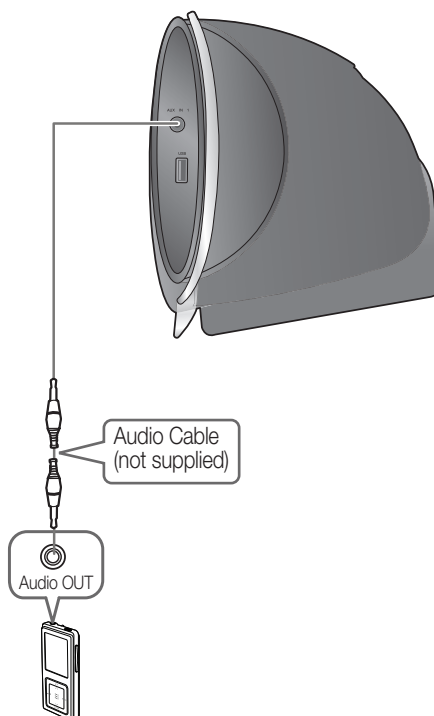

1. Connect AUX IN 1 (Audio) on the Home Theater to the Audio Out of the external component/MP3 player.
2. Press the **AUX** button on the remote control to select **AUX1** input.
 - You can also use the **FUNCTION** button on the main unit.
The mode switches as follows :
DVD/CD → D.IN → AUX 1 → AUX 2 → USB → BT AUDIO → FM.

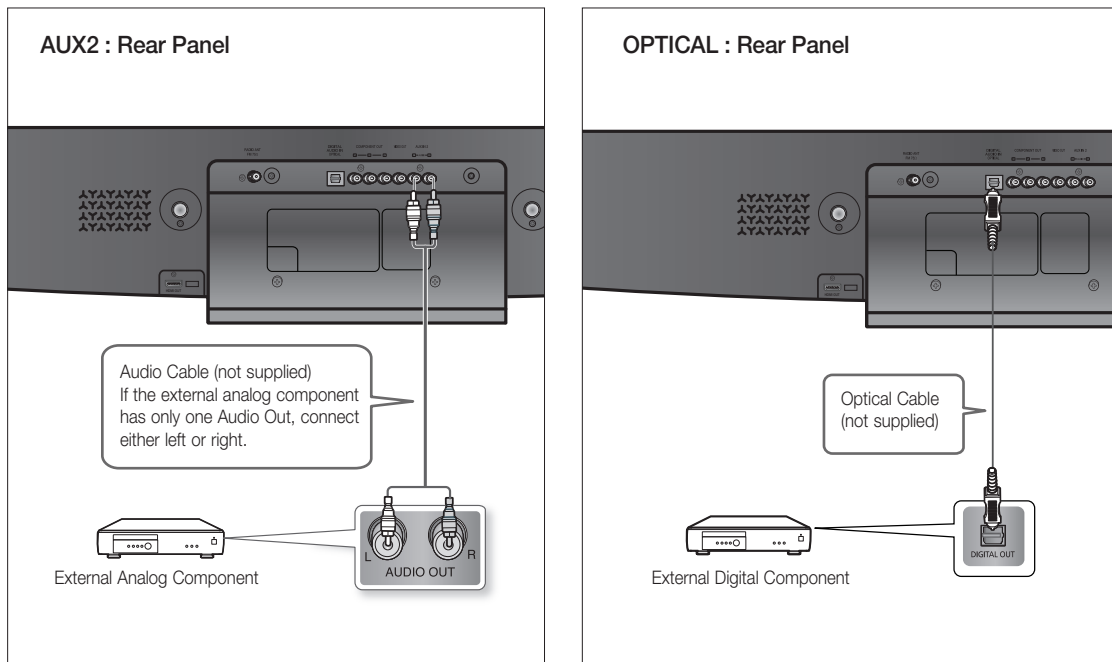

AUX2 : Connecting an External Analog Component

Analog signal components such as a VCR.

1. Connect AUX IN 2 (Audio) on the Home Theater to the Audio Out of the external analog component.
 - Be sure to match connector colors.
2. Press the **AUX** button on the remote control to select **AUX 2** input.
 - You can also use the **FUNCTION** button on the main unit.
The mode switches as follows :
DVD/CD → D.IN → AUX 1 → AUX 2 → USB → BT AUDIO → FM.



- You can connect the Video Output jack of your VCR to the TV, and connect the Audio Output jacks of the VCR to this product.

OPTICAL : Connecting an External Digital Component

Digital signal components such as a Cable Box/Satellite receiver (Set-Top Box).

1. Connect the Digital Input (OPTICAL) on the Home Theater to the Digital Output of the external digital component.
2. Press the **AUX** button on the remote control to select **DIGITAL IN**.
 - You can also use the **FUNCTION** button on the main unit.
The mode switches as follows :
DVD/CD → D.IN → AUX 1 → AUX 2 → USB → BT AUDIO → FM.

connections

CONNECTING THE FM ANTENNA

1. Connect the FM antenna supplied to the FM 75Ω COAXIAL Jack.
2. Slowly move the antenna wire around until you find a location where reception is good, then fasten it to a wall or other rigid surface.

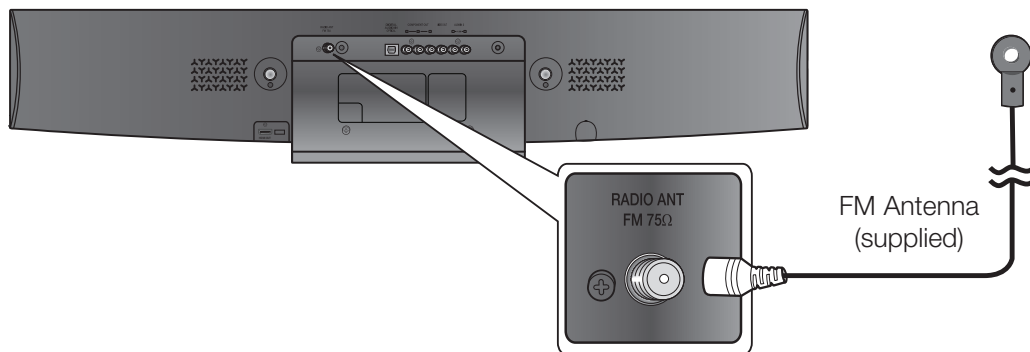

-
-  ■ This unit does not receive AM broadcasts.

before using your home theater

The DVD Home Theater's remote can be used to control Samsung TVs.

1. Plug the main unit's power cord into the AC power supply.



2. Press the **DVD RECEIVER** button to switch to DVD RECEIVER mode to operate the DVD Home Theater.
3. Press the **FUNCTION** button on the main unit or **DVD** button on the remote to enable DVD/CD playback.
4. Press the **TV** button to set the remote to TV mode.
5. Press the **POWER** button to turn on your Samsung TV with this remote.
6. Press the **TV/VIDEO** button to select VIDEO mode on your TV.

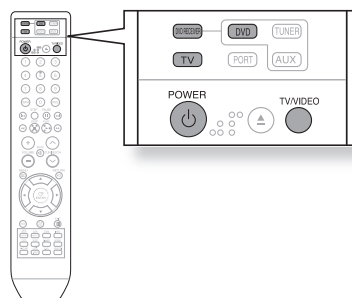

DISC PLAYBACK



1. Press the **EJECT** (⏏) button to open the Disc Slot cover.
2. Load a disc vertically into the Disc Insert Hole.
 - Place a disc gently into the tray with the disc's label facing up.
3. Close the compartment by pressing the **PLAY** (▶) button.
 - Playback starts automatically.

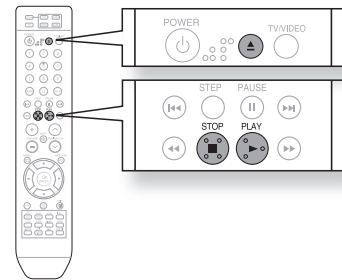

To stop playback, press the **STOP** (■) button during playback.

- If pressed once, **PRESS PLAY** is displayed and the stop position will be stored in memory. If the **PLAY** (▶) button or **ENTER** button is pressed, playback resumes from the stop position. (This function works only with DVDs.)
- If pressed twice, **STOP** is displayed, and if the **PLAY** (▶) button is pressed, playback starts from the beginning.

To temporarily pause playback, press the **PAUSE** (⏏) button during playback.

- To resume playback, press the **PLAY** (▶) button.



- Depending on the content of the disc, the initial screen may appear different.
- Pirated discs will not run in this player because it violates the CSS (Content Scrambling System : a copy protection system) recommendations.
- Do not put force on or pull out the door. This may cause damage to the door.

MP3/WMA-CD PLAYBACK

Data CDs (CD-R, CD-RW) encoded in MP3/WMA format can be played.



1. Load an MP3/WMA disc.
 - The MP3/WMA menu screen will appear and playback will start.
 - The appearance of the menu depends on the MP3/WMA disc.
 - WMA-DRM files cannot be played.
2. In Stop mode, use the Cursor **▲, ▼, ◀, ▶** button to select the album, and then press the **ENTER** button.
 - Use the Cursor **▲, ▼** button to select the track.
3. To change the album, use the Cursor **▲, ▼, ◀, ▶** button to select another album in Stop mode, and then press the **ENTER** button.
4. Press the **STOP** (■) button to stop playback.

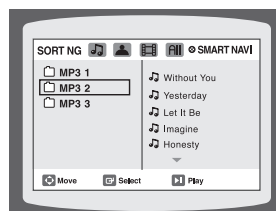
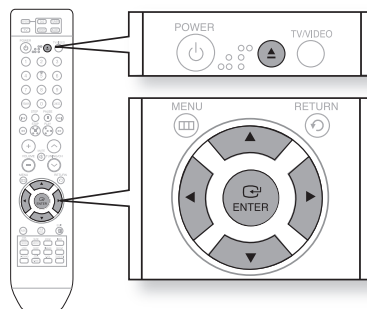

- Depending on the recording mode, some MP3/WMA-CDs may not play.
- Table of contents of a MP3-CD varies depending on the MP3/WMA track format recorded on the disc.

To play a file icon in the screen,

- Press the Cursor **▲, ▼, ◀, ▶** button when it is in Stop mode and select a desired icon from the top part of the menu.

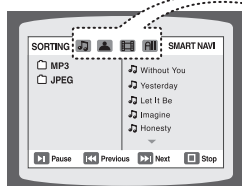

- Music File Icon** : To play music files only, select the icon.
- Image File Icon** : To view image files only, select the icon.
- Movie File Icon** : To view movie files only, select the icon.
- All File Icon** : To view all files, select the icon.

JPEG FILE PLAYBACK

Images captured with a digital camera or camcorder, or JPEG files on a PC can be stored on a CD and then played back with this Home Theater.

Rotate/Flip Function



Press the Cursor ▲, ▼, ◀, ▶ button during playback.

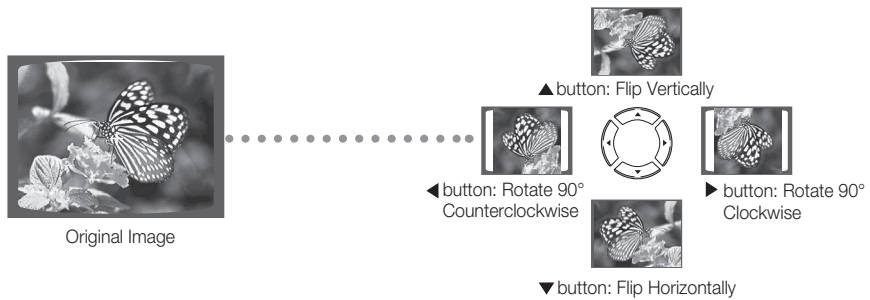
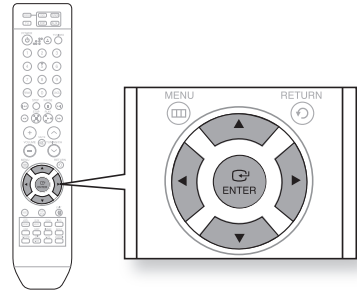

- The maximum resolutions supported by this product are 5120 x 3480 (or 19.0 MPixel) for standard JPEG files and 2048 x 1536 (or 3.0 MPixel) for progressive image files.
- If a JPEG file is played when the HDMI output resolution is 720p/1080i/1080p, the mode is automatically converted to 480p mode.

DIVX PLAYBACK

The functions on this page apply to DivX disc playback.

Skip Forward/Back

During playback, press the **◀▶** button.

- Goes to the next file whenever you press the **▶▶** button, if there are over 2 files in the disc.
- Goes to the previous file whenever you press the **◀◀** button, if there are over 2 files in the disc.

Fast Playback

During playback, press the **◀▶** button.

To play back the disc at a faster speed, press the **◀◀** or **▶▶** button during playback.

- Each time you press either button, the playback speed will change as follows:
2x → 4x → 8x → 32x → Normal.

5 Minutes Skip function

During playback, press the Cursor **◀▶** button.

- Playback skips 5 minutes forward whenever you press the Cursor **▶** button.
- Playback skips 5 minutes back whenever you press the Cursor **◀** button.

Audio Display

Press the **AUDIO** button.

- If there are multiple audio tracks on a disc, you can toggle between them.
- Each time you press the button, your selection will toggle between **AUDIO (1/N, 2/N ...)** and **🔇**.



▪ **🔇** is displayed when there is only one supported language in the disc.

Subtitle Display

Press the **SUBTITLE** button.

- Each time you press the button, your selection will toggle between **SUBTITLE (1/N, 2/N ...)** and **SUBTITLE OFF**.
- If the disc has only one subtitle file, it will be played automatically.
- See number 2 (Caption Function) below for more details concerning Subtitle usage with DivX discs.

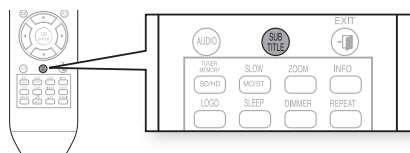
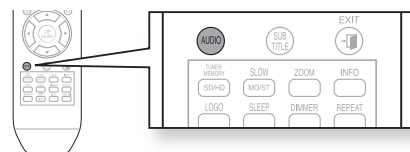
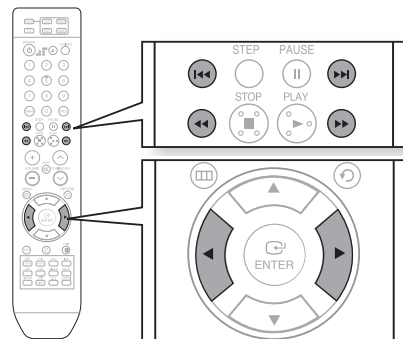

DIVX PLAYBACK (CON'T)



If the Disc has more than One Subtitle File

If the disc has more than one subtitle file, the default subtitle may not match the movie and you will have to select your subtitle language as follows:

1. In Stop mode, press the Cursor **▲,▼** button, select the desired subtitle  from the TV screen, and then press the **ENTER** button.
2. When you select the desired DivX file from the TV screen, the movie will be played normally.

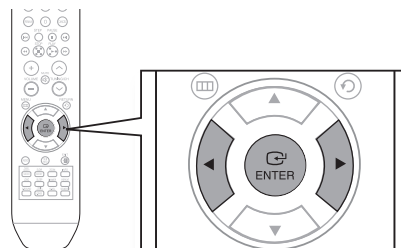

DivX(Digital internet video eXpress)

DivX is a video file format developed by Microsoft and is based on MPEG4 compression technology to provide audio and video data over the Internet in real-time.

MPEG4 is used for video encoding and MP3 for audio encoding so that the users can watch a movie at near DVD-quality video and audio.

1. Supported Formats

This product only supports the following media formats. If both video and audio formats are not supported, the user may experience problems such as broken images or no sound.

Supported Video Formats

Format	AVI	WMV
Supported Versions	DivX3.11 ~ DivX5.1, XviD	V1/V2/V3/V7

Supported Audio Formats

Format	MP3	WMA	AC3
Bit Rate	80~384kbps	56~128kbps	128~384kbps
Sampling Frequency	44.1khz		44.1/48khz

- Aspect Ratio : Although the default DivX resolution is 640x480 pixels (4:3), this product supports up to 800x600 pixels (16:9). TV screen resolutions higher than 800 will not be supported.
- When you play a disc whose sampling frequency is higher than 48khz or 320kbps, you may experience shaking on the screen during playback.

2. Caption Function

- You must have some experience with video extraction and editing in order to use this feature properly.
- To use the caption function, save the caption file (*.smi) in the same file name as that of the DivX media file (*.avi) within the same folder.
Example. Root Samsung_007CD1.avi
 Samsung_007CD1.smi
- Up to 60 alphanumeric characters or 30 East Asian characters (2 byte characters such as Korean and Chinese) for the file name.
- Official DivX® Certified product
- Plays all versions of DivX® video (including DivX® 6) with standard playback of DivX® media files

USING THE PLAYBACK FUNCTION

Displaying Disc Information



You can view disc playback information on the TV screen.

Press the **INFO** button.



- Depending on the disc, the disc information display may appear different.
- Depending on the disc, you can also select DOLBY DIGITAL, or PRO LOGIC.

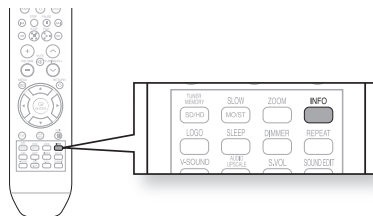

appears on the TV screen!

If this symbol appears on the TV screen when pressing a button, that operation is not possible with the disc currently being played.

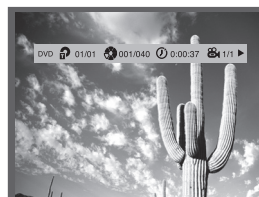

Checking the Remaining Time



Press the **REMAIN** button.

- For checking the total and remaining time of a title or chapter being played.

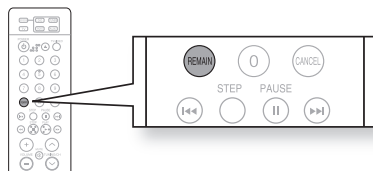

Each time the Remain button is pressed



TITLE ELAPSED → **TITLE REMAIN** → **CHAPTER ELAPSED** → **CHAPTER REMAIN**



GROUP ELAPSED → **GROUP REMAIN** → **TRACK ELAPSED** → **TRACK REMAIN**



TRACK ELAPSED → **TRACK REMAIN** → **TOTAL ELAPSED** → **TOTAL REMAIN**



TRACK REMAIN → **TRACK ELAPSED**

playback

USING THE PLAYBACK FUNCTION (CON'T)

Fast Playback



Press the **◀▶** button.

- Each time the button is pressed during playback, the playback speed changes as follows:

◀▶ 2X → **◀▶ 4X** → **◀▶ 8X** → **◀▶ 32X** → **PLAY**

▶▶ 2X → **▶▶ 4X** → **▶▶ 8X** → **▶▶ 32X** → **PLAY**

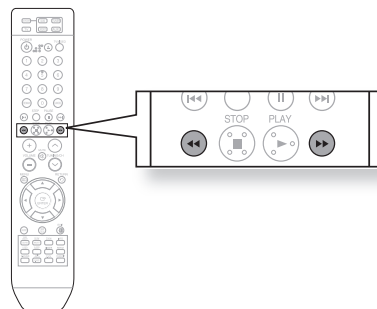

- During fast playback of a CD or MP3-CD, sound is heard only at 2x speed, and not at 4x, 8x, and 32x speeds.

Slow Playback



Press the **SLOW** button.

- Each time the button is pressed during playback, the playback speed changes as follows:

▶▶ 1/2 → **▶▶ 1/4** → **▶▶ 1/8** → **◀◀ 1/2** → **◀◀ 1/4** → **◀◀ 1/8** → **PLAY**

▶▶ 1/2 → **▶▶ 1/4** → **▶▶ 1/8** → **PLAY**

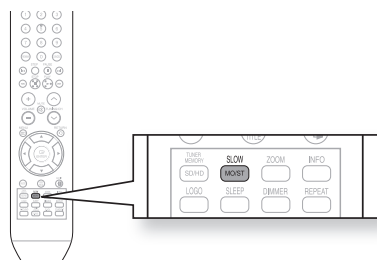

- No sound is heard during slow playback.
- Reverse slow playback does not work with DivX.

Skipping Scenes/Songs



Press the **◀▶** button.

- Each time the button is pressed during playback, the previous or next chapter, track or directory (file) will be played.
- You cannot skip chapters consecutively.

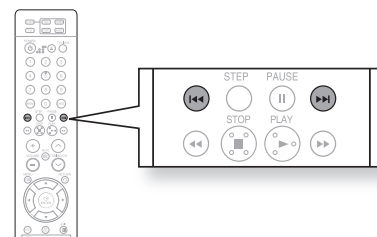

Repeat Playback



Repeat playback allows you to repeatedly play a chapter, title, track (song), or directory (MP3 file).

Press the **REPEAT** button.

- Each time the button is pressed during playback, the repeat playback mode changes as follows:

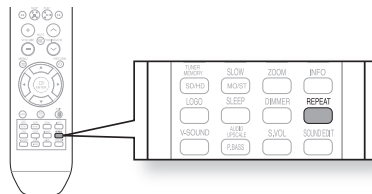

REPEAT : CHAPTER → **REPEAT : TITLE** → **REPEAT : OFF**



REPEAT : TRACK → **REPEAT : GROUP** → **REPEAT : OFF**



REPEAT : TRACK → **REPEAT : DISC** → **REPEAT : OFF**



REPEAT : OFF → **REPEAT : RANDOM** → **REPEAT : TRACK** → **REPEAT : DIR**
→ **REPEAT : DISC** → **REPEAT : OFF**

Repeat Playback Options

CHAPTER : Repeatedly plays the selected chapter.

TITLE : Repeatedly plays the selected title.

GROUP : Repeatedly plays the selected group.

RANDOM : Plays tracks in random order. (A track that has already been played may be played again.)

TRACK : Repeatedly plays the selected track.

DIR : Repeatedly plays all tracks in the selected folder.

DISC : Repeatedly plays the entire disc.

OFF : Cancels Repeat Playback.

To Select a Repeat Playback Mode in the Disc Information Screen



- Press the **INFO** button twice.
- Press the Cursor **▶** button to move to **REPEAT PLAYBACK** (🔄) display.
- Press the Cursor **▼** button to select the desired Repeat Playback mode.
 - To select another album and track, repeat Steps 2 and 3 above.
- Press the **ENTER** button.

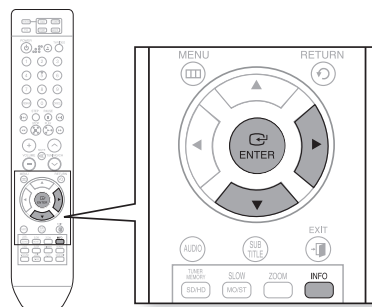

OFF → **A-** → **CHAP** → **TITLE** → **OFF**



OFF → **A-** → **TRACK** → **DISC** → **OFF**



- For DivX, MP3 and JPEG discs, you cannot select Repeat Play from the information display screen.

playback

USING THE PLAYBACK FUNCTION (CON'T)

A-B Repeat Playback



You can repeatedly play back a designated section of a DVD.

1. Press the **INFO** button twice.
2. Press the Cursor **▶** button to move to REPEAT PLAYBACK (⏮) display.
3. Press the Cursor **▲, ▼** button to select **A-** and then press the **ENTER** button.
 - When the **ENTER** button is pressed, the selected position will be stored in memory.
4. Press the **ENTER** button at the end of the desired segment.
 - The specified segment will be played repeatedly.

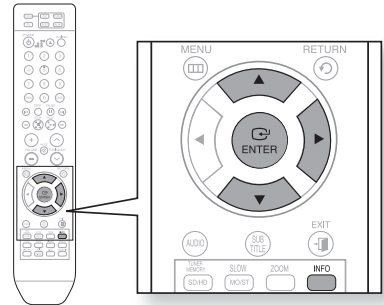

➤ To return to normal playback, press the Cursor **▲, ▼** button to select **⏮ OFF**.



- The A-B Repeat function does not operate with DivX, MP3 or JPEG discs.

Step Function



Press the **STEP** button.

- The picture moves forward one frame each time the button is pressed during playback.

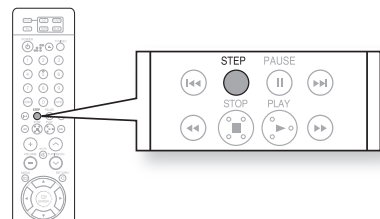

- No sound is heard during step motion playback.

Angle Function



This function allows you to view the same scene in different angles.

1. Press the **INFO** button.
2. Press the Cursor **▶** button to move to ANGLE () display.
3. Press the Cursor **▲, ▼** button or numeric buttons to select the desired angle.
 - Each time the button is pressed, the angle changes as follows:

1/3 → 2/3 → 3/3 → 1/3

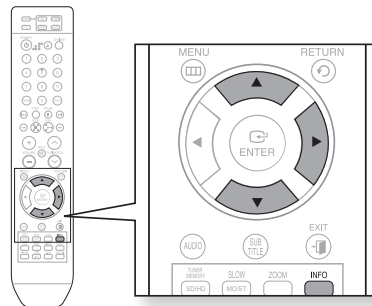

- The Angle function works only with discs on which multiple angles have been recorded.

Zoom (Screen Enlarge) Function



This function allows you to enlarge a particular area of the displayed image.

1. Press the **ZOOM** button.
2. Press the Cursor **▲, ▼, ◀, ▶** button to move to the area you want to enlarge.
3. Press the **ENTER** button.
 - Each time the button is pressed, the zoom level changes as follows:

ZOOM X 1.5 → **ZOOM X 2** → **ZOOM X 3**
→ **ZOOM OFF**

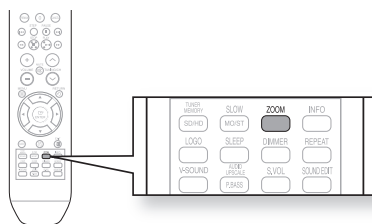

USING THE PLAYBACK FUNCTION (CON'T)

Bonus Group



Some DVD-Audio discs have an extra 'bonus' group that requires a 4-digit key number to access. See the disc packaging for details and the key number.

When you play a DVD-Audio disc that has a bonus group, the key number input screen appears automatically.

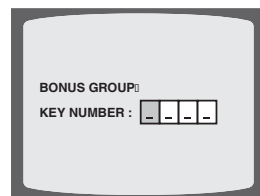

- If you eject the disc, switch the power off, or unplug the player, you will need to re-enter the key number.

Navigating Pages



During playback, press the **∇**, **▲** button on the remote control.

- You can select the desired image from a DVD-Audio disc containing still images.
- With some discs, you may not be able to select images.

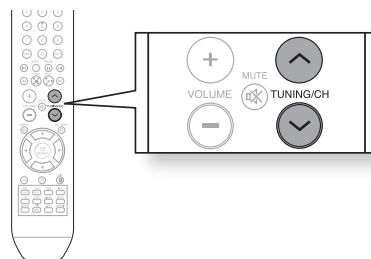

Audio Language Selection Function



1. Press the **INFO** button twice.
2. Press the Cursor **▲**, **▼** button or numeric buttons to select the desired audio language.
 - Depending on the number of languages on a DVD disc, a different audio language (ENGLISH, SPANISH, FRENCH, etc.) is selected each time the button is pressed.

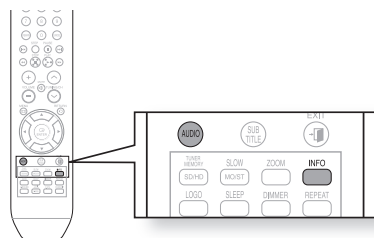

EN 1/3 → **SP 2/3** → **FR 3/3** → **EN 1/3**



- To operate this function, you can also press the AUDIO buttons on the remote control.
- Depending on the disc, the Audio Language functions may not be available.

Subtitle Language Selection Function



1. Press the **INFO** button twice.
2. Press the Cursor **▶** button to move to **SUBTITLE** (📄) display.
3. Press the Cursor **▼** button or numeric buttons to select the desired subtitle.

EN 01/03 → SP 02/03 → FR 03/03 → OFF/03 →
EN 01/03

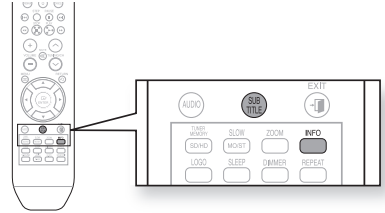

- To operate this function, you can also press the SUBTITLE buttons on the remote control.
- Depending on the disc, the Subtitle Language functions may not be available.

Moving Directly to a Scene/Song



1. Press the **INFO** button.
2. Press the Cursor **▲**, **▼** button or numeric buttons to select the desired title/track (📄) and then press the **ENTER** button.
3. Press the Cursor **◀**, **▶** button to move to the Chapter (🌀) display.
4. Press the Cursor **▲**, **▼** button or numeric buttons to select the desired chapter and then press the **ENTER** button.
5. Press the Cursor **◀**, **▶** button to move to time (🕒) display.
6. Press the numeric buttons to select the desired time and then press the **ENTER** button.

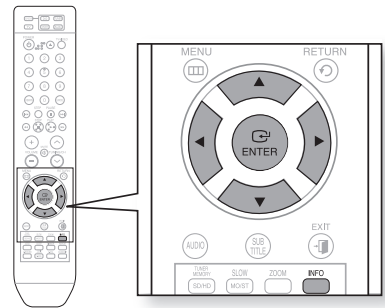

Press the **numeric** buttons.

- The selected file will be played.
- When playing an MP3 or JPEG disc, you cannot use the Cursor **▲**, **▼** button to move to a folder.
To move a folder, press the **STOP** (■) and then press the Cursor **▲**, **▼** button.

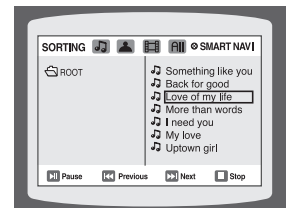

- You can press the **◀◀, ▶▶** button on the remote control to move directly to the desired title, chapter, or track.
- Depending on the disc, you may not be able to move to the selected title or time.

USING THE PLAYBACK FUNCTION (CON'T)

Using the Disc Menu



You can use the menus for the audio language, subtitle language, profile, etc.

DVD menu contents differ from disc to disc.

1. In Stop mode, press the **MENU** button.
2. Press the Cursor **▲, ▼** button or numeric buttons to move to **Disc Menu** and then press the **ENTER** button.
 - When you select Disc Menu and it is not supported by the disc, the "**This menu is not supported**" message appears on the screen.
3. Press the Cursor **▲, ▼, ◀, ▶** button to select the desired item.
4. Press the **ENTER** button.

➤ Press the **EXIT** button to exit the setup screen.

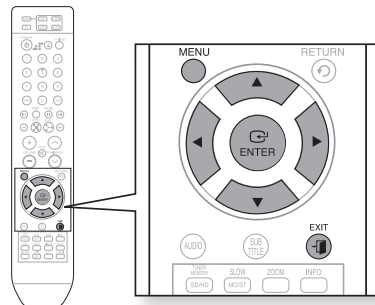

▪ The disc menu display may be different depending on the disc.

Using the Title Menu



For DVDs containing multiple titles, you can view the title of each movie. Depending on the disc, the availability of this feature may vary.

1. In Stop mode, press the **MENU** button.
2. Press the Cursor **▲, ▼** button to move to **Title Menu**.
3. Press the **ENTER** button.
 - The title menu appears.

➤ Press the **EXIT** button to exit the setup screen.

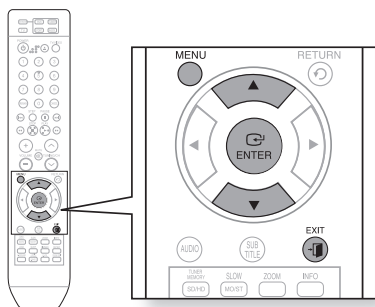

▪ The Title menu display may be different depending on the disc.

USING BLUETOOTH

You can use a Bluetooth device to enjoy music with high quality stereo sound, all without wires!

What is Bluetooth?

Bluetooth is a new technology that enables Bluetooth-compliant devices to easily interconnect with each other using a short wireless connection.

- A Bluetooth device may cause a noise or malfunction, depending on usage.
 - When a part of the body is in contact with the receiving/transmitting system of the Bluetooth device or the Home Theater System.
 - Electrical variation from electrical jamming by the wall, corner or office partitioning.
 - Electrical interference from the same frequency-band devices including medical equipment, microwave oven and wireless LAN.
- Pair the Home Theater System with the Bluetooth device while maintaining a close distance.
- The further the distance is between Home Theater System and Bluetooth device, the worse the quality. If the distance exceeds the Bluetooth operational range, the connection is lost.
- In poor reception-sensitivity areas, the Bluetooth connection may not work properly.
- The Home Theater System has an effective reception range of up to 33 feet in all directions if there are no obstacles. The connection will be automatically cut off if the distance is out of this range. Even within this range, the sound quality may be deteriorated by obstacles such as walls or doors.

To connect the Home Theater System to a bluetooth device

Check if the Bluetooth device supports the Bluetooth-compliant stereo headset function.

1. Press the **FUNCTION** button on the front panel of the home theater system repeatedly until "**BT AUDIO**" appears.
 - The mode switches as follows :
DVD/CD → D. IN → AUX 1 → AUX 2 → USB → BT AUDIO → TUNER
 - You will see "**WAIT**" for 2 seconds and then "**READY**" on the front display of the Home Theater System.
2. Select the Bluetooth menu on the Bluetooth device you want to connect. (refer to bluetooth device's user manual)
3. Select a Stereo headset menu in a Bluetooth device.
 - You will see a list of scanned devices.
4. Select "**Samsung Home Theater**" from the searched list.
 - When the Home Theater System is connected to the Bluetooth device, the Home Theater System will display "**CONNECT**" on the front display, followed by the device name of the connected Bluetooth device.
 - The Home Theater System connection is complete.
5. Play music on the connected device.
 - You can listen to the music playing on the connected Bluetooth device over the home theater system.

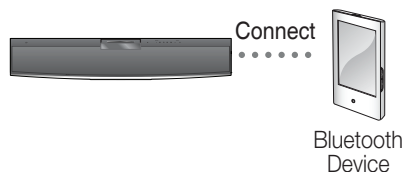
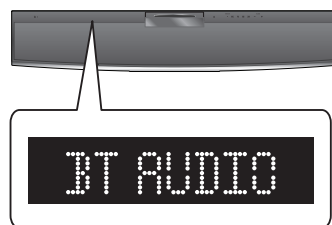

- You may be required to enter a PIN code(password) when connecting the Bluetooth device to the home Theater system. If the PIN code input window appears, enter <0000>.
- The Home Theater System may control play related function only when connected device supports the function.
- If connected device does not support some play related function, the Home Theater System can't control the device.
- The Home Theater System only supports Middle Quality SBC data(up to 237kbps@48kHz), and does not support High Quality SBC data(328kbps@44.1kHz).

USING BLUETOOTH (CON'T)

To disconnect the Bluetooth device from the Home Theater System

You can disconnect the Home Theater System from the Bluetooth device. (refer to bluetooth device's user manual)

- The Home Theater System will be disconnected.
- When the Home Theater System is disconnected from the Bluetooth device, the Home Theater System will display "DISCONNECT" on the front display.

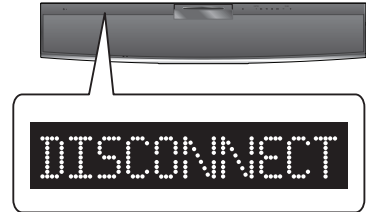

To disconnect the Home Theater System from the Bluetooth device

Press the **FUNCTION** button on the front panel of the home theater system to switch from "BT AUDIO" to another mode.

- The bluetooth device connected will wait a certain time for response from the home theater system before terminating the connection. (Time to disconnection may differ, depending on the bluetooth device)
- The currently connected device will be disconnected.



- In Bluetooth connection mode, the Bluetooth connection will be lost if the distance between the Home Theater System and the Bluetooth device exceeds 33 feet. If the distance is returned to the effective range or you restart the Bluetooth device, the Bluetooth connection can be restored.
- With some bluetooth devices, some functions may not work properly.

PLAYING MEDIA FILES USING THE USB HOST FEATURE

You can enjoy media files such as pictures, movies and music saved on an MP3 player, USB memory stick or digital camera in high quality video by connecting the storage device to the USB port of the Home Theater.

1. Connect the USB device to the USB port on the side of the unit.
2. Press the **FUNCTION** button on the DVD Player or the **PORT** button on the remote control to select the USB mode.
 - **USB** appears on the display screen and then disappears.
 - The USB MENU screen appears on the TV screen and the saved file is played.
3. To stop playback, press the **STOP** (■) button.

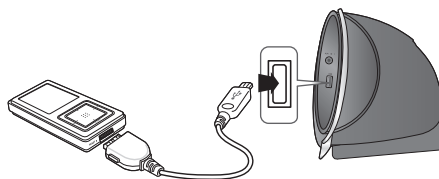

Safe USB Removal

To prevent damage to the memory stored in the USB device, perform safe removal before disconnecting the USB cable.

- Press the **STOP** (■) button twice in a row. The display will show **REMOVE USB**.
- Remove the USB cable.

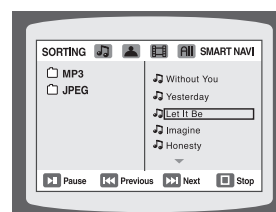

Skip Forward/Back

During playback, press the **SKIP FORWARD/BACK** button.

- When there is more than one file and you press the **SKIP FORWARD** button, the next file is selected.
- When there is more than one file and you press the **SKIP BACK** button, the previous file is selected.

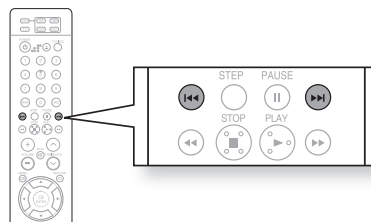

PLAYING MEDIA FILES USING THE USB HOST FEATURE (CON'T)

Fast playback

During playback, press the ◀▶ button.

- Each time you press either button, the playback speed will change as follows:

2x → 4x → 8x → 32x → Normal.

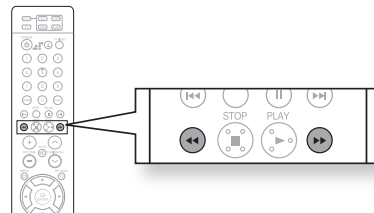

Compatible Devices

1. USB devices that support USB Mass Storage v1.0. (USB devices that operate as a removable disc in Windows (2000 or later) without additional driver installation.)
2. MP3 Player: HDD and flash type MP3 players.
3. Digital camera: Cameras that support USB Mass Storage v1.0.
 - Cameras that operate as a removable disc in Windows (2000 or later) without additional driver installation.
4. USB HDD and USB Flash Drive: Devices that support USB2.0 or USB1.1.
 - You may experience a difference in playback quality when you connect a USB1.1 device.
 - For a USB HDD, make sure to connect an auxiliary power cord to the USB HDD for proper operation.
5. USB card Reader: One slot USB card reader and Multi slot USB card reader.
 - Depending on the manufacturer. the USB card reader may not be supported.
 - If you install multiple memory devices into a multi card reader, you may experience problems.
6. If you use a USB extension cable, the USB device might not be recognized.

Supported Formats

Format	File name	File extension	Bit rate	Version	Pixel	Sampling Frequency
Still Picture	JPG	JPG .JPEG	–	–	640x480	–
Music	MP3	.MP3	80~384kbps	–	–	44.1kHz
	WMA	.WMA	56~128kbps	V8	–	44.1kHz
Movie	WMV	.WMV	4Mbps	V1,V2,V3,V7	720x480	44.1kHz~48kHz
	DivX	.AVI,.ASF	4Mbps	DivX3.11~ DivX5.1, XviD	720x480	44.1kHz~48kHz

- CBI (Control/Bulk/Interrupt) is not supported.
- Digital Cameras that use PTP protocol or require additional program installation when connected to a PC are not supported.
- A device using NTFS file system is not supported. (Only FAT 16/32 (File Allocation Table 16/32) file system is supported.)
- Some MP3 players, when connected to this product, may not operate depending on the sector size of their file system.
- The USB host function is not supported if a product that transfers media files by its manufacturer-specific program is connected.
- Does not operate with Janus enabled MTP (Media Transfer Protocol) devices.
- **The USB host function of this product does not support all USB devices. For information on the supported devices, see page 55.**

system setup

For your convenience, you can set this Home Theater's features for the best use in your home environment.

SETTING THE LANGUAGE

OSD(On-Screen Display) language is set to English by default.

1. In Stop mode, press the **MENU** button.
2. Press the Cursor **▼** button to move to **Setup** and then press the **ENTER** or **▶** button.
3. Select **Language** and then press the **ENTER** or **▶** button.
4. Press the Cursor **▲,▼** button to select **OSD Language** and then press the **ENTER** or **▶** button.
5. Press the Cursor **▲,▼** button to select the desired language and then press the **ENTER** button.
 - Once the setup is complete, the OSD will be English if English has been selected as the language.

- Press the **RETURN** button to return to the previous level.
- Press the **EXIT** button to exit the setup screen.

- **OSD LANGUAGE** : Selecting the OSD Language
- **AUDIO** : Selecting the Audio Language (recorded on the disc)
- **SUBTITLE** : Selecting the Subtitle Language (recorded on the disc)
- **DISC MENU** : Selecting the Disc Menu Language (recorded on the disc)
- ※ If the language you selected is not recorded on the disc, menu language will not change even if you set it to your desired language.

- **OTHERS** : To select another language, select OTHERS and enter the language code of your country (see page 54). AUDIO, SUBTITLE and DISC MENU languages can be selected.

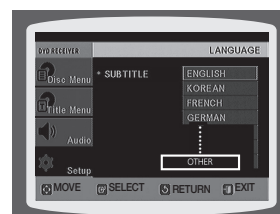
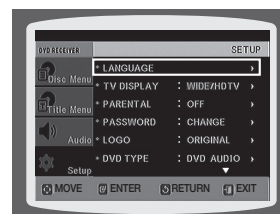

system setup

SETTING TV SCREEN TYPE

Depending on your TV type (Wide Screen or conventional 4:3), you can select the TV's aspect ratio.

1. In Stop mode, press the **MENU** button.
 2. Press the Cursor **▼** button to move to **Setup** and then press the **ENTER** or **▶** button.
 3. Press the Cursor **▼** button to move to **TV DISPLAY** and then press the **ENTER** or **▶** button.
 4. Press the Cursor **▲,▼** button to select the desired item and then press the **ENTER** button.
 - Once the setup is complete, you will be taken to the previous screen.
- Press the **RETURN** button to return to the previous level.
➤ Press the **EXIT** button to exit the setup screen.

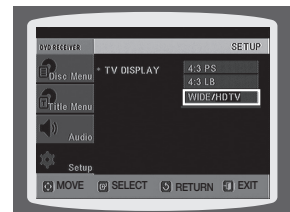
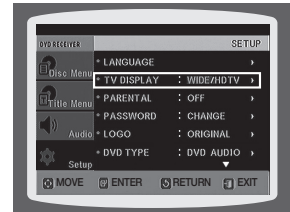

Adjusting the TV Aspect Ratio (Screen Size)

The horizontal to vertical screen size ratio of conventional TVs is 4:3, while that of widescreen and high definition TVs is 16:9. This ratio is called the aspect ratio. When playing DVDs recorded in different screen sizes, you should adjust the aspect ratio to fit your TV or monitor.

For a standard TV, select either **4:3PS** or **4:3LB** option according to personal preference. Select **WIDE/HDTV** if you have a widescreen TV.

4:3PS (4:3 Pan&Scan)

Select this to play a 16:9 picture in the pan & scan mode on a conventional TV.

- You can see the central portion of the screen only (with the sides of the 16:9 picture cut off).



4:3LB (4:3 Letterbox)

Select this to play a 16:9 picture in the letter box mode on a conventional TV.

- Black bars will appear at the top and bottom of the screen.



WIDE/HDTV

Select this to view a 16:9 picture in the full-screen mode on your widescreen TV.

- You can enjoy the widescreen aspect.



- If a DVD is in the 4:3 ratio, you cannot view it in widescreen.
- Since DVD discs are recorded in various image formats, they will look different depending on the software, the type of TV, and the TV aspect ratio setting.
- When using HDMI, the screen is automatically converted to Wide mode.

SETTING PARENTAL CONTROLS (RATING LEVEL)

Use this to restrict playback of adult or violent DVDs you do not want children to view.

1. In Stop mode, press the **MENU** button.
2. Press the Cursor **▼** button to move to **Setup** and then press the **ENTER** or **▶** button.
3. Press the Cursor **▼** button to move to **PARENTAL** and then press the **ENTER** or **▶** button.
4. Press the Cursor **▲,▼** button to select the desired rating level and then press the **ENTER** button.
 - If you have selected Level 6, you cannot view DVDs with Level 7 or higher.
 - The higher the level, the closer the content is to violent or adult material.
5. Enter the password and then press the **ENTER** button.
 - The password is set to "7890" by default.
 - Once the setup is complete, you will be taken to the previous screen.

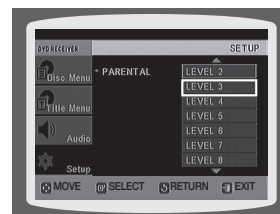

- Press the **RETURN** button to return to the previous level.
- Press the **EXIT** button to exit the setup screen.



■ This function works only if a DVD disc contains rating level information.

SETTING THE PASSWORD

You can set the password for the Parental (rating level) setting.

1. In Stop mode, press the **MENU** button.
2. Press the Cursor **▼** button to move to **Setup** and then press the **ENTER** or **▶** button.
3. Press the Cursor **▼** button to move to **PASSWORD** and then press the **ENTER** or **▶** button.
4. Press the **ENTER** button.
5. Enter the password and then press the **ENTER** button.
 - Enter the old password, a new password, and confirm new password.
 - The setting is complete.



■ The password is set to "7890" by default.

If you have forgotten the rating level password, do the following

- While the player is in No Disc mode, hold the DVD Players **STOP** (■) button for longer than 5 seconds. **INITIAL** appears on the display and all settings will return to the default values.
- Press the **POWER** button.

Using the **RESET** function will erase all stored settings.
Do not use this unless necessary.

system setup

SETTING THE WALLPAPER



While watching a DVD or JPEG CD, you can set the image you like as background wallpaper.

1. During playback, press the **PAUSE** (⏸) button when an image you like appears.
2. Press the **LOGO** button.
 - **COPY LOGO DATA** will be displayed on the TV screen.
3. The power will turn off and then back on.
 - The selected wallpaper will be displayed.
 - You can select up to 3 wallpaper settings.

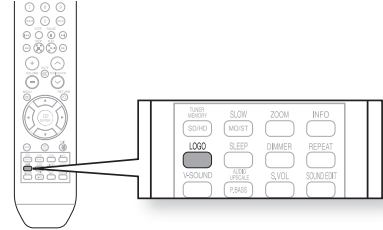

■ This function will not work when the HDMI output is 720p, 1080i or 1080p.

TO SELECT ONE OF THE 3 WALLPAPER SETTINGS YOU'VE MADE

1. In Stop mode, press the **MENU** button.
 2. Press the Cursor **▼** button to move to **Setup** and then press the **ENTER** or **▶** button.
 3. Press the Cursor **▼** button to move to **LOGO** and then press the **ENTER** or **▶** button.
 4. Press the Cursor **▲, ▼** button select the desired **USER**, and then press the **ENTER** button.
 - This selects one of the 3 wallpaper screens.
 5. Press the **EXIT** button to exit the setup screen.
- **ORIGINAL** : Select this to set the Samsung Logo image as your wallpaper.
 - **USER** : Select this to set the desired image as your wallpaper.
- Press the **RETURN** button to return to the previous level.
➤ Press the **EXIT** button to exit the setup screen.

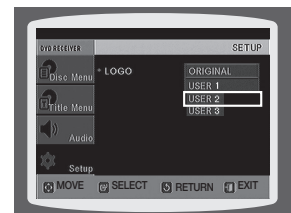
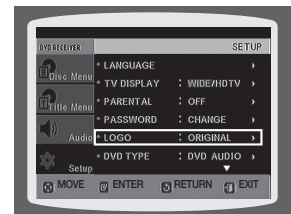

DVD PLAYBACK MODE

Some DVD-Audio discs contain DVD-Video as well as DVD-Audio.

To play back the DVD-Video portion of the DVD-Audio disc, set the unit to DVD-Video mode.

1. Press the **MENU** button while the disc tray is open.
2. Press the Cursor **▼** button to move to **Setup** and then press the **ENTER** or **▶** button.
3. Press the Cursor **▼** button to move to **DVD TYPE** and then press the **ENTER** or **▶** button.
4. Press the Cursor **▲, ▼** button to move to **DVD VIDEO** and then press the **ENTER** button.

- Set steps 1 ~ 4 again if you want to switch to DVD AUDIO Play mode.

- **DVD VIDEO** : Set to play the DVD video contents contained on a DVD audio disc.
- **DVD AUDIO** : Set to play the default DVD audio.



- DVD Play mode is set to DVD Audio as factory default setting.
- Powering off the main unit will automatically switch to the DVD Audio mode.

DviX (R) Registration

Please use the Registration code to register this player with the DivX (R) video on demand format.

To learn more, go to www.divx.com/vod.

SETTING THE DRC (DYNAMIC RANGE COMPRESSION)

This feature balances the range between the loudest and quietest sounds. You can use this function to enjoy Dolby Digital sound when watching movies at low volume at night.

1. In Stop mode, press the **MENU** button.
2. Press the Cursor **▼** button to move to **Audio** and then press the **ENTER** or **▶** button.
3. Press the Cursor **▼** button to move to **DRC** and then press the **ENTER** or **▶** button.
4. Press the Cursor **▲, ▼** to adjust the **DRC**.
 - When the Cursor **▲** button is pressed, the effect is greater, and when the Cursor **▼** button is pressed, the effect is smaller.

- Press the **RETURN** button to return to the previous level.
- Press the **EXIT** button to exit the setup screen.



system setup

SETTING THE AV SYNC

Video may look slower than the audio if it is connected to a digital TV. If this occurs, adjust the audio delay time to match the video.

1. In Stop mode, press the **MENU** button.
2. Press the Cursor **▼** button to move to **Audio** and then press the **ENTER** or **▶** button.
3. Press the Cursor **▼** button to move to **AV-SYNC** and then press the **ENTER** or **▶** button.
4. Press the Cursor **▲,▼** button to select the AV-SYNC Delay Time and then press the **ENTER** button.
 - You can set the audio delay time between 0 ms and 300 ms. Set it to the optimal status.
 - Press the **RETURN** button to return to the previous level.
 - Press the **EXIT** button to exit the setup screen.

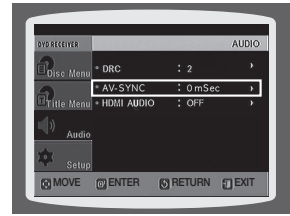

SETTING THE HDMI AUDIO

The audio signals transmitted over the HDMI Cable can be toggled ON/OFF.

1. In Stop mode, press the **MENU** button.
 2. Press the Cursor **▼** button to move to **Audio** and then press the **ENTER** or **▶** button.
 3. Press the Cursor **▼** button to move to **HDMI AUDIO** and then press the **ENTER** or **▶** button.
 4. Press the Cursor **▲,▼** button to select **ON** or **OFF** and then press the **ENTER** button.
- **ON** : Both video and audio signals are transmitted over the HDMI connection cable, and audio is output through your TV speakers only.
 - **OFF** : Video is transmitted over the HDMI connection cable only, and audio is output through the home theater speakers only.
- Press the **RETURN** button to return to the previous level.
 - Press the **EXIT** button to exit the setup screen.

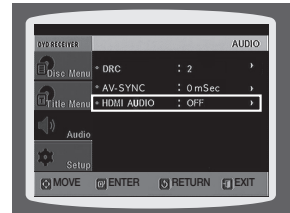

- The default setting of this function is HDMI AUDIO OFF.
- HDMI AUDIO is automatically down-mixed to 2ch for TV speakers.

SETTING THE AUDIO

Manually Adjusting the Speaker Volume and Balance with the SOUND EDIT Button.

Press the **SOUND EDIT** button and then press the Cursor **◀,▶** button.

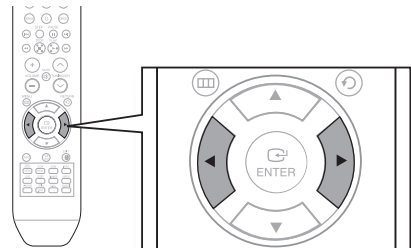

Adjusting Front Speaker Balance

- You can select between 00, -06, and OFF.
- The volume decreases as you move closer to -6.

Adjusting Subwoofer Speaker Level

- The volume level can be adjusted in steps from +6dB to -6dB.
- The sound gets louder as you move closer to +6dB and quieter as you get closer to -6dB.

LISTENING TO RADIO

Remote Control

1. Press the **TUNER** button to select the FM band.
2. Tune in to the desired station.
 - **Automatic Tuning 1** : When the **◀◀, ▶▶** button is pressed, a preset broadcast station is selected.
 - **Automatic Tuning 2** : Press and hold the **▲, ▼** button to automatically search for active broadcasting stations.
 - **Manual Tuning** : Briefly press the **▲, ▼** button to increase or decrease the frequency incrementally.

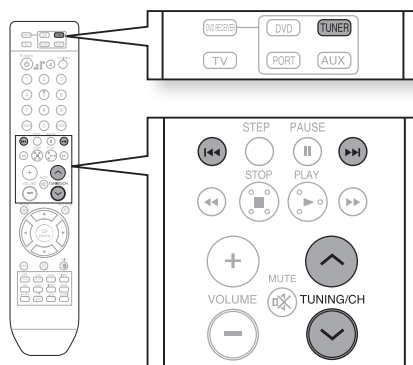

Main Unit

1. Press the **FUNCTION** button to select the FM band.
2. Select a broadcast station.
 - **Automatic Tuning 1** : Press the **STOP (■)** button to select **PRESET** and then press the **◀◀, ▶▶** button to select the preset station.
 - **Automatic Tuning 2** : Press the **STOP (■)** button to select **MANUAL** and then press and hold the **◀◀, ▶▶** button to automatically search the band.
 - **Manual Tuning** : Press the **STOP (■)** button to select **MANUAL** and then briefly press the **◀◀, ▶▶** button to tune in to a lower or higher frequency.

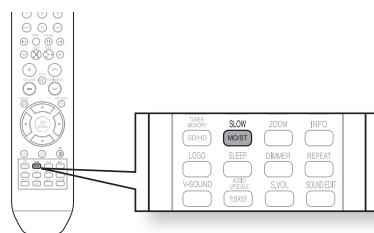

Press the **MO/ST** button to listen in Mono/Stereo.

- Each time the button is pressed, the sound switches between **STEREO** and **MONO**.
- In a poor reception area, select **MONO** for a clear, interference-free broadcast.

PRESETTING STATIONS

Example : Presetting FM 89.10 in the memory

1. Press the **TUNER** button to select the FM band.
2. Press the **▲, ▼** button to select **89.10**.
3. Press the **TUNER MEMORY** button.
 - **01** flashes in the display.
4. Press the **◀◀, ▶▶** button to select preset number.
 - You can select between 1 and 15 presets.
5. Press the **TUNER MEMORY** button again.
 - Press the **TUNER MEMORY** button before **Number** disappears from the display.
 - **Number** disappears from the display and the station is stored in memory.
6. To preset another station, repeat steps 2 to 5.
 - To tune in to a preset station, press the **◀◀, ▶▶** button on the remote control to select a channel.

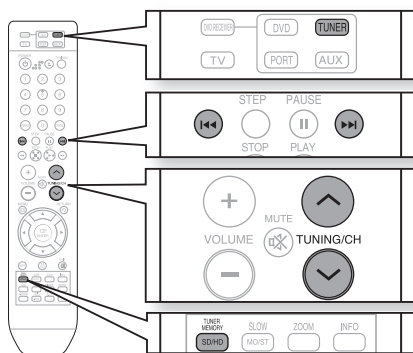

■ This unit does not receive AM broadcasts.

convenient function

SLEEP TIMER FUNCTION

You can set the time that the Home Theater will shut itself off.

Press the **SLEEP** button.

- **SLEEP** will be displayed. Each time the button is pressed, the preset time changes as follows :

→10 → 20 → 30 → 60 → 90 → 120 → 150 → OFF

To confirm the sleep timer setting, press the **SLEEP** button.

- The remaining time before the Home Theater will shut itself off is displayed.
- Pressing the button again changes the sleep time from what you have set earlier.

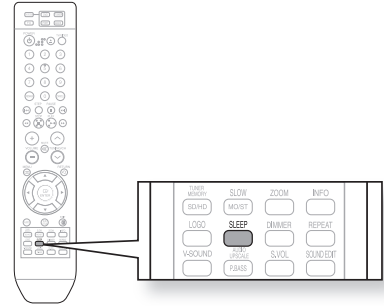

To cancel the sleep timer, press the **SLEEP** button until **OFF** appears on the display.

ADJUSTING DISPLAY BRIGHTNESS

You can adjust the brightness of the display on the main unit so it won't interfere with your movie viewing.

Press the **DIMMER** button.

- Each time the button is pressed, the front display brightness will be adjusted.

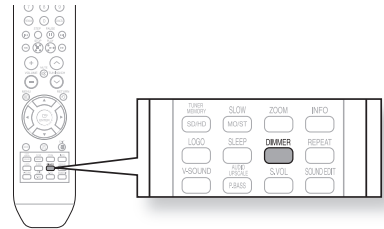

MUTE FUNCTION

This is useful when answering a doorbell or telephone call.

Press the **MUTE** button.

- **MUTE** appears in the display.
- To restore the sound, press the **MUTE** button again.

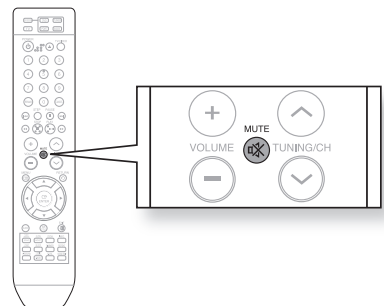

V-SOUND (VIRTUAL SOUND)

This feature provides virtual surround sound over 2.1 speakers.

Press the V-SOUND button.

- Each time the button is pressed, the selection changes as follows :

V-SO ON → **V-SO OFF**

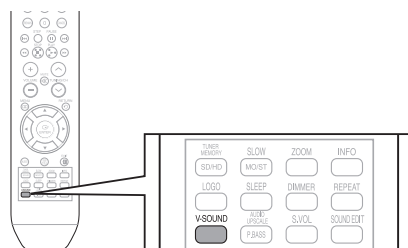

S.VOL (SMART VOLUME)

This will regulate and stabilize the volume level against a drastic volume change when changing channels or during a scene transition.

Press the S.VOL button.

- Each time the button is pressed, the selection changes as follows :

SVOL ON → **SVOL OFF**

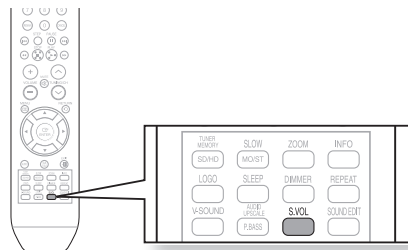

P.BASS/AUDIO UPSCALING

P.BASS

The P.BASS feature provides a bass boost to reinforce the low frequencies.

Press the **P.BASS/AUDIO UPSCALE** button to select **P.BASS** mode.

- Each time the button is pressed, the selection changes as follows :

PBAS ON → **UPSC ON** → **OFF**

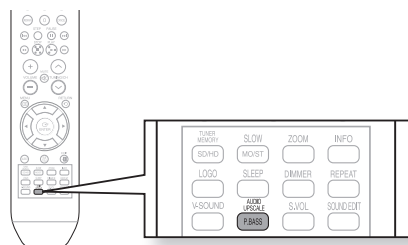

AUDIO UPSCALING

This also helps enhance your sound experience (ex. mp3 music).

You can upscale your MP3 level sound(24 kHz, 8bit) to CD level sound(44.1 kHz, 16bit).

Press the **P.BASS/AUDIO UPSCALE** button to select **AUDIO UPSCALE** mode.

- Each time the button is pressed, the selection changes as follows :

PBAS ON → **UPSC ON** → **OFF**



- The P.BASS function is only available with 2 channel LPCM sources such as mp3, Divx, cd and wma. Press P.BASS button and "POWER BASS ON" will be displayed on the screen.

troubleshooting

Refer to the chart below when this unit does not function properly. If the problem you are experiencing is not listed below or if the instruction below does not help, turn off the unit, disconnect the power cord, and contact the nearest authorized dealer or Samsung Electronics Service Center.

SYMPTOM	Check/Remedy
I cannot eject the disc.	<ul style="list-style-type: none"> • Is the power cord plugged securely into the outlet? • Turn off the power and then turn it back on.
Playback does not start.	<ul style="list-style-type: none"> • Check the region number of the DVD. DVD discs purchased from abroad may not be playable. • CD-ROMs and DVD-ROMs cannot be played on this DVD player. • Make sure that the rating level is correct.
Playback does not start immediately when the Play/Pause button is pressed.	<ul style="list-style-type: none"> • Are you using a deformed disc or a disc with scratches on the surface? • Wipe the disc clean.
Sound is not produced.	<ul style="list-style-type: none"> • No sound is heard during fast playback, slow playback, and step motion playback. • Are the speakers connected properly? Is the speaker setup correctly customized? • Is the disc severely damaged?
The remote control does not work.	<ul style="list-style-type: none"> • Is the remote control being operated within its operation range of angle and distance? • Are the batteries exhausted? • Have you selected the mode(TV/DVD) functions of the remote control (TV or DVD) correctly?
<ul style="list-style-type: none"> • Disc is rotating but no picture is produced. • Picture quality is poor and picture is shaking. 	<ul style="list-style-type: none"> • Is the TV power on? • Are the video cables connected properly? • Is the disc dirty or damaged? • A poorly manufactured disc may not be playable.
Audio language and subtitles do not work.	<ul style="list-style-type: none"> • Audio language and subtitles will not work if the disc does not contain them.
Menu screen does not appear even when the menu function is selected.	<ul style="list-style-type: none"> • Are you using a disc that does not contain menus?
Aspect ratio cannot be changed.	<ul style="list-style-type: none"> • You can play 16:9 DVDs in 16:9 WIDE mode, 4:3 LETTER BOX mode, or 4:3 PAN SCAN mode, but 4:3 DVDs can be seen in 4:3 ratio only. Refer to the DVD disc jacket and then select the appropriate function.

SYMPTOM	Check/Remedy
<ul style="list-style-type: none"> • The main unit is not working. (Example: The power goes out or strange noise is heard.) • The DVD player is not working normally. 	<ul style="list-style-type: none"> • Turn off the power and hold the STOP (■) button on the main unit for longer than 5 seconds. <p>Using the RESET function will erase all stored settings. Do not use this unless necessary.</p>
<p>The rating level password has been forgotten.</p>	<ul style="list-style-type: none"> • While “NO DISC” message appears on the display of main unit, hold the main unit's STOP (■) button for longer than 5 seconds. “INITIAL” appears on the display and all settings will return to the default values. • Press the POWER button. <p>Using the RESET function will erase all stored settings. Do not use this unless necessary.</p>
<p>Can't receive radio broadcast.</p>	<ul style="list-style-type: none"> • Is the antenna connected properly? • If the antenna's input signal is weak, install an external FM antenna in an area with good reception.

language code list

Enter the appropriate code number for the initial settings “Disc Audio”, “Disc Subtitle” and/or “Disc Menu” (See page 43).

Code	Language	Code	Language	Code	Language	Code	Language
1027	Afar	1181	Frisian	1334	Latvian, Lettish	1506	Slovenian
1028	Abkhazian	1183	Irish	1345	Malagasy	1507	Samoan
1032	Afrikaans	1186	Scots Gaelic	1347	Maori	1508	Shona
1039	Amharic	1194	Galician	1349	Macedonian	1509	Somali
1044	Arabic	1196	Guarani	1350	Malayalam	1511	Albanian
1045	Assamese	1203	Gujarati	1352	Mongolian	1512	Serbian
1051	Aymara	1209	Hausa	1353	Moldavian	1513	Siswati
1052	Azerbaijani	1217	Hindi	1356	Marathi	1514	Sesotho
1053	Bashkir	1226	Croatian	1357	Malay	1515	Sundanese
1057	Byelorussian	1229	Hungarian	1358	Maltese	1516	Swedish
1059	Bulgarian	1233	Armenian	1363	Burmese	1517	Swahili
1060	Bihari	1235	Interlingua	1365	Nauru	1521	Tamil
1069	Bislama	1239	Interlingue	1369	Nepali	1525	Tegulu
1066	Bengali; Bangla	1245	Inupiak	1376	Dutch	1527	Tajik
1067	Tibetan	1248	Indonesian	1379	Norwegian	1528	Thai
1070	Breton	1253	Icelandic	1393	Occitan	1529	Tigrinya
1079	Catalan	1254	Italian	1403	(Afan) Oromo	1531	Turkmen
1093	Corsican	1257	Hebrew	1408	Oriya	1532	Tagalog
1097	Czech	1261	Japanese	1417	Punjabi	1534	Setswana
1103	Welsh	1269	Yiddish	1428	Polish	1535	Tonga
1105	Danish	1283	Javanese	1435	Pashto, Pushto	1538	Turkish
1109	German	1287	Georgian	1436	Portuguese	1539	Tsonga
1130	Bhutani	1297	Kazakh	1463	Quechua	1540	Tatar
1142	Greek	1298	Greenlandic	1481	Rhaeto-Romance	1543	Twi
1144	English	1299	Cambodian	1482	Kirundi	1557	Ukrainian
1145	Esperanto	1300	Kannada	1483	Romanian	1564	Urdu
1149	Spanish	1301	Korean	1489	Russian	1572	Uzbek
1150	Estonian	1305	Kashmiri	1491	Kinyarwanda	1581	Vietnamese
1151	Basque	1307	Kurdish	1495	Sanskrit	1587	Volapuk
1157	Persian	1311	Kirghiz	1498	Sindhi	1613	Wolof
1165	Finnish	1313	Latin	1501	Sangro	1632	Xhosa
1166	Fiji	1326	Lingala	1502	Serbo-Croatian	1665	Yoruba
1171	Faeroese	1327	Laothian	1503	Singhalese	1684	Chinese
1174	French	1332	Lithuanian	1505	Slovak	1697	Zulu

USB host feature supported products

DIGITAL CAMERA

Product	Company	Type	Product	Company	Type
Finepix-A340	Fuji	Digital Camera	U300	Olympus	Digital Camera
Finepix-F810	Fuji	Digital Camera	X-350	Olympus	Digital Camera
Finepix-F610	Fuji	Digital Camera	C-760	Olympus	Digital Camera
Finepix-f450	Fuji	Digital Camera	C-5060	Olympus	Digital Camera
Finepix S7000	Fuji	Digital Camera	X1	Olympus	Digital Camera
Finepix A310	Fuji	Digital Camera	U-mini	Olympus	Digital Camera
KD-310Z	Konica	Digital Camera	Lumix-FZ20	Panasonic	Digital Camera
Finecam SL300R	Kyocera	Digital Camera	DMC-FX7GD	Panasonic	Digital Camera
Finecam SL400R	Kyocera	Digital Camera	Lumix LC33	Panasonic	Digital Camera
Finecam S5R	Kyocera	Digital Camera	LUMIX DMC-F1	Panasonic	Digital Camera
Finecam Xt	Kyocera	Digital Camera	Optio-S40	Pentax	Digital Camera
Dimage-Z1	Minolta	Digital Camera	Optio-S50	Pentax	Digital Camera
Dimage Z1	Minolta	Digital Camera	Optio 33LF	Pentax	Digital Camera
Dimage X21	Minolta	Digital Camera	Optio MX	Pentax	Digital Camera
Coolpix4200	Nikon	Digital Camera	Digimax-420	Samsung	Digital Camera
Coolpix4300	Nikon	Digital Camera	Digimax-400	Samsung	Digital Camera
Coolpix 2200	Nikon	Digital Camera	Sora PDR-T30	Toshiba	Digital Camera
Coolpix 3500	Nikon	Digital Camera	Coolpix 5900	Nikon	Digital Camera
Coolpix 3700	Nikon	Digital Camera	Coolpix S1	Nikon	Digital Camera
Coolpix 4100	Nikon	Digital Camera	Coolpix 7600	Nikon	Digital Camera
Coolpix 5200	Nikon	Digital Camera	DMC-FX7	Panasonic	Digital Camera
Stylus 410 digital	Olympus	Digital Camera	Dimage Xt	Minolta	Digital Camera
300-digital	Olympus	Digital Camera	AZ-1	Olympus	Digital Camera
300-digital	Olympus	Digital Camera			

USB FLASH DISC

Product	Company	Type	Product	Company	Type
Cruzer Micro	Sandisk	USB 2.0 USB Flash Drive 128M	XTICK	LG	USB 2.0 128M
Cruzer Mini	Sandisk	USB 2.0 128M	Micro Mini	lomega	USB 2.0 128M
Cruzer Mini	Sandisk	USB 2.0 256M	iFlash	lmation	USB 2.0 64M
SONY Micro Vault	Sony	USB 2.0 64MB	LG	XTICK(M)	USB 2.0 64M
FLEX DRIVE	Serotech	USB 2.0 32MB	RiDATA	EZDrive	USB 2.0 64M
AnyDrive	A.L tech	USB 2.0 128MB			

MP3 PLAYER

Product	Company	Type	Product	Company	Type
Creative MuVo NX128M	Creative	128 MB MP3 Player	YP-K3	Samsung	MP3 Player
Iriver H320	Iriver	20G HDD MP3 Player	YP-U3	Samsung	MP3 Player
YH-920	Samsung	20G HDD MP3 Player	YP-Z5F	Samsung	MP3 Player
YP-T7	Samsung	MP3 Player	iAUDIO U2	Cowon	MP3 Player
YP-MT6	Samsung	MP3 Player	iAUDIO G3	Cowon	MP3 Player
YP-T6	Samsung	MP3 Player	iAudio M3	Cowon	HDD MP3 Player
YP-T9	Samsung	MP3 Player	SI-M500L	Sharp	256MB MP3 Player
YP-ST5	Samsung	MP3 Player	H10	Iriver	MP3 Player
YP-T5	Samsung	MP3 Player	YP-T10	Samsung	MP3 Player
YP-K5	Samsung	MP3 Player	YP-P2	Samsung	MP3 Player

CAUTIONS ON HANDLING AND STORING DISCS

Small scratches on the disc may reduce sound and picture quality or cause skipping.
Be especially careful not to scratch discs when handling them.

Handling discs

Do not touch the playback side of the disc.
Hold the disc by the edges so that fingerprints will not get on the surface.
Do not stick paper or tape on the disc.

Disc Storage

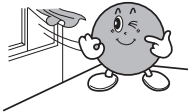
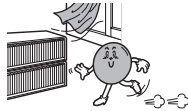
Do not keep in direct sunlight	Keep in a cool ventilated area	Keep in a clean Protection jacket. Store vertically.
		



- Do not allow the discs to become contaminated with dirt.
- Do not load cracked or scratched discs.

Handling and Storing Discs

When you get fingerprints or dirt on the disc, clean it with a mild detergent diluted in water and wipe with a soft cloth.

- When cleaning, wipe gently from the inside to the outside of the disc



- Condensation may form if warm air comes into contact with cold parts inside the player. When condensation forms inside the player, the player may not operate correctly. If this occurs, remove the disc and let the player stand for 1 or 2 hours with the power on.

SPECIFICATIONS

General	Power Requirements	AC 120V, 60Hz	
	Power Consumption	Main Unit : 55 W Subwoofer: 50 W	
	Weight	16.4 lbs	
	Dimensions	39.3 (W) x 7.1 (H) x 5.6 (D) inches	
	Operating Temperature Range	+41°F to +95°F	
	Operating Humidity Range	10 % to 75 %	
Disc	DVD (Digital Versatile Disc)	Reading Speed : 3.49 ~ 4.06 m/sec. Approx. Play Time (Single Sided, Single Layer Disc) : 135 min.	
	CD : 5 inches (COMPACT DISC)	Reading Speed : 4.8 ~ 5.6 m/sec. Maximum Play Time : 74 min.	
	CD : 3 1/2 inches (COMPACT DISC)	Reading Speed : 4.8 ~ 5.6 m/sec. Maximum Play Time : 20 min.	
Video Output	Composite Video	1.0 Vp-p (75 Ω load)	
	Component Video	Y : 1.0 Vp-p (75 Ω load) Pr : 0.70 Vp-p (75 Ω load) Pb : 0.70 Vp-p (75 Ω load)	
	HDMI	Impedance: 85~115 Ω	
Amplifier	Front speaker output	75W X 2(3Ω)	
	Subwoofer speaker output	150W(3Ω)	
	Frequency range	20Hz~20KHz	
	S/N Ratio	70dB	
	Channel separation	55dB	
	Input sensitivity	(AUX)600mV	
Speaker	Speaker system	2.1ch speaker system	
	Impedance	Front	Subwoofer
	Frequency range	3 Ω	3 Ω
	Output sound pressure level	140Hz~20KHz	35Hz~160Hz
	Rated input	86dB	86dB
	Maximum input	75W	150W
Subwoofer	Weight	150W	
	Dimensions	9.8 lbs 7 (W) x 15(D) x 12.7 (H) inches	

*: Nominal specification

- Samsung Electronics Co., Ltd reserves the right to change the specifications without notice.
- Weight and dimensions are approximate.

WARRANTY

LIMITED WARRANTY TO ORIGINAL PURCHASER

This SAMSUNG brand product, as supplied and distributed by Samsung Electronics America, Inc. (SAMSUNG) and delivered new, in the original carton to the original consumer purchaser, is warranted by SAMSUNG against manufacturing defects in materials and workmanship for a limited warranty period of:

One (1) Year Parts and Labor*

(*90 Days Parts and Labor for Commercial Use)

This limited warranty begins on the original date of purchase, and is valid only on products purchased and used in the United States. To receive warranty service, the purchaser must contact SAMSUNG for problem determination and service procedures. Warranty service can only be performed by a SAMSUNG authorized service center. The original dated bill of sale must be presented upon request as proof of purchase to SAMSUNG or SAMSUNG's authorized service center. Transportation of the product to and from the service center is the responsibility of the purchaser.

SAMSUNG will repair or replace this product, at our option and at no charge as stipulated herein, with new or reconditioned parts or products if found to be defective during the limited warranty period specified above. All replaced parts and products become the property of SAMSUNG and must be returned to SAMSUNG. Replacement parts and products assume the remaining original warranty, or ninety (90) days, whichever is longer.

SAMSUNG's obligations with respect to software products distributed by SAMSUNG under the SAMSUNG brand name are set forth in the applicable end user license agreement. Non-SAMSUNG hardware and software products, if provided, are on an "AS IS" basis. Non-SAMSUNG manufacturers, suppliers, publishers, and service providers may provide their own warranties.

This limited warranty covers manufacturing defects in materials and workmanship encountered in normal, and except to the extent otherwise expressly provided for in this statement, noncommercial use of this product, and shall not apply to the following, including, but not limited to: damage which occurs in shipment; delivery and installation; applications and uses for which this product was not intended; altered product or serial numbers; cosmetic damage or exterior finish; accidents, abuse, neglect, fire, water, lightning or other acts of nature; use of products, equipment, systems, utilities, services, parts, supplies, accessories, applications, installations, repairs, external wiring or connectors not supplied and authorized by SAMSUNG, or which damage this product or result in service problems; incorrect electrical line voltage, fluctuations and surges; customer adjustments and failure to follow operating instructions, cleaning, maintenance and environmental instructions that are covered and prescribed in the instruction book; product removal or reinstallation; reception problems and distortion related to noise, echo, interference or other signal transmission and delivery problems. SAMSUNG does not warrant uninterrupted or error-free operation of the product.

THERE ARE NO EXPRESS WARRANTIES OTHER THAN THOSE LISTED AND DESCRIBED ABOVE, AND NO WARRANTIES WHETHER EXPRESS OR IMPLIED, INCLUDING, BUT NOT LIMITED TO, ANY IMPLIED WARRANTIES OF MERCHANTABILITY OR FITNESS FOR A PARTICULAR PURPOSE, SHALL APPLY AFTER THE EXPRESS WARRANTY PERIODS STATED ABOVE, AND NO OTHER EXPRESS WARRANTY OR GUARANTY GIVEN BY ANY PERSON, FIRM OR CORPORATION WITH RESPECT TO THIS PRODUCT SHALL BE BINDING ON SAMSUNG. SAMSUNG SHALL NOT BE LIABLE FOR LOSS OF REVENUE OR PROFITS, FAILURE TO REALIZE SAVINGS OR OTHER BENEFITS, OR ANY OTHER SPECIAL, INCIDENTAL OR CONSEQUENTIAL DAMAGES CAUSED BY THE USE, MISUSE OR INABILITY TO USE THIS PRODUCT, REGARDLESS OF THE LEGAL THEORY ON WHICH THE CLAIM IS BASED, AND EVEN IF SAMSUNG HAS BEEN ADVISED OF THE POSSIBILITY OF SUCH DAMAGES. NOR SHALL RECOVERY OF ANY KIND AGAINST SAMSUNG BE GREATER IN AMOUNT THAN THE PURCHASE PRICE OF THE PRODUCT SOLD BY SAMSUNG AND CAUSING THE ALLEGED DAMAGE. WITHOUT LIMITING THE FOREGOING, PURCHASER ASSUMES ALL RISK AND LIABILITY FOR LOSS, DAMAGE OR INJURY TO PURCHASER AND PURCHASER'S PROPERTY AND TO OTHERS AND THEIR PROPERTY ARISING OUT OF THE USE, MISUSE OR INABILITY TO USE THIS PRODUCT SOLD BY SAMSUNG NOT CAUSED DIRECTLY BY THE NEGLIGENCE OF SAMSUNG. THIS LIMITED WARRANTY SHALL NOT EXTEND TO ANYONE OTHER THAN THE ORIGINAL PURCHASER OF THIS PRODUCT, IS NONTRANSFERABLE AND STATES YOUR EXCLUSIVE REMEDY.

Some states do not allow limitations on how long an implied warranty lasts, or the exclusion or limitation of incidental or consequential damages, so the above limitations or exclusions may not apply to you. This warranty gives you specific legal rights, and you may also have other rights which vary from state to state.

To obtain warranty hardware service, please contact SAMSUNG at:

Samsung Electronics America, Inc.
105 Challenger Road Ridgefield Park, NJ 07660-0511
1-800-SAMSUNG (726-7864) and www.samsung.com/us

Contact SAMSUNG WORLD WIDE

If you have any questions or comments relating to Samsung products, please contact the SAMSUNG customer care center.

Region	Country	Customer Care Center ☎	Web Site
North America	CANADA	1-800-SAMSUNG(726-7864)	www.samsung.com/ca
	MEXICO	01-800-SAMSUNG(726-7864)	www.samsung.com
	U.S.A	1-800-SAMSUNG(726-7864)	www.samsung.com
Latin America	ARGENTINE	0800-333-3733	www.samsung.com/ar
	BRAZIL	0800-124-421 , 4004-0000	www.samsung.com
	CHILE	800-SAMSUNG(726-7864)	www.samsung.com/cl
	NICARAGUA	00-1800-5077267	
	HONDURAS	800-7919267	
	COSTA RICA	0-800-507-7267	www.samsung.com/latin
	ECUADOR	1-800-10-7267	www.samsung.com/latin
	EL SALVADOR	800-6225	www.samsung.com/latin
	GUATEMALA	1-800-299-0013	www.samsung.com/latin
	JAMAICA	1-800-234-7267	www.samsung.com/latin
	PANAMA	800-7267	www.samsung.com/latin
	PUERTO RICO	1-800-682-3180	www.samsung.com/latin
	REP. DOMINICA	1-800-751-2676	www.samsung.com/latin
	TRINIDAD & TOBAGO	1-800-SAMSUNG(726-7864)	www.samsung.com/latin
VENEZUELA	0-800-100-5303	www.samsung.com/latin	
COLOMBIA	01-8000112112	www.samsung.com.co	
Europe	BELGIUM	0032 (0)2 201 24 18	www.samsung.com/be
	CZECH REPUBLIC	844 000 844 Distributor pro Českou republiku: Samsung Zrt., česká organizační složka Vyskočilova 4, 14000 Praha 4	www.samsung.com/cz
	DENMARK	70 70 19 70	www.samsung.com/dk
	FINLAND	030-6227 515	www.samsung.com/fi
	FRANCE	3260 SAMSUNG (€ 0,15/Min), 08 25 08 65 65 (€ 0,15/Min)	www.samsung.com
	GERMANY	01805 - SAMSUNG(726-7864) (€ 0,14/Min)	www.samsung.com
	HUNGARY	06-80-SAMSUNG(726-7864)	www.samsung.com
	ITALIA	800-SAMSUNG(726-7864)	www.samsung.com
	LUXEMBURG	0035 (0)2 261 03 710	www.samsung.com/be
	NETHERLANDS	0900-SAMSUNG(726-7864) (€ 0,10/Min)	www.samsung.com/nl
	NORWAY	815-56 480	www.samsung.com/no
	POLAND	0 801 801 881 , 022-607-93-33	www.samsung.com/pl
	PORTUGAL	80820-SAMSUNG(726-7864)	www.samsung.com/pt
	SLOVAKIA	0800-SAMSUNG(726-7864)	www.samsung.com/sk
	SPAIN	902 10 11 30	www.samsung.com
	SWEDEN	0771-400 200	www.samsung.com/se
	U.K	0845 SAMSUNG (7267864)	www.samsung.com
EIRE	0818 717 100	www.samsung.com/ie	
AUSTRIA	0800-SAMSUNG(726-7864)	www.samsung.com/at	
SWITZERLAND	0800-SAMSUNG(726-7864)	www.samsung.com/ch	
CIS	RUSSIA	8-800-555-55-55	www.samsung.com
	KAZAHSTAN	8-10-800-500-55-500	www.samsung.kz
	UZBEKISTAN	8-10-800-500-55-500	www.samsung.uz
	KYRGYZSTAN	00-800-500-55-500	
	TADJIKISTAN	8-10-800-500-55-500	
	UKRAINE	8-800-502-0000	www.samsung.com
	LITHUANIA	8-800-77777	www.samsung.lt
	LATVIA	800-7267	www.samsung.com/lv
ESTONIA	800-7267	www.samsung.ee	
Asia Pacific	AUSTRALIA	1300 362 603	www.samsung.com
	NEW ZEALAND	0800SAMSUNG(726-7864)	www.samsung.com/nz
	CHINA	800-810-5858 , 010-6475 1880	www.samsung.com
	HONG KONG	3698-4698	www.samsung.com/hk
	INDIA	3030 8282 , 1800 110011	www.samsung.com
	INDONESIA	0800-112-8888	www.samsung.com
	JAPAN	0120-327-527	www.samsung.com/jp
	MALAYSIA	1800-88-9999	www.samsung.com/my
	PHILIPPINES	1800-10-SAMSUNG(726-7864)	www.samsung.com/ph
	SINGAPORE	1800-SAMSUNG(726-7864)	www.samsung.com
	THAILAND	1800-29-3232 , 02-689-3232	www.samsung.com
	TAIWAN	0800-329-999	www.samsung.com/tw
VIETNAM	1 800 588 889	www.samsung.com	
Middle East & Africa	TURKEY	444 77 11	www.samsung.com
	SOUTH AFRICA	0860-SAMSUNG(726-7864)	www.samsung.com
	U.A.E	800-SAMSUNG (726-7864), 8000-4726	www.samsung.com



QUESTIONS OR COMMENTS?

COUNTRY	CALL	OR VISIT US ONLINE AT	WRITE
IN THE US	1-800-SAMSUNG (7267864)	www.samsung.com/us	Samsung Electronics America, Inc. 105 Challenger Road Ridgefield Park, NJ 07660-0511