



SAMSUNG

# LFD DISPLAY User Manual

---

LE32C LE46C LE55C

---

The color and the appearance may differ depending on the product, and the specifications are subject to change without prior notice to improve the performance.

BN46-00330A-03

---

# Table of contents

## Before Using the Product

---

<b>Copyright</b>	<b>5</b>
<b>Safety Precautions</b>	<b>6</b>
Symbols	6
Cleaning	6
Storage	7
Electricity and Safety	7
Installation	8
Operation	10

## Preparations

---

<b>Checking the Contents</b>	<b>13</b>
Removing the Packaging (for LE32C and LE46C models only)	13
Removing the Packaging (for LE55C models only)	14
Checking the Components	15
<b>Parts</b>	<b>17</b>
Control Panel	17
Rear View	18
Anti-theft Lock	19
Remote Control	20
Connection Using an IR Stereo Cable (sold separately)	23
<b>Before Installing the Product (Installation Guide)</b>	<b>24</b>
Tilting Angle and Rotation	24
Ventilation	24

---

<b>Dimensions</b>	<b>25</b>
<b>Installing the Wall Mount</b>	<b>26</b>
Installing the Wall Mount Kit	26
Wall Mount Kit Specifications (VESA)	27
<b>Remote Control (RS232C)</b>	<b>28</b>
Cable Connection	28
Connection	31
Control Codes	32

## Connecting and Using a Source Device

---

<b>Before Connecting</b>	<b>41</b>
Pre-connection Checkpoints	41
<b>Connecting to a PC</b>	<b>42</b>
Connection using the D-SUB cable (Analog type)	42
Connection using a DVI cable (Digital type)	43
Connection Using an HDMI-DVI Cable	43
Connection Using an HDMI Cable	44
<b>Changing the Resolution</b>	<b>45</b>
Changing the Resolution on Windows XP	45
Changing the Resolution on Windows 7	46
<b>Connecting to a Video Device</b>	<b>47</b>
Connection Using the AV Cable	47
Connection Using the component Cable	48
Connection Using an HDMI-DVI Cable	48
Connection Using an HDMI Cable	49

---

<b>Connecting to an Audio System</b>	<b>50</b>
<b>Connecting the network box (Sold separately)</b>	<b>51</b>
MagicInfo	51

## Input

---

<b>Source List</b>	<b>54</b>
<b>PIP</b>	<b>55</b>
PIP	55
Source	55
Size	56
Position	56
Transparency	57
<b>Edit Name</b>	<b>57</b>
<b>Source AutoSwitch Settings</b>	<b>58</b>
Source AutoSwitch	58
Primary Source Recovery	58
Primary Source	59
Secondary Source	59

---

# Table of contents

## Picture

<b>Mode</b>	<b>60</b>
<b>Custom</b>	<b>61</b>
<b>Color Tone</b>	<b>62</b>
<b>Color Control</b>	<b>62</b>
<b>Color Temp.</b>	<b>63</b>
<b>Image Lock</b>	<b>63</b>
<b>Auto Adjustment</b>	<b>64</b>
<b>Signal Balance</b>	<b>64</b>
Signal Balance	64
Signal Control	64
<b>Size</b>	<b>65</b>
<b>HDMI Black Level</b>	<b>65</b>
<b>PIP Picture</b>	<b>66</b>
<b>Dynamic Contrast</b>	<b>66</b>
<b>Lamp Control</b>	<b>67</b>
<b>Brightness Sensor</b>	<b>67</b>
<b>Picture Reset</b>	<b>68</b>

## Picture

<b>Mode</b>	<b>69</b>
<b>Custom</b>	<b>70</b>
<b>Color Tone</b>	<b>71</b>
<b>Color Temp.</b>	<b>71</b>
<b>Size</b>	<b>72</b>
<b>Digital NR</b>	<b>72</b>
<b>HDMI Black Level</b>	<b>73</b>
<b>Film Mode</b>	<b>73</b>
<b>PIP Picture</b>	<b>74</b>
<b>Dynamic Contrast</b>	<b>74</b>
<b>Lamp Control</b>	<b>75</b>
<b>Brightness Sensor</b>	<b>75</b>
<b>Picture Reset</b>	<b>76</b>

## Sound

<b>Mode</b>	<b>77</b>
<b>Custom</b>	<b>78</b>
<b>Auto Volume</b>	<b>78</b>
<b>SRS TS XT</b>	<b>79</b>

<b>Sound Select</b>	<b>79</b>
<b>Speaker Select</b>	<b>80</b>
<b>Sound Reset</b>	<b>80</b>

## Setup

<b>Language</b>	<b>81</b>
<b>Time</b>	<b>82</b>
Clock Set	82
Sleep Timer	82
Timer1 / Timer2 / Timer3	82
Holiday Management	82
<b>Menu Transparency</b>	<b>83</b>
<b>Safety Lock</b>	<b>83</b>
Change PIN	83
Lock	83
<b>Energy Saving</b>	<b>84</b>
<b>Video Wall</b>	<b>84</b>
Video Wall	84
Format	85
Horizontal	85
Vertical	86
Screen Position	86
<b>Safety Screen</b>	<b>87</b>
Pixel Shift	87
Timer	88
Bar	88

---

# Table of contents

Eraser	89
Pixel	89
Side Gray	90
<b>Resolution Select</b>	<b>90</b>
<b>Power On Adjustment</b>	<b>91</b>
<b>OSD Rotation</b>	<b>91</b>
<b>Advanced Settings</b>	<b>92</b>
Temperature	92
Auto Power	92
Button Lock	93
User Auto Color	93
Standby Control	94
Lamp Schedule	94
OSD Display	95
Software Upgrade	96
<b>Setup Reset</b>	<b>97</b>
<b>Reset All</b>	<b>97</b>
<b>Using MDC</b>	
<b>Multi Control</b>	<b>98</b>
<b>MDC Program Installation/Uninstallation</b>	<b>99</b>
Installation	99
Uninstallation	99
<b>What is MDC?</b>	<b>100</b>
Connecting to MDC	100
Connection Management	103

User Login	104
Auto Set ID	105
Cloning	106
Command Retry	107
<b>Getting Started with MDC</b>	<b>108</b>
Main Screen Layout	109
Menus	109
Screen Adjustment	111
Advanced features	114
Sound Adjustment	116
System Setup	116
Tool Settings	125
Other Functions	128
Group Management	129
Schedule Management	131
Troubleshooting Guide	133

## Troubleshooting Guide

<b>Requirements Before Contacting Samsung Customer Service Center</b>	<b>135</b>
Testing the Product	135
Checking the Resolution and Frequency	135
Check the followings.	136
<b>Q &amp; A</b>	<b>139</b>

## Specifications

<b>General</b>	<b>141</b>
<b>PowerSaver</b>	<b>144</b>
<b>Preset Timing Modes</b>	<b>146</b>

## Appendix

<b>Contact SAMSUNG WORLD WIDE</b>	<b>148</b>
<b>Responsibility for the Pay Service (Cost to Customers)</b>	<b>156</b>
Not a product defect	156
A Product damage caused by customer's fault	156
Others	156
<b>Correct Disposal</b>	<b>157</b>
Correct Disposal of This Product (Waste Electrical & Electronic Equipment)	157
Correct disposal of batteries in this product	157
<b>Optimum Picture Quality and Afterimage Burn-in Prevention</b>	<b>158</b>
Optimum Picture Quality	158
Prevention of Afterimage Burn-in	159
<b>License</b>	<b>161</b>
<b>Terminology</b>	<b>162</b>

# Chapter 01

## Before Using the Product

### Copyright

The contents of this manual are subject to change without notice to improve quality.

© 2013 Samsung Electronics

Samsung Electronics owns the copyright for this manual.

Use or reproduction of this manual in parts or entirety without the authorization of Samsung Electronics is prohibited.

Microsoft, Windows are registered trademarks of Microsoft Corporation.

VESA, DPM and DDC are registered trademarks of the Video Electronics Standards Association.

Ownership of all other trademarks is attributed to their due owner.

- An administration fee may be charged if either
  - (a) an engineer is called out at your request and there is no defect in the product (i.e. where you have failed to read this user manual).
  - (b) you bring the unit to a repair center and there is no defect in the product (i.e. where you have failed to read this user manual).
- The amount of such administration charge will be advised to you before any work or home visit is carried out.

# Safety Precautions

## Caution

RISK OF ELECTRIC SHOCK DO NOT OPEN

Caution : TO REDUCE THE RISK OF ELECTRIC SHOCK, DO NOT REMOVE COVER. (OR BACK)

THERE ARE NO USER SERVICEABLE PARTS INSIDE.

REFER ALL SERVICING TO QUALIFIED PERSONNEL.



This symbol indicates that high voltage is present inside.

It is dangerous to make any kind of contact with any internal part of this product.



This symbol alerts you that important literature concerning operation and maintenance has been included with this product.

## Symbols

### Warning

A serious or fatal injury may result if instructions are not followed.

### Caution

Personal injury or damage to properties may result if instructions are not followed.



Activities marked by this symbol are prohibited.



Instructions marked by this symbol must be followed.

## Cleaning

- Exercise care when cleaning as the panel and exterior of advanced LCDs are easily scratched.
- Take the following steps when cleaning.
- The following images are for reference only. Real-life situations may differ from what is shown in the images.

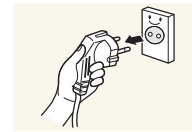

- 1 Power off the product and computer.
- 2 Disconnect the power cord from the product.

- Hold the power cable by the plug and do not touch the cable with wet hands. Otherwise, an electric shock may result.

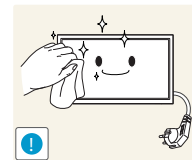

- 3 Wipe the product with a clean, soft and dry cloth.



- Do not use detergents that contain alcohol, solvent or surface-active agents.



- Do not spray water or detergent directly on the product.

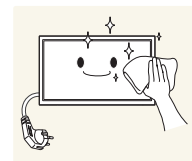

- 4 Wet a soft and dry cloth in water and wring thoroughly to clean the exterior of the product.

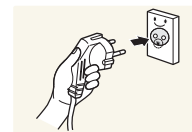

- 5 Connect the power cord to the product when cleaning is finished.
- 6 Power on the product and computer.

## Storage

High-glossy models can develop white stains on the surface if an ultrasonic wave humidifier is used nearby.

— Contact Customer Service Center if the inside of the product needs cleaning (service fee will be charged).

## Electricity and Safety

— The following images are for reference only. Real-life situations may differ from what is shown in the images.

### Warning

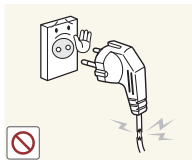

Do not use a damaged power cord or plug, or a loose power socket.

- An electric shock or fire may result.

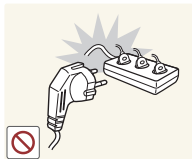

Do not use multiple products with a single power socket.

- Overheated power sockets may cause a fire.

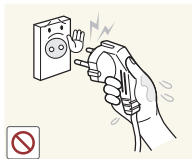

Do not touch the power plug with wet hands. Otherwise, an electric shock may result.

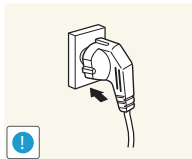

Insert the power plug all the way in so it is not loose.

- An unsecure connection may cause a fire.

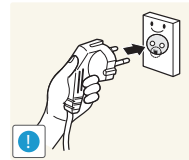

Connect the power plug to a grounded power socket (type 1 insulated devices only).

- An electric shock or injury may result.

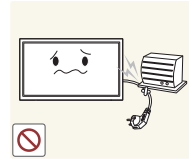

Do not bend or pull the power cord with force. Be careful not to leave the power cord under a heavy object.

- Damage to the cord may result in a fire or electric shock.



Do not place the power cord or product near heat sources.

- A fire or electric shock may result.

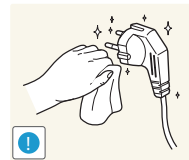

Clean any dust around the pins of the power plug or the power socket with a dry cloth.

- A fire may result.

## Caution



Do not disconnect the power cord while the product is being used.

- The product may become damaged by an electric shock.

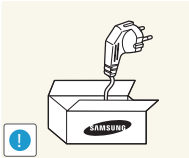

Only use the power cord provided with your product by Samsung. Do not use the power cord with other products.

- A fire or electric shock may result.

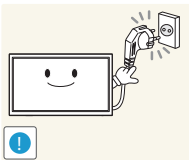

Keep the power socket where the power cord is connected unobstructed.

- The power cord must be disconnected to cut off power to the product when an issue occurs.
- Note that the product is not completely powered down by using only the power button on the remote.

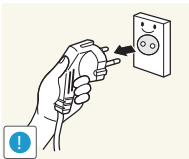

Hold the plug when disconnecting the power cord from the power socket.

- An electric shock or fire may result.

## Installation

### Warning



DO NOT PLACE CANDLES, INSECT REPELLANTS OR CIGARETTES ON TOP OF THE PRODUCT. DO NOT INSTALL THE PRODUCT NEAR HEAT SOURCES.

- A fire may result.

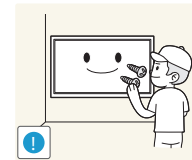

Have a technician install the wall-mount hanger.

- Installation by an unqualified person can result in an injury.
- Only use approved cabinets.



Do not install the product in poorly ventilated spaces such as a bookcase or closet.

- An increased internal temperature may cause a fire.

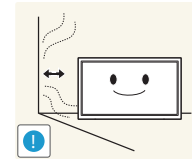

Install the product at least 10cm away from the wall to allow ventilation.

- An increased internal temperature may cause a fire.



Keep the plastic packaging out of the reach of children.

- Children may suffocate.





Do not install the product on an unstable or vibrating surface (insecure shelf, sloped surface, etc.)

- The product may fall and become damaged and/or cause an injury.
- Using the product in an area with excess vibration may damage the product or cause a fire.

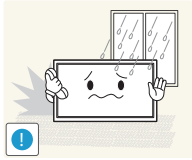

Do not install the product in a vehicle or a place exposed to dust, moisture (water drips, etc.), oil, or smoke.

- A fire or electric shock may result.

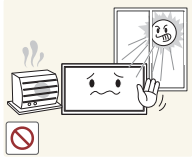

Do not expose the product to direct sunlight, heat, or a hot object such as a stove.

- The product lifespan may be reduced or a fire may result.

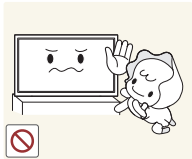

Do not install the product within the reach of young children.

- The product may fall and injure children.
- As the front is heavy, install the product on a flat and stable surface.



Edible oil, such as soybean oil, can damage or deform the product.

Do not install the product in a kitchen or near a kitchen counter.

## Caution

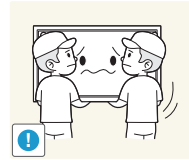

Do not drop the product while moving.

- Product failure or personal injury may result.

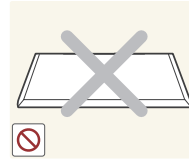

Do not set down the product on its front.

- The screen may become damaged.

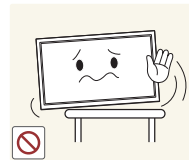

When installing the product on a cabinet or shelf, make sure that the bottom edge of the front of the product is not protruding.

- The product may fall and become damaged and/or cause an injury.
- Install the product only on cabinets or shelves of the right size.

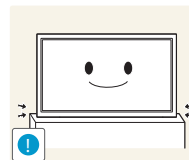

Set down the product gently.

- Product failure or personal injury may result.



Installing the product in an unusual place (a place exposed to a lot of fine particles, chemical substances or extreme temperatures, or an airport or train station where the product should operate continuously for an extended period of time) may seriously affect its performance.

- Be sure to consult Samsung Customer Service Center if you want to install the product at such a place.

## Operation

### Warning

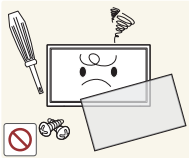

There is a high voltage inside the product. Never disassemble, repair or modify the product yourself.

- A fire or electric shock may result.
- Contact Samsung Customer Service Center for repairs.

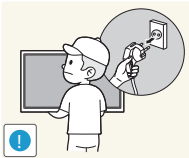

Before moving the product, turn off the power switch and disconnect the power cable and all other connected cables.

- Damage to the cord may result in a fire or electric shock.

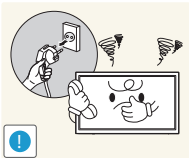

If the product generates abnormal sounds, a burning smell or smoke, disconnect the power cord immediately and contact Samsung Customer Service Center.

- An electric shock or fire may result.

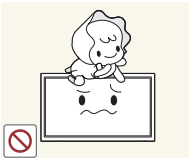

Do not let children hang from the product or climb on top of it.

- Children may become injured or seriously harmed.



If the product is dropped or the outer case is damaged, turn off the power switch and disconnect the power cord. Then contact Samsung Customer Service Center.

- Continued use can result in a fire or electric shock.

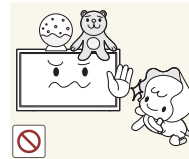

Do not leave heavy objects or items that children like (toys, sweets, etc.) on top of the product.

- The product or heavy objects may fall as children try to reach for the toys or sweets resulting in a serious injury.

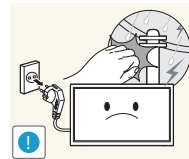

During a lightning or thunderstorm, power off the product and remove the power cable.

- A fire or electric shock may result.

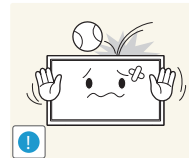

Do not drop objects on the product or apply impact.

- A fire or electric shock may result.

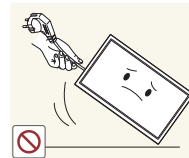

Do not move the product by pulling the power cord or any cable.

- Product failure, an electric shock or fire may result from a damaged cable.

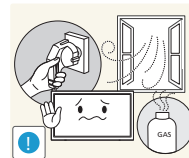

If a gas leakage is found, do not touch the product or power plug. Also, ventilate the area immediately.

- Sparks can cause an explosion or fire.

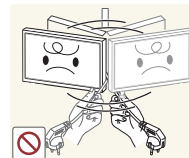

Do not lift or move the product by pulling the power cord or any cable.

- Product failure, an electric shock or fire may result from a damaged cable.

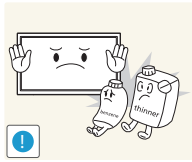

Do not use or keep combustible spray or an inflammable substance near the product.

- An explosion or fire may result.

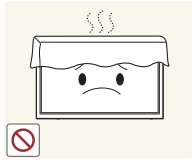

Ensure the vents are not blocked by tablecloths or curtains.

- An increased internal temperature may cause a fire.

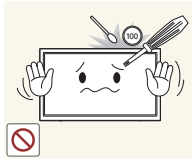

Do not insert metallic objects (chopsticks, coins, hairpins, etc) or objects that burn easily (paper, matches, etc) into the product (via the vent or input/output ports, etc).

- Be sure to power off the product and disconnect the power cord when water or other foreign substances have entered the product. Then contact Samsung Customer Service Center.
- Product failure, an electric shock or fire may result.

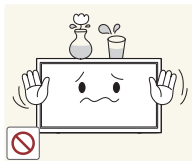

Do not place objects containing liquid (vases, pots, bottles, etc) or metallic objects on top of the product.

- Be sure to power off the product and disconnect the power cord when water or other foreign substances have entered the product. Then contact Samsung Customer Service Center.
- Product failure, an electric shock or fire may result.

### Caution

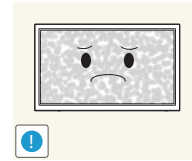

Leaving the screen fixed on a stationary image for an extended period of time may cause afterimage burn-in or defective pixels.

- Activate power-saving mode or a moving-picture screen saver if you will not be using the product for an extended period of time.

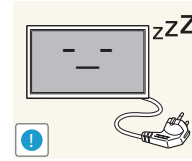

Disconnect the power cord from the power socket if you do not plan on using the product for an extended period of time (vacation, etc).

- Dust accumulation combined with heat can cause a fire, electric shock or electric leakage.

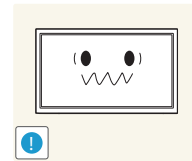

Use the product at the recommended resolution and frequency.

- Your eyesight may deteriorate.



Do not hold the product upside-down or move it by holding the stand.

- The product may fall and become damaged or cause an injury.

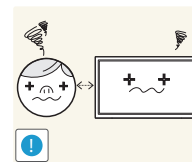

Looking at the screen too close for an extended period of time can deteriorate your eyesight.



Do not use humidifiers or stoves around the product.

- A fire or electric shock may result.

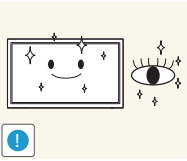

Rest your eyes for more than 5 minutes for every 1 hour of product use.

- Eye fatigue will be relieved.



Do not touch the screen when the product has been turned on for an extended period of time as it will become hot.

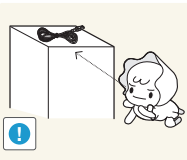

Store small accessories out of the reach of children.

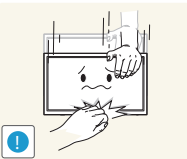

Exercise caution when adjusting the product angle or stand height.

- Your hand or finger may get stuck and injured.
- Tilting the product at an excessive angle may cause the product to fall and an injury may result.



Do not place heavy objects on the product.

- Product failure or personal injury may result.



When using headphones or earphones, do not turn the volume too high.

- Having the sound too loud may damage your hearing.

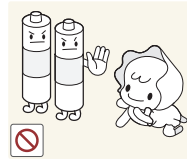

Be careful that children do not place the battery in their mouths when removed from the remote control. Place the battery in a location that children or infants cannot reach.

- If children have had the battery in their mouths, consult your doctor immediately.

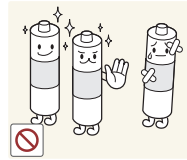

When replacing the battery, insert it with the right polarity (+, -).

- Otherwise, the battery may become damaged or it may cause fire, personal injury or damage due to leakage of the internal liquid.

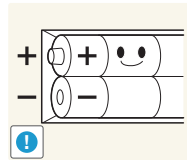

Use only the specified standardized batteries, and do not use a new battery and a used battery at the same time.

- Otherwise, the batteries may be damaged or cause fire, personal injury or damage due to a leakage of the internal liquid.

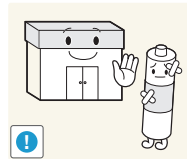

The batteries (and rechargeable batteries) are not ordinary refuse and must be returned for recycling purposes. The customer is responsible for returning the used or rechargeable batteries for recycling.

- The customer can return used or rechargeable batteries to a nearby public recycling center or to a store selling the same type of the battery or rechargeable battery.

# Chapter 02

## Preparations

### Checking the Contents

#### Removing the Packaging (for LE32C and LE46C models only)

— The following images are for reference only. Real-life situations may differ from what is shown in the images.

- 1 Remove the black locking device at the bottom of the box.



- 2 Remove the styrofoam from the product.

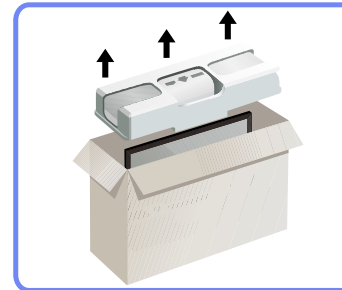

- 3 Check the product and remove the styrofoam and plastic bag.

— The appearance of the actual product may differ from the image shown.

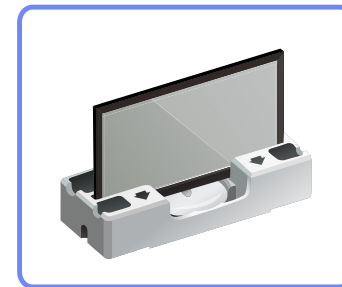

— This image is for reference only.

- 4 Store the box in a dry area so that it can be used when moving the product in the future.

## Removing the Packaging (for LE55C models only)

The following images are for reference only. Real-life situations may differ from what is shown in the images.

- 1 Remove the black locking device at the bottom of the box.

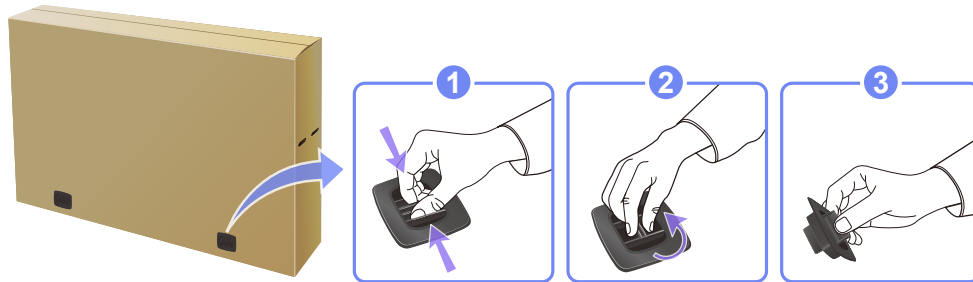

- 2 Using the grooves in the box, lift and remove the top of the box.

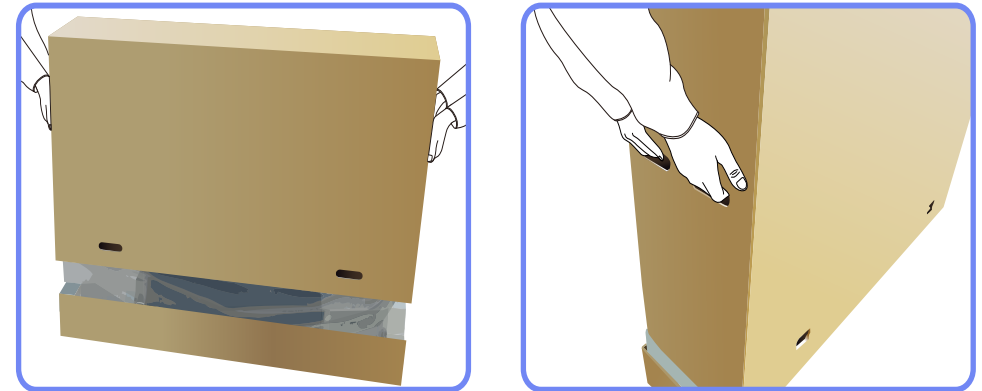

- 3 Check the components and remove the styrofoam and plastic bag.

The appearance of actual components may differ from the image shown.

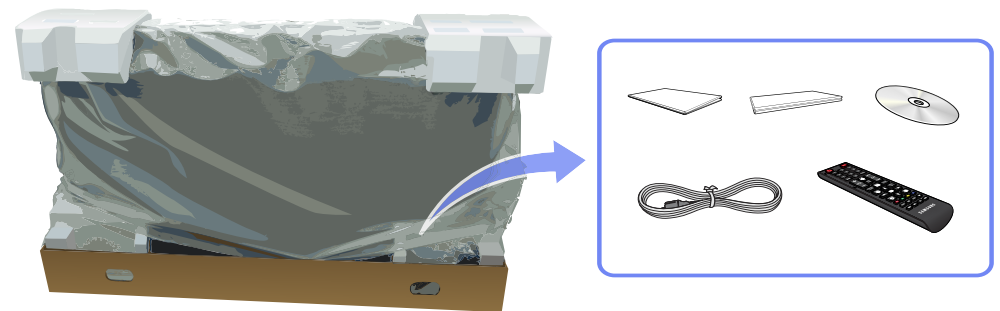

- 4 Store the box in a dry area so that it can be used when moving the product in the future.

---

# Checking the Components

## Components

— Components may differ in different locations.

- Contact the vendor where you purchased the product if any components are missing.
- The appearance of the components and items sold separately may differ from the image shown.
- A stand is not provided with the product. To install a stand, you can purchase one separately.

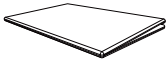

Quick setup guide



Warranty card  
(Not available in some locations)

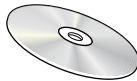

User manual

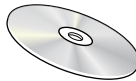

MagicInfo Lite Edition Software CD

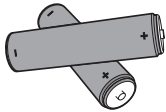

Batteries [\(P.21\)](#)  
(Not available in some locations)



Remote Control [\(P.20\)](#)



Power cord

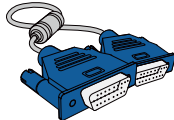

D-SUB cable [\(P.42\)](#)



Cover Screw

## Items sold separately

– The following items can be purchased at your nearest retailer.

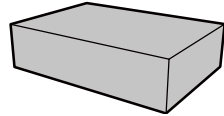

Wall-mount Kit

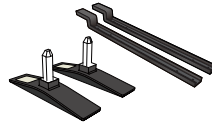

Stand

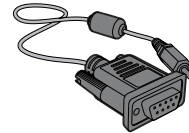

RS232C-Stereo cable (P.100)

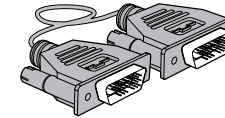

DVI cable (P.43)

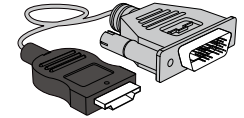

HDMI-DVI cable (P.43)

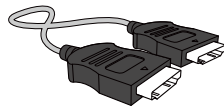

HDMI cable (P.44)

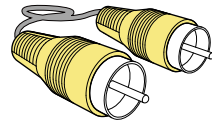

Video cable (P.47)

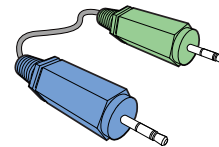

Stereo cable (P.23)

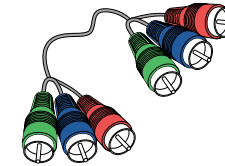

Component cable (P.48)

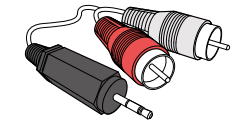

RCA stereo cable (P.50)

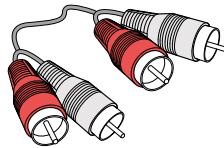

RCA cable (P.47)

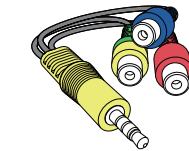

AV/Component Adapter (P.47)

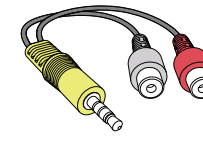

AUDIO Adapter (P.47)

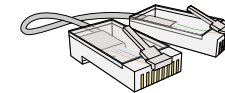

LAN cable (P.101)

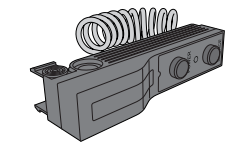

External sensor Kit (P.23)

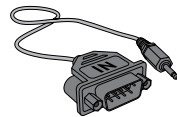

RS232C(IN) Adapter

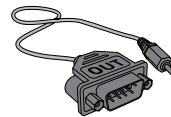

RS232C(OUT) Adapter

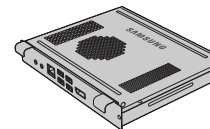

PIM



# Parts

## Control Panel

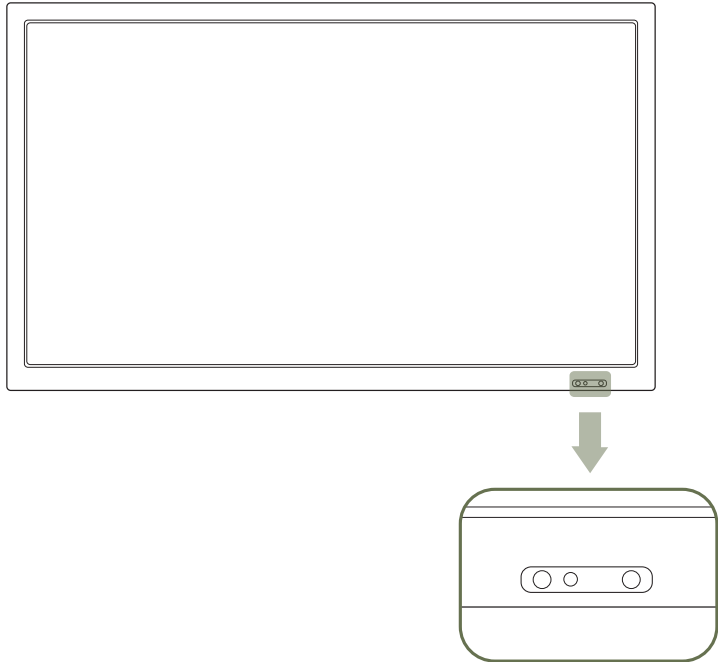

— The color and shape of parts may differ from what is shown. Specifications are subject to change without notice to improve quality.

Buttons	Description
	<b>Brightness Sensor (Optional)</b> Automatically detects the surrounding brightness it accordingly. — This function is activated only on the models equipped with an auto brightness sensor.
	<b>Power indicator</b> Shows PowerSaver mode by blinking green See PowerSaver described in the manual for further information regarding power saving functions. — For energy conservation, turn your LCD Display OFF when it is not needed or when leaving it unattended for long periods.
	<b>Remote sensor</b> Aim the remote control towards this spot on the LCD Display. — Using other display devices in the same space as the remote control of this product can cause the other display devices to be inadvertently controlled.

## Rear View

The color and shape of parts may differ from what is shown. Specifications are subject to change without notice to improve quality.

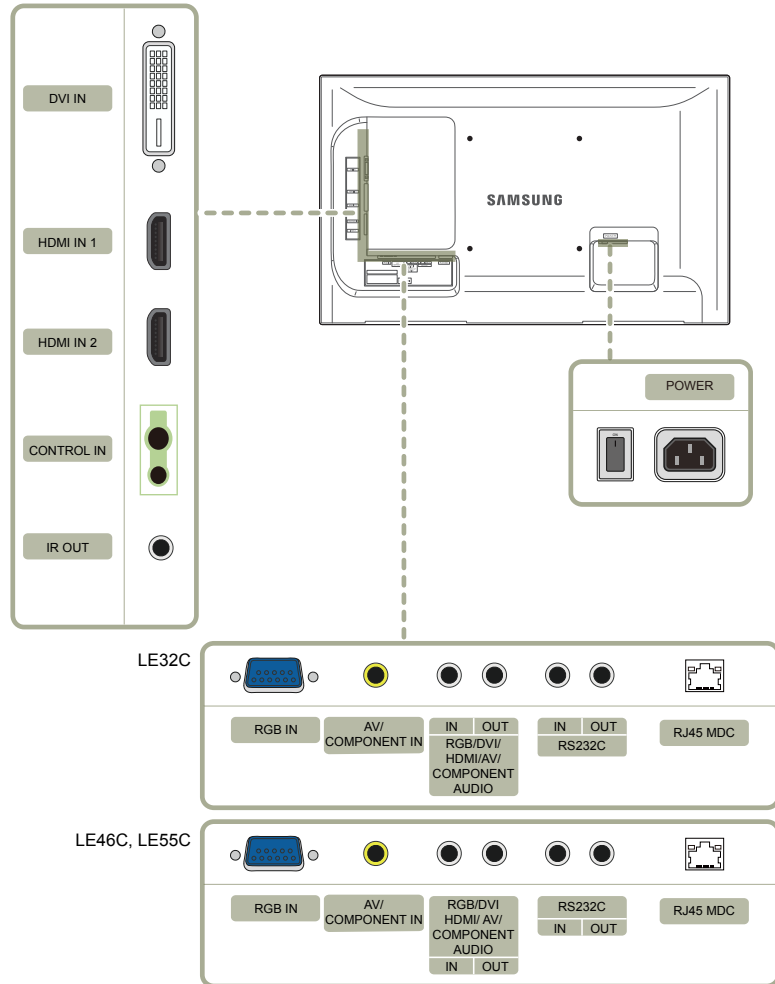

## Port

## Description

<b>DVI IN</b>	Connects to a source device using a DVI cable or HDMI-DVI cable.
<b>HDMI IN 1, HDMI IN 2</b>	Connects to a source device using an HDMI cable.
<b>CONTROL IN</b>	Supplies power to the external sensor board or receives the light sensor signal.
<b>IR OUT</b>	Receives the remote control signal via the external sensor board and outputs the signal via LOOP OUT.
<b>RGB IN</b>	Connects to a source device using a D-SUB cable.
<b>AV / COMPONENT IN</b>	Connects to a source device using the AV/component adapter.
<b>RGB / DVI / HDMI / AV / COMPONENT / AUDIO IN</b>	Receives sound from a PC via an audio cable.
<b>RGB / DVI / HDMI / AV / COMPONENT / AUDIO OUT</b>	Connects to the audio of a source device.
<b>RS232C IN</b>	Connects to MDC using an RS232C-stereo adapter.
<b>RS232C OUT</b>	
<b>RJ45 MDC</b>	Connects to MDC using a LAN cable.

---

## Anti-theft Lock

- An anti-theft lock allows you to use the product securely even in public places.
- The locking device shape and locking method depend on the manufacturer. Refer to the user guide provided with your anti-theft locking device for details.

### To lock an anti-theft locking device:

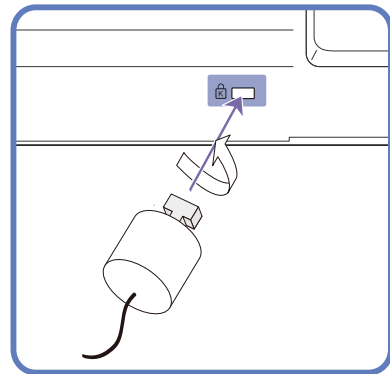

- 1 Fix the cable of your anti-theft locking device to a heavy object such as a desk.
- 2 Put one end of the cable through the loop on the other end.
- 3 Insert the locking device into the anti-theft lock slot at the back of the product.
- 4 Lock the locking device.
  - An anti-theft locking device can be purchased separately.
  - Refer to the user guide provided with your anti-theft locking device for details.
  - Anti-theft locking devices can be purchased at electronics retailers or online.

# Remote Control

Using other display devices in the same space as the remote control of this product can cause the other display devices to be inadvertently controlled.

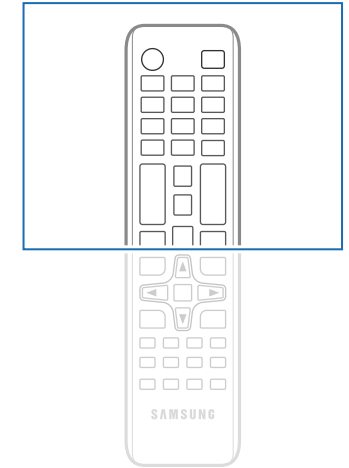
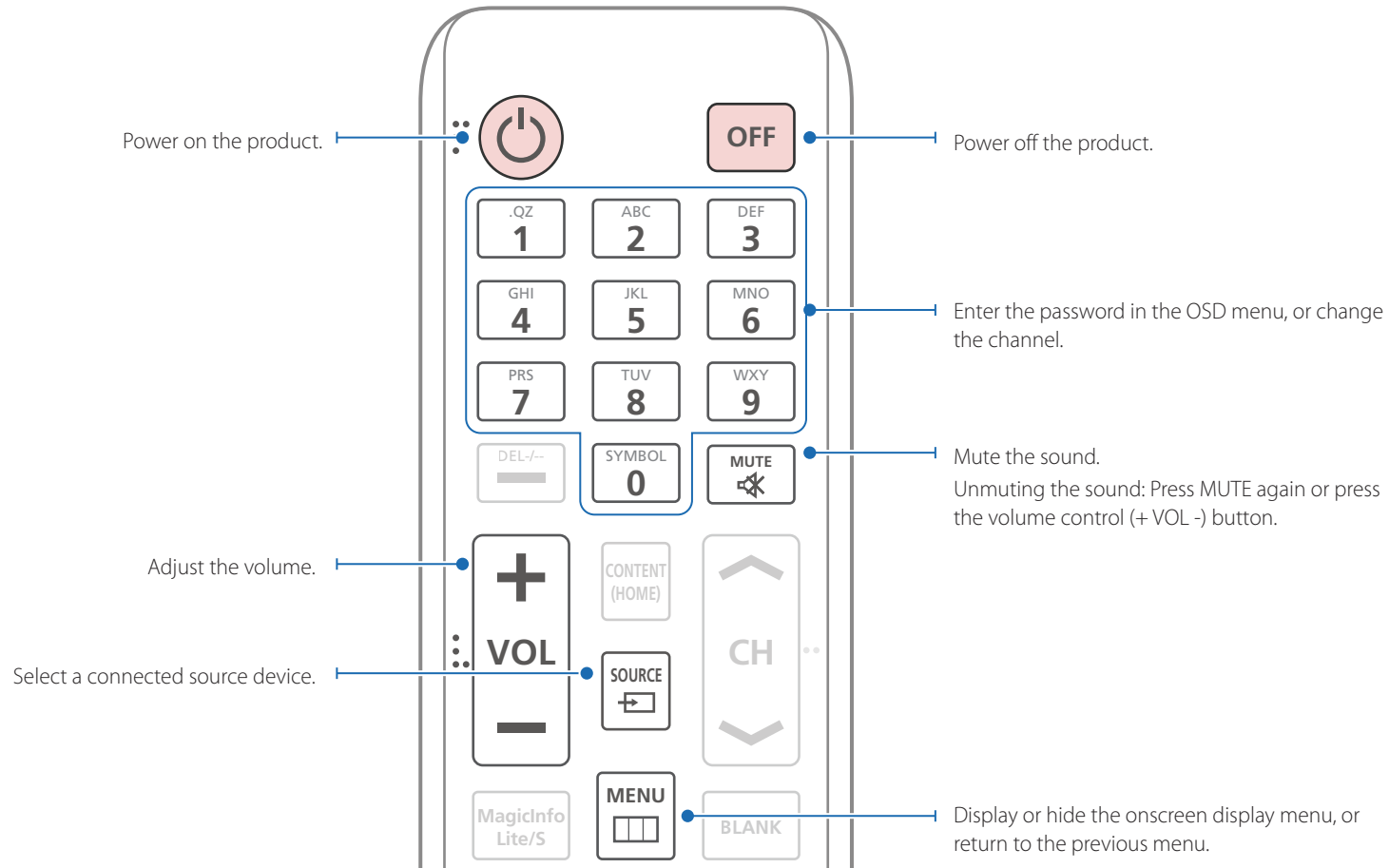

Remote control button functions may differ for different products.

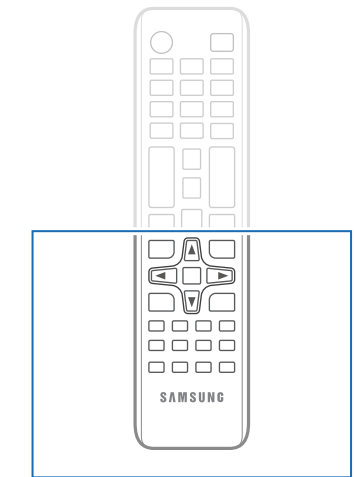
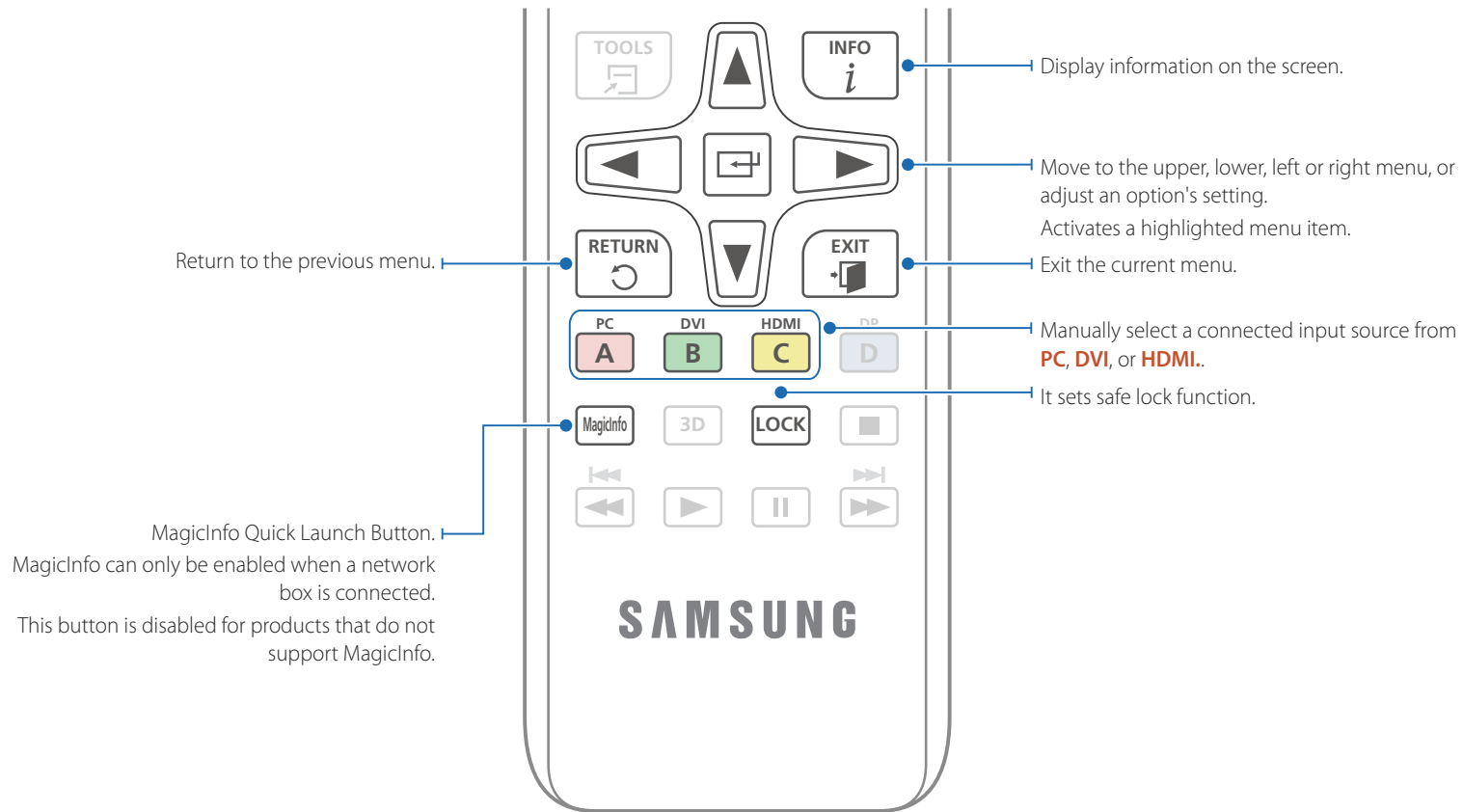

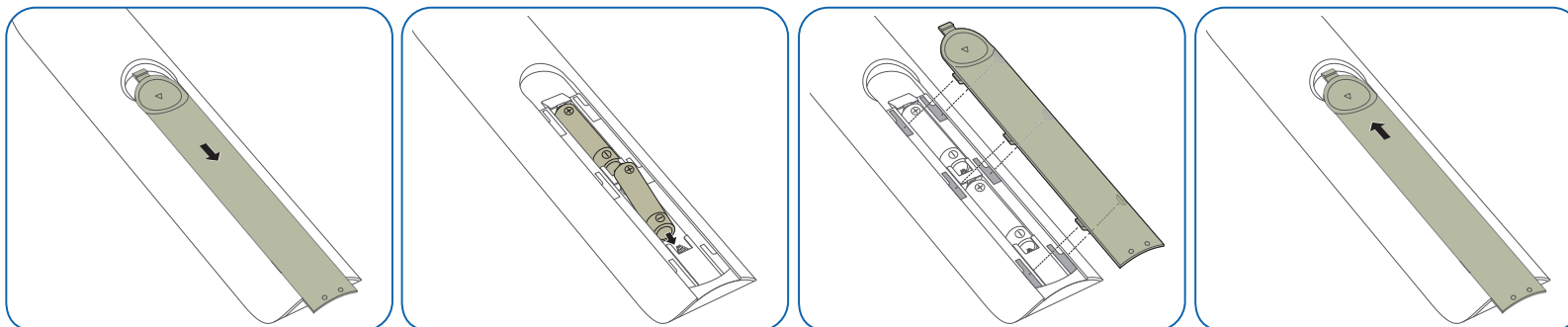

- Remote control button functions may differ for different products.

### To place batteries in the remote control

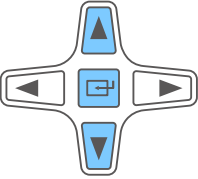
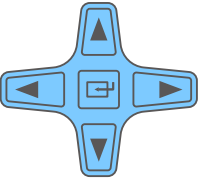
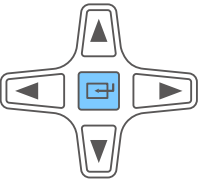

## Adjusting the OSD with the Remote Control

Buttons	Description
	1 Open the OSD menu.
	2 Select from <b>Input, Picture, Sound, Setup</b> or <b>Multi Control</b> in the displayed OSD menu screen.
	3 Change settings as desired.
	4 Finish setting.
	5 Close the onscreen display (OSD) menu.

## Remote Control Reception Range

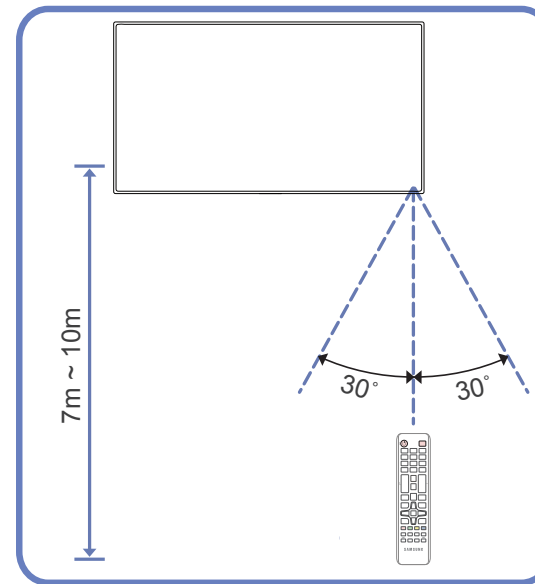

Use the remote control within 7m to 10m from the sensor on the product at an angle of 30° from the left and right.

- Store used batteries out of reach of children and recycle.
- Do not use a new and used battery together. Replace both batteries at the same time.
- Remove batteries when the remote control is not to be used for an extended period of time.

## Connection Using an IR Stereo Cable (sold separately)

Turn off the device before connecting the External Sensor Kit. After it is connected, turn on the device.

### Controlling more than one display product using your remote control

- Connect the **IR OUT** port on the product to the **CONTROL IN** port on the other display product using the dedicated stereo cable.
- A command sent from the remote control pointed at product **1** will be received by both display products **1** and **2**.

— The appearance may differ depending on the product.

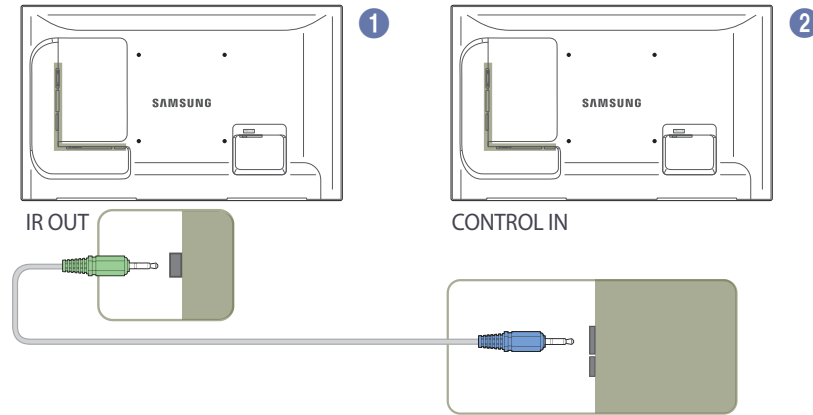

### Controlling more than one display product using an external sensor kit (sold separately)

- A command sent from the remote control pointed at product **1** (to which the external sensor kit is connected) will be received by both display products **1** and **2**.

— The appearance may differ depending on the product.

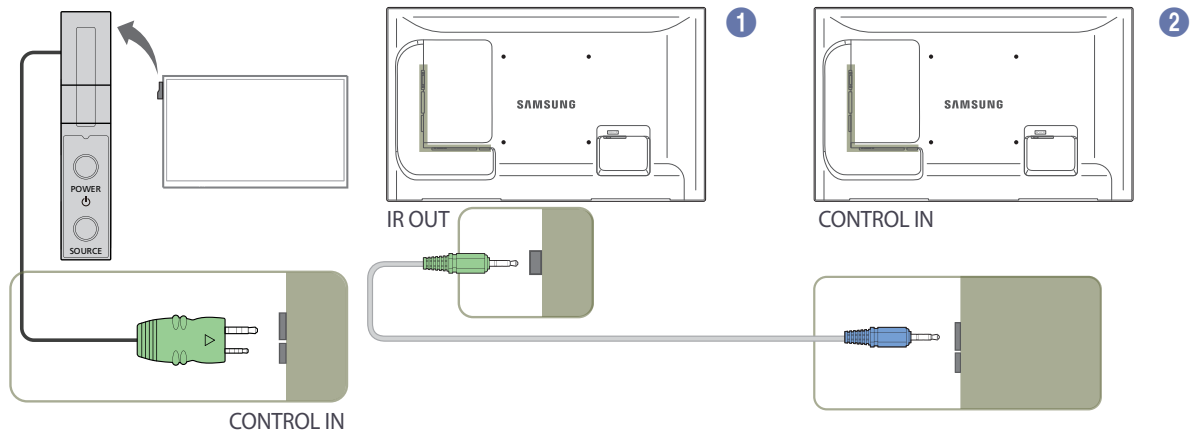

## Before Installing the Product (Installation Guide)

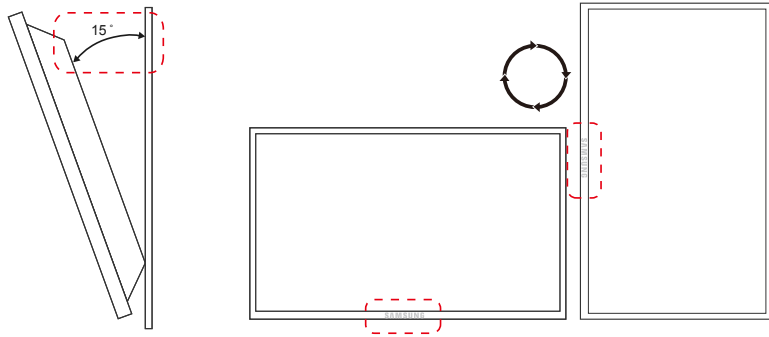

- To prevent injury, this apparatus must be securely attached to the floor/wall in accordance with the installation instructions.
  - Ensure that an authorized installation company installs the wall mount.
  - Otherwise, it may fall and cause personal injury.
  - Make sure to install the specified wall mount.

### Tilting Angle and Rotation

- Contact Samsung Customer Service Center for further details.
  - The product can be tilted at a maximum angle of 15° from a perpendicular wall surface.
  - To use the product vertically (portrait), turn it clockwise so that the LED is pointing down.

### Ventilation

#### Installation on a Perpendicular Wall

A Minimum 40 mm

B Ambient temperature: Under 35°C

- When installing the product on a perpendicular wall, allow at least 40 mm of space between the product and wall surface for ventilation and ensure that the ambient A temperature is kept below 35°C.

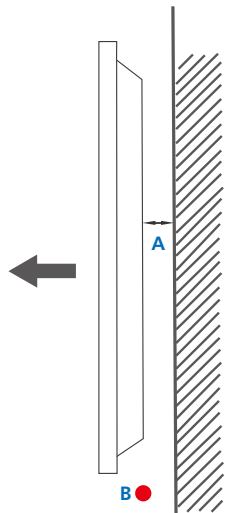

Figure 1.1 Side view



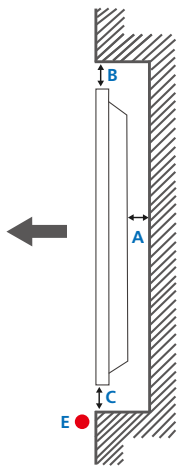
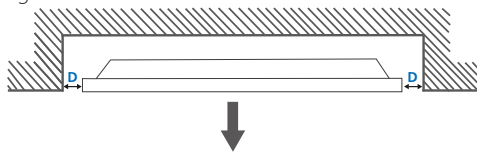

Figure 1.2 Side view

Figure 1.3 Side view



## Installation on an Indented Wall

— Contact Samsung Customer Service Center for further details.

### Plane view

A Minimum 40 mm

B Minimum 70 mm

C Minimum 50 mm

D Minimum 50 mm

E Ambient temperature: Under 35°C

— When installing the product on an indented wall, allow at least the space specified above between the product and wall for ventilation and ensure that the ambient temperature is kept below 35°C.

## Dimensions

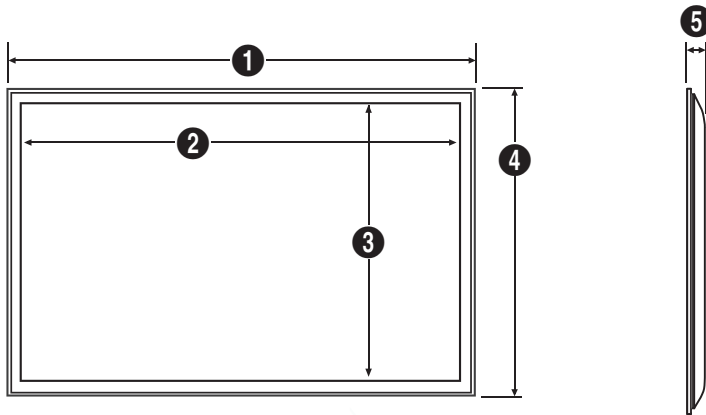

Unit: mm (inches)

Model name	1	2	3	4	5
LE32C	744.0 (29.3)	698.4 (27.5)	392.85 (15.5)	452.7 (17.8)	65.9 (2.6)
LE46C	1061.0 (41.8)	1018.08 (40.1)	572.67 (22.5)	619.8 (24.4)	51.7 (2.0)
LE55C	1252.4 (49.3)	1209.6 (47.6)	680.4 (26.8)	727.7 (28.6)	51.7 (2.0)

— All drawings are not necessarily to scale. Some dimensions are subject to change without prior notice.

Refer to the dimensions prior to performing installation of your product. Not responsible for typographical or printed errors.

---

## Installing the Wall Mount

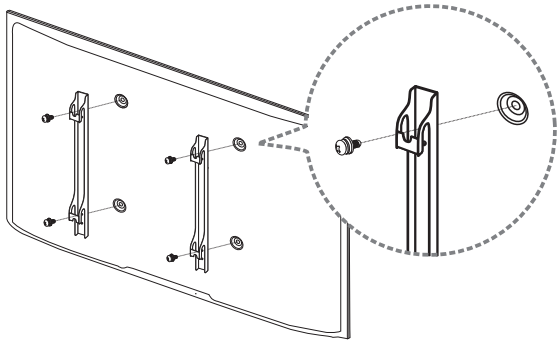

## Installing the Wall Mount Kit

The wall mount kit (sold separately) allows you to mount the product on the wall.

For detailed information on installing the wall mount, see the instructions provided with the wall mount.

We recommend you contact a technician for assistance when installing the wall mount bracket.

Samsung Electronics is not responsible for any damage to the product or injury to yourself or others if you elect to install the wall mount on your own.

## Wall Mount Kit Specifications (VESA)

- Install your wall mount on a solid wall perpendicular to the floor.  
Before attaching the wall mount to surfaces other than plaster board, please contact your nearest dealer for additional information.
- If you install the product on a slanted wall, it may fall and result in severe personal injury.

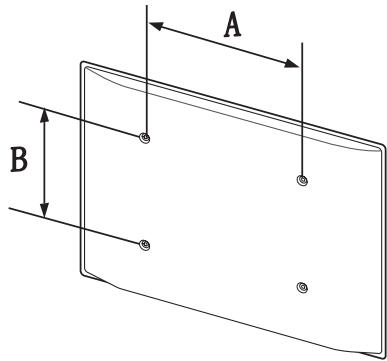

- Samsung wall mount kits contain a detailed installation manual and all parts necessary for assembly are provided.
- Do not use screws that are longer than the standard length or do not comply with the VESA standard screw specifications. Screws that are too long may cause damage to the inside of the product.
- For wall mounts that do not comply with the VESA standard screw specifications, the length of the screws may differ depending on the wall mount specifications.
- Do not fasten the screws too firmly. This may damage the product or cause the product to fall, leading to personal injury. Samsung is not liable for these kinds of accidents.
- Samsung is not liable for product damage or personal injury when a non-VESA or non-specified wall mount is used or the consumer fails to follow the product installation instructions.
- Do not mount the product at more than a 15 degree tilt.
- Always have two people mount the product on a wall.
- Standard dimensions for wall mount kits are shown in the table below.

Unit: mm (inches)

Model name	VESA screw hole specs (A * B) in millimeters	Standard Screw	Quantity
LE32C	200 × 200 (7.9 X 7.9)	M6	
LE46C	400 × 400 (15.7 X 15.7)	M8	4
LE55C	400 × 400 (15.7 X 15.7)		

- Do not install your Wall Mount Kit while your product is turned on. It may result in personal injury due to electric shock.

# Remote Control (RS232C)

## Cable Connection

### RS232C Cable

Interface	RS232C (9 pins)
Pin	TxD (No.2), RxD (No.3), GND (No.5)
Bit rate	9600 bps
Data bits	8 bit
Parity	None
Stop bit	1 bit
Flow control	None
Maximum length	15 m (only shielded type)

- Pin assignment

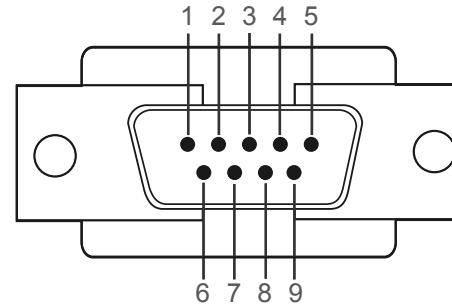

Pin	Signal
1	Detect data carrier
2	Received data
3	Transmitted data
4	Prepare data terminal
5	Signal ground
6	Prepare data set
7	Send request
8	Clear to send
9	Ring indicator

- RS232C cable  
Connector: 9-Pin D-Sub to Stereo Cable

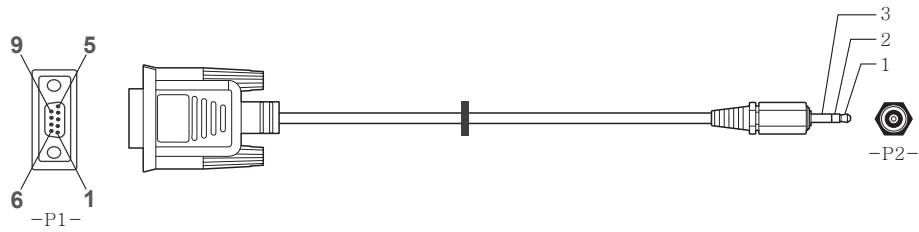

-P1-				-P2-	
Female	Rx	2	----->	3	Tx
	Tx	3	<-----	2	Rx
	Gnd	5	-----	5	Gnd
					STEREO
					PLUG
					(3.5ø)

## LAN Cable

- Pin assignment

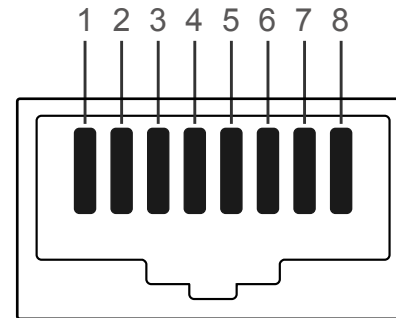

Pin No	Standard Colour	Signal
1	White and orange	TX+
2	Orange	TX-
3	White and green	RX+
4	Blue	NC
5	White and blue	NC
6	Green	RX-
7	White and brown	NC
8	Brown	NC

- Connector: RJ45

### Direct LAN cable (PC to HUB)

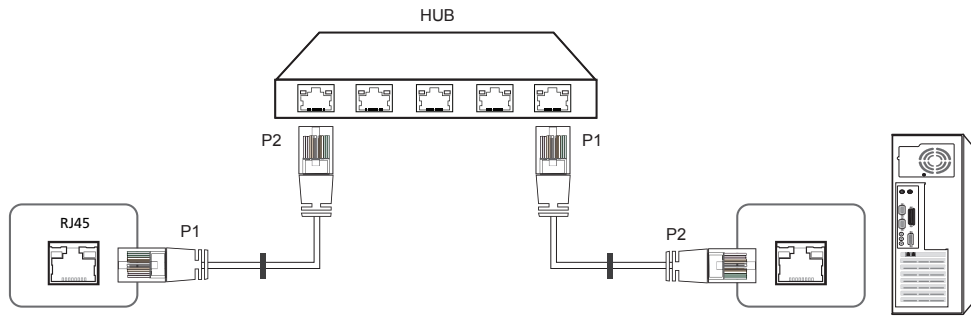

Signal	P1		P2	Signal
TX+	1	<----->	1	TX+
TX-	2	<----->	2	TX-
RX+	3	<----->	3	RX+
RX-	6	<----->	6	RX-

### Cross LAN cable (PC to PC)

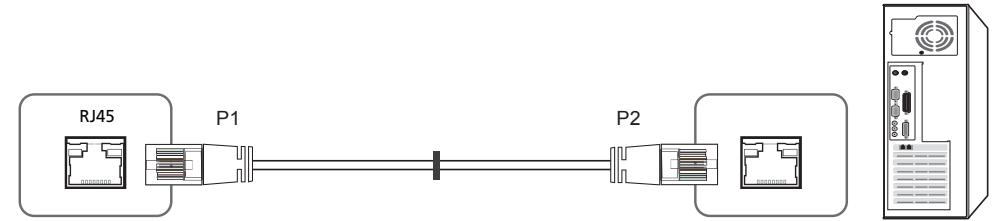

Signal	P1		P2	Signal
TX+	1	<----->	3	RX+
TX-	2	<----->	6	RX-
RX+	3	<----->	1	TX+
RX-	6	<----->	2	TX-

# Connection

- Connection 1

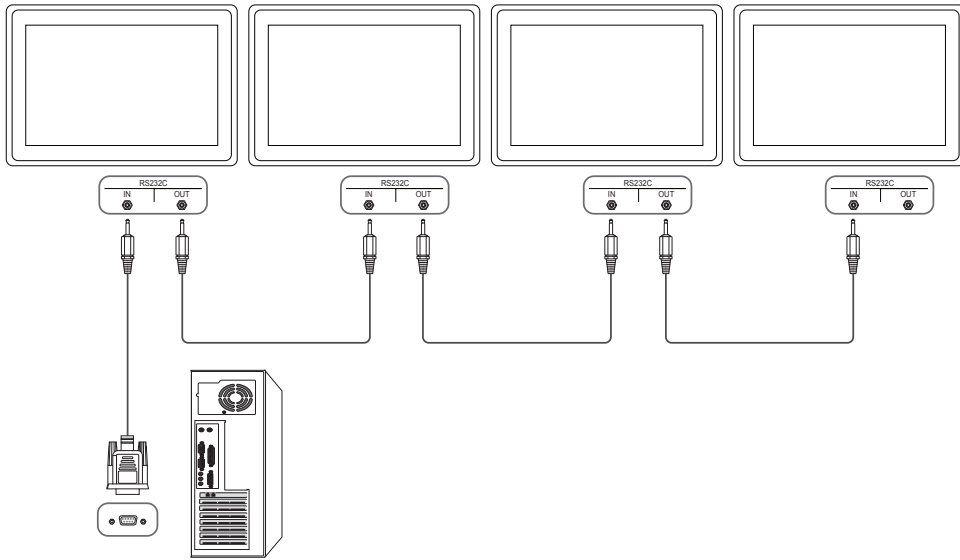

- Connection 2

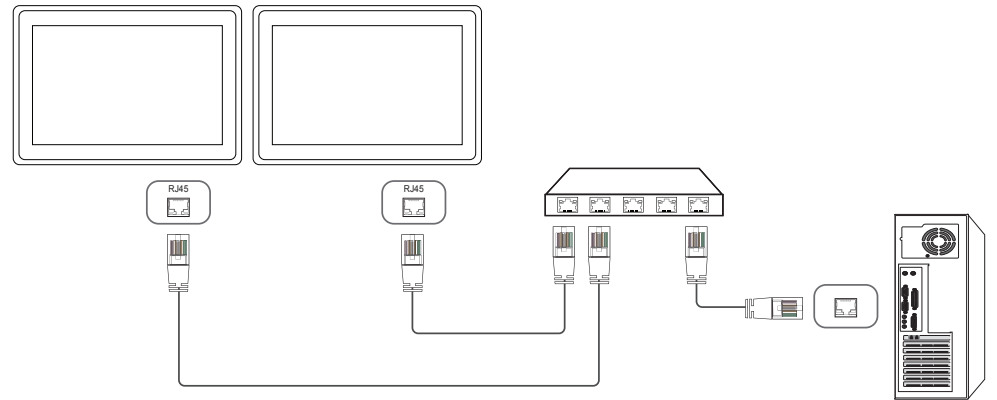

- Connection 3

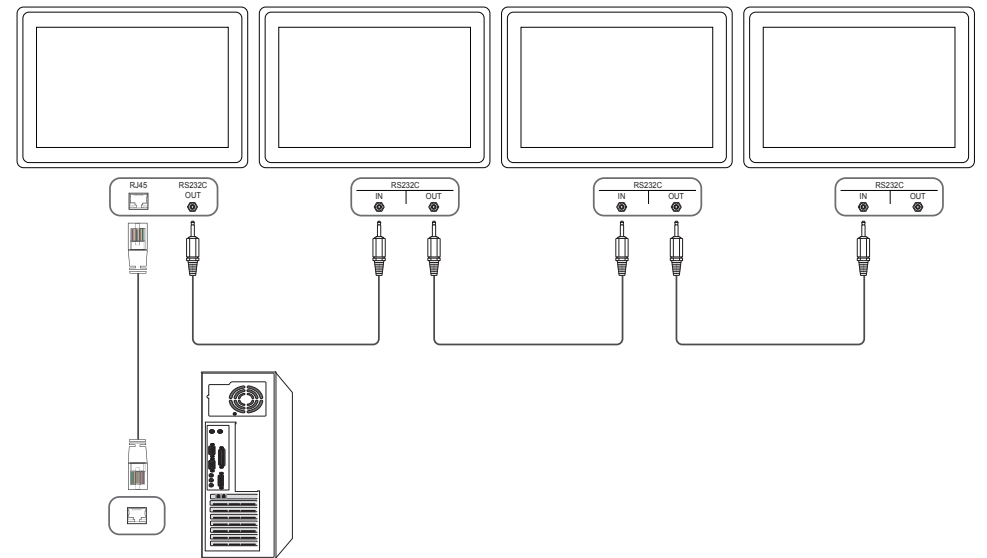

## Control Codes

### Viewing control state (Get control command)

Header	Command	ID	Data length	Checksum
0xAA	Command type		0	

### Controlling (Set control command)

Header	Command	ID	Data length	Data	Checksum
0xAA	Command type		1	Value	

### Command

No.	Command type	Command	Value range
1	Power control	0x11	0~1
2	Volume control	0x12	0~100
3	Input source control	0x14	-
4	Screen mode control	0x18	-
5	Screen size control	0x19	0~255
6	PIP on/off control	0x3C	0~1
7	Auto adjustment control (PC and BNC only)	0x3D	0
8	Video wall mode control	0x5C	0~1
9	Safety Lock	0x5D	0~1

No.	Command type	Command	Value range
10	Video Wall On	0x84	0~1
11	Video Wall User Control	0x89	-

- All communications take place in hexadecimal. The checksum is calculated by adding up all values except the header. If a checksum adds up to be more than 2 digits as shown below (11+FF+01+01=112), the first digit is removed.

E.g. Power On & ID=0

Header	Command	ID	Data length	Data 1	Checksum
0xAA	0x11		1	"Power"	

Header	Command	ID	Data length	Data 1	12
0xAA	0x11		1	1	

- To control all devices connected by a serial cable simultaneously irrespective of IDs, set the ID as "0xFE" and transmit commands. Commands will be executed by each device but ACK will not respond.



## Power control

- Function  
A product can be powered on and off using a PC.
- Viewing power state (Get Power ON / OFF Status)

Header	Command	ID	Data length	Checksum
0xAA	0x11		0	

- Setting power ON/Off (Set Power ON / OFF)

Header	Command	ID	Data length	Data	Checksum
0xAA	0x11		1	"Power"	

"Power": Power code to be set on a product.

1: Power ON

0: Power OFF

- Ack

Header	Command	ID	Data length	Ack/Nak	r-CMD	Val1	Checksum
0xAA	0xFF		3	'A'	0x11	"Power"	

"Power": Power code to be set on a product.

- Nak

Header	Command	ID	Data length	Ack/Nak	r-CMD	Val1	Checksum
0xAA	0xFF		3	'N'	0x11	"ERR"	

"ERR" : A code showing what error has occurred.

## Volume control

- Function  
The volume of a product can be adjusted using a PC.
- Viewing volume state (Get Volume Status)

Header	Command	ID	Data length	Checksum
0xAA	0x12		0	

- Setting the volume (Set Volume)

Header	Command	ID	Data length	Data	Checksum
0xAA	0x12		1	"Volume"	

"Volume": Volume value code to be set on a product. (0-100)

- Ack

Header	Command	ID	Data length	Ack/Nak	r-CMD	Val1	Checksum
0xAA	0xFF		3	'A'	0x12	"Volume"	

"Volume": Volume value code to be set on a product. (0-100)

- Nak

Header	Command	ID	Data length	Ack/Nak	r-CMD	Val1	Checksum
0xAA	0xFF		3	'N'	0x12	"ERR"	

"ERR" : A code showing what error has occurred.

## Input source control

- Function  
The input source of a product can be changed using a PC.
- Viewing input source state (Get Input Source Status)

Header	Command	ID	Data length	Checksum
0xAA	0x14		0	

- Setting the input source (Set Input Source)

Header	Command	ID	Data length	Data	Checksum
0xAA	0x14		1	"Input Source"	

"Input Source": An input source code to be set on a product.

0x14	PC
0x18	DVI
0x0C	Input source
0x08	Component
0x20	MagicInfo
0x1F	DVI_video
0x30	RF(TV)
0x40	DTV
0x21	HDMI1
0x22	HDMI1_PC
0x23	HDMI2

0x24	HDMI2_PC
0x25	DisplayPort

— DVI\_video, HDMI1\_PC and HDMI2\_PC cannot be used with the Set command. They only respond to "Get" commands.

— This model does not support HDMI1, HDMI1\_PC, HDMI2 and HDMI2\_PC ports.

— **MagicInfo** is only available with models that contain the **MagicInfo** function.

— RF(TV), DTV are only available with models that include a TV.

- Ack

Header	Command	ID	Data length	Ack/Nak	r-CMD	Val1	Checksum
0xAA	0xFF		3	'A'	0x14	"Input Source"	

"Input Source": An input source code to be set on a product.

- Nak

Header	Command	ID	Data length	Ack/Nak	r-CMD	Val1	Checksum
0xAA	0xFF		3	'N'	0x14	"ERR"	

"ERR" : A code showing what error has occurred.

## Screen mode control

- Function  
The screen mode of a product can be changed using a PC.  
Screen mode cannot be controlled when the **Video Wall** function is enabled.

— This control can only be used on models that include a TV.

- Viewing screen status (Get Screen Mode Status)

Header	Command	ID	Data length	Checksum
0xAA	0x18		0	

- Setting the picture size (Set Picture Size)

Header	Command	ID	Data length	Data	Checksum
0xAA	0x18		1	"Screen Mode"	

"Screen Mode": A code that sets the product status

0x01	16:9
0x04	Zoom
0x31	Wide Zoom
0x0B	4:3

- Ack

Header	Command	ID	Data length	Ack/Nak	r-CMD	Val1	Checksum
0xAA	0xFF		3	'A'	0x18	"Screen Mode"	

"Screen Mode": A code that sets the product status

- Nak

Header	Command	ID	Data length	Ack/Nak	r-CMD	Val1	Checksum
0xAA	0xFF		3	'N'	0x18	"ERR"	

"ERR": A code showing what error has occurred

## Screen size control

- Function  
The screen size of a product can be changed using a PC.

- Viewing the screen size (Get Screen Size Status)

Header	Command	ID	Data length	Checksum
0xAA	0x19		0	

- Ack

Header	Command	ID	Data length	Ack/Nak	r-CMD	Val1	Checksum
0xAA	0xFF		3	'A'	0x19	"Screen Size"	

"Screen Size": product screen size (range: 0 – 255, unit: inch)

- Nak

Header	Command	ID	Data length	Ack/Nak	r-CMD	Val1	Checksum
0xAA	0xFF		3	'N'	0x19	"ERR"	

"ERR": A code showing what error has occurred

## PIP On/Off control

- Function  
The PIP mode of a product can be turned on or off using a PC.
  - Only available on models that have the PIP function.
  - The mode cannot be controlled if **Video Wall** is set to **On**.
  - This function is not available in **MagicInfo**.
- Viewing PIP on/off state (Get the PIP ON / OFF Status)

Header	Command	ID	Data length	Checksum
0xAA	0x3C		0	

- Setting PIP on/off (Set the PIP ON / OFF)

Header	Command	ID	Data length	Data	Checksum
0xAA	0x3C		1	"PIP"	

"PIP": A code used to turn the PIP mode of a product on or off

1: PIP ON

0: PIP OFF

- Ack

Header	Command	ID	Data length	Ack/Nak	r-CMD	Val1	Checksum
0xAA	0xFF		3	'A'	0x3C	"PIP"	

"PIP": A code used to turn the PIP mode of a product on or off

- Nak

Header	Command	ID	Data length	Ack/Nak	r-CMD	Val1	Checksum
0xAA	0xFF		3	'A'	0x3C	"PIP"	

"ERR": A code showing what error has occurred

## Auto adjustment control (PC and BNC only)

- Function  
Automatically adjust the PC system screen using a PC.
- Viewing auto adjustment state (Get Auto Adjustment Status)  
None
- Setting auto adjustment (Set Auto Adjustment)

Header	Command	ID	Data length	Data	Checksum
0xAA	0x3D		1	"Auto Adjustment"	

"Auto Adjustment" : 0x00 (at all times)

- Ack

Header	Command	ID	Data length	Ack/Nak	r-CMD	Val1	Checksum
0xAA	0xFF		3	'A'	0x3D	"Auto Adjustment"	

- Nak

Header	Command	ID	Data length	Ack/Nak	r-CMD	Val1	Checksum
0xAA	0xFF		3	'A'	0x3D	"ERR"	

"ERR": A code showing what error has occurred

## Video Wall Mode Control

- Function  
**Video Wall** mode can be activated on a product using a PC.  
 This control is only available on a product whose **Video Wall** is enabled.
- Viewing video wall mode (Get Video Wall Mode)

Header	Command	ID	Data length	Checksum
0xAA	0x5C		0	

- Setting the video wall (Set Video Wall Mode)

Header	Command	ID	Data length	Data	Checksum
0xAA	0x5C		1	"Video Wall Mode"	

"Video Wall Mode": A code used to activate Video Wall mode on a product

1: **Full**

0: **Natural**

- Ack

Header	Command	ID	Data length	Ack/Nak	r-CMD	Val1	Checksum
0xAA	0xFF		3	'A'	0x5C	"Video Wall Mode"	

"Video Wall Mode": A code used to activate Video Wall mode on a product

- Nak

Header	Command	ID	Data length	Ack/Nak	r-CMD	Val1	Checksum
0xAA	0xFF		3	'A'	0x5C	"ERR"	

"ERR": A code showing what error has occurred

## Safety Lock

- Function  
 PC can be used to turn the **Safety Lock** function on or off on a product.  
 This control is available regardless of whether or not the power is turned on.
- Viewing the safety lock state (Get Safety Lock Status)

Header	Command	ID	Data length	Checksum
0xAA	0x5D		0	

- Enabling or disabling safety lock (Set Safety Lock Enable / Disable)

Header	Command	ID	Data length	Data	Checksum
0xAA	0x5D		1	"Safety Lock"	

"Safety Lock": Safety lock code to be set on a product

1: ON

0: OFF

- Ack

Header	Command	ID	Data length	Ack/Nak	r-CMD	Val1	Checksum
0xAA	0xFF		3	'A'	0x5D	"Safety Lock"	

"Safety Lock": Safety lock code to be set on a product

- Nak

Header	Command	ID	Data length	Ack/Nak	r-CMD	Val1	Checksum
0xAA	0xFF		3	'N'	0x5D	"ERR"	

"ERR": A code showing what error has occurred

## Video Wall On

- Function  
Turn Video Wall on or off on the product from your computer.
- Get Video Wall On/Off Status

Header	Command	ID	Data length	Checksum
0xAA	0x84		0	

- Set Video Wall On/Off

Header	Command	ID	Data length	Data	Checksum
0xAA	0x84		1	V.Wall_On	

- V.Wall\_On: Video Wall code to be assigned to the product

1: Video Wall ON

0: Video Wall OFF

- Ack

Header	Command	ID	Data length	Ack/Nak	r-CMD	Val1	Checksum
0xAA	0xFF		3	'A'	0x84	V.Wall_On	

V.Wall\_On : Same as above

- Nak

Header	Command	ID	Data length	Ack/Nak	r-CMD	Val1	Checksum
0xAA	0xFF		3	'N'	0x84	ERR	

"ERR": A code showing what error has occurred

## Video Wall User Control

- Function  
Turn the Video Wall function on or off on the product from your computer.
- Get Video Wall Status

Header	Command	ID	Data length	Checksum
0xAA	0x89		0	

- Set Video Wall

Header	Command	ID	Data length	Val1	Val2	Checksum
0xAA	0x89		2	Wall_Div	Wall_SNo	

Wall\_Div: Video Wall Divider code assigned to the product

## 10x10 Video Wall Model

	1	2	3	4	5	6	7	8	9	10	11	12	13	14	15
<b>Off</b>	0x00	0x00	0x00	0x00	0x00	0x00	0x00	0x00	0x00	0x00	0x00	0x00	0x00	0x00	0x00
<b>1</b>	0x11	0x12	0x13	0x14	0x15	0x16	0x17	0x18	0x19	0x1A	0x1B	0x1C	0x1D	0x1E	0x1F
<b>2</b>	0x21	0x22	0x23	0x24	0x25	0x26	0x27	0x28	0x29	0x2A	0x2B	0x2C	0x2D	0x2E	0x2F
<b>3</b>	0x31	0x32	0x33	0x34	0x35	0x36	0x37	0x38	0x39	0x3A	0x3B	0x3C	0x3D	0x3E	0x3F
<b>4</b>	0x41	0x42	0x43	0x44	0x45	0x46	0x47	0x48	0x49	0x4A	0x4B	0x4C	0x4D	0x4E	0x4F
<b>5</b>	0x51	0x52	0x53	0x54	0x55	0x56	0x57	0x58	0x59	0x5A	0x5B	0x5C	0x5D	0x5E	0x5F
<b>6</b>	0x61	0x62	0x63	0x64	0x65	0x66	0x67	0x68	0x69	0x6A	0x6B	0x6C	0x6D	0x6E	0x6F
<b>7</b>	0x71	0x72	0x73	0x74	0x75	0x76	0x77	0x78	0x79	0x7A	0x7B	0x7C	0x7D	0x7E	N/A
<b>8</b>	0x81	0x82	0x83	0x84	0x85	0x86	0x87	0x88	0x89	0x8A	0x8B	0x8C	N/A	N/A	N/A
<b>9</b>	0x91	0x92	0x93	0x94	0x95	0x96	0x97	0x98	0x99	0x9A	0x9B	N/A	N/A	N/A	N/A
<b>10</b>	0xA1	0xA2	0xA3	0xA4	0xA5	0xA6	0xA7	0xA8	0xA9	0xAA	N/A	N/A	N/A	N/A	N/A
<b>11</b>	0xB1	0xB2	0xB3	0xB4	0xB5	0xB6	0xB7	0xB8	0xB9	N/A	N/A	N/A	N/A	N/A	N/A
<b>12</b>	0xC1	0xC2	0xC3	0xC4	0xC5	0xC6	0xC7	0xC8	N/A	N/A	N/A	N/A	N/A	N/A	N/A
<b>13</b>	0xD1	0xD2	0xD3	0xD4	0xD5	0xD6	0xD7	N/A	N/A	N/A	N/A	N/A	N/A	N/A	N/A
<b>14</b>	0xE1	0xE2	0xE3	0xE4	0xE5	0xE6	0xE7	N/A	N/A	N/A	N/A	N/A	N/A	N/A	N/A
<b>15</b>	0xF1	0xF2	0xF3	0xF4	0xF5	0xF6	N/A	N/A	N/A	N/A	N/A	N/A	N/A	N/A	N/A

## 10x10 Video Wall Model : ( 1 ~ 100)

Set Number	Data
1	0x01
2	0x02
...	...
99	0x63
100	0x64

- Ack

Header	Command	ID	Data length	Ack/Nak	r-CMD	Val1	Val2	Checksum
0xAA	0xFF		4	'A'	0x89	Wall_Div	Wall_SNo	

- Nak

Header	Command	ID	Data length	Ack/Nak	r-CMD	Val1	Checksum
0xAA	0xFF		3	'N'	0x89	ERR	

"ERR": A code showing what error has occurred



# Chapter 03

## Connecting and Using a Source Device

### Before Connecting

Check the following before you connect this product with other devices.

Devices that can be connected to this product include PCs, camcorders, speakers, set top boxes and DVD/Blu-ray Disc players.

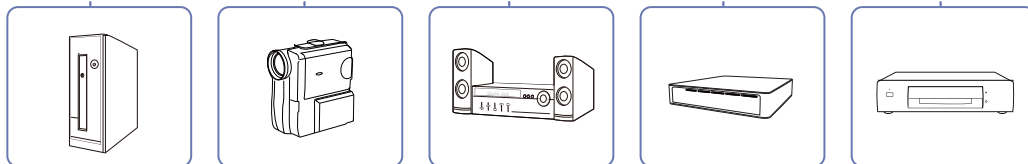
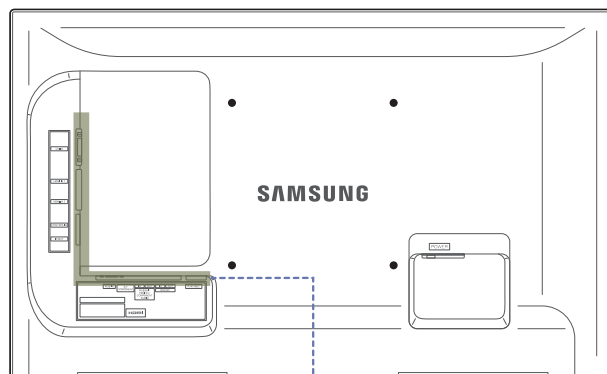

### Pre-connection Checkpoints

- Before connecting a source device, read the user manual provided with it.  
The number and locations of ports on source devices may differ from device to device.
- Do not connect the power cable until all connections are completed.  
Connecting the power cable during connection may damage the product.
- Connect the sound ports correctly: left = white and right = red.
- Check the types of ports at the back of the product you want to connect.

## Connecting to a PC

- Do not connect the power cable before connecting all other cables.  
Ensure you connect a source device first before connecting the power cable.
- A PC can be connected to the product in a variety of ways.  
Select a connection method suitable for your PC.

— Connecting parts may differ in different products.

### Connection using the D-SUB cable (Analog type)

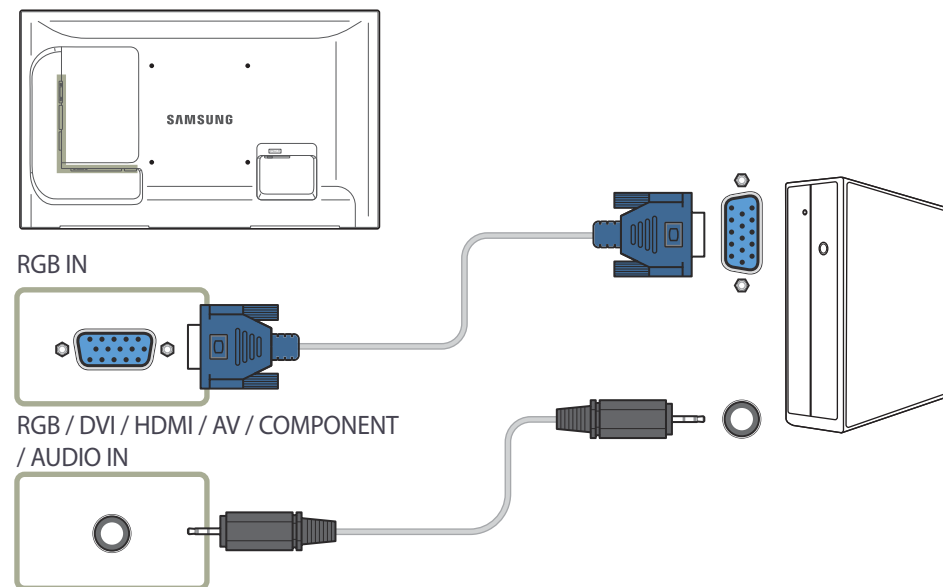

## Connection using a DVI cable (Digital type)

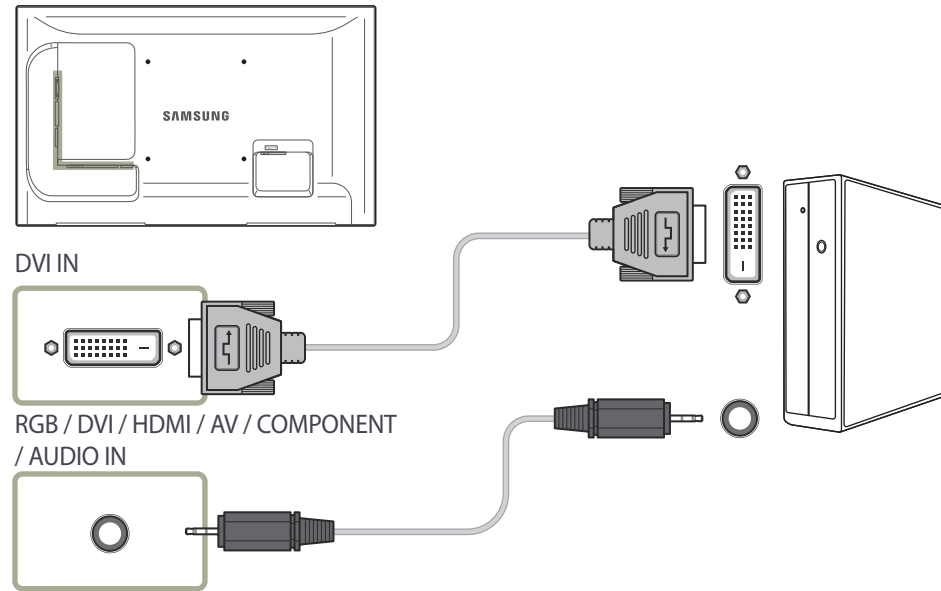

## Connection Using an HDMI-DVI Cable

— When you connect a PC to the product using an HDMI-DVI cable, set **Edit Name** to **DVI PC** to access video and audio content stored on the PC.

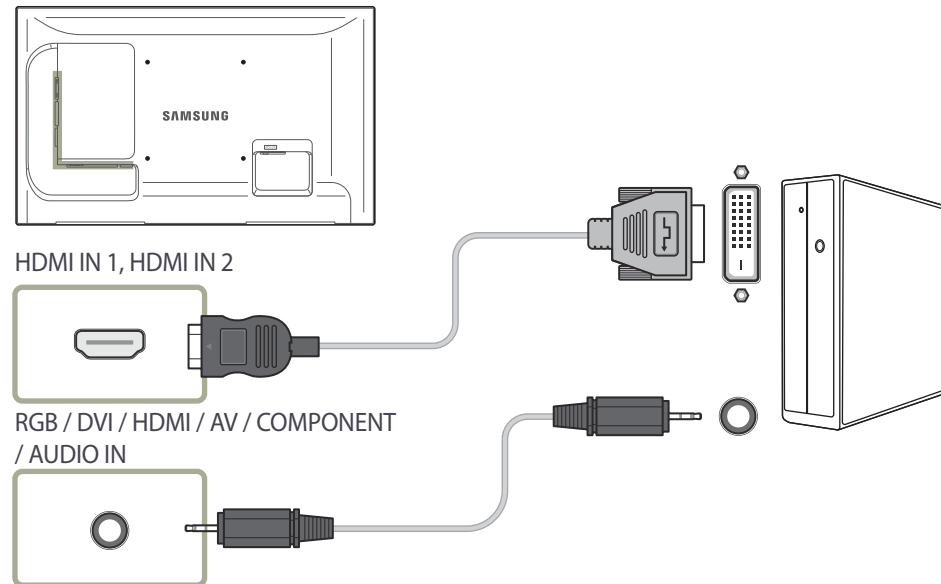

---

## Connection Using an HDMI Cable

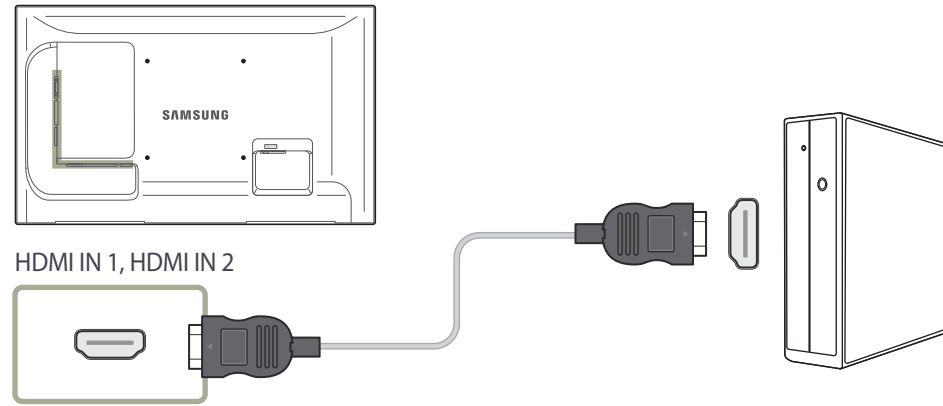

# Changing the Resolution

- Adjust the resolution and refresh rate in Control Panel on your PC to obtain optimum picture quality.
- The picture quality of TFT-LCDs may degrade if the optimum resolution is not selected.

## Changing the Resolution on Windows XP

Go to **Control Panel** → **Display** → **Settings**, and change the resolution.

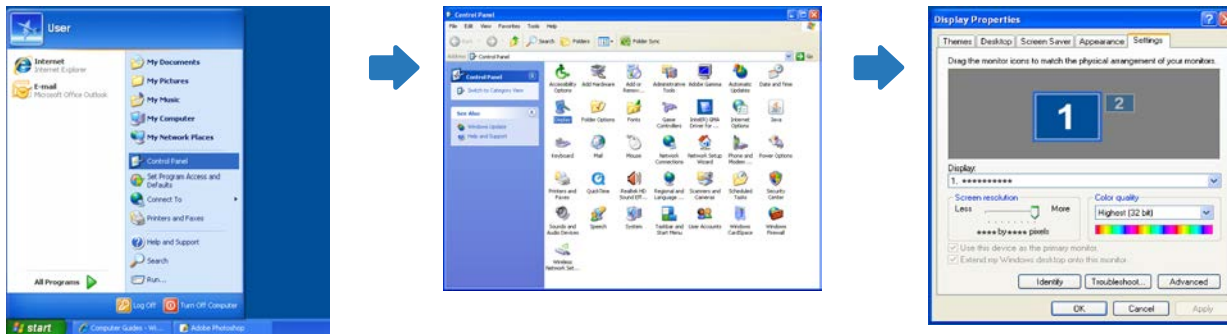

## Changing the Resolution on Windows Vista

Go to **Control Panel** → **Personal Settings** → **Display Settings**, and change the resolution.

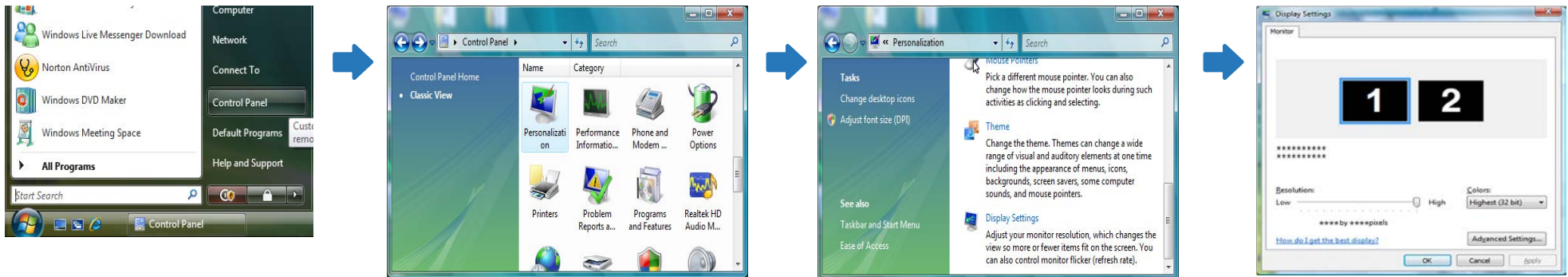

## Changing the Resolution on Windows 7

Go to **Control Panel** → **Display** → **Screen Resolution**, and change the resolution.

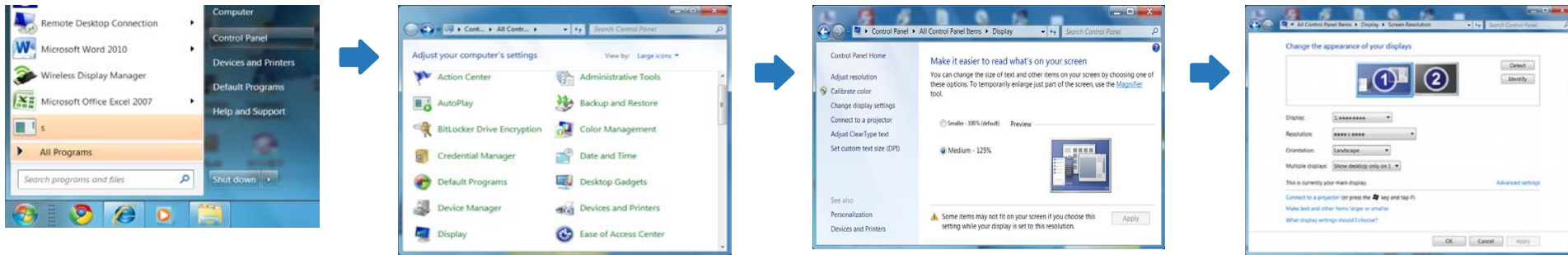

## Changing the Resolution on Windows 8

Go to **Settings** → **Control Panel** → **Display** → **Screen Resolution**, and change the resolution.

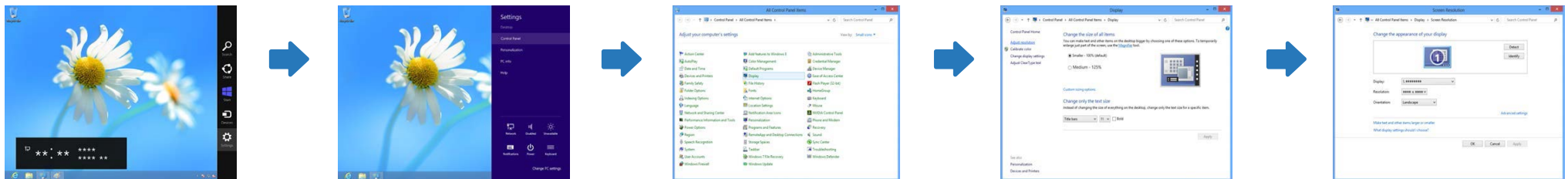

## Connecting to a Video Device

- Do not connect the power cable before connecting all other cables. Ensure you connect a source device first before connecting the power cable.
- You can connect a video device to the product using a cable.
  - Connecting parts may differ in different products.
  - Press the **SOURCE** button on the remote control to change the source.

## Connection Using the AV Cable

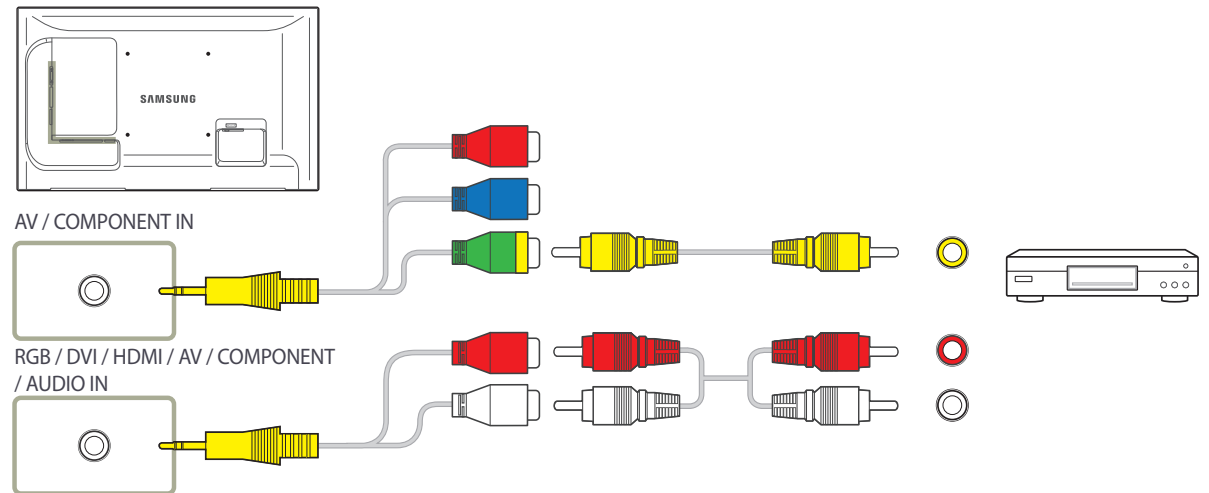

## Connection Using the component Cable

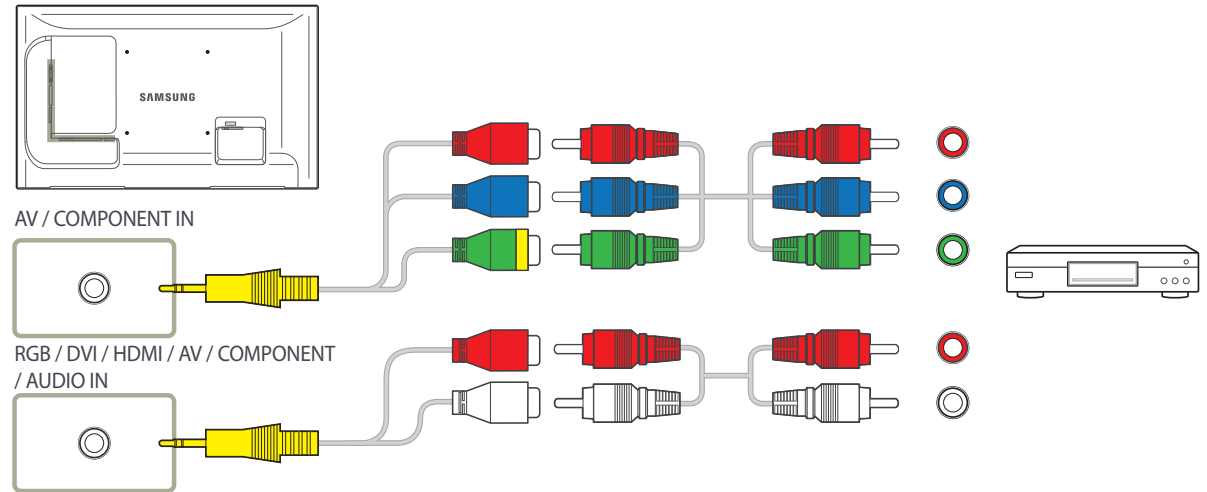

## Connection Using an HDMI-DVI Cable

— Audio will not be enabled if the product is connected to a video device using an HDMI-DVI cable. To resolve this, additionally connect an audio cable to the audio ports on the product and video device.

When you connect a video device to the product using an HDMI-DVI cable, set **Edit Name** to **DVI Devices** to access video and audio content stored on the video device.

— Supported resolutions include 1080p (50/60Hz), 720p (50/60Hz), 480p, and 576p.

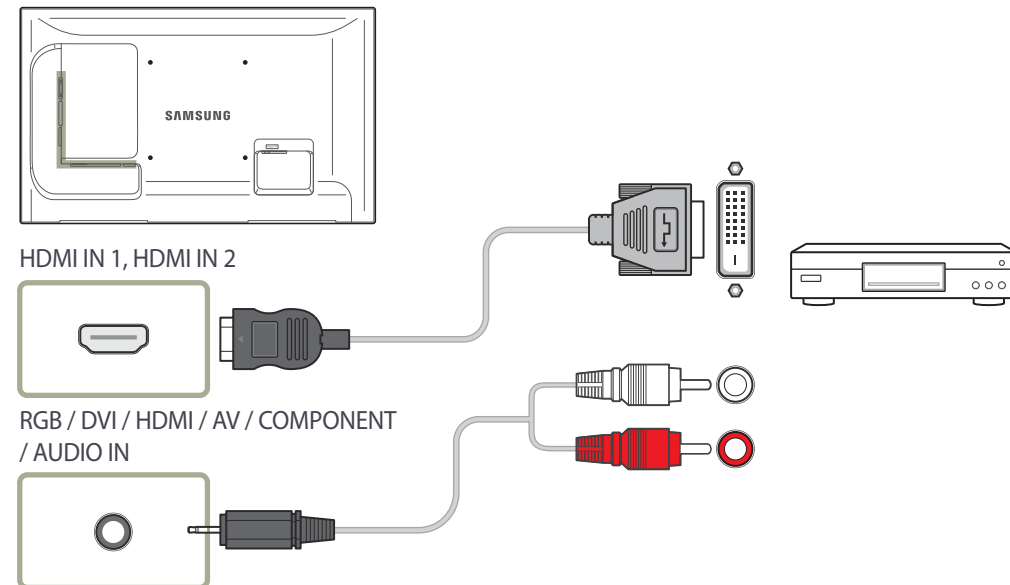



## Connection Using an HDMI Cable

### Using an HDMI cable or HDMI-DVI Cable (up to 1080p)

- For better picture and audio quality, connect to a digital device using an HDMI cable.
- An HDMI cable supports digital video and audio signals, and does not require an audio cable.
  - To connect the product to a digital device that does not support HDMI output, use an HDMI-DVI and audio cables.
- The picture may not display normally (if at all) or the audio may not work if an external device that uses an older version of HDMI mode is connected to the product. If such a problem occurs, ask the manufacturer of the external device about the HDMI version and, if out of date, request an upgrade.
- Be sure to use an HDMI cable with a thickness of 14 mm or less.
- Be sure to purchase a certified HDMI cable. Otherwise, the picture may not display or a connection error may occur.
- A basic high-speed HDMI cable or one with ethernet is recommended. This product does not support the ethernet function via HDMI.

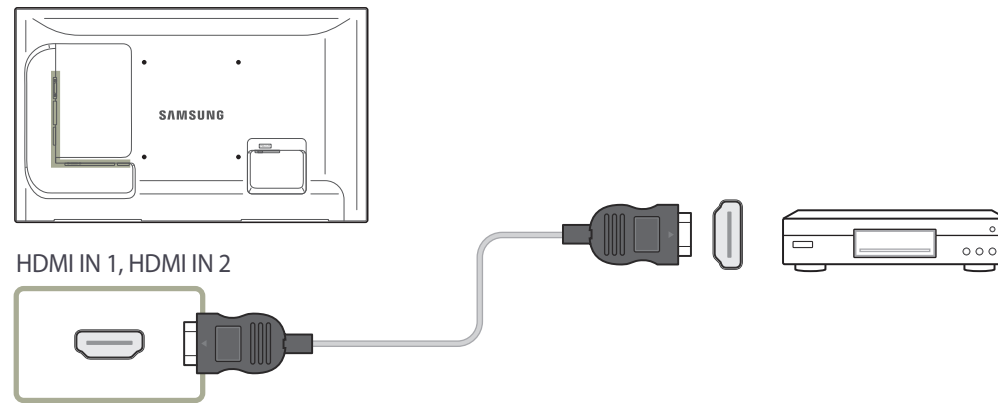

## Connecting to an Audio System

Connecting parts may differ in different products.

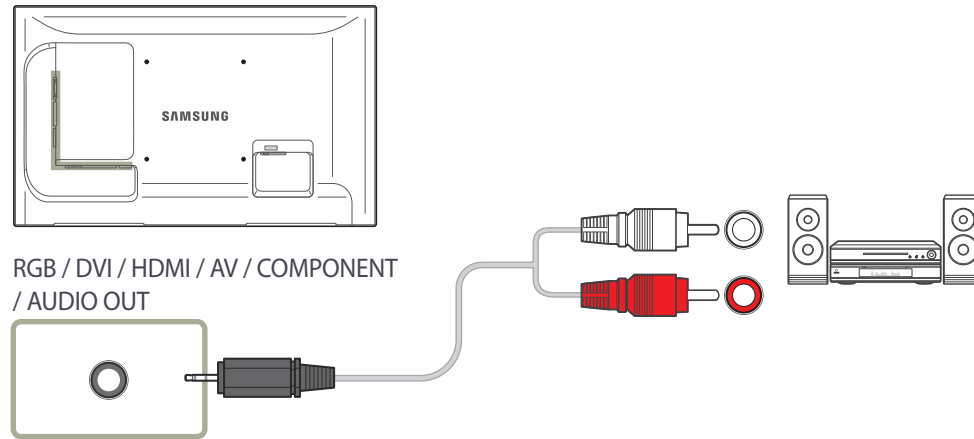

## Connecting the network box (Sold separately)

— For details on how to connect to a network box, refer to the user's manual provided with the network box upon purchase.

### MagicInfo

To use **MagicInfo**, a network box (sold separately) must be connected to the product.

— To change the MagicInfo settings, run "MagicInfoSetupWizard" on the desktop.

— For details on how to use **MagicInfo**, refer to the DVD provided with the network box.

— The information in this section is subject to change without notice for quality improvement.

— If a problem occurs after installing an operating system other than the one provided with the network box, restoring the previous version of the operating system, or installing software that is not compatible with the operating system provided, you will not be able to benefit from technical support and will be charged a fee for a visit from a service technician. A product exchange or refund will also not be available.

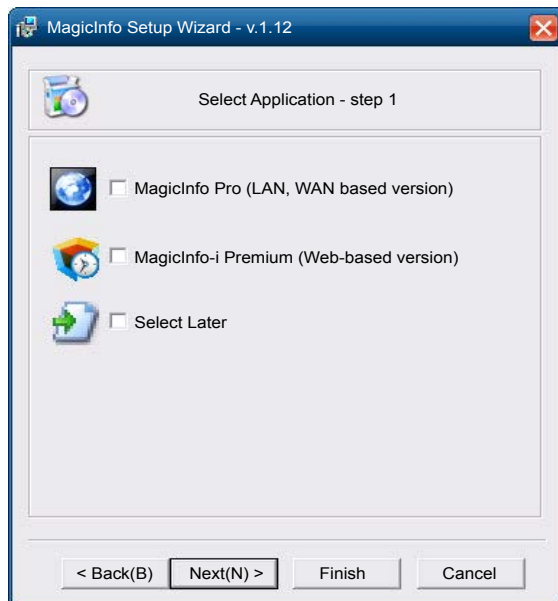

### Entering MagicInfo mode

- 1 After installing and connecting the network box (sold separately) to the product, power on the product.
- 2 Press **SOURCE** on the remote control, and select **MagicInfo**.
- 3 Select the default application you want to run when MagicInfo starts.

4 Enter the IP information.

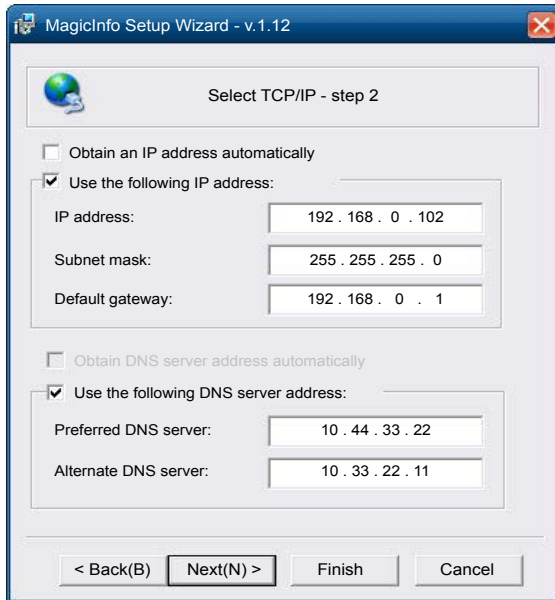

5 Select a language. (The default language is English.)



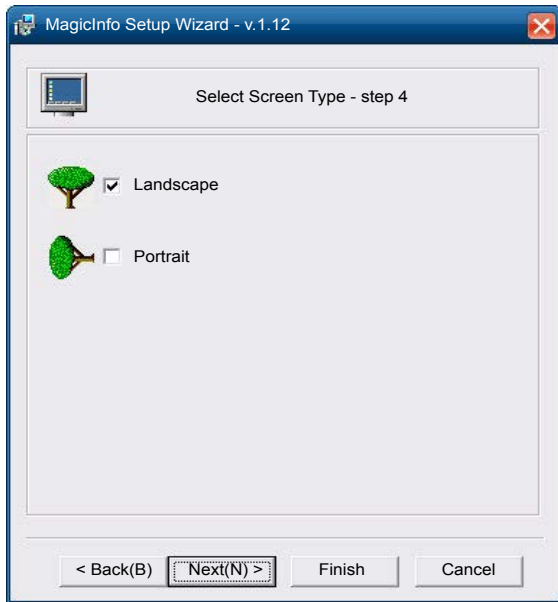

6 Select a display mode.

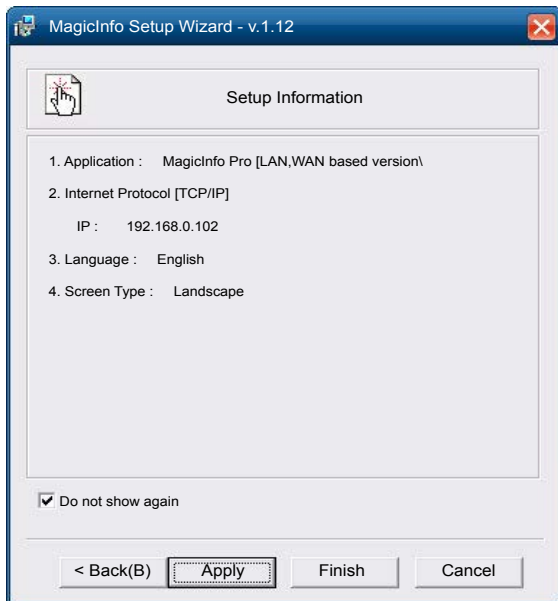

7 Double-check the settings you have just configured.

— If the execution icon does not appear, double-click the **MagicInfo** icon on the desktop. The icon will appear at the bottom right of the screen.

# Chapter 04

## Input

### Source List

MENU  → Input → Source List → ENTER 

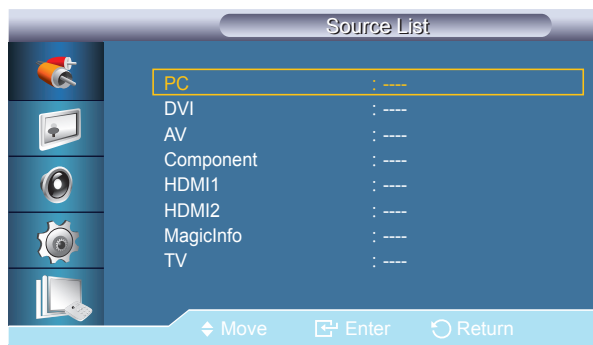

– The displayed image may differ depending on the model.

Use to select **PC**, **HDMI** or other external input sources connected to the LCD Display.

Use to select the screen of your choice.

- 1 **PC**
- 2 **DVI**
- 3 **AV**
- 4 **Component**
- 5 **HDMI1**
- 6 **HDMI2**
- 7 **MagicInfo**
- 8 **TV**

This is deactivated when a network box is installed.

Activated when a network box is connected.

# PIP

## PIP

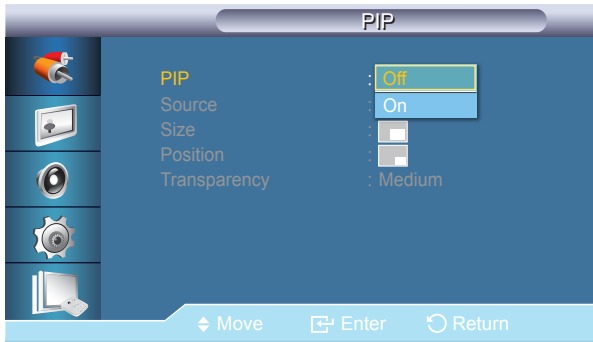

- The displayed image may differ depending on the model.

## Source

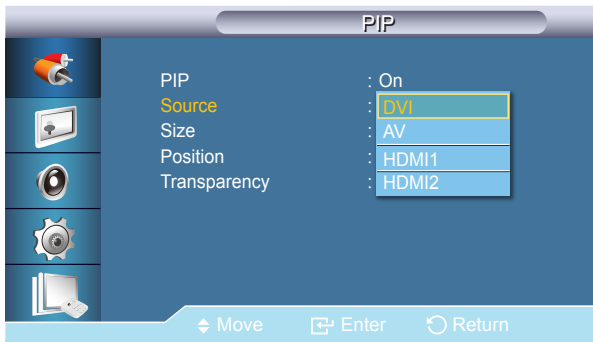

- The displayed image may differ depending on the model.

Turns the **PIP** Screen **Off/On**.

- **Off / On**

— PIP turns off when the LCD Display is switched to an external source.

— If you select    in **Size**, **Position** and **Transparency** will not be activated.

— The **PIP** function is not available when **Video Wall** is **On**.

— When external AV devices such as VCRs or DVDs are connected to the LCD Display , **PIP** allows you to watch video from those devices in a small window super-imposed on the PC Video signal.

Selects the input source for the PIP.

### Primary Source

### Secondary Source

PC

DVI, AV, HDMI1, HDMI2

DVI

PC

AV

PC

HDMI1

PC

HDMI2

PC

PIM

PC, AV, Component

— PIP is disabled if the primary screen does not receive a signal.

## Size

Changes the Size of the PIP window.

— **Picture > Size** will be changed to **16:9** when **PIP** is **On**.

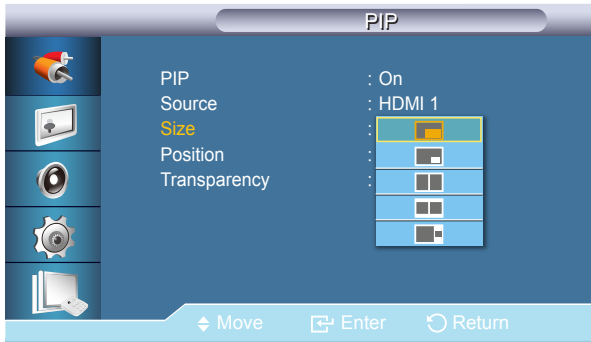

– The displayed image may differ depending on the model.

## Position

Changes the Position of the PIP window.

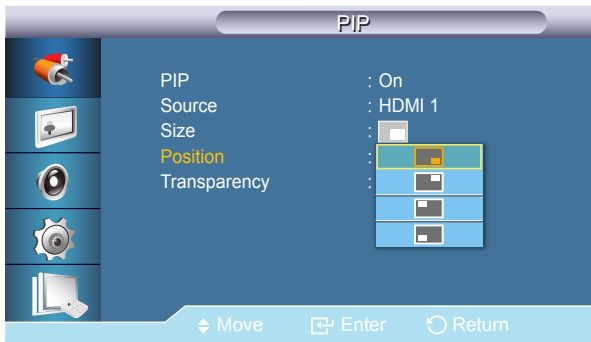

– The displayed image may differ depending on the model.



## Transparency

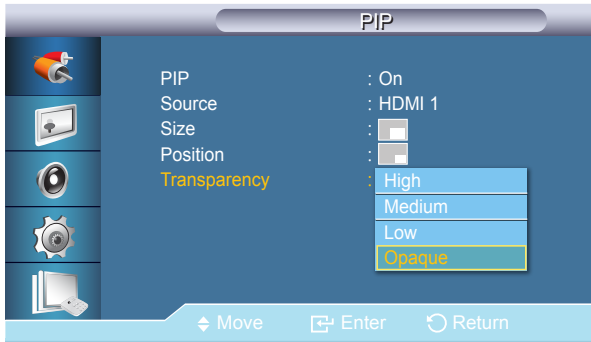

– The displayed image may differ depending on the model.

Adjusts the Transparency of PIP windows.

- **High**
- **Medium**
- **Low**
- **Opaque**

## Edit Name

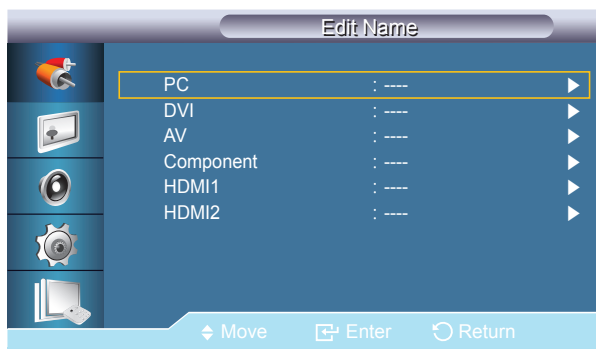

– The displayed image may differ depending on the model.

Name the input device connected to the input jacks to make your input source selection easier.

**VCR / DVD / Cable STB / HD STB / Satellite STB / AV Receiver / DVD Receiver / Game / Camcorder / DVD Combo / DHR / PC / DVI PC / DVI Devices**

— The displayed devices differ depending on the external input mode.

When connecting a PC to the HDMI terminal, set **Edit Name** to **PC**. In other cases, set **Edit Name** to **AV**. However, since 640x480, 720p (1280x720), and 1080p (1920x1080) are common signals for **AV** and **PC**, make sure to set the **Edit Name** in accordance with the input signal.

— The **Picture** menu changes depending on the input signal and **Edit Name**.

When using a HDMI-DVI cable connection (which does not support audio and video at the same time), the audio port should be connected via a separate audio cable.

When a PC is connected, set **Edit Name** to **DVI PC** to enjoy the video and audio from the connected PC.

When an AV device is connected, set **Edit Name** to **DVI Devices** to enjoy the video and audio from the connected AV device.

# Source AutoSwitch Settings

## Source AutoSwitch

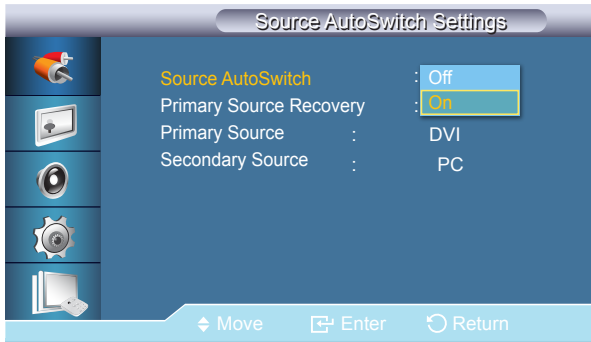

- The displayed image may differ depending on the model.
- **Source AutoSwitch Settings** is disabled if **PIP** is set to **On**.

## Primary Source Recovery

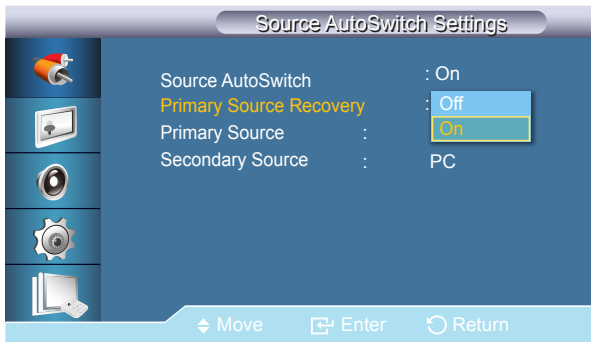

- The displayed image may differ depending on the model.

When the **Source AutoSwitch** is **On**, the display video source will automatically be searched for active video.

The **Primary Source** selection will be activated, if the current video source is not recognized.

**Secondary Source** selection will become active, if no primary video source is available. If the primary or secondary source is not recognized, the display will search again, if no active video is found the display will show the no-input-signal message.

When the **Primary Source** selection is set to **All**, the display will search all the video source inputs twice in sequence looking for an active video source, returning back to the first video source in the sequence if no video is found.

- **Off / On**
- **Source AutoSwitch** selection and **PIP** function: If the **Source AutoSwitch** selection is set to **On**, the **PIP** function will not work, the **Source AutoSwitch** selection must be set to **Off**, for the **PIP** feature to work.
- When the **Source AutoSwitch** selection is **On**, and or the **Primary Source Recovery** is **On**, the display power saving mode becomes inactive.
- When **Primary Source Recovery** is **On**, only the **Primary Source** and **Secondary Source** selection are available and they are interchangeable and selectable at will. Refer to **PIP > Source** for compatible signals for each primary input source.

When **Primary Source Recovery** is **On**, only the **Primary Source** and **Secondary Source** video source selection will be searched for active video.

The **Primary Source** will be selected if active video is found, if no video is found, the **Secondary Source** will be selected, if no video is found in **Secondary Source** again, the no-input-signal is displayed.

- **Off / On**

## Primary Source

Specify **Primary Source** for the automatic input source.

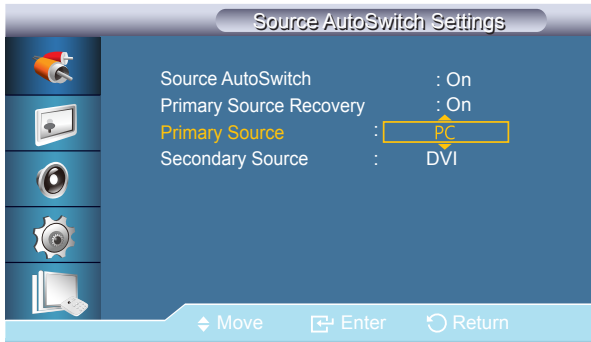

- The displayed image may differ depending on the model.

## Secondary Source

Specify **Secondary Source** for the automatic input source.

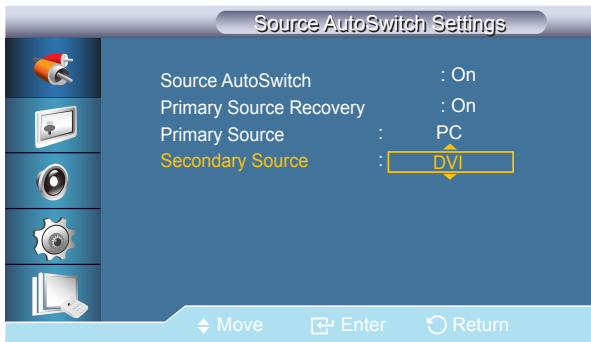

- The displayed image may differ depending on the model.

# Chapter 05

## Picture

PC / DVI / MagicInfo Mode

### Mode

MENU  → **Picture** → **Mode** → ENTER 

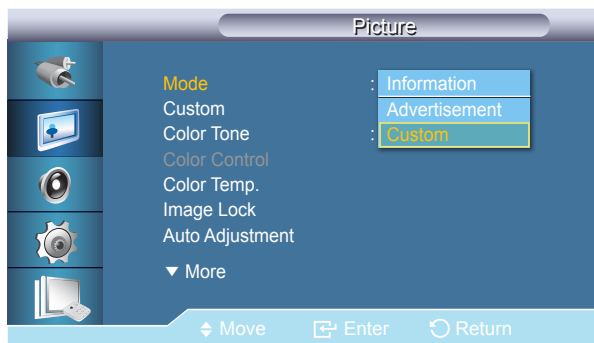

– The displayed image may differ depending on the model.

The LCD Display has four automatic picture settings ("**Information**", "**Advertisement**" and "**Custom**") that are preset at the factory.

- **Information**  
Recommended for communicating exact information (e.g. public information).
- **Advertisement**  
Recommended for displaying advertisements (e.g. videos or indoor or outdoor ads).
- **Custom**

— Not available when **Dynamic Contrast** is set to **On**.

## Custom



– The displayed image may differ depending on the model.

By using the on-screen menus, the contrast and brightness can be changed to your personal preference.

— By adjusting the picture using the **Custom** function, **Mode** will change to **Custom** mode.

— Not available when **Dynamic Contrast** is set to **On**.

### Contrast

Adjusts the Contrast.

### Brightness

Adjusts the Brightness.

### Sharpness

Adjusts the Sharpness.

### Gamma

Adjust the mid-range brightness (Gamma) for the picture.

- **Natural**
- **Mode1**  
Sets the picture brighter than **Natural**.
- **Mode2**  
Sets the picture darker than **Mode1**.
- **Mode3**  
Increases the contrast between dark and bright colors.

## Color Tone



- The displayed image may differ depending on the model.

The Color tones can be changed.

- Not available when **Dynamic Contrast** is set to **On**.
  - **Off / Cool / Normal / Warm / Custom**
- If you set the **Color Tone** to **Cool, Normal, Warm, or Custom**, the **Color Temp.** function is disabled.
- If you set the **Color Tone** to **Off**, the **Color Control** function is disabled

## Color Control

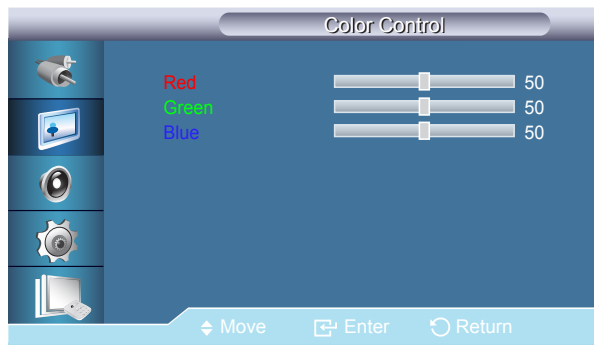

- The displayed image may differ depending on the model.

Adjusts individual Red, Green, Blue Color balance.

- Not available when **Dynamic Contrast** is set to **On**.
  - **Red / Green / Blue**

## Color Temp.



- The displayed image may differ depending on the model.

**Color Temp.** is a measure of the 'warmth' of the image Colors.

— This function is enabled when **Mode** is set to **Custom**, and **Dynamic Contrast** and **Color Tone** are **Off**.

## Image Lock

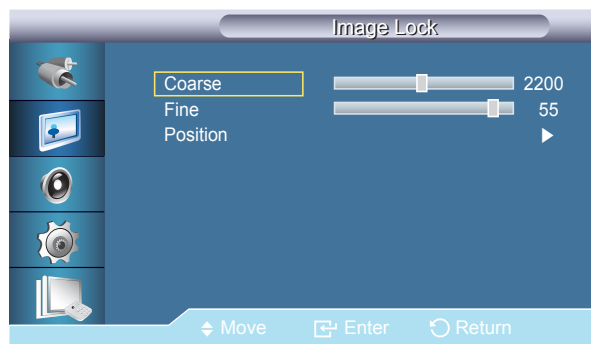

- The displayed image may differ depending on the model.
- Available in **PC** mode only.

**Image Lock** is used to fine-tune and get the best image by removing noise that creates unstable images with jitters and shakiness. If satisfactory results are not obtained using the Fine adjustment, use the Coarse adjustment and then use Fine again.

- **Coarse**  
Removes noise such as vertical stripes. Coarse adjustment may move the screen image area. You may relocate it to the Center using the horizontal control menu.
- **Fine**  
Removes noise such as horizontal stripes. If the noise persists even after Fine tuning, repeat it after adjusting the frequency (clock speed).
- **Position**  
Adjusts the screen location horizontally and vertically.

## Auto Adjustment

The values of **Fine**, **Coarse**, **Position** are adjusted automatically.  
By changing the resolution in the control panel, the auto function is performed.

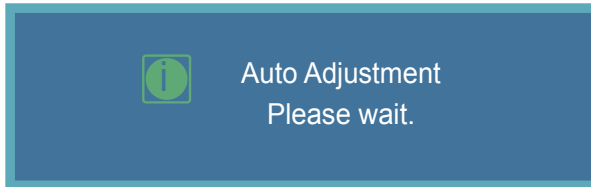

- The displayed image may differ depending on the model.
- Available in **PC** mode only.

## Signal Balance

### Signal Balance

Selects either **On** or **Off** with the signal balance.

### Signal Control

Available when **Signal Control** is set to **On**.

- **R-Gain / G-Gain / B-Gain / R-Offset / G-Offset / B-Offset**

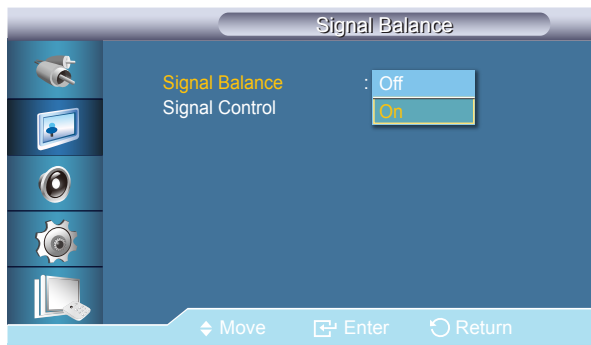

- The displayed image may differ depending on the model.



## Size

The **Size** can be switched.

- **16:9 / 4:3 / Original Ratio**

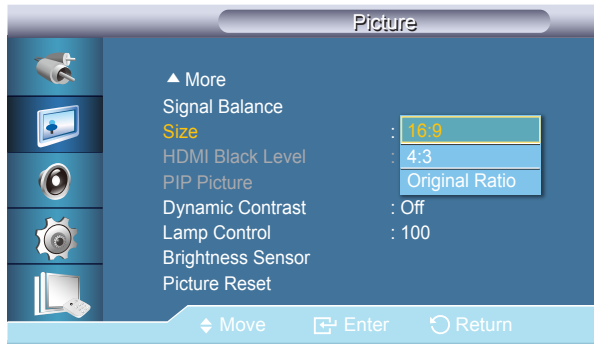

– The displayed image may differ depending on the model.

## HDMI Black Level

When a DVD or set-top box is connected to your product via HDMI or DVI port, it may cause a degradation in the screen quality, such as an increase in the black level, a low contrast, or discoloration, etc., depending on the external device connected. In this case, adjust the screen quality of your product by configuring the **HDMI Black Level**.

- **Normal / Low**

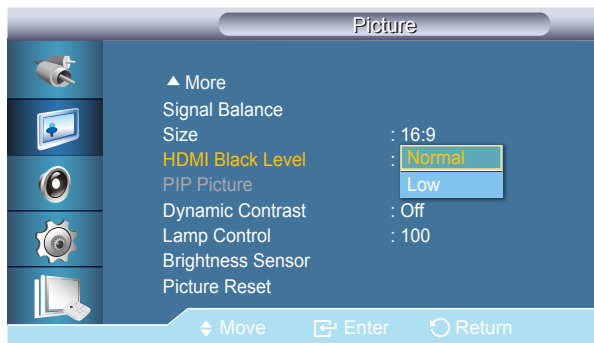

– The displayed image may differ depending on the model.

## PIP Picture



– The displayed image may differ depending on the model.

Adjusts the PIP Screen Settings.

– Available Modes: **PIP On**

- **Contrast**  
Adjusts the Contrast of the PIP window on the screen.
- **Brightness**  
Adjusts the Brightness of the PIP window on the screen.
- **Sharpness**  
Adjusts the Sharpness of the PIP window on the screen.
- **Color**  
Adjusts the Color of the PIP window on the screen.
  - **PIP** input only operates in **AV**, **HDMI1**, or **HDMI2** mode.
- **Tint**  
Adds a natural tone to the PIP window.
  - **PIP** input only operates in **AV**, **HDMI1**, or **HDMI2** mode.

## Dynamic Contrast



– The displayed image may differ depending on the model.

**Dynamic Contrast** automatically detects the distribution of the visual signal and adjusts to create an optimum contrast.

- **Off / On**
  - This function is disabled when **PIP** or **Energy Saving** is **On**.

## Lamp Control

Adjusts the inverter lamp in order to reduce energy consumption.

— Not available when **Dynamic Contrast** is set to **On**.



— The displayed image may differ depending on the model.

## Brightness Sensor

**Brightness Sensor** detects the ambient light intensity so that the picture brightness can automatically be adjusted.

- **Off / On**

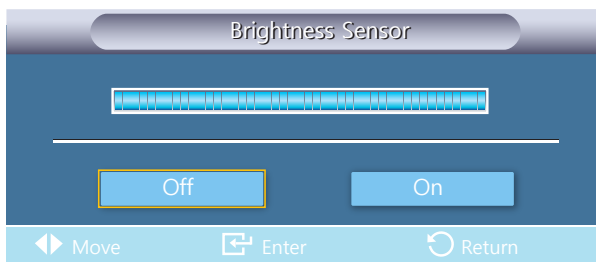

— The displayed image may differ depending on the model.

---

## Picture Reset

Reset the screen settings.

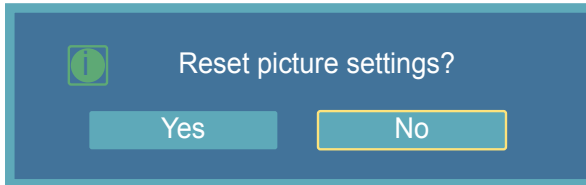

---

- The displayed image may differ depending on the model.

# Chapter 06

## Picture

AV / HDMI / TV / Component Mode

### Mode

MENU  → **Picture** → **Mode** → ENTER 

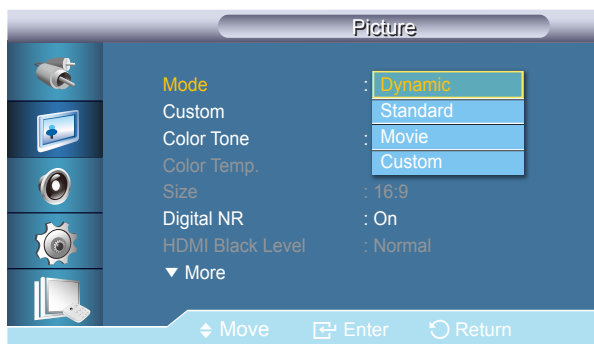

– The displayed image may differ depending on the model.

The LCD Display has four automatic picture settings ("**Dynamic**", "**Standard**", "**Movie**" and "**Custom**") that are preset at the factory.

- **Dynamic**
- **Standard**
- **Movie**
- **Custom**

— Not available when **Dynamic Contrast** is set to **On**.

## Custom



- The displayed image may differ depending on the model.

By using the on-screen menus, the contrast and brightness can be changed to your personal preference.

— Not available when **Dynamic Contrast** is set to **On**.

### Contrast

Adjusts the Contrast.

### Brightness

Adjusts the Brightness.

### Sharpness

Adjusts the picture Sharpness.

### Color

Adjusts the picture Color.

### Tint

Adds a natural tone to the display.

— The **Tint** slider is only displayed when input source is **AV**, **Component**, **HDMI1** or **HDMI2**.

## Color Tone

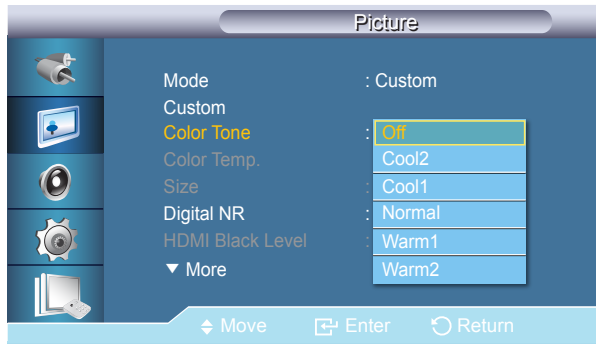

- The displayed image may differ depending on the model.

## Color Temp.



- The displayed image may differ depending on the model.

The Color tones can be changed. The individual Color components are also user adjustable.

— Not available when **Dynamic Contrast** is set to **On**.

- **Off / Cool2 / Cool1 / Normal / Warm1 / Warm2**

— If you set the **Color Tone** to **Cool2, Cool1, Normal, Warm1, or Warm2**, the **Color Temp.** function is disabled.

— Changing a setting in the **Color Tone** menu will switch the screen mode to **Custom**.

**Color Temp.** is a measure of the 'warmth' of the image Colors.

— This function is enabled when **Mode** is set to **Custom**, and **Dynamic Contrast** and **Color Tone** are **Off**.

## Size



– The displayed image may differ depending on the model.

The **Size** can be switched.

- **16:9**  
Sets the picture to 16:9 wide mode.
- **Zoom1**  
Magnifies the size of the picture on the screen.
- **Zoom2**  
Magnifies the size of the picture more than **Zoom1**.
- **4:3**  
Sets the picture to 4:3 normal mode.
- **Screen Fit**  
Displays the input scenes as they are without any cutoff when HDMI 720p, 1080i, 1080p signals are input.
- **Custom**  
Changes the resolution to suit the user's preferences.

## Digital NR

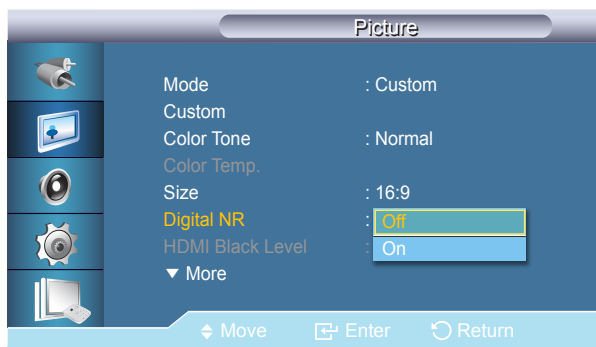

– The displayed image may differ depending on the model.

The Digital Noise Reduction feature allows you to enjoy clearer and crisper images.

- **Off / On**
- **Digital NR** function is not available for all resolutions.



## HDMI Black Level

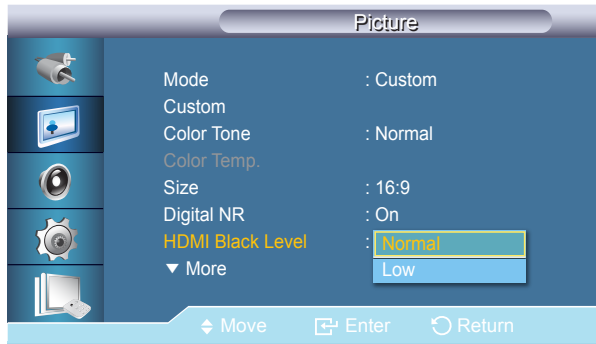

- The displayed image may differ depending on the model.

When a DVD or set-top box is connected to your product via HDMI or DVI port, it may cause a degradation in the screen quality, such as an increase in the black level, a low contrast, or discoloration, etc., depending on the external device connected. In this case, adjust the screen quality of your product by configuring the **HDMI Black Level**.

- **Normal / Low**

— For Timing which can be used for both the PC and the DTV in **HDMI** and DTV mode, **HDMI Black Level** will be activated.

## Film Mode

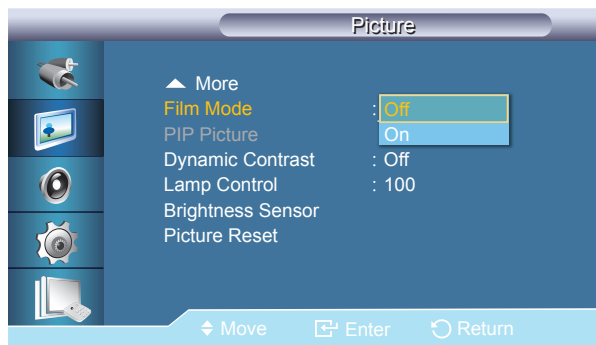

- The displayed image may differ depending on the model.

**Film Mode** calibrates unnatural picture when watching a movie (24 frames) played on a TV (30 frames).

Moving subtitles may appear corrupted when this mode is enabled.

— In **HDMI** mode, this function is available when the input signal is interlaced scan; it is not available in progressive scan.

- **Off / On**

## PIP Picture



– The displayed image may differ depending on the model.

Adjusts the PIP Screen Settings.

- **Contrast**  
Adjusts the Contrast of the PIP window on the screen.
- **Brightness**  
Adjusts the Brightness of the PIP window on the screen.
- **Sharpness**  
Adjusts the Sharpness of the PIP window on the screen.

## Dynamic Contrast

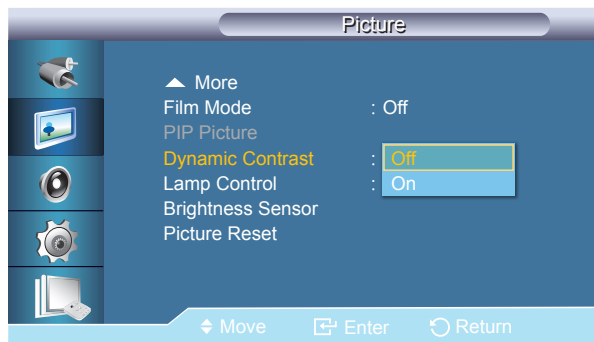

– The displayed image may differ depending on the model.

**Dynamic Contrast** automatically detects the distribution of the visual signal and adjusts to create an optimum contrast.

- **Off / On**  
— This function is disabled when **PIP** or **Energy Saving** is **On**.

## Lamp Control

Adjusts the inverter lamp in order to reduce energy consumption.

— Not available when **Dynamic Contrast** is set to **On**.



— The displayed image may differ depending on the model.

## Brightness Sensor

**Brightness Sensor** detects the ambient light intensity so that the picture brightness can automatically be adjusted.

- **Off / On**

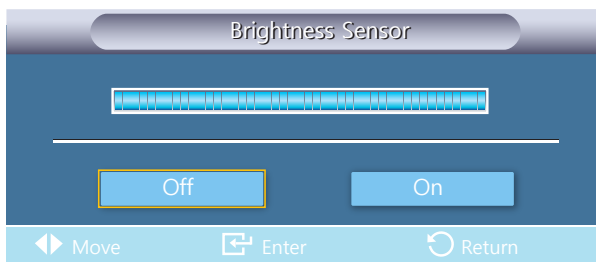

— The displayed image may differ depending on the model.

---

## Picture Reset

Reset the screen settings.

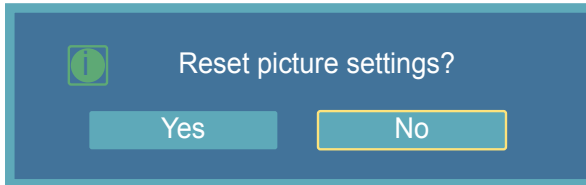

---

- The displayed image may differ depending on the model.

# Chapter 07

## Sound

### Mode

MENU  → **Sound** → **Mode** → ENTER 



– The displayed image may differ depending on the model.

The LCD Display has a built-in high fidelity stereo amplifier.

- **Standard**  
Selects **Standard** for the standard factory settings.
- **Music**  
Selects **Music** when watching music videos or concerts.
- **Movie**  
Selects **Movie** when viewing movies.
- **Speech**  
Selects **Speech** when watching a show that is mostly dialog (i.e., news).
- **Custom**  
Selects **Custom** if you want to adjust the settings according to your personal preferences.

## Custom

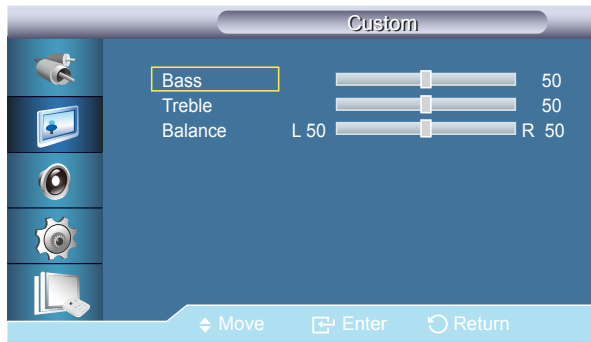

- The displayed image may differ depending on the model.

The sound settings can be adjusted to suit your personal preferences.

- You can hear the sound even when sound value is set to 0.
- If you adjust sound using **Custom** function, **Mode** will turn to **Custom** mode.

### Bass

Emphasizes low frequency audio.

### Treble

Emphasizes high frequency audio.

### Balance

Allows you to Adjusts the sound balance between the left and right speakers.

## Auto Volume

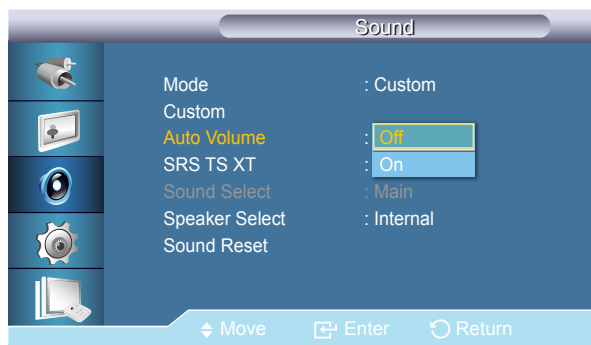

- The displayed image may differ depending on the model.

Reduces the difference in volume control between broadcasters.

- **Off / On**

## SRS TS XT

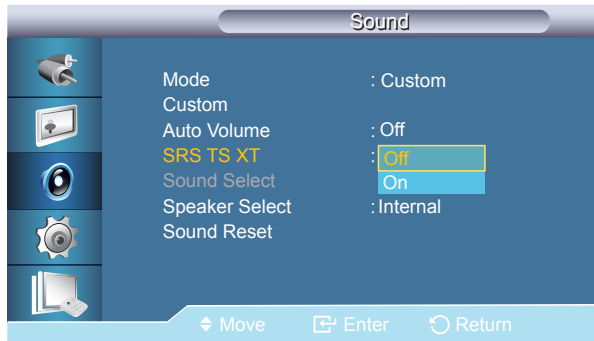

– The displayed image may differ depending on the model.

**SRS TS XT** is a patented SRS technology that solves the problem of playing 5.1 multichannel content over two speakers. TruSurround XT delivers a compelling, virtual surround sound experience through any two-speaker playback system, including internal television speakers. It is fully compatible with all multichannel formats.

- **Off / On**

## Sound Select

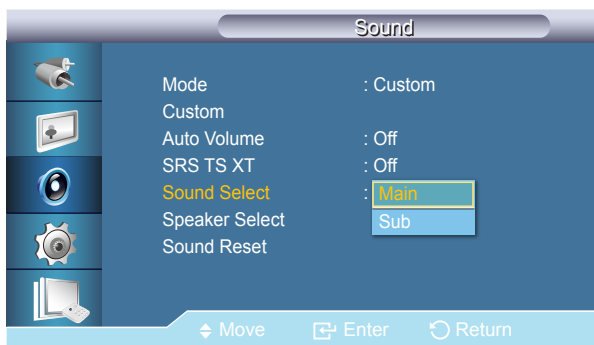

– The displayed image may differ depending on the model.

Enable the sound of either the primary or secondary display in **PIP** mode.

— Available when **PIP** is set to **On**.

- **Main / Sub**

## Speaker Select

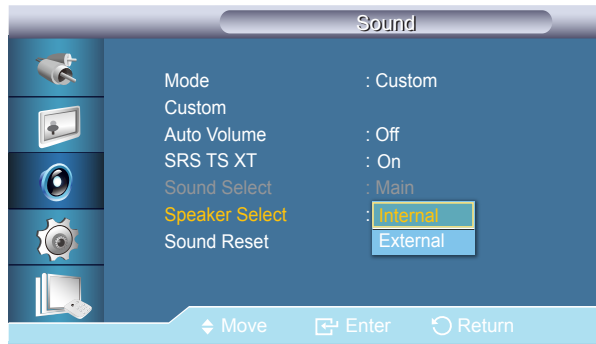

– The displayed image may differ depending on the model.

## Sound Reset

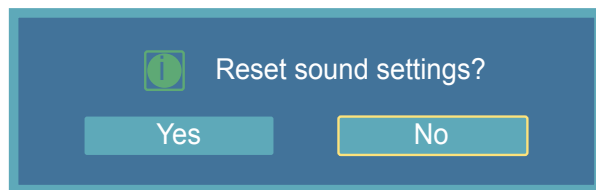

– The displayed image may differ depending on the model.

When you use the product with it connecting to a Home Theater, turn the internal speakers off so you can listen to sound from the Home Theater's (external) speakers.

- **Internal**  
Sound is outputted both from the **Internal** speaker and the **External** speakers, but the volume control is only available from the **Internal** speaker.
- **External**  
When sound is only outputted from the **External** speakers, the volume control is also only available from the **External** speakers.

Reset the sound settings.



# Chapter 08

## Setup

### Language

MENU  → Setup → Language → ENTER 



You can choose one of 14 languages.

— The language chosen affects only the language of the OSD. It has no effect on any software running on the computer.

English, Deutsch, Español, Français, Italiano, Svenska, Русский  
Português, Türkçe, Polish, 简体中文, 繁體中文, 日本語, 한국어

— The displayed image may differ depending on the model.

# Time

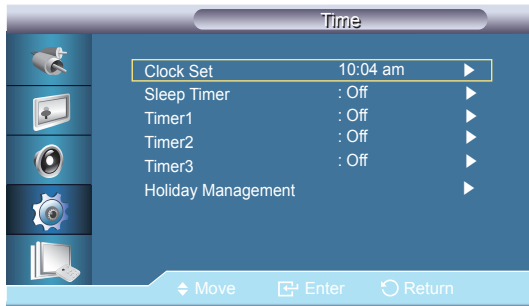

- The displayed image may differ depending on the model.

Selects from one of 4 time settings, **Clock Set**, **Sleep Timer**, **Timer**, and **Holiday Management**.

## Clock Set

Current Time Setting.

## Sleep Timer

Turns the LCD Display off automatically at certain times.

- **Off / 30 / 60 / 90 / 120 / 150 / 180**

## Timer1 / Timer2 / Timer3

You can set the LCD display to automatically turn on or off at a specified time.

- Only enabled when the clock is set using the **Clock Set** menu.
- The **Manual** option allows you to select a day of the week.
- **Holiday** : When choose **Apply**, timer is not available on holiday; when choose **Don't Apply**, timer is available on holiday.

## Holiday Management

- **Add**  
You can register holidays.
- **Delete Selected**  
You can delete selected holidays.
  - Only enabled when registered holidays are selected.
  - More than one holiday can be selected and deleted.
- **Delete All**  
You can delete all the registered holidays.

## Menu Transparency



– The displayed image may differ depending on the model.

Change the transparency of the background of the OSD.

- **High / Medium / Low / Opaque**

## Safety Lock

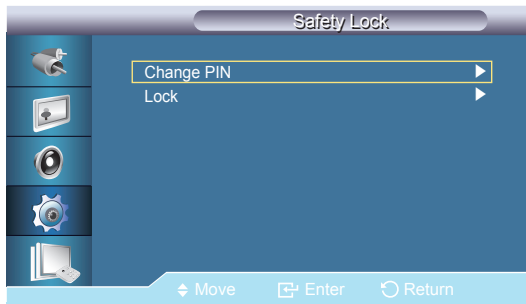

– The displayed image may differ depending on the model.

## Change PIN

The password can be changed.

The preset password for the LCD Display is "0000".

— If you forgot your password, press the remote buttons **INFO** → **EXIT** → **MUTE** to reset the password to "0000".

## Lock

This is the function that locks the OSD in order to keep the current settings or to prevent others from adjusting the settings.

## Energy Saving



– The displayed image may differ depending on the model.

This feature adjusts the power consumption of the unit in order to save energy.

- **Off / On**

## Video Wall

### Video Wall

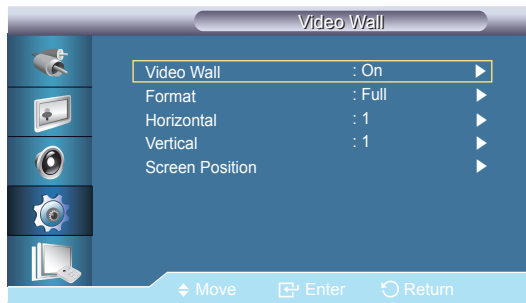

– The displayed image may differ depending on the model.

A **Video Wall** is a set of video screens connected together, so that each screen shows a part of the whole picture or where the same picture is repeated on each screen.

When the **Video Wall** is on, you can adjust the **Video Wall** screen setting.

- When **Video Wall** is running, the **Size** functions are not available.
- Disabled when **PIP** is set to **On**.

Turns Off/On the **Video Wall** function of the selected display Off/On.

- **Off / On**

## Format

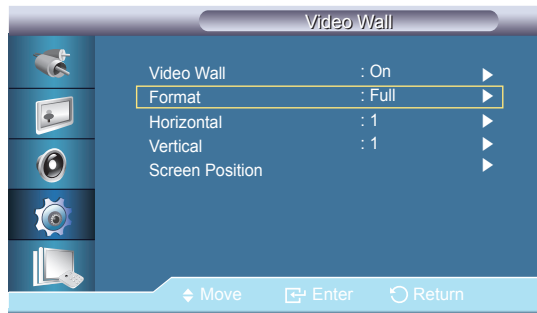

– The displayed image may differ depending on the model.

The **Format** can be selected to see a divided screen.

- **Full**  
Provides a full screen without any margins.
- **Natural**  
Displays a natural image with the original aspect ratio intact.

## Horizontal

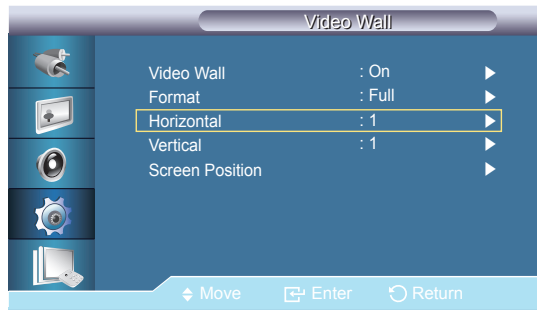

– The displayed image may differ depending on the model.

Sets how many parts the screen should be divided horizontally.

Fifteen adjustment levels: 1~15.

— If **Vertical** is set to **15**, the maximum value for **Horizontal** is **6**.

## Vertical

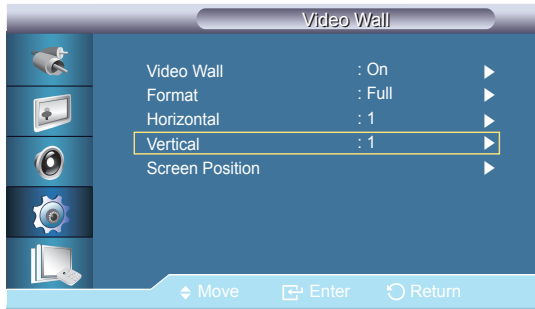

– The displayed image may differ depending on the model.

Sets how many parts the screen should be divided vertically.

Fifteen adjustment levels: 1~15.

— If **Horizontal** is set to **15**, the maximum value for **Vertical** is **6**.

## Screen Position



– The displayed image may differ depending on the model.

The screen can be divided into several images. A number of screens can be selected with a different layout when dividing.

- Select a mode in **Screen Position**.
- Select a display in Display Selection.
- The selection will be set up by pressing a number in the selected mode.
- The screen can be split into a maximum of 100 sub-screens.

— When more than four displays are connected, we recommend a resolution of XGA (1024\*768) or greater to prevent any picture degradation.

# Safety Screen

## Pixel Shift

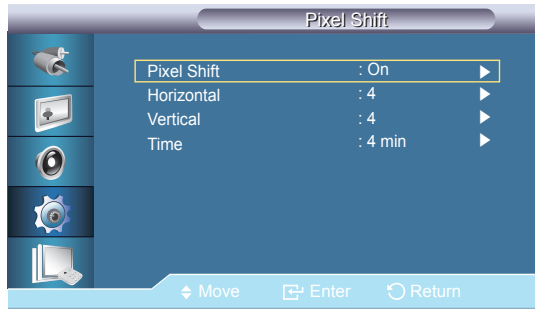

– The displayed image may differ depending on the model.

### Pixel Shift

To prevent after-images on the screen, you can use this function to have pixels move on the LCD in the horizontal or vertical direction.

- **Off / On**

### Horizontal

Sets how many pixels the screen moves horizontally.

Five adjustment levels: 0, 1, 2, 3, and 4.

### Vertical

Sets how many pixels the screen moves vertically.

Five adjustment levels: 0, 1, 2, 3, and 4.

### Time

Set the time interval for performing the horizontal or vertical movement, respectively.

## Timer

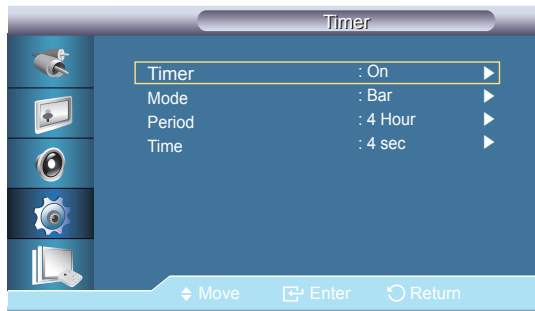

– The displayed image may differ depending on the model.

### Timer

You can set the timer for Screen Burn Protection. If you start the operation to erase any residual image, the operation will be performed for the set period of time and then automatically finish.

- **Off / On**

### Mode

You can change the **Safety Screen** Type.

- **Bar / Eraser / Pixel**

### Period

Use this function to set the execution period for each mode set in the **Timer**.

### Time

Within the set Period of time specify a time for execution.

This function prevents after-images on the screen by moving long black and white vertical lines.

## Bar



– The displayed image may differ depending on the model.



---

## Eraser

This function prevents after-images on the screen by moving a rectangular pattern.



---

- The displayed image may differ depending on the model.

## Pixel

This function prevents after-images by moving many pixels on the screen.

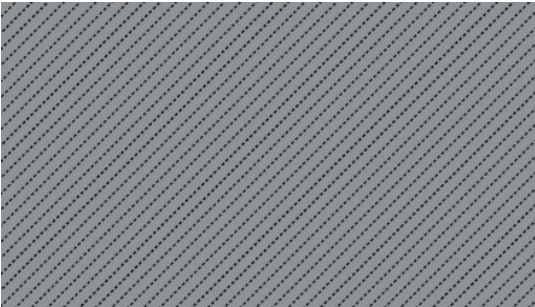

---

- The displayed image may differ depending on the model.

## Side Gray

Select the brightness of the grey for the screen background.

- **Off / Light / Dark**



– The displayed image may differ depending on the model.

## Resolution Select

When the picture is not displayed properly on the screen when setting the graphics card resolution of the computer to **1024 x 768 @ 60Hz**, **1280 x 768 @ 60Hz**, **1360 x 768 @ 60Hz** or **1366 x 768 @ 60Hz**, by using this function(Resolution Select), you can have the picture displayed on the screen in the specified resolution.

— Selecting the menu is only allowed when the graphics resolution is set to **1024 x 768 @ 60Hz**, **1280 x 768 @ 60Hz**, **1360 x 768 @ 60Hz** or **1366 x 768 @ 60Hz**.

- **Off / 1024 X 768 / 1280 X 768 / 1360 X 768 / 1366 X 768**



– The displayed image may differ depending on the model.

– Available in **PC** mode only.

## Power On Adjustment

Adjusts the Power On time for the screen.

— Set the Power On time to be longer to avoid overvoltage.

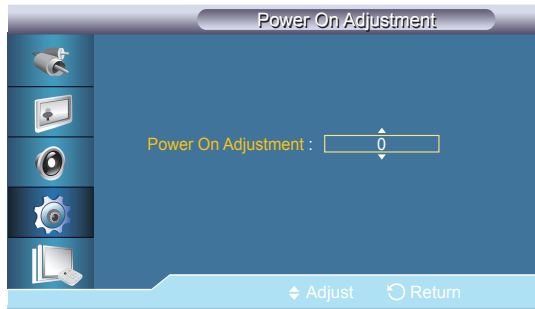

— The displayed image may differ depending on the model.

## OSD Rotation

OSD Rotate

- **Landscape / Portrait**

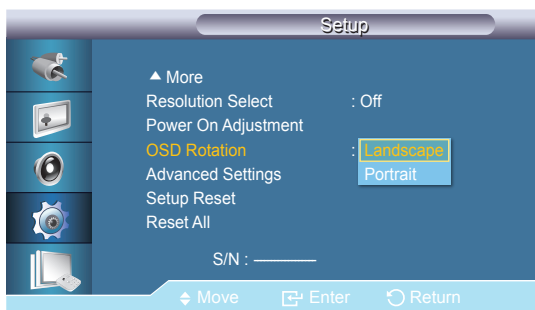

— The displayed image may differ depending on the model.

## Advanced Settings

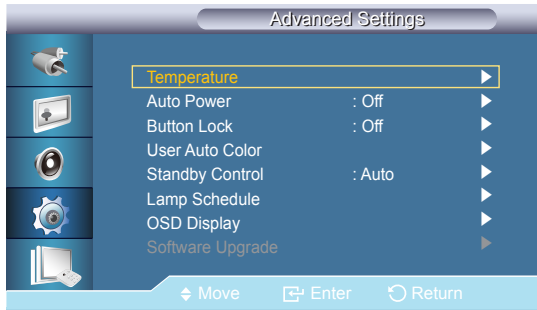

- The displayed image may differ depending on the model.

## Auto Power

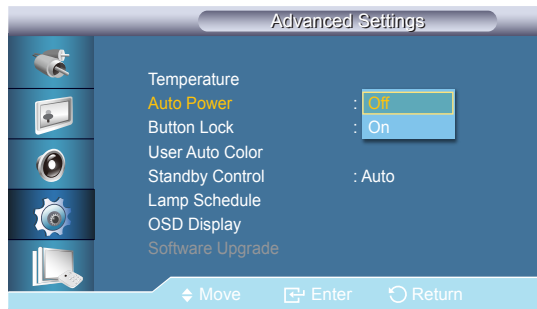

- The displayed image may differ depending on the model.

## Temperature

Configures the setting for the Temperature function, which detects the internal temperature for the product's protection.

### Temperature Control

Detects the product's internal temperature and specifies the desired temperature.

The product is set to 77°C by default.

- The picture will be dimmed if the temperature exceeds the specified temperature, and the product will automatically power off to prevent overheating if the temperature keeps rising.
- It is best to use the product at temperatures 75 - 80°C (based on ambient temperature of 40°C). Refer to "Specifications" herein for details about operating conditions.

### Current Temperature

Shows the current temperature of the product.

Enables or disables **Auto Power** for the product.

- **Off / On**
- When **Auto Power** is **On**, the product will power on automatically as soon as it is connected to power.

## Button Lock

Locks or unlocks the monitor control buttons on the product.

- **Off / On**

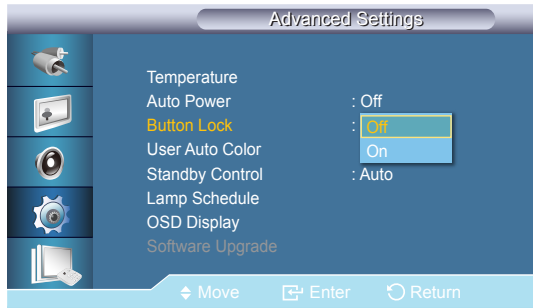

– The displayed image may differ depending on the model.

## User Auto Color

- **Auto Color**  
Automatically adjusts the colors.
- **Reset**  
Resets the color settings.

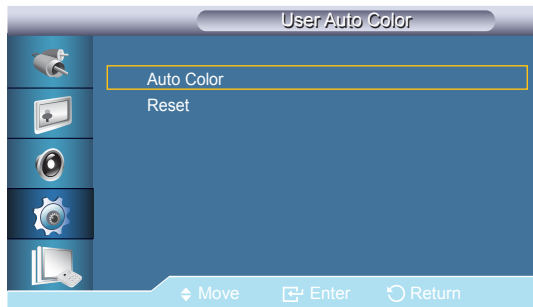

– The displayed image may differ depending on the model.

— Enabled only in **PC** mode.

## Standby Control

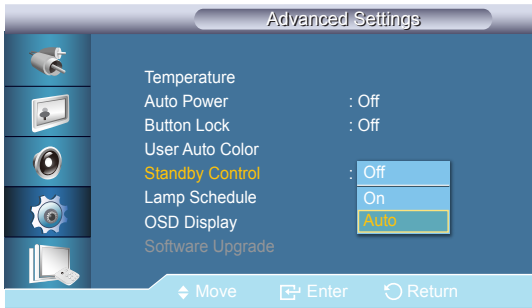

– The displayed image may differ depending on the model.

Sets the standby mode, which will be activated when no input signal is detected.

- **Off**  
A message will read **No Signal** if no input signal is detected.
  - **On**  
Power-saving mode will be activated if no input signal is detected.
  - **Auto**  
When no input signal is detected,
    - Power-saving mode will be activated if an external device is connected.
    - A message will read **No Signal** if no external device is connected.
- Enabled only in **PC, DVI** mode.
- **Auto** will be disabled in **HDMI** mode.

## Lamp Schedule



– The displayed image may differ depending on the model.

Adjusts the luminance to a user-specified value at a specified time.

## OSD Display

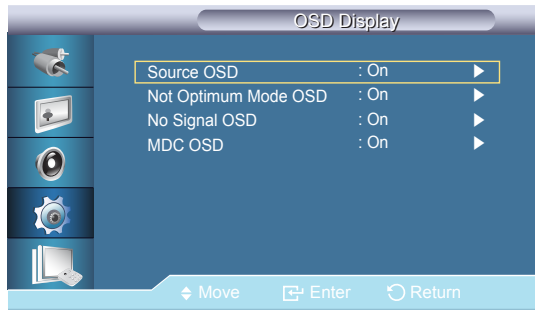

– The displayed image may differ depending on the model.

Displays or hides a menu item on the screen.

### Source OSD

- Off / On

### Not Optimum Mode OSD

- Off / On

### No Signal OSD

- Off / On

### MDC OSD

- Off / On

## Software Upgrade

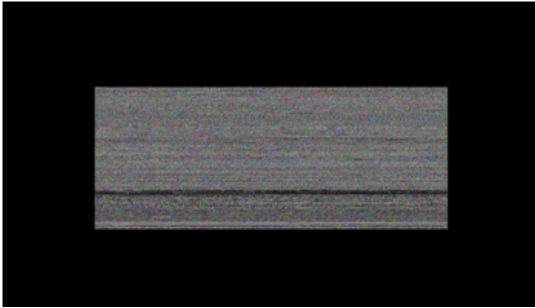

- When there are two or more BMP images, they are displayed on the screen using a slideshow.
- It is recommended that the playback interval between two BMP images in the slideshow should be one second. The image extraction probability will decrease with other playback intervals.
- A BMP image might not be extracted if it is covered by another image (for example, the mouse pointer).

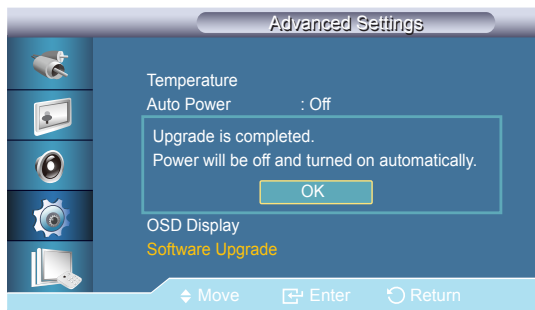

- The displayed image may differ depending on the model.

Performs a software upgrade.

- 1 Connect the product to a computer via a digital signal such as DVI or HDMI. Click the BMP image file converted from an SW code. The image below will appear on the screen of the product.
  - 2 While a BMP image onto which the software code has been converted is displayed on the screen, select **Software Upgrade**.
  - 3 If a more recent version than the current software version is detected, you will be asked whether to upgrade the current software. If you select **Yes**, the upgrade is performed.
  - 4 When the software upgrade is completed, the product is turned off and on automatically.
- This only operates with a digital signal, such as in **DVI, HDMI1, or HDMI2** mode. (The input resolution must be identical to the panel resolution.)
  - In **HDMI1** and **HDMI2** modes, the timing values used for both the PC and TV are only supported if the **Edit Name** is set to **PC** or **DVI PC**.
  - This is only supported if the **Size** is set to **16:9**.



---

## Setup Reset

Reset all the values for a setting.

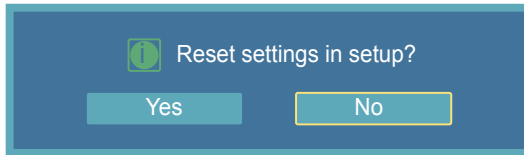

---

- The displayed image may differ depending on the model.

## Reset All

Reset all the settings for the display.

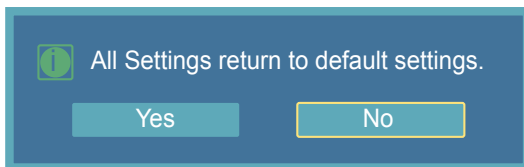

---

- The displayed image may differ depending on the model.

# Chapter 09

## Using MDC

MDC (Multiple Display Control) is an application that allows you to easily control multiple display devices simultaneously using a PC.

### Multi Control

MENU  → **Multi Control** → ENTER 

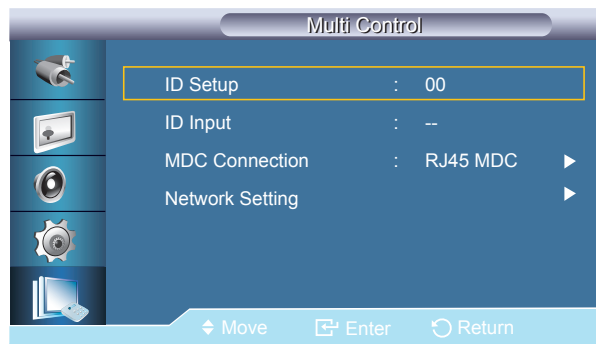

– The displayed image may differ depending on the model.

- **ID Setup**  
Assigns distinctive IDs to the SET.
- **ID Input**  
Use to select the transmitter functions of the individual SET. Only a SET where the ID corresponds to the transmitter setting becomes activated.
- **MDC Connection**  
Selects a port to receive the MDC inputs from.
  - **RS232C MDC**: Communicates with the MDC via a **RS232C MDC** cable.
  - **RJ45 MDC**: Communicates with the MDC via an **RJ45 MDC** cable.
- **Network Setting**  
**IP Setting** : **Manual, Auto**  
**IP Address** : Manually enter the **IP Address** if **IP Setting** is set to **Manual**.  
**Subnet Mask** : Manually enter the **Subnet Mask** if **IP Setting** is set to **Manual**.  
**Gateway** : Manually enter the **Gateway** if **IP Setting** is set to **Manual**.

---

# MDC Program Installation/Uninstallation

## Installation

- 1 Insert the installation CD into the CD-ROM drive.
- 2 Click the **MDC Unified** installation program.
- 3 Select a language for installation. Next, click "**OK**".
- 4 When the "**Welcome to the InstallShield Wizard for MDC\_Unified**" screen appears, click "**Next**".
- 5 In the "**License Agreement**" window displayed, select "**I accept the terms in the license agreement**" and click "**Next**".
- 6 In the displayed "**Customer Information**" window, fill out all the information fields and click "**Next**".
- 7 In the displayed "**Destination Folder**" window, select the directory path you want to install the program in and click "**Next**".
- 8 In the displayed "**Ready to Install the Program**" window, check the directory path to install the program in and click "**Install**".
- 9 Installation progress will be displayed.
- 10 Click "**Finish**" in the displayed "**InstallShield Wizard Complete**" window.
- 11 The **MDC Unified** shortcut icon will be created on the desktop after installation.

## Uninstallation

- 1 Select **Settings > Control Panel** on the **Start** menu and double-click **Add/Delete Program**.
- 2 Select **MDC Unified** from the list and click **Change/Remove**.

---

MDC installation can be affected by the graphics card, mother board and network conditions.

---

If a software installation window is not displayed on the main screen, install with the **MDC Unified** execution file in the **MDC** folder on the CD.

---

If the directory path is not specified, the program will be installed in the default directory path.

---

Select "**Launch MDC Unified**" and click "**Finish**" to run the MDC program immediately.

- 
- The MDC execution icon may not be displayed depending on the PC system or product specifications.
  - Press F5 if the execution icon is not displayed.

# What is MDC?

Multiple display control "MDC" is an application that allows you to easily control multiple display devices simultaneously using a PC.

## Connecting to MDC

### Using MDC via RS-232C (serial data communications standards)

An RS-232C serial cable must be connected to the serial ports on the PC and monitor.

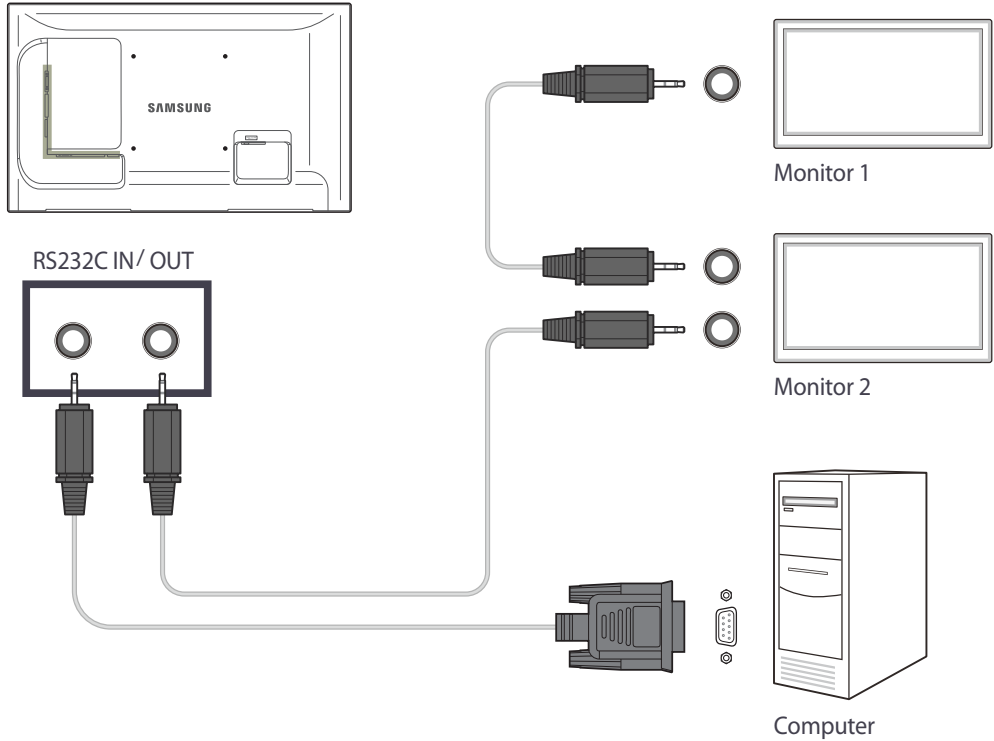

## Using MDC via Ethernet

Enter the IP for the primary display device and connect the device to the PC. One display device can connect to another using an RS-232C serial cable.

### Connection using a direct LAN cable

Multiple products can be connected using the **RJ45 MDC** port on the product and the LAN ports on the HUB.

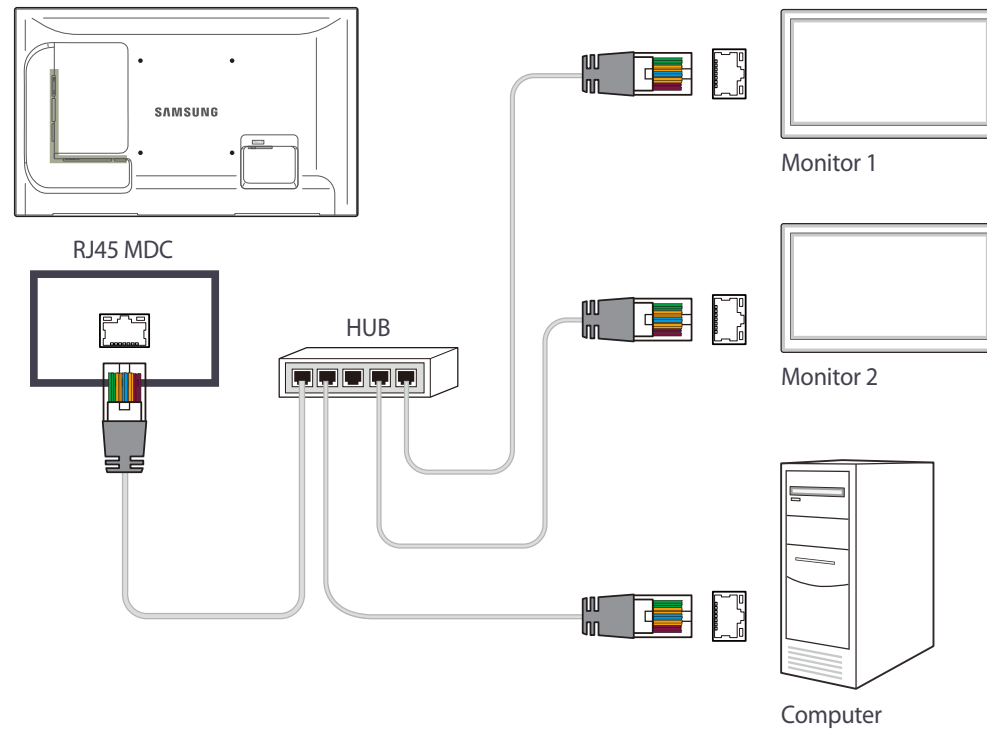

### Connection using a cross LAN cable

Multiple products can be connected using the RS232C IN / OUT port on the product.

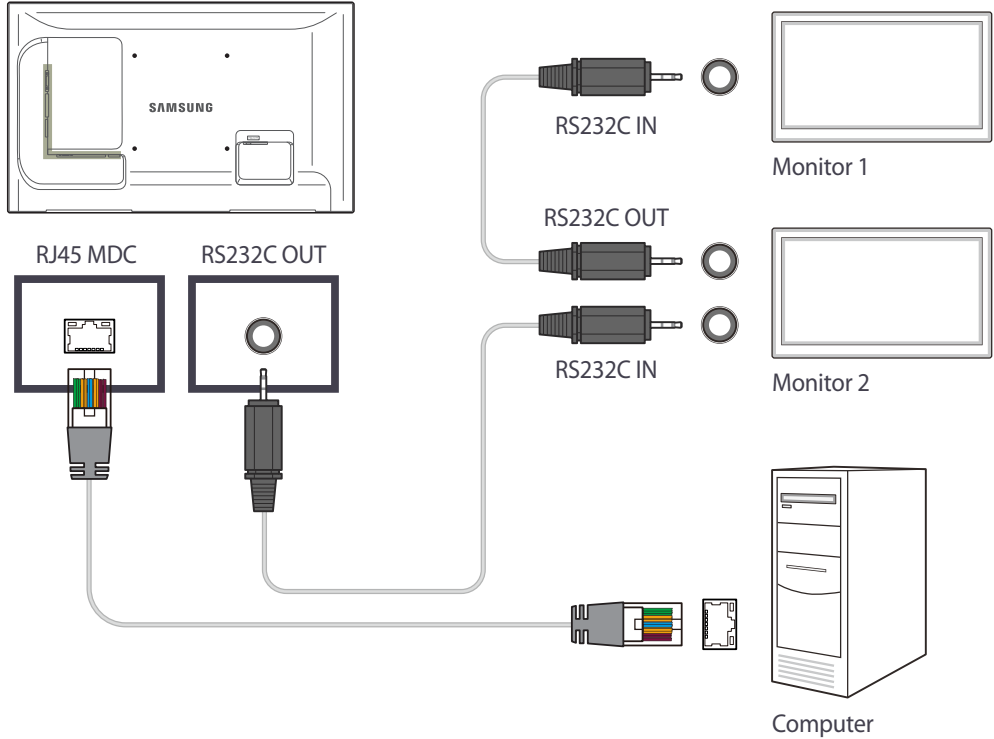

# Connection Management

Connection management includes the **Connection list** and **Connection list** modification options.

**Connection list** - Connection list shows the details of the connections such as connection setting (IP/COM, Port No, MAC, and Connection Type), connection status, **Set ID Range**, and detected devices.

Each connection can contain a maximum of 100 devices connected in serial daisy-chain fashion. All the LFDs detected in a connection are displayed in the Device list, where the user can make groups and send commands to detected devices.

**Connection list modification options** - Connection modification options includes **Add**, **Edit**, **Delete**, and **Refresh**.

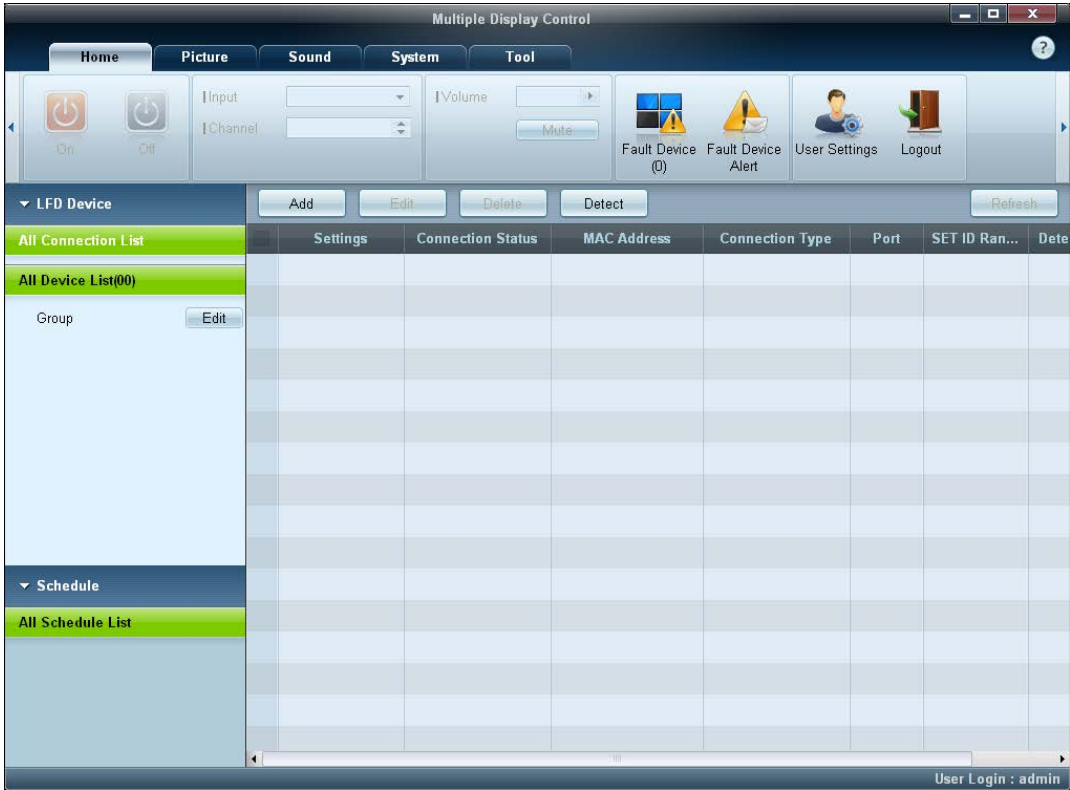

## User Login

Launching the program displays the user login window.

The initial login ID (**Username: admin**) and password (**password: admin**) are set to **admin**.

— After logging in for the first time, make sure to change the password to ensure security.

— To change the password, go to **Home > User Settings**.

After you are logged in, [**User Login : admin**] appears at the right bottom of the program.

To log in automatically when the program restarts, select the **Auto Login** checkbox in the **User Login** window.

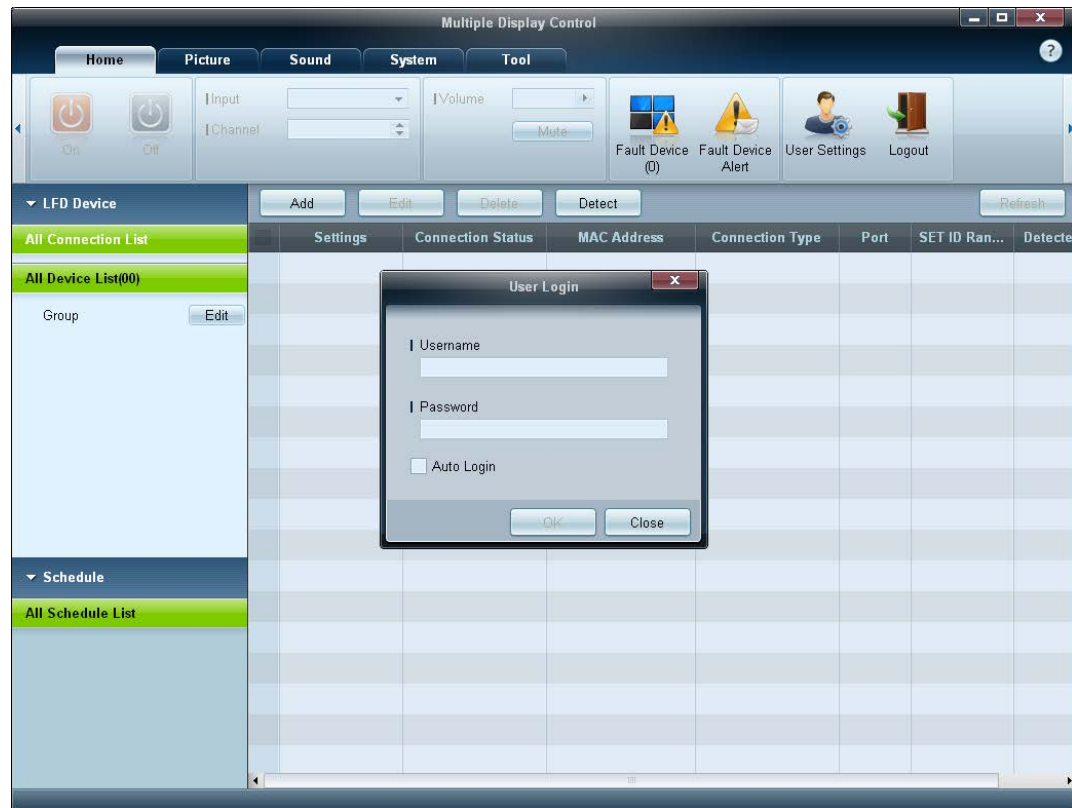



# Auto Set ID

**Auto Set ID** feature assigns a Set ID for all the LFDs connected in daisy-chain of a selected connection.

There can be a maximum of 100 LFDs in a connection.

The Set ID is assigned sequentially in the daisychain running from 1 to 99, and then finally to Set ID 0.

— ID for the last 100th LFD is set to 0.

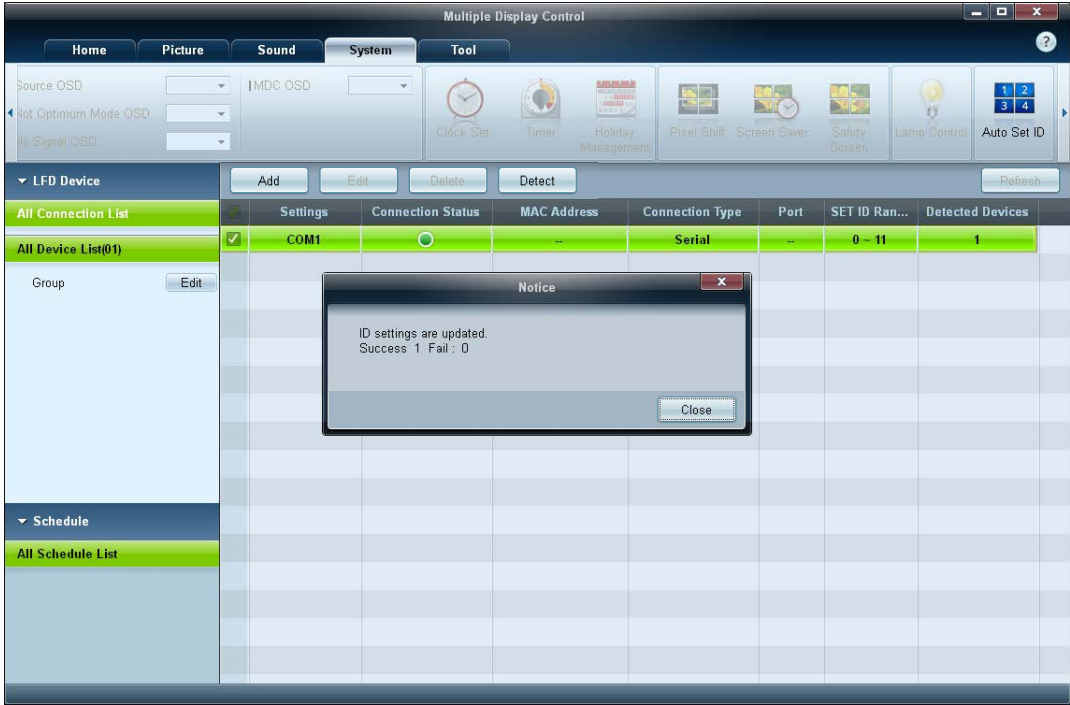

# Cloning

Using the **Cloning** feature, you can copy the setting of one LFD and apply it to multiple selected LFDs. You can select specific tab categories or all tab categories for cloning, using the copy setting option window.

- To delete the settings you have configured, click the **Paste Settings** button.

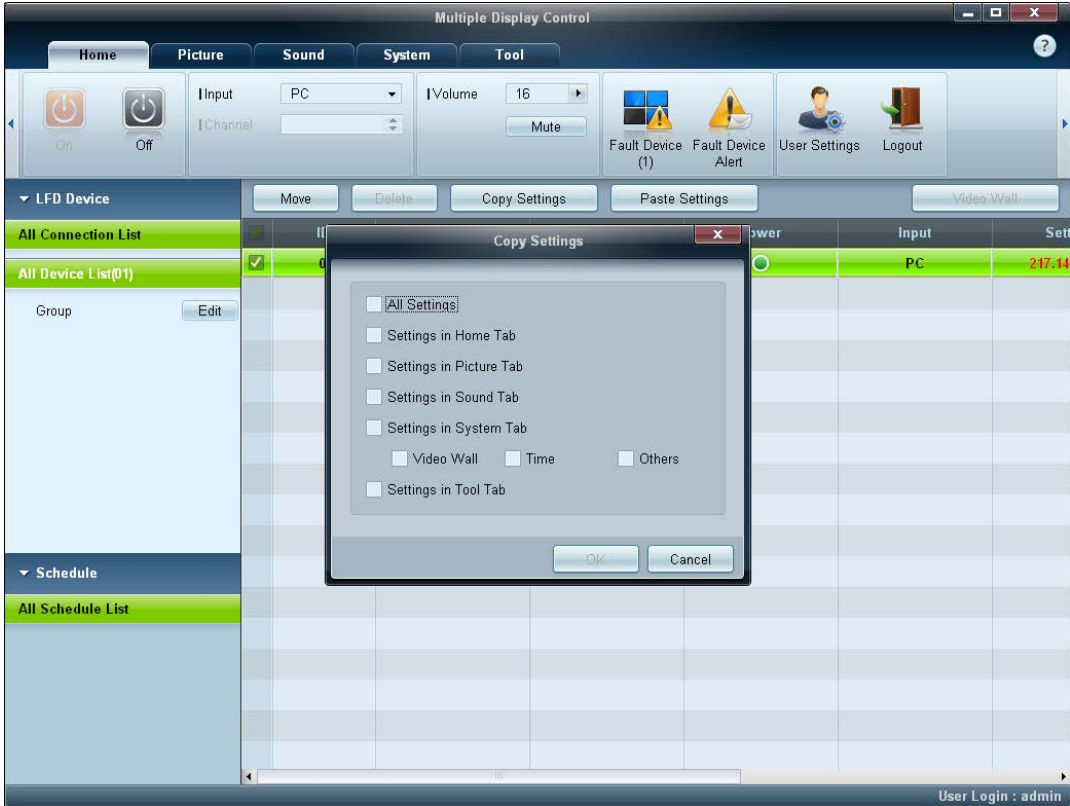

# Command Retry

This feature is used to specify the maximum number of times the MDC command will be retried in case of there being no reply or a corrupted reply from an LFD. The retry count value can be set using the MDC options window. The retry count value must be between 1-10. The default value is 1.

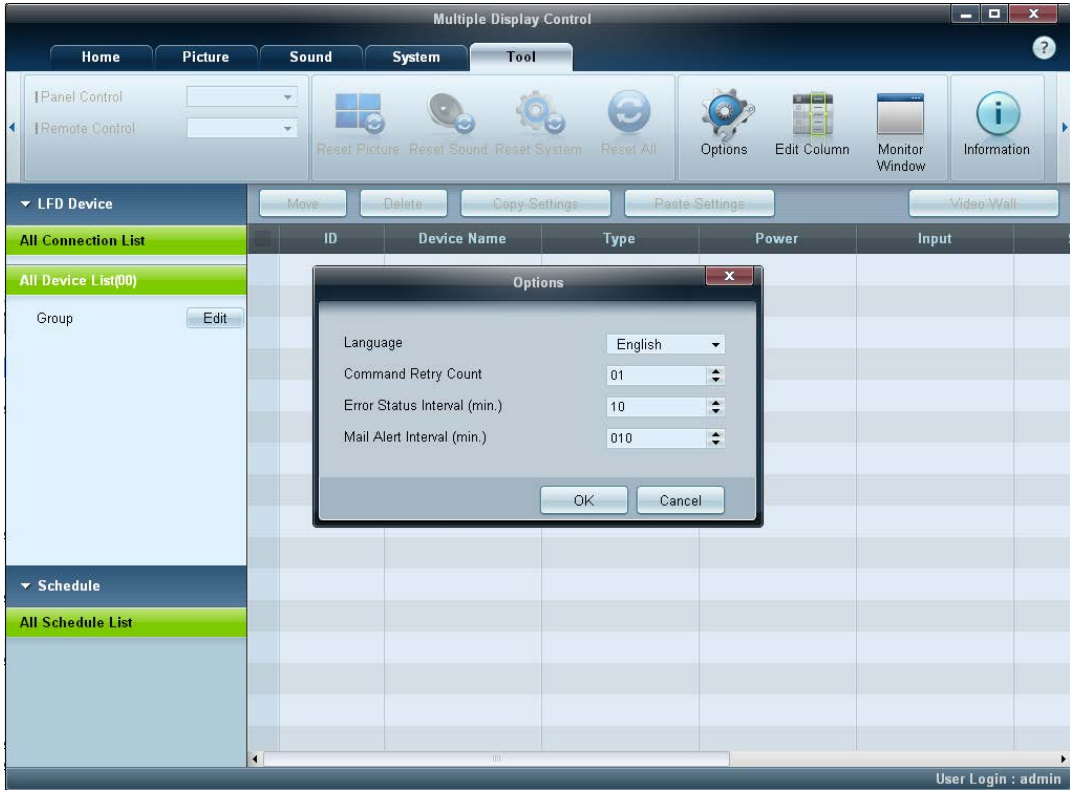

## Getting Started with MDC

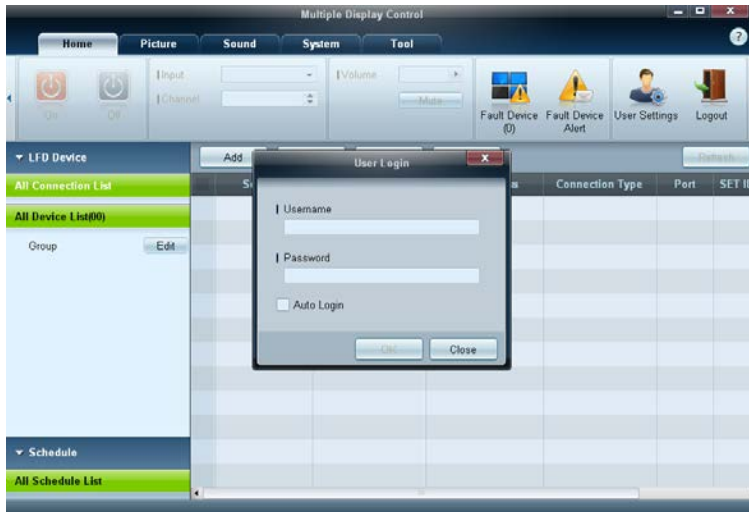

1 To start the program, click **Start** → **Programs** → **Samsung** → **MDC Unified**.

The login window appears after the MDC program is launched.

Enter the user ID and password.

- The default user ID and password are **admin**.
- Make sure to change the password after the first login.

2 Click **Add** to add a display device.

**SET ID Range:** Select a range of the unique ID assigned to a monitor.

- If the connection is established via RS232C, go to **Serial** and specify the **COM Port**.
- If the connection is established via **Ethernet**, enter the IP that was entered for the display device.



## Main Screen Layout

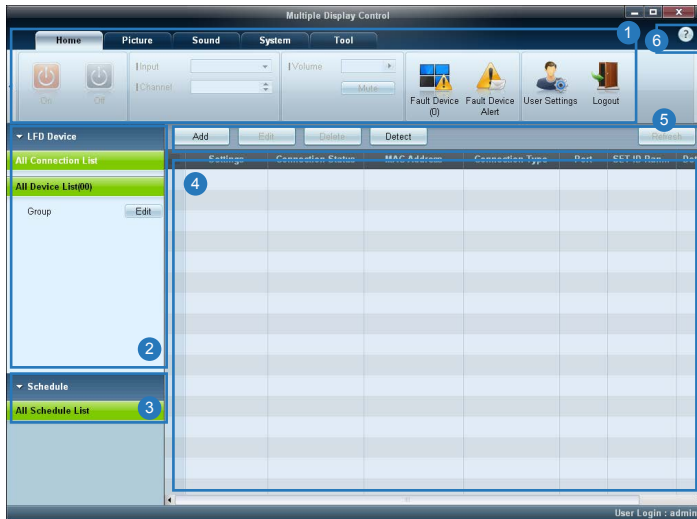

- |                       |   |
|-----------------------|---|
| 1 Menu Bar            | Change the status of a display device or the properties of the program. |
| 2 Device Category     | View a list of connected display devices or device groups.              |
| 3 Schedule Category   | View a list of schedules for display devices.                           |
| 4 Set List            | Select the display device you want to adjust.                           |
| 5 Modify the Set List | Add, edit, regroup or delete sets.                                      |
| 6 Help Topics         | Display help topics for the program.                                    |

## Menus

### Home



You can power on or off a selected device or change the input source or volume of the device.

Choose display devices from the list of sets, and select the **Home** tab.

Select an item and change the corresponding setting.

Power

- **On**: Power on a selected display.
- **Off**: Power off a selected display.

Input

- Input Source : Change the input source.
  - Input sources available can vary depending on the Display Device Models.
  - The input source can be changed only for displays that are turned on.
- **Channel**: Change the channel.
  - The TV channel can be changed by using the up/down arrow keys.
  - The channel can be changed only when the input source is **TV**.
  - Only registered channels can be selected.
  - Only applicable to models that support TVs.

## Volume



— The volume can be changed or the sound can be muted only for displays that are turned on.

### Volume

- Adjust the volume of a selected display.
- The volume can be adjusted using the slider bar in the range of 0 to 100.

### Mute

- Enable or disable **Mute** for a selected display.  
**Mute** will automatically be disabled if **Volume** is adjusted when **Mute** is on.

## Alert



### Fault Device

- This menu shows a list of display devices which have following errors - fan error, temperature error, brightness sensor error, or lamp error.
- Select a display device from the list. The **Repair** button will be enabled.
- Click the **Refresh** button to refresh the error status of the display device. The recovered display device will disappear from the **Fault Device List**.

### Fault Device Alert

- Display device in which error is detected will be reported by email.
- Fill in all required fields. The **Test** and **OK** buttons will be enabled.  
Ensure the **Sender** information and at least one **Recipient** are entered.

## User Login



### User Settings

- Add, delete or edit login information.

### Logout

- Log out from the current user account as follows.
- Click **Logout**. The message "**Do you want to log admin out?**" is displayed
- Click **Yes**. The user login window appears.
- If you do not want to log in, click **Close**. The program is closed.

— If you close the program using **Logout**, the login window will appear prompting you to enter user information even if the **Auto Login** checkbox is selected.

## Screen Adjustment

### Custom

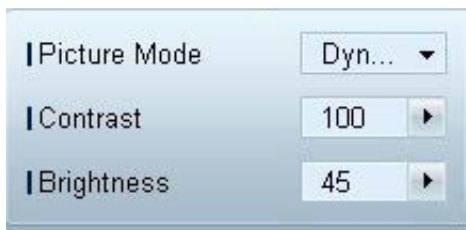

The screen settings (contrast, brightness, etc.) can be adjusted.

Choose display devices from the list of sets, and select the **Picture** tab.

Select an item and change the corresponding screen setting.

### Picture Mode

- Adjust the picture mode for the selected display device.

### Contrast

- Adjust the contrast for the selected display device.

### Brightness

- Adjust the brightness for the selected display device.

## Color

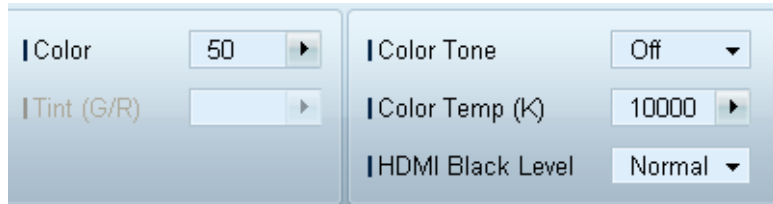

- **Color** and **Tint (G/R)** are not available if the input source is **PC**.
- **Color**, **Tint (G/R)**, **Color Tone** and **Color Temp.** are not available if both **PC Source** and **Video Source** are selected.

## Options

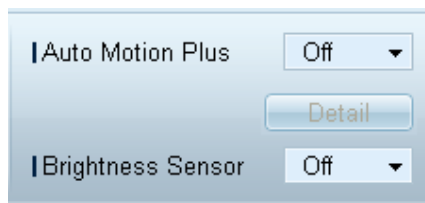

### Color

- Adjust the colors for the selected display device.

### Tint (G/R)

- Adjust the tint for the selected display device.

### Color Tone

- Adjust the background color tone for the selected display device.

### Color Temp.

- Adjust the color temperature for the selected display device.

— This option is enabled if **Color Tone** is set to **Off**.

### HDMI Black Level

- Adjust the **HDMI Black Level** for the selected display device.

### Auto Motion Plus

This option is used to view dynamic images.

- **Off**: Disable the **Auto Motion Plus** function.
- **Clear**: Set the level of **Auto Motion Plus** to clear. This mode is suitable to display vivid images.
- **Standard**: Set the level of **Auto Motion Plus** to standard.
- **Smooth**: Set the level of **Auto Motion Plus** to smooth. This mode is suitable to display smooth images.
- **Custom**: Customize the level of screen burn-in or flickering.
- **Demo**: This function demonstrates the technology of **Auto Motion Plus**. The result when the mode is changed can be previewed on the left side of the window.
  - **Auto Motion Plus** may not be available depending on the product.
- **Detail**: View detailed information about the selected display device.

### Brightness Sensor

- Enable or disable the **Brightness Sensor** for the selected display device.
- The **Brightness Sensor** detects the ambient light intensity and automatically adjusts the screen brightness.
  - **Brightness Sensor** may not be available depending on the product.



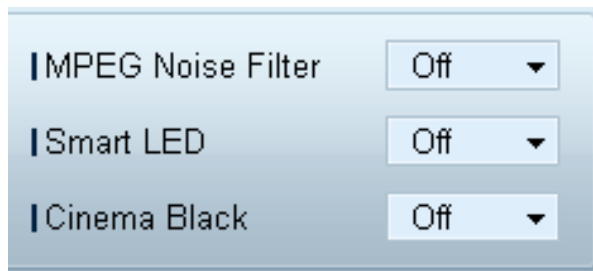

#### MPEG Noise Filter

Reduces MPEG noise to provide improved picture quality.

- **Off / Low / Medium / High / Auto**

#### Smart LED

Controls the LED backlight to maximize picture clarity.

#### Cinema Black

In Movie mode, this feature dims the top and bottom areas of the video image to provide a more immersive viewing experience.

- **Off:** Turns off the **Cinema Black** feature.
- **On:** Adjusts the dimming of the top and bottom areas of the screen according to the video.

## Size



#### Picture Size

- Adjust the screen size for the selected display device.
- The **Detail** item will be disabled if **Picture Size** is set to a mode that does not support detailed configuration.
- The -/+ buttons can be used to adjust **Zoom**.
- The screen can be relocated using the up/down/left/right buttons.

#### Detail

- You can view details of the selected screen size.

#### PC Screen Adjustment

- Frequency adjustment or fine-tuning is available by using the -/+ buttons in **Coarse** or **Fine**.
- To relocate the screen, click one of the four images below **Position**.
- To automatically adjust the frequency, fine-tune or relocate the screen, click **Auto Adjustment**.

## Advanced features



### 3D Control

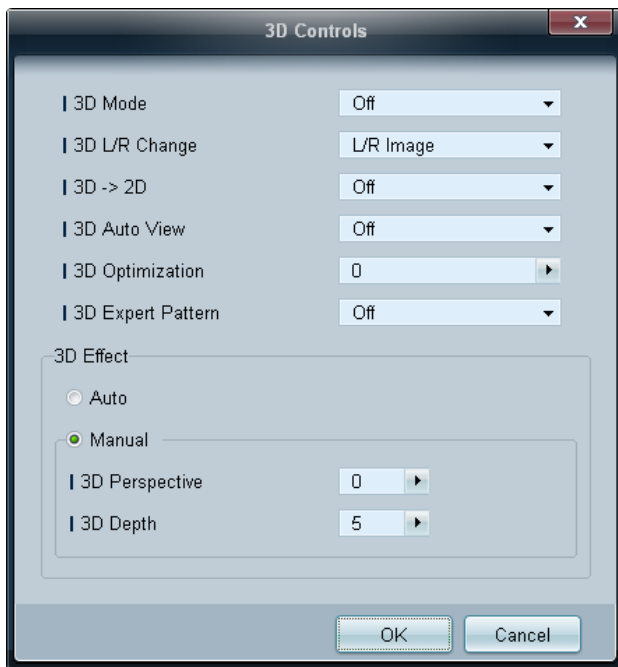

### 3D Mode

Select the 3D input format.

### 3D L/R Change

Swap the left and right pictures.

### 3D → 2D

Displays the image for the left eye only.

### 3D Auto View

If you set **3D Auto View** to **Message Notice**, a pop up message window appears when the product receives a 3D signal.

### 3D Optimization

The overall adjustment of 3D effect.

### 3D Expert Pattern

View a 3D pattern.

### 3D Effect

Adjust 3D effects like perspective and depth for your preferred 3D viewing experience.

- **Auto**: Automatically adjust the perspective and depth settings in accordance with the 3D input source.
- **Manual**: Manually adjust the perspective and depth settings.

## Advanced Settings

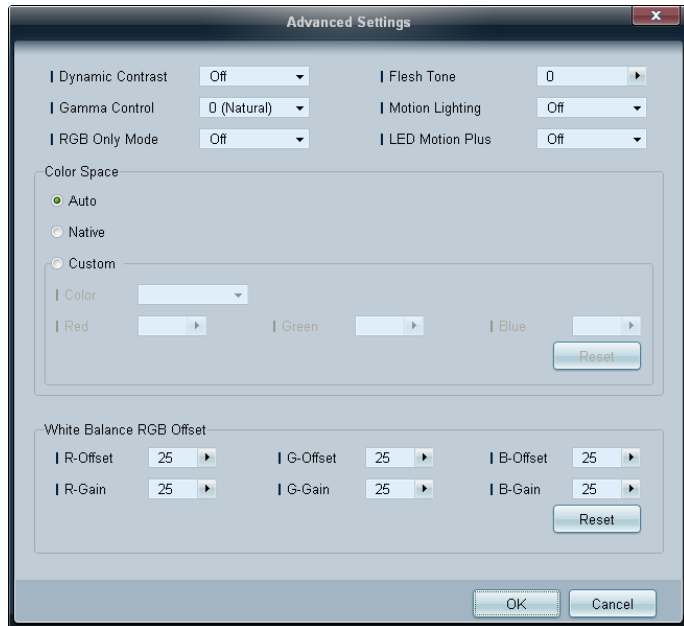

### Dynamic Contrast

Adjust the screen contrast.

### Gamma Control

Adjust the primary color intensity.

### RGB Only Mode

Displays the **Red**, **Green** and **Blue** color for making fine adjustments to the hue and saturation.

### Flesh Tone

Emphasize pink "Flesh Tone."

### Motion Lighting

Reduces power consumption by reducing screen brightness when the picture on the screen is in motion.

### LED Motion Plus

Removes blur and judder from scenes with larger amounts of rapid movement to provide a clearer picture.

### Color Space

Adjusts the range and variety of color (the color space) available to create images.

- **Auto / Native / Custom**
  - To adjust **Color**, **Red**, **Green**, **Blue** and **Reset**, set **Color Space** to **Custom**.

### White Balance

Adjust the colour temperature for a more natural picture.

- **R-Offset / G-Offset / B-Offset**  
Adjust each color (red, green, blue) darkness.
- **R-Gain / G-Gain / B-Gain**  
Adjust each color (red, green, blue) brightness.
- **Reset**  
Resets the **White Balance** to it's default settings.

## Sound Adjustment



— The **Bass** or **Treble** item will be disabled if the item is not supported by the selected set.

You can change the sound settings.

Choose display devices from the list of sets, and select the **Sound** tab.

### Bass

- Adjust the bass for the selected display.

### Treble

- Adjust the treble for the selected display.

### Balance(L/R)

- Adjust the volume of the left and right speakers of the selected display device.

### SRS TS XT

- Enable or disable the **SRS TS XT** effect for the selected display device.

## System Setup

### Video Wall



Choose display devices from the list of sets, and select the **System** tab.

The **Video Wall** function can be used to display part of a whole picture or repeat the same picture on each of connected multiple display devices.

— **Video Wall** is enabled only when devices are in the group.

### Video Wall

- Enable or disable **Video Wall**.

## Format

- Select the format to display the split screen.

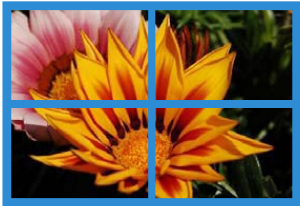
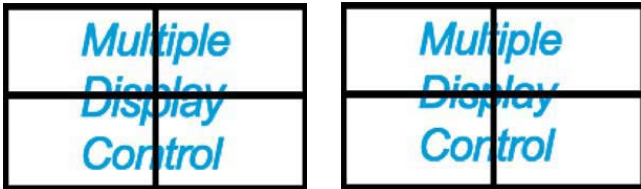

Full

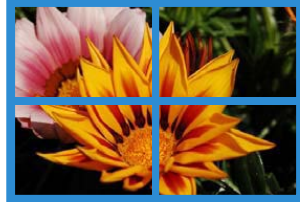

Natural

## PIP



- Basic information required to adjust PIP will appear in the menu screen.
- PIP will be disabled when **Video Wall** is **On**.
- Note that **Picture Size** is disabled when PIP is **On**.

## H

- Select the number of horizontal display devices.
- A maximum of 15 displays can be arranged in a row.
  - A maximum of 6 can be assigned to **V** if 15 is assigned to **H**.

## V

- Select the number of vertical display devices.
- A maximum of 15 displays can be arranged in a row.
  - A maximum of 6 can be assigned to **H** if 15 is assigned to **V**.

## Screen Position

- View the layout of displays (configured by the screen divider) or change the layout as required.
- **Screen Position** and **Preview** are enabled when **Video Wall** is set to on.
- Note that if multiple sets are selected, **Preview** is enabled only if the settings for **H** and **V** match the layout of the selected sets.
- To change the **Position**, select a set and drag it to a new position.
  - The range of screen divider settings may differ depending on the model.

## PIP Size

- View the **PIP Size** of the current display.

## PIP Source

- Select a PIP input source.

## Sound Select

- Select and enable the sound from either the primary screen or secondary screen.

## Channel

- The channel can be changed if **PIP Source** is **TV**.

## General



### User Auto Color

- Automatically adjust the screen colors.  
— Available only in **PC** mode.

### Auto Power

- Set the product to automatically power on.

### Standby Control

- Set the standby mode to activate if an input source is not detected.

## Fan & Temperature

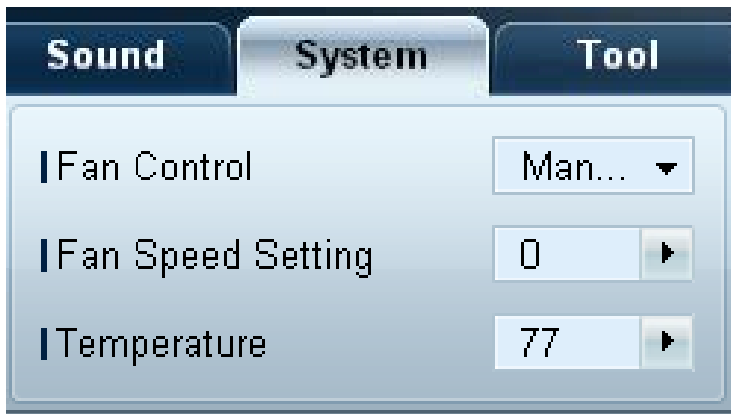

Configure the settings required to detect the fan speed and internal temperature for the product's protection.

### Fan Control

- Select a method to configure the fan speed.

### Fan Speed Setting

- Configure the fan speed.

### Temperature

- Detect the internal temperature by specifying the range of temperature.

## Security

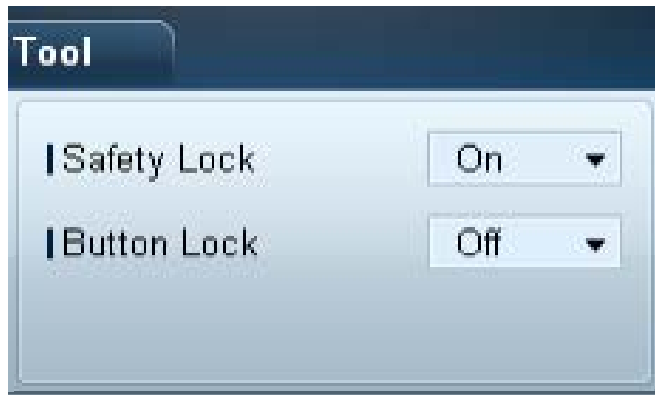

### Safety Lock

- Lock the on-screen menus.
  - To unlock the menus, set **Safety Lock** to **Off**.

### Button Lock

- Lock the buttons on the display device.
  - To unlock the buttons, set **Button Lock** to **Off**.

## OSD Display



### Source OSD

- Select whether to display a message when the **Source** is changed.

### Not Optimum Mode OSD

- Select whether to display a message when a non-compatible mode is selected.

### No Signal OSD

- Select whether to display a message when there is no input signal.

### MDC OSD

- Select whether to display a message when settings are changed by the MDC.

## Time



## Clock Set



Change the current time on the selected display device according to the time set on a PC. If the time is not set on the display device, null values will be displayed.

## Timer



## On Timer

- **Repeat:** Specify the period for which you want to repeat the selected **Timer**.  
**Once, EveryDay, Mon~Fri, Mon~Sat, Sat~Sun, Manual**
- **Holiday Apply:** The **Holiday Management** settings can be applied to the **Timer**.
- **On Time:** Set the time to power on the selected display device.
- **Volume:** Specify the volume of the display device when it is powered on by **On Time**.
- **Source:** Specify the input source of the display device when it is powered on by **On Time**.

## Off Timer

- **Repeat:** Specify the period for which you want to repeat the selected **Timer**.  
**Once, EveryDay, Mon~Fri, Mon~Sat, Sat~Sun, Manual**
  - **Holiday Apply:** The **Holiday Management** settings can be applied to the **Timer**.
  - **Off Time:** Set the time to power off the selected display device.
- The checkboxes to select days of the week below **Repeat** are enabled only if **Manual** is selected.



## Holiday Management

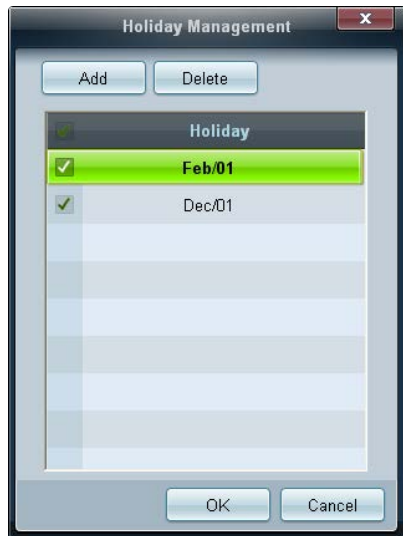

**Holiday Management** allows you to prevent devices that are set to be powered on by the **Timer** from turning on at a specified date.

The **Holiday Management** function can be enabled or disabled in the **Timer** settings menu.

- **Add:** You can specify holidays.  
Click the **Add** button in the **Holiday Management** window.



- **Delete:** Delete holidays. Check the corresponding checkboxes and click this button.
- **List of holidays:** View a list of holidays you have added.

## Screen Burn Protection

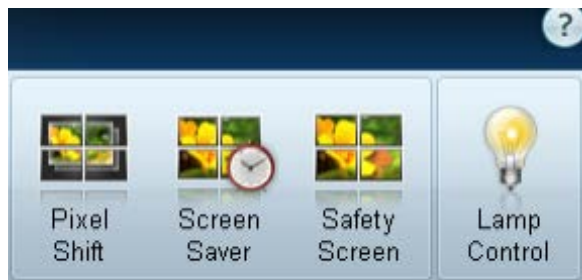

## Pixel Shift

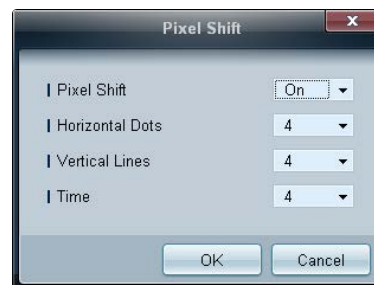

Move the screen slightly at specified time intervals to prevent screen burn-in.

## Screen Saver

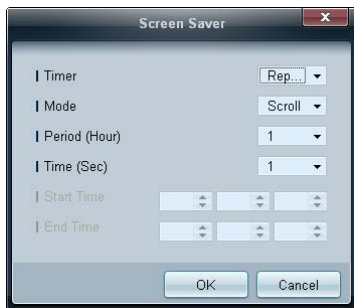

— **Period (Hour)** and **Time (Sec)** can be configured when **Repeat** is selected.

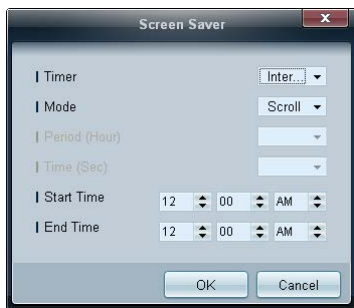

— **Start Time** and **End Time** can be configured when **Interval** is selected.

This function prevents screen burn-in when the screen of the selected display device is left idle for an extended period of time.

**Timer:** You can set the timer for **Screen Saver**.

- **Off**
- **Repeat:** Display the image retention-preventive pattern set in **Mode** at specified time intervals (**Period**).
- **Interval:** Display the image retention-preventive pattern set in **Mode** for a specified period of time (from **Start Time** to **End Time**).
- **Mode:** Select a screen protective pattern to display.
- **Period (Hour):** Specify the time interval to activate the **Screen Saver** function.
  - The option is enabled when **Repeat** is selected for **Timer**.
- **Time (Sec):** Specify the duration to keep the **Screen Saver** function on.
  - The option is enabled when **Repeat** is selected for **Timer**.
- **Start Time:** Set start time to display screen saver.
  - The option is enabled when **Interval** is selected for **Timer**.
- **End Time:** Set end time to display screen saver.
  - The option is enabled when **Interval** is selected for **Timer**.

## Safety Screen



The **Safety Screen** function can be used to prevent screen burn-in when a stationary image displays on the screen of a display device for an extended period of time.

## Lamp Control



**Lamp Control** is used to adjust the backlight to reduce power consumption.

Automatically adjust the backlight of the selected display device at a specified time.

If **Manual Lamp Control** is adjusted, **Auto Lamp Control** will automatically switch to **Off**.

Manually adjust the backlight for the selected display.

If **Auto Lamp Control** is adjusted, **Manual Lamp Control** will automatically switch to **Off**.

- **Ambient Light: Ambient Light** detects ambient light intensity and automatically adjusts the screen brightness of all the LFDs in the same serial chain.

## Ticker

The screenshot shows a dialog box titled "Ticker" with the following sections and controls:

- Ticker:** A dropdown menu set to "Off".
- Message:** A text input field labeled "Text".
- Time:** Two time pickers for "Start Time" and "End Time", both set to "12 : 00 AM".
- Position:** Two dropdown menus for "Horizontal" (set to "Left") and "Vertical" (set to "Down").
- Motion:** Radio buttons for "On" and "Off" (selected), and dropdown menus for "Direction" (set to "Left") and "Speed" (set to "Slow").
- Font Options:** Four dropdown menus for "Size" (Standard), "Foreground Color" (White), "Background Color" (Black), and "Background Opacity" (Solid). A "Reset" button is located below these options.

At the bottom of the dialog are "OK" and "Cancel" buttons.

Input text while a video or image is displayed and display the text on the screen.

### Ticker

Enable or disable **Ticker**.

- **Off / On**

### Message

Enter a message to display on the screen.

### Timer

Set the **Start Time** and **End Time** to display a message (**Message**).

### Position

Select an orientation to display a message (**Message**) from **Horizontal** and **Vertical**.

### Motion

Specify the **Direction** and **Speed** to display a message (**Message**).

### Font Options

Specify the message **Size**, **Foreground Color**, **Foreground Opacity**, **Background Color** and **Background Opacity**.

## Tool Settings

### Security



- **Panel Control:** Turn on or off the screen of a display device.
- **Remote Control:** Enable or disable the remote control.

### Reset



- **Reset Picture:** Reset the screen settings.
- **Reset Sound:** Reset the sound settings.
- **Reset System:** Reset the system settings.
- **Reset All:** Reset the screen, sound and system settings at the same time.

## Edit Column

### Options

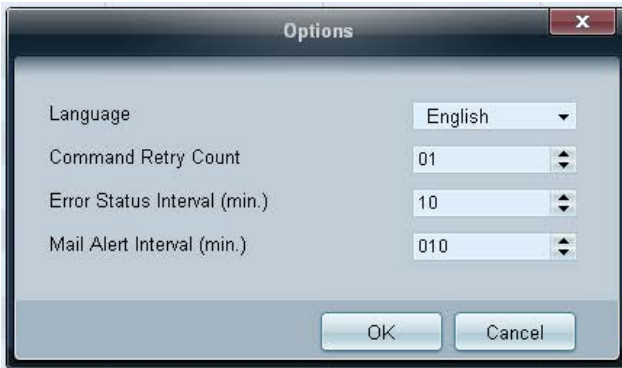

Configure the settings for the items that will be displayed on the list of displays.

- **Language:** Select a language to use in the MDC program. After selecting a language, restart the MDC program to use the selected language.
- **Command Retry Count:** Specify the number of retry attempts when a command fails.
- **Error Status Interval:** Specify the time interval to query the display device in order to check if "Fault Device" has occurred.
- **Mail Alert Interval:** Specify the time interval for email notifications in the event when "Fault Device" occurs.

### Edit Column

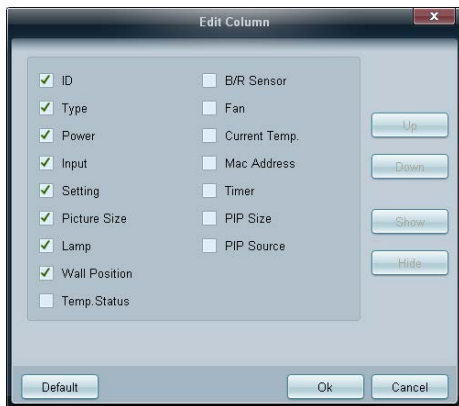

Select the items you want to display in the list of sets.

## Monitor Window

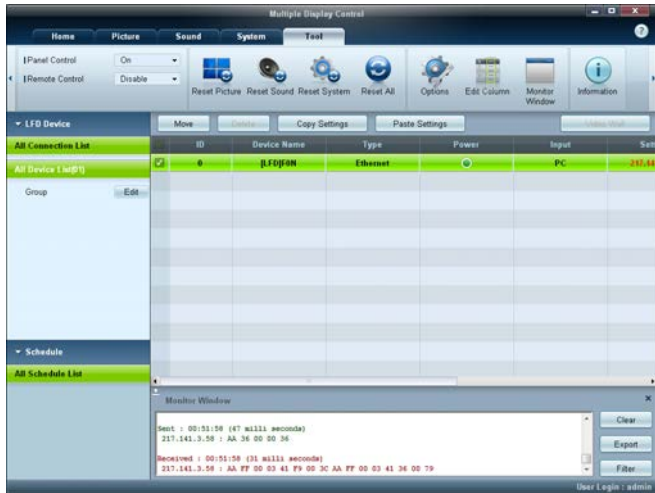

A window appears showing details for data transfer between the computer and display devices.

- **Filter**

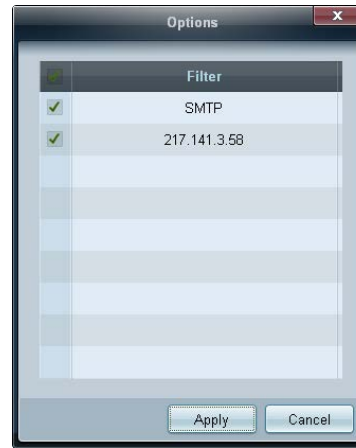

## Information

View the program information.

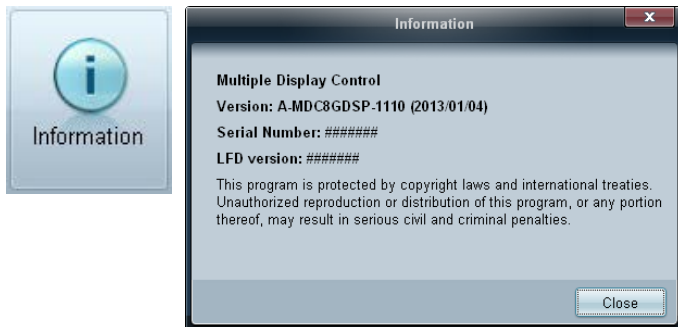

# Other Functions

## Resizing a Window

Place the mouse pointer on a corner of the program window. An arrow will appear. Move the arrow to customize the size of the program window.

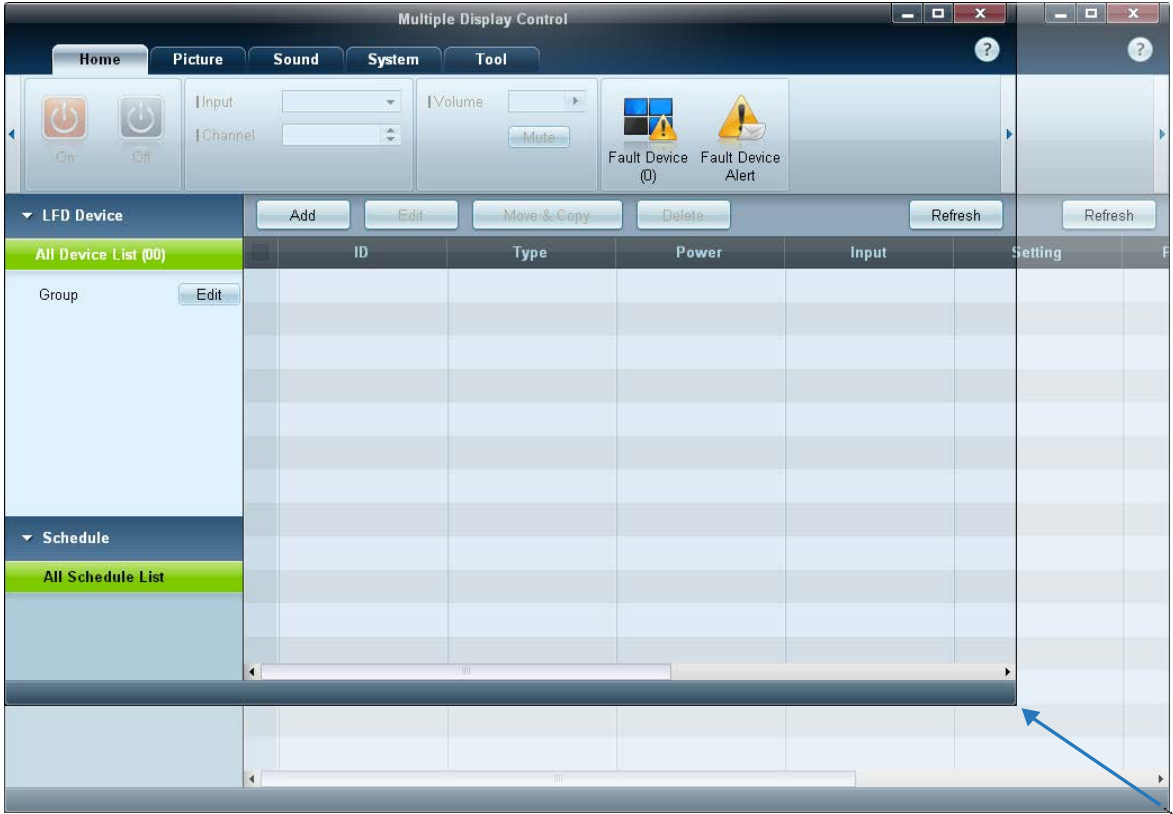



# Group Management

## Creating Groups

Create groups and manage the list of sets on a group basis.

— Duplicate group names cannot be used.

- 1 Right-click and select **Group** → **Edit** in the display device list section on the left side of the program window.

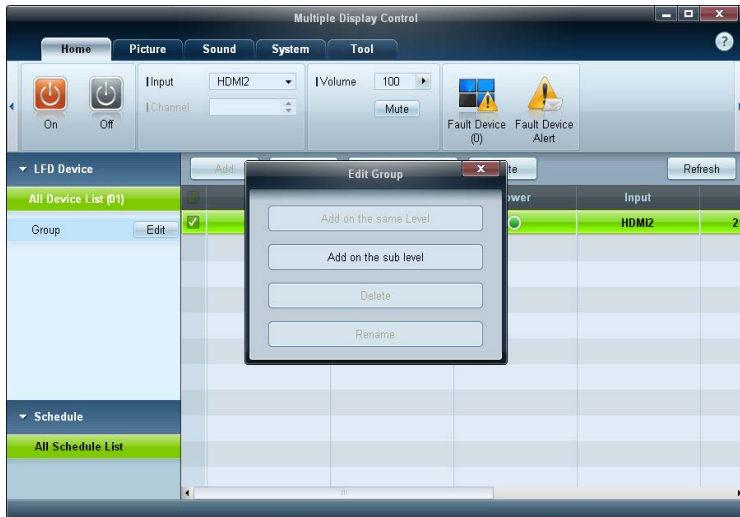

- 2 In the **Edit Group** window displayed, click **Add on the same level** or **Add on the sub level**.

- **Add on the same level**: Create a group on the same level as the selected group.

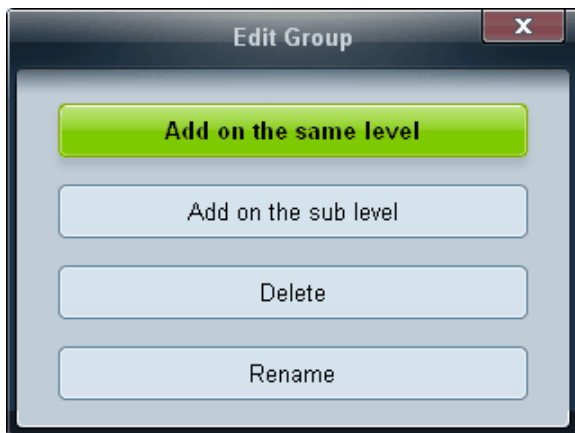

— The **Add on the same level** button is enabled only if at least one group is created.

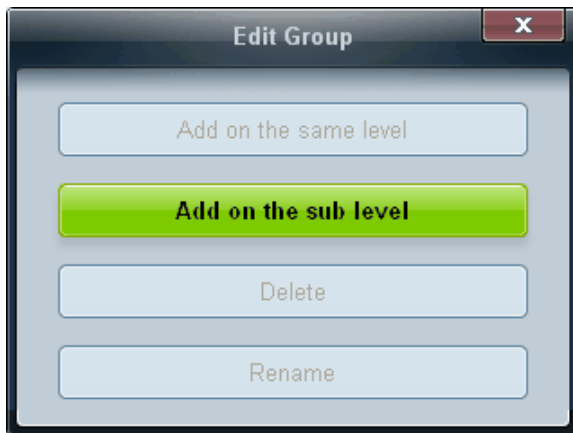

- **Add on the sub level:** Create a sub-group under the selected group.
- 3 Enter the group name.

## Deleting Groups

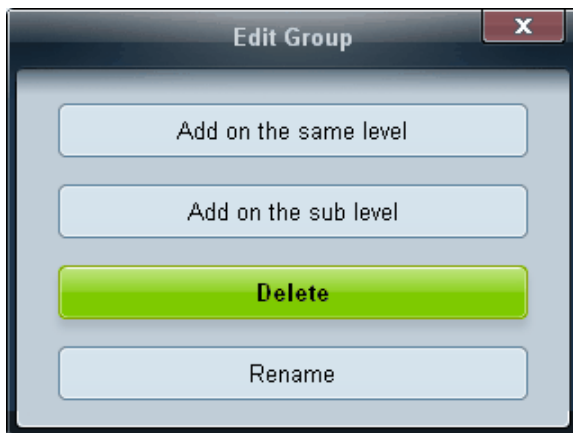

- 1 Select a group name, and click **Edit**.
- 2 In the **Edit Group** window displayed, click **Delete**.
- 3 Click **Yes**. The group will be deleted.

## Renaming Groups

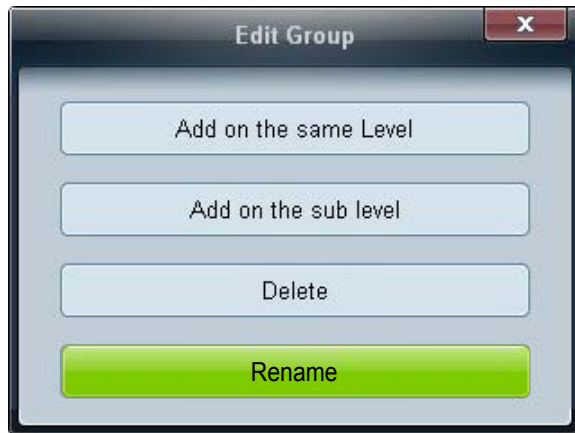

- 1 Select a group name, and click **Edit**.
- 2 In the **Edit Group** window displayed, click **Rename**.
- 3 If a cursor appears in the old group name, enter a new group name.

## Schedule Management

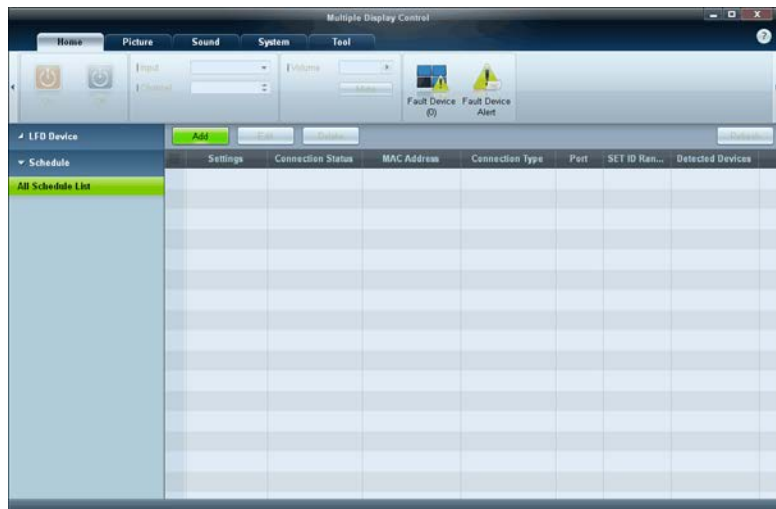

## Creating Schedules

Create and register a schedule on a group basis.

- 1 Click **All Schedule List** in the schedule section on the left side of the program window. The **Add** button will be enabled in the middle.

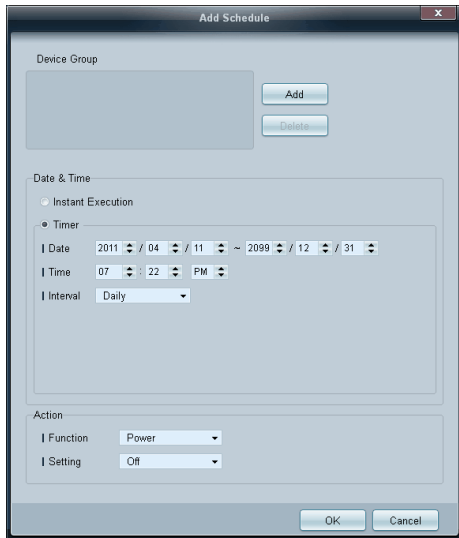

- 2 Click the **Add** button. The **Add Schedule** window will appear.
- 3 Click **Add** below the **Device Group** item, and select the group you want to add a schedule to.

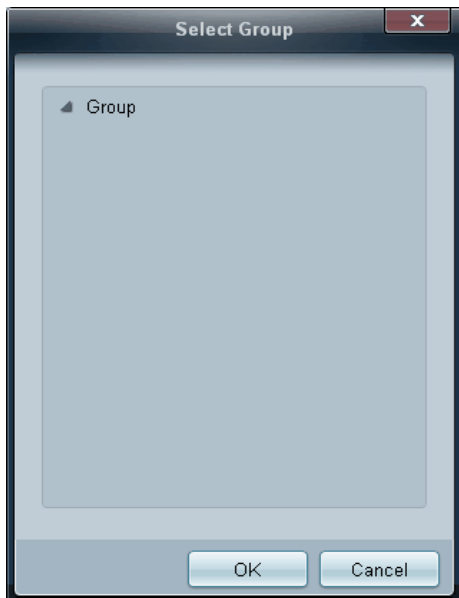

- 4 Select **Date&Time/Action** and click **OK**. The schedule will be added and a list of schedules will appear in the set list window.
  - **Device Group**: Select a group.
  - **Date&Time**
    - Instant Execution**: Run the schedule immediately.
    - Timer**: Set the date, time and interval to run the schedule.
  - **Action**: Select a function that will activate at the specified time and interval.

### Schedule Modification

To modify a schedule, select the schedule and click **Edit**.

### Deleting a Schedule

To delete a schedule, select the schedule and click **Delete**.

---

## Troubleshooting Guide

- 
- This program may malfunction sometimes due to a communication problem between the PC and display or electromagnetic waves emitted from nearby electronic devices.

Issue	Solution
<b>The display you want to control does not appear on the system information chart.</b>	<ol style="list-style-type: none"><li>1 Check the connection of the RS232C cable (check that the cable is properly connected to appropriate serial port).</li><li>2 Check that another display with a duplicate ID is not connected. Connecting displays with a duplicate ID can cause the displays not to be shown due to data collision.</li><li>3 Check that the display ID is within the range of 0 and 99. (Change the ID using the Display menu.)<ul style="list-style-type: none"><li>▮ For a display that supports the ID in a range of 0 to 99, the <b>ID</b> should be set between 0 and 99.</li></ul></li></ol>
<b>The display you want to control does not appear on the other Control Info Grids.</b>	<p>Check that the display is powered on. (See the power status in the system information chart.)</p> <p>Ensure you select the input source the display is connected to.</p>
<b>The following message appears repeatedly.</b>	<p>Check that the display you want to control is selected.</p>
	
<b>Displays power on or off at different time from one another even though <b>On Time</b> or <b>Off Time</b> is set.</b>	<p>Adjust the time on the PC to synchronize the time between the connected displays.</p>
<b>The remote control does not work.</b>	<p>The remote control may not work if the RS-232C cable is removed or the program is closed abnormally while the <b>Remote Control</b> function is <b>Disable</b>. To resolve this, run the program again and set <b>Remote Control</b> to <b>Enable</b>.</p>

---

## How display properties are shown when multiple displays are used

- 1 When no display is selected: The default value is displayed.
- 2 When one display is selected: Settings for the selected display are displayed.
- 3 When two displays are selected (e.g. in sequence of **ID 1** and **ID 3**): The settings for **ID 1** are displayed before the settings for **ID 3**.
- 4 When the **All+Select** checkbox is checked and all displays are selected: The default settings are displayed.

# Chapter 10

## Troubleshooting Guide

---

Before calling Samsung Customer Service Center, test your product as follows. If the problem persists, contact Samsung Customer Service Center.

---

If the screen remains blank, check the PC system, video controller and cable.

### Requirements Before Contacting Samsung Customer Service Center

#### Testing the Product

Check if your product is operating normally by using the product test function.

If the screen remains blank while the power LED blinks even when the product is correctly connected to a PC, perform product testing.

- 1 Power off both the PC and product.
- 2 Disconnect all the cables from the product.
- 3 Power on the product.
- 4 If **No Signal** is displayed, the product is operating normally.

#### Checking the Resolution and Frequency

**Not Optimum Mode** will briefly be displayed if a mode that exceeds a supported resolution is selected (refer to Supported Resolutions).

---

## Check the followings.

### Installation issue (PC mode)

---

**The screen keeps switching on and off.**

Check the cable connection between the product and PC, and ensure the connection is secure.

---

**Blank spaces are found on all four sides of the screen when an HDMI or HDMI-DVI cable is connected to the product and PC.**

The blank spaces found on the screen have nothing to do with the product.

Blank spaces on the screen are caused by the PC or graphics card. To resolve the problem, adjust the screen size in the HDMI or DVI settings for the graphics card.

If the graphics card settings menu does not have an option to adjust the screen size, update the graphics card driver to the latest version.

(Please contact the graphics card or computer manufacturer for further details about how to adjust the screen settings.)

---

### Screen issue

---

**The power LED is off. The screen will not switch on.**

Make sure that the power cord is connected.

---

**No Signal** is displayed on the screen (refer to "Connecting to a PC").

Check that the product is connected correctly with a cable

---

Check that the device connected to the product is powered on.

---

**Not Optimum Mode** is displayed.

This message is displayed when a signal from the graphics card exceeds the product's maximum resolution and frequency.

---

Refer to the Standard Signal Mode Table and set the maximum resolution and frequency according to the product specifications.

---

**The screen is not clear. The screen is blurry.**

Check the cable connection to the product.

---

Remove any accessories (video extension cable, etc) and try again.

---

Set the resolution and frequency to the recommended level.

---



---

## Screen issue

---

**The screen appears unstable and shaky.**

Check that the resolution and frequency of the PC and graphics card are set within a range compatible with the product. Then, change the screen settings if required by referring to the Additional Information on the product menu and the Standard Signal Mode Table.

---

**There are shadows or ghost images left on the screen.**

---

**The screen is too bright. The screen is too dark.**

Adjust **Brightness** and **Contrast**.

---

**Screen color is inconsistent.**

Go to **Picture** and adjust the **Color Control** settings.

---

**White does not really look white.**

Go to **Picture** and adjust the **Color Control** settings.

---

**There is no image on the screen and the power LED blinks every 0.5 to 1 second.**

The product is in power-saving mode.

---

Press any key on the keyboard or move the mouse to return to the previous screen.

---

## Sound issue

---

**There is no sound.**

Check the connection of the audio cable or adjust the volume.

---

Check the volume.

---

**The volume is too low.**

Adjust the volume.

---

If the volume is still low after turning it up to the maximum level, adjust the volume on your PC sound card or software program.

---

---

## Remote control issue

---

**The remote control does not work.**

Make sure that the batteries are correctly in place (+/-).

---

Check if the batteries are flat.

---

Check for power failure.

---

Make sure that the power cord is connected.

---

Check for any special lighting or neon signs switched on in the vicinity.

---

## Source device issue

---

**A beeping sound is heard when my PC is booting.**

If a beeping sound is heard when your PC is booting, have your PC serviced.

---

---

## Q & A

### Question

How can I change the frequency?

---

Refer to the user manual for your PC or graphics card for further instructions on adjustment.

### Answer

Set the frequency on your graphics card.

- Windows XP: Go to **Control Panel** → **Appearance and Themes** → **Display** → **Settings** → **Advanced** → **Monitor** and adjust the frequency in **Monitor Settings**.
- Windows ME/2000: Go to **Control Panel** → **Display** → **Settings** → **Advanced** → **Monitor** and adjust the frequency in **Monitor Settings**.
- Windows Vista: Go to **Control Panel** → **Appearance and Personalization** → **Personalize** → **Display Settings** → **Advanced Settings** → **Monitor** and adjust the frequency in **Monitor Settings**.
- Windows 7: Go to **Control Panel** → **Appearance and Personalization** → **Display** → **Adjust resolution** → **Advanced Settings** → **Monitor** and adjust the frequency in **Monitor Settings**.
- Windows 8: Go to **Settings** → **Control Panel** → **Appearance and Personalization** → **Display** → **Adjust resolution** → **Advanced Settings** → **Monitor** and adjust the frequency in **Monitor Settings**.

---

How can I change the resolution?

- Windows XP: Go to **Control Panel** → **Appearance and Themes** → **Display** → **Settings** and adjust the resolution.
  - Windows ME/2000: Go to **Control Panel** → **Display** → **Settings** and adjust the resolution.
  - Windows Vista: Go to **Control Panel** → **Appearance and Personalization** → **Personalize** → **Display Settings** and adjust the resolution.
  - Windows 7: Go to **Control Panel** → **Appearance and Personalization** → **Display** → **Adjust Resolution** and adjust the resolution.
  - Windows 8: Go to **Settings** → **Control Panel** → **Appearance and Personalization** → **Display** → **Adjust Resolution** and adjust the resolution.
-

---

## Question

How do I set powersaving mode?

## Answer

- Windows XP: Set power-saving mode in **Control Panel** → **Appearance and Themes** → **Display** → **Screen Saver Settings** or BIOS SETUP on the PC.
  - Windows ME/2000: Set power-saving mode in **Control Panel** → **Display** → **Screen Saver Settings** or BIOS SETUP on the PC.
  - Windows Vista: Set power-saving mode in **Control Panel** → **Appearance and Personalization** → **Personalize** → **Screen Saver Settings** or BIOS SETUP on the PC.
  - Windows 7: Set power-saving mode in **Control Panel** → **Appearance and Personalization** → **Personalize** → **Screen Saver Settings** or BIOS SETUP on the PC.
  - Windows 8: Set power-saving mode in **Settings** → **Control Panel** → **Appearance and Personalization** → **Personalize** → **Screen Saver Settings** or BIOS SETUP on the PC.
-

# Chapter 11

## Specifications

1 Size

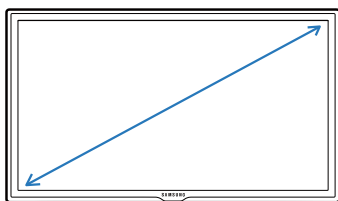

2 Display area

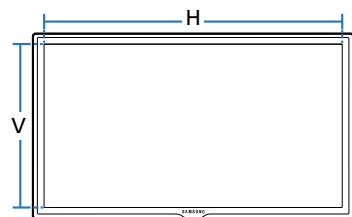

3 Dimensions (W x H x D)

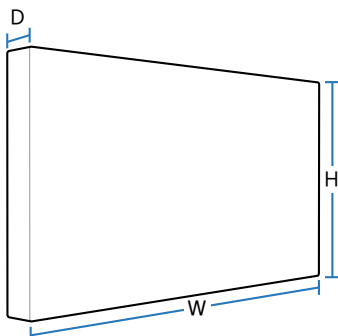

## General

Model Name		LE32C	LE46C	LE55C
Panel	Size	32 Class (32 inches / 80.5 cm)	46 Class (45.9 inches / 116 cm)	55 Class (54.6 inches / 138 cm)
	Display area	698.4 mm (H) x 392.85 mm (V) 27.5 inches (H) x 15.5 inches (V)	1018.08 mm (H) x 572.67 mm (V) 40.1 inches (H) x 22.5 inches (V)	1209.6 mm (H) x 680.4 mm (V) 47.6 inches (H) x 26.8 inches (V)
Dimensions (W x H x D)		744.0 X 452.7 X 65.9 mm 29.3 X 17.8 X 2.6 inches	1061.0 X 619.8 X 51.7 mm 41.8 X 24.4 X 2.0 inches	1252.4 X 727.7 X 51.7 mm 49.3 X 28.6 X 2.0 inches
Weight (without stand)		9.1 Kg / 20 lbs	17.4 Kg / 38.4 lbs	23.6 Kg / 52 lbs
VESA		200 x 200 mm	400 x 400 mm	400 x 400 mm
Display Color		1073.7 M		
Maximum Pixel Clock		148.5 MHz		
Synchronization	Horizontal Frequency	30~81 kHz		
	Vertical Frequency	56~85 Hz		

Model Name		LE32C	LE46C	LE55C
<b>Resolution</b>	<b>Optimum resolution</b>	1920 x 1080 @ 60 Hz		
	<b>Maximum resolution</b>	1920 x 1080 @ 60 Hz		
<b>Power Supply</b>		This product uses 100 to 240V. Refer to the label at the back of the product as the standard voltage can vary in different countries.		
<b>Signal connectors</b>	<b>Input</b>	PC, DVI, AV, Component, HDMI1, HDMI2, Audio In, RJ45, RS232C IN, External Ambient Sensor, PIM(option)		
	<b>Output</b>	Audio Out, RS232C Out, IR Out		
	<b>Optional Network</b>	USB3.0 2port, USB2.0 2port, LAN, DP out, MIC in, Audio Out		
<b>Environmental considerations</b>	<b>Operating</b>	Temperature		
		With PIM: 50°F~104°F (10°C~ 40°C) / Without PIM: 32°F~104°F (0°C~ 40°C)		
	Humidity: 10% ~ 80%, non-condensing			
	<b>Storage</b>	Temperature: -4°F~113°F (-20°C~ 45°C)		
Humidity: 5% ~ 95%, non-condensing				

— Plug-and-Play

This monitor can be installed and used with any Plug-and-Play compatible systems.

Two-way data exchange between the monitor and PC system optimizes the monitor settings.

Monitor installation takes place automatically. However, you can customize the installation settings if desired.

— Due to the nature of the manufacturing of this product, approximately 1 pixel per million (1ppm) may appear brighter or darker on the panel.

This does not affect product performance.

— This device is a Class A digital apparatus.

---

[Recommendation] - EU Only



- Hereby, Samsung Electronics, declares that this Monitor is in compliance with the essential requirements and other relevant provisions of Directive 1999/5/EC.
- The official Declaration of Conformity may be found at <http://www.samsung.com>, go to Support > Search Product Support and enter the model name.
- This equipment may be operated in all EU countries.

(USA only)

Dispose unwanted electronics through an approved recycler.

To find the nearest recycling location, go to our website:

[www.samsung.com/recyclingdirect](http://www.samsung.com/recyclingdirect) or call, (877) 278 - 0799

## PowerSaver

The power-saving function of this product reduces power consumption by switching off the screen and changing the color of the power LED if the product is not used for a specified period of time. The power is not turned off in power-saving mode. To switch the screen back on, press any key on the keyboard or move the mouse. Power-savign mode only functions when the product is connected to a PC with a power-saving function.

### LE32C

PowerSaver	Normal Operation			Power saving mode	Power off (Power Button off)
	Rating		Typical		
	Without PIM	With PIM			
Power Indicator	On (Green)			Blinking	On (Orange)
Power Consumption	70 W	130 W	57 W	Lower than 0.5 W	Lower than 0.5 W

### LE46C

PowerSaver	Normal Operation			Power saving mode	Power off (Power Button off)
	Rating		Typical		
	Without PIM	With PIM			
Power Indicator	On (Green)			Blinking	On (Orange)
Power Consumption	120 W	180 W	99 W	Lower than 0.5 W	Lower than 0.5 W



## LE55C

PowerSaver	Normal Operation			Power saving mode	Power off (Power Button off)
	Rating		Typical		
	Without PIM	With PIM			
Power Indicator	On (Green)			Blinking	On (Orange)
Power Consumption	140 W	200 W	123 W	Lower than 0.5 W	Lower than 0.5 W

— The displayed power consumption level can vary in different operating conditions or when settings are changed.

— SOG(Sync On Green) is not supported.

— To reduce the power consumption to 0, turn off the switch at the back or disconnect the power cord.

Disconnect the power cable if you will not be using the product for an extended period of time (during vacation, etc.).

## Preset Timing Modes

- This product can be set to only one resolution for each screen size to obtain the optimum picture quality due to the nature of the panel.
  - Using a resolution other than the specified resolution may degrade the picture quality.
  - To avoid this, it is recommended that you select the optimum resolution specified for your product.
  - Check the frequency when you exchange a CDT product (connected to a PC) for an LCD product.
  - If the LCD product does not support 85Hz, change the vertical frequency to 60Hz using the CDT product before you exchange it with the LCD product.

The screen will automatically be adjusted if a signal that belongs to the following standard signal modes is transmitted from your PC. If the signal transmitted from the PC does not belong to the standard signal modes, the screen may be blank with the power LED on. In such a case, change the settings according to the following table by referring to the graphics card user manual.

<b>Resolution</b>	<b>Horizontal Frequency (kHz)</b>	<b>Vertical Frequency (Hz)</b>	<b>Pixel Clock (MHz)</b>	<b>Sync Polarity (H/V)</b>
VESA, 640 x 480	31,469	59,940	25,175	-/-
IBM, 720 x 400	31,469	70,087	28,322	-/+
MAC, 640 x 480	35,000	66,667	30,240	-/-
MAC, 832 x 624	49,726	74,551	57,284	-/-
VESA, 640 x 480	37,861	72,809	31,500	-/-
VESA, 640 x 480	37,500	75,000	31,500	-/-
VESA, 800 x 600	35,156	56,250	36,000	+/+
VESA, 800 x 600	37,879	60,317	40,000	+/+
VESA, 800 x 600	48,077	72,188	50,000	+/+
VESA, 800 x 600	46,875	75,000	49,500	+/+
VESA, 1024 x 768	48,363	60,004	65,000	-/-
VESA, 1024 x 768	56,476	70,069	75,000	-/-

---

– Horizontal Frequency

The time to scan one line connecting the right edge to the left edge of the screen horizontally is called the Horizontal Cycle and the inverse number of the Horizontal Cycle is called the Horizontal Frequency.

Unit: kHz

– Vertical Frequency

Like a fluorescent lamp, the screen has to repeat the same image many times per second to display an image to the user. The frequency of this repetition is called the Vertical Frequency or Refresh Rate.

Unit: Hz

---

<b>Resolution</b>	<b>Horizontal Frequency (kHz)</b>	<b>Vertical Frequency (Hz)</b>	<b>Pixel Clock (MHz)</b>	<b>Sync Polarity (H/V)</b>
VESA, 1024 x 768	60,023	75,029	78,750	+/+
VESA, 1152 x 864	67,500	75,000	108,000	+/+
MAC, 1152 x 870	68,681	75,062	100,000	-/-
VESA, 1280 x 720	45,000	60,000	74,250	+/+
VESA, 1280 x 800	49,702	59,810	83,500	-/+
VESA, 1280 x 1024	63,981	60,020	108,000	+/+
VESA, 1280 x 1024	79,976	75,025	135,000	+/+
VESA, 1366 x 768	47,712	59,790	85,500	+/+
VESA, 1440 x 900	55,935	59,887	106,500	-/+
VESA(RB), 1600 x 900	60,000	60,000	108,000	+/+
VESA, 1680 x 1050	65,290	59,954	146,250	-/+
VESA, 1920 x 1080	67,500	60,000	148,500	+/+

---

# Chapter 12

## Appendix

### Contact SAMSUNG WORLD WIDE

— If you have any questions or comments relating to Samsung products, please contact the SAMSUNG customer care center.

#### NORTH AMERICA

<b>U.S.A</b>	1-800-SAMSUNG (726-7864)	<a href="http://www.samsung.com">http://www.samsung.com</a>
<b>CANADA</b>	1-800-SAMSUNG (726-7864)	<a href="http://www.samsung.com/ca">http://www.samsung.com/ca</a> (English) <a href="http://www.samsung.com/ca_fr">http://www.samsung.com/ca_fr</a> (French)
<b>MEXICO</b>	01-800-SAMSUNG (726-7864)	<a href="http://www.samsung.com">http://www.samsung.com</a>

#### LATIN AMERICA

<b>ARGENTINE</b>	0800-333-3733	<a href="http://www.samsung.com">http://www.samsung.com</a>
<b>BOLIVIA</b>	800-10-7260	<a href="http://www.samsung.com">http://www.samsung.com</a>
<b>BRAZIL</b>	0800-124-421 4004-0000	<a href="http://www.samsung.com">http://www.samsung.com</a>
<b>CHILE</b>	800-SAMSUNG (726-7864) From mobile 02-482 82 00	<a href="http://www.samsung.com">http://www.samsung.com</a>
<b>COLOMBIA</b>	01-8000112112	<a href="http://www.samsung.com">http://www.samsung.com</a>

## LATIN AMERICA

<b>COSTA RICA</b>	0-800-507-7267	<a href="http://www.samsung.com/latin">http://www.samsung.com/latin</a> (Spanish) <a href="http://www.samsung.com/latin_en">http://www.samsung.com/latin_en</a> (English)
<b>DOMINICA</b>	1-800-751-2676	<a href="http://www.samsung.com/latin">http://www.samsung.com/latin</a> (Spanish) <a href="http://www.samsung.com/latin_en">http://www.samsung.com/latin_en</a> (English)
<b>ECUADOR</b>	1-800-10-7267	<a href="http://www.samsung.com/latin">http://www.samsung.com/latin</a> (Spanish) <a href="http://www.samsung.com/latin_en">http://www.samsung.com/latin_en</a> (English)
<b>EL SALVADOR</b>	800-6225	<a href="http://www.samsung.com/latin">http://www.samsung.com/latin</a> (Spanish) <a href="http://www.samsung.com/latin_en">http://www.samsung.com/latin_en</a> (English)
<b>GUATEMALA</b>	1-800-299-0013	<a href="http://www.samsung.com/latin">http://www.samsung.com/latin</a> (Spanish) <a href="http://www.samsung.com/latin_en">http://www.samsung.com/latin_en</a> (English)
<b>HONDURAS</b>	800-27919267	<a href="http://www.samsung.com/latin">http://www.samsung.com/latin</a> (Spanish) <a href="http://www.samsung.com/latin_en">http://www.samsung.com/latin_en</a> (English)
<b>JAMAICA</b>	1-800-234-7267	<a href="http://www.samsung.com">http://www.samsung.com</a>
<b>NICARAGUA</b>	00-1800-5077267	<a href="http://www.samsung.com/latin">http://www.samsung.com/latin</a> (Spanish) <a href="http://www.samsung.com/latin_en">http://www.samsung.com/latin_en</a> (English)
<b>PANAMA</b>	800-7267	<a href="http://www.samsung.com/latin">http://www.samsung.com/latin</a> (Spanish) <a href="http://www.samsung.com/latin_en">http://www.samsung.com/latin_en</a> (English)
<b>PERU</b>	0-800-777-08	<a href="http://www.samsung.com">http://www.samsung.com</a>
<b>PUERTO RICO</b>	1-800-682-3180	<a href="http://www.samsung.com">http://www.samsung.com</a>
<b>TRINIDAD &amp; TOBAGO</b>	1-800-SAMSUNG (726-7864)	<a href="http://www.samsung.com">http://www.samsung.com</a>
<b>VENEZUELA</b>	0-800-100-5303	<a href="http://www.samsung.com">http://www.samsung.com</a>

## EUROPE

<b>AUSTRIA</b>	0810 - SAMSUNG (7267864, € 0.07/min)	<a href="http://www.samsung.com">http://www.samsung.com</a>
<b>BELGIUM</b>	02-201-24-18	<a href="http://www.samsung.com/be">http://www.samsung.com/be</a> (Dutch) <a href="http://www.samsung.com/be_fr">http://www.samsung.com/be_fr</a> (French)
<b>BOSNIA</b>	05 133 1999	<a href="http://www.samsung.com">http://www.samsung.com</a>
<b>BULGARIA</b>	07001 33 11, normal tariff	<a href="http://www.samsung.com">http://www.samsung.com</a>
<b>CROATIA</b>	062 SAMSUNG (062 726 7864)	<a href="http://www.samsung.com">http://www.samsung.com</a>
<b>CYPRUS</b>	8009 4000 only from landline (+30) 210 6897691 from mobile and land line	<a href="http://www.samsung.com">http://www.samsung.com</a>
<b>CZECH</b>	800 - SAMSUNG (800-726786)  Samsung Electronics Czech and Slovak, s.r.o., Oasis Florenc, Sokolovská 394/17, 180 00, Praha 8	<a href="http://www.samsung.com">http://www.samsung.com</a>
<b>DENMARK</b>	70 70 19 70	<a href="http://www.samsung.com">http://www.samsung.com</a>
<b>EIRE</b>	0818 717100	<a href="http://www.samsung.com">http://www.samsung.com</a>
<b>ESTONIA</b>	800-7267	<a href="http://www.samsung.com">http://www.samsung.com</a>
<b>FINLAND</b>	09 85635050	<a href="http://www.samsung.com">http://www.samsung.com</a>
<b>FRANCE</b>	01 48 63 00 00	<a href="http://www.samsung.com">http://www.samsung.com</a>
<b>GERMANY</b>	0180 5 SAMSUNG bzw. 0180 5 7267864* (*0,14 €/Min. aus dem dt. Festnetz, aus dem Mobilfunk max. 0,42 €/Min.)	<a href="http://www.samsung.com">http://www.samsung.com</a>
<b>GREECE</b>	80111-SAMSUNG (80111 726 7864) only from land line (+30) 210 6897691 from mobile and land line	<a href="http://www.samsung.com">http://www.samsung.com</a>
<b>HUNGARY</b>	06-80-SAMSUNG (726-7864)	<a href="http://www.samsung.com">http://www.samsung.com</a>

## EUROPE

<b>ITALIA</b>	800-SAMSUNG (726-7864)	<a href="http://www.samsung.com">http://www.samsung.com</a>
<b>LATVIA</b>	8000-7267	<a href="http://www.samsung.com">http://www.samsung.com</a>
<b>LITHUANIA</b>	8-800-77777	<a href="http://www.samsung.com">http://www.samsung.com</a>
<b>LUXEMBURG</b>	261 03 710	<a href="http://www.samsung.com">http://www.samsung.com</a>
<b>MONTENEGRO</b>	020 405 888	<a href="http://www.samsung.com">http://www.samsung.com</a>
<b>NETHERLANDS</b>	0900-SAMSUNG (0900-7267864) (€ 0,10/Min)	<a href="http://www.samsung.com">http://www.samsung.com</a>
<b>NORWAY</b>	815 56480	<a href="http://www.samsung.com">http://www.samsung.com</a>
<b>POLAND</b>	0 801-1SAMSUNG (172-678) +48 22 607-93-33	<a href="http://www.samsung.com">http://www.samsung.com</a>
<b>PORTUGAL</b>	808 20-SAMSUNG (808 20 7267)	<a href="http://www.samsung.com">http://www.samsung.com</a>
<b>ROMANIA</b>	08008 SAMSUNG (08008 726 7864) TOLL FREE No.	<a href="http://www.samsung.com">http://www.samsung.com</a>
<b>SERBIA</b>	0700 SAMSUNG (0700 726 7864)	<a href="http://www.samsung.com">http://www.samsung.com</a>
<b>SLOVAKIA</b>	0800 - SAMSUNG (0800-726 786)	<a href="http://www.samsung.com">http://www.samsung.com</a>
<b>SPAIN</b>	902 - 1 - SAMSUNG (902 172 678)	<a href="http://www.samsung.com">http://www.samsung.com</a>
<b>SWEDEN</b>	0771 726 7864 (SAMSUNG)	<a href="http://www.samsung.com">http://www.samsung.com</a>
<b>SWITZERLAND</b>	0848 - SAMSUNG (7267864, CHF 0.08/min)	<a href="http://www.samsung.com/ch">http://www.samsung.com/ch</a> (German) <a href="http://www.samsung.com/ch_fr">http://www.samsung.com/ch_fr</a> (French)
<b>U.K</b>	0330 SAMSUNG (7267864)	<a href="http://www.samsung.com">http://www.samsung.com</a>

## CIS

ARMENIA	0-800-05-555	<a href="http://www.samsung.com">http://www.samsung.com</a>
AZERBAIJAN	088-55-55-555	<a href="http://www.samsung.com">http://www.samsung.com</a>
BELARUS	810-800-500-55-500	<a href="http://www.samsung.com">http://www.samsung.com</a>
GEORGIA	0-800-555-555	<a href="http://www.samsung.com">http://www.samsung.com</a>
KAZAKHSTAN	8-10-800-500-55-500 (GSM: 7799)	<a href="http://www.samsung.com">http://www.samsung.com</a>
KYRGYZSTAN	00-800-500-55-500	<a href="http://www.samsung.com">http://www.samsung.com</a>
MOLDOVA	0-800-614-40	<a href="http://www.samsung.com">http://www.samsung.com</a>
MONGOLIA	+7-800-555-55-55	<a href="http://www.samsung.com">http://www.samsung.com</a>
RUSSIA	8-800-555-55-55	<a href="http://www.samsung.com">http://www.samsung.com</a>
TADJIKISTAN	8-10-800-500-55-500	<a href="http://www.samsung.com">http://www.samsung.com</a>
UKRAINE	0-800-502-000	<a href="http://www.samsung.com/ua">http://www.samsung.com/ua</a> (Ukrainian) <a href="http://www.samsung.com/ua_ru">http://www.samsung.com/ua_ru</a> (Russian)
UZBEKISTAN	8-10-800-500-55-500	<a href="http://www.samsung.com">http://www.samsung.com</a>

## ASIA PACIFIC

AUSTRALIA	1300 362 603	<a href="http://www.samsung.com">http://www.samsung.com</a>
CHINA	400-810-5858	<a href="http://www.samsung.com">http://www.samsung.com</a>
HONG KONG	(852) 3698-4698	<a href="http://www.samsung.com/hk">http://www.samsung.com/hk</a> (Chinese) <a href="http://www.samsung.com/hk_en">http://www.samsung.com/hk_en</a> (English)



---

## ASIA PACIFIC

<b>INDIA</b>	1800 1100 11 3030 8282 1800 3000 8282 1800 266 8282	<a href="http://www.samsung.com">http://www.samsung.com</a>
<b>INDONESIA</b>	0800-112-8888 021-5699-7777	<a href="http://www.samsung.com">http://www.samsung.com</a>
<b>JAPAN</b>	0120-327-527	<a href="http://www.samsung.com">http://www.samsung.com</a>
<b>MALAYSIA</b>	1800-88-9999	<a href="http://www.samsung.com">http://www.samsung.com</a>
<b>NEW ZEALAND</b>	0800 SAMSUNG (0800 726 786)	<a href="http://www.samsung.com">http://www.samsung.com</a>
<b>PHILIPPINES</b>	1-800-10-SAMSUNG (726-7864) for PLDT 1-800-3-SAMSUNG (726-7864) for Digitel 1-800-8-SAMSUNG (726-7864) for Globe 02-5805777	<a href="http://www.samsung.com">http://www.samsung.com</a>
<b>SINGAPORE</b>	1800-SAMSUNG (726-7864)	<a href="http://www.samsung.com">http://www.samsung.com</a>
<b>TAIWAN</b>	0800-329-999 0266-026-066	<a href="http://www.samsung.com">http://www.samsung.com</a>
<b>THAILAND</b>	1800-29-3232 02-689-3232	<a href="http://www.samsung.com">http://www.samsung.com</a>
<b>VIETNAM</b>	1 800 588 889	<a href="http://www.samsung.com">http://www.samsung.com</a>

## MIDDLE EAST

<b>BAHRAIN</b>	8000-4726	<a href="http://www.samsung.com/ae">http://www.samsung.com/ae</a> (English) <a href="http://www.samsung.com/ae_ar">http://www.samsung.com/ae_ar</a> (Arabic)
<b>EGYPT</b>	08000-726786	<a href="http://www.samsung.com">http://www.samsung.com</a>
<b>IRAN</b>	021-8255	<a href="http://www.samsung.com">http://www.samsung.com</a>
<b>JORDAN</b>	800-22273 065777444	<a href="http://www.samsung.com">http://www.samsung.com</a>
<b>KUWAIT</b>	183-2255	<a href="http://www.samsung.com/ae">http://www.samsung.com/ae</a> (English) <a href="http://www.samsung.com/ae_ar">http://www.samsung.com/ae_ar</a> (Arabic)
<b>MOROCCO</b>	080 100 2255	<a href="http://www.samsung.com">http://www.samsung.com</a>
<b>OMAN</b>	800-SAMSUNG (726-7864)	<a href="http://www.samsung.com/ae">http://www.samsung.com/ae</a> (English) <a href="http://www.samsung.com/ae_ar">http://www.samsung.com/ae_ar</a> (Arabic)
<b>SAUDI ARABIA</b>	9200-21230	<a href="http://www.samsung.com/ae">http://www.samsung.com/ae</a> (English) <a href="http://www.samsung.com/ae_ar">http://www.samsung.com/ae_ar</a> (Arabic)
<b>TURKEY</b>	444 77 11	<a href="http://www.samsung.com">http://www.samsung.com</a>
<b>U.A.E</b>	800-SAMSUNG (726-7864)	<a href="http://www.samsung.com">http://www.samsung.com</a>

## AFRICA

<b>ANGOLA</b>	91-726-7864	<a href="http://www.samsung.com">http://www.samsung.com</a>
<b>BOTSWANA</b>	0800-726-000	<a href="http://www.samsung.com">http://www.samsung.com</a>
<b>CAMEROON</b>	7095- 0077	<a href="http://www.samsung.com">http://www.samsung.com</a>
<b>COTE D'IVOIRE</b>	8000 0077	<a href="http://www.samsung.com">http://www.samsung.com</a>

---

## AFRICA

<b>GHANA</b>	0800-10077 0302-200077	<a href="http://www.samsung.com">http://www.samsung.com</a>
<b>KENYA</b>	0800 545 545	<a href="http://www.samsung.com">http://www.samsung.com</a>
<b>NAMIBIA</b>	8197267864	<a href="http://www.samsung.com">http://www.samsung.com</a>
<b>NIGERIA</b>	0800-726-7864	<a href="http://www.samsung.com">http://www.samsung.com</a>
<b>SENEGAL</b>	800-00-0077	<a href="http://www.samsung.com">http://www.samsung.com</a>
<b>SOUTH AFRICA</b>	0860-SAMSUNG (726-7864)	<a href="http://www.samsung.com">http://www.samsung.com</a>
<b>TANZANIA</b>	0685 88 99 00	<a href="http://www.samsung.com">http://www.samsung.com</a>
<b>UGANDA</b>	0800 300 300	<a href="http://www.samsung.com">http://www.samsung.com</a>
<b>ZAMBIA</b>	211350370	<a href="http://www.samsung.com">http://www.samsung.com</a>

---

## Responsibility for the Pay Service (Cost to Customers)

— When the service is requested, in spite of in warranty, we may charge you for a visit from a service technician in the following cases.

### Not a product defect

Cleaning of the product, Adjustment, Explanation, Re-installation and etc.

- If a service technician gives instructions on how to use product or simply adjusts options without disassembling product.
- If a defect is caused by external environmental factors (Internet, Antenna, Wired Signal, etc.)
- If a product is reinstalled or devices are connected additionally after installing the purchased product for the first time.
- If a product is reinstalled to move to a different spot or to move to a different house.
- If customer requests instructions on how to use because of another company's product.
- If customer requests instructions on how to use the network or another company's program.
- If customer requests software installation and setup for the product.
- If a service technician removes/cleans dusts or foreign materials inside of the product.
- If customer requests an installation additionally after purchasing a product through home-shopping or online.

## A Product damage caused by customer's fault

Product damage caused by customer's mishandling or wrong repair

If a product damage is caused by;

- External impact or drop.
- Use of supplies or separately sold product unspecified by Samsung.
- Repair from a person besides an engineer of outsourcing service company or partner of Samsung Electronics Co., Ltd.
- Remodeling or repairing the product by customer.
- Using it with incorrect voltage or non-authorized electrical connections.
- Not following the "cautions" in User Manual.

### Others

- If product fails by natural disaster. (lightning, fire, earthquake, flood damage, etc)
- If consumable components are all used up. (Battery, Toner, Fluorescent lights, Head, Vibrator, Lamp, Filter, Ribbon, etc.)

— If customer requests a service in case the product has no defect, service fee may be charged. So please read User Manual first.

---

## Correct Disposal

### Correct Disposal of This Product (Waste Electrical & Electronic Equipment)



(Applicable in countries with separate collection systems)

This marking on the product, accessories or literature indicates that the product and its electronic accessories (e.g. charger, headset, USB cable) should not be disposed of with other household waste at the end of their working life. To prevent possible harm to the environment or human health from uncontrolled waste disposal, please separate these items from other types of waste and recycle them responsibly to promote the sustainable reuse of material resources.

Household users should contact either the retailer where they purchased this product, or their local government office, for details of where and how they can take these items for environmentally safe recycling. Business users should contact their supplier and check the terms and conditions of the purchase contract. This product and its electronic accessories should not be mixed with other commercial wastes for disposal.

### Correct disposal of batteries in this product



(Applicable in countries with separate collection systems)

The marking on the battery, manual or packaging indicates that the battery in this product should not be disposed of with other household waste. Where marked, the chemical symbols Hg, Cd or Pb indicate that the battery contains mercury, cadmium or lead above the reference levels in EC Directive 2006/66.

The battery incorporated in this product is not user replaceable. For information on its replacement, please contact your service provider. Do not attempt to remove the battery or dispose it in a fire. Do not disassemble, crush, or puncture the battery. If you intend to discard the product, the waste collection site will take the appropriate measures for the recycling and treatment of the product, including the battery.

---

# Optimum Picture Quality and Afterimage Burn-in Prevention

## Optimum Picture Quality

- To enjoy the optimum picture quality, go to Control Panel on your PC and adjust the resolution and refresh rate as follows. The picture quality of TFT-LCDs may degrade if the optimum resolution is not selected.
  - Resolution: 1920 x 1080 @ 60 Hz
  - Vertical frequency (refresh rate): 58 ~ 85 Hz  
Screen refresh rate: refers to the number of times a display image is refreshed per second.
- Due to the nature of the manufacturing of this product, approximately 1 pixel per million (1ppm) may be brighter or darker on the panel. This does not affect product performance.
  - The number of sub-pixels by panel type: 6,220,800
- Run **Auto Adjustment** to improve the picture quality. If noise is still found even after auto adjustment, adjust **Coarse** or **Fine**.
- Leaving the screen fixed on a stationary image for an extended period of time may cause afterimage burn-in or defective pixels.
  - Activate power-saving mode or a dynamic screen saver if you will not be using the product for an extended period of time.
- Unlike CDT monitors, TFT-LCD monitors (due to the nature of the panel) can be set to only one resolution to obtain the optimum picture quality. Therefore, setting a resolution other than the specified resolution may degrade the picture quality. To avoid this, it is recommended that you select the optimum resolution specified for your monitor.

## Prevention of Afterimage Burn-in

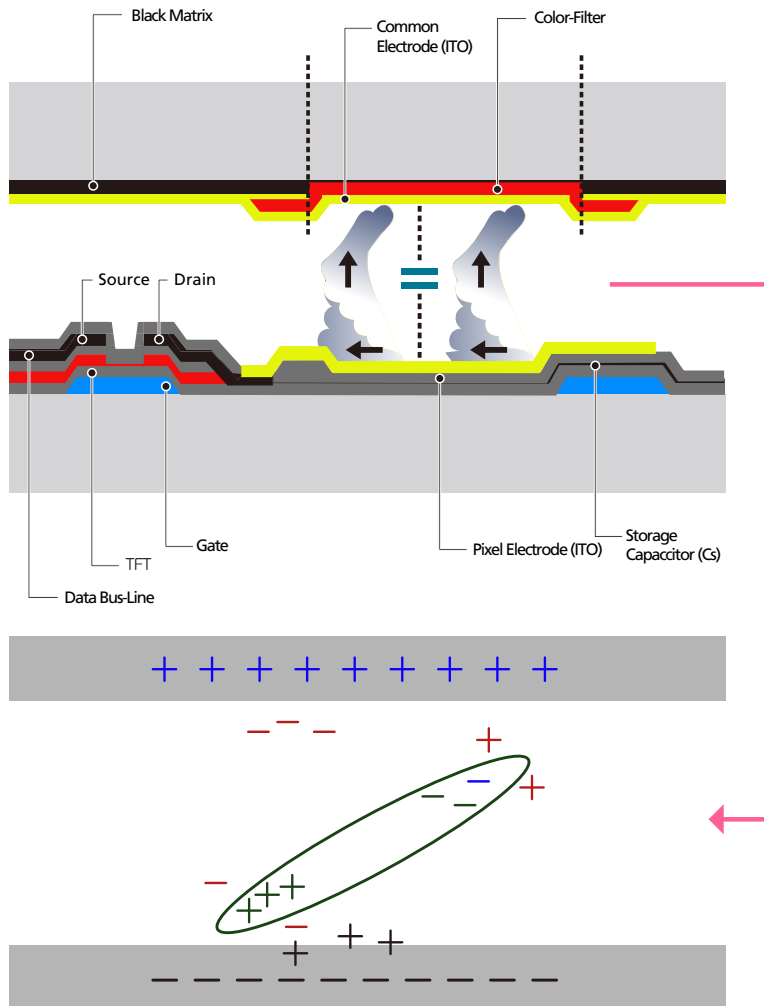

## What is afterimage burn-in?

Afterimage burn-in should not occur when the LCD panel is operating normally. Normal operation refers to a continuously changing video pattern. If the LCD panel displays a fixed pattern for an extended period of time (more than 12 hours), a slight voltage difference may occur between the electrodes in pixels that control the liquid crystals.

Such a voltage difference between electrodes increases with time and makes the liquid crystals thinner. When this occurs, a previous image can remain on the screen when the pattern changes. To prevent this, the accumulated voltage difference should be reduced.

— Afterimage burn-in should not occur when an LCD panel is operating in proper conditions.

## Preventing afterimage burn-in

— The best way to protect the product from afterimage burn-in is switching the power off or setting the PC or system to run a screen saver when not in use. Also, Warranty service may be limited depending on instruction guide.

- Powering Off, Screen Saver and Power Saving Mode
  - Power off the product for 4 hours after using it for 20 hours.
  - Power off the product for 2 hours after using it for 12 hours.
  - Go to Display Properties > Power Supply on your PC and set the product to power off as required.
  - Using a screen saver is recommended.
    - It is best to use a single-color or moving-image screen saver.
- Regular color Change
  - Use 2 colors
  - Switch between 2 colors every 30 minutes as shown above.

Type 1

FLIGHT	TIME
OZ348	20:30
UA102	21:10

Type 2

FLIGHT	TIME
OZ348	20:30
UA102	21:10



\*Brightness: refers to the lightness or darkness of a color which varies depending on the amount of light emitted.

- Avoid combinations of a text color and background color of contrasting brightness.
- Avoid using grey as it may contribute to afterimage burn-in.
- Avoid using colors of contrasting brightness (black and white; grey).



- Regular Text color Change
  - Use bright colors of similar brightness.
  - Interval: Change text color and background color every 30 minutes



- Move and change text every 30 minutes as shown below.



- Regularly display a moving image along with a logo.
- Interval: Display a moving image along with a logo for 60 seconds after using for 4 hours.



---

## License



Manufactured under license from Dolby Laboratories.  
Dolby and the double-D symbol are trademarks of Dolby Laboratories.

---



Manufactured under a license from U.S. Patent No's: 5,956,674, 5,974,380, 5,978,762, 6,487,535, 6,226,616, 7,212,872, 7,003,467, 7,272,567, 7,668,723, 7,392,195, 7,930,184, 7,333,929 and 7,548,853. DTS, the Symbol, and DTS and the Symbol together are registered trademarks & DTS Premium Sound | 5.1 is a trademark of DTS, Inc. ©2012 DTS, Inc. All Rights Reserved.

---



The terms HDMI and HDMI High-Definition Multimedia Interface, and the HDMI Logo are trademarks or registered trademarks of HDMI Licensing LLC in the United States and other countries.

---



DivX Certified® to play DivX® video up to HD 1080p, including premium content.

DivX®, DivX Certified® and associated logos are trademarks of DivX, Inc. and are used under license.

---

ABOUT DIVX VIDEO: DivX® is a digital video format created by DivX, Inc. This is an official DivX Certified® device that plays DivX video. Visit [www.divx.com](http://www.divx.com) for more information and software tools to convert your files into DivX video.

ABOUT DIVX VIDEO-ON-DEMAND: This DivX Certified® device must be registered in order to play purchased DivX Video-on-Demand (VOD) movies. To obtain your registration code, locate the DivX VOD section in your device setup menu. Go to [vod.divx.com](http://vod.divx.com) for more information on how to complete your registration.

Covered by one or more of the following U.S. patents: 7,295,673; 7,460,668; 7,515,710; 7,519,274

---

### Open Source Licence Notice

In the case of using open source software, Open Source Licences are available on the product menu. Open Source Licence Notice is written only English.

---

---

## Terminology

### **480i / 480p / 720p / 1080i /**

**1080p**\_\_\_\_\_ Each of the scanning rates above refers to the number of effective scanning lines that decides the screen resolution. The scanning rate may be indicated in i (interlaced) or p (progressive), depending on the scanning method.

#### - Scanning

Scanning refers to a process of sending pixels that form an image progressively. A larger number of pixels will deliver a clearer and more vivid picture.

#### - Progressive

In progressive scan mode, all lines of pixels are scanned one by one (progressively) on the screen.

#### - Interlaced

In interlaced scan mode, every other line of pixels is scanned from top to bottom first and then the remaining lines of pixels (that were not scanned) are scanned.

### **Non-interlace Mode and Interlace Mode**\_\_\_\_\_

Non-interlace mode (progressive scan) displays a horizontal line from the top to the bottom of a screen progressively. Interlace mode displays the odd number lines first and the even number lines next. Non-interlace mode is mainly used in monitors as it produces screen clarity and interlace mode is mainly used in TVs.

### **Dot Pitch**\_\_\_\_\_

The product and screen consist of red, green and blue dots. A shorter distance between the dots produces a higher resolution. Dot pitch refers to the distance between the shortest distance between dots of the same color. Dot pitch is measured in millimeters.

**Vertical Frequency**\_\_\_\_\_ The product displays a single image many times per second (like a fluorescent light that flickers) to display an image for a viewer to see. The rate of a single image being displayed repeatedly per second is called vertical frequency or refresh rate. Vertical frequency is measured in Hz. E.g. 60Hz refers to a single image being displayed 60 times in one second.

**Horizontal Frequency**\_\_\_\_\_ The time required to scan a single line from the left to the right side of the screen is called a horizontal cycle. The reciprocal number of a horizontal cycle is called horizontal frequency. Horizontal frequency is measured in kHz.

**Source**\_\_\_\_\_ Input source refers to a video source device connected to the product such as a camcorder or video or DVD player.

**Component ports (green, blue and red)**\_\_\_\_\_ The component ports, which identify, transmit and receive contrast signals, provide superior picture quality to any other video connection methods.

**Plug & Play**\_\_\_\_\_ Plug & Play is a function that allows the automatic exchange of information between a monitor and PC to produce an optimum display environment. The product uses VESA DDC (international standard) to execute Plug & Play.

**Resolution**\_\_\_\_\_ Resolution is the number of horizontal dots (pixels) and vertical dots (pixels) that form a screen. It represents the level of display detail. A higher resolution enables more data to be displayed on the screen and is useful to perform multiple tasks simultaneously.  
E.g. A resolution of 1920 X 1080 consists of 1,920 horizontal pixels (horizontal resolution) and 1,080 vertical pixels (vertical resolution).

**DVD (Digital Versatile Disc)**\_\_\_\_\_ DVD refers to a CD-sized mass storage disk where you can save multimedia (audio, video or game) applications using MPEG-2 video compression technology.

**HDMI (High Definition Multimedia Interface)**\_\_\_\_\_ It is an interface that can be connected to a digital audio source as well as a high-definition video source by using a single cable without compression.

**Multiple Display Control (MDC)**\_\_\_\_\_ MDC (Multiple Display Control) is an application that allows multiple display devices to be controlled simultaneously using a PC. Communication between a PC and monitor takes place using RS232C (serial data transmission) and RJ45 (LAN) cables.