

SAMSUNG

Premium Security



Digital Video Recorder SVR-1650E/1640A/950E User's Manual

Thank you for purchasing a Samsung Digital Video Recorder.
Before attempting to connect or operate this product,
please read these instructions carefully and save this manual for future use.

ENGLISH

Introduction

Thank you for purchasing the SVR-1650E/1640A/950E.

This is a user manual for SVR-1650E/1640A/950E. Before product installation and operation, please become thoroughly familiar with this user manual and other manuals referenced by this manual.

This user manual and the software and hardware described here are protected by the copyright law. Therefore, with the exception of copying for general use within the copyright law, copying and reprinting the user manual, either partially or in its entirety, or translating it into another language without the consent of Samsung Techwin, Inc. is prohibited.

This specification may be changed without prior notice for improvement of product performance.

Product warranty and limits of responsibility

The manufacturer does not assume any other responsibility concerning the sale of this product and does not delegate any right to a third party to take any responsibility on its behalf. Product warranty does not cover cases of accidents, negligence, alteration, misuse or abuse. In addition, no warranty is offered for any attachments or parts not supplied by the manufacturer.

The warranty period for this product will be for 2 years from the date of purchase. The following cases are not covered by the warranty and payment is required for repairs.

- ❖ Malfunction due to negligence in handling by the user
- ❖ Deliberate disassembly and replacement by the user
- ❖ Connection of a power source other than a properly rated power source
- ❖ Malfunction caused by natural disasters (fire, flood, tidal wave, etc.)
- ❖ Replacement of expendable parts(HDD, FAN, etc.)

Warranty only refers to the warranty covering products that have been paid for.

After expiration of the warranty period (2 years), examination and repair will be provided for a fee. Even during the warranty period, repair and examination of items outside the preceding warranty scope will require a payment.

Please inquire at the point of purchase or the local service center for repairs requiring a payment.

This product is not for exclusive use of crime prevention but for assistance unit such as a fire or theft. Therefore, the manufacturer never take any responsibility for the damage from any incident.

※ This User Manual is made out on the basis of F/W version 2.8.

Table of Contents

Introduction	1
Product warranty and limits of responsibility	1
Chapter1. Safety Cautions	5
Symbols displayed for each item	5
Chapter2. Summary	8
2.1 Features	8
2.2 Components	11
2.3 Name and Function of Each Part.....	11
2.3.1 Front panel	11
2.3.2 Back connector terminals	14
2.3.3 Remote Controller.....	15
2.4 Product specification	16
Chapter3. Installation method	21
3.1 Overall connection.....	21
3.1.1 Front connection method	21
3.1.2 Back connection method	22
3.2 Detailed connection	23
3.2.1 Rack mount.....	23
3.2.2 Video/Audio connection.....	24
3.2.3 External connector	26
Chapter4. Operation method.....	34
4.1 Preoperation inspection items	34
4.2 Connection of power supply	34
4.3 Live screen	34
4.3.1 FUNCTION screen display	35
4.3.2 Single channel screen display.....	35
4.3.3 Multi screen display	36
4.4 Recording	37
4.4.1 General recording	37
4.4.2 Scheduled recording.....	37
4.5 Search	38

4.5.1 Time search	38
4.5.2 Event search	40
4.5.3 Log search.....	41
4.6 Recording file playback	41
4.6.1 Jog dial / shuttle ring.....	42
4.7 Live / Playback screen conversion	42
4.8 Digital zoom	44
4.9 Copy	44
4.9.1 SLiM Player	46
4.10 PTZ	48
4.10.1 PTZ adjustment	48
4.10.2 Preset setup.....	49
4.10.3 Preset utilization	49
4.10.4 Using OSD for the Speed Dome Camera.....	49
4.11 Quick setup	50
4.12 PIP	51
4.13 System information	52
4.14 SPOT.....	53

Chapter 5. Setup method..... 54

5.1 Menu organization	54
5.2 Initial value setup	56
5.3 Operation description.....	65
5.4 FUNCTION menu	66
5.4.1 LIVE/PLAY mode	66
5.4.2 FUNCTION operation description.....	66
5.5 Menu screen description.....	70
5.6 Screen setup.....	71
5.6.1 Screen.....	71
5.6.2 Sequencing.....	72
5.6.3 Display.....	75
5.6.4 Covert.....	76
5.6.5 SPOT	76
5.7 Record setup	77
5.7.1 Record mode.....	77
5.7.2 Record program.....	79
5.7.3 Recording time table	80
5.8 Event setup.....	82
5.8.1 Event	82
5.8.2 Motion detection.....	83

5.8.3 Relay	84
5.8.4 TEXT	84
5.8.5 EVENT-PRESET	85
5.9 Communication setup	86
5.9.1 NETWORK	86
5.9.2 RS-232.....	88
5.9.3 RS-422/485	89
5.9.4 E-MAIL.....	90
5.9.5 DDNS.....	91
5.9.6 DDNS Registration.....	92
5.10 System setup.....	96
5.10.1 System	96
5.10.2 HDD.....	99
5.10.3 Password	100
5.10.4 Date setup.....	102
5.10.5 PTZ.....	103
5.11 Video recording search.....	104
5.11.1 Time search	104
5.11.2 Event search.....	105
5.11.3 Log search.....	106
5.12 Copy	107
5.13 Exit	108

Chapter 6. Troubleshooting.....109

Product Specifications	111
------------------------------	-----



For more information on network manager program, please see network manager quick guide and manual file enclosed with CD.

Chapter1. Safety Cautions

Symbols displayed for each item



Warning

Refers to information users need to know in order to prevent serious injury or death.



Caution

Provides information users need to know in order to prevent minor injury or product damage.



❖ Before installation

- ✓ Verify the supplied voltage (AC100V~AC240V) before connecting the power supply.
- ✓ Make sure the power supply is off before installation.
- ✓ Do not install in a very humid environment. Doing so may cause an electric shock or fire.
- ✓ Make sure ground line is connected to reduce electric shock risk.

❖ During operation

- ✓ Do not open the product cover except qualified personnel or system installer. Opening the product cover may cause an electric shock.
- ✓ Do not plug multiple appliances into one power outlet. Doing so may cause fire.
- ✓ Do not place dishes containing water or heavy objects on the product. Doing so may cause a malfunction.
- ✓ Do not use in areas containing inflammable materials like propane gas and gasoline or in areas that generate dust. Doing so may cause an explosion or fire.
- ✓ Do not touch the power line with a wet hand. Doing so may cause an electric shock.
- ✓ Do not insert a hand into the opening of the DVD. Doing so may cause an injury.
- ✓ Make sure conduction materials do not enter the cooling ventilator opening.

- ✓ Do not apply excessive force when pulling on the power cord. Damaging the cord may cause an electric shock or fire.
- ✓ Random replacement of built-in battery by other types of batteries may cause explosion.
- ✓ The battery shall be replaced by the same battery.
- ✓ The used batteries shall be disposed carefully because they can cause environment pollutions.

❖ Dismantling and cleaning

- ✓ Do not dismantle, repair or modify the product deliberately. Doing so may cause a damage, an electric shock or an injury.
- ✓ Do not use water, thinner or organic solvent for cleaning the product exterior. Doing so may cause a malfunction or an electric shock. Use a dry cloth to clean the exterior.



❖ During installation

- ✓ To get adequate ventilation, install the product with at least 15cm of space between the cooling ventilation opening and a wall.
- ✓ To prevent falling, install the product in a flat area . Dropping the product may cause an injury or a malfunction.
- ✓ Avoid areas exposed to sun light or heat since they may cause deformation or a malfunction.
- ✓ If a camera is installed while the DVR is recording, image in another channel may be disrupted. Start the storage after installing the camera is recommended.

❖ During use

- ✓ Make sure the product is not exposed to shocks or shaking when using the product or during moving.
- ✓ Do not move the product while it is in operation, and apply strong shocks to the product or throw the product.
- ✓ If hard disk drives other than those recommended are used additionally, abnormal operation may occur. Inquire at the point of purchase of the product before installing such a hard disk drive.
- ✓ Product warranty will not cover deliberate additional use of such hard disk drives.
- ✓ This product is a supplementary rather than primary means for preventing fire and theft. Our company is not responsible for incidence of incident or damage that may occur.

FCC Compliance Statement

Caution : Any changes or modification in construction of this device which are not expressly approved the party responsible for compliance could void the user's authority to operate the equipment.

NOTE : This equipment has been tested and found to comply with the limits for a Class A digital device, pursuant to part 15 of the FCC Rules. These limits are designed to provide reasonable protection against harmful interference when the equipment is operated in a commercial environment. This equipment generates, uses, and can radiate radio frequency energy and, if not installed and used in accordance with the instruction manual, may cause harmful interference to radio communications. Operation of this equipment in a residential area is likely to cause harmful interference in which cause the user will be required to correct the interference at his own expense.

1

Safety cautions

Correct Disposal of This Product (Waste Electrical & Electronic Equipment)



(Applicable in the European Union and other European countries with separate collection systems) This marking shown on the product or its literature, indicates that it should not be disposed with other household wastes at the end of its working life. To prevent possible harm to the environment or human health from uncontrolled waste disposal, please separate this from other types of wastes and recycle it responsibly to promote the sustainable reuse of material resources. Household users should contact either the retailer where they purchased this product, or their local government office, for details of where and how they can take this item for environmentally safe recycling. Business users should contact their supplier and check the terms and conditions of the purchase contract. This product should not be mixed with other commercial wastes for disposal.



Samsung Techwin cares for the environment at all product manufacturing stages to preserve the environment, and is taking a number of steps to provide customers with more environment-friendly products. The Eco mark represents Samsung Techwin's will to create environment-friendly products, and indicates that the product satisfies the EU RoHS Directive.

Chapter 2. Summary

This product is a digital video recorder that digitizes 16 channels of video input and stores it in the built-in hard disk drive. Product functions can be setup conveniently using the mouse and buttons on the front panel.

Samsung SVR-1650E/1640E/1640A/950E is a digital image recorder that can be used as security equipment in banks, apartments, and government and public offices. It is a stand-alone product with proven performance and stability. Since a hard disk drive is used for storage instead of a video tape, high quality can be maintained for even repetitive recordings and fast retrieval of digital files is also possible. This is a user friendly digital device with a diverse array of functions including a high quality video, a large capacity storage, perfect simultaneous implementation of recording/playback/backup functions, motion detection, PTZ (Pan, Tilt, Zoom) control function, password setup, real time voice data storage, an event list with up to 10,000 events and log file storage.

2.1 Features

Monitoring Screen

Vivid live video with high image quality is realized and various observation screens are provided for each channel.

- ❖ Implementation of real time MPEG-4 video
 - NTSC : 480 frames(SVR-1650E/1640A)/270 frames(SVR-950E)
 - PAL : 400 frames(SVR-1650E/1640A)/225 frames(SVR-950E)
- ❖ Various observation screen modes:
 - SVR-1650E/1640A : Single, 4 DIVISION, 9 DIVISION, 16 DIVISION
 - SVR-950E : Single, 4 DIVISION, 9 DIVISION
- ❖ Automatic screen conversion (AUTO)
- ❖ Various monitor output supported [3 Composite (including 1 Spot), 1 VGA, 1 RCA]
- ❖ Pan, Tilt, Digital Zoom, PIP(Picture in Picture; view screen within a screen)

Voice recording

Real time voice input and recording function is provided.

- ❖ Real time, simultaneous recording of 4 channels voice input possible (1, 2, 3, 4 channel fixed)
- ❖ Input: 4 channels (4 back side), Output: 2 (1 back side/ 1 front side)
- ❖ Simultaneous recording and playback is possible

Video recording

High image quality MPEG4 video recording is possible. Up to 480 frames(SVR-1650E)/120 frames(SVR-1640A/950E) per second of recorded video can be stored and pre-event recording can be done for up to 5 seconds before an event occurs. In addition, privacy is protected by the COVERT (image hiding) function.

- ❖ MPEG-4 video recording with high image quality
- ❖ 4 steps video recording resolution setup to adjust storage capacity
- ❖ Multiple recordings possible for manual & events or schedule & events
- ❖ Simultaneous execution of the following 4 functions: recording/playback/backup/network.
- ❖ Easy setup of video recording resolution and motion detection for each channel.
- ❖ Video recording setup of up to 480(NTSC : SVR-1650E)/120(NTSC :SVR-1640A/950E) or 400(PAL : SVR-1650E)/100(PAL : SVR-1640A/950E) frames per second possible (352×240 or 352×288(CIF) based),
- ❖ Manual and scheduled recording possible
- ❖ Video loss detection function
- ❖ Record events(sensor, video loss, motion detection and text) in the event list
- ❖ Up to 5 seconds of pre-alarm event recording for each channel possible

Search/Playback

A wide range of convenient functions for search and playback are provided.

- ❖ Playback by time, by date, by channel
- ❖ Convenient search using the mouse
- ❖ Still image step up/down playback
- ❖ Playback based on EVENT(sensor, video loss, motion detection and text) list
- ❖ Easy search using the remote controller and jog/shuttle
- ❖ Digital zoom in playback screen

Storage device

A built-in hard disk drive is provided. User may also select to use DVD±RW, CD-RW and USB memory for backup.

- ❖ Standard storage: Built-in hard disk drive
- ❖ Various backup devices available: DVD±RW, DVD±R, CD-RW, CD-R and USB memory
- ❖ HDD Extension Unit (external extendable storage device) : SVS-5 (Sold separately as a designated device)

Network

Various networks including LAN, xDSL is supported. Key functions of the product may be manipulated easily and maintained remotely using the dedicated viewer for PC.

- ❖ If an EVENT occurs, transmit by E-mail through TCP/IP, DHCP
- ❖ Live image viewing from a remote location is possible (entire or 4 DIVISION screen selection is possible)
- ❖ PC playback, storage, search function and DVR control function using the network viewer is possible
- ❖ Search and playback by time or by event from a remote location is possible
- ❖ 10/100Mbps Ethernet/xDSL support
- ❖ Multiple DVR connection

Others

- ❖ GUI and mouse for user convenience
- ❖ Convenient firmware upgrade function using USB memory
- ❖ PTZ CONTROL (SPEED DOME), PRE-SET support
- ❖ Multiple language support: Korean, English, Italian, Spanish, Japanese, etc.
- ❖ Video recorded image backup function (still images/video) using the USB port
- ❖ 16 DVRs may be controlled conveniently using one remote controller

2.2 Components

DVR package contains the main body and the following accessories. Please verify whether all accessories are included at the time of purchase. If any accessory is missing, inquire at the point of purchase.

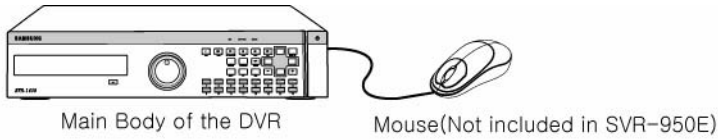

1. Program CD



2. DVR / Network Viewer Quick Guide



3. User Manual Guide



4. Remote controller



5. Cablecore

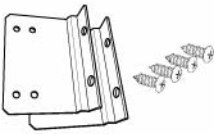

6. Rack mount, Screw

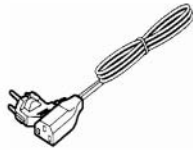

7. Power Supply Cable



8. RJ-45 Cable



9. D-SUB 25P Connector (Male)

2.3 Name and Function of Each Part

2.3.1 Front panel

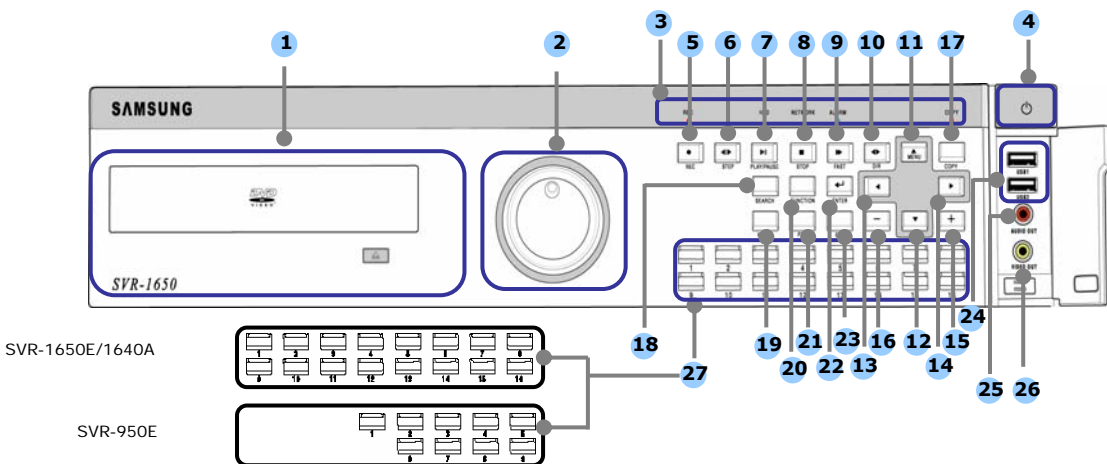

Backup(Copy) section

Category	Function
1. DVD-Multi : DVR for backup	Used to backup recorded/stored images on DVD/CD media.

Jog/shuttle section

Category	Function
2. JOG/SHUTTLE	Menu setup values can be adjusted and STEP function can be controlled with JOG. SHUTTLE can be used for moving items between menus, increasing or decreasing playback speed, changing playback direction and for controlling PTZ.

Display section

	Category	Function
3.	REC display LED	Indicates whether recording is in progress.
	HDD display LED	Indicates whether hard disk drive is in operation.
	NETWORK display LED	Indicates whether network is in connection.
	ALARM display LED	Indicates whether event is in detection.
	COPY display LED	Indicates whether COPY is in progress.

Power supply section

Category	Function
4. Stand-by button	Turn product ON or OFF.

Playback and recording section

Category	Function
5. REC	Start or stop the manual mode video recording.
6. STEP	Start 1 Frame playback.
7. PLAY/PAUSE	Start playback or pause momentarily.
8. STOP	Stop playback and return to live screen mode.
9. FAST	Playback is carried out faster than the normal playback speed.
10. DIR	Used to change the playback direction.

Function button section

Category	Function	
MENU	11. ▲	Used for movement in the upper direction.
	12. ▼	Used for movement in the lower direction.
	13. ◀	Used for movement to the left
	14. ▶	Used for movement to the right
15. +	Used to increase value to be setup or move to another page.	
16. -	Used to decrease value to be setup or move to another page.	
17. COPY	Display the copy menu. Store data in DVD/CD and USB Memory Stick at the preset time.	
18. SEARCH	Select data search mode.	
19. MULTI	Convert to a divided screen.	
20. FUNCTION	Display the LIVE screen menu for FUNCTION.	
21. PTZ	Select PTZ mode.	
22. ENTER	Store or execute the select options.	
23. ESC.	Return to the previous stage menu.	

USB, Audio/Video section

Category	Function
24. USB1, USB2, USB3	Connection port for mouse, USB Memory Stick and DVD+RW
25. AUDIO OUT	Output port for connecting speaker.
26. VIDEO OUT	Output port to connect TV monitor.

Channel button section

Category	Function
27. CH1~16(SVR-1650E/1640A) / CH1 ~ 9 (SVR-950E)	Display selection button of each channel (Live/Playback), Select single mode and PIP channel.

2.3.2 Back connector terminals

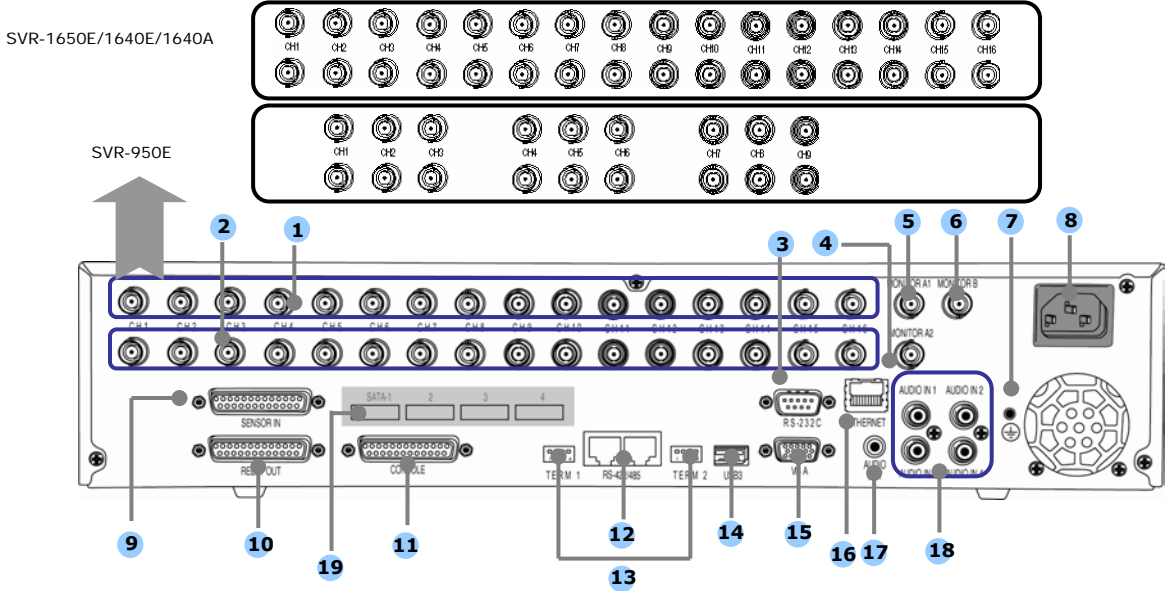

No.	I/O terminal names	Function
1	CH1~16 (SVR-950E: CH1~9)	BNC input connector terminal for the camera.
2	LOOP OUT	BNC output (loop) connector terminal for the camera.
3	RS-232C	RS-232C terminal.
4	MONITOR A2	BNC connector terminal for monitor output.
5	MONITOR A1	BNC connector terminal for monitor output.
6	MONITOR B	BNC connector terminal for SPOT monitor output.
7	GROUND	Ground terminal for DVR main body and external equipment.
8	POWER IN	Socket for AC100V ~ AC240V power supply cord.
9	SENSOR IN	Input terminal for external alarm sensor.
10	RELAY OUT	Relay output terminal.
11	CONSOLE	SVR-1650E/1640A : Auxiliary port SVR-950E : Terminal for ATM/POS
12	RS-485/422	Terminal to connect expansion controller, speed dome camera, SRX-100B connector.
13	TERMINATION	Switch for RS-485 termination resistor setup.
14	USB	Terminal to connect external equipment (DVD+RW, CD-RW, etc.).
15	VGA OUTPUT	Output port to connect the PC monitor.
16	ETHERNET(Main)	LAN connection terminal.
17	AUDIO OUT	Terminal for speaker output.
18	AUDIO IN	Terminal for microscope input.
19	SATA1~4	This is a connection terminal for HDD Extension Unit



Refer to 'Chapter 3. Installation method' and 'Chapter 4. Operation method' for detailed description about setup and utilization.



If you make a connection to ATM/POS or HDD Extension Unit, please refer to the manual.

2.3.3 Remote Controller

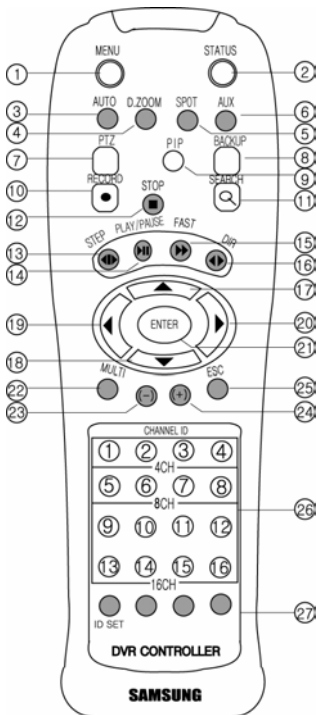

Button names	Function
1. MENU	Menu screen conversion
2. STATUS	System setup information display
3. AUTO	Automatic screen conversion
4. D.ZOOM	Digital zoom execution
5. SPOT	SPOT monitor screen conversion
6. AUX	Auxiliary
7. PTZ	PTZ mode conversion
8. COPY	Copy menu display, store the image through USB
9. PIP	View picture in picture
10. RECORD(●)	Start or stop general video recording
11. SEARCH(🔍)	Search menu display
12. STOP(■)	Cancel playback mode
13. STEP(◀▶)	Playback 1 frame
14. PLAY/PAUSE(▶)	Playback and pause
15. FAST(▶▶)	High speed playback
16. DIR(◀▶)	Change playback direction (forward direction or reverse direction)
17. (▲)	Move cursor up in the setup menu
18. (▼)	Move cursor down in the setup menu
19. (◀)	Move cursor to the left in the setup menu
20. (▶)	Move cursor to the right in the setup menu
21. ENTER	Setup value selection, execution
22. MULTI	Divided screen selection
23. (-)	Reduce setup value, move to another page.
24. (+)	Increase setup value, move to another page.
25. ESC	Cancel the setup, exit the menu
26. Channel button	Camera channel selection
27. Remote controller ID	Remote controller ID selection

2.4 Product specification

Video

Items	Specification
Input method	Composite input 16 channels (SVR-1650E/1640A) / 9 channels(SVR-950E)
Video input level	1.0 V _{p-p} , composite
Live screen presentation speed	NTSC - SVR-1650E/1640A : 480 frames/sec - SVR-950E : 270 frames/sec PAL - SVR-1650E/1640A : 400 frames/sec - SVR-950E : 225 frames/sec
Live screen resolution	NTSC : 720(horizontal) × 480(vertical) pixels, if entire screen selected PAL : 720(horizontal) × 576(vertical) pixels, if entire screen selected
Monitor output	1.0V _{p-p} Composite, 75Ω output Back : 2 terminals(BNC : composite), 1 terminal(BNC : SPOT composite) Front : 1 terminal(RCA : composite) Loop(BNC) 16 CH(SVR-1650E/1640A) / 9CH(SVR-950E) output
VGA output (PC monitor)	RGB output
PIP screen	PIP screen size: 240×160(Fixed on left top side) PIP screen organization: Small live screen inside the live entire screen

Audio

Items	Specification
Audio	4 channel audio input
Line input level	1.0V / 20kΩ
Line output level	1.0V / 1kΩ
Storage method	PCM method

Electric Specification

Items	Specification
Power supply	AC 100V ~ 240V, (50/60Hz), Max, 2A
Power consumption	About 75W (if one hard disk drive used)

Connector terminals

Items	Specification
Video input	BNC(SVR-1650E/1640A: 16, SVR-950E: 9)
Loop output	BNC(SVR-1650E/1640A: 16, SVR-950E: 9)
Monitor output	BNC(2), RCA(Front 1)
SPOT Monitor output	BNC(1)
VGA output (PC monitor)	15 pin VGA
Audio	RCA input (4), RCA output (2 - including the front)
25 pin DSUB(2)	Sensor input (SVR-1650E/1640A: 16, SVR-950E: 9), relay output(4)
Dual RJ-45	RS-422/485(2)
9 pin DSUB	RS-232C(1)
USB port	Front (2), back (1)
RJ-45	Network (Ethernet)-10/100M bps supported
SATA output	HDD Extension Unit (external extendable storage device) connection terminal (4 units)

Alarm

Items	Specification
Input	16 channels(SVR-1650E/1640A) / 9channels(SVR-950E)
Output	4 relay outputs(video loss, power off, motion detection, sensor) user setup possible

Operation environment

Items	Specification
Operating temperature	5°C ~ 40°C
Storage temperature	-10°C ~ 60°C
Humidity	30% ~ 90%

Exterior appearance

Items	Specification
Material	Metal case, Front(aluminum, plastic)
Dimensions	430(width) × 465(length) × 88(height) mm
Weight	About 8.9kg(1 HDD)

Controller

Item	Specification
Remote controller	Infrared LED(Max. 5m)
Mouse(USB)	Menu setup and DVR setup handling possible
Dedicated controller	SCC-3100A(RS-485)

Hard disk drive

Items	Specification
Max. no. of mounts	4
Basic mount	1 (built-in)
Hard disk drive type	EIDE(ULTRA DMA-133)
Min. speed	7200rpm
Recommended product	Seagate series, Maxtor series, Samsung Electronics



The recommended models are as follows.

Manufacturer	HDD capacity	Buffer	Interface
Seagate	250G	8M	PATA
Seagate	500G	16M	PATA
Seagate	160G	2M	PATA

※ If other products are used, HDD operation error may occur.

※ Please, refer to the manual HDD Extension Unit (external extendable storage device) if you wish to use a Hard Disk.

Video recording

Items	Specification	
	SVR-1650E	SVR-1640A/950E
Compression method	MPEG-4	
Video recording method	2 video recording modes: schedule & event, manual & event	
Maximum number of frames per second (resolution)	NTSC(704×480) : 120 frames/sec NTSC(704×240) : 240 fields/sec NTSC(352×240) : 480 fields/sec PAL(704×576) : 100 frames/sec PAL(704×288) : 200 fields/sec PAL(352×288) : 400 fields/sec	30 frames/sec 60 fields/sec 120fields/sec 25 frames/sec 50 fields/sec 100 fields/sec
Picture quality	4 levels of picture quality: User setup possible (SUPER, HIGH, MID, LOW)	
Pre Alarm	Setup possible within maximum 5 seconds	
Post Alarm	Setup possible within maximum 5 minuets	



Countries using NTSC : USA, Canada, Japan, Korea, Taiwan, Mexico, etc.

Countries using PAL : Australia, Austria, Belgium, China, Denmark, Finland, Germany, England, Nederland, Italy, Kuwait, Malaysia, New Zealand, Singapore, Spain, Sweden, Switzerland, Thailand, Norway, etc.

Copy

Item	Specification
Digital copy	DVD±RW, DVD±R, CD-RW, CD-R and External USB memory



DVD±RW, DVD±R, CD-RW and CD-R media may be used.

Search and playback

Item	Specification
Search mode	Search by time : year, month, day, hour, minute, second Search by channel : For each channel Search by event : sensor, motion detection, video loss and text
Log file	Power ON/OFF, video recording start/stop, display miscellaneous information
Event item	Alarm, motion detection, video loss
Playback speed and direction	Forward direction, reverse direction
High speed search	Fast forward (×2, ×4, ×8, Max), reverse(×2, ×4, ×8, MAX)
Pause and frame playback	Playback screen pause function, function to reproduce one frame at a time from the paused state

Password

Item	Specification
2 stage password	8 digit numeric code Admin: Control all functions User: Connect through the network

Network

Items	Specification
General	Compression method : MPEG-4 Connection method: Dedicated viewer Supported protocols: TCP/IP, DHCP Supported interfaces: Ethernet(10M/100M bps), xDSL
PC requirements	CPU: Pentium IV 3.0GHz or higher (Hyper Threading recommended) Memory: Over 512MB recommended Video Card : Memory over 128MB recommended Hard Disk : Size larger than 120GB is recommended OS: Windows 2000 or higher versions recommended Monitor: Over 1,024×768 pixels(1280×1024 recommended) LAN interface: 10/100 Base-T Network card

Accessories

Item	Specification
Supplied accessories	Network viewer program CD User manual Quick guide manual Remote controller Mouse (Not included in SVR-950E) Cable core RJ-45 cable (2 cable) Rack mount and screw D-Sub 25p Connector (2 ea) Power supply cable

Chapter3. Installation method

3.1 Overall connection

3.1.1 Front connection method

Connection organization diagram for DVR front side terminals are as follows.

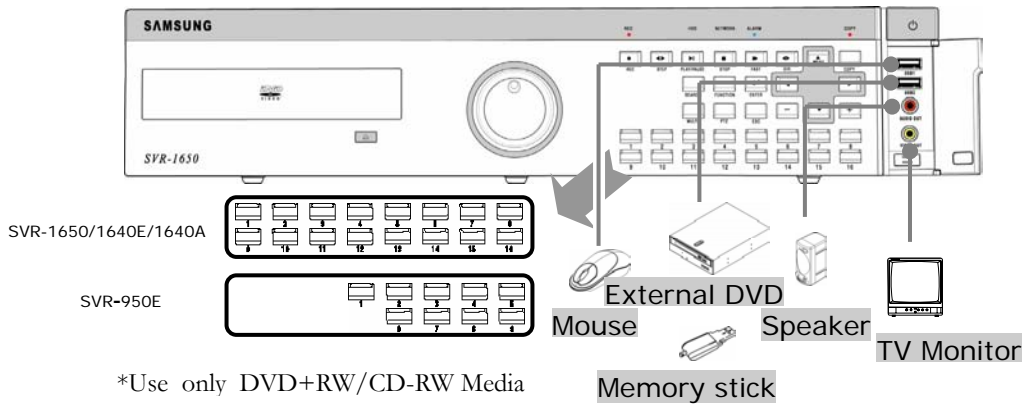

3.1.2 Back connection method

The organization chart for DVR and monitors, CCTV cameras and external devices is as follows.

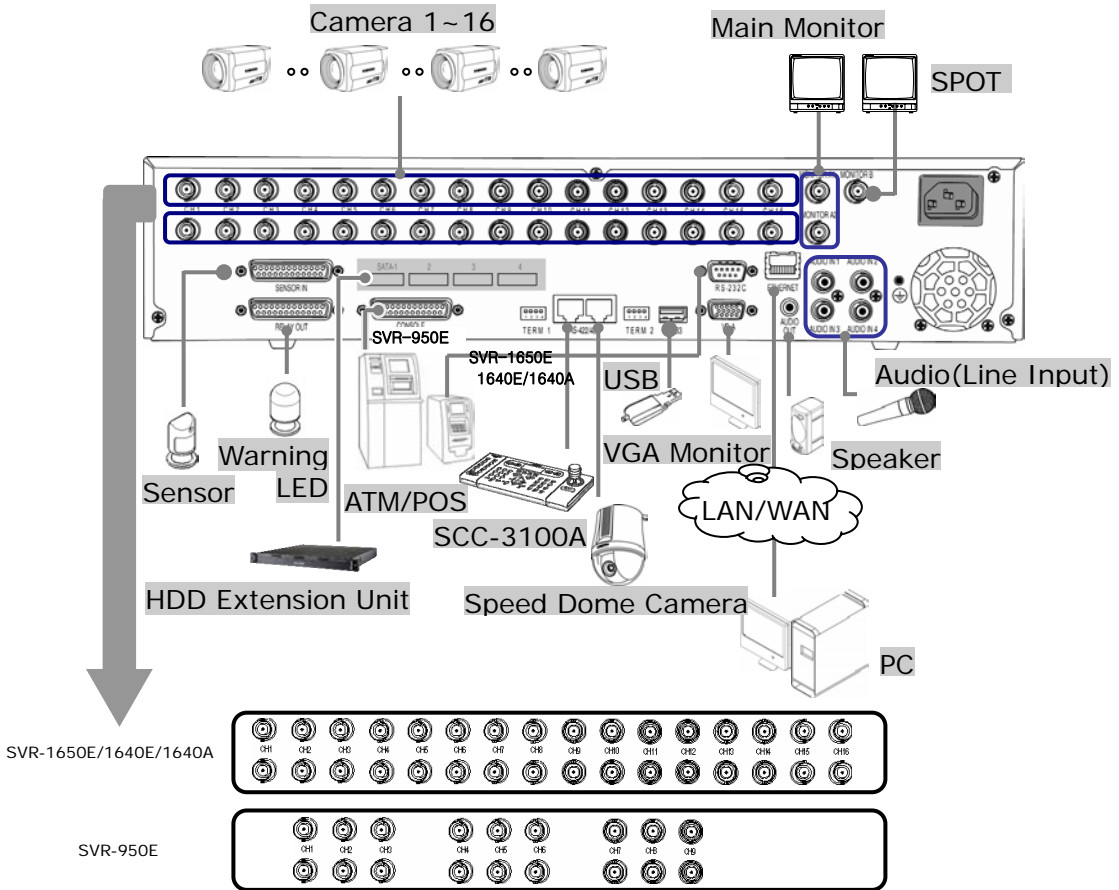

If you make a connection to ATM/POS, please refer to the manual.

3.2 Detailed connection

3.2.1 Rack mount

To mount the product, the enclosed rack must be mounted first. Mount sequence is as follows.

- ❖ The enclosed rack mount is mounted on the product.

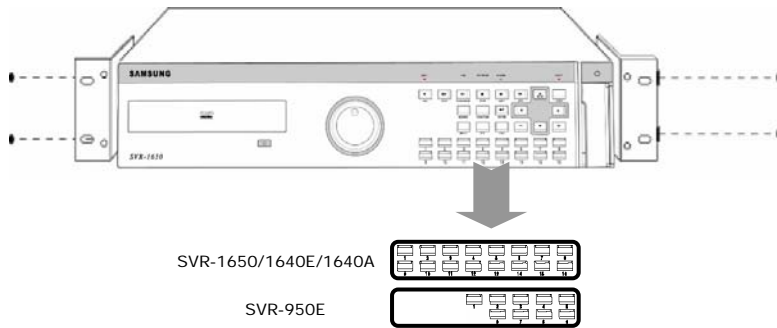

- ❖ The product is mounted on the 19 inch rack.

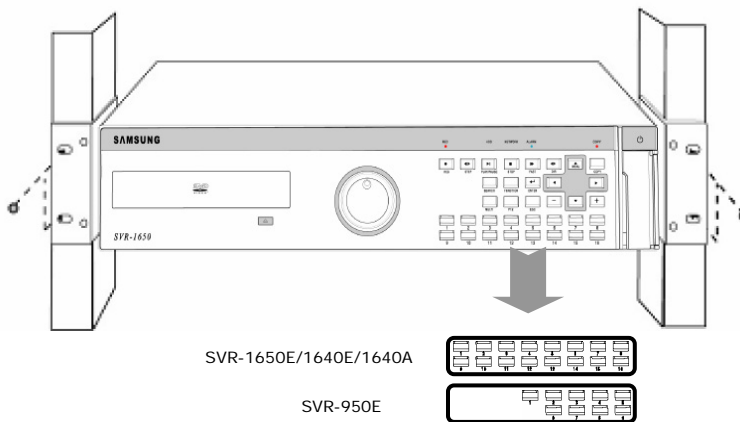

3.2.2 Video/Audio connection

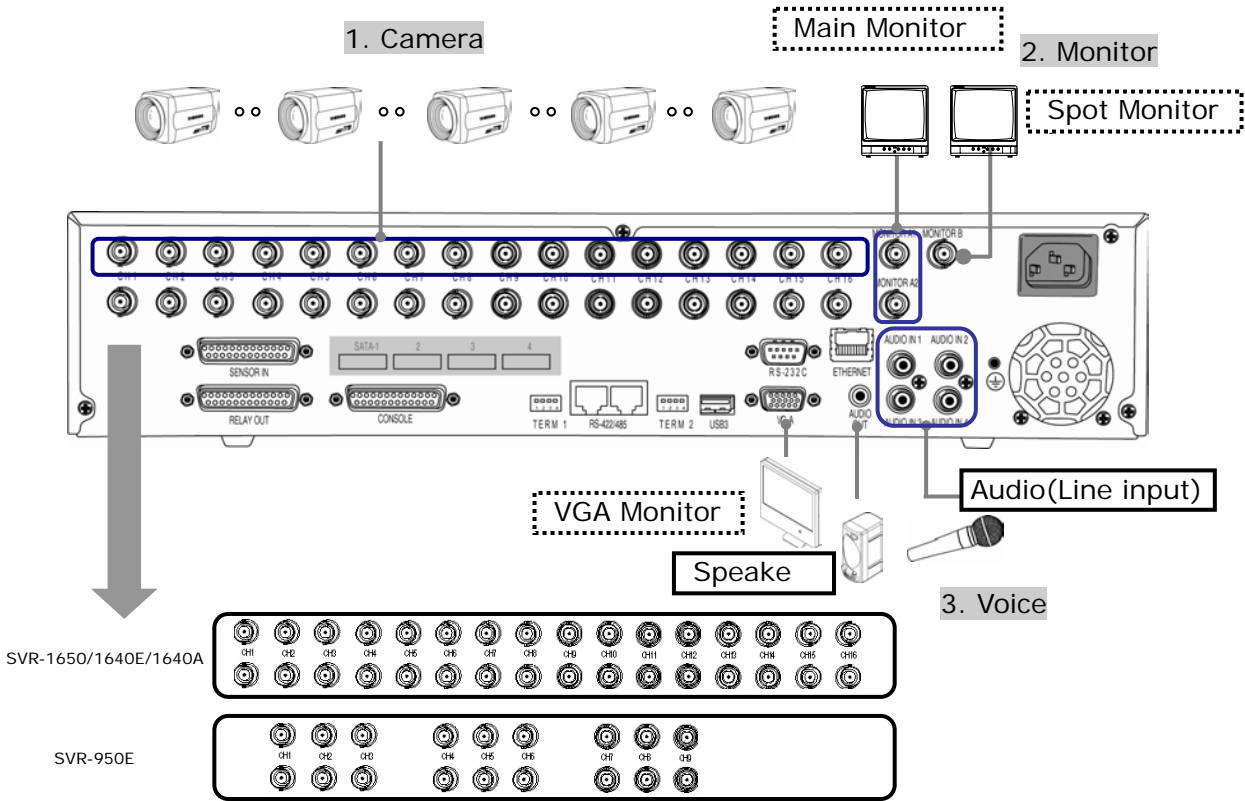

1. Camera

Up to 16(SVR-950E: Up to 9) CCTV cameras can be connected to DVR.
 Connect the BNC terminal for each camera to the CAMERA IN terminal in the back of this product.



If BNC terminal is only connected to CAMERA IN, a 75Ω terminating resistor is setup internally.

If connected to both CAMERA IN and CAMERA OUT, the device receiving the output must setup a terminating resistor of 75Ω.

Since CAMERA OUT terminal is a loop output for the camera input, it should only be connected and used when there is an image input in CAMERA IN terminal.

If cable connected to the CAMERA OUT terminal is not connected to an external device and is left exposed, image quality may be adversely affected.

Input video system type (NTSC/PAL) is recognized automatically when the product power button is pushed. However, if a CCTV using a different system type is connected to a CAMERA IN terminal during product operation, the product must be turned OFF and ON again for proper automatic recognition of the input video system type .



Image input from each camera is output simultaneously to the external device connected to the MONITOR OUT terminal in the back of the product.

2. Monitor

To output screen information to the main monitor, connect the VGA terminal for monitor output in the back of the product and the monitor BNC terminal with a BNC cable. There are 5 monitor output terminals [BNC 3(SPOT 1), RCA 1, VGA 1) and up to 5 auxiliary monitors can be connected.



Monitor outputs are labeled A and B. If one monitor is used, it is connected to MONITOR A. MONITOR B is used to connect the SPOT monitor.

3. Voice connection

This product has a function to store input voice information. Appropriate devices must be connected to store or output voice information.

Voice input

Connect a RCA voice input terminal (like a line level input) to the AUDIO IN terminal in the back of the product.



To setup voice input, set [AUDIO] to ON in the record setup screen in the Setup menu. Refer to '5.7 Record setup' for details.

Four voice inputs are each synchronized 1:1 with CH1~CH4 and voice output is only possible in the single screen mode. In the multi screen mode, CH1 voice output is default. Voice is not output even during single mode double speed playback. In addition, on the network multi-screen, voice output is available when one of CH1~CH4 is selected.

Voice output

Connect a RCA voice output terminal (like a monitor with a speaker) to the AUDIO OUT terminal in the back and front of the product.

3.2.3 External connector

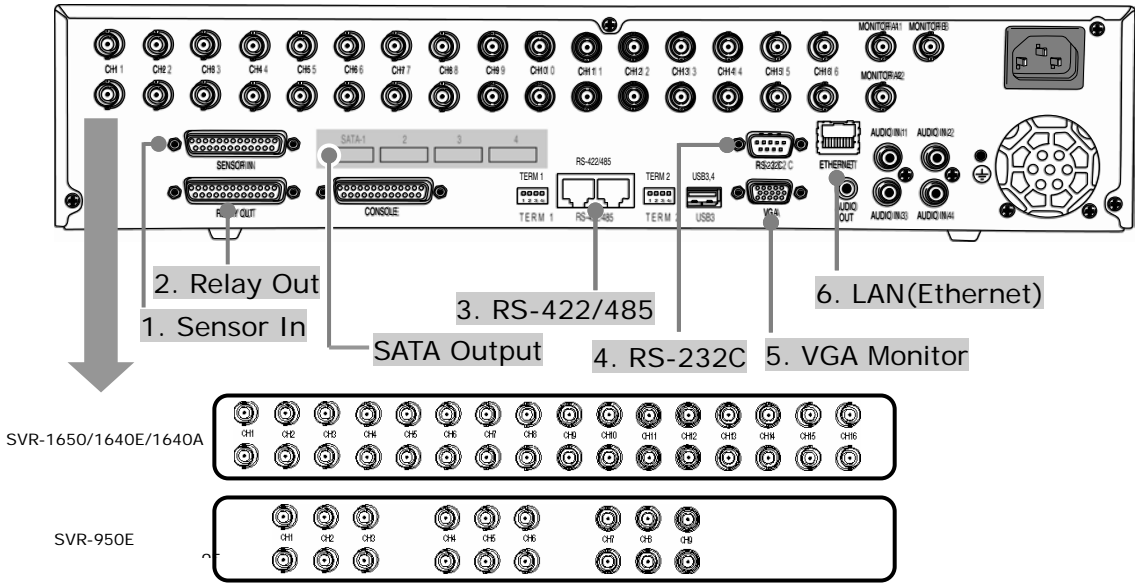

If you make a connection to HDD Extension Unit, please refer to the manual.

1. Sensor input (SENSOR IN)

This is an external sensor connection terminal used to input information from the connected sensors or devices to the product.

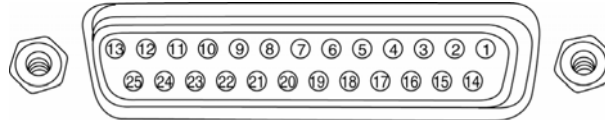

SENSOR IN

No.	Description		No.	Description	
1	S1	SENSOR 1	14	S14	SENSOR 14
2	S2	SENSOR 2	15	S15	SENSOR 15
3	S3	SENSOR 3	16	S16	SENSOR 16
4	S4	SENSOR 4	17	GND	Ground
5	S5	SENSOR 5	18	GND	Ground
6	S6	SENSOR 6	19	GND	Ground
7	S7	SENSOR 7	20	GND	Ground
8	S8	SENSOR 8	21	GND	Ground
9	S9	SENSOR 9	22	GND	Ground
10	S10	SENSOR 10	23	GND	Ground
11	S11	SENSOR 11	24	GND	Ground
12	S12	SENSOR 12	25	GND	Ground
13	S13	SENSOR 13			



Sensor input type can be setup in the Event setup screen in the Main menu. Refer to '5.8.1 Event setup' for details.

*** For SVR-950E, sensors 10 to 16 are not connected (NC)**

2. Relay output (RELAY OUT)

This is an alarm output terminal used to output alarms for sensor, motion detection, video loss and power OFF to external devices.

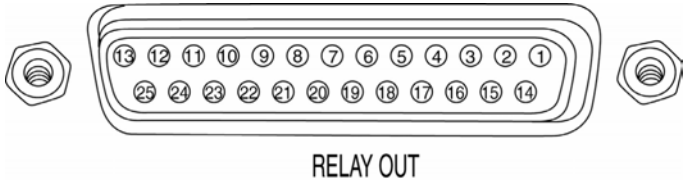

No.	Description		No.	Description	
1	NO1	Normal Open	14	D_IO 0	Digital I/O
2	CM1	Common	15	D_IO 1	Digital I/O
3	NC1	Normal Close	16	D_IO 2	Digital I/O
4	NO2	Normal Open	17	D_IO 3	Digital I/O
5	CM2	Common	18	D_IO 4	Digital I/O
6	NC2	Normal Close	19	D_IO 5	Digital I/O
7	NO3	Normal Open	20	D_IO 6	Digital I/O
8	CM3	Common	21	D_IO 7	Digital I/O
9	NC3	Normal Close	22	GND	Ground
10	NO4	Normal Open	23	GND	Ground
11	CM4	Common	24	GND	Ground
12	NC4	Normal Close	25	GND	Ground
13	GND	Ground			

 For operation of each relay output, refer to the main menu event setup in '5.8.3 Relay setup'.

3. External control equipment (RS-422/485)

This is a terminal for connecting external control equipment.
The switch labeled TERM is used to turn ON/OFF terminating resistance for RS-422/485 communication equipment.

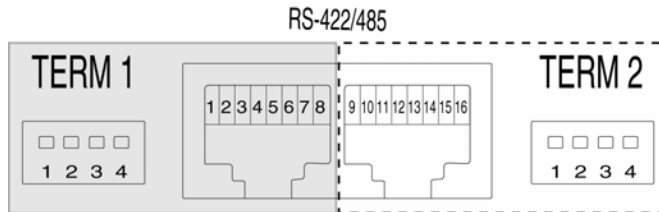

PORT	No.	RS-422	RS-485
PORT A (Controller SCC-3100A Control)	1	RX+ (+Data Receive)	Data+
	2	RX- (-Data Receive)	Data-
	3	N/C (Not connected)	N/C (Not connected)
	4	N/C (Not connected)	N/C (Not connected)
	5	GND(Ground)	GND(Ground)
	6	N/C (Not connected)	N/C (Not connected)
	7	Tx-(-Data Send)	Data-
	8	Tx+(+Data Send)	Data+
PORT B (Speed Dome Control)	9	Rx+(+Data Receive)	Data+
	10	Rx-(-Data Receive)	Data-
	11	N/C (Not connected)	N/C (Not connected)
	12	N/C (Not connected)	N/C (Not connected)
	13	GND(Ground)	GND(Ground)
	14	N/C (Not connected)	N/C (Not connected)
	15	Tx-(-Data Send)	Data-
	16	Tx+(+Data Send)	Data+



TERM 1 switch controls PORT A, TERM 2 Switch controls PORT B
1, 2 : ON → RS-485 MODE, OFF → RS-422 MODE
3, 4 : ON → Termination On, OFF → Termination Off

PORT A : SCC-3100A terminal

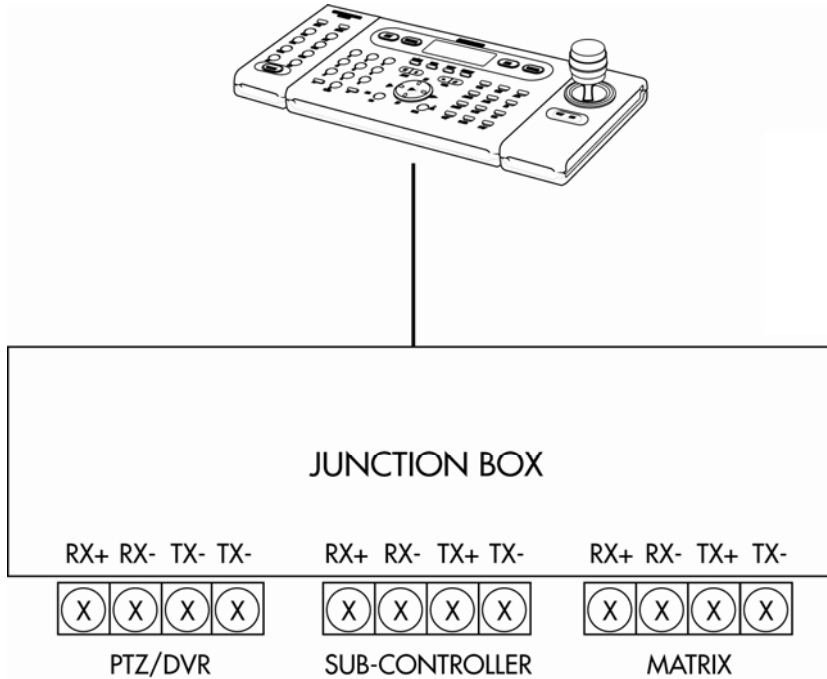

Controller Terminal (PORT 1)	DVR PORT A	
	RS-485	RS-422
RX+	1 or 8	8
RX-	2 or 7	7
TX+		1
TX-		2

- ※ RS-422/485 connection can be selected from the SW1 switch.
 To connect RS-485: SW1 switch 1, 2 are turned ON.
 To connect RS-422: SW1 switch 1, 2 are turned OFF

PORT B : SPD-2200 terminal

3

Installation method

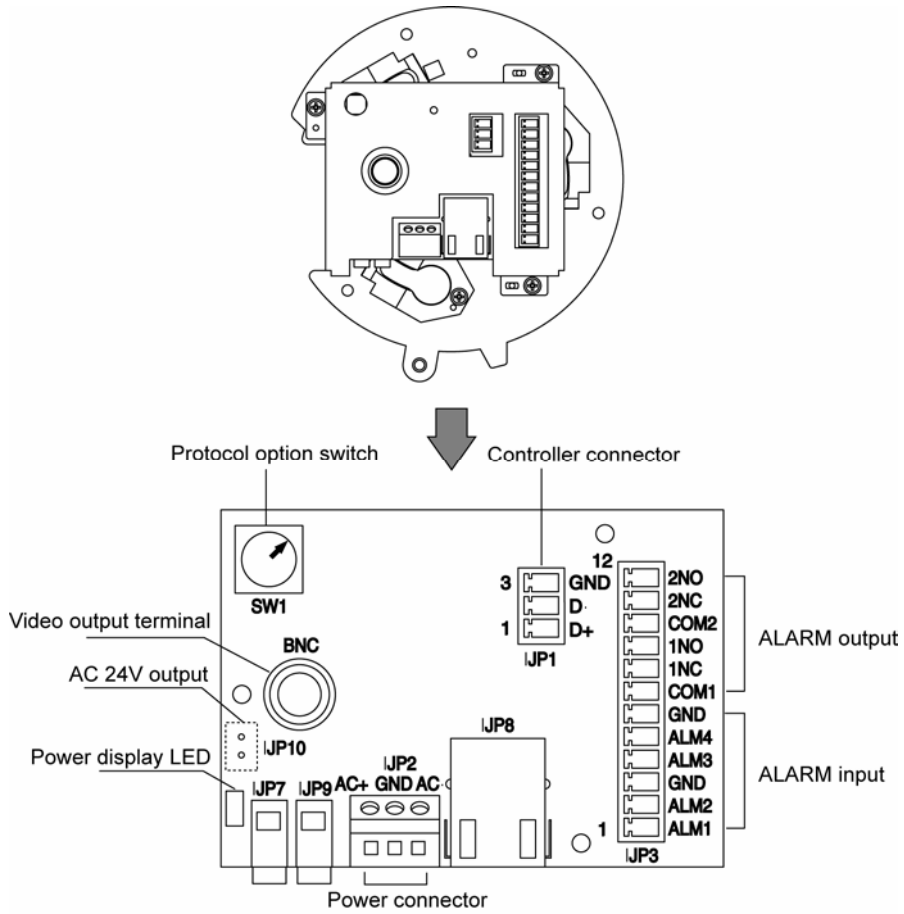

Speed dome terminal	DVR PORT B
D +	9 or 16
D -	10 or 15
GND	13

※ If GND is connected, a much sharper image quality can be seen.
 TERM2 switch 1, 2 must be set to ON.

SPD-2500 terminal

Interface connector

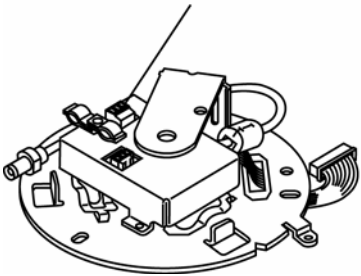

Interface connector

Terminal No.	Signal name
1	DATA(+)
2	DATA(-)
3	Signal GND

Speed dome terminal	DVR PORT B
D +	9 or 16
D -	10 or 15
GND	13

※ If GND is connected, a much sharper image quality can be seen.
 TERM2 switch 1, 2 must be set to ON.

SPD-2300/3000/3300 terminal

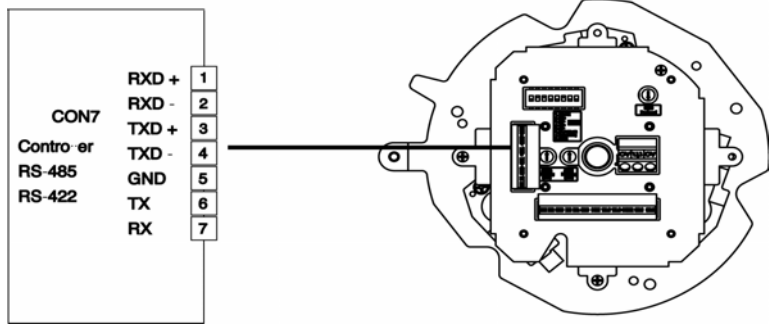

Speed dome terminal	DVR PORT B	
	RS-485	RS-422
RXD+	9 or 16	16
RXD-	10 or 15	15
TXD+		9
TXD-		10
GND	13	
TX	Terminal for RS-232 communication	
RX	Terminal for RS-232 communication	

※ If GND is connected, a much sharper image quality can be seen.
 RS-422/485 connection can be selected from the TERM2 switch.

4. Communication port (RS-232C)

This is a port used to connect to the PC to control the product.

No.	Description	No.	Description
1	N/C(Not connected)	6	N/C(Not connected)
2	RxD(Data receive)	7	N/C(Not connected)
3	TxD(Data send)	8	N/C(Not connected)
4	N/C(Not connected)	9	N/C(Not connected)
5	GND(Ground)		

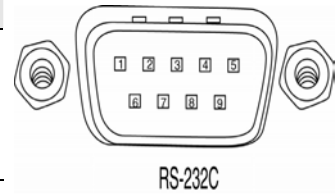

External devices ATM/POS may be connected and used.
 - SVR-1650E/1640A : RS-232C
 - SVR-950E : CONSOLE.

5. Monitor output (VGA)

This is an output connector for the VGA monitor.

No.	Description	No.	Description
1	Red signal(75Ω, 0.7Vp-p)	9	N/C(Not connected)
2	Green signal(75Ω, 0.7Vp-p)	10	GND
3	Blue signal(75Ω, 0.7Vp-p)	11	GND
4	N/C(Not connected)	12	N/C(Not connected)
5	GND	13	HSYNC(Horizontal synchronization)
6	GND	14	VSYNC(Vertical synchronization)
7	GND	15	N/C(Not connected)
8	GND		

6. LAN connection (Ethernet)

This is a port to connect to the network.

No.	Description	No.	Description
1	TX+ (Data send)	5	N/C (Not connected)
2	TX- (Data send)	6	RX-(Data receive)
3	RX+(Data receive)	7	N/C (Not connected)
4	N/C (Not connected)	8	N/C (Not connected)

When connecting network cable, we recommend installation with the cable core as below to improve communication quality.

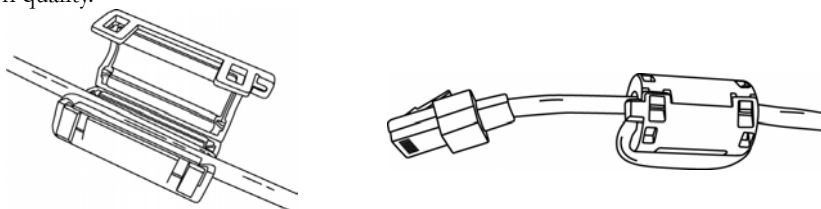

Chapter 4. Operation method

4.1 Preoperation inspection items

- ❖ Make sure you verify the input power source voltage before turning on the power.
- ❖ If product used for NTSC is used with a PAL device, it may malfunction initially (recognize as a NTSC device). In this case, if power is turned OFF and ON again, it will recognize the PAL device properly.

4.2 Connection of power supply

- ❖ After connecting the product with other equipment including the power supply cable, turn ON the power by pressing the stand-by switch button in front of the product.
- ❖ When product is turned ON, video signal presence is recognized automatically.
- ❖ Even if there is a sudden power failure, all setup value will be maintained.
- ❖ If the product is setup to input a password when product is turned ON and OFF, enter the password. Product cannot be turned ON or OFF without entering the password in this case.

4.3 Live screen

When the product is turned ON, live screen, which is a surveillance screen, is displayed.

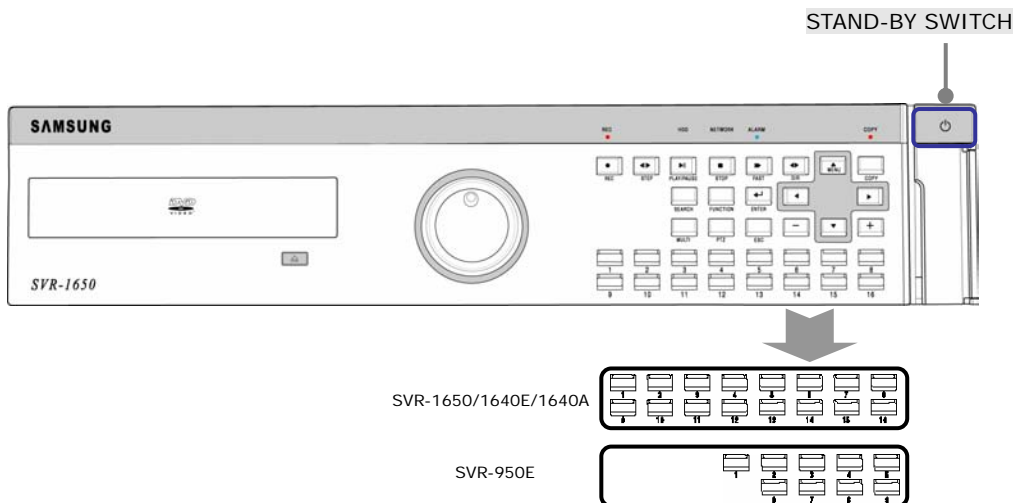

4.3.1 FUNCTION screen display

If Channel 1~16(SVR-950E: Channel 1~9) is setup as screen mode and FUNCTION button is pressed, icons for FUNCTION-LIVE will be activated. FUNCTION icon can be used to setup SPOT, PTZ and PIP.

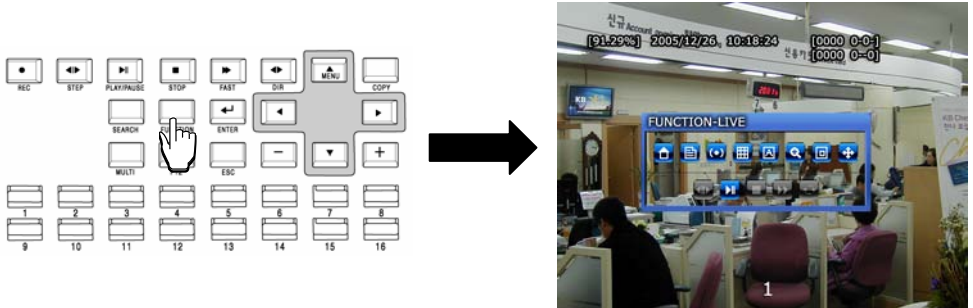

In the FUNCTION-PLAY screen, the following play screen will be displayed.



4.3.2 Single channel screen display

If Channel 1~16(SVR-950E: Channel 1~9) button is pressed, each channel is displayed using the entire screen.

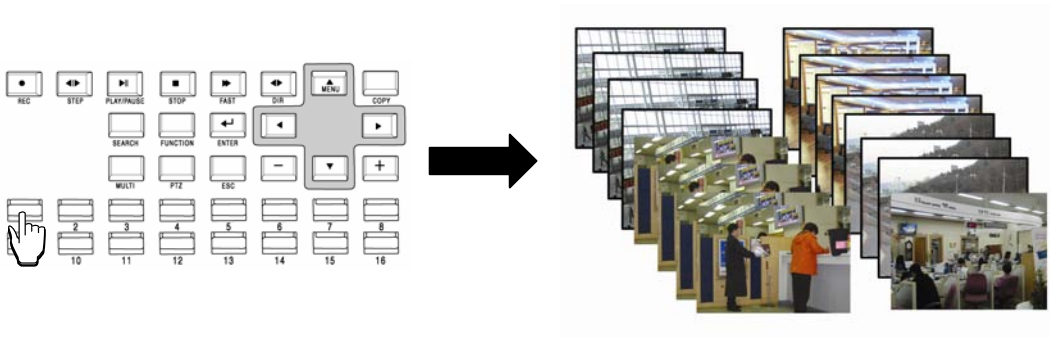

4.3.3 Multi screen display

If MULTI button is pressed, 16 channels are displayed as a 16 DIVISION screen (For SVR-950E, channel 9 is partitioned into 9 segments on the screen.). If MULTI button is pressed once again, a 4 DIVISION screen is displayed. Each time MULTI button is pressed, a divided screen is displayed following the order for divided screen types setup in [Screen Setup]-[SEQUENCING].

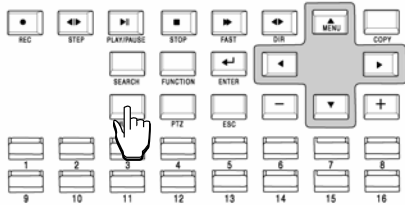

**If Multi button is pressed in order, display is changed in the following order :
 16 DIVISION → 4 DIVISION → 9 DIVISION screen.
 (SVR-950E: 9 DIVISION → 4 DIVISION)**

4.4 Recording

4.4.1 General recording

If REC button is pressed, red LED is turned ON, N is displayed in the upper right corner and video recording is started. If REC is pressed again, video recording is stopped.

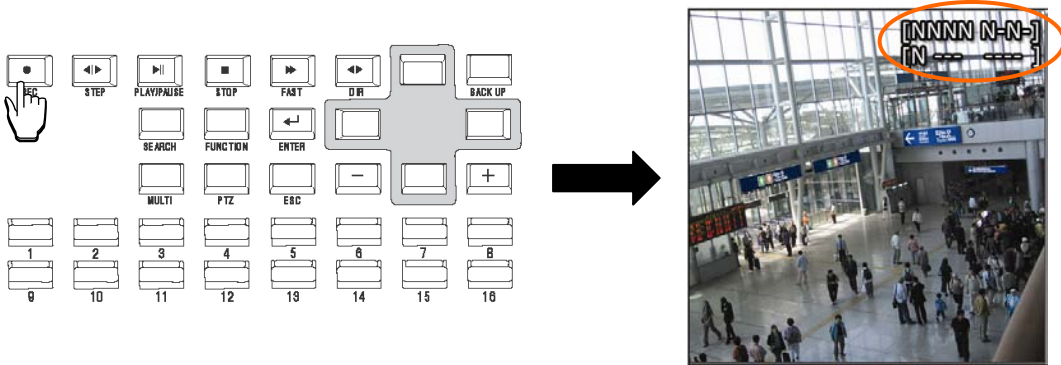

[RECORD-OFF] is set to ON in password function, password input is needed to stop REC.

4.4.2 Scheduled recording

If [Scheduled video recording] is setup for [Record Setup]-[RECORD]-[RECORD MODE] in the menu, scheduled video recording is carried out automatically according to the reservation setup. REC button is not operational during scheduled video recording.



Video recording status display ([NNNN]), shown on the screen, when the corresponding channel is not being recorded, "0" is displayed and if there are no images, "-" is displayed.

N: Normal video recording in progress

S: Scheduled video recording in progress

E: Event video recording in progress (motion detection video loss , sensor)



REC button is not operational during scheduled video recording.

4.5 Search

If SEARCH button is pressed, the following search menu is displayed. Video recorded items can be searched by time, by event and by date using the menu and played. Log file search is also possible.

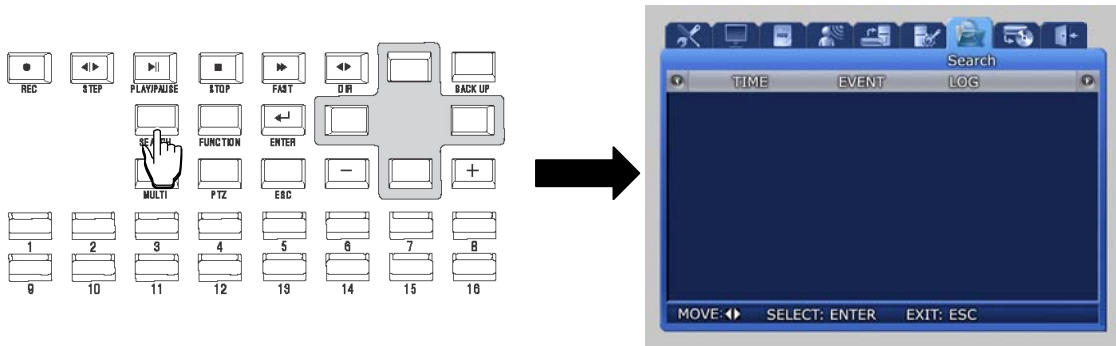

4.5.1 Time search

If [TIME] is selected after SEARCH button is pressed, images stored in the basic built-in HDD can be setup by 'TIME' or 'CALENDAR' and played.

In case of 'TIME', date and time video recording was carried out is displayed. If the desired date and time is entered and [OK] button is pressed, images recorded for each channel during this time period can be viewed. In case of 'CALENDAR', recorded images can be conveniently found and viewed by using calendar.



In case of 'TIME', recorded images are viewed by selected time period.

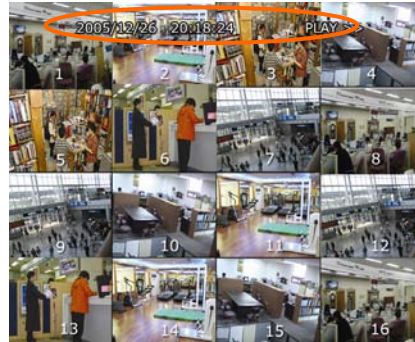

SVR-1650E/1640E/1640A



SVR-950E

In case of 'CALENDAR', calendar helps to search recorded images conveniently through data and time table.

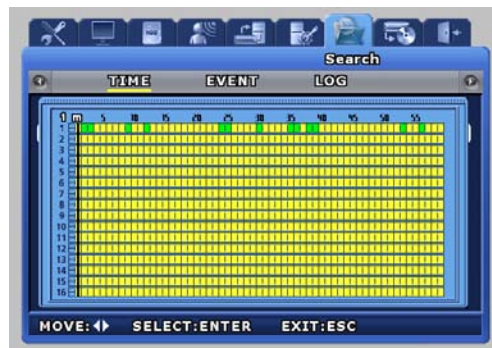
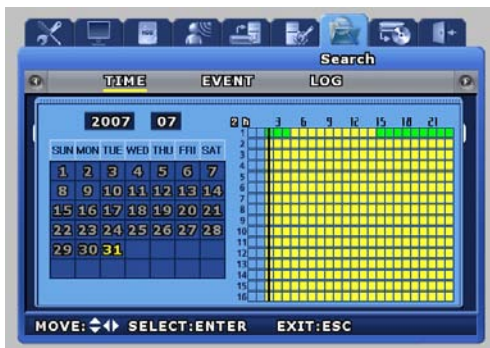

After the date on the left calendar and the hour and channel on the right table are selected, minute can be selected.



In the CALENDAR table, green section means event recording and Yellow section means normal recording.

4.5.2 Event search

If [EVENT] is selected after SEARCH button is pressed, a screen for selecting the event to search for is displayed. User can search by event and play the result as needed.



Channel : Select a channel for event search.

- ✓ SVR-1650E/1640A : CH1~16
- ✓ SVR-950E : CH1~9

Event type : Event type can be filtered for all events or [SENSOR/V-LOSS/MD/TEXT].

- ✓ SENSOR : Sensor events
- ✓ V-LOSS : Video loss events
- ✓ MD : Motion detection events
- ✓ TEXT : Text input events



If number of video recording items exceeds the number that can be displayed on one screen, use the (+)/(-) buttons on the remote controller or the main body to move between pages.

If a video recording item is selected and ENTER button is pressed, the corresponding video recording will be played.

To return to the EVENT LIST, press the ECS button again.

4.5.3 Log search

Log history can be searched to verify the time for video recording start and stop, power ON/OFF, system time change (CLOCK), menu setup change (SETUP).



- ❖ [LOG] only provides a list and does not play recordings.
- ❖ Press the ESC button to exit the list.
- ❖ Select the modified Setup on [CONTENTS] and press ENTER button to verify authority and submenu information.

4.6 Recording file playback

Files found by video recording search can be view through the playback related buttons shown in the figure below. Function for each playback related button is as follows.

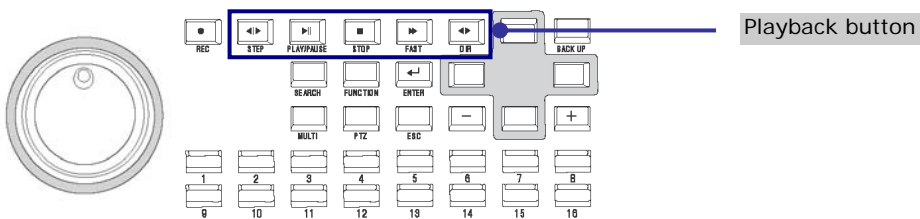

- ✓ STEP(Frame play) : Press the STEP button from the video recorded screen to play it in a frame. Each time the button is pressed, a small frame is played.
- ✓ PLAY/PAUSE : If PAUSE button is pressed from the PLAY screen, the PLAY screen is paused momentarily. If the button is pressed again, PLAY is resumed.
- ✓ STOP : Press the STOP button from the PLAY screen to exit the PLAY mode.
- ✓ FAST(FAST PLAY) : Press the FAST button from the PLAY screen to play at a faster speed than the normal speed (2x, 4x, 8x, MAX).
- ✓ DIR(Play direction conversion) : Press the DIR button from the PLAY screen to convert play direction to forward direction or reverse direction.

4.6.1 Jog dial / shuttle ring

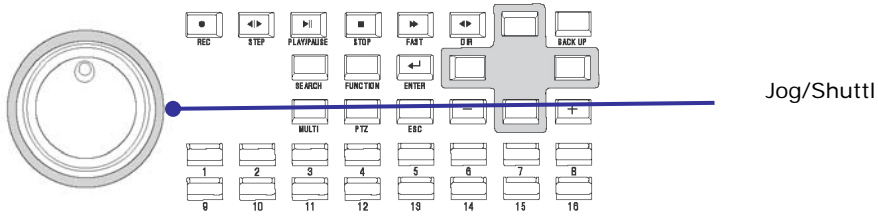

- ✓ Shuttle ring: Used to increase/decrease play speed and to change play direction, to move between menus
- ✓ Jog dial: Used to search still images in paused state.

4.7 Live / Playback screen conversion

If there is a video recording, press the PLAY/PAUSE button from the LIVE screen to get to the PLAY screen. Press the STOP button from the PLAY screen to return to the LIVE screen. Conversion from live to playback screen is only possible if a file for a video recording that occurred one minute ago, with respect to end time, exists. If such a file does not exist, a 'No Data' message is outputted.

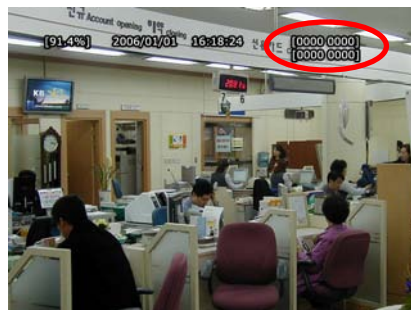
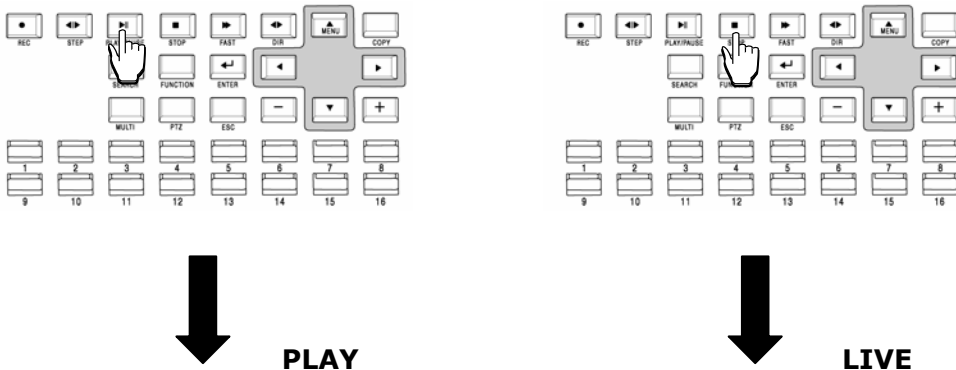



**< Image freeze and copy function while LIVE or playback mode.>
(USB memory stick is necessary.)**

Images can be paused and saved to USB memory stick while LIVE or playback mode. The still image is saved as bitmap (*.bmp) file.

▶ How to capture still image while LIVE mode.

- Press [STEP] button to freeze images. (On the top of center, 'Freeze' is displayed.)
- Though recording is operated, you can freeze and copy image without quit.
- Under freezing image, the time is paused but 'Title', 'Rec', 'Status' and remains of HDD is continuously displayed on the screen.
- Connect USB memory stick to DVR and press [COPY] button.
- While copying image, 'COPYING' is displayed on the screen.
- Saved bitmap file has the following format.
"SVR(model)_LIVE_(date:yyyymmdd)_(time:hmmss)"
Ex. "SVR1650_LIVE_20070822_171350.bmp" is saved.
- Press [STEP] button to release a freeze.

▶ How to capture still image while playback mode.

- Press [Pause] button to freeze images while playback.
- Connect USB memory stick to DVR and press [COPY] button.
- Saved bitmap file has the following format.
"SVR(model)_PLAY_(date:yyyymmdd)_(time:hmmss)"
Ex. "SVR1650_PLA_20070822_171350.bmp" is saved.
- Press any button except [COPY] to release a freeze.

▶ Notes for image capture

- When capture is over, you hear a beep. If you remove USB memory stick immediately as hearing a beep, image capture may be incomplete.
- Image capture can't support SPOT monitor.

4.8 Digital zoom

If FUNCTION button is pressed and digital zoom  icon is clicked, zoom function can be used.

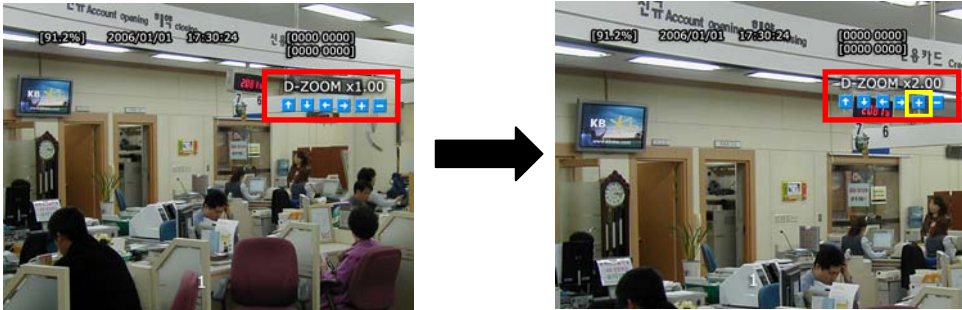

- ✓ To move in the expanded screen, use the up/down/left/right buttons.
- ✓ D-ZOOM button operates in the single screen mode for channel 1~16 (SVR-950E: channel 1~9).
- ✓ To cancel, press the mouse right button or the ESC key.

4.9 Copy

If COPY button is pressed, HDD content can be stored in other storage medium including DVD±RW/DVD±R/CD-RW/CD-R and USB memory stick. The device connected to the product will be automatically recognized and displayed on the menu.

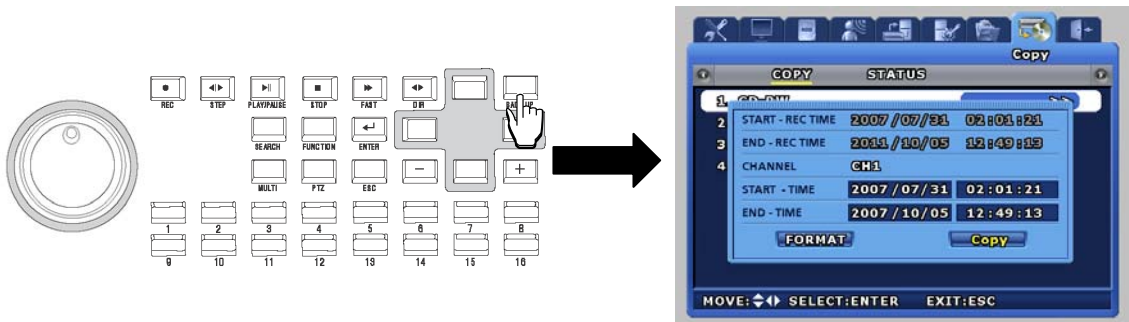

After selecting a storage medium, select the channel for which COPY will be carried out and the image information [START-REC TIME /END-REC TIME]. Press 'FORMAT' to format media and then press 'COPY' to copy recorded images to the media from HDD.



- If a recording is in progress, it is continued even during the time COPY is carried out.
- Network backup and network playback function are not supported during the time COPY is carried out.
- If NORMAL COPY is carried out using a USB memory, the maximum amount that can be copied with one USB memory is 200MB.



1. Before COPY, storage device formatting must be carried out first.
 - DVD±RW/CD-RW: Use after executing the DVR Format Menu
 - USB memory stick : Use after executing the Format Menu in FAT format from the PC. (FAT32 format may not operate normally.)
2. Recommended media
 - DVD : Mitsubishi, TDK, Imation (1~4X recommended)
 - CD : Mitsubishi, TDK, Imation (4~12X recommended)
 - USB memory stick : SanDisk, Transcend (512MB recommended)

3. If you wish to use an external DVD, you should use one of the recommended models as follows.

	Manufacturer	Model
DVD	LG	GSA-H10N
5.25" External DVD case	SAEROTECK	FCD-524

4. Please make sure only authentic products are used. If inauthentic products are used, problems may occur. Using new media products is recommended. If DVD and CD are used over a long period of time, error may occur.
5. If one of the messages below is displayed, COPY has not been completed normally. Please follow directions to complete the COPY operation normally.

"Copy is terminated. Try it over again after formatting the media, or continue to copy from the termination time with new media."

4.9.1 SLiM Player

SLiM Player is a program that is automatically saved when making a backup copy of a movie file on a CD or USB using the copy function of the DVR. You may replay a backup copy of the data on a PC without installing a separate Player program on a PC.

This function is only supported by DVR firmware version 1.8 or higher.

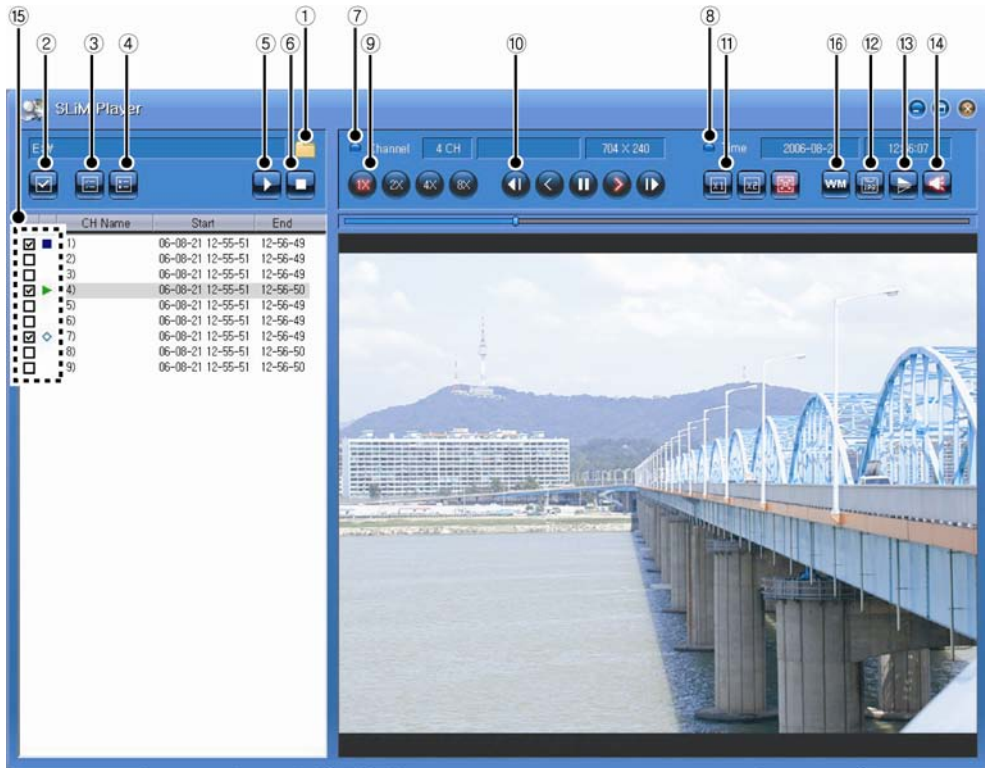

Button	Name	Function
1	Select Folder	Clicking on the button, the program will be executed and the folder will appear. At this moment, if you click on the folder where the recorded file is located, the list of recorded files in the folder will appear. The list of recorded files will be arranged and displayed in the order of channel or time.
2	All list check or not check	Select every file or cancel the selection.
3	Selected list check	Select a file.
4	Selected list not check	Cancel the selection of a file.
5	Play	Play the selected files in order.
6	Stop	Stop playing the file and canceling all the selections made.

Button	Name	Function
7	Channel Info	Display the information of the channel that is saved.
8	Time Info	Display the information on the recording time for the file being played.
9	Control of playback speed	Adjust the playing speed.(1x/2x/4x/8x)
10	Control of playback functions	These are functions related to 'play'. - Move to the previous frame. - Play in the reverse direction. - Temporary stop. - Play in the forward direction. - Move to the next frame.
11	Control of playback Image size	Adjusting the size of the screen for playing the content. - 1x zoom/2x zoom/Entire screen - Images with resolutions, 704x240 or 704x288 will not change its size even with 2x zooming.
12	Save as JPEG	Save the screen being played as a JPEG file.
13	Invert	Rotate the screen being played by 180°.
14	Audio ON/OFF	Turn the audio function ON/OFF.
15	Playback File List	◇ : Getting ready for playing ► : forward play ◀ : reverse play : pause ■ : stop playing
16	Watermark detector	Turn the watermark detector ON/OFF.

4.10 PTZ

From the selected LIVE entire screen SINGLE mode, press the PTZ button to adjust camera Pan, Tilt, Zoom or view the screen in preset (PTZ value for camera setup in advance) state. There are no PTZ related buttons on the remote controller.

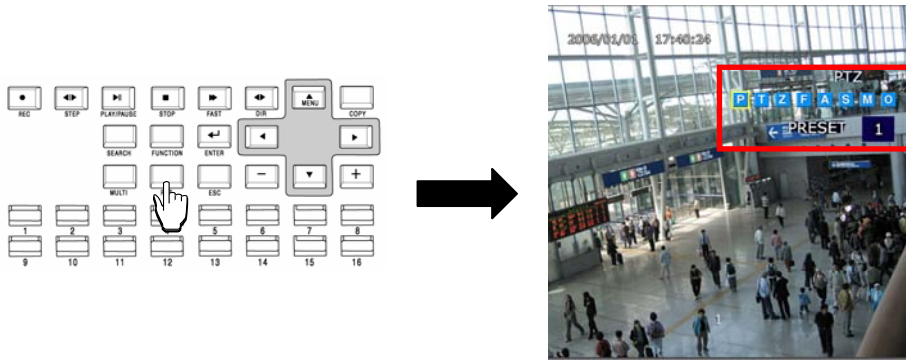

4.10.1 PTZ adjustment

- ✓ After pressing the PTZ button from the single screen, put the cursor on the **P** button and adjust using the shuttle.
- ✓ To adjust camera TILT, after pressing the PTZ button from the single screen, put the cursor on the **T** button and adjust using the shuttle.
- ✓ To adjust camera ZOOM, after pressing the PTZ button from the single screen, put the cursor on the **Z** button and adjust using the shuttle.
- ✓ To adjust camera focus, put the cursor on the **F** button and adjust using the shuttle.



Jog dial can only cause movement in 1x speed. By increasing the shuttle ring rotation angle, movement in 2x, 4x, 8x speed is possible for the shuttle ring.

- ✓ After adjusting, if the **A** button is pressed with the mouse or if the ENTER button, located on the front of DVR, is pressed after the A button is selected, focus is adjusted automatically.
- ✓ To exit the PTZ mode, press the mouse right button or the ESC key.



PTZ mode can only be used in LIVE screen and cannot be setup in MULTI mode. It must be setup as SINGLE mode in the LIVE screen.

4.10.2 Preset setup

- ✓ Select a desired channel from channel 1~16(SVR-950E: channel 1~9) in the LIVE screen and select the entire screen mode.
- ✓ Press PTZ to select the PTZ mode (PTZ is displayed in the upper right corner of the screen.)
- ✓ Press (PAN) / (TILT) / (ZOOM) and use the mouse and jog/shuttle to take the screen to the desired PTZ state.
- ✓ Use PRESET located below PTZ and setup the value with the mouse (1~255).







1. If PTZ (P-Set) is displayed in the upper part of the screen, Channel 1~16 (SVR-950E: channel1~9) displays the preset number to setup (1~255) rather than the corresponding channel.

2. Preset may be setup by pressing the 'ENTER' key, located in the front of DVR, or the mouse button after moving the cursor to .

4.10.3 Preset utilization

- ✓ Select a desired channel from channel 1~16(SVR-950E: channel 1~9) and select the entire screen mode.
- ✓ Press PTZ to select the PTZ mode (PTZ is displayed in the upper right corner of the screen.)
- ✓ Use the mouse on PRESET, located below PTZ on the screen, to setup the value (1~255).
- ✓ If the desired button between Channel 1~16(SVR-950E: channel 1~9) is pressed, the cursor is moved to the  button and the ENTER key located on the front of DVR is pressed, the camera operates with preset values setup in advance.

4.10.4 Using OSD for the Speed Dome Camera

- ✓ After pressing the PTZ button from the single screen, if either the ENTER key in the front of the DVR or the mouse button is pressed after moving the cursor to , OSD for the speed dome camera and the following message will be displayed: 'PTZ OSD'.
- ✓ OSD cursor for the speed dome camera may be moved up/down and left/right by using     keys in the front of the DVR.
- ✓ Changes in OSD for the speed dome camera may be setup or cancelled by using ENTER and ESC keys in the front of the DVR.
- ✓ OSD function for the speed dome camera can be terminated by pressing the PTZ button in the front of the DVR.

4.11 Quick setup

Collection of frequently used menu items that can be used to modify setup values quickly. It can move to the [Quick Setup] screen by pressing the MENU button on the front of the product.

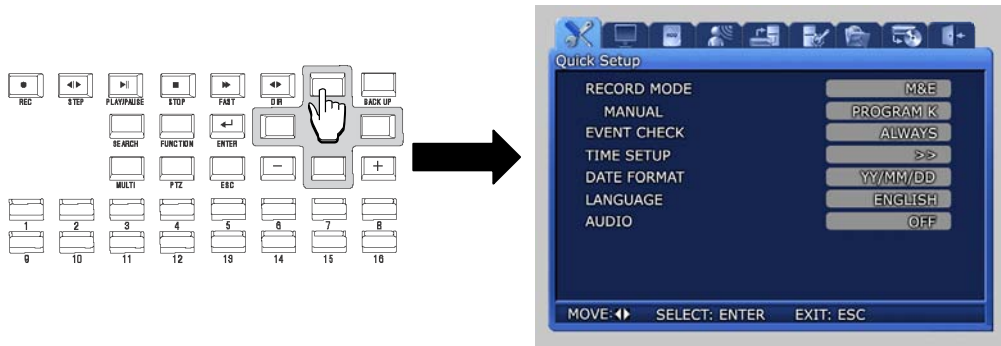

- ✓ RECORDE MODE : Manual & Event or Schedul & Event setup item.
- ✓ EVENT CHECK : Can be set to OFF, ALWAYS or TIMEZONE.
- ✓ TIME SETUP : Setup the system time.
- ✓ DATE FORMAT : Setup the date display format.
- ✓ LANGUAGE : Language can be selected.
- ✓ AUDIO : Select whether to store voice information along with images.

Press the ESC button after completing the setup to move to the completion screen. If [SAVE] is selected here, setup items are saved.

4.12 PIP

If FUNCTION button is pressed in entire screen mode, the FUNCTION screen is displayed. If the PIP



icon is pressed from here, another screen can be viewed together.



SVR-1650E/1640A



SVR-950E

❖ Live PIP from Live screen

1. Press the FUNCTION button and select the PIP icon.
2. From the menu on the right side of the live screen, select the desired channel.
3. If the desired channel is selected with the mouse, a small screen is displayed inside the screen.
4. If mouse right button or the ESC button is pressed, PIP mode is cancelled.

❖ Play PIP from PLAY screen

Same as PIP setup item in live screen.

4.13 System information

If FUNCTION button is pressed, the FUNCTION screen is displayed. If the STATUS  icon is clicked from here, system related information is displayed as shown below.

SYSTEM INFORMATION 1					SYSTEM INFORMATION 2		
RECORD MODE	M	M&E	PROGRAM	A	VIDEO	AUDIO	
CH	M	Q	E	Q			
1	5	S	7	S	0.0 M/min	0 KB	
2	5	H	7	S	0.0 M/min	0 KB	
3	5	M	7	S	0.0 M/min	0 KB	
4	5	L	7	S	0.0 M/min	0 KB	
5	5	S	7	S	0.0 M/min		
6	5	H	7	S	0.0 M/min		
7	5	M	7	S	0.0 M/min		
8	5	L	7	S	0.0 M/min		
9	5	S	10	S	0.0 M/min		
10	5	S	10	S	0.0 M/min		
11	5	S	10	S	0.0 M/min		
12	5	S	10	S	0.0 M/min		
13	5	S	7	S	0.0 M/min		
14	5	S	7	S	0.0 M/min		
15	5	S	7	S	0.0 M/min		
16	5	S	7	S	0.0 M/min		

SVR-1650E

SYSTEM INFORMATION 1					SYSTEM INFORMATION 2		
RECORD MODE	M	M&E	PROGRAM	K	IMAGE SIZE	704 X 240	
CH	M	Q	E	Q	VIDEO	AUDIO	
1	5	H	10	S	0.0 M/min	0 KB	
2	5	H	10	S	0.0 M/min	0 KB	
3	5	H	10	S	0.0 M/min	0 KB	
4	5	H	10	S	0.0 M/min	0 KB	
5	5	H	10	S	0.0 M/min		
6	5	H	10	S	0.0 M/min		
7	5	H	10	S	0.0 M/min		
8	5	H	10	S	0.0 M/min		
9	5	H	10	S	0.0 M/min		
10	5	H	10	S	0.0 M/min		
11	5	H	10	S	0.0 M/min		
12	5	H	10	S	0.0 M/min		
13	5	H	10	S	0.0 M/min		
14	5	H	10	S	0.0 M/min		
15	5	H	10	S	0.0 M/min		
16	5	H	10	S	0.0 M/min		

SVR-1640A

SYSTEM INFORMATION 1					SYSTEM INFORMATION 2		
RECORD MODE	M	M&E	PROGRAM	K	IMAGE SIZE	704 X 240	
CH	M	Q	E	Q	VIDEO	AUDIO	
1	5	H	10	S	2.2 M/min	0 KB	
2	5	H	10	S	2.3 M/min	0 KB	
3	5	H	10	S	0.0 M/min	0 KB	
4	5	H	10	S	0.0 M/min	0 KB	
5	5	H	10	S	0.0 M/min		
6	5	H	10	S	0.0 M/min		
7	5	H	10	S	0.0 M/min		
8	5	H	10	S	0.0 M/min		
9	5	H	10	S	0.0 M/min		

SVR-950E

SYSTEM INFORMATION 1		SYSTEM INFORMATION 2	
FIRMWARE VERSION	v 1.9a		
N/W FIRMWARE VERSION	v 1.9a		
IP ADDRESS	192.168.001.076		
MAC ADDRESS	00 00 00 aa bb cc		
AUDIO	OFF		
AVERAGE DATA RATES	1.0 M/min		
HDD TOTAL SIZE	147456 MB		
TOTAL RECORDABLE TIME	98D 0H 21M		
HDD FREE SIZE	124307 MB		
CURRENT RECORDABLE TIME	82D 15H 4M		

- ✓ TOTAL RECORDABLE TIME : The time duration that can be allocated to the entire portion of HDD for a given amount of image data received by the DVR in one minute.
- ✓ CURRENT RECORDABLE TIME : The time duration that can be allocated to the unrecorded portion of HDD for a given amount of image data received by the DVR in one minute.

As shown on the screen above, video recording program information and version, IP address, MAC address, voice information can be verified. If mouse right button or ESC button is pressed, the information screen is closed.

4.14 SPOT

If FUNCTION button is pressed, the FUNCTION screen is displayed. If the SPOT icon  is clicked from here, the following screen is displayed. If SPOT monitor is used, it can be used like the MULTI function for the main monitor.

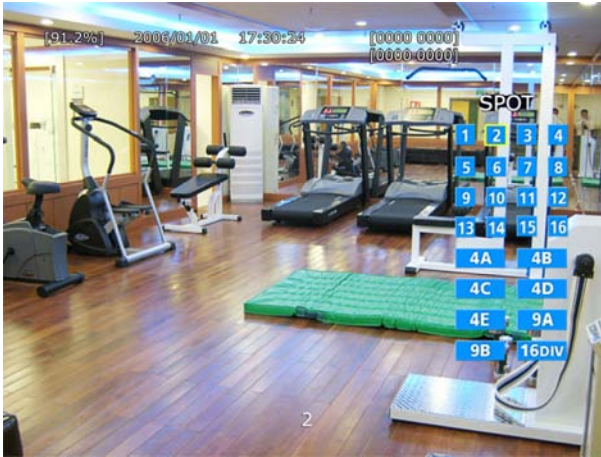

SVR-1650E/1640A

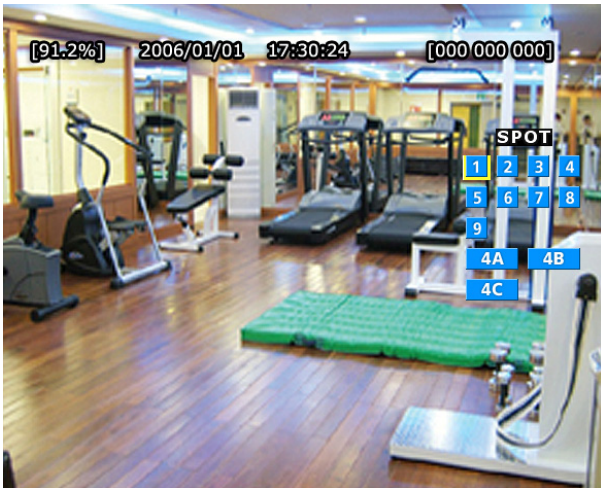

SVR-950E

Chapter 5. Setup method

5.1 Menu organization

Menu organization for DVR is as follows.

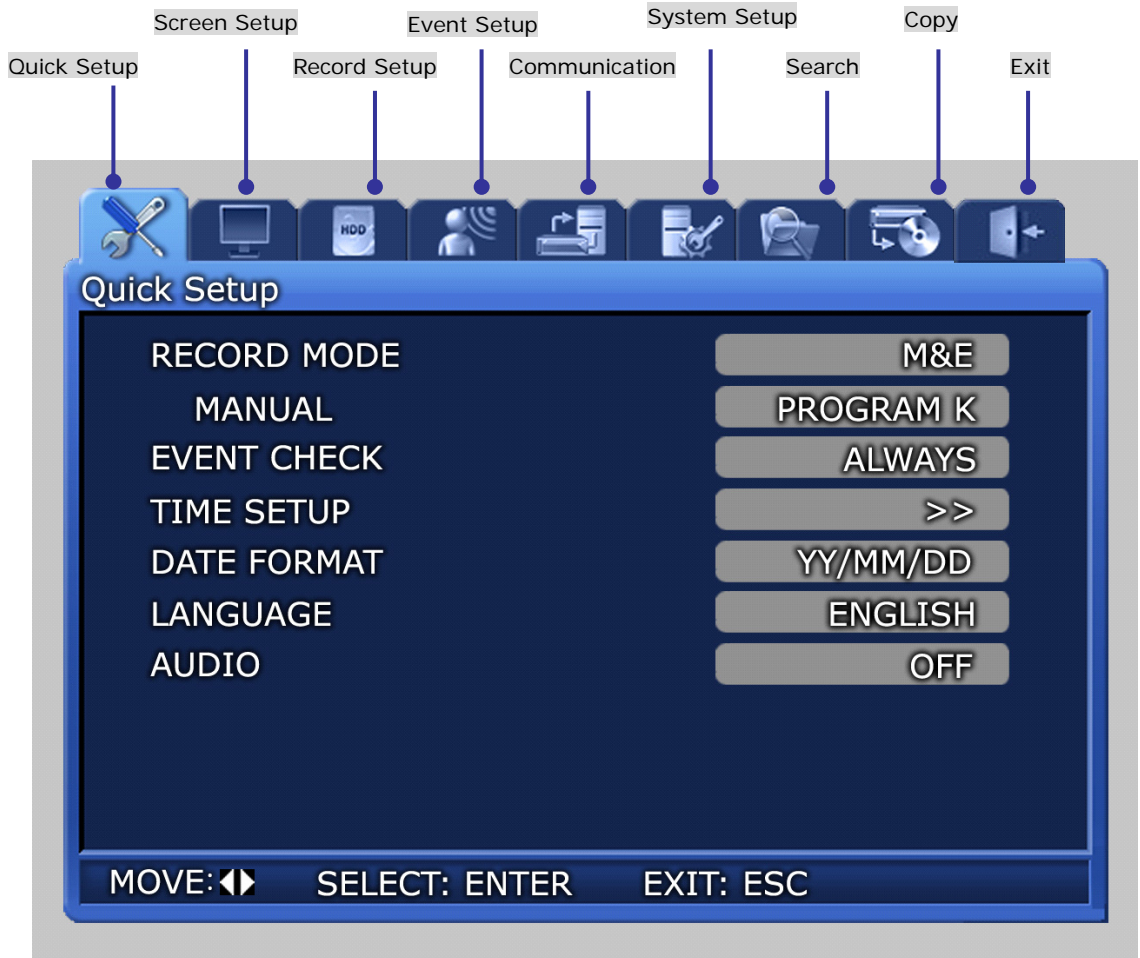

Menu organization is as follows. Refer to '5.5 ~ 5.10' for details.

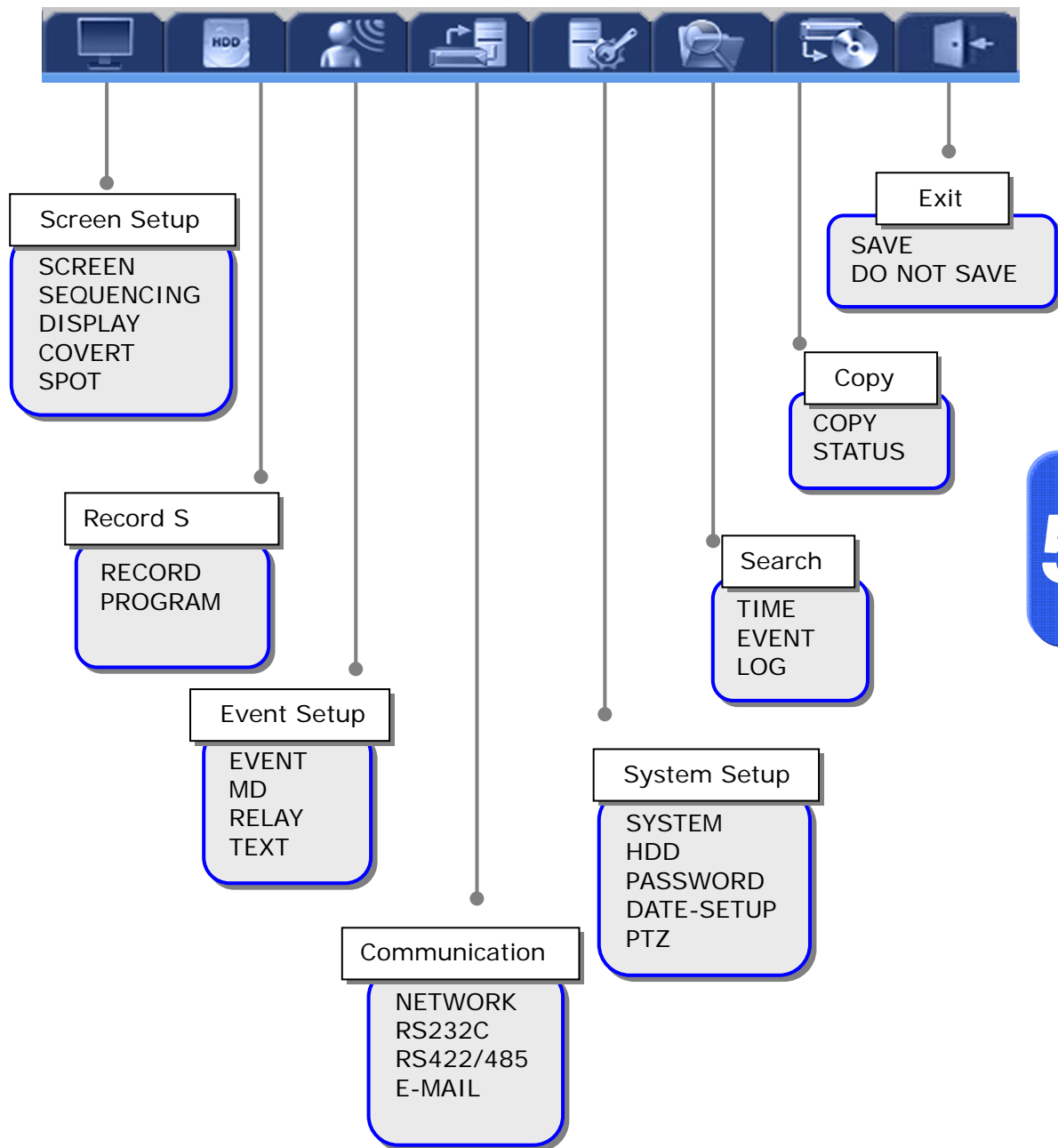

5

5.2 Initial value setup

DVR product is shipped with the initial value setup listed below. If the initial values have been changed and the user wants to get back the initial values the product was shipped with, click [System Setup]-[System] in the menu and set [DEFAULT] to [Yes].

Screen setup

Main menu	Lower menu	Initial value	
		SVR-1650E/1640A	SVR-950E
SCREEN	CH NUMBER	CH1~16	CH1~9
	TITLE	1~16	1~9
	BRIGHTNESS	0	0
	CONTRAST	0	0
	SHARPNESS	0	0
	VIDEO OUTPUT SELECT	Enhanced COMPOSITE	Enhanced COMPOSITE
SEQUENCING	DWHEEL TIME	3 sec (CH1 ~ 16)	3 sec (CH1 ~9)
	ORDER	CH1...→CH16→4DIV A...→ 4DIV E→9DIV A→9DIV B→ 16DIV	CH1...→CH9→4DIV A→ 4DIV B→4DIV C→9DIV
	MULTI MODE	4DIV : CH1,CH5,CH9,CH13 9DIV : CH8 ~ CH16	4DIV : CH1,CH2,CH3,CH9
	VIDEO LOSS SKIP	OFF	OFF
DISPLAY	DATE & TIME	ON	ON
	HDD FREE SPACE	ON	ON
	RECORD STATUS	ON	ON
	TITLE	ON	ON
	REMOTE ID	ON	ON
COVERT	CH NUMBER	CH1~16	CH1~9
	LIVE COVERT	OFF	OFF
	PLAY COVERT	OFF	OFF
SPOT	TITLE DISPLAY	ON	No function available
	SPOT MODE	MANUAL	MANUAL
	SPOT EVENT	OFF	OFF
	SCREEN		

Record setup

Main menu	Lower menu	Initial value
RECORD	RECORD MODE PROGRAM PRE EVENT DURATION POST EVENT DURATION REPEAT RECORD MODE WARNING LEVEL AUDIO	M&E PROGRAM K 3 sec 10 sec ON 5% OFF
PROGRAM	PROGRAM K	IMAGE SIZE 704 x 240(NTSC) SVR-1650E : M=5, Q=H, E=10, Q=S SVR-1640A: M=1, Q=H, E=3, Q=S SVR-950E : M=2, Q=H, E=3, Q=S (Refer to '5.7.2 Record program' for details.)

Record program (SVR-1650E)

Order	NTSC					PAL				
	SIZE	MANUAL	QUALITY	EVENT	QUALITY	SIZE	MANUAL	QUALITY	EVENT	QUALITY
A	704 X 480	5	S	7	S	704 X 576	5	S	6	S
B	704 X 480	3	S	4	S	704 X 576	3	S	5	S
C	704 X 480	5	H	7	S	704 X 576	5	H	6	S
D	704 X 480	3	H	4	H	704 X 576	3	H	5	H
E	704 X 480	1	H	3	H	704 X 576	1	H	3	H
F	704 X 240	10	S	15	S	704 X 288	10	S	15	S
G	704 X 240	5	S	20	S	704 X 288	5	S	20	S
H	704 X 240	3	S	10	S	704 X 288	3	S	10	S
I	704 X 240	10	H	20	S	704 X 288	10	H	20	S
J	704 X 240	10	H	15	S	704 X 288	10	H	15	S
K	704 X 240	5	H	10	S	704 X 288	5	H	10	S
L	704 X 240	5	H	10	H	704 X 288	5	H	10	H
M	704 X 240	3	H	5	H	704 X 288	3	H	5	H
N	704 X 240	5	M	15	S	704 X 288	5	M	15	S
O	704 X 240	3	M	10	H	704 X 288	3	M	10	H
P	352 X 240	30	S	30	S	352 X 288	25	S	25	S
Q	352 X 240	20	H	20	S	352 X 288	15	H	15	S
R	352 X 240	10	H	15	H	352 X 288	10	H	15	H
S	352 X 240	25	M	25	S	352 X 288	20	M	20	S
T	352 X 240	10	M	10	H	352 X 288	10	M	10	H

■ Matters that require attention

-Initial value is currently set to K.

-Value that corresponds to the program above can be applied to all 16 channels.

Record program (SVR-1640A)

Order	NTSC					PAL				
	SIZE	MANUAL	QUALITY	EVENT	QUALITY	SIZE	MANUAL	QUALITY	EVENT	QUALITY
A	704 X 480	1	H	5	S	704 X 576	1	H	5	S
B	704 X 480	1	H	3	H	704 X 576	1	H	3	H
C	704 X 480	1	H	1	H	704 X 576	1	H	1	H
D	704 X 240	3	S	9	S	704 X 288	3	S	4	S
E	704 X 240	3	H	5	S	704 X 288	3	H	3	S
F	704 X 240	3	H	3	H	704 X 288	3	H	3	H
G	704 X 240	1	H	3	S	704 X 288	1	H	3	S
H	704 X 240	3	M	9	S	704 X 288	3	M	4	S
I	704 X 240	3	M	5	H	704 X 288	3	M	3	H
J	704 X 240	1	M	3	S	704 X 288	1	M	3	S
K	704 X 240	1	H	3	S	704 X 288	1	H	3	S
L	352 X 240	7	S	9	S	352 X 288	6	S	7	S
M	352 X 240	5	H	10	S	352 X 288	4	H	5	S
N	352 X 240	3	H	5	S	352 X 288	3	H	5	S
O	352 X 240	7	H	9	H	352 X 288	5	H	10	H
P	352 X 240	3	H	5	H	352 X 288	3	H	5	H
Q	352 X 240	1	H	5	S	352 X 288	1	H	5	S
R	352 X 240	7	M	9	S	352 X 288	6	M	7	S
S	352 X 240	5	M	10	H	352 X 288	3	M	10	H
T	352 X 240	3	M	5	S	352 X 288	3	M	5	S

5

■ Matters that require attention

-Initial value is currently set to K.

-Value that corresponds to the program above can be applied to all 16 channels.

Record program (SVR-950E)

Order	NTSC					PAL				
	SIZE	MANUAL	QUALITY	EVENT	QUALITY	SIZE	MANUAL	QUALITY	EVENT	QUALITY
A	704 X 480	2	H	5	S	704 X 576	2	H	5	S
B	704 X 480	1	H	3	H	704 X 576	1	H	3	H
C	704 X 480	1	H	2	H	704 X 576	1	H	2	H
D	704 X 240	5	S	9	S	704 X 288	5	S	5	S
E	704 X 240	3	H	5	S	704 X 288	3	H	5	S
F	704 X 240	3	H	3	H	704 X 288	3	H	3	H
G	704 X 240	1	H	3	S	704 X 288	1	H	3	S
H	704 X 240	5	M	9	S	704 X 288	5	M	5	S
I	704 X 240	3	M	5	H	704 X 288	3	M	5	H
J	704 X 240	1	M	3	S	704 X 288	1	M	3	S
K	704 X 240	2	H	3	S	704 X 288	2	H	3	S
L	352 X 240	10	S	12	S	352 X 288	7	S	10	S
M	352 X 240	5	H	10	S	352 X 288	5	H	10	S
N	352 X 240	3	H	5	S	352 X 288	3	H	5	S
O	352 X 240	10	H	12	H	352 X 288	7	H	10	H
P	352 X 240	5	H	10	H	352 X 288	5	H	10	H
Q	352 X 240	2	H	5	S	352 X 288	2	H	5	S
R	352 X 240	10	M	12	S	352 X 288	7	M	10	S
S	352 X 240	5	M	10	H	352 X 288	5	M	7	H
T	352 X 240	3	M	5	S	352 X 288	3	M	5	S

■ Matters that require attention

-Initial value is currently set to K.

-Value that corresponds to the program above can be applied to all 9 channels.

Event setup

Main menu	Lower menu	Initial value
EVENT	CHECK	OFF
	MESSAGE	ON
	BUZZER	OFF
	SWITCH TO EVENT SCREEN	OFF
	EVENT DISPLAY MIN TIME	3 sec
	EVENT DISPLAY MAX TIME	5 sec
	TEXT MONITORING	OFF
	SENSOR TYPE - CH1~16(SVR-1650E/1640A) - CH1~9(SVR-950E)	NO
MD	MD CHANNEL	CH1~16 (SVR-1650E/1640A)/ CH1~9(SVR-950E), ALL
	ALL AREA SET	-
RELAY	SENSOR, MD, V-LOSS, POWER	OFF
TEXT	SYNC CHANNEL	CH1
	DEVICE	NORMAL
	CHECK PROTOCOL LINES	OFF 1
EVENT- PRESET	SENSOR PRESET	CH1/PRESET 0
	MD PRESET	CH1/PRESET 0

Communication

Main menu	Lower menu	Initial value
NETWORK	TYPE	Ethernet
	DHCP	OFF
	IP ADDRESS	000.000.000.000
	SUBNET MASK	255.255.255.000
	GATEWAY	000.000.000.000
	DNS	000.000.000.000
	PORT	4000
RS232	SWR	OFF
	BAUD RATE	9600
	DATA BIT	8
	PARITY BIT	NONE
RS422/ 485	STOP BIT	1
	SYSTEM ID	0
	PORT TYPE	PORT A
	BAUD RATE	9600
	DATA BIT	8
E-MAIL	PARITY BIT	NONE
	STOP BIT	1
	E-MAIL CHECK	OFF
	TO	-
DDNS	SMTP SERVER	-
	AUTHENTICATION	OFF
	ID, PW	-
	SWR	OFF
DDNS	DDNS	OFF
	SERVER	-
	ID	-
	PW	-

System setup

Main menu	Lower menu	Initial value
SYSTEM	LANGUAGE KEY BUZZER DEFAULT LOAD/SAVE CONFIGURATION FIRMWARE DOWNLOAD REMOTE SETUP DVR ALIAS REMOTE ID REMOTE LIVE MODE (Function exclusively for SVR-1650E/1640A) CH 1 ~ 16 (NTSC) CH 1 ~ 16 (PAL)	ENGLISH ON - LOAD - ENABLE - ALL SINGLE 7 6
HDD	INTERNAL HDD HDD Format HDD EXTERNAL HDD HDD Format HDD	- HDD1 - PORT1-HDD1
PASSWORD	USER AUTHORIZATION USER PASSWORD BUZZER IF CHECKING FAILS	- - OFF
DATE-SETUP	TIME SETUP DATE FORMAT DAYLIGHT SAVING NTP CHECK NTP SERVER	- YY/MM/DD OFF OFF time.windows.com
PTZ	CH NUMBER CAMERA ID MODEL	CH1~16 (SVR-1650E/1640A) / CH1~9 (SVR-950E) 0 NONE

Search

Main menu	Lower menu	Initial value
TIME	TIME CALENDAR	- -
EVENT	CHANNEL EVENT TYPE	ALL ALL
LOG	-	

Copy

Main menu	Lower menu	Initial value
COPY	COPY	1.NONE(GSA-H55N) 2.NONE 3.NONE 4.NONE
	STATUS	NO DATA

Exit

Main menu	Lower menu	Initial value
-	SAVE	-
	DO NOT SAVE	-

5.3 Operation description

DVR can be setup easily using the USB mouse.

❖ Operation using the mouse

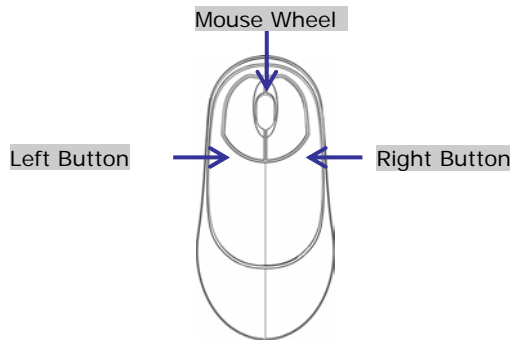

- ✓ Left button : It is used to select menu or check the setting value. Used to select menu, verify setup values and cancel the popup menu of main menu.
- ✓ Right button : Used to Function or cancel popup menu.
- ✓ Mouse wheel : Used to change setup values and display popup menu.

❖ Operation using the main body buttons

- ✓ ◀▶ : Move the cursor to the left and to the right.
- ✓ ▲▼ : Move the cursor up and down.
- ✓ +, - : Used to increase or decrease the value to be setup.
- ✓ Move the cursor and press the ENTER button to select the corresponding characters.
- ✓ Press the ESC button to exit the current menu being setup.
- ✓ To move between character rows, use the up/down arrow buttons.

❖ Operation using the remote controller

- ✓ Move left/right within the menu : Push the ◀ ▶ button.
- ✓ Menu selection : Press the ENTER button.
- ✓ Setup value modification : Press the (-) (+) button.



DVR does not support double-click of left mouse button.

5.4 FUNCTION menu

5.4.1 LIVE/PLAY mode

For SINGLE mode setup in the LIVE screen, all LIVE functions are activated and displayed. For MULTI mode setup in the LIVE screen, D-ZOOM, PIP, PTZ are inactivated and cannot be setup.

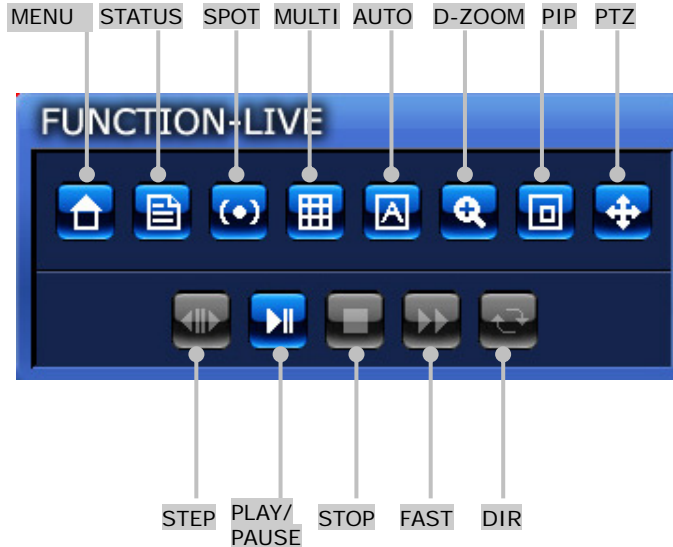

If PLAY/PAUSE button is pressed, conversion to the PLAY screen occurs. For single screen mode setup in the PLAY screen, PLAY functions SPOT, MULTI, D-ZOOM and PIP can be setup
 If PLAY/PAUSE button is pressed while in MULTI mode, D-ZOOM function cannot be setup.

5.4.2 FUNCTION operation description

MAIN

If MAIN button is pressed from FUNCTION-LIVE, the convenient setup screen, shown below, is displayed. If MAIN Menu setup is desired, press the MAIN button.



STATUS 

If STATUS button is clicked, information related to the system is displayed.

- ✓ SYSTEM INFORMATION 1 : Displays video recording program status information.
- ✓ SYSTEM INFORMATION 2 : Displays VERSION, IP ADDRESS, MAC ADDRESS and AUDIO information.

SYSTEM INFORMATION 1					SYSTEM INFORMATION 2	
RECORD MODE	M	M&E	PROGRAM	A	VIDEO	AUDIO
CH	M	Q	E	Q		
1	5	S	7	S	0.0 M/min	0 KB
2	5	H	7	S	0.0 M/min	0 KB
3	5	M	7	S	0.0 M/min	0 KB
4	5	L	7	S	0.0 M/min	0 KB
5	5	S	7	S	0.0 M/min	
6	5	H	7	S	0.0 M/min	
7	5	M	7	S	0.0 M/min	
8	5	L	7	S	0.0 M/min	
9	5	S	10	S	0.0 M/min	
10	5	S	10	S	0.0 M/min	
11	5	S	10	S	0.0 M/min	
12	5	S	10	S	0.0 M/min	
13	5	S	7	S	0.0 M/min	
14	5	S	7	S	0.0 M/min	
15	5	S	7	S	0.0 M/min	
16	5	S	7	S	0.0 M/min	

SVR-1650E

SYSTEM INFORMATION 1					SYSTEM INFORMATION 2	
RECORD MODE	M	M&E	PROGRAM	K	IMAGE SIZE	704 X 240
CH	M	Q	E	Q	VIDEO	AUDIO
1	5	H	10	S	0.0 M/min	0 KB
2	5	H	10	S	0.0 M/min	0 KB
3	5	H	10	S	0.0 M/min	0 KB
4	5	H	10	S	0.0 M/min	0 KB
5	5	H	10	S	0.0 M/min	
6	5	H	10	S	0.0 M/min	
7	5	H	10	S	0.0 M/min	
8	5	H	10	S	0.0 M/min	
9	5	H	10	S	0.0 M/min	
10	5	H	10	S	0.0 M/min	
11	5	H	10	S	0.0 M/min	
12	5	H	10	S	0.0 M/min	
13	5	H	10	S	0.0 M/min	
14	5	H	10	S	0.0 M/min	
15	5	H	10	S	0.0 M/min	
16	5	H	10	S	0.0 M/min	

SVR-1640A

SYSTEM INFORMATION 1					SYSTEM INFORMATION 2	
RECORD MODE	M	M&E	PROGRAM	K	IMAGE SIZE	704 X 240
CH	M	Q	E	Q	VIDEO	AUDIO
1	5	H	10	S	2.2 M/min	0 KB
2	5	H	10	S	2.3 M/min	0 KB
3	5	H	10	S	0.0 M/min	0 KB
4	5	H	10	S	0.0 M/min	0 KB
5	5	H	10	S	0.0 M/min	
6	5	H	10	S	0.0 M/min	
7	5	H	10	S	0.0 M/min	
8	5	H	10	S	0.0 M/min	
9	5	H	10	S	0.0 M/min	

SVR-950E

SYSTEM INFORMATION 1	SYSTEM INFORMATION 2
FIRMWARE VERSION	v 1.9a
N/W FIRMWARE VERSION	v 1.9a
IP ADDRESS	192.168.001.076
MAC ADDRESS	00 00 00 aa bb cc
AUDIO	OFF
AVERAGE DATA RATES	1.0 M/min
HDD TOTAL SIZE	147456 MB
TOTAL RECORDABLE TIME	98D 0H 21M
HDD FREE SIZE	124307 MB
CURRENT RECORDABLE TIME	82D 15H 4M



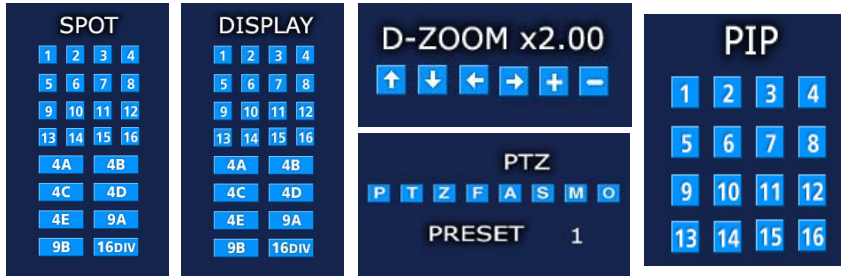

SVR-1650E/1640E/1640A

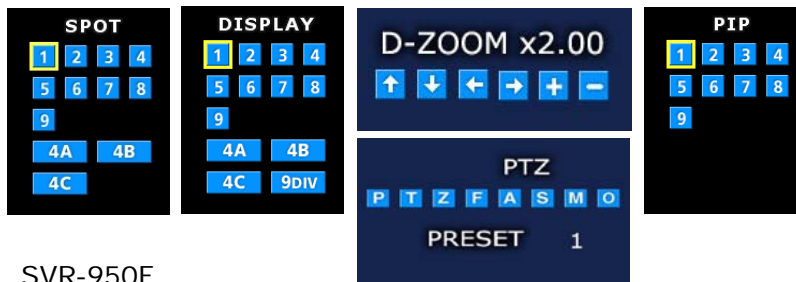

SVR-950E

SPOT

If SPOT button is clicked, the SPOT setup screen is displayed. SPOT monitor can be used to view SINGLE or divided screen.

DISPLAY

If MULTI button is clicked, the MULTI setup screen is displayed. Main monitor can be used for live observation in SINGLE screen or divided screen.

AUTO 

If AUTO button is pressed, each channel and 4 DIVISION screen, 9 DIVISION screen and 16 DIVISION screen(SVR-950E: 4 DIVISION screen, 9 DIVISION screen) are automatically converted and displayed in time interval which was setup in [Screen Setup]–[SEQUENCING] in the conversion menu.



In automatic screen conversion state, input from other buttons is not recognized. Push the AUTO button and cancel the Automatic screen conversion function before using other function buttons.

If an Event is generated and [EVENT]–[SWITCH TO EVENT SCREEN] is [ON] for [Event Setup], Automatic screen conversion function is halted for [EVENT DISPLAY MAX TIME] before resuming operation.

D-ZOOM 

If D-ZOOM button is clicked, zoom function for the installed camera can be used. D-ZOOM is scalable by 8 times.

PIP 

If PIP button is clicked, screen within a screen can be viewed in SINGLE mode. PIP function can be setup for every 16 channels(SVR-950E: 9 channels).

PTZ 

If PTZ button is clicked, detailed PRESET setup and PAN, TILT, ZOOM function for the dome camera that has already been installed can be used.

5.5 Menu screen description

Organization of the menu screen is as follows.

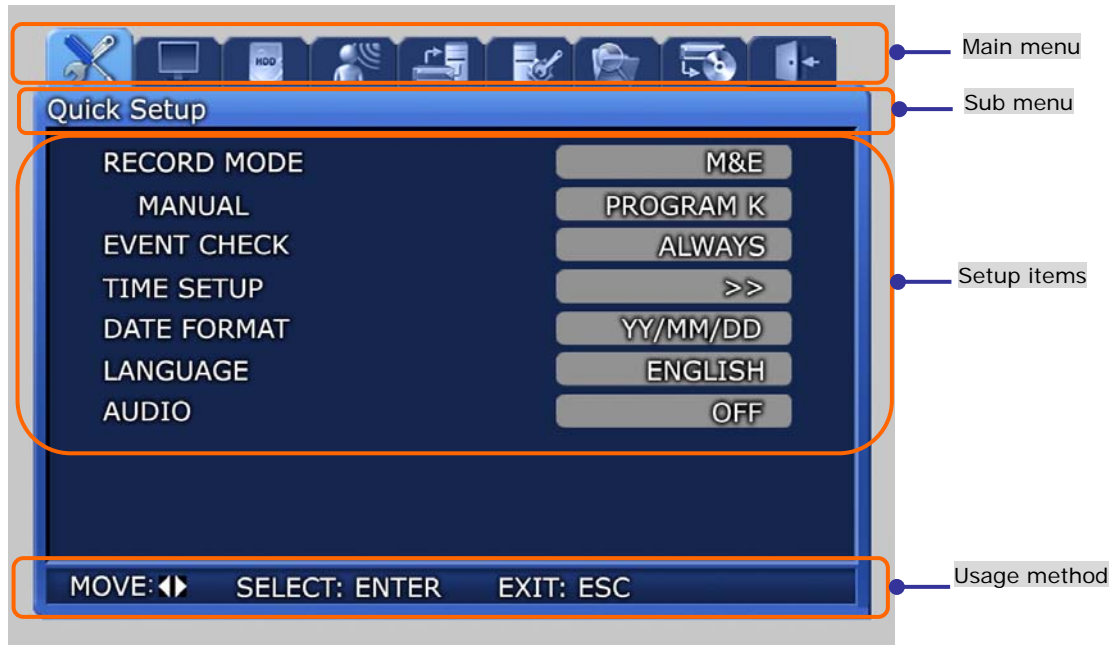

Description of all menu screen setup value selection and modification is based on the assumption that the mouse is used.

- ✓ Main menu : Main menu corresponding to each tab can be selected.
- ✓ Sub menu : Lower menu that can be setup from the main menu can be selected.
- ✓ Setup items : Setup items for the lower menu can be modified.
- ✓ Usage method : Usage method for the selected menu.
- ✓ Record setup may take some time. Please wait until it is completed.

5.6 Screen setup

If [Screen Setup] tab is clicked, lower menu related to [Screen Setup] is displayed as shown below. In screen setup, [SCREEN], [SEQUENCING], [DISPLAY], [COVERT], [SPOT] related setup values may be modified.

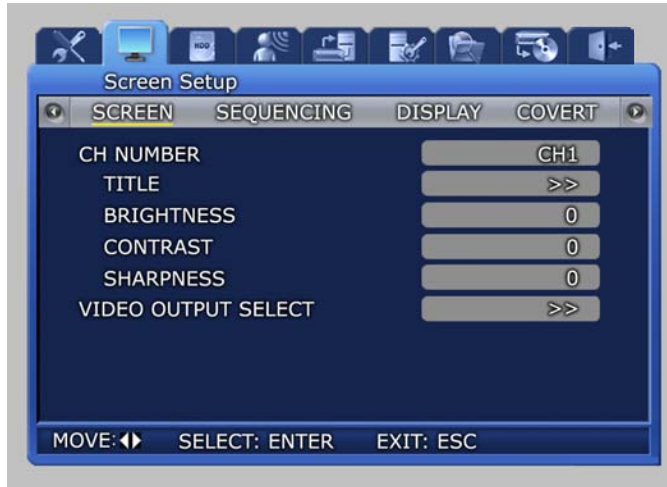

5

5.6.1 Screen

Select a channel among the 16 available (SVR-950E: select a channel among the 9 available) and setup the channel name, brightness and contrast for that channel. Each channel can be setup separately like this.



- ✓ TITLE : User can setup a title for each channel. A channel name consists of 8 characters including the channel number.

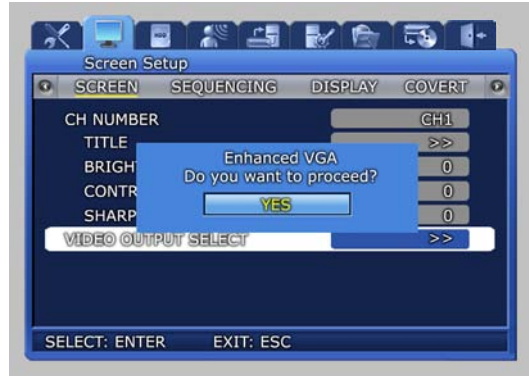
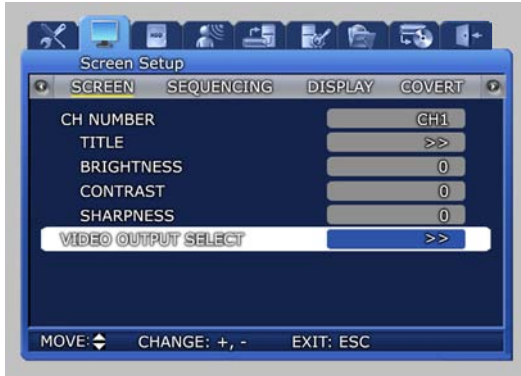

VIDEO OUTPUT SELECT

- ✓ Enhanced COMPOSITE: May be selected when current mode is 'Enhanced VGA'. Both COMPOSITE output and VGA output is possible and values from -9 to 9 may be setup for 'CONTRAST'. In 'Enhanced COMPOSITE', image quality for VGA output may degrade slightly.
- ✓ Enhanced VGA : May be selected when current mode is 'Enhanced COMPOSITE'. Only VGA output is possible and values from -7 to 7 may be setup for 'CONTRAST'. Better image quality than that for VGA output in 'Enhanced COMPOSITE' may be obtained.



When 'Enhanced VGA' is selected and VGA output cannot be viewed, press the following keys in order from the DVR front panel to change to 'Enhanced COMPOSITE': '+' , '1' , '2' , '3' , '4' , '2' , '3' , '4' , '1' , 'ENTER'

5.6.2 Sequencing

Automatic screen conversion function for the live screen can be setup.

Channels are displayed after every set time interval, after automatic conversion, in the following order:
[MULTI MODE]

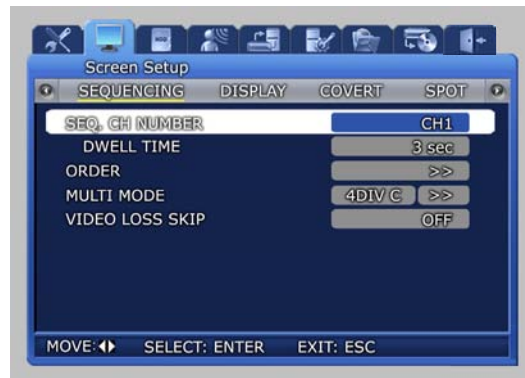
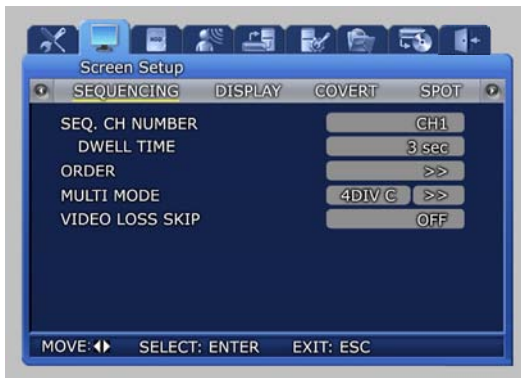

- ✓ SEQ. CH NUMBER : Setup the screen display duration for each channel. Setup range is Channel 1~16(SVR-950E: channel 1~9), ALL.

- ✓ DWELL TIME : Setup the conversion display duration. Setup range is SKIP, 1~99 sec.



SVR-1650E/1640A



SVR-950E



- ✓ ORDER : Setup whole channels that will be converted.
- ✓ User defined screen
 - 4DIV C : SVR-950E
 - 4DIV E : SVR-1650E/1640A
 - It sets the user defined screen with 4-partitioned segments for 4 channels.
 - 9DIV B : It sets the user defined screen with 9-partitioned segments for 9 channels.
 - (This function is not supported by a SVR-950E series.)

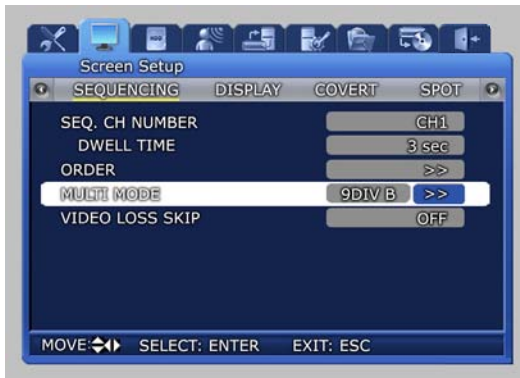

VIDEO LOSS SKIP [ON/OFF] : If setup as [ON], channels without image signals will be skipped automatically and only channels with image signals will be displayed in the screen.

5.6.3 Display

Information to be displayed on the live screen can be selected.

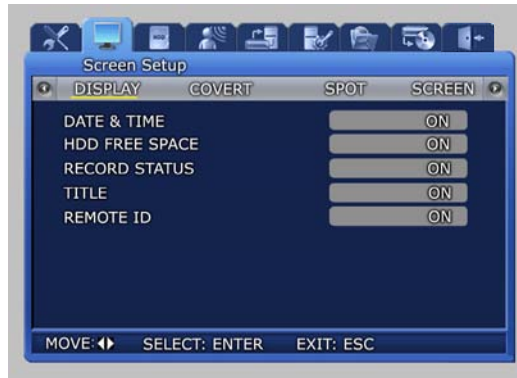

- ✓ DATE & TIME [ON/OFF] : If setup as [ON], current time is displayed in the live screen.
- ✓ HDD FREE SPACE [ON/OFF] : If setup as [ON], remaining capacity for the mounted hard disk drive is displayed.
- ✓ RECORD STATUS [ON/OFF] : If setup as [ON], video recording status display([NNNN]) is displayed in the upper right area of the screen during video recording.
- ✓ TITLE [ON/OFF] : If setup as [ON], titles for Channel 1 ~ 16(SVR-950E: channel 1~9), set by the user in the channel name lower menu, is displayed in the live screen.
- ✓ REMOTE ID [ON/OFF] : If setup as [ON], ID number of the remote controller is displayed on the screen.



For details on video recording status display, refer to '5.4 Record setup'.

5.6.4 Covert

One channel among the 16 available(SVR-950E: among the 9channel) may be selected to setup the image hiding function.



- ✓ LIVE COVERT : If image hiding is turned ON, image is not shown for live screen as in V-LOSS and privacy can be protected.
- ✓ PLAYBACK COVERT : If Playback Covert is turned ON, recorded images stored in HDD cannot be played back.

5.6.5 SPOT

Setup items for the SPOT monitor.



- ✓ TITLE DISPLAY : Determines if title is to be displayed in the SPOT monitor. (This function is not supported by a SVR-950E series.)
- ✓ SPOT MODE : If you have set it to "MANUAL" and you want to switch to a different channel, then press the FUNCTION button located on the front panel of the product and then select the SPOT menu. For MANUAL setup, screen channel is converted by the button located in front of the product. For SEQUENCE setup, screen is converted automatically in setup order to the SPOT monitor.
- ✓ SPOT EVENT SCREEN : If setup as ON and an event is generated, it is converted to that screen.

5.7 Record setup

If the mouse is moved over the [Record Setup] tab, a video recording related lower menu is displayed as shown below. If 'ENTER' key, located in the front of DVR, is pressed or if lower level menu is selected with the mouse, detailed items may be viewed.



5.7.1 Record mode

Record mode setups manual and scheduled recording mode.



- ✓ M & E : Manual setup. If REC button is pressed, video recording is carried out.
- ✓ S & E : Video recording is carried out automatically according to the setup reserved schedule.
- ✓ PRE EVENT DURATION : The amount of time before an event is setup and automatic video recording is carried out for this amount of time.
- ✓ POST EVENT DURATION : The amount of time after an event is setup and automatic video recording is carried out for this amount of time.
- ✓ REPEAT RECORD MODE : If HDD capacity is used up during video recording, recording will be continued by overwriting the data at the front of the HDD.



ON: If there is no more space left in the HDD, repetitive video recording will be carried out by overwriting the oldest data.

OFF: If there is no more space left in the HDD, video recording will be halted.

- ✓ **WARNING LEVEL** : If available space in the hard disk drive reaches the setup percentage, a warning message will be displayed to the user. Possible setup range is 1 ~ 10% and 5 ~ 10% is generally used.
- ✓ **AUDIO** : Select whether to store voice information.

Scheduled video recording mode can be used to setup the date and time when video recording will be carried out automatically.



❖ **Setting Method**

- ✓ As you set INDEX, DAY, PROGRAM and HOUR, then the content will be immediately displayed in the table.
- ✓ If you select the start time and the stop time for recording in the table and click on them in order, the content will be displayed in INDEX, DAY, PROGRAM and HOUR.

❖ **Deletion Method**

- ✓ Select the desired INDEX and then click on the Delete button. If you click on the Delete button before selecting INDEX, then the content of INDEX that was selected previously will be deleted first. After that, the content in the highest INDEX will be deleted and then others INDEX will be deleted in the increasing order of INDEX.

❖ **Editing Method**

- ✓ Select the INDEX to be edited and then change DAY, PROGRAM and HOUR on your own.
- ✓ If all the INDEX fields up to INDEX 50 are already set, then click on the time in the table to be edited with your mouse. Click on the hour in the table to be changed, again with your mouse. The previous setting will be deleted and overwritten with the change that you have just made.

❖ **Caution**

- ✓ If the same time is set twice then '?' will be displayed in the table.
- ✓ When you set the region of time, you may not include the existing time that is set previously.

5.7.2 Record program



SVR-1650E



SVR-1640A

- ✓ In the SVR-1650E series, it is possible to assign a different resolution to each group.
- ✓ Each group is comprised of the four channels as follows.
Group1: Channel1~4, Group2: Channel5~8, Group3: Channel9~12, Group4: Channel13~16



SVR-950E

[PROGRAM] can be used to adjust the FRAME RATE, QUALITY and RESOLUTION to setup video recording for M&E and S&E.

A program may be selected or directly setup depending on the desired number of frames and resolution. For event recording, setup is possible for up to the maximum number of frames that can be stored in one channel.

If events occur in more than two channels, the number of frames recorded can be adjusted automatically.



- Video recording quality can be setup as Low, Middle, High or Super. When an event occurs, an image quality above High is recommended.
- M : Manual Framerate, Q : Manual Quality, E : Event Framerate, Q : Event Quality
- Program : Each video recording quality and channel values have A~T program.

5.7.3 Recording time table

NTSC (Installed Hard disk : 250G) FRAME, Recording capacity by picture quality

SVR-1650E

704 x 480	SUPER		HIGH		MID		LOW	
120	1 Day	5 Hour	1 Day	16 Hour	2 Day	14 Hour	7 Day	15 Hour
80	1 Day	10 Hour	1 Day	23 Hour	3 Day	10 Hour	11 Day	11 Hour
64	1 Day	19 Hour	2 Day	11 Hour	4 Day	7 Hour	14 Day	8 Hour
30	3 Day	20 Hour	5 Day	5 Hour	9 Day	4 Hour	30 Day	14 Hour
16	7 Day	5 Hour	9 Day	20 Hour	17 Day	5 Hour	57 Day	9 Hour
8	14 Day	11 Hour	19 Day	16 Hour	34 Day	10 Hour	114 Day	18 Hour
4	28 Day	23 Hour	39 Day	8 Hour	68 Day	20 Hour	229 Day	13 Hour

704 x 240	SUPER		HIGH		MID		LOW	
240	1 Day	4 Hour	1 Day	15 Hour	2 Day	14 Hour	7 Day	15 Hour
180	1 Day	13 Hour	2 Day	4 Hour	3 Day	11 Hour	10 Day	4 Hour
120	2 Day	8 Hour	3 Day	6 Hour	5 Day	5 Hour	15 Day	7 Hour
60	3 Day	16 Hour	5 Day	2 Hour	8 Day	8 Hour	30 Day	14 Hour
32	6 Day	21 Hour	9 Day	13 Hour	15 Day	15 Hour	57 Day	9 Hour
16	13 Day	18 Hour	19 Day	3 Hour	31 Day	7 Hour	114 Day	18 Hour
8	27 Day	13 Hour	38 Day	6 Hour	62 Day	14 Hour	229 Day	13 Hour
4	55 Day	2 Hour	76 Day	12 Hour	125 Day	5 Hour	459 Day	3 Hour

352 x 240	SUPER		HIGH		MID		LOW	
480	1 Day	4 Hour	1 Day	13 Hour	2 Day	13 Hour	7 Day	15 Hour
320	1 Day	19 Hour	2 Day	8 Hour	3 Day	19 Hour	11 Day	11 Hour
240	2 Day	9 Hour	3 Day	3 Hour	5 Day	2 Hour	15 Day	7 Hour
120	4 Day	19 Hour	6 Day	7 Hour	10 Day	4 Hour	30 Day	14 Hour
64	6 Day	21 Hour	9 Day	13 Hour	15 Day	15 Hour	57 Day	9 Hour
32	13 Day	18 Hour	19 Day	3 Hour	31 Day	7 Hour	114 Day	18 Hour
16	27 Day	13 Hour	38 Day	6 Hour	62 Day	14 Hour	229 Day	13 Hour
8	55 Day	2 Hour	76 Day	12 Hour	125 Day	5 Hour	459 Day	3 Hour
4	110 Day	4 Hour	153 Day	1 Hour	250 Day	10 Hour	918 Day	7 Hour

SVR-1640A/950E(* Basic mount HDD of SVR-950E is 160GB.)

704 x 480	SUPER		HIGH		MID		LOW	
30	3 Day	22 Hour	5 Day	14 Hour	9 Day	14 Hour	30 Day	5 Hour
16	7 Day	14 Hour	9 Day	22 Hour	17 Day	14 Hour	57 Day	22 Hour
8	14 Day	5 Hour	19 Day	20 Hour	34 Day	5 Hour	114 Day	21 Hour
4	28 Day	11 Hour	39 Day	16 Hour	68 Day	10 Hour	229 Day	19 Hour

704 x 240	SUPER		HIGH		MID		LOW	
60	3 Day	3 Hour	2 Day	22 Hour	4 Day	21 Hour	15 Day	23 Hour
32	6 Day	10 Hour	4 Day	18 Hour	7 Day	19 Hour	22 Day	22 Hour
16	13 Day	21 Hour	9 Day	13 Hour	15 Day	15 Hour	45 Day	21 Hour
8	27 Day	18 Hour	19 Day	3 Hour	31 Day	7 Hour	91 Day	19 Hour
4	55 Day	13 Hour	38 Day	6 Hour	62 Day	14 Hour	183 Day	15 Hour

352 x 240	SUPER		HIGH		MID		LOW	
120	2 Day	3 Hour	2 Day	20 Hour	4 Day	19 Hour	16 Day	16 Hour
64	4 Day	1 Hour	5 Day	9 Hour	9 Day	1 Hour	31 Day	7 Hour
32	6 Day	21 Hour	9 Day	13 Hour	15 Day	15 Hour	45 Day	21 Hour
16	13 Day	18 Hour	19 Day	3 Hour	31 Day	7 Hour	91 Day	19 Hour
8	27 Day	13 Hour	38 Day	6 Hour	62 Day	14 Hour	183 Day	15 Hour
4	55 Day	2 Hour	76 Day	12 Hour	125 Day	5 Hour	367 Day	7 Hour

PAL (Installed Hard disk : 250G)

SVR-1650E

704 x 480	SUPER		HIGH		MID		LOW	
100	1 Day	5 Hour	1 Day	13 Hour	2 Day	10 Hour	7 Day	20 Hour
50	2 Day	0 Hour	2 Day	18 Hour	4 Day	9 Hour	13 Day	18 Hour
25	4 Day	0 Hour	5 Day	12 Hour	8 Day	19 Hour	27 Day	13 Hour
16	6 Day	6 Hour	8 Day	14 Hour	13 Day	18 Hour	43 Day	1 Hour
8	12 Day	12 Hour	17 Day	5 Hour	27 Day	13 Hour	86 Day	2 Hour
4	25 Day	1 Hour	34 Day	10 Hour	55 Day	2 Hour	172 Day	4 Hour

704 x 240	SUPER		HIGH		MID		LOW	
200	1 Day	5 Hour	1 Day	12 Hour	2 Day	12 Hour	7 Day	20 Hour
100	2 Day	10 Hour	3 Day	1 Hour	5 Day	0 Hour	15 Day	17 Hour
50	3 Day	16 Hour	5 Day	4 Hour	8 Day	19 Hour	27 Day	13 Hour
32	5 Day	17 Hour	8 Day	2 Hour	13 Day	18 Hour	43 Day	1 Hour
16	11 Day	11 Hour	16 Day	4 Hour	27 Day	13 Hour	86 Day	2 Hour
8	22 Day	22 Hour	32 Day	9 Hour	55 Day	2 Hour	172 Day	4 Hour
4	45 Day	21 Hour	64 Day	19 Hour	110 Day	4 Hour	344 Day	8 Hour

352 x 240	SUPER		HIGH		MID		LOW	
400	1 Day	2 Hour	1 Day	12 Hour	2 Day	12 Hour	7 Day	20 Hour
200	2 Day	4 Hour	3 Day	1 Hour	5 Day	0 Hour	15 Day	17 Hour
100	4 Day	9 Hour	6 Day	2 Hour	10 Day	0 Hour	31 Day	11 Hour
48	7 Day	15 Hour	10 Day	10 Hour	16 Day	9 Hour	57 Day	9 Hour
32	11 Day	11 Hour	15 Day	15 Hour	24 Day	14 Hour	86 Day	2 Hour
16	22 Day	22 Hour	31 Day	7 Hour	49 Day	4 Hour	172 Day	4 Hour
8	45 Day	21 Hour	62 Day	14 Hour	98 Day	9 Hour	344 Day	8 Hour
4	91 Day	19 Hour	125 Day	5 Hour	196 Day	18 Hour	688 Day	17 Hour



SVR-1640A/950E

704 x 480	SUPER		HIGH		MID		LOW	
25	2 Day	0 Hour	2 Day	18 Hour	4 Day	9 Hour	11 Day	0 Hour
16	3 Day	3 Hour	4 Day	7 Hour	6 Day	21 Hour	17 Day	5 Hour
8	6 Day	6 Hour	8 Day	14 Hour	13 Day	18 Hour	34 Day	10 Hour
4	12 Day	12 Hour	17 Day	5 Hour	27 Day	13 Hour	68 Day	20 Hour

704 x 240	SUPER		HIGH		MID		LOW	
50	2 Day	2 Hour	2 Day	22 Hour	4 Day	21 Hour	14 Day	16 Hour
32	2 Day	20 Hour	4 Day	1 Hour	6 Day	21 Hour	17 Day	5 Hour
16	5 Day	17 Hour	8 Day	2 Hour	13 Day	18 Hour	34 Day	10 Hour
8	11 Day	11 Hour	16 Day	4 Hour	27 Day	13 Hour	68 Day	20 Hour
4	22 Day	22 Hour	32 Day	9 Hour	55 Day	2 Hour	137 Day	17 Hour

352 x 240	SUPER		HIGH		MID		LOW	
100	2 Day	0 Hour	2 Day	22 Hour	4 Day	21 Hour	14 Day	16 Hour
48	4 Day	4 Hour	6 Day	2 Hour	10 Day	4 Hour	30 Day	14 Hour
32	5 Day	17 Hour	7 Day	19 Hour	12 Day	7 Hour	34 Day	10 Hour
16	11 Day	11 Hour	15 Day	15 Hour	24 Day	14 Hour	68 Day	20 Hour
8	22 Day	22 Hour	31 Day	7 Hour	49 Day	4 Hour	137 Day	17 Hour
4	45 Day	21 Hour	62 Day	14 Hour	98 Day	9 Hour	275 Day	11 Hour

5.8 Event setup

For event video recording, a lower menu like the one shown below can be setup. If 'ENTER' key, located in the front of DVR, is pressed or if lower level menu is selected with the mouse, detailed items may be viewed.

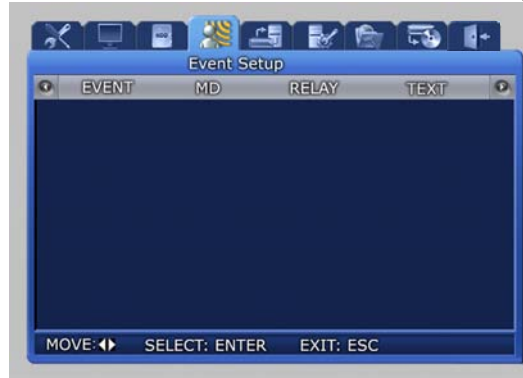

5.8.1 Event



- ✓ CHECK : Setup whether to check and store events. [Application time setup] will be activated only if [Event application time] is setup as [Time application].
- ✓ MESSAGE [ON/OFF] : Select whether to display event items on screen with text.
- ✓ BUZZER : Select whether to sound the buzzer when an alarm is generated.
- ✓ SWITCH TO EVENT SCREEN : Setup whether to convert the screen to the corresponding

channel when an event occurs.

- ✓ EVENT DISPLAY MIN TIME : Min. retention time for the screen when an event occurs (Amount of time to ignore an event if consecutive events are generated) is set within 0 ~ 5 seconds.
- ✓ EVENT DISPLAY MAX TIME : Max. retention time for the screen when an event occurs is set within 0 ~ 99 seconds or allways. [Maintain current state] During setup, display the screen in which the event was generated continuously.
- ✓ TEXT MONITORING : Determine whether to save characters input from external devices through RS-232.
- ✓ SENSOR TYPE : Setup the sensor type for the channel.(NO/NC)



NO : Open type (Normal Open) sensor.

NC : Closed type (Normal Close) sensor.

[Max. retention time] cannot be setup with a smaller value than [Min. retention time].

5.8.2 Motion detection

Analyze the image input by the camera to detect motion. If any change is detected, it is counted as an event.

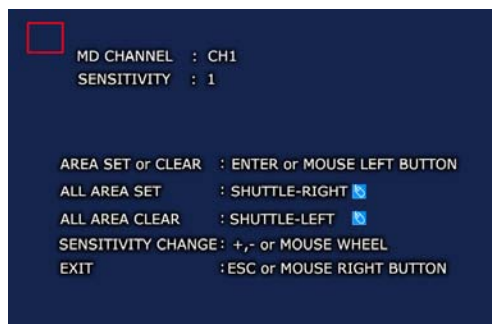
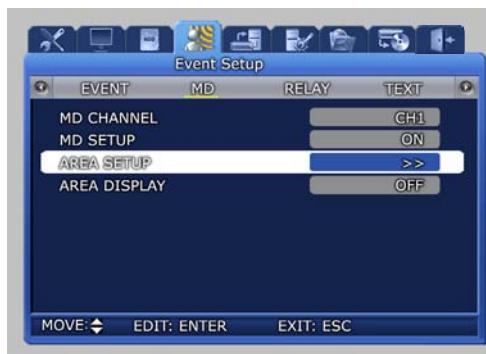

Area selection can be carried out by clicking the mouse icon on the screen or by turning the shuttle ring on the product to the right. To cancel, rotate the shuttle ring to the left.

Press the right button of mouse or ESC button on the front panel to go back to the main menu

Min SENSITIVITY: 1, Max SENSITIVITY : 5

- ✓ MD CHANNEL : Setup the channel for which motion detection will be carried out.
- ✓ MD SETUP : Setup whether to detect motion for channel that will be used for motion detection.
- ✓ AREA SETUP : Setup motion detection for each channel and specify the sensitivity and area with the mouse.
- ✓ AREA DISPLAY : If motion is detected, area related to motion can be displayed.

5.8.3 Relay

When an event occurs, you can generate RELAY during sensor, movement detection, lost images, power alarm and record off using the output device connected to the RELAY OUT terminal on the back side of the product.



Blinking green box indicates the state before selection. After selection, it turns yellow.

5.8.4 TEXT

This setup allows material input with equipment like a POS System to be viewed with DVR equipment. To match protocol with the input equipment, HEADER and DELIMITER are assigned and line to output to the screen is setup.



5.8.5 EVENT-PRESET

This function allows each Speed Dome Camera wired to the DVR for quick setup of event detection and positioning to the initial location allocated per each event such as sensor input or motion detection.

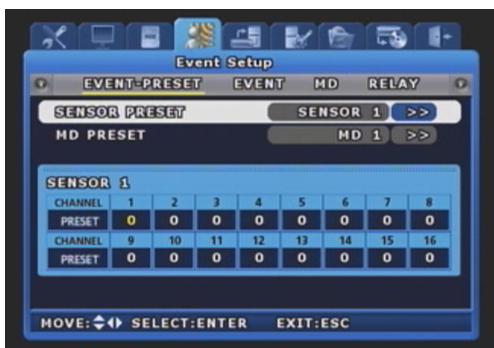

- ✓ **SENSOR PRESET:** Determine a preset number of each specific event sensor. When the preset sensor detects input signal, determine a PRESET number of each channel to command PRESET MOVE.
- ✓ **MD PRESET:** Determine a preset number of each specific sensor of MD event. When the preset channel tracks MD event, determine a PRESET number of channel to command PRESET MOVE.



- The system ignores repeated events detected in a channel within the time interval designated in the 'LEAST HALT TIME' zone of submenu 'EVENT' of 'EVENT CONFIGURATION' menu.

- In case that the Speed Dome Camera receives consecutive PRESET MOVE commands issued by events with short time interval, delay of MOVE command execution or command cancellation can happen owing to reaction speed limitation of the camera.

- SPD Model: The system will cancel any new PRESET MOVE command during execution of previous PRESET MOVE command, i.e., the system executes any new PTZ command only after the completion of ongoing MOVE command.

- It is recommended not use PRESET MOVE function of 'ALARM MANAGER' menu of Network Manager Program during execution of EVENT-PRESET function of DVR.

- During manual execution of PTZ control with controller, remote network program, touch panel key and so forth, Event-Preset command issued by new event may collide with ongoing manual PTZ control, hence, required PRESET MOVE command or manual PTZ control may not function.



If you have installed Speed Dome Cameras from multiple suppliers, you are strongly recommended to use single program protocol for all.

5.9 Communication setup

Setup items needed to connect a computer to a network. Communication setup screen is as shown below. If 'ENTER' key, located in the front of DVR, is pressed or if lower level menu is selected with the mouse, detailed items may be viewed.

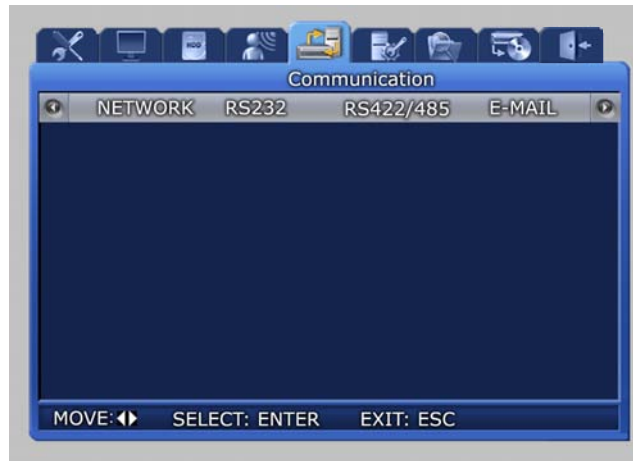

5.9.1 NETWORK

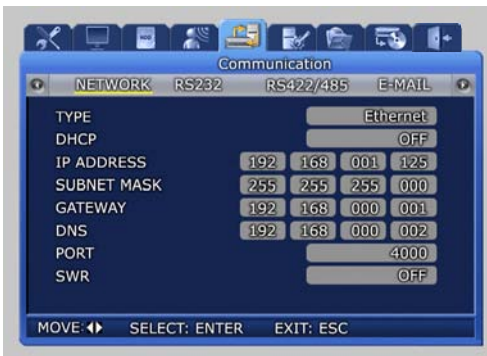

- ✓ DHCP [ON/OFF]: DVR is automatically granted IP by DHCP server, it activates DHCP function. 'DHCP' is used in LAN environment where DHCP server operates. Generally for the middle/large size, DHCP server is operated by LAN and for the small size, DHCP function of IP router is generally used.
- ✓ DHCP [ON/OFF] : Select whether to get the IP address automatically using the Dynamic Host Configuration Protocol.
- ✓ TYPE [Ethernet/xDSL] : Select the network type connected to the DVR.



You are recommended to reboot your DVR when changing the type of communication line.

Especially, when switching to Ethernet from xDSL or DHCP, first switch the line type to Ethernet and the save the changes.

Then, reboot your DVR. When rebooting is completed, make sure to check whether the line has been successfully switched to an Ethernet-type.

After that, enter the IP Address that you want to use.

- ✓ SUBNET MASK : Input the [SUBNET MASK] address obtained from the internet service company of the user.
- ✓ GATEWAY : Input the [GATEWAY] address obtained from the internet service company of the user.
- ✓ DNS : Input the [DNS] address obtained from the internet service company of the user.
- ✓ PORT : [PORT] assigned when connecting to a computer can be changed. If port is changed in the DVR, When the network setup is changed, it takes time to setup the network module again. Connect after 1~2 minutes. Port number can be setup depending on network conditions (firewall etc.).
DEFAULT PORT : 4000
- ✓ SWR : If the product is connected to a cable modem or a xDSL modem, IP address will change each time connection to ISP (User's communication company server) is attempted. In this case, the user will not know the changed IP address. If a product using a floating IP is registered on the SWR server, the changed IP can be found when attempting connection with the product. To register an IP address on the SWR, setup [SWR] item to ON. Changed IP address can be verified from FUNCTION-STATUS (SYSTEM INFORMATION 2).

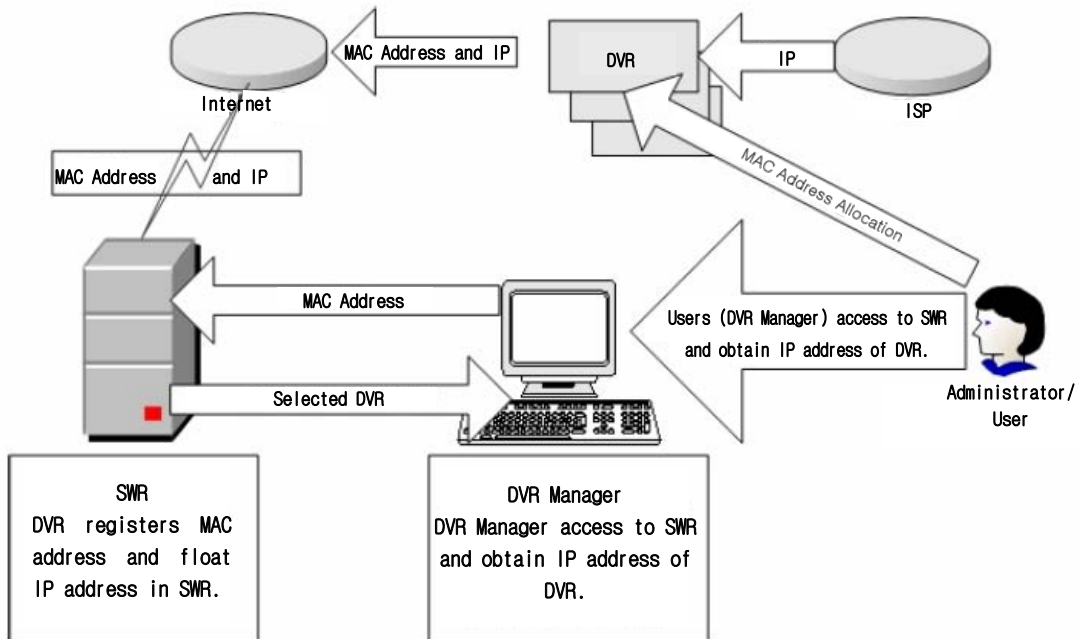



If using network by connecting the DVR body with IP router, you should designate a port for DVR from the Setup Menu of the IP router. The main body of SVR-1650E/1640A/950E uses 2 ports for TCP communication. In addition, it uses DHCP function supported by IP router. Even if dynamically allocating IP address to the main body of DVR for use, you should designate a port for IP, which DVR receives from the Setup Menu of IP router. If using a IP router, previously designate IP allocated to the DVR main body and port numbers from the Setup Menu of the IP router, not using DHCP function, and set access mode to the static IP in the DVR main body, and it is recommended to directly input IP designated to the IP router.

For method to set IP router, refer to manual of IP router or contact the manufacturer.

5.9.2 RS-232

Setup items needed to connect with the computer connected to the product through the serial port.



- ✓ BAUD RATE : Setup the data transmission speed per second.
- ✓ DATA BIT : Setup the data transmission bit.
- ✓ PARITY BIT : Setup the error check method for data transmission.
- ✓ STOP BIT : Setup bit to include when data transmission has been completed.

5.9.3 RS-422/485

Setup items needed to connect the product with surveillance equipment like camera and CCTV.



- ✓ SYSTEM ID : Setup ID for DVR main body when connecting the product with equipment like a controller.
- ✓ PORT TYPE: Setup type of port to use.
 - PORT A: Connect the SCC-3100A controller.
 - PORT B: Connect the speed dome.
 - Control method
 - Controller : Connect PORT A and controller with RS422/485.
Setup the SYSTEM ID corresponding to the connected SCC-3100A.
(Refer to page 30)
 - Speed dome : Connect PORT B and speed dome with RS422/485.
After moving SYSTEM → PTZ, setup protocol for each channel and the ID for the speed dome. (Refer to page 103)
- ✓ BAUD RATE : Setup the data transmission speed per second.
- ✓ DATA BIT : Setup the data transmission bit.
- ✓ PARITY BIT : Setup the error check method for data transmission.
- ✓ STOP BIT : Setup bit to include when data transmission has been completed.

5.9.4 E-MAIL

The manager can verify details related to the generated event through the email.

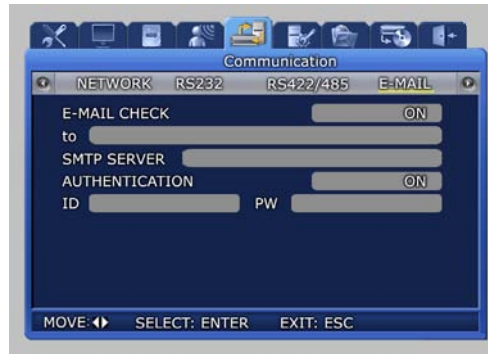

- ✓ E-MAIL CHECK : If turned [ON], E-MAIL notice function is activated.
- ✓ to : Setup the E-MAIL address to receive a transmission if an event occurs.
Ex) to : user@yahoo.com
- ✓ SMTP SERVER : This is a standard protocol for transmitting e-mail and used to prevent e-mail from spam mail. You must have a User ID for using e-mail.
Ex) SMTP SERVER : kornet.net
- ✓ AUTHENTICATION: Used during user account registration.

5.9.5 DDNS Configuration



- ✓ SWR : Decide the use of SWR function.
The SWR provides same function as below (DDNS), but this mode doesn't support connection by using ID.
- ✓ DDNS : Decide the use of DDNS function.
The DDNS function supports to connect web-server directly regardless of change of IP.
- ✓ SERVER : Enter the DDNS server address.
Ex) SMTP SERVER : kornet.net
- ✓ Enter the ID & Password used to register product at iPOLIS website.



Please take notice that user of SVR-1640A and SVR-950E must reboot after changing network configuration.

5.9.6 DDNS Registration

DDNS Registration Procedure

Step1) Sign up at iPOLiS website

The website : www.samsungipolis.com



Figure5-1. iPOLiS Homepage

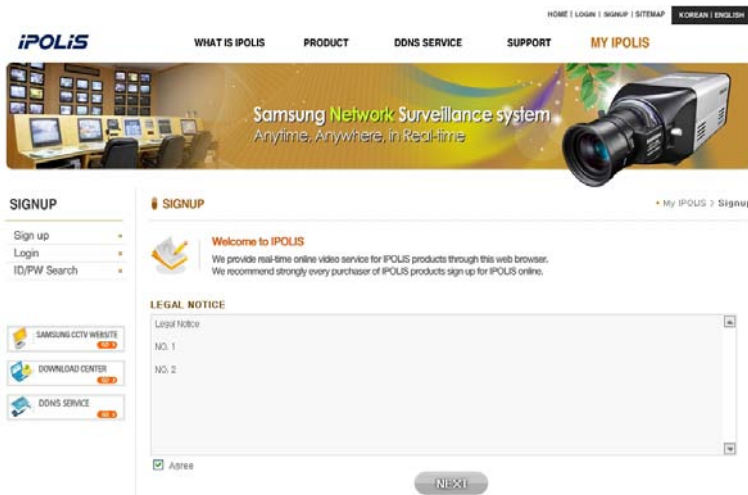

Figure5-2. Agreement the general terms and conditions

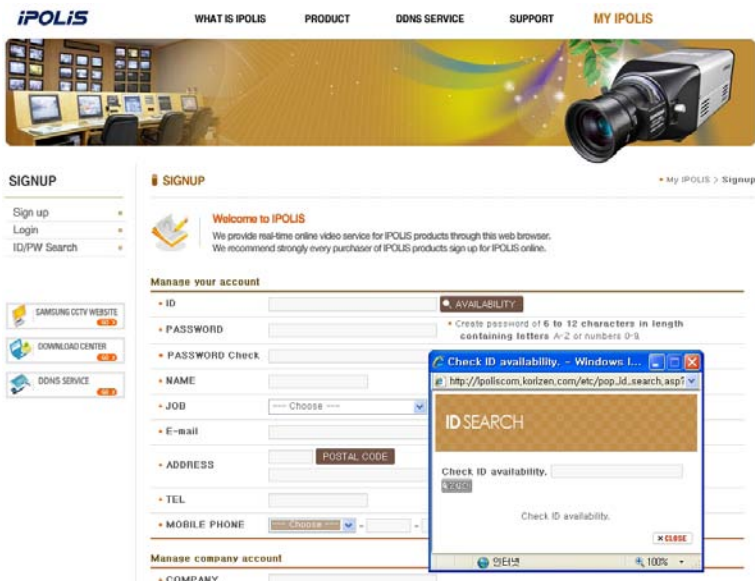

Figure5-3. SIGN UP page: check ID availability

5

Step2) The product registration is possible after sign up.

WELCOME to **IPOLiS** !

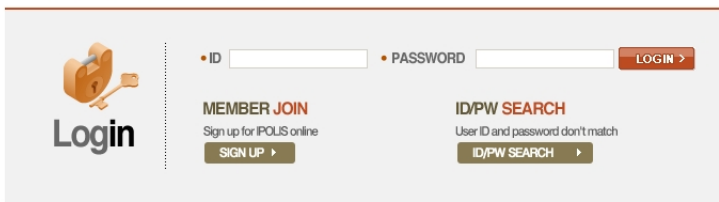

Figure5-4. Sign in at iPOLiS website

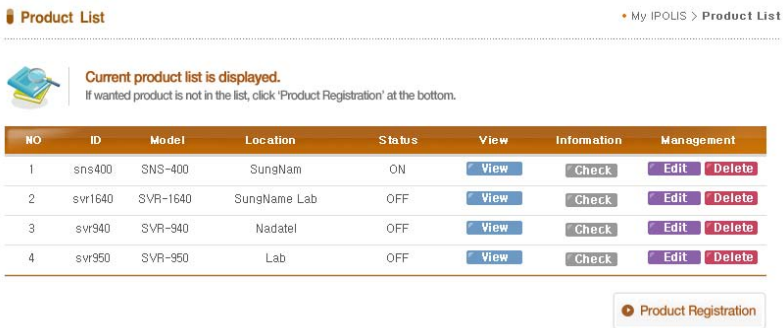

Figure5-5. Product List (If you didn't register products, there are no list)

Product Registration

My IPOLIS > Product Registration

Mandatory Information

http://www.samsungipolis.com/ AVAILABILITY

ID(domain) *
 - Create an ID of 4 to 12 characters in length containing letters A-Z or numbers 0-9.
 - You should have exactly same ID with the...
 - Make sure the correct ID and click the ite...
 - You may not able to change the initial dom...

PASSWORD *

PASSWORD CHECK *

CLASSIFICATION * --- Choose ---

MODEL NUMBER * --- Choose ---

LOCATION *
 - Determine the location to install the system...
 - Designate the installation location within 1...

DESCRIPTION
 - Describe product for management purpose.

Registration > Cancel >

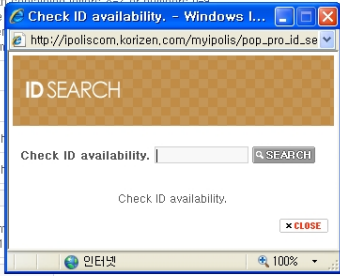

Figure5-6. Product Registration (Check ID availability)

Product List

My IPOLIS > Product List

Current product list is displayed.
 If wanted product is not in the list, click 'Product Registration' at the bottom.

NO	ID	Model	Location	Status	View	Information	Management
1	sns400	SNS-400	SungNam	ON	View	Check	Edit Delete
2	svr1640	SVR-1640	SungName Lab	OFF	View	Check	Edit Delete
3	svr940	SVR-940	Nadatel	OFF	View	Check	Edit Delete
4	svr950	SVR-950	Lab	OFF	View	Check	Edit Delete

[Product Registration](#)

Figure5-7. Check the registration at product list

Step3) Configuration DDNS at DVR

Select [Network] > [DDNS] on OSD Menu.

- ✓ DDNS > 'ON'
- ✓ SERVER > Enter the DDNS server address(Default:www.samsungipolis.com)
- ✓ ID & PW > Enter the ID(Domain) & Password using the product registration at iPOLiS website.



The DDNS configuration is completed.



Step4) The connection status of selected product can check on product list.

Product List My iPOLiS > Product List

 **Current product list is displayed.**
If wanted product is not in the list, click 'Product Registration' at the bottom.

NO	ID	Model	Location	Status	View	Information	Management
1	sns400	SNS-400	SungNam	ON	View	Check	Edit Delete
2	svr1640	SVR-1640	SungName Lab	OFF	View	Check	Edit Delete
3	svr940	SVR-940	Nadatel	OFF	View	Check	Edit Delete
4	svr950	SVR-950	Lab	OFF	View	Check	Edit Delete

[Product Registration](#)

- ✓ [VIEW]: See the log-in page of selected product
- ✓ [Edit]/[Delete]: Edit/Delete the selected product, password is needed for checking



The product 'ID(domain)' can not change at registered status. When the product needs to change the ID, first of all, delete the desired product, and register product again.

5.10 System setup

System setup screen is as shown below. If 'ENTER' key, located in the front of DVR, is pressed or if lower level menu is selected with the mouse, detailed items may be viewed.

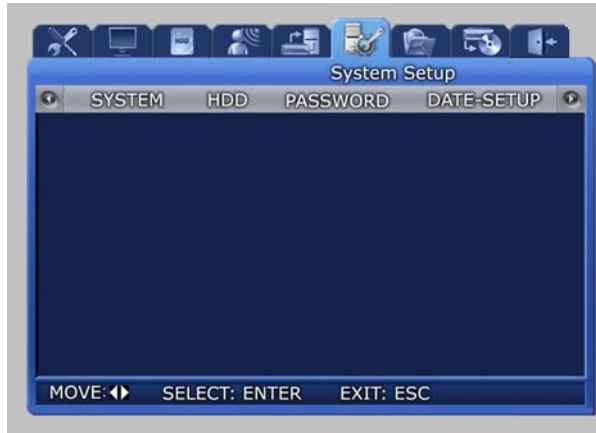

5.10.1 System



- ✓ LANGUAGE : Select a language for the menu screen.
- ✓ KEY BUZZER [ON/OFF] : Select whether to generate sound for key strokes when using the remote controller or when manipulating keys.
- ✓ DEFAULT : Use to get back the initial setup values the product was shipped with.
- ✓ If [Yes] is selected from the following screen, it will be initialized.



LOAD/SAVE CONFIGURATION

- ✓ LOAD: Call the setup file stored in the USB Memory Stick and change the DVR setup value.
- ✓ SAVE: Store the DVR setup value in the USB Memory Stick



This function is not compatible between SVR-1650E, SVR-1640A and SVR-950E. It may not be compatible with other firmware versions. Firmware version may be verified by pressing the "FUNC" button in front of the DVR. USB Memory Stick formatted in FAT32 format may not work.

- ✓ FIRMWARE DOWNLOAD : Download the firmware for upgrading the product software.



In general a user cannot upgrade. Upgrade must be carried out by a certified expert.

- ✓ If [Yes] is selected from the following screen, it will be upgraded.





✓ REMOTE LIVE MODE

Determines the frame and video quality of each channel of the network board.

There are single mode and quad mode. When single mode is selected, a window for setting the framerate and bitrate that is sent to the network for each channel can be displayed.

In auto mode, the network transmit data is regularly monitored and when the amount that is transferred drops, it automatically reduces the bitrate to compute the optimal transmission conditions.

(This mode is supported in only SVR-1650E/1640A.)

- ✓ REMOTE SETUP[ON/OFF] : Used to determine remote setup mode.
- ✓ DVR ALIAS : Used to identify network name.



The resolution and framerate of REMOTE LIVE MODE is different according to Recording Setup (SVR-950E)

5.10.2 HDD

'HDD' setups information for the mounted hard disk drive. Basic information related to HDD is displayed on the screen. Information for up to 4 hard disk drives can be viewed.

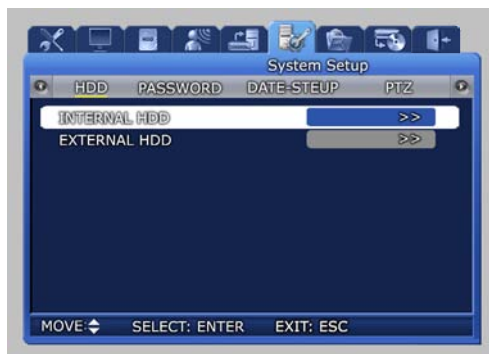

- ✓ INTERNAL HDD : You may view the information on the HDD included in the DVR.
- ✓ HDD FORMAT : Select whether to format the built-in, fixed HDD. If 'YES' is clicked in the confirmation dialog window, formatting is carried out.
- ✓ HDD : Setup can be for HDD1~HDD4 or ALL. Selection of HDD for format and information for the selected item will be displayed.

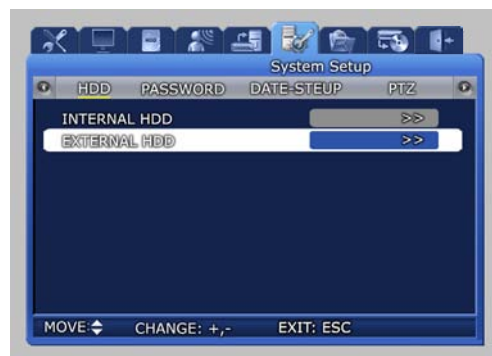

- ✓ EXTERNAL HDD : You may view the information on the external HDD connected to the outside of the DVR through HDD Extension Unit. (The Function it will be able to use to only the case which will connect the HDD Extension Unit)
- ✓ It is possible to select one from PORT1-HDD1~4, PORT2-HDD1~4, PORT3-HDD1~4, PORT4-HDD1~4, PORT1-ALL, PORT2-ALL, PORT3-ALL, PORT4-ALL. If you select the HDD to be formatted then the information on the HDD will be displayed. The four functions from PORT1-ALL to PORT4-ALL are used to divide a total of 16 units of HDD into four different groups in order.



If HDD is initialized (formatted), all information stored in the disk is deleted. (Initialization is not possible during video recording.)

5.10.3 Password

Setup password for user and manager to give authorization needed to use the product and to modify the setup. If 'ENTER' key, located in the front of DVR, is pressed or if lower level menu is selected with the mouse, detailed items may be viewed. One 'ADMIN' and 10 'USER' are supported. (10 users are displayed as 'USER1'~'USER10')



- ✓ USER AUTHORIZATION: Setup all user's password and authority. 'PASSWORD CHECK' should be "O" in the authorization table to setup authority of a specific function. (*Only 'ADMIN' is permitted.)
 - MENU: Setup the authority of menu.
 - PTZ: Setup the authority of PTZ.
 - R/OFF: Setup the authority of Reconing off
 - PB: Setup the authority of playback.
 - P/OFF: Setup the authority of power off.
 - P/ON: Setup the authority of power on.
 - N/MIC: Setup the authority of bidirectional audio.



- "X" (yellow color): That function is permitted to all users. (Password is unnecessary.)
- "O" (yellow color): Only authorized user is permitted though know the password.

- ✓ USER PASSWORD : Setup the user password. Passwords can only be setup using the buttons on DVR. Mouse cannot be used to setup passwords.
- ✓ BUZZER IF CHECKING FAILS : If wrong password is entered three times, the buzzer will go off.



System user authorization

- ADMIN: All system setup is allowed.
- USER1~USER10: Only allowed by authority.

Factory default password

ADMIN	11111111		
USER1	22222222	USER2	33333333
USER3	44444444	USER4	55555555
USER5	66666666	USER6	77777777
USER7	88888888	USER8	99999999
USER9	12344321	USER10	43211234

- Modified password should be saved on MENU to affect after rebooting.



Previous ADMIN's and USER1's password is kept after firmware upgrade.

5.10.4 Date setup

It is used to setup date and time for the product.

When setup is completed and stored, it is displayed on the live screen.



- ✓ **TIME SETUP** : Setup the date, time and defference from GMT. From the dialog box shown above, use the mouse wheel or the buttons on the front of the product to modify the setup value. Then select [SET] to make the assignment.
- ✓ **DATE FORMAT** : Setup format to use for date notation. Select from [year/month/day], [month/day/year], [day/month/year].
- ✓ **DAYLIGHT SAVING** : Setup whether to apply daylight savings time.
- ✓ **NTP CHECK**: Setup whether use network time protocol function or not.
- ✓ **NTP SERVER**: Input the name (ex. time.windows.com) or IP address of NTP server.



NTP means network time protocol that synchronizes the time of device or equipment through internet. DVR accesses to public NTP server and automatically synchronizes the time value. NTP server is alternative by local server which can synchronizes local time. As NTP server broadcasts GMT, DVR should be set also time difference between local and GMT.



If Check points when time synchronization fails.

- Please check network connection and setting.
- Please check NTP server setting. NTP SERVER should be public or permitted to access.
- Please check DNS sever setting. When NTP SERVER is set as server name not IP address, DNS server is necessary.

5.10.5 PTZ

If dome camera has been installed, camera ID can be assigned and setup for each channel to use the PAN, TILT, ZOOM functions.

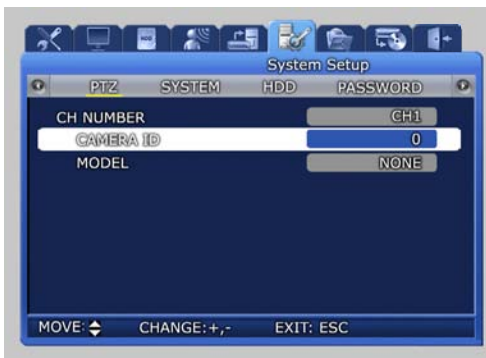
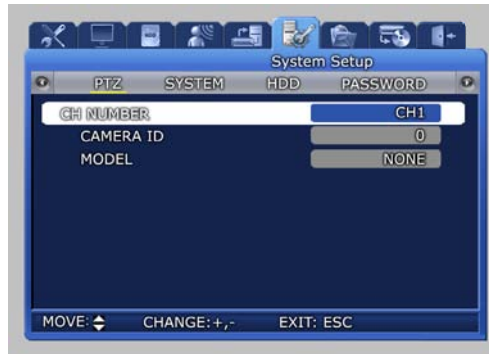
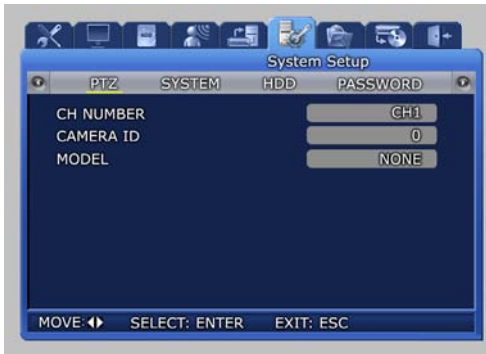

- ✓ CH NUMBER : For camera connected to each channel, assign an ID and setup the camera model.
- ✓ CAMERA ID : User can assign an ID between 0 ~ 255 for each camera.
- ✓ MODEL[None/SPD/PELCO(D)/PANASONIC/SCC/SRX/BOSCH] : Select the manufacturer for the connected camera. Signal input from a camera is different for each manufacturer. Please setup accurately for the corresponding model.



Models that can be used.

- Samsung : SPD(SPD-2200, 2300, 2500, 3000, 3300), SRX-100B
- Pelco(D) : Speed dome using Pelco 'D' protocol
- Panasonic : WV-CS854
- SCC : SCC-641/643
- Bosch : Bosch G3A series Speed dome

5.11 Video recording search

For video recording search, time, event and log file retrieval functions are provided. If 'ENTER' key, located in the front of DVR, is pressed or if lower level menu is selected with the mouse, detailed items may be viewed.

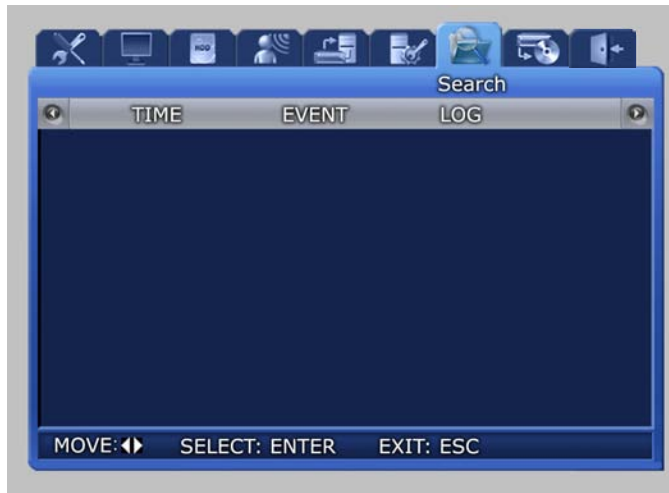

The above is same as '4.5. Search' after [SEARCH] button is pressed on DVR.

5.11.1 Time search

From HDD, recorded images can be searched by using TIME of CALENDAR.

In case of 'TIME', desired date and time that is within the range for dates and times the recordings were made is setup and [OK] button is pressed, the video recording can be reproduced and viewed for each channel.

In case of 'CALENDAR', calendar and time table help convenient searching.



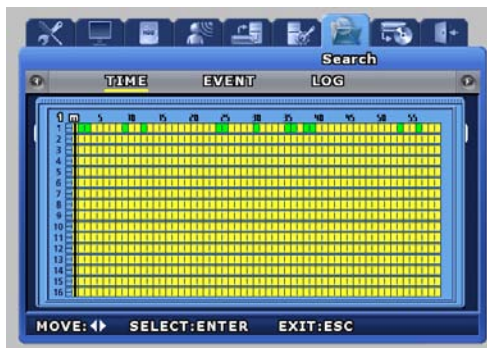
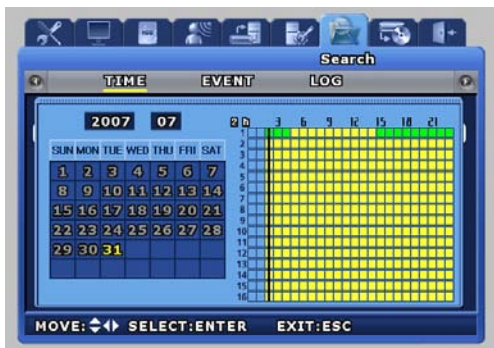

In the CALENDAR table, green section means event recording and Yellow section means normal recording.

5.11.2 Event search

Retrieval by event types including loss video, sensor and motion detection is possible.

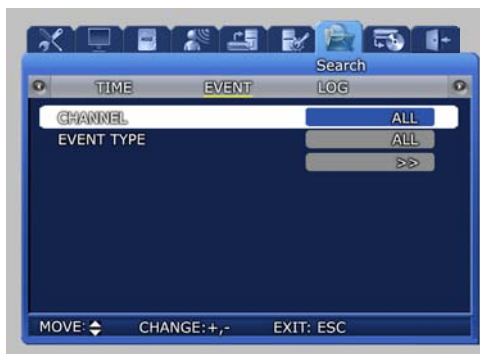

Items selected during event search can be played back. If ESC key is pressed during playback, returns to the event search window.

5.11.3 Log search

Log history for generated events can be verified. When the setup is modified, you can verify submenu information and authority by press [ENTER] button.



< LOG file copy function > (USB memory stick is necessary.)

Log file is recorded by DVR can be saved to USB memory stick.

► How to capture log file.

- Press [MENU] button to main menu. (Or press [SEARCH] button.)
- Select submenu 'LOG' after menu 'SEARCH'.
- Connect USB memory stick to DVR and press [COPY] button.
- Saved log-file has the following format.
"SVR(model)_logfile_(date:yyyymmdd)_(time:hmmss)"
Ex. "SVR1650_logfile_20070822_173133.txt" is saved.
- Saved text file can be opened by 'notepad' on your PC.

5.12 Copy

If a storage medium is connected, video recorded images may be copied to the storage devices. If 'ENTER' key, located in the front of DVR, is pressed or if lower level menu is selected with the mouse, detailed items may be viewed.

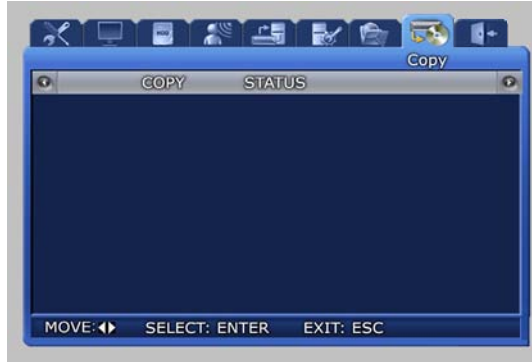

If USB and DVD±RW/DVD±R/CD-RW/CD-R storage is inserted, a screen like the one shown below is displayed.



- ✓ STATUS : Progress status for the current copy operation is displayed.



Please use recommended media. For more details, please refer to "4.9 Reference Note for COPY".

5.13 Exit

Modified setup values are applied when they are verified after the Save button is pressed.



- ✓ As shown in the screen below, when setup has been modified and [SAVE] is pressed, the setup functions are applied. The setup functions can be cancelled by pressing “Do NOT SAVE”.

Chapter 6. Troubleshooting

DVR is an intricate mechanical device and it can malfunction. For such cases, take the following measures.

Product is not turned ON when stand-by switch is pressed.

Verify if the power supply cable is connected properly.

Screen is not displayed when product is turned ON.

Verify if video output terminal is properly connected to the CCTV monitor.

Verify if the camera is properly connected to the input terminal.

Verify if CCTV monitor brightness is appropriate.

Video recorded image does not emit any sound.

Check whether [Voice recording] is set to [ON] for [Video recording setup] in the menu.

Check the volume for the TV or the product in the menu.

The IR remote controller is not operating.

Check the batteries and replace them if needed.

Aim the remote controller properly at the product remote controller receiver section during operation.

If product and remote controller ID is different, make them the same.

Video is not recorded in the HDD.

Video recording may not be possible if HDD is at the end of its lifespan or if there are bad sectors. Such HDD must be replaced. Refer to the description of error messages in the next page.

Reserved video recording is not carried out.

Verify whether current time and recording reservation time is setup accurately.

Monitor screen is not clear.

Check if the camera is focused properly.

Cases for which the point of purchase must be contacted

For the following cases, stop using the product immediately, cut the power supply and ask the point of purchase to fix the damage.

- ❖ If an abnormal behavior occurs in the product during use (Example: Strange noise, odor or smoke)

- ❖ If the power cable connector has been damaged
- ❖ If rain or water has entered the product
- ❖ If a liquid has been spilled on the product or if a foreign substance has entered the product
- ❖ If the product does not operate as described in this manual
- ❖ If the product has been seriously damaged after being dropped
- ❖ If there is a clear difference in performance

Product Specifications



Model		NTSC		
		SVR-1650E	SVR-1640A	SVR-950E
Power Source		AC 100V~240V,(50/60Hz), Max. 2A		
Power Consumption		Max. 75W(1 HDD)		
Video Input		16Ch		9Ch
Video Output	Monitor A	2 BNC, 1 VGA, 1 RCA(Front)		
	Monitor B	1 BNC(Single/Multi)		
Compression		MPEG-4		
Display	Speed	480fps		270fps
	Resolution	720 x 480		
	Multi Screen	1 / 4 / 9 / 16		1 / 4 / 9
Recording	Speed/ Resolution	120 fps (D1, 704 x 480)	30 fps (D1, 704 x 480)	
		240 fps (HD1, 704 x 240)	60 fps (HD1, 704 x 240)	
		480 fps (CIF, 352 x 240)	120 fps (CIF, 352 x 240)	
	Mode	Manual & Event, Schedule & Event		
HDD	250GB 1HDD (Up to 2TB available with mounting 4HDDs of maximum 500GB)			160GB 1HDD (Up to 2TB available with mounting 4HDDs of maximum 500GB)
	HDD Extension Unit : It is possible to add maximum 16 units of 500G HDD. (Product separately sold)			
Backup		DVD Drive: DVD±RW, DVD±R, CD-RW and CD-R (Product separately sold) 3 USB(2 Front):USB Memory Drive (Product separately sold)		
Serial Interface		RS-232C, RS-422/485(RJ-45)		
Sensor Input/Relay Output		16/4		9/4
Audio	Input/Output	4/2(1 Front)		
	Interface	RCA		
Network	Protocol	TCP/IP, DHCP, SMTP		
	Software	Network viewer		
	Transport speed	Max 480 fps	Max 120 fps	
Control		Mouse, Remote control(Controllable up to 16 DVRs) Keyboard controller(SCC-3100A) Password : 2 level (Admin, User) Image quality adjustment : 4 level (Super, High, Middle, Low) support Screen SMS : ATM/POS support		
OSD(On Screen Display)		GUI, Multi-language		
Temperature	Operation	5℃ ~ 40℃		
	Storage	-10℃ ~ 60℃		
Dimensions		430(W) x 88(H) x 465(D)mm		
Weight		Approximately 8.9kg		

Model		PAL		
		SVR-1650E	SVR-1640A	SVR-950E
Power Source		AC 100V~240V,(50/60Hz), Max. 2A		
Power Consumption		Max. 75W(1 HDD)		
Video Input		16Ch	9Ch	
Video Output	Monitor A	2 BNC, 1 VGA, 1 RCA(Front)		
	Monitor B	1 BNC(Single/Multi)		
Compression		MPEG-4		
Display	Speed	400fps	225fps	
	Resolution	720 x 576		
	Multi Screen	1 / 4 / 9 / 16	1 / 4 / 9	
Recording	Speed/ Resolution	100 fps (D1, 704 x 576)	25 fps (D1, 704 x 576)	
		200 fps (HD1, 704 x 288)	50 fps (HD1, 704 x 288)	
		400 fps (CIF, 352 x 288)	100 fps (CIF, 352 x 288)	
	Mode	Manual & Event, Schedule & Event		
HDD	250GB 1HDD (Up to 2TB available with mounting 4HDDs of maximum 500GB)		160GB 1HDD (Up to 2TB available with mounting 4HDDs of maximum 500GB)	
	HDD Extension Unit : It is possible to add maximum 16 units of 500G HDD. (Product separately sold)			
Backup		DVD Drive: DVD±RW, DVD±R, CD-RW and CD-R (Product separately sold) 3 USB(2 Front):USB Memory Drive (Product separately sold)		
Serial Interface		RS-232C, RS-422/485(RJ-45)		
Sensor Input/Relay Output		16/4	9/4	
Audio	Input/Output	4/2(1 Front)		
	Interface	RCA		
Network	Protocol	TCP/IP, DHCP, SMTP		
	Software	Network viewer		
	Transport speed	Max 400 fps	Max 100 fps	
Control		Mouse, Remote control(Controllable up to 16 DVRs) Keyboard controller(SCC-3100A) Password : 2 level (Admin, User) Image quality adjustment : 4 level (Super, High, Middle, Low) support Screen SMS : ATM/POS support		
OSD(On Screen Display)		GUI, Multi-language		
Temperature	Operation	5℃ ~ 40℃		
	Storage	-10℃ ~ 60℃		
Dimensions		430(W) x 88(H) x 465(D)mm		
Weight		Approximately 8.9kg		

Dimensions

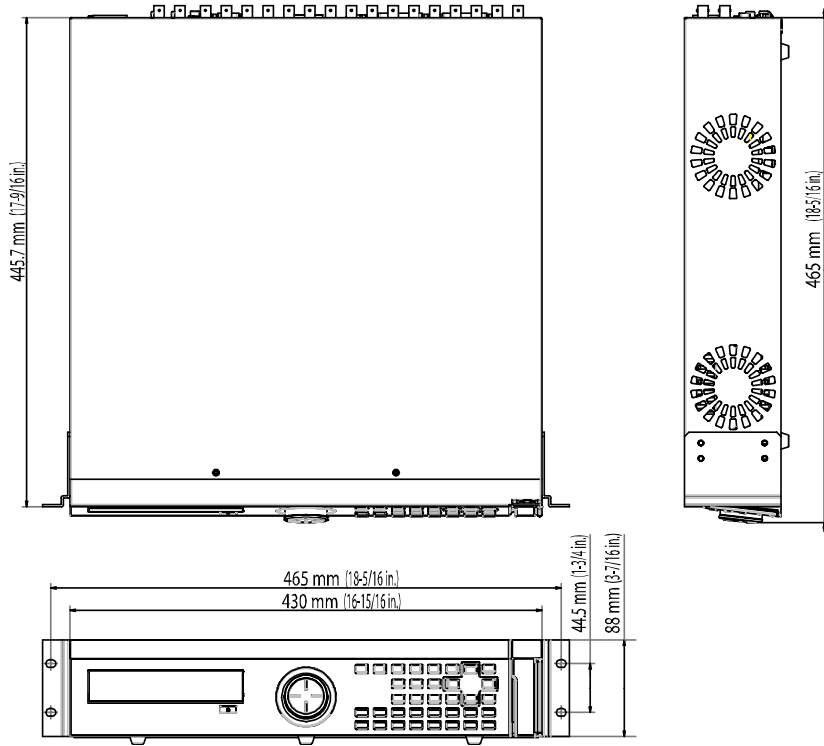

SAMSUNG TECHWIN



SALES NETWORK

SAMSUNG TECHWIN CO., LTD.
145-3, Sangdaewon-dong, Jungwon-gu
Seongnam-si Gyeonggi-do 462-120, Korea
Tel: +82-31-740-8151~8 Fax: +82-31-740-8145

SAMSUNG OPTO-ELECTRONICS UK, LTD.
Samsung House, 1000 Hillswood Drive,
Hillswood Business Park Chertsey, Surrey KT16 OPS
Tel: +44-1932-45-5308 Fax: +44-1932-45-5325

<http://www.samsungtechwin.com>
<http://www.samsungcctv.com>

P/No. : Z6806.0759.04D

I-H-0805