



Contact SAMSUNG WORLDWIDE

If you have any questions or comments relating to Samsung products, please contact the SAMSUNG customer care centre.

| Country | Customer Care Centre ☎ | Web Site |
|-------------|--|--|
| AUSTRALIA | 1300 362 603 | www.samsung.com |
| NEW ZEALAND | 0800 SAMSUNG (0800 726 786) | www.samsung.com |
| CHINA | 400-810-5858 010-6475 1880 | www.samsung.com |
| HONG KONG | (852) 3698-4698 | www.samsung.com/hk www.samsung.com/hk_en/ |
| INDIA | 3030 8282 1800 110011 1800 3000 8282 1800 266 8282 | www.samsung.com |
| INDONESIA | 0800-112-8888 021-5699-7777 | www.samsung.com |
| JAPAN | 0120-327-527 | www.samsung.com |
| MALAYSIA | 1800-88-9999 | www.samsung.com |
| PHILIPPINES | 1-800-10-SAMSUNG(726-7864) 1-800-3-SAMSUNG(726-7864) 1-800-8-SAMSUNG(726-7864) 02-5805777 | www.samsung.com |
| SINGAPORE | 1800-SAMSUNG(726-7864) | www.samsung.com |
| THAILAND | 1800-29-3232 02-689-3232 | www.samsung.com |
| TAIWAN | 0800-329-999 | www.samsung.com |
| VIETNAM | 1 800 588 889 | www.samsung.com |



LED TV user manual

imagine the possibilities

Thank you for purchasing this Samsung product.
To receive more complete service, please register
your product at

www.samsung.com/register

Model _____ Serial No. _____



Figures and illustrations in this User Manual are provided for reference only and may differ from actual product appearance. Product design and specifications may be changed without notice.

Still image warning

Avoid displaying still images (like jpeg picture files) or still image element (like TV programme logo, panorama or 4:3 image format, stock or news bar at screen bottom etc.) on the screen. Constant displaying of still picture can cause ghosting of LED screen, which will affect image quality. To reduce risk of this effect, please follow below recommendations:

- Avoid displaying the same TV channel for long periods.
- Always try to display image in full screen mode, use TV set picture format menu for best possible match.
- Reduce brightness and contrast values to minimum required level to achieve desired picture quality, exceeded values may speed up the burnout process.
- Frequently use all TV features designed to reduce image retention and screen burnout, refer to proper user manual section for details.

Securing the Installation Space

Keep the required distance between the product and other objects (e.g. walls) to ensure proper ventilation.

Failing to do so may result in fire or a problem with the product due to an increase in the internal temperature of the product.

- 🔧 When using a stand or wall-mount, use parts provided by Samsung Electronics only.
 - If you use parts provided by another manufacturer, it may result in a problem with the product or an injury due to the product falling.
- 🔧 The appearance may differ depending on the product.

Installation with a stand.

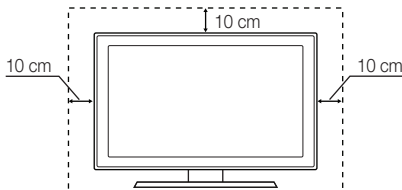

Installation with a wall-mount.

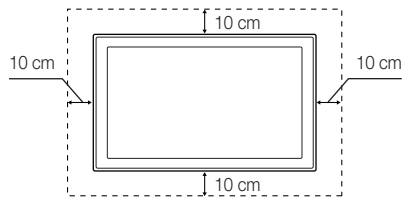

Contents

Getting Started

4

- 4 Accessories
- 5 Viewing the Control Panel
- 6 Viewing the Remote Control
- 7 Connecting to an Antenna
- 7 Plug & Play (Initial Setup)

Connections

8

- 8 Connecting to an AV Device
- 10 Connecting to an Audio Device
- 10 Changing the Input Source

Basic Features

11

- 11 How to Navigate Menus
- 11 Using the **INFO** button (Now & Next guide)
- 11 Planning Your Viewing
- 13 Channel Menu
- 15 Picture Menu
- 20 Sound Menu
- 22 Setup Menu
- 24 Support Menu

Advanced Features

26

- 26 Connecting to a PC
- 27 Network Connection
- 34 Media Play
- 42 Anynet+
- 46 Internet@TV
- 50 AllShare

Other Information

52

- 52 Analogue Channel Teletext Feature
- 53 Assembling the Cables
- 53 Installing the Wall Mount
- 55 Anti-theft Kensington Lock
- 55 Securing the TV to the wall
- 56 Troubleshooting
- 60 Specifications
- 61 Index

Check the Symbol!



This function can be used by pressing the **TOOLS** button on the remote control.



Note



One-Touch Button

Getting Started

Accessories

 Please make sure the following items are included with your LED TV. If any items are missing, contact your dealer.

 The items' colours and shapes may vary depending on the models.

 **CAUTION: INSERT SECURELY LEST SHOULD BE DETACHED IN SET**

- Remote Control & Batteries (AAA x 2)
- Warranty Card / Safety Guide (Not available in some locations)
- Cleaning Cloth
- Owner's Instructions

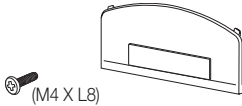

- Blanking Bracket & Screw (1EA)



- Holder-Ring (4EA)



- Holder-Wire stand

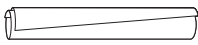

- Cable Tie



- Holder-Wire (3EA)



- LAN Adapter



- Antenna Adapter (Air / Cable)



- Optical Adapter



- PC Adapter



- Component Adapter



- AV1 Adapter



- AV2 Adapter

See separate guide for installing the stand.

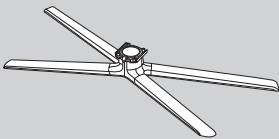

- Stand (1EA)

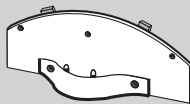

- Guide Stand (1EA)



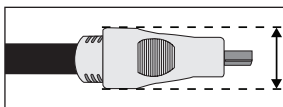

- Screws (9EA)

 For best cable connection to this product, be sure to use a cables with a maximum thickness as below:





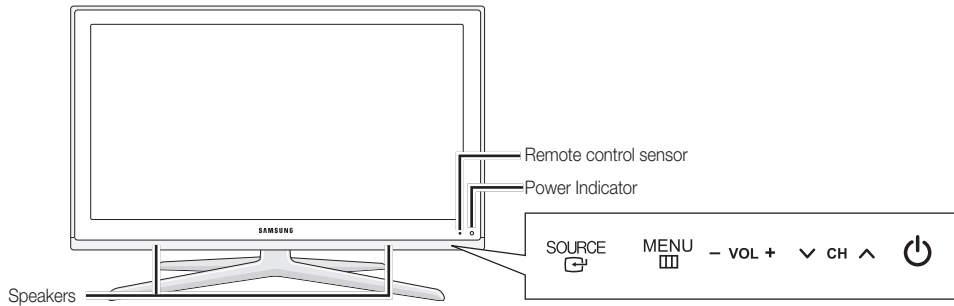

- Maximum thickness - 0.55 inches (14mm)

Viewing the Control Panel

-  The product colour and shape may vary depending on the model.
-  Contact with objects other than your finger may switch on the LED touchpad.



| | |
|---|---|
| Remote control sensor | Aim the remote control towards this spot on the TV. |
| Power Indicator | Blinks and turns off when the power is on and lights up in standby mode. |
| SOURCE  | Toggles between all the available input sources. In the on-screen menu, use this button as you would use the ENTER  button on the remote control. |
| MENU  | Displays an on-screen menu, the OSD (on screen display), of your TV's features. |
| -VOL+ | Adjusts the volume. In the OSD, use the -VOL+ buttons as you would use the ◀ and ▶ buttons on the remote control. |
| ▼ CH ▲ | Changes the channels. In the OSD, use the ▼ CH ▲ buttons as you would use the ▼ and ▲ buttons on the remote control. |
|  (Power) | Turns the TV on or off. |

Standby mode

Do not leave your TV in standby mode for long periods of time (when you are away on a holiday, for example). A small amount of electric power is still consumed even when the power button is turned off. It is best to unplug the power cord.

Getting Started

Viewing the Remote Control

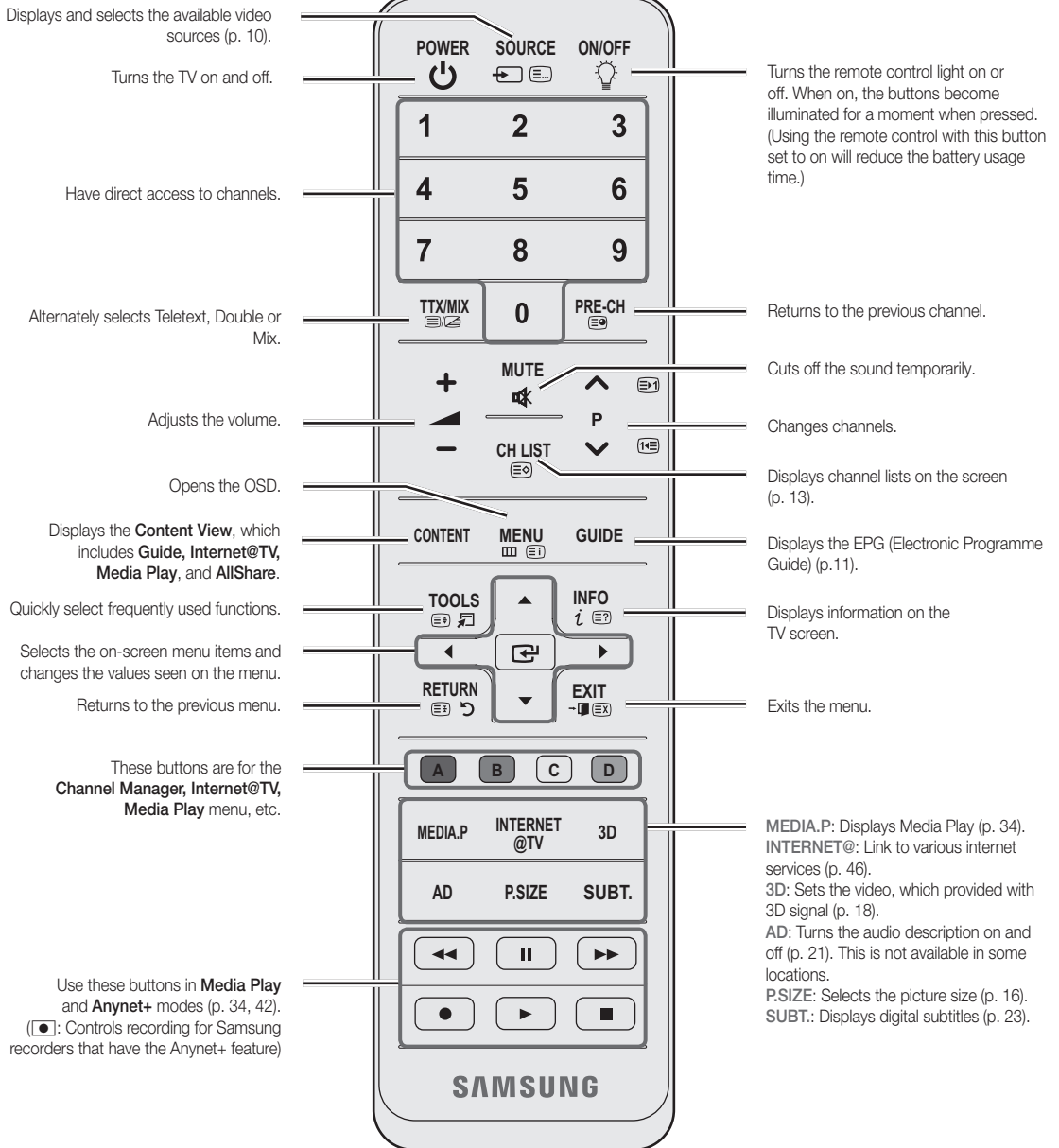

Installing batteries (Battery size: AAA)

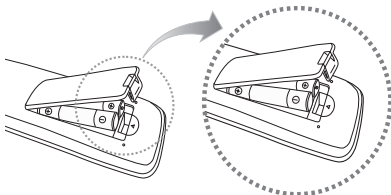

NOTE

- Use the remote control within 23 feet from the TV.
- Bright light may affect the performance of the remote control. Avoid using nearby special fluorescent light or neon signs.
- The colour and shape may vary depending on the model.

Connecting to an Antenna

When the TV is initially powered on, basic settings proceed automatically.



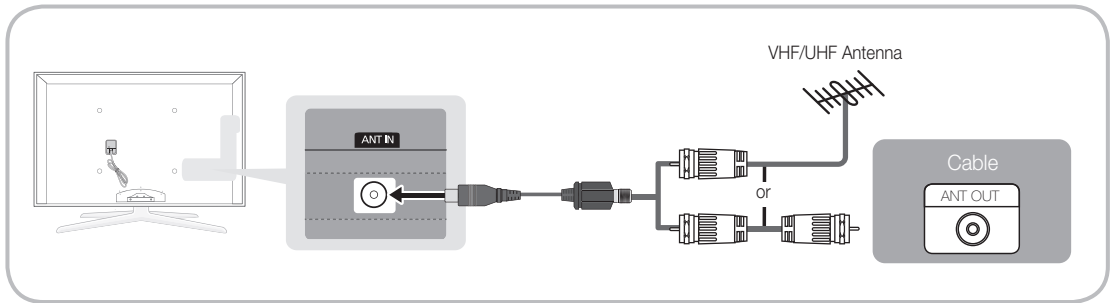







 **Preset:** Connecting the power cord and antenna.



Plug & Play (Initial Setup)

When the TV is initially powered on, a sequence of on-screen prompts will assist in configuring basic settings. Press the **POWER**  button. **Plug & Play** is available only when the **Input** source is set to TV.

 To return to the previous step, press the Red button.

| | | | |
|----------|--|---|---|
| 1 | Selecting Store Demo or Home Use | Press the ◀ or ▶ button, then press the ENTER  button. <ul style="list-style-type: none"> • Select the Home Use mode. Store Demo Mode is for retail environments. • Return the unit's settings from Store Demo to Home Use (standard): Press the volume button on the TV. When you see the volume OSD, press and hold MENU for 5 sec. |  |
| 2 | Selecting a country | Press the ▲ or ▼ button, then press the ENTER  button. Select the appropriate country. | |
| 3 | Selecting a channel | Press the ▲ or ▼ button, then press the ENTER  button. After selecting the channel source to memorise, select Search . For more information, refer to Channel → Auto Store . (p.13) <p> Press the ENTER  button at any time to interrupt the memorisation process.</p> | |
| 4 | Setting the Clock Mode | Set the Clock Mode automatically or manually. Press the ▲ or ▼ button to select Auto , then press the ENTER  button. <ul style="list-style-type: none"> • Auto: Allows you to select a time zone. <ul style="list-style-type: none">  Press the ▲ or ▼ button to highlight the time zone for your local area. Press the ENTER  button. (Australia only) • Manual: Allows you to manually set the current date and time (p. 22). | |
| 5 | Viewing the HD Connection Guide . | The connection method for the best HD screen quality is displayed. | |
| 6 | Enjoy your TV. | Press the ENTER  button. | |

If You Want to Reset This Feature...

Select **Setup - Plug & Play** (Initial Setup). Enter your 4 digit PIN number. The default PIN number is "0-0-0-0." If you want to change the PIN number, use the **Change PIN** function.

Connections

Connecting to an AV Device

Using an HDMI or HDMI / DVI Cable: HD connection (up to 1080p)

Available devices: DVD, Blu-ray player, HD cable box, HD STB (Set-Top-Box) satellite receiver, cable box, satellite receiver (STB)

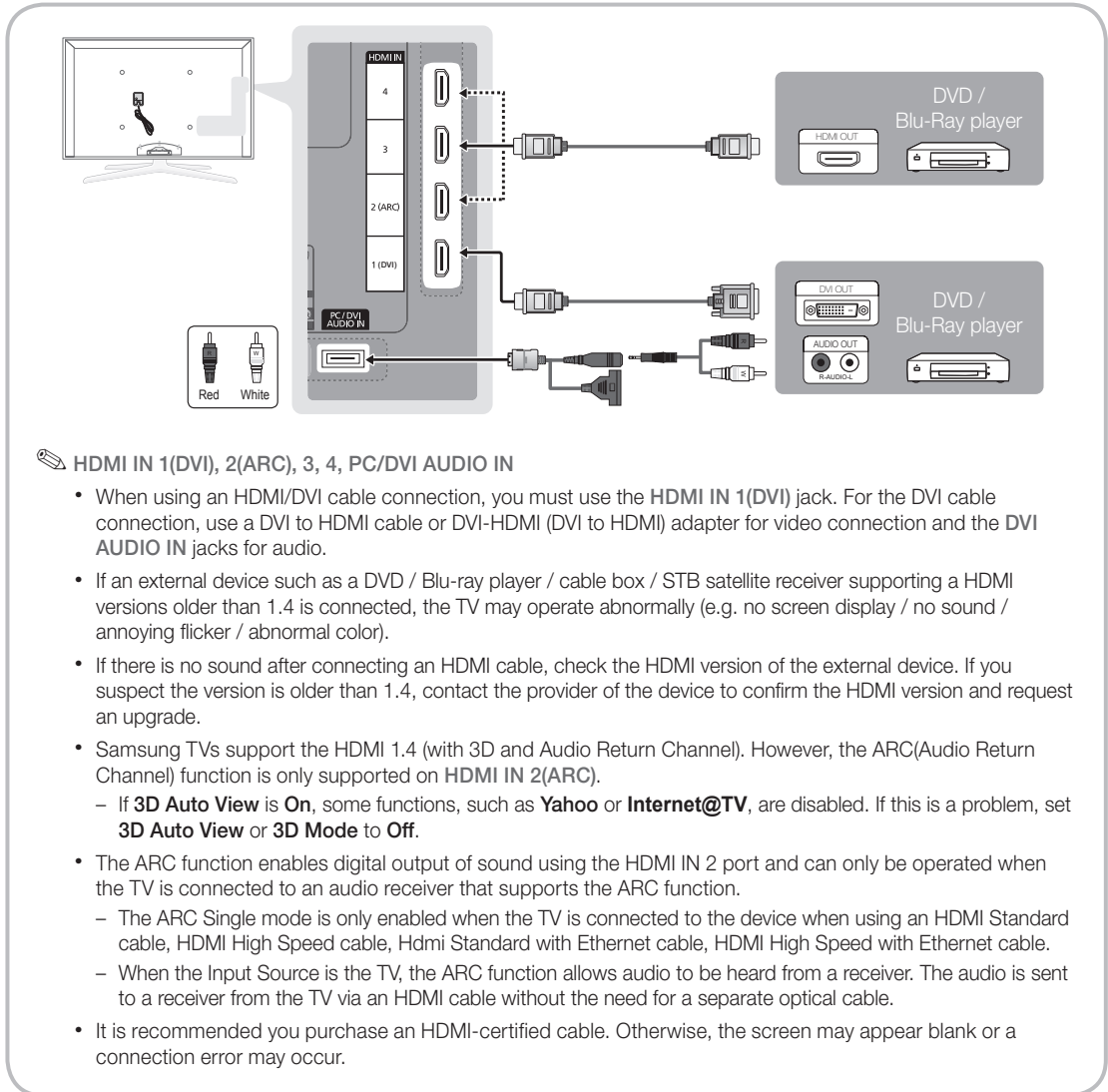

Using a Component (up to 1080p) or Audio/Video (480i only) Cable

Available devices: VCR, DVD, Blu-ray player, cable box, STB satellite receiver

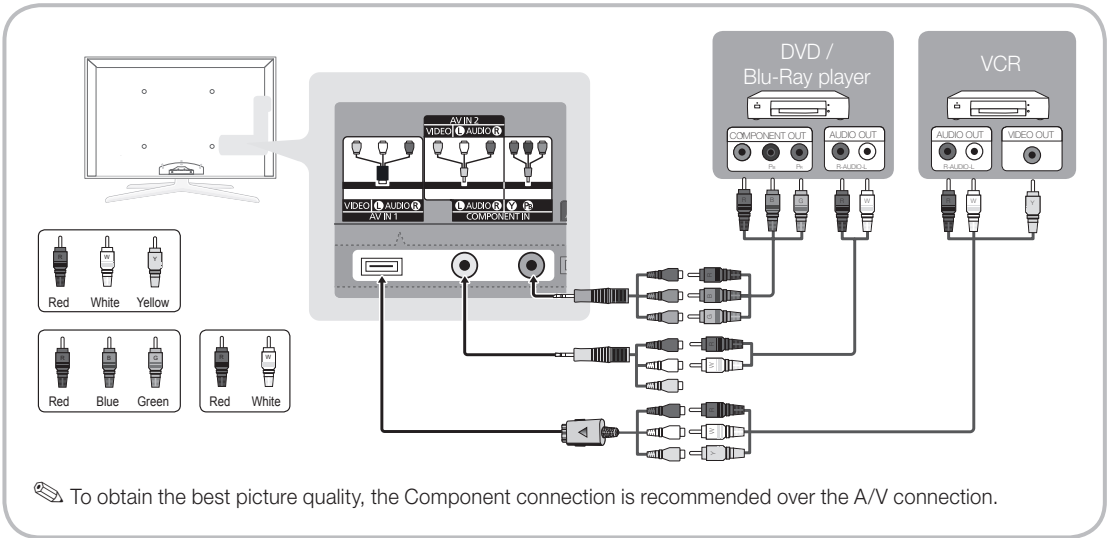

Connections

Connecting to an Audio Device

Using an Optical (Digital) or Audio (Analogue) Cable or Headphone Connection

Available devices: digital audio system, amplifier, DVD home theatre

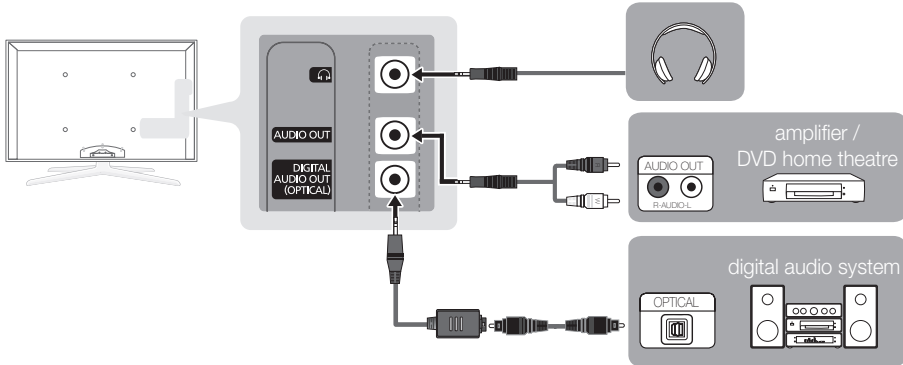

DIGITAL AUDIO OUT (OPTICAL)

- When a digital audio system is connected to the **DIGITAL AUDIO OUT (OPTICAL)** jack, decrease the volume of both the TV and the system.
- 5.1 CH (channel) audio is available when the TV is connected to an external device supporting 5.1 CH.
- When the receiver (home theatre) is set to on, you can hear sound output from the TV's optical jack. When the TV is receiving a DTV signal, the TV will send 5.1 CH sound to the home theatre receiver. When the source is a digital component such as a DVD / Blu-ray player / cable box / STB (Set-Top-Box) satellite receiver and is connected to the TV via HDMI, only 2 CH audio will be heard from the home theatre receiver. If you want to hear 5.1 CH audio, connect the digital audio out jack from your DVD / Blu-ray player / cable box / STB satellite receiver directly to an amplifier or home theatre.

Headphones : You can connect your headphones to the headphones output on your set. While the headphones are connected, the sound from the built-in speakers will be disabled.

- Sound function may be restricted when connecting headphones to the TV.
- Headphone volume and TV volume are adjusted separately.

AUDIO OUT: Connects to the audio input jacks on your amplifier/DVD home theatre.

- When connecting, use the appropriate connector (sold separately).
- When an audio amplifier is connected to the **AUDIO OUT** jacks: Decrease the volume of the TV and adjust the volume level with the amplifier's volume control.

Changing the Input Source

Source List

Use to select TV or other external input sources such as DVD / Blu-ray players / cable box / STB satellite receiver connected to the TV.

- **TV / PC / AV1/ AV2 / Component / HDMI1/DVI / HDMI2 / HDMI3 / HDMI4 / USB**

In the **Source List**, connected inputs will be highlighted.

PC always stay activated.



Edit Name

- **VCR / DVD / Cable STB / Satellite STB / PVR STB / AV Receiver / Game / Camcorder / PC / DVI PC / DVI Devices / TV / IPTV / Blu-ray / HD DVD / DMA:** Name the device connected to the input jacks to make your input source selection easier.

When a PC with a resolution of 1920 x 1080 @ 60Hz is connected to the **HDMI IN 1(DVI)** port, you should set to **DVI PC** mode under **Edit Name**.

When connecting an HDMI/DVI cable to the **HDMI IN 1(DVI)** port, you should set to **DVI PC** or **DVI Devices** mode under **Edit Name**.

Basic Features

How to Navigate Menus

Before using the TV, follow the steps below to learn how to navigate the menu and select and adjust different functions.

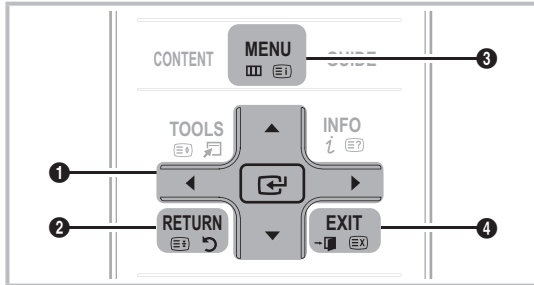

- 1 ENTER / Direction button: Move the cursor and select an item. Confirm the setting.
- 2 RETURN button: Returns to the previous menu.
- 3 MENU button: Displays the main on-screen menu.
- 4 EXIT button: Exits the on-screen menu.

How to Operate the OSD (On Screen Display)

The access step may differ depending on the selected menu.

- | | | |
|---|-------|--|
| 1 | MENU | The main menu options appear on the screen: Picture, Sound, Channel, Setup, Input, Application, Support. |
| 2 | ▲ / ▼ | Select an icon with the ▲ or ▼ button. |
| 3 | ENTER | Press ENTER to access the sub-menu. |
| 4 | ▲ / ▼ | Select the desired submenu with the ▲ or ▼ button. |
| 5 | ◀ / ▶ | Adjust the value of an item with the ◀ or ▶ button. The adjustment in the OSD may differ depending on the selected menu. |
| 6 | ENTER | Press ENTER to complete the configuration. |
| 7 | EXIT | Press EXIT. |

Using the INFO button (Now & Next guide)

The display identifies the current channel and the status of certain audio-video settings.

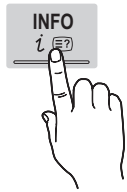

The Now & Next guide shows daily TV programme information for each channel according to the broadcasting time.

- Scroll ◀, ▶ to view information for a desired programme while watching the current channel.
- Scroll ▲, ▼ to view information for other channels. If you want to move to the currently selected channel, press the ENTER button.

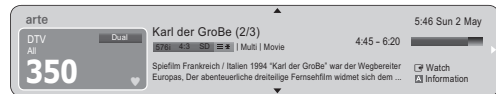

Planning Your Viewing

Guide

The EPG (Electronic Programme Guide) information is provided by broadcasters.

Using programme schedules provided by broadcasters, you can specify programmes you want to watch in advance so that the channel automatically changes to the selected programme channel at the specified time. Programme entries may appear blank or out of date depending on a channel status.



- In New Zealand, if **Digital Text** is set to **Enable**, the EPG (Electronic Program Guide) will work. (refer to page 23)

Using Channel View



Basic Features

Using Scheduled View

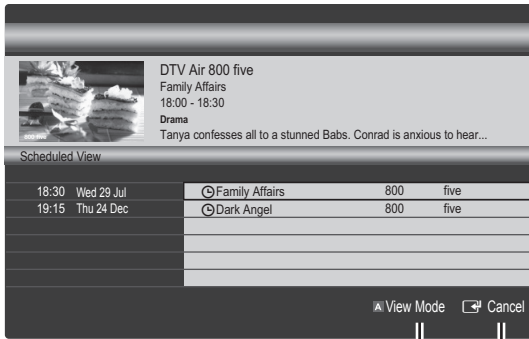

- 1 **Red (View Mode):** View the list of programmes that are playing now or coming up.
- 2 **Yellow (+24 Hours):** Viewing the list of programmes to be broadcasted after 24 hours.
- 3 **Blue (Ch. Mode):** Select the type of channels you want to display on the **Channel View** window. (**All, TV, Radio, Data/Other, My Channel 1~4**)
- 4 **Information:** Displays details of the selected programme.
- 5 **◇ (Page):** Move to next or previous page.
- 6 **ENTER** button.
 - When selecting the current programme, you can watch the selected programme.
 - When selecting the future programme, you can reserve to watch the selected programme. To cancel the schedule, press the **ENTER** button again and select **Cancel Schedules**.

Channel Manager

Delete or set favourites channels and use the programme guide for digital broadcasts. Select a channel in the **Channels, My Channels** or **Scheduled** screen.

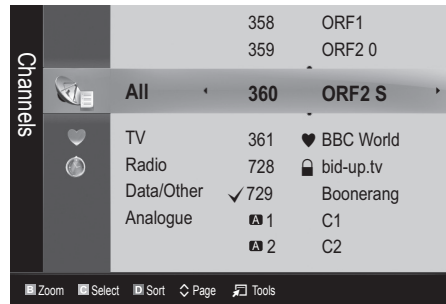

- **Channels:** Shows the channel list according to channel type.
 - **♥ My Channels:** Shows the group of the channel.
 - **🕒 Scheduled:** Shows all the currently reserved programmes.
- 📌 Using the colour buttons with the **Channel Manager**.
- **Green (Zoom):** Enlarges or shrinks a channel number.
 - **Yellow (Select):** Select desired channels and press the Yellow button to set all the selected channels at the same time. The ✓ mark appears to the left of the selected channels.
 - **Blue (Sort):** Change the list ordered by channel name or channel number.
 - **◇ (Page):** Move to next or previous page.
 - **🔧 (Tools):** Displays the **Channel Manager** option menu. (The options menus may differ depending on the situation.)

Channel Status Display Icons

| Icons | Operations |
|-------|--|
| A | An analogue channel. |
| ✓ | A channel selected. |
| ♥ | A channel set as a Favourite. |
| 📺 | A programme currently being broadcast. |
| 🔒 | A locked channel. |
| 🕒 | A reserved programme. |

Using Favourite Channels

♥ My Channels

(in **Channel Manager**)

Shows all favourite channels.

■ **Edit My Channels** **TOOLS** : You can set the selected channels to desired my channels group.

 The “♥” symbol will be displayed and the channel will be set as a my channel.

1. Select a channel and press the **TOOLS** button.
2. Add or delete a channel in the my channel groups you want among 1, 2, 3 and 4.
 - One or more groups can be selected.
3. After you have changed the settings, the channel list for each group can be viewed in my channel.

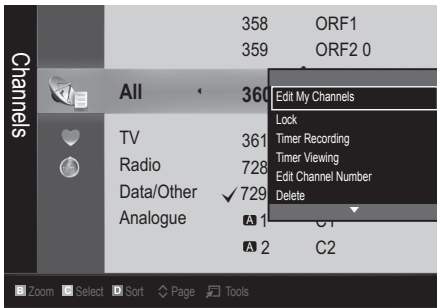

Channel List

You can see all the channels searched.



Channel Menu

Retuning Channels

Country

You can change the country. The PIN input screen appears. Enter your 4 digit PIN number.

Auto Store

Scans for a channel automatically and stores in the TV.

 Automatically allocated programme numbers may not correspond to actual or desired programme numbers. If a channel is locked using the **Child Lock** function, the PIN input window appears.

■ **Channel Source (Digital & Analogue / Digital / Analogue)**: Select the channel source to memorise.

Manual Store

Scans for a channel manually and stores in the TV.

 If a channel is locked using the **Child Lock** function, the PIN input window appears.

■ **Digital Channel (Channel, Frequency, Bandwidth)**: When scanning has finished, channels are updated in the channel list.

 The **Bandwidth** function is supported in New Zealand and Singapore only.

■ **Analogue Channel (Programme, Colour System, Sound System, Channel, Search)**: If there is abnormal sound or no sound, reselect the sound standard required.

 Channel mode

- **P** (programme mode): When tuning is complete, the broadcasting stations in your area have been assigned to position numbers from P0 to P99. You can select a channel by entering the position number in this mode.
- **C** (aerial channel mode) / **S** (cable channel mode): These two modes allow you to select a channel by entering the assigned number for each aerial broadcasting station or cable channel.

Basic Features

Editing Channels

Channel Manager Option Menu

(in **Channel Manager**)

1. Select a channel and press the **TOOLS** button.
 2. Edit the channel name or number using the **Edit Channel Name** or **Edit Channel Number** menu.
- **Edit Channel Name** (analogue channels only): Assign your own channel name.
 - **Edit Channel Number** (digital channels only) (New Zealand only): Edit the number by pressing the number buttons desired.

Other Features



Channel Manager

Channel Manager Option Menu

Set each channel using the **Channel Manager** menu options (**Lock / Unlock**, **Timer Recording**, **Timer Viewing**, **Sort**, **Delete**, **Select All / Deselect All**). Option menu items may differ depending on the channel status.

1. Select a channel and press the **TOOLS** button.
 2. Select a function and change its settings.
- **Lock / Unlock**: Lock a channel so that the channel cannot be selected and viewed.

NOTE

- This function is available only when the **Child Lock** is set to **On**.
 - The PIN input screen appears. Enter your 4-digit PIN, the default of which is "0-0-0-0." Change the PIN using the **Change PIN** option.
- **Timer Recording** (digital channels only): Allows you to record a programme currently being broadcasted or make a reservation to record a programme scheduled for broadcast.
 -  A USB device with 4GB of memory or greater must be connected to the TV.
 -  A USB storage device cannot record until it completes the Device Performance Test.
 - **Timer Viewing**: You can set a desired channel to be displayed automatically at the reserved time. Set the current time first to use this function.
 -  When a digital channel is selected, press the ► button to view the digital Programme.
 - **Sort** (analogue channels only): This operation allows you to change the programme numbers of the stored channels. This operation may be necessary after using the auto store.

- **Delete**: You can delete a channel to display the channels you want.
- **Select All / Deselect All**: Select all the channels or deselect all the selected channels in the channel manager.

Scheduled

(in **Channel Manager**)

You can view, modify or delete a show you have reserved to watch.

- **Change Info**: Change a show you have reserved to watch.
- **Cancel Schedules**: Cancel a show you have reserved to watch.
- **Information**: Display a show you have reserved to watch. (You can also change the reservation information.)
- **Select All / Deselect All**: Select or deselect all reserved programmes.

Channel List Transfer

The PIN input screen appears. Enter your 4 digit PIN number. Imports or exports the channel map. You should connect a USB storage to use this function.

- **Import from USB**: Import channel list from USB.
- **Export to USB**: Export channel list to USB. this function is available when USB is connected.

Edit Channel Number (Disable / Enable)



(New Zealand only)

Edit the number by pressing the number buttons desired.

Fine Tune

(analogue channels only)

If the signal is weak or distorted, fine tune the channel manually.

-  Fine tuned channels are marked with an asterisk "*".
-  To reset the fine-tuning, select **Reset**.

Picture Menu

Changing the Preset Picture Mode

Mode

Select your preferred picture type.

- **Dynamic:** Suitable for a bright room.
- **Standard:** Suitable for a normal environment.
- **Natural:** Suitable for reducing eye strain.
 - ✎ **Natural** is not available in PC mode.
- **Movie:** Suitable for watching movies in a dark room.

Adjusting Picture Settings

Backlight / Contrast / Brightness / Sharpness / Colour / Tint (G/R)

Your television has several setting options for picture quality control.

✎ NOTE

- In analogue **TV, AV** modes of the PAL system, the **Tint (G/R)** function is not available.
- In PC mode, you can only make changes to **Backlight, Contrast** and **Brightness**.
- Settings can be adjusted and stored for each external device connected to the TV.
- Lowering picture brightness reduces power consumption.

Economical Solutions

Eco Solution

- **Energy Saving (Off / Low / Medium / High / Picture Off / Auto)** **TOOLS** : Adjust the brightness of the TV in order to reduce power consumption. If you select **Picture Off**, the screen is turned off, but the sound remains on. Press any button except volume button to turn on the screen.
 - **Eco Sensor (Off / On):** To enhance your power savings; the picture settings will automatically adapt to the light in the room.
 - ✎ If you adjust the **Backlight**, the **Eco Sensor** will be set to **Off**.
- Min Backlight:** When **Eco sensor** is **On**, the minimum screen brightness can be adjusted manually.
- ✎ If **Eco Sensor** is **On**, the display brightness may change (become slightly darker or brighter) depending on the surrounding light intensity.

- **No Signal Power Off (Off / 15 min / 30 min / 60 min):** To avoid unnecessary energy consumption, set how long you want the TV to remain on if it's not receiving a signal.
 - ✎ Disabled when the PC is in power saving mode.

Changing the Picture Options

Advanced Settings

(available in **Standard / Movie** mode)



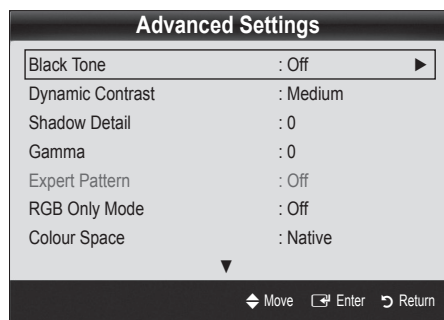

You can adjust the detailed setting for the screen including colour and contrast.

- ✎ In PC mode, you can only make changes to **Dynamic Contrast, Gamma, White Balance** and **LED Motion Plus**.



- **Black Tone (Off / Dark / Darker / Darkest):** Select the black level to adjust the screen depth.
- **Dynamic Contrast (Off / Low / Medium / High):** Adjust the screen contrast.
- **Shadow Detail (-2~+2):** Increase the brightness of dark images.
- **Gamma:** Adjust the primary colour intensity.
- **Expert Pattern (Off / Pattern 1 / Pattern 2):** By running the **Expert Pattern** function, the picture can be calibrated without a generator or filter. If the OSD menu disappears or a menu other than the Picture menu is opened, the calibration is saved and the **Expert Pattern** window disappears.
 - ✎ While the **Expert Pattern** is running, sound is not outputted.
 - ✎ Only enabled in DTV, Component and HDMI modes.
- **RGB Only Mode (Off / Red / Green / Blue):** You can adjust **Colour** or **Tint (G/R)** of **Red, Green** or **Blue** for the picture from an external device (DVD player, home theatre, etc.).
- **Colour Space (Auto / Native / Custom):** Adjust the range of colours available to create the image. To adjust **Colour, Red, Green, Blue** and **Reset**, set **Colour Space** to **Custom**.



Basic Features

- **White Balance:** Adjust the colour temperature for a more natural picture.
R-Offset / G-Offset / B-Offset: Adjust each colour's (red, green, blue) darkness.
R-Gain / G-Gain / B-Gain : Adjust each colour's (red, green, blue) brightness.
Reset: Resets the **White Balance** to its default settings.
- **10p White Balance (Off / On):** Controls the white balance in 10 point interval by adjusting the red, green, and blue brightness.
 -  Available when the picture mode is set to **Movie** and when the external input is set to HDMI or Component.
 -  Some external devices may not support this function.
- Interval:** Select interval to adjust.
Red: Adjust the red level.
Green: Adjust the green level.
Blue: Adjust the blue level.
Reset: Resets the **10p White Balance** to its default settings
- **Flesh Tone:** Emphasize pink "Flesh Tone."
- **Edge Enhancement (Off / On):** Emphasize object boundaries.
- **xvYCC (Off / On):** Setting the **xvYCC** mode on increases detail and colour space when watching movies from an external device (e.g. DVD player) connected to the HDMI or Component IN jacks.
 -  Available when the picture mode is set to **Movie** and when the external input is set to HDMI or Component.
 -  Some external devices may not support this function.
- **LED Motion Plus (Off / On):** Removes drag from fast scenes with a lot of movement to provide a clear picture.

Picture Options

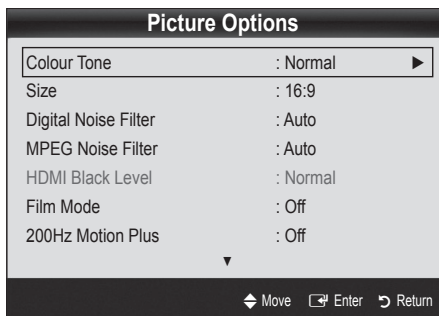



 In PC mode, you can only make changes to the **Colour Tone**, **Size**, **Digital Noise Filter** and **Auto Protection Time**.



- **Colour Tone (Cool / Normal / Warm1 / Warm2)**
 -  **Warm1** or **Warm2** will be deactivated when the picture mode is **Dynamic**.
 -  Settings can be adjusted and stored for each external device connected to an input on the TV.
- **Size:** Your cable box/satellite receiver may have its own set of screen sizes as well. However, we highly recommend you use 16:9 mode most of the time.



P.SIZE

 - Auto Wide** (New Zealand, Singapore only): Automatically adjusts the picture size to the 16:9 aspect ratio.
 - 16:9 :** Adjusts the picture size to 16:9 for DVDs or wide broadcasting.
 - Wide Zoom:** Magnifies the picture size more than 4:3.
 -  Adjusts the **Position** by using **▲, ▼** buttons.
 - Zoom:** Magnifies the 16:9 wide pictures vertically to fit the screen size.
 -  Adjusts the **Position** or **Size** by using **▲, ▼** buttons.
 - 4:3 :** The default setting for a movie or normal broadcasting.
 -  Do not watch in 4:3 format for a long time. Traces of borders displayed on the left, right and centre of the screen may cause image retention(screen burn) which are not covered by the warranty.
 - Screen Fit:** Displays the full image without any cut-off when HDMI (720p / 1080i / 1080p) or Component (1080i / 1080p) signals are inputted.
-  **NOTE**
 - When Double (■■■, ■■■) mode has been set in PIP, the Picture Size cannot be set.
 - Depending on the input source, the picture size options may vary.
 - The available items may differ depending on the selected mode.
 - In PC mode, only **16:9** and **4:3** modes can be adjusted.
 - Settings can be adjusted and stored for each external device connected to an input of the TV.
 - After selecting **Screen Fit** in **HDMI** (1080i / 1080p) or **Component** (1080i / 1080p) mode: Adjusts the **Position** or **Size** by using **▲, ▼, ◀, ▶** button.
 - If you use the **Screen Fit** function with HDMI 720p input, 1 line will be cut at the top, bottom, left and right as in the overscan function.
- **Screen Mode (16:9 / Wide Zoom / Zoom / 4:3)** (New Zealand, Singapore only): Available only when picture size is set to **Auto Wide**. You can determine the desired picture size at the 4:3 WSS (Wide Screen Service) size or the original size. Each European country requires different picture size.
 -  Not available in PC, Component or HDMI mode.

- **Digital Noise Filter (Off / Low / Medium / High / Auto / Auto Visualisation):** When the broadcast signal is weak, some static and ghosting may appear. Select one of the options until the best picture is displayed.

Auto Visualisation: When changing analogue channels, displays the intensity of the current signal and defines the screen noise filter.

 Only available for analogue channels.

- **MPEG Noise Filter (Off / Low / Medium / High / Auto):** Reduces MPEG noise to provide improved picture quality.
 - **HDMI Black Level (Normal / Low):** Selects the black level on the screen to adjust the screen depth.

 Available only in HDMI mode (RGB signals).
 - **Film Mode (Off / Auto1 / Auto2):** Sets the TV to automatically sense and process film signals from all sources and adjust the picture for optimum quality.

 Available in TV, AV, COMPONENT (480i / 1080i) and HDMI (480i / 1080i).
 - **200Hz Motion Plus (Off / Clear / Standard / Smooth / Custom / Demo) :** Removes drag from fast scenes with a lot of movement to provide a clearer picture.

 If noise occurs on the screen, please set up the **200Hz Motion Plus** to **Off**. If **200Hz Motion Plus** is **Custom**, you can set up the **Blur Reduction**, **Judder Reduction** or **Reset** manually.

 If **200Hz Motion Plus** is **Demo**, you can compare the difference of on and off modes.
- Blur Reduction:** Adjusts the blur reduction level from video sources.
- Judder Reduction:** Adjusts the judder reduction level from video sources when playing films.
- Reset:** Reset the custom settings.
- **Auto Protection Time (2 hours / 4 hours / 8 hours / 10 hours / Off):** If the screen remains idle with a still image for a certain period of time defined by the user, the screen saver is activated to prevent the formation of ghost images on the screen.

Viewing TV using the 3D function

IMPORTANT SAFETY INFORMATION. READ THE FOLLOWING WARNINGS BEFORE YOU OR YOUR CHILD USE THE 3D FUNCTION

WARNING

- Parents' careful supervision is required particularly when children or teenagers view 3D images.
- Photosensitive Seizure Warning and Other Health Risks
 - Some viewers may experience an epileptic seizure or stroke when exposed to certain flashing images or lights contained in certain television pictures or video games. If you or any of your relatives has a history of epilepsy or strokes, please consult with a medical specialist before using the 3D function.

- Even those without a personal or family history of epilepsy or stroke may have an undiagnosed condition that can cause “photosensitive epileptic seizures.”
- If you experience any of the following symptoms immediately stop watching 3D pictures and consult a medical specialist: **(1) altered vision; (2) lightheadedness; (3) dizziness; (4) involuntary movements such as eye or muscle twitching; (5) confusion; (6) nausea; (7) loss of awareness; (8) convulsions; (9) cramps; and/or (10) disorientation.** Parents should monitor and ask their children about the above symptoms—children and teenagers may be more likely than adults to experience these symptoms.
- Note that watching TV while sitting too close to the screen for an extended period of time may weaken your eyesight.
- Note that watching TV while wearing 3D Active Glasses for an extended period of time may cause a headache or fatigue. If you feel headache, fatigue or dizziness, stop watching TV and rest.
- Some 3D pictures may startle viewers. The pregnant, elderly, epileptic and those suffering from serious physical conditions are advised to avoid utilizing the unit's 3D functionality.
- We don't recommend 3D pictures to those who are in bad physical condition, who are sleep-deprived or who drank liquor.
- Please take care to be aware of the world around you. This product is designed to be immersive. DO NOT use this product near open stairwells, cables, balconies, or other objects that can be tripped over, run into, knocked down, broken or fallen over. Being startled or deluding yourself into thinking that the 3D images are real may cause you to crush a nearby object or get injured trying to move your body.
- Do not use the 3D Active Glasses for any other purpose than for which it was designed. Wearing the with an HDMI/DVI for any other purpose (as general spectacles, sunglasses, protective goggles, etc.) may physically harm you or weaken your eyesight.
- Immersive video can potentially have adverse effects on the user including motion sickness, perceptual after effects, disorientation, eye strain, and decreased postural stability. Take frequent breaks to lessen the potential of these effects, as is commonly suggested for other items, such as keyboards and computer monitors, that you may tend to fixate or concentrate on. If your eyes show signs of fatigue or dryness or if you have any of the above symptoms, immediately discontinue use of this device and do not resume using it for at least thirty minutes after the symptoms have subsided.
- The ideal viewing distance should be three times or more the height of the screen. We recommend sitting with viewer's eyes on a level with the screen.

Basic Features

3D

This exciting new feature enables you to view 3D content. In order to fully enjoy this feature, you must purchase a pair of Samsung 3D Active Glasses (SSG-2100AB, SSG-2200AR, SSG-2200KR) to view 3D video.

Samsung 3D Active Glasses are sold separately. For more detailed purchasing information, contact the retailer where you purchased this TV.

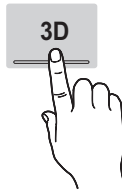

If there is any obstacle between the emitter and 3D Active Glasses, the proper 3D effect may not be obtained.

■ **3D Mode:** Select the 3D input format.

If you want to feel the 3D effect fully, please wear the 3D Active Glasses first, and then select **3D mode** from the list below that provides the best 3D viewing experience.

| 3D Mode | Operation |
|-----------------|--|
| Off | Turns the 3D function off. |
| 2D → 3D | Changes a 2D image to 3D. |
| Side by Side | Displays two images next to each other. |
| Top & Bottom | Displays one image above another. |
| Line by Line | Displays the images for the left and right eye alternately in rows. |
| Vertical Stripe | Displays the images for the left and right eye alternately in columns. |
| Checker Board | Displays the images for the left and right eye alternately in pixels. |
| Frequency | Displays the images for the left and right eye alternately in frames. |

“Side by Side” and “Top & Bottom” are available when the resolution is 720p, 1080i and 1080p in **DTV, HDMI** and **USB** mode or set to PC connecting through HDMI/DVI cable.

“Vertical Strip”, “Line by Line” and “Checker Board” are available when the resolution is set to PC connecting through HDMI/DVI cable.

“Frequency” displays the frequency (60Hz only) when the resolution is set to PC.

■ **3D → 2D (Off / On):** Displays the image for the left eye only.
This function is deactivated when **3D Mode** set to “2D → 3D” or **Off**.

■ **Depth:** Adjusts focus / depth in “2D → 3D” mode.

This function is only activated when the **3D Mode** is “2D → 3D”.

■ **Picture Correction:** Adjusts the images for the left and right eye.

■ **3D Auto View (Off / On):** If **3D Auto View** is set to **On**, a “Side-By-Side” format HDMI signal with one of the resolutions below is automatically switched to 3D. Here, correct 3D information must be sent from the HDMI 1.3 transmitter.

If a 3D failure occurs due to a 3D information error, set **3D Auto View** to **Off** and manually select a **3D Mode** using the 3D button or corresponding menu.

Support resolution (16:9 only)

| Resolution | Frequency (Hz) |
|--------------|----------------------|
| 1280 x 720p | 50 / 60 Hz |
| 1920 x 1080i | 50 / 60 Hz |
| 1920 x 1080p | 24 / 30 / 50 / 60 Hz |

Resolution supported for HDMI PC mode

The resolution for HDMI PC mode is optimized to 1920 x 1080 input.

An input resolution other than 1920 x 1080 may not be displayed properly in 3D display or full screen mode.

How to watch the 3D image

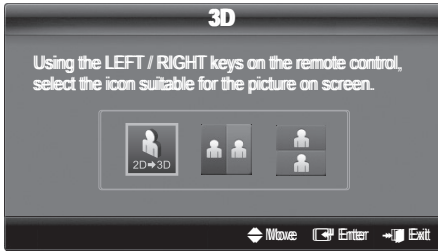

1. Press the **CONTENT** button, then the **Content View** menu will appear.
2. Press the **◀** or **▶** button, then select **3D**.
To watch in 3D, wear 3D Active Glasses and press the power button on the glasses.
3. Select **OK**, then press the **ENTER** button.
4. Using the **◀** or **▶** buttons on your remote control, selects the **3D Mode** of the image you want to view.
 Some 3D modes may not be available depending on the format of the image source.

Supported formats and operating specifications for HDMI 1.4

| Source signal format | Standard HDMI 1.4 3D |
|----------------------|----------------------|
| 1920x1080p@24Hz x 2 | 1920x2205p@24Hz |
| 1280x720p@60Hz x 2 | 1280x1470p@60Hz |
| 1280x720p@50Hz x 2 | 1280x1470p@50Hz |

The mode is automatically switched to 3D mode for the 3D video input in one of the formats above.

For the HDMI 1.4@24Hz format, the TV is optimized as follows:

- **Resolution First Display Mode:** If **Auto Motion Plus** is set to **Off**, **Clear** or **Standard**, you can watch the video at a high resolution optimized to the resolution of the source video.
- **Judder Reduction Display Mode:** When **Auto Motion Plus** is set to **Smooth** or **Custom**, you can watch a smooth picture without judder.

Before using 3D function...

NOTE

- When watching 3D images under a fluorescent lamp (50Hz ~ 60Hz) or 3 wavelength lamp, you may notice a small amount of screen flickering. If so, dim the light or turn the lamp off.
- 3D mode is automatically disabled in following cases: when changing a channel or the input source, or accessing **Media Play** or **Internet@TV**.
- Some Picture functions are disabled in **3D** mode.
- **PIP** and data broadcast is not supported in **3D** mode.
- **Auto Store** and **Manual Store** is disabled in **3D** mode.
- Data broadcasts (MHEG / MHP) are not supported in 3D mode.
- 3D Active Glasses from other manufacturers may not be supported.
- When the TV is initially powered on, may take some time until the 3D display is optimized.
- If there is any other 3D product, electronic devices such as a PDP or LCD TV, or wireless communication devices nearby, the 3D Active Glasses may not work properly due to mutual interference. If there is a problem, keep other electronic devices as far away as possible from the 3D Active Glasses.
- When watching pictures from a 50Hz 3D source with its Game mode On, visually-sensitive viewers may see some flicker on bright images.
- **Photos** of **Media Play** are shown in “2D → 3D” mode only.
- If lying on your side, the 3D-effects may not be displayed.

Basic Features

Picture Reset (OK / Cancel)

Resets your current picture mode to its default settings.

Setting up the TV with Your PC

Set the input source to PC.

Auto Adjustment

Adjust frequency values/positions and fine tune the settings automatically.

 Not available when connecting with an HDMI/DVI cable.

Screen

- **Coarse / Fine:** Removes or reduces picture noise. If the noise is not removed by Fine-tuning alone, then adjust the frequency as best as possible (**Coarse**) and Fine-tune again. After the noise has been reduced, readjust the picture so that it is aligned to the centre of screen.
- **Position:** Adjust the PC screen position with direction button (▲ / ▼ / ◀ / ▶).
- **Image Reset:** Resets the image to default settings.

Using Your TV as a Computer (PC) Display

Setting Up Your PC Software (Based on Windows XP)
Depending on the version of Windows and the video card, the actual screens on your PC may differ in which case the same basic set-up information will almost always be applied. (If not, contact your computer manufacturer or Samsung Dealer.)

1. Click on "Control Panel" on the Windows start menu.
2. Click on "Appearance and Themes" in the "Control Panel" window and a display dialog-box will appear.
3. Click on "Display" and a display dialog box will appear.
4. Navigate to the "Settings" tab on the display dialog-box.
 - The correct size setting (resolution) [Optimum: 1920 X 1080 pixels]
 - If a vertical-frequency option exists on your display settings dialog box, the correct value is "60" or "60 Hz". Otherwise, just click "OK" and exit the dialog box.

Sound Menu

Changing the Preset Sound Mode

SRS TheaterSound

- **Standard:** Selects the normal sound mode.
- **Music:** Emphasizes music over voices.
- **Movie:** Provides the best sound for movies.
- **Clear Voice:** Emphasizes voices over other sounds.
- **Amplify:** Increase the intensity of high-frequency sound to allow a better listening experience for the hearing impaired.

Adjusting Sound Settings

Equalizer

Adjusts the sound mode (standard sound mode only).

- **Balance L/R:** Adjusts the balance between the right and left speaker.
- **100Hz / 300Hz / 1kHz / 3kHz / 10kHz** (Bandwidth Adjustment): Adjusts the level of specific bandwidth frequencies.
- **Reset:** Resets the equalizer to its default settings.

Sound Systems, Etc.

SRS TruSurround HD (Off / On)

(standard sound mode only)

This function provides a virtual 5.1 channel surround sound experience through a pair of speakers using HRTF (Head Related Transfer Function) technology.

SRS TruDialog (Off / On)

(standard sound mode only)

This function allows you to increase the intensity of a voice over background music or sound effects so that dialog can be heard more clearly.

Audio Language

(digital channels only)

Change the default value for audio languages.

 The available language may differ depending on the broadcast.

Audio Format (MPEG / Dolby Digital 5.1)

(digital channels only)

When sound is emitted from both the main speaker and the audio receiver, a sound echo may occur due to the decoding speed difference between the main speaker and the audio receiver. In this case, use the TV Speaker function.

- ✎ **Audio Format** option may differ depending on the broadcast. 5.1ch Dolby digital sound is only available when connecting an external speaker through an optical cable.

Audio Description

(not available in all locations) (digital channels only)

This function handles the Audio Stream for the AD (Audio Description) which is sent along with the Main audio from the broadcaster.

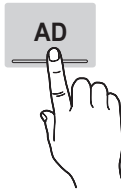

- **Audio Description (Off / On):** Turn the audio description function on or off.
- **Volume:** Adjust the audio description volume.

Auto Volume (Off / Normal / Night)

To equalize the volume level on each channel, set to **Normal**.

- **Night:** This mode provides an improved sound experience compared to **Normal** mode, making almost no noise. It is useful at night.

Speaker Select (External Speaker / TV Speaker)

A sound echo may occur due to a difference in decoding speed between the main speaker and the audio receiver. In this case, set the TV to **External Speaker**.

- ✎ When **Speaker Select** is set to **External Speaker**, the volume and MUTE buttons will not operate and the sound settings will be limited.
- ✎ When **Speaker Select** is set to **External Speaker**
 - **TV Speaker: Off , External Speaker: On**
- ✎ When **Speaker Select** is set to **TV Speaker**
 - **TV Speaker: On , External Speaker: On**
- ✎ If there is no video signal, both speakers will be mute.

Additional Setting

- **DTV Audio Level (MPEG / HE-AAC):** This function allows you to reduce the disparity of a voice signal (which is one of the signals received during a digital TV broadcast) to a desired level.

- ✎ According to the type of broadcast signal, **MPEG / HE-AAC** can be adjusted between -10dB and 0dB.
- ✎ To increase or decrease the volume, adjust between the range 0 and -10 respectively.

- **SPDIF Output:** SPDIF (Sony Philips Digital InterFace) is used to provide digital sound, reducing interference going to speakers and various digital devices such as a DVD player.

Audio Format: During the reception of a digital TV broadcast, you can select the Digital Audio output (SPDIF) format from the options **PCM** or **Dolby Digital**.

- ✎ By connecting to 5.1ch speakers in a Dolby Digital setup, maximize your interactive 3D sound experience.

Audio Delay: Correct audio-video sync problems, when watching TV or video, and when listening to digital audio output using an external device such as an AV receiver (0ms ~ 250ms).

- **Dolby Digital Comp (Line / RF):** This function minimizes signal disparity between a dolby digital signal and a voice signal (i.e. MPEG Audio, HE-AAC, ATV Sound).

- ✎ Select **Line** to obtain dynamic sound, and **RF** to reduce the difference between loud and soft sounds at night time.

Line: Set the output level for signals greater or less than -31dB (reference) to either -20dB or -31dB.

RF: Set the output level for signals greater or less than -20dB (reference) to either -10dB or -20dB.

Sound Reset (OK / Cancel)

Reset all sound settings to the factory defaults.

Selecting the Sound Mode

When you set to **Dual I-II**, the current sound mode is displayed on the screen.

| | Audio Type | Dual I-II | Default |
|--------------|------------|--|------------------|
| A2 Stereo | Mono | Mono | Automatic change |
| | Stereo | Stereo ↔ Mono | |
| | Dual | Dual I ↔ Dual II | Dual I |
| NICAM Stereo | Mono | Mono | Automatic change |
| | Stereo | Mono ↔ Stereo | |
| | Dual | Mono ↔ Dual I ↔ Dual II ↙ | Dual I |

- ✎ If the stereo signal is weak and an automatic switching, occurs, then switch to the mono.
- ✎ Only activated in stereo sound signal.
- ✎ Only available when the **Input** source is set to **TV**.

Basic Features

Setup Menu

Setting the Time

Time

- **Clock:** Setting the clock is for using various timer features of the TV.

 The current time will appear every time you press the **INFO** button.

 If you disconnect the power cord, you have to set the clock again.

Clock Mode (Auto / Manual)

 Depending on the broadcast station and signal, the auto time set up may not be correct. In this case, set the time manually.

 The antenna must be connected in order to set the time automatically.

Clock Set: Set the **Day, Month, Year, Hour** and **Minute** manually.

 Available only when **Clock Mode** is set to **Manual**.

Time Zone (Australia only): Select your time zone.

 This function is only available when the **Clock Mode** is set to **Auto**.

Using the Sleep Timer

- **Sleep Timer** : Automatically shuts off the TV after a preset period of time. (30, 60, 90, 120, 150 and 180 minutes).

 To cancel **Sleep Timer**, select **Off**.

Setting the On / Off Timer

- **Timer 1 / Timer 2 / Timer 3:** Three different on / off timer settings can be made. You must set the clock first.

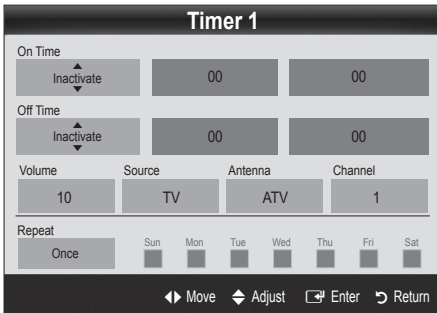

On Time / Off Time: Set the hour, minute, and activate / inactivate. (To activate timer with the setting you've chosen, set to **Activate**.)

Volume: Set the desired volume level.

Source: Select **TV** or **USB** content to be played when the TV is turned on automatically. (**USB** can be selected only when a USB device is connected to the TV)

Antenna (when the **Source** is set to **TV**): Select **ATV** or **DTV**.

Channel (when the **Source** is set to **TV**): Select the desired channel.

Contents (when the **Source** is set to **USB**): Select a folder in the USB device containing music or photo files to be played when the TV is turned on automatically.

NOTE

- If there is no music file on the USB device or the folder containing a music file is not selected, the Timer function does not operate correctly.
- When there is only one photo file in the USB device, the Slide Show will not play.
- If a folder name is too long, the folder cannot be selected.
- Each USB you use is assigned its own folder. When using more than one of the same type of USB, make sure the folders assigned to each USB have different names.

Repeat: Select **Once, Everyday, Mon~Fri, Mon~Sat, Sat~Sun** or **Manual** to set at your convenience. If you select **Manual**, you can set up the day you want to activate the timer.

 The **✓** mark indicates the day is selected.

 **Auto Power Off** (available only when the TV is turned on by **Timer**): The TV will be automatically turned off after 3 hours of being left idle to prevent overheating.

Locking Programmes

Security

 The PIN input screen appears before the setup screen.

 Enter your 4-digit PIN, the default of which is "0-0-0-0". Change the PIN using the **Change PIN** option.

- **Child Lock (Off / On):** Lock channels in **Channel Manager**, to prevent unauthorized users, such as children, from watching unsuitable programme.

 Available only when the **Input** source is set to **TV**.

- **Parental Lock:** Prevent unauthorized users, such as children, from watching unsuitable programme with a user-defined 4-digit PIN code. If the selected channel is locked, the  symbol will be displayed.

Allow All: Unlock all TV ratings.

 The items of **Parental Lock** differs depending on the country.

- **Change PIN:** Change your personal ID number required to set up the TV.

 If you forget the PIN code, press the remote control buttons in the following sequence, which resets the PIN to "0-0-0-0": **POWER** (off) → **MUTE** → 8 → 2 → 4 → **POWER** (on).



Other Features

Language

- **Teletext Language:** Set a desired language for teletext.
 -  English is the default in cases where the selected language is unavailable in the broadcast.
- **Preference (Primary Audio Language / Secondary Audio Language / Primary Subtitle Language / Secondary Subtitle Language / Primary Teletext Language / Secondary Teletext Language):** Select a language, which will be the default language when a channel is selected.

Subtitle

Use this menu to set the **Subtitle** mode.

- **Subtitle (Off / On):** Switches subtitles on or off.
- **Mode (Normal / Hearing Impaired):** Sets the subtitle mode.
- **Subtitle Language:** Sets the subtitle language.
 -  If the programme you are watching does not support the **Hearing Impaired** function, **Normal** automatically activates even if the **Hearing Impaired** mode is selected.
 -  English is the default in cases where the selected language is unavailable in the broadcast.



Digital Text (Disable / Enable)

(New Zealand only)

If the programme broadcasts with digital text, this feature is enabled.

-  **NOTE**
 - **MHEG** (Multimedia and Hypermedia Information Coding Experts Group)
 - An International standard for data encoding systems used in multimedia and hypermedia. This is at a higher level than the MPEG system which includes data-linking hypermedia such as still images, character service, animation, graphic and video files as well as multimedia data. MHEG is user runtime interaction technology and is being applied to various fields including VOD (Video-On-Demand), ITV (Interactive TV), EC (Electronic Commerce), tele-education, tele-conferencing, digital libraries and network games.
 - At present, the broadcasting station provides EPG content only. Providing more content is scheduled for the future.
 - If **Digital Text** is set to **Disable**, the EPG (Electronic Program Guide) will not work.

Network (Network Type / Network Setup / Network Test / SWL(Samsung Wireless Link) / SWL connect)

For details on set up options, refer to the “Network Connection” instructions (p. 27).

General

- **Game Mode (Off / On):** When connecting to a game console such as PlayStation™ or Xbox™, you can enjoy a more realistic gaming experience by selecting game mode.

NOTE

- Precautions and limitations for game mode
 - To disconnect the game console and connect another external device, set **Game Mode** to **Off** in the setup menu.
 - If you display the TV menu in **Game Mode**, the screen shakes slightly.
- **Game Mode** is not available when the input source is set to TV or PC.
- After connecting the game console, set **Game Mode** to **On**. Unfortunately, you may notice reduced picture quality.
- If **Game Mode** is **On**:
 - **Picture** mode is set to **Standard** and **Sound** mode is set to **Movie**.
 - **Equalizer** is not available.
- **BD Wise (Off / On):** Provides the optimal picture quality for Samsung DVD, Blu-ray and Home Theatre products which support **BD Wise**. When **BD Wise** is turned **On**, the picture mode is automatically changed to the optimal resolution.
 -  Available when connecting Samsung products that support **BD Wise** through a HDMI cable.
- **Menu Transparency (Bright / Dark):** Set the Transparency of the menu.
- **Melody (Off / Low / Medium / High):** Set so that a melody plays when the TV is turned on or off.
- **FastStart (Off / On):** When the TV is powered on, the screen will come on quickly with this feature.

Wireless Remote Control

Turn wireless remote controls on or off or give permission to wireless remote controls.

Basic Features

Picture In Picture (PIP)











PIP

You can watch the TV tuner and one external video source simultaneously. **PIP** (Picture-in-Picture) does not function in the same mode.

NOTE





- For PIP sound, refer to the **Sound Select** instructions.
- If you turn the TV off while watching in **PIP** mode, the PIP window will disappear.
- You may notice that the picture in the PIP window becomes slightly unnatural when you use the main screen to view a game or karaoke.
- While **Internet@TV** is in operation, the **PIP** function cannot be used.
- PIP settings

| Main picture | Sub picture |
|---|-------------|
| Component, HDMI1/DVI, HDMI2, HDMI3, HDMI4, PC | TV |

- **PIP (Off / On):** Activate or deactivate the PIP function.
- **Channel:** Select the channel for the sub-screen.
- **Size** ( /  /  / ): Select a size for the sub-picture.
- **Position** ( /  /  / ): Select a position for the sub-picture.
 -  In Double ( , ) mode, Position cannot be selected.
- **Sound Select (Main / Sub):** You can choose the desired sound (**Main / Sub**) in **PIP** mode.

Support Menu

Self Diagnosis

-  Self Diagnostic might take few seconds, this is part of the normal operation of the TV
- **Picture Test (Yes / No):** Use to check for picture problems.
- **Sound Test (Yes / No):** Use the built-in melody sound to check for sound problems.
 -  If you hear no sound from the TV's speakers, before performing the sound test, make sure **Speaker Select** is set to **TV Speaker** in the **Sound** menu.
 -  The melody will be heard during the test even if **Speaker Select** is set to **External Speaker** or the sound is muted by pressing the **MUTE** button.
- **Signal Information:** (digital channels only) HDTV channel's reception quality is either perfect or the channels are unavailable. Adjust your antenna to increase signal strength.
- **Troubleshooting:** If the TV seems to have a problem, refer to this description.
 -  If none of these troubleshooting tips apply, contact the Samsung customer service centre.

Software Upgrade

Software Upgrade can be performed via a broadcasting signal or by network connection or downloading the latest firmware from "www.samsung.com," to a USB memory device.

Current Version the software already installed in the TV.

 Software is represented as "Year/Month/Day_Version".

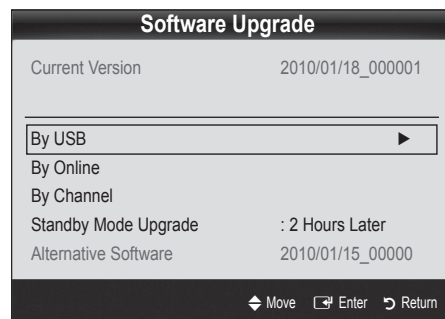

Installing the Latest Version

- **By USB:** Insert a USB drive containing the firmware upgrade file, downloaded from “www.samsung.com,” into the TV. Please be careful not to disconnect the power or remove the USB drive until upgrades are complete. The TV will be turned off and on automatically after completing the firmware upgrade. When software is upgraded, video and audio settings you have made will return to their default settings. We advise you to write down your settings so that you can easily reset them after the upgrade.
- TV Real Panel

USB Drive
- **By Online:** Upgrade the software using the Internet.

 - ✎ First, configure your network. For detailed procedures on using the Network Setup, refer to the “Network Connection” instructions.
 - ✎ If the internet connection doesn’t operate properly, the connection may be broken. Please retry downloading. If the problem persists, download by USB and upgrade.
 - **By Channel:** Upgrade the software using the broadcasting signal.

 - ✎ If the function is selected during the software transmission period, software will be automatically searched and downloaded.
 - ✎ The time required to download the software is determined by the signal status.
 - **Standby Mode Upgrade:** A manual upgrade will be automatically performed at selected time. Since the power of the unit is turned on internally, the screen may be turned on slightly for the LED product. This phenomenon may continue for more than 1 hour until the software upgrade is complete.
 - **Alternative Software (backup):** Displays the software version downloaded through **By Online**. During the software upgrading, When the Upgrade will discontinue from last step, this function be activated.

HD Connection Guide

Refer to this information when connecting external devices to the TV.

Contact Samsung

View this information when your TV does not work properly or when you want to upgrade the software. You can find information regarding our call centers and how to download products and software.

Advanced Features

Connecting to a PC

Using an HDMI/DVI Cable / a D-sub Cable

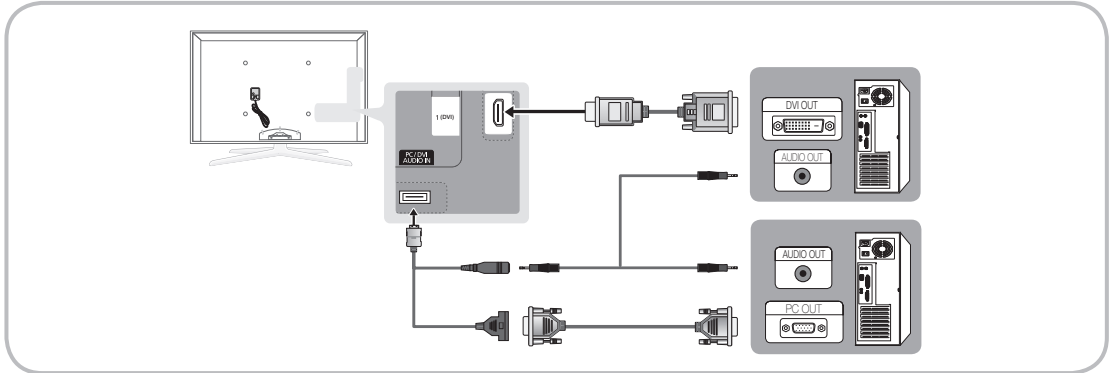

Display Modes (D-Sub and HDMI/DVI Input)

Optimal resolution is 1920 X 1080 @ 60 Hz.

| Mode | Resolution | Horizontal Frequency (KHz) | Vertical Frequency (Hz) | Pixel Clock Frequency (MHz) | Sync Polarity (H / V) |
|--------------------|--------------|----------------------------|-------------------------|-----------------------------|-----------------------|
| IBM | 640 x 350 | 31.469 | 70.086 | 25.175 | +/- |
| | 720 x 400 | 31.469 | 70.087 | 28.322 | -/+ |
| MAC | 640 x 480 | 35.000 | 66.667 | 30.240 | -/- |
| | 832 x 624 | 49.726 | 74.551 | 57.284 | -/- |
| | 1152 x 870 | 68.681 | 75.062 | 100.000 | -/- |
| VESA CVT | 720 x 576 | 35.910 | 59.950 | 32.750 | -/+ |
| | 1152 x 864 | 53.783 | 59.959 | 81.750 | -/+ |
| | 1280 x 720 | 56.456 | 74.777 | 95.750 | -/+ |
| | 1280 x 960 | 75.231 | 74.857 | 130.000 | -/+ |
| VESA DMT | 640 x 480 | 31.469 | 59.940 | 25.175 | -/- |
| | 640 x 480 | 37.861 | 72.809 | 31.500 | -/- |
| | 640 x 480 | 37.500 | 75.000 | 31.500 | -/- |
| | 800 x 600 | 37.879 | 60.317 | 40.000 | +/+ |
| | 800 x 600 | 48.077 | 72.188 | 50.000 | +/+ |
| | 800 x 600 | 46.875 | 75.000 | 49.500 | +/+ |
| | 1024 x 768 | 48.363 | 60.004 | 65.000 | -/- |
| | 1024 x 768 | 56.476 | 70.069 | 75.000 | -/- |
| | 1024 x 768 | 60.023 | 75.029 | 78.750 | +/+ |
| | 1152 x 864 | 67.500 | 75.000 | 108.000 | +/+ |
| | 1280 x 1024 | 63.981 | 60.020 | 108.000 | +/+ |
| | 1280 x 1024 | 79.976 | 75.025 | 135.000 | +/+ |
| | 1280 x 720 | 45.000 | 60.000 | 74.250 | +/+ |
| | 1280 x 800 | 49.702 | 59.810 | 83.500 | -/+ |
| | 1280 x 800 | 62.795 | 74.934 | 106.500 | -/+ |
| | 1280 x 960 | 60.000 | 60.000 | 108.000 | +/+ |
| 1360 x 768 | 47.712 | 60.015 | 85.500 | +/+ | |
| 1440 x 900 | 55.935 | 59.887 | 106.500 | -/+ | |
| 1440 x 900 | 70.635 | 74.984 | 136.750 | -/+ | |
| 1680 x 1050 | 65.290 | 59.954 | 146.250 | -/+ | |
| VESA GTF | 1280 x 720 | 52.500 | 70.000 | 89.040 | -/+ |
| | 1280 x 1024 | 74.620 | 70.000 | 128.943 | -/- |
| VESA DMT / DTV CEA | 1920 x 1080p | 67.500 | 60.000 | 148.500 | +/+ |

NOTE

- For HDMI/DVI cable connection, you must use the HDMI IN 1(DVI) jack.
- The interlace mode is not supported.
- The set might operate abnormally if a non-standard video format is selected.
- Separate and Composite modes are supported. SOG (Sync On Green) is not supported.

You can set up your TV so that it can access the Internet through your local area network (LAN) using a wired or wireless connection.

Connecting to a Wired Network

You can attach your TV to your LAN using cable in three ways:

- You can attach your TV to your LAN by connecting the LAN port on the back of your TV to an external modem using a Cat 5 cable. See the diagram below.

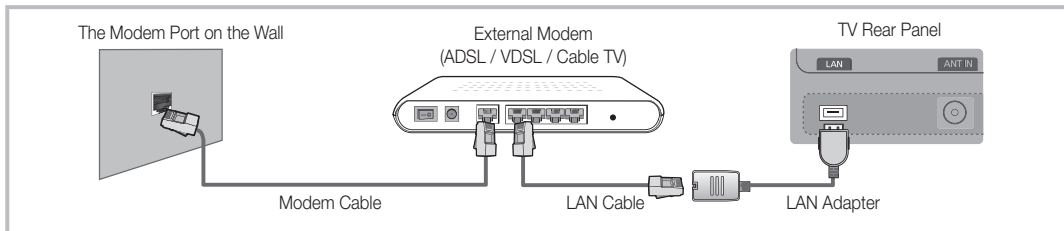

- You can attach your TV to your LAN by connecting the LAN port on the back of your TV to an IP Sharer which is connected to an external modem. Use Cat 5 cable for the connection. See the diagram below.

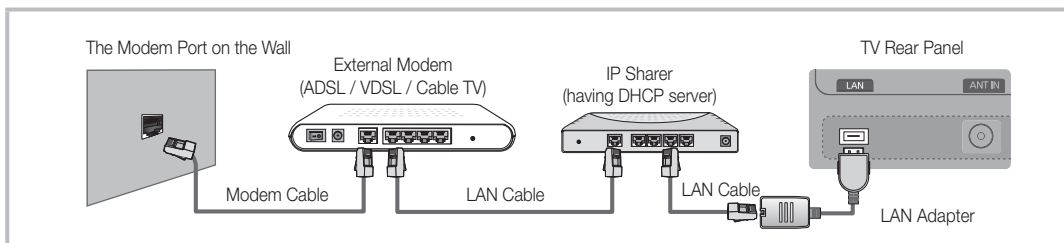

- Depending on how your network is configured, you may be able to attach your TV to your LAN by connecting the LAN port on the back of your TV directly to a network wall outlet using a Cat 5 cable. See the diagram below. Note that the wall outlet is attached to a modem or router elsewhere in your house.

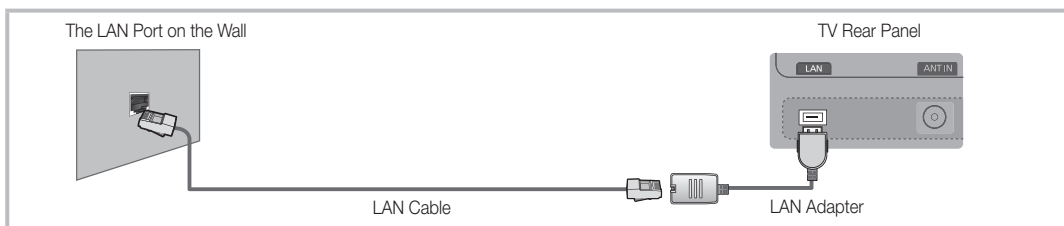

If you have a Dynamic Network, you should use an ADSL modem or router that supports Dynamic Host Configuration Protocol (DHCP). Modems and routers that support DHCP automatically provide the IP address, subnet mask, gateway, and DNS values your TV needs to access the Internet so you don't have to enter them manually. Most home networks are Dynamic Networks.

Some networks require a Static IP address. If your network requires a Static IP address, you must enter the IP address, subnet mask, gateway, and DNS values manually on your TV's Cable Setup Screen when you set up the network connection. To get the IP address, subnet mask, gateway, and DNS values, contact your Internet Service Provider (ISP). If you have a Windows computer, you can also get these values through your computer.

 You can use ADSL modems that support DHCP if your network requires a Static IP address. ADSL modems that support DHCP also let you use Static IP addresses.

Advanced Features

Network Setup (Auto)

Use the Automatic **Network Setup** when connecting your TV to a network that supports DHCP. To set up your TV's cable network connection automatically, follow these steps:

How to set up automatically

1. Connect your TV to your LAN as described in the previous section.
2. Turn on your TV, press the **MENU** button on your remote, use the **▲** or **▼** button to select **Setup**, and then press the **ENTER** button.
3. Use the **▲** or **▼** button to select **Network** in the **Setup** menu, and then press the **ENTER** button. The **Network** screen appears.

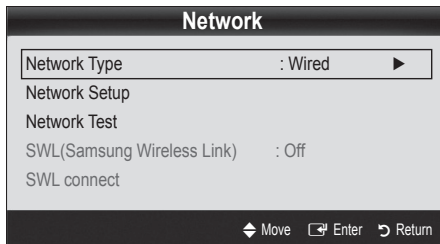

4. On the **Network** screen, select **Network Type**.
5. Set **Network Type** to **Wired**.
6. Select **Network Setup**. The **Network Setup** screen appears.

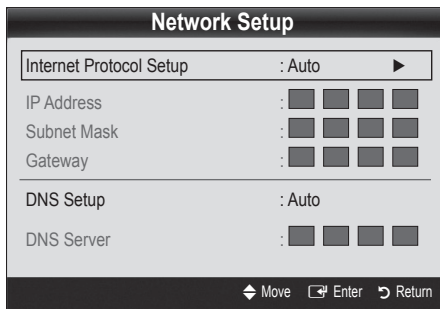

7. Set **Internet Protocol Setup** to **Auto**.
8. **Auto** acquires and enters the needed Internet values automatically.
9. When done, press the **RETURN** button on your remote.
10. Select **Network Test** to check the Internet connectivity.
11. If the **Network** Function has not acquired the network connection values, go to the directions for **Manual**.

Network Setup (Manual)

Use the Manual **Network Setup** when connecting your TV to a network that requires a Static IP address.

Getting the Network Connection Values

To get the Network connection values on most Windows computers, follow these steps:

1. Right click the Network icon on the bottom right of the screen.
2. In the pop-up menu that appears, click Status.
3. On the dialog that appears, click the Support tab.
4. On the Support Tab, click the Details button. The Network connection values are displayed.

How to set up manually

To set up your TV's cable network connection manually, follow these steps:

1. Follow Steps 1 through 6 in the "How to set up automatically" procedure.
2. Set **Internet Protocol Setup** to **Manual**.
3. Press the **▼** button on your remote to go to the first entry field.
4. Enter the **IP Address**, **Subnet Mask**, **Gateway**, and **DNS Server** values. Use the number buttons on your remote to enter numbers and the arrow buttons to move from one entry field to another.
5. When done, press the **RETURN** button on your remote.
6. Select **Network Test** to check the Internet connectivity.

Connecting to a Wireless Network

To connect your TV to your network wirelessly, you need a wireless router or modem and a Samsung Wireless LAN Adapter (WIS09ABGN), which you connect to your TV's back or side panel USB jack. See the illustration below.

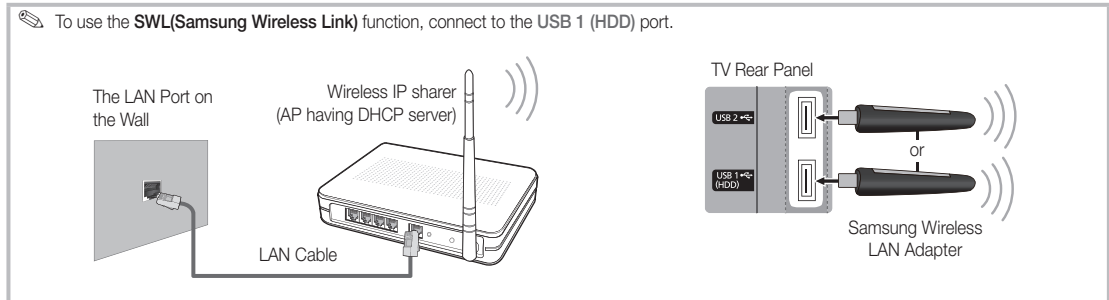

Samsung's Wireless LAN adapter is sold separately and is offered by selected retailers, E-commerce sites and Samsungparts.com. Samsung's Wireless LAN adapter supports the IEEE 802.11A/B/G and N communication protocols. Samsung recommends using IEEE 802.11N. When you play the video over a IEEE 802.11B/G connection, the video may not play smoothly.

NOTE

- You must use the "Samsung Wireless LAN Adapter" (WIS09ABGN) to use a wireless network.
- Samsung's Wireless LAN adapter is sold separately. The WIS09ABGN Wireless LAN adapter is offered by select retailers, Ecommerce sites and Samsungparts.com.
- To use a wireless network, your TV must be connected to a wireless IP sharer. If the wireless IP sharer supports DHCP, your TV can use a DHCP or static IP address to connect to the wireless network.
- Select a channel for the wireless IP sharer that is not currently being used. If the channel set for the wireless IP sharer is currently being used by another device nearby, this will result in interference and communication failure.
- If you apply a security system other than the systems listed below, it will not work with the TV.
- If Pure High-throughput (Greenfield) 802.11n mode is selected and the Encryption type is set to WEP, TKIP or TKIP-AES (WPS2Mixed) for your AP, Samsung TVs will not support a connection in compliance with new Wi-Fi certification specifications.
- If your AP supports WPS (Wi-Fi Protected Setup), you can connect to the network via PBC (Push Button Configuration) or PIN (Personal Identification Number). WPS will automatically configure the SSID and WPA key in either mode.
- Keep the Samsung Wireless LAN Adapter at a distance from the TV. If you watch the TV with the adapter connected nearby, images may appear corrupted for some channels.
- If your router, modem, or device isn't certified, it may not connect to the TV via the "Samsung Wireless LAN Adapter."
- **Connection Methods:** You can setup the wireless network connection six ways.
 - Samsung Auto Configuration
 - **PBC (WPS)**
 - Auto Setup (Using the Auto Network Search function)
 - Manual Setup
 - **SWL(Samsung Wireless Link)**
 - **Ad-Hoc**
- All of Samsung Wireless LAN Adapter should be connected directly to the TV's USB port. USB HUB are not supported.

Advanced Features

Notice

The picture may appear corrupted or have static for some channels when the TV is connected to the Samsung Wireless LAN Adapter. In such case, establish a connection using one of the following methods:

Method 1

Connect using the USB right angle adapter

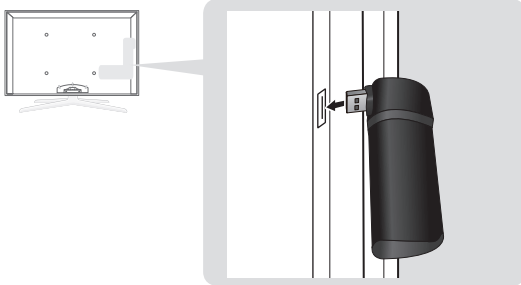

Method 2

Connect via an extension cable

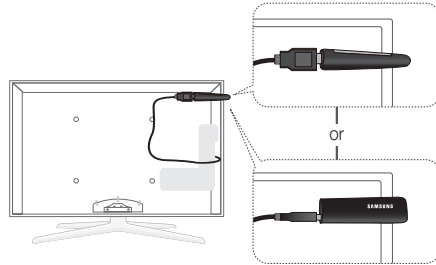





Network Setup (Samsung Auto Configuration)

This function is available in APs (Access Points) that support Auto Configuration. If your AP does not support Auto Configuration, you can connect through **PBC (WPS)**, auto, or manually.

 This function is available when **SWL(Samsung Wireless Link)** is set to **Off**.

 You can check for equipment that supports Samsung Auto Configuration on www.samsung.com.

How to set up using Samsung Auto Configuration

1. Place the AP and TV next to each other and turn them on.
 -  Because the booting time of applications differ, you may have to wait for approximately 2 minutes.
 -  If the LAN cable connected the WAN port of AP during Samsung Auto Configuration, you are able to complete until internet connection test. If you do not connect, Samsung Auto Configuration will check only device connecting of AP (Not check internet).
2. After 2 minutes, connect the Samsung Wireless LAN Adapter to the TV. When the Samsung Wireless LAN Adapter is established, the pop-up window appears.
3. As soon as a connection is established, place the AP in parallel with the Samsung Wireless LAN Adapter giving a gap no larger than 25cm.
4. Wait until the connection is automatically established.
 -  If the connection fails, reset the AP and then try again.
 -  If Samsung Auto Configuration does not connect your TV to your AP, a pop-up window appears on the screen notifying you of the failure. Reset the AP, and then try again. If the connection fails again, choose one of the other connection setup methods, PBC (WPS), auto, or manual.
5. After the connection is established, locate the sharer at the desired location.
 -  If the AP settings have been changed or it is the first time you use the new AP after purchase, you need to set up again beginning from Step 1.

Network Setup (PBC (WPS))

How to set up using PBC (WPS)

If your router has a PBC (WPS) button, follow these steps:

1. Connect your TV to your LAN as described in the previous section.
2. Turn on your TV, press the **MENU** button on your remote, use the **▲** or **▼** button to select **Setup**, and then press the **ENTER** button.
3. Use the **▲** or **▼** button to select **Network** in the **Setup** menu, and then press the **ENTER** button.
4. On the **Network** screen, select **Network Type**.
5. Set **Network Type** to **Wireless**.
6. Select **Network Setup**. The **Network Setup** screen appears.

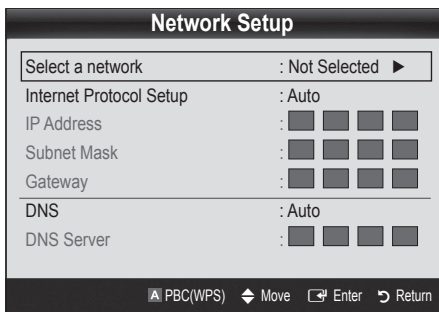

7. Press the Red button on your remote.
8. Press the PBC (WPS) button on your router within 2 minutes. Your TV player automatically acquires all the network setting values it needs and connects to your network.
9. After the network connection is set up, press the **RETURN** button to exit the **Network Setup** screen.

Network Setup (Auto)

Most wireless networks have an optional security system that requires devices that access the network to transmit an encrypted security code called an Access or Security Key. The Security Key is based on a Pass Phrase, typically a word or a series of letters and numbers of a specified length you were asked to enter when you set up security for your wireless network. If you use this method of setting up the network connection, and have a Security Key for your wireless network, you will have to enter the Pass Phrase during the setup process.

How to set up automatically

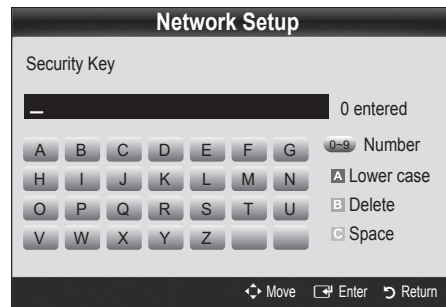

To set up the wireless connection automatically, follow these steps:

1. Follow Steps 1 through 6 in the "How to set up using PBC (WPS)" procedure.
2. Press the **▼** button to select **Internet Protocol Setup**, and then press the **ENTER** button. Press the **▲** or **▼** button to select **Auto**, and then press the **ENTER** button.
3. Press the **▲** button to go to **Select a Network**, and then press the **ENTER** button. The **Network** function searches for available wireless networks. When done, it displays a list of the available networks.
4. In the list of networks, press the **▲** or **▼** button to select a network, and then press the **ENTER** button.
 - If the AP is set to Hidden (Invisible), you have to select **Add Network** and enter the correct **Network Name (SSID)** and **Security Key** to establish the connection.
5. If the Security/PIN pop-up appears, go to Step 6. If the Network Connecting Screen appears, go to Step 10.
6. Press the **▲** or **▼** button to select **Security** or **PIN**. For most home networks, you would select Security (for **Security Key**). The **Security** Screen appears.



7. On the **Security** screen, enter your network's Pass Phrase.
 - You should be able to find the Pass Phrase on one of the set up screens you used to set up your router or modem.

Advanced Features

- To enter the Pass Phrase, follow these general directions:
 - Press the number buttons on your remote to enter numbers.
 - Use the direction buttons on your remote to move from button to button on the **Security Key** screen.
 - Press the Red button to change case or display symbols/characters.
 - To enter a letter or symbol, move to the letter or symbol, and then press the **ENTER**  button.
 - To delete the last letter or number you entered, press the Green button on your remote.
- When done, press the Blue button on your remote. The Network Connecting screen appears.
- Wait until the connection confirmation message is displayed, and then press the **ENTER**  button. The **Network Setup** screen re-appears.
- To test the connection, press the **RETURN** button to select **Network Test**, and then press the **ENTER**  button.

Network Setup (Ad-Hoc)

You can connect to a mobile device without an access point through the “Samsung Wireless LAN Adapter” by using a peer to peer network.

 This function is available when **SWL(Samsung Wireless Link)** is set to **Off**.

How to connect to new Ad-hoc device

- Follow Steps 1 through 6 in the “How to set up using PBC (WPS)” (p. 31).
- Choose **Select a network**. A list of devices/networks appears.
- While in the device list, press the Blue button on the remote.
 -  The message **Ad-hoc is a direct Wi-Fi connection with cell phone or PC. The existing network system may have limited functionality. Do you want to change the network connection?** is displayed.
- Input the generated **Network Name (SSID)** and **Security Key** into the device you want to connect.

How to connect an existing Ad-hoc device

- Follow Steps 1 through 6 in the “How to set up using PBC (WPS)” (p. 31).
- Choose **Select a network**. The Device/Network list appears.
- Select the device you want in the Device list.
- If security key is required, input the security key.
 -  If network doesn't operate normally, check the **Network Name (SSID)** and **Security Key** again. An incorrect **Security Key** may cause a malfunction.

Network Setup (Manual)

If the other methods do not work, you need to enter the Network setting values manually.



Getting the Network Connection Values

To get the Network connection values on most Windows computers, follow these steps:

- Right click the Network icon on the bottom right of the screen.
- In the pop-up menu, click Status.
- On the dialog that appears, click the Support tab.
- On the Support tab, click the Details button. The Network settings are displayed.



How to set up manually

To enter the Network connection values manually, follow these steps:

- Follow Steps 1 through 6 in the “How to set up using PBC (WPS)” (p. 31).
- Press the **▼** button to select **Internet Protocol Setup**, and then press the **ENTER**  button. Press the **▲** or **▼** button to select **Manual**, and then press the **ENTER**  button.
- Press the **▼** button to go to the first entry field (IP Address).
- Use the number buttons to enter numbers.
- When done with each field, use the **▶** button to move successively to the next field. You can also use the other arrow buttons to move up, down, and back.
- Enter the **IP Address**, **Subnet Mask**, and **Gateway** values.
- Press the **▲** or **▼** button to go to **DNS**.
- Press the **▼** button to go to the first DNS entry field. Enter the numbers as above.
- When done, press the **▲** button to go to **Select a Network**. Select your network, and then press the **ENTER**  button.
- Go to Step 4 in the “How to set up automatically” (p. 31), and follow the directions from that point on.

SWL(Samsung Wireless Link)

This function lets you connect a Samsung device that supports the PBC (WPS) to your TV. You can connect devices to the TV even if a sharer is not connected to the TV.

-  To use the Internet@TV, the AP (access point) must be connected to the wireless network.
-  If a Samsung Wireless LAN Adapter is connected to the **USB 2** port, the network may not operate normally. We recommend to connecting it to the **USB 1 (HDD)** port.
-  Only sharers using the 2.4 Ghz band are supported. Sharers using the 5 Ghz band are not supported.





SWL connect

You can directly connect a device that supports the PBC (WPS) to the TV.

-  This function is available when **SWL(Samsung Wireless Link)** is set to **On**.

How to connect Samsung Wireless Link

For the procedures to establish a connection, refer to the following:

1. Follow Steps 1 through 5 in the "How to set up using PBC (WPS)" (p. 31).
2. Select **SWL(Samsung Wireless Link)** by using the ▼ button and press the ENTER  button to turn it On.
3. Select **SWL connect** by using the ▼ button and press the ENTER  button.
4. If the "**Press the PBC button on the device which supports PBC button to connect within 120 seconds**" message appears, press the PBC button on the device to connect.
 -  For more information, refer to the wireless network setup manual of the device to be connected.
5. The device is connected. Go to **Network Setup** and press the ENTER  button. You can configure the network for the connected device.
 -  If the connection fails, please retry after 2 minutes.

If Your TV Fails to Connect to the Internet

Your TV may not be able to connect to the Internet because your ISP has permanently registered the MAC address (a unique identifying number) of your PC or modem, which it then authenticates each time you connect to the Internet as a way of preventing unauthorized access. As your TV has a different MAC address, your ISP can not authenticate its MAC address, and your TV can not connect.

To resolve this problem, ask your ISP about the procedures required to connect devices other than a PC (such as your TV) to the Internet.

If your Internet service provider requires an ID or password to connect to the Internet, your TV may not be able to connect to the Internet. If this is the case, you must enter your ID or password when connecting to the Internet.

The internet connection may fail because of a firewall problem. If this is the case, contact your Internet service provider.

If you cannot connect to the Internet even after you have followed the procedures of your Internet service provider, please contact Samsung Electronics at 1-800-SAMSUNG.

Advanced Features

Media Play



Enjoy photos, music and/or movie files saved on a USB Mass Storage Class (MSC) device and/or your PC.

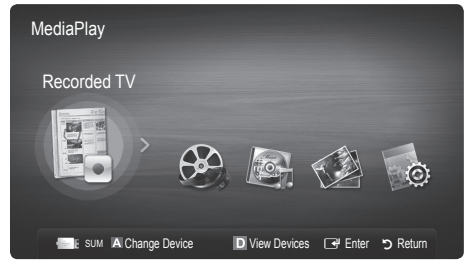

Connecting a USB Device

1. Turn on your TV.
2. Connect a USB device containing recorded tv, photo, music and/or movie files to the **USB 1 (HDD)** or **USB 2** jack on the side of the TV.
3. When USB is connected to the TV, popup window appears. Then you can select **Media Play**.

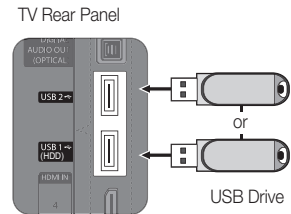

Connecting to the PC through network

You can play pictures, music and videos saved on your PC through a network connection in the **Media Play** mode.

If you use **Media Play** through saved file on your PC, you should download “PC Share Manager” and users manual from “www.samsung.com.”

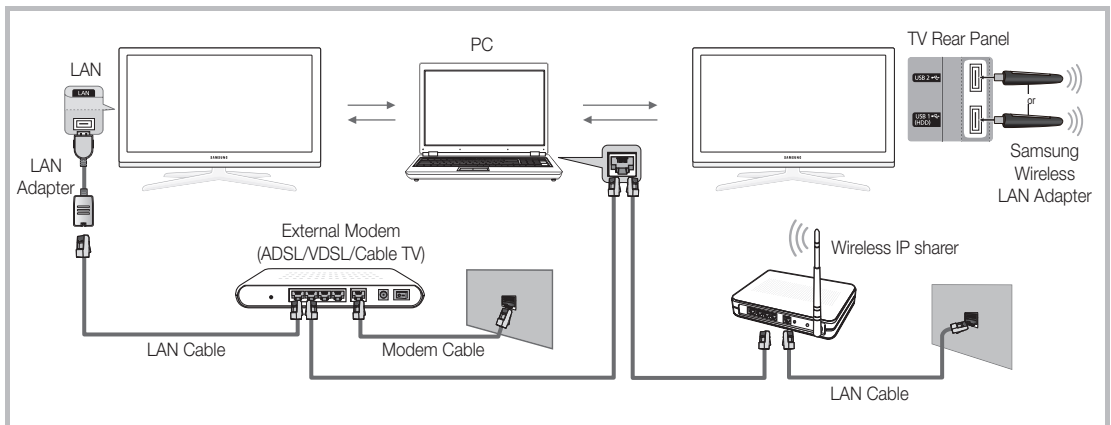



1. For more information on how to configure your network, refer to “Network Connection” (p. 27).
 - You are recommended to locate both TV and PC in same subnet. The first 3 parts of the subnet address of the TV and the PC IP addresses should be the same and only the last part (the host address) should be changed. (e.g. IP Address: 123.456.789.**)
2. Using a LAN cable, connect between the external modem and the PC onto which the Samsung PC Share Manager programme will be installed.
 - You can connect the TV to the PC directly without connecting it through a Sharer (Router).

- ✎ No supported functions when connecting to the PC through network:
 - The **Background Music** and **Background Music Setting** functions.
 - Sorting files by preference in the **Photos**, **Music**, and **Videos** folders.
 - The ◀ (REW) or ▶ (FF) button while a movie is playing.
- ✎ The Divx DRM, Multi-audio, embedded caption does not supported.
- ✎ Samsung PC Share manager should be permitted by the firewall programme on your PC.
- ✎ When you use **Media Play** mode through a network connection, According to functions of the provided server:
 - The sorting method may vary.
 - The scene search function may not be supported.
 - The **Play Continuously** function, which resumes playing of a video, may not be supported.
 - The **Play Continuously** function does not support multiple users. (It will have only memorised the point where the most recent user stopped playing.)
 - The ◀ or ▶ button may not work depending on the content information.
 - If you experience any file stuttering issue while playing a video over a wireless network, we recommend using a wired network.
- ✎ It might not work properly with unlicensed multimedia files.
- ✎ Need-to-Know List before using **Media Play**
 - MTP (Media Transfer Protocol) is not supported.
 - The file system supports FAT16, FAT32 and NTFS.
 - Certain types of USB Digital camera and audio devices may not be compatible with this TV.
 - Media Play only supports USB Mass Storage Class (MSC) devices. MSC is a Mass Storage Class Bulk-Only Transport device. Examples of MSC are Thumb drives, Flash Card Readers and USB HDD (USB HUB are not supported). Devices should be connected directly to the TV's USB port.
 - Before connecting your device to the TV, please back up your files to prevent them from damage or loss of data. SAMSUNG is not responsible for any data file damage or data loss.
 - Connect a USB HDD to the dedicated port, **USB 1 (HDD)** port.
 - Do not disconnect the USB device while it is loading.
 - The higher the resolution of the image, the longer it takes to display on the screen.
 - The maximum supported JPEG resolution is 15360X8640 pixels.
 - For unsupported or corrupted files, the "Not Supported File Format" message is displayed.
 - If the files are sorted by Basic View, up to 1000 files can be displayed in each folder.
 - MP3 files with DRM that have been downloaded from a non-free site cannot be played. Digital Rights Management (DRM) is a technology that supports the creation of content, the distribution and management of the content in an integrated and comprehensive way, including the protection of the rights and interests of the content providers, the prevention of the illegal copying of contents, as well as managing billings and settlements.
 - If more than 2 PTP devices are connected, you can only use one at a time.
 - If more than two MSC devices are connected, some of them may not be recognized. A USB device that requires high power (more than 500mA or 5V) may not be supported.
 - If an over-power warning message is displayed while you are connecting or using a USB device, the device may not be recognized or may malfunction.
 - If the TV has been no input during time set in **Auto Protection Time**, the Screensaver will run.
 - The power-saving mode of some external hard disk drives may be released automatically when connected to the TV.
 - If a USB extension cable is used, the USB device may not be recognized or the files on the device may not be read.
 - If a USB device connected to the TV is not recognized, the list of files on the device is corrupted or a file in the list is not played, connect the USB device to the PC, format the device and check the connection.
 - If a file deleted from the PC is still found when Media Play is run, use the "Empty the Recycle Bin" function on the PC to permanently delete the file.

Advanced Features

Screen Display

Move to the file you desired using the up/down/right/left buttons and then press the ENTER  or  (Play) button. The file is played.

 Supports the **View Devices** and **Home in Media Play** homepage.

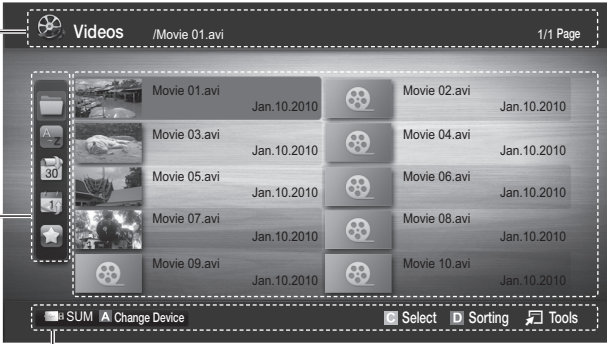





Information:
You can ascertain the selected file name and the number of files and page.



Sort List Section:
Displays sorting standard.

 Sorting standard is different depending on the contents.

File List Section:
You can confirm the files and groups that is sorted by each category.

Operation Buttons

-  **Red (Change Device):** Selects a connected device.
-  **Green (Preference):** Sets the file preference. (not supported in Basic view)
-  **Yellow (Select):** Selects multiple files from file list. Selected files are marked with a symbol.
-  **Blue (Sorting):** Selects the sort list.
-  **Tools:** Displays the option menu.

 Using the  (REW) or  (FF) button, file list can move to next or previous page.

Recorded TV

To use the recording or Timeshift function, the connected USB device must be available for recording. **Device format** is recommended to use USB HDD.

 During the Device formatting, do not disconnect the device while formatting is in progress. If you format the device, all files will be deleted.

Playing Recorded TV Program

1. Press the  or  button to select **Recorded TV**, then press the ENTER  button in the **Media Play** menu.
2. Press the /// button to select the desired file in the file list.
3. Press the ENTER  button or  (Play) button.
 - The selected file is displayed on the top with its playing time.
 - During playing the recorded TV program, you can search using the  and  button.

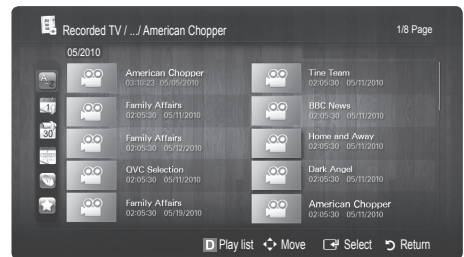



Using the Timeshift function

If you missed a live broadcast, you can see from the recorded broadcast using this feature.

When the **Timeshift Mode** is set to **Auto**, the TV stores the channel you watch currently to record automatically.

When the **Timeshift Mode** is set to **Manual**, if you press the  (Play) button, the TV stores the channel from the point of view you want to record.



 **NOTE**

- Recorded videos are DRM (digital rights management) protected and cannot be played on a PC or other TVs, nor can they be played when the main board of the TV is changed.
- Data broadcasts cannot be recorded.
- The availability of both recording and the **Timeshift Mode** function may differ depending on picture quality and the free space on the hard disk drive.
- If you press the ▲ or ▼ button, you can see the current channel being on air, or can see the start point the recorded broadcast.
- The **Timeshift Mode** operates for a maximum of 90 minutes.
- After the **Timeshift Mode** function has run for the maximum time, the time information will be fixed to "00:00:00." Note that if you have paused the recording the TV will automatically resume playback.
- If the 5% free memory space limit of the USB storage device is reached, the current recording process will be closed.
- When recording is performed by both the PVR (Personal Video Recorder) function and a device that supports the HDMI-CEC feature, recording by the PVR function takes precedence.
- During a playback or the **Timeshift Mode**, the picture will be displayed according to the display settings of the TV.
- If you change the input source during recording, the screen will go blank until the change is completed.
- An application which supports neither the recording nor the **Timeshift Mode** function will close automatically if you try to use it during either function.
- A message may appear in front of the application window indicating that the recording or the **Timeshift Mode** function is closed.
- **Timeshift Mode** function is not supported for radio channels.
- The recording and the **Timeshift Mode** functions are disabled for channels locked with **Child Lock**.
- If the USB device has failed the **Device Performance Test**, the USB device must go through the **Device Format** and **Device Performance Test** again before you record with the **Guide** or **Channel Manager**.
- The recording and **Timeshift Mode** functions can only be used with a USB storage device that completed the **Device Performance Test**.
- If you attempt the recording or **Timeshift Mode** function with a device that did not have the **Device Performance Test**, the function will not start.
- If you press  (REC) on the remote control while the **Channel Manager** screen is being displayed or record with **Timer Recording**, the TV may start or stop recording 1 or 2 seconds later than you intended due to the time needed to process the command.
- If a USB device dedicated to recording is connected, existing **Timeshift Mode** or recording files that were saved abnormally will automatically be deleted.
- If you switch to external input mode during recording, the recording will continue but the  (REC) button will be disabled.
- If any function that turns off the TV (**Sleep Timer**, Off timer, etc.) is set for a time that conflicts with recording, the TV will be turned off once the recording is complete.

Advanced Features

Videos

Playing Video

1. Press the ◀ or ▶ button to select **Videos**, then press the ENTER  button in the **Media Play** menu.
2. Press the ◀/▶/▲/▼ button to select the desired file in the file list.
3. Press the ENTER  button or ▶ (Play) button.
 - The selected file is displayed on the top with its playing time.
 - If video time information is unknown, play time and progress bar are not displayed.
 - During playing the video, you can search using the ◀ and ▶ button.

 In this mode, you can enjoy movie clips contained on a Game, but you cannot play the Game itself.

- Supported Subtitle Formats

| Name | File extension | Format |
|------------------------|----------------|--------------|
| MPEG-4 time-based text | .txt | XML |
| SAMI | .smi | HTML |
| SubRip | .srt | string-based |
| SubViewer | .sub | string-based |
| Micro DVD | .sub or .txt | string-based |

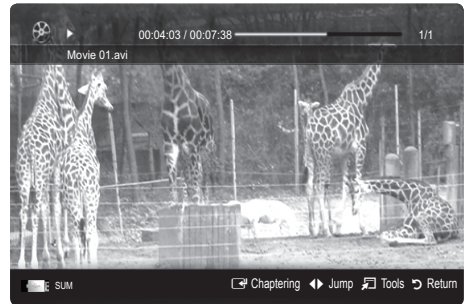

- Supported Video Formats

| File Extension | Container | Video Codec | Resolution | Frame rate (fps) | Bit rate (Mbps) | Audio Codec |
|-----------------------|------------|-----------------------------|------------|------------------|-----------------|--|
| *.avi *.mkv | AVI MKV | Divx 3.11 / 4.x / 5.1 / 6.0 | 1920x1080 | 6 ~ 30 | 8 | MP3 / AC3 / LPCM / ADPCM / DTS Core |
| | | XviD | 1920x1080 | 6 ~ 30 | 8 | |
| | | H.264 BP / MP / HP | 1920x1080 | 6 ~ 30 | 25 | |
| | | MPEG4 SP / ASP | 1920x1080 | 6 ~ 30 | 8 | |
| | | Motion JPEG | 800x600 | 6 ~ 30 | 8 | |
| *.asf | ASF | Divx 3.11 / 4.x / 5.1 / 6.0 | 1920x1080 | 6 ~ 30 | 8 | MP3 / AC3 / LPCM / ADPCM / WMA |
| | | XviD | 1920x1080 | 6 ~ 30 | 8 | |
| | | H.264 BP / MP / HP | 1920x1080 | 6 ~ 30 | 25 | |
| | | MPEG4 SP / ASP | 1920x1080 | 6 ~ 30 | 8 | |
| | | Motion JPEG | 800x600 | 6 ~ 30 | 8 | |
| *.wmv | ASF | Window Media Video v9 | 1920x1080 | 6 ~ 30 | 25 | WMA |
| *.mp4 | MP4 | H.264 BP / MP / HP | 1920x1080 | 6 ~ 30 | 25 | MP3 / ADPCM / AAC |
| | | MPEG4 SP / ASP | 1920x1080 | 6 ~ 30 | 8 | |
| | | XVID | 1920x1080 | 6 ~ 30 | 8 | |
| *.3gp | 3GPP | H.264 BP / MP / HP | 1920x1080 | 6 ~ 30 | 25 | ADPCM / AAC / HE-AAC |
| | | MPEG4 SP / ASP | 1920x1080 | 6 ~ 30 | 8 | |
| *.vro *.vob | VRO VOB | MPEG1 | 1920x1080 | 24 / 25 / 30 | 30 | AC3 / MPEG / LPCM |
| | | MPEG2 | 1920x1080 | 24 / 25 / 30 | 30 | |
| *.mpg *.mpeg | PS | MPEG1 | 1920x1080 | 24 / 25 / 30 | 30 | AC3 / MPEG / LPCM / AAC |
| | | MPEG2 | 1920x1080 | 24 / 25 / 30 | 30 | |
| | | H.264 | 1920x1080 | 6 ~ 30 | 25 | |
| *.ts *.tp *.trp | TS | MPEG2 | 1920x1080 | 24 / 25 / 30 | 30 | AC3 / AAC / MP3 / DD+ / HE-AAC |
| | | H.264 | 1920x1080 | 6 ~ 30 | 25 | |
| | | VC1 | 1920x1080 | 6 ~ 30 | 25 | |

Other Restrictions

NOTE

- If there are problems with the contents of a codec, the codec will not be supported.
- If the information for a Container is incorrect and the file is in error, the Container will not be able to play correctly.
- Sound or video may not work if the contents have a standard bitrate/frame rate above the compatible Frame/sec listed in the table above.
- If the Index Table is in error, the Seek (Jump) function is not supported.

| Video Decoder | Audio Decoder |
|---|---|
| <ul style="list-style-type: none"> • Supports up to H.264, Level 4.1 • H.264 FMO / ASO / RS, VC1 SP / MP / AP L4 and AVCHD are not supported. • XVID, MPEG4 SP, ASP : <ul style="list-style-type: none"> – Below 1280 x 720: 60 frame max – Above 1280 x 720: 30 frame max • GMC 2 over is not supported. • H.263 is not supported. • Only Samsung Techwin MJPEG is supported. | <ul style="list-style-type: none"> • Supports up to WMA 7, 8, 9, STD • WMA 9 PRO does not support 2 channel excess multi channel or lossless audio. • WMA sampling rate 22050Hz mono is not supported. |

Playing recorded TV or movie file continuously (Resume Play)

If you exit the playing Recorded TV or Videos function, it can be played later from the point where it was stopped.

If you press the **ENTER** button (**Chaptering**) during playing the file, you can explore scene divided into 5 chapters you want.

1. Select the movie file you want to play continuously by pressing the ◀ or ▶ button to select it from the file list section.
2. Press the ▶ (Play) / **ENTER** button.
3. Select **Play Continuously** (Resume Play) by pressing the Blue button. The Movie will begin to play from where it was stopped.

The Blue button is available when resuming play.

If the **Cont. movie play help** function is set to **On** in the **Settings** menu, a pop-up message will appear when you resume play a movie file.

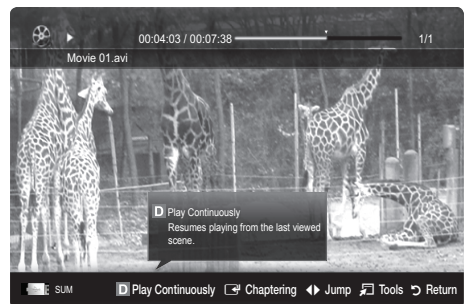

Music

Playing Music

1. Press the ◀ or ▶ button to select **Music**, then press the **ENTER** button in the **Media Play** menu.
2. Press the ◀/▶/▲/▼ button to select the desired file in the file list.
3. Press the **ENTER** button or ▶ (Play) button.
 - During playing the music, you can search using the ◀ and ▶ button.
 - ◀◀ (REW) and ▶▶ (FF) buttons do not function during play.

Only displays the files with MP3 and PCM file extension. Other file extensions are not displayed, even if they are saved on the same USB device.

If the sound is strange when playing MP3 files, adjust the **Equalizer** in the **Sound** menu. (An over-modulated MP3 file may cause a sound problem.)



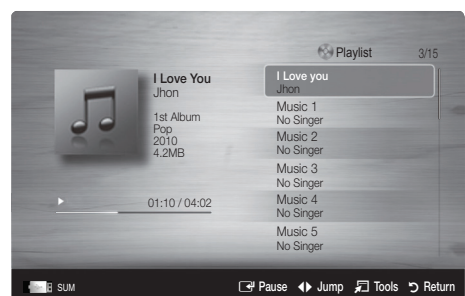

You can create **My Playlist** selecting the desired music in the file, and can play **My Playlist**.





Advanced Features

Photos

Viewing a Photo (or Slide Show)

1. Press the ◀ or ▶ button to select **Photos**, then press the ENTER  button in the **Media Play** menu.
2. Press the ◀/▶/▲/▼ button to select the desired file in the file list.
3. Press the ENTER  button or  (Play) button.
 - While a photo list is displayed, press the  (Play) / ENTER  button on the remote control to start slide show.
 - All files in the file list section will be displayed in the slide show.
 - During the slide show, files are displayed in order from currently being shown.



-  Music files can be automatically played during the Slide Show if the **Background Music** is set to **On**.
-  The **BGM Mode** cannot be changed until the BGM has finished loading.

Playing the Multiple Files

Playing the selected recorded TV/video/music/photo files

1. Press the Yellow button in the file list to select the desired file.
2. Repeat the above operation to select multiple files.

NOTE

- The ✓ mark appears to the left of the selected files.
- To cancel a selection, press the Yellow button again.
- To deselect all selected files, press the **TOOLS** button and select **Deselect All**.

3. Press the **TOOLS** button and select **Play Selected Contents**.













Playing the recorded TV/video/music/photo file group

1. While a file list is displayed, move to the any file in desired group.
2. Press the **TOOLS** button and select **Play Current Group**.

Media Play Additional Function

Sorting the file list

Press the Blue button in the file list to sort the files.

| Category | Operations | Recorded TV | Videos | Music | Photos |
|--|---|-------------|--------|-------|--------|
|  Basic View | It shows whole folder. You can view the photo by selecting the folder. | | ▼ | ▼ | ▼ |
|  Title | It sorts and displays the file title in Symbol/Number/Alphabet/Special order. | ▼ | ▼ | ▼ | ▼ |
|  Preference | It sorts and displays the file by preference. You can change the file preference in the file list section using the Green button. | ▼ | ▼ | ▼ | ▼ |
|  Latest Date | It sorts and shows files by latest date. | ▼ | ▼ | | ▼ |
|  Earliest Date | It sorts and shows files by earliest date. | ▼ | ▼ | | ▼ |
|  Artist | It sorts the music file by artist in alphabetical. | | | ▼ | |
|  Album | It sorts the music file by album in alphabetical order. | | | ▼ | |
|  Genre | It sorts music files by the genre. | | | ▼ | |
|  Mood | It sorts music files by the mood. You can change the music mood information. | | | ▼ | |
|  Monthly | It sorts and shows photo files by month. It sorts only by month (from January to December) regardless of year. | ▼ | | | ▼ |
|  Channel | It sorts the recorded files by channel name. | ▼ | | | |

Recorded TV/Videos/Music/Photos Play Option menu

During playing a file, press the **TOOLS** button.

| Category | Operations | Recorded TV | Videos | Music | Photos |
|---|---|-------------|--------|-------|--------|
| Title | You can move the other file directly. | ▼ | ▼ | | |
| Repeat Mode | You can play recorded TV, movie and music files repeatedly. | ▼ | ▼ | ▼ | |
| Picture Size | You can adjust the picture size for preference. | ▼ | ▼ | | |
| Picture Setting | You can adjust the picture setting (p. 15~20). | ▼ | ▼ | | ▼ |
| Sound Setting | You can adjust the sound setting (p. 20, 21). | ▼ | ▼ | ▼ | ▼ |
| Subtitle Setting | You can play the video file with Subtitle. This function only works if the subtitles are the same file name as the video file. | ▼ | ▼ | | |
| Audio Description | You can adjust the audio description (p. 21). | ▼ | | | |
| Audio | You can enjoy video in one of supported languages as required. The function is only enabled when stream-type files which support multiple audio formats are played. | ▼ | ▼ | | |
| Stop Slide Show / Start Slide Show | You can start or stop a slide show. | | | | ▼ |
| Slide Show Speed | You can select the slide show speed during the slide show. | | | | ▼ |
| Slide Show Effect | You can set variously the slide show effect. | | | | ▼ |
| Background Music | You can set and select background music when watching a slide show. | | | | ▼ |
| Zoom | You can zoom into images in full screen mode. | | | | ▼ |
| Rotate | You can rotate images in full screen mode. | | | | ▼ |
| Home Background | You can move the file to the Media Play desktop. | | | | ▼ |
| Information | You can see detailed information about the played file. | ▼ | ▼ | ▼ | ▼ |

Settings

Using the Setup Menu

- **Background Setting:** Select to display the background you want.
- **Cont. movie play help (Resume Play) (On / Off):** Select to display the help pop-up message for continuous movie playback.
- **Get the DivX® VOD registration code:** Shows the registration code authorized for the TV. If you connect to the DivX web site and register the registration code with a personal account, you can download VOD registration file. If you play the VOD registration using Media Play, the registration is completed.
 For more information on DivX® VOD, visit "www.DivX.com."
- **Get the DivX® VOD deactivation code:** When DivX® VOD is not registered, the registration deactivation code is displayed. If you execute this function when DivX® VOD is registered, the current DivX® VOD registration is deactivated.
- **Information:** Select to view information about the connected device.

Advanced Features

Anynet+

What is Anynet+? **TOOLS**

Anynet+ is a function that enables you to control all connected Samsung devices that support Anynet+ with your Samsung TV's remote. The Anynet+ system can be used only with Samsung devices that have the Anynet+ feature. To be sure your Samsung device has this feature, check if there is an Anynet+ logo on it.

To connect to Home Theatre

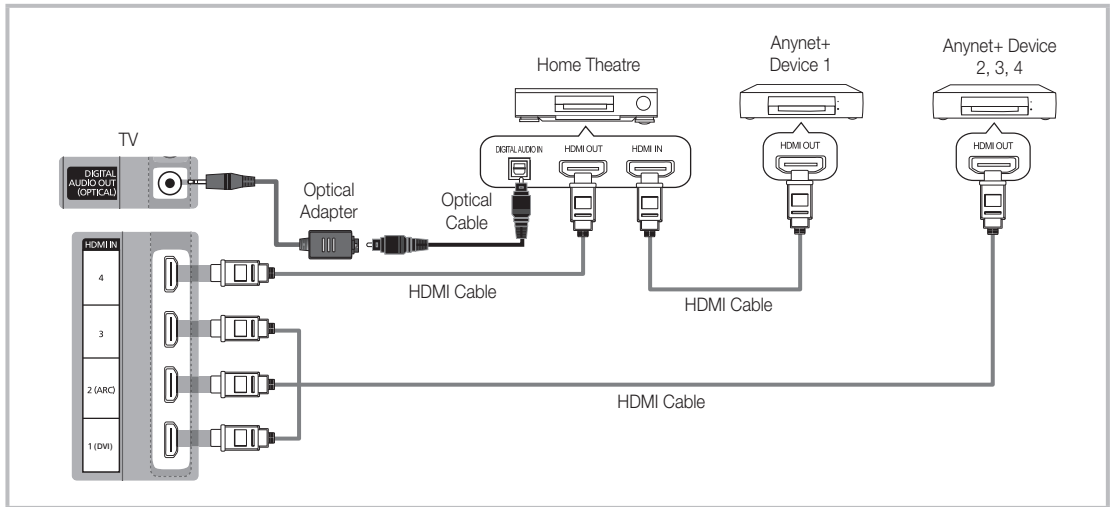

1. Connect the **HDMI IN (1 (DVI), 2 (ARC), 3 or 4)** jack on the TV and the **HDMI OUT** jack of the corresponding Anynet+ device using an HDMI cable.
2. Connect the **HDMI IN** jack of the home theatre and the **HDMI OUT** jack of the corresponding Anynet+ device using an HDMI cable.

NOTE

- Connect the Optical cable between the **DIGITAL AUDIO OUT (OPTICAL)** jack on your TV and the Digital Audio Input on the Home Theatre.
- The ARC function enables digital output of sound using the **HDMI IN 2 (ARC)** port and can only be operated when the TV is connected to an audio receiver that supports the ARC function.
- When following the connection above, the Optical jack only outputs 2 channel audio. You will only hear sound from the Home Theatre's Front, Left and Right speakers and the subwoofer. If you want to hear 5.1 channel audio, connect the **DIGITAL AUDIO OUT (OPTICAL)** jack on the DVD / satellite box (i.e. Anynet Device 1 or 2) directly to the Amplifier or Home Theatre, not the TV.
- Connect only one Home Theatre.
- You can connect an Anynet+ device using the HDMI cable. Some HDMI cables may not support Anynet+ functions.
- Anynet+ works when the AV device supporting Anynet+ is in the standby or on status.
- Anynet+ supports up to 12 AV devices in total. Note that you can connect up to 3 devices of the same type.

Anynet+ Menu

The Anynet+ menu changes depending on the type and status of the Anynet+ devices connected to the TV.

| Anynet+ Menu | Description |
|------------------------------------|--|
| View TV | Changes Anynet+ mode to TV broadcast mode. |
| Device List | Shows the Anynet+ device list. |
| (device_name) MENU | Shows the connected device menus. E.g. If a DVD recorder is connected, the disc menu of the DVD recorder will appear. |
| (device_name) INFO | Shows the play menu of the connected device. E.g. If a DVD recorder is connected, the play menu of the DVD recorder will appear. |
| Recording: (*recorder) | Starts recording immediately using the recorder. (This is only available for devices that support the recording function.) |
| Stop Recording: (*recorder) | Stops recording. |
| Receiver | Sound is played through the receiver. |

If more than one recording device is connected, they are displayed as (*recorder) and if only one recording device is connected, it will be represented as (*device_name).

Setting Up Anynet+

■ Setup

Anynet+ (HDMI-CEC) (Off / On): To use the Anynet+ Function, **Anynet+ (HDMI-CEC)** must be set to **On**.



 When the **Anynet+ (HDMI-CEC)** function is disabled, all the Anynet+ related operations are deactivated.

Auto Turn Off (No / Yes): Setting an Anynet+ Device to turn off automatically when the TV is turned off.

 The active source on the TV must be set to TV to use the Anynet+ function.

 Even if an external device is still recording, it may turn off.

Switching between Anynet+ Devices



1. Anynet+ devices connected to the TV are listed.
 -  If you cannot find a device you want, press the red button to refresh the list.
2. Select a device and press the **ENTER**  button. You can switch to the selected device.
 -  Only when you set **Anynet+ (HDMI-CEC)** to **On** in the **Application** menu, the **Device List** menu appears.
 - Switching to the selected device may take up to 2 minutes. You cannot cancel the operation during the switching operation.
 - If you have selected external input mode by pressing the **SOURCE** button, you cannot use the Anynet+ function. Make sure to switch to an Anynet+ device by using the **Device List**.

Advanced Features





Recording

You can make a recording of a TV programme using a Samsung recorder.

1. Select **Recording**.

-  When there are more than two recording devices
 - When multiple recording devices are connected, the recording devices are listed. Select one recording device in the **Device List**.
-  When the recording device is not displayed, select **Device List** and press the Red button to search devices.

2. Press the **EXIT** button to exit.



-  You can record the source streams by selecting **Recording**: (device_name).
-  Pressing the  (REC) button will record whatever you are currently watching. If you are watching video from another device, the video from the device is recorded.
-  Before recording, check whether the antenna jack is properly connected to the recording device. To properly connect an antenna to a recording device, refer to the recording device's users manual.

Listening through a Receiver

You can listen to sound through a receiver (i.e Home Theatre) instead of the **TV Speaker**.

1. Select **Receiver** and set to **On**.

2. Press the **EXIT** button to exit.

-  If your receiver supports audio only, it may not appear in the device list.
-  The receiver will work when you have properly connected the optical in jack of the receiver to the **DIGITAL AUDIO OUT (OPTICAL)** jack of the TV.
-  When the receiver (i.e Home Theatre) is set to On, you can hear sound output from the TV's Optical jack. When the TV is displaying a DTV (aerial) signal, the TV will send out 5.1 channel sound to the receiver. When the source is a digital component such as a DVD and is connected to the TV via HDMI, only 2 channel sound will be heard from the receiver.

NOTE



- You can only control Anynet+ devices using the TV remote control, not the buttons on the TV.
- The TV remote control may not work under certain conditions. If this occurs, reselect the Anynet+ device.
- The Anynet+ functions do not operate with other manufacturers' products.

Using the ARC function

You can listen to sound through a receiver connected HDMI cable without the need for a separate optical cable.

1. Select **Receiver** and set to **On**.

2. Press the **EXIT** button to exit.

-  To use the ARC function, a receiver which supports the HDMI-CEC and ARC features must be connected to the **HDMI IN 2(ARC)** port.
-  To disable the ARC function, set the **Receiver** to **Off**. Even if the TV transmits the ARC signal continuously, the receiver will be blocked from receiving the signal.

Troubleshooting for Anynet+

| Problem | Possible Solution |
|--|---|
| Anynet+ does not work. | <ul style="list-style-type: none"> • Check if the device is an Anynet+ device. The Anynet+ system supports Anynet+ devices only. • Connect only one receiver (home theatre). • Check if the Anynet+ device power cord is properly connected. • Check the Anynet+ device's Video/Audio/HDMI Cable connections. • Check whether Anynet+ (HDMI-CEC) is set to On in the Anynet+ setup menu. • Check whether the TV remote control is in TV mode. • Check whether it is Anynet+ exclusive remote control. • Anynet+ doesn't work in certain situations. (Searching channels, operating Media Play or Plug & Play (Initial setup), etc.) • When connecting or removing the HDMI cable, please make sure to search devices again or turn your TV off and on again. • Check if the Anynet+ Function of Anynet+ device is set on. |
| I want to start Anynet+. | <ul style="list-style-type: none"> • Check if the Anynet+ device is properly connected to the TV and check if the Anynet+ (HDMI-CEC) is set to On in the Anynet+ Setup menu. • Press the TOOLS button to display the Anynet+ menu and select a menu you want. |
| I want to exit Anynet+. | <ul style="list-style-type: none"> • Select View TV in the Anynet+ menu. • Press the SOURCE button on the TV remote control and select a device other than Anynet+ devices. • Press P ▼/▲, and PRE-CH to change the TV mode. (Note that the channel button operates only when a tuner-embedded Anynet+ device is not connected.) |
| The message "Connecting to Anynet+ device..." appears on the screen. | <ul style="list-style-type: none"> • You cannot use the remote control when you are configuring Anynet+ or switching to a view mode. • Use the remote control when the Anynet+ setting or switching to view mode is complete. |
| The Anynet+ device does not play. | <ul style="list-style-type: none"> • You cannot use the play function when Plug & Play (Initial setup) is in progress. |
| The connected device is not displayed. | <ul style="list-style-type: none"> • Check whether or not the device supports Anynet+ functions. • Check whether or not the HDMI Cable is properly connected. • Check whether Anynet+ (HDMI-CEC) is set to On in the Anynet+ setup menu. • Search Anynet+ devices again. • You can connect an Anynet+ device using the HDMI Cable only. Some HDMI cables may not support Anynet+ functions. • If it is terminated by an abnormal situation such as disconnecting the HDMI cable or power cord or a power failure, please repeat the device scan. |
| The TV programme cannot be recorded. | <ul style="list-style-type: none"> • Check whether the antenna jack on the recording device is properly connected. |
| The TV sound is not output through the receiver. | <ul style="list-style-type: none"> • Connect the optical cable between TV and the receiver. • The ARC function enables digital output of sound using the HDMI IN 2(ARC) port and can only be operated when the TV is connected to an audio receiver that supports the ARC function. |

Advanced Features

Getting Started with Internet@TV



Internet@TV brings useful and entertaining contents and services directly from the web to your TV.



NOTE

- Configure the network settings before using **Internet@TV**. For more information, refer to “Network Connection” (p. 27).
- Unsupported fonts within the provider’s content will not display normally.
- Slow responses and/or interruptions may occur, depending on your network conditions.
- English may be only supported in application service depending on region.
- This feature is not available in some locations.
- If you experience a problem using a widget, please contact the content provider.
- According to circumstances of the contents provider, an application’s updates or the application itself may be discontinued.
- Depending on your country’s regulations, some widgets may have limited service or not be supported.

Screen Display

TV Screen:
Displays the current channel.

Information:
Displays notices, new applications, and advertisements brought to you by Samsung product introductions.

Application service:
You can experience various service by provided samsung.

Recommended Applications:
Displays the recommended service by Samsung. You are not able to add or delete a service in this list.

Downloaded Applications:
Displays the downloaded applications through the Samsung Apps.

Internet@TV Settings:
Edit and configure applications and Internet@TV settings.

Controls:

- **Red (Login):** To log in to Internet@TV.
- **Green (Mark as Favourite):** To mark the applications as a favourite.
- **Blue (Sort by):** To sort the applications.
- **Return:** To return to the previous menu.

The colour buttons may work differently depending on the application.

Account Login

For a widget with multiple account, use ◀ and ▶ to access the different account.

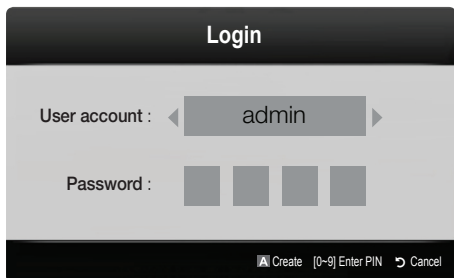

✎ For a more enjoyable widget experience, register and log in to your account.

✎ For instructions on creating an account, refer to **Settings** → **Internet@TV ID** → **Create**.

1. Press the Red button in **Internet@TV** home page.
2. Select desired **User account**, then press the ENTER button.
 - ✎ If you want create account, press Red button; then create account OSD window appear.
3. Enter the **Password**.
 - ✎ When login succeeds, **User account** will be displayed on the screen.

Setting up Internet@TV

Settings

Create IDs and configure Internet@TV settings from this screen. Highlight Settings using ▲ and ▼ buttons and press the ENTER button.

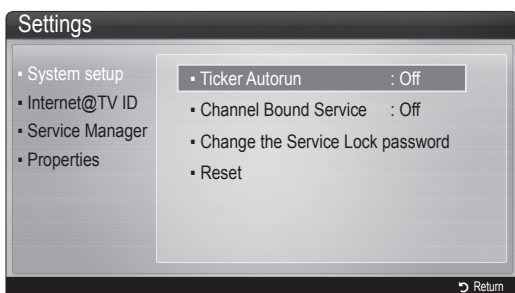

System Setup

Ticker Autorun (Off / On): Enable/disable ticker autorun upon powering on the TV.

✎ The **Ticker** application provides useful News, Weather, and Stock Market information. The **Ticker** application on **Internet@TV** must be downloaded to use this feature.

✎ Depending on your country, the **Ticker** application may have different service or not be supported.

Channel Bound Service (Off / On): Some channels support widgets as an Internet data service, allowing you to access the Internet service while watching TV.

✎ Only available if supported by the broadcaster.

Change the Service Lock password

✎ The default password set is "0-0-0-0."

✎ If you forget the password, press the following sequence of remote control buttons to reset the password to "0-0-0-0": **POWER** (off) → **MUTE** → 8 → 2 → 4 → **POWER** (on).

Reset: Resets Internet@TV settings to factory default settings.

Internet@TV ID

You can use this menu when creating, deleting the account. You can control your account including contents site's account information.

✎ Account is only for internet@TV.

Create: Create an account and link it with desired service widgets.

NOTE

- Account will be made less than 10.
- Maximum number of characters is 8.

Manager

- **Service Site:** Register login information for service sites.
- **Change Password:** Change account password.
- **Delete:** Delete the account.

■ **Service Manager:** Delete and lock widgets installed to Internet@TV.

Lock: Lock the widget.

✎ Accessing a locked widget requires the password.

Delete: Delete the widget.

■ **Properties:** Display information about Internet@TV. Use the **Check the speed of your internet connection** option to test your network connection.

Advanced Features

Using the Internet@TV service

Samsung Apps

Samsung Apps is a store for downloading applications to be used on Samsung TV/AV equipment.

Users can enjoy a variety of contents like videos, music, photos, games, useful information etc. using the downloaded applications.

Additional applications will be available hereafter.

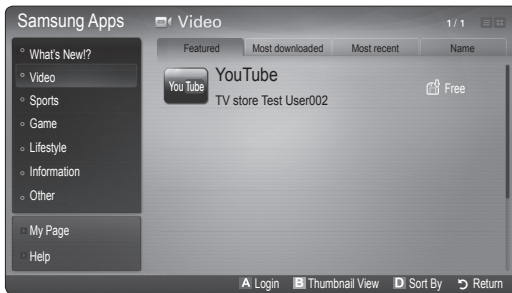

Using the colour buttons with the **Samsung Apps**.

- **Red (Login):** To log in to the internet service.
- **Green (Thumbnail View):** To change the view mode.
- **Blue (Sort By):** To sort the widgets by **Featured**, **Most downloaded**, **Most recent** or **Name**.
- **Return:** Moves to previous menu.

Skype

Skype created a little piece of software that makes communicating with people around the world easy and fun. With Skype you can say hello or share a laugh with anyone, anywhere. And if both of you are on Skype, it's free. Communicate with people around the world!

For more information, download the Skype user's manual from "www.samsung.com."

Using the Samsung Apps by category

The following categories are available:

- **What's New?:** Displays newly registered applications.
- **Video:** Displays various video media such as movies, TV shows and short length videos.
- **Sports:** Displays various sports media such as match information, images and short length video.
- **Game:** Displays various games such as sudoku and chess.
- **Lifestyle:** Includes various lifestyle media services such as music, personal photo management tools and social networking such as Facebook and Twitter.
- **Information:** Includes various information services such as news, stocks and weather.
- **Other:** Includes other miscellaneous services.
- **My Page:** **My Page** offers information about already installed applications on the TV like detailed information, download contents etc. It can allow delete or lock the applications.
- **Help:** If you have questions about Internet@TV, check this section first.



Troubleshooting for internet@TV

| Problem | Possible Solution |
|---|---|
| Some application contents only have English. How can I change the language? | Application content language may be different from application user interface language. It depends on service provider. |
| Some application services do not work. | Check with that service provider. Refer to help website for application service provider information. |
| When a network error occurred, I can't use other menus except setting menu. | If network connection doesn't work, your service might be limited. Because all of function except setting menu are needed to connect internet. |

Help Website

 Approaching step may be changed later on.

 It can be different links for special countries.

| Country | Website |
|--------------|---|
| UAE | www.samsung.com → Consumer → television → Internet@TV |
| Australia | www.samsung.com → Consumer → television → Internet@TV |
| China | www.samsung.com → 个人消费产品 → 电视产品 → Internet@TV |
| India | www.samsung.com → consumer products → television → Internet@TV |
| Indonesia | www.samsung.com → Produk → television → Internet@TV |
| Japan | www.samsung.com → 製品情報 → 液晶ディスプレイ → Internet@TV |
| Malaysia | www.samsung.com → Consumer → television → Internet@TV |
| NewZealand | www.samsung.com → Consumer → television → Internet@TV |
| Philippines | www.samsung.com → Consumer → television → Internet@TV |
| Singapore | www.samsung.com → Consumer → television → Internet@TV |
| Taiwan | www.samsung.com → 个人消费产品 → 电视 → Internet@TV |
| Thailand | www.samsung.com → ผลิตภัณฑ์ → โทรทัศน์ → Internet@TV |
| Vietnam | www.samsung.com → sản phẩm nghe nhìn → máy thu hình → Internet@TV |
| South Africa | www.samsung.com → Consumer → television → Internet@TV |

Advanced Features

AllShare

About AllShare

AllShare connects your TV, mobile phones and other devices which are compatible through a network. On your TV, you can view call arrivals, SMS messages and schedules set on your mobile phones. In addition, you can play media contents including videos, photos and music saved on your mobile phones or the other devices (such as your PC) by controlling them on the TV via the network. Additionally, you can use your TV as a monitor for your mobile when browsing a web page.

For more information, visit "www.samsung.com" or contact the Samsung call centre. Mobile devices may need additional software installation. For details, refer to each device's user's guide.

Setting Up AllShare

Setup

- **Message (On / Off):** Enables or disables the message function (for call arrivals, SMS messages and schedules set on your mobile phones).
- **Media (On / Off):** Enables or disables the media function. When the media function is on, it plays videos, photos and music from a mobile phone or other device that supports **AllShare**.
- **ScreenShare (On / Off):** Enables or disables the ScreenShare function for using mobile phone as a remote control.
- **TV name:** Sets the TV name so you can find it easily on a mobile device.

If you select **User Input**, you can type on the TV using the OSK (On Screen Keyboard).

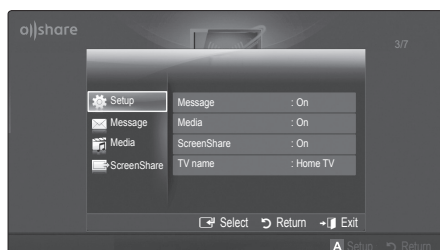

Message / Media / ScreenShare

Shows a list of mobile phones or connected devices which have been set up with this TV for using the **Message**, **Media**, or **ScreenShare** function.

The **Media** function is available in all mobile devices which support **AllShare**.

■ **Allowed / Denied:** Allows/Blocks the mobile phone.

■ **Delete:** Deletes the mobile phone from the list.

This function only deletes the name of the mobile from the list. If the deleted mobile device is turned on or tries to connect to the TV, it may appear on the list again.

Using the Message Function

Using this function, you view call arrivals, SMS messages and schedules set on the mobile phone through the alarm window while watching TV.

NOTE

- To disable the alarm window, set **Message** to **Off** in **Setup** of **AllShare**.
- If **OK** is selected, or if **OK** is not selected after the message has appeared three times, the message will be deleted. The message is not deleted from the mobile phone.
- The alarm window can be displayed while using some applications such as **Media Play** etc. To view the contents of a message, switch to TV viewing mode.
- When a message from an unknown mobile phone is displayed, select the mobile phone on the message menu in **AllShare** and select **Denied** to block the phone.

Message View

If a new SMS message arrives while you are watching TV, the alarm window appears. If you click the OK button, the contents of the message are displayed.

You can configure the viewing settings for SMS messages on your mobile phones. For the procedures, refer to the mobile phone manual.



Some types of characters may be displayed as blank or broken characters.

Call Arrival Alarm

If a call arrives while you are watching TV, the alarm window appears.

Schedule Alarm

While you are watching TV, the alarm window appears to display the registered event.

-  You can configure viewing settings for schedule contents on your mobile phones. For the procedures, refer to the mobile phone manual.
-  Some special characters may be displayed as blank or broken characters.

Using the Media Function

An alarm window appears informing the user that the media contents (videos, photos, music) sent from a mobile phone will be displayed on your TV. The contents are played automatically 3 seconds after the alarm window appears. If you press the **RETURN** or **EXIT** button when the alarm window appears, the media contents are not played.

NOTE

- If the media function executes for the first time, the warning popup window appears. Press the **ENTER**  button to select Allow, then you can use Media function on that device.

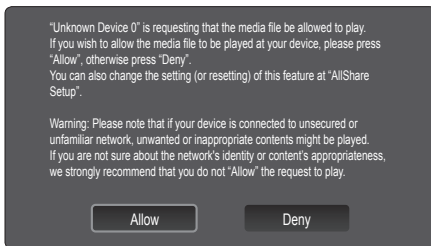

- To turn off the media contents transmission from the mobile phone, set **Media** to **Off** in the **AllShare** setup.
- Contents may not be played on your TV depending on their resolution and format.
- The **ENTER**  and **◀ / ▶** buttons may not work depending on the type of media content.
- Using the mobile device, you can control the media playing. For details, refer to each mobile's user's guide.
- When you want to play media contents from your PC, select the PC icon on the main display of **AllShare**. Then the TV's **Media Play** menu automatically changes. For more detail information, refer to "Media Play" (p. 34).

Using ScreenShare Function

ScreenShare displays the same web page as provide in mobile. Using ScreenShare, you can open the various contents saved in a mobile phone. For example, the image below displays an access page for contents from a mobile. You can read the mobile's various files and view the phone book and calendar on the TV. Also, in phone book, you can make a call to other person, or can send to SMS.

NOTE

- In Samsung mobile, ScreenShare must be installed and the supporting application must be executed; then you can use the ScreenShare function.
- Available buttons on your remote control may vary for each page.
- **Doc Viewer** can read files in doc format, but cannot modify them.
- The screen display may differ depending on the connected device.



Using your Samsung phone to control your TV Simply

Before you can use this feature, you must connect to a Samsung mobile phone that supports ScreenShare functions. When operating the TV with your mobile phone, only the **POWER**, **-** , **+**  and **MUTE** buttons are supported.







-  Even if you keep pressing down on a control button (channel or volume) on the mobile phone, the value will only go up or down by one unit.

Other Information





Analogue Channel Teletext Feature

The index page of the Teletext service gives you information on how to use the service. For Teletext information to be displayed correctly, channel reception must be stable. Otherwise, information may be missing or some pages may not be displayed.

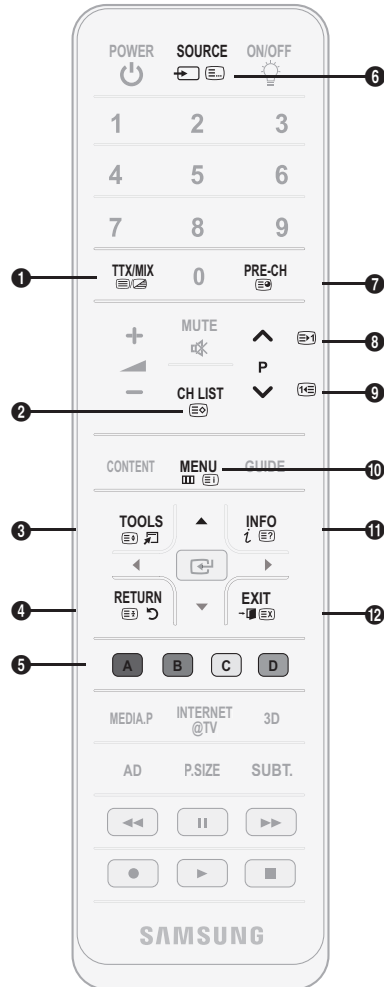
 You can change Teletext pages by pressing the numeric buttons on the remote control.

- 1  (Teletext on/mix): Activates the Teletext mode for the current channel. Press it twice to overlap the Teletext display onto the current broadcasting screen.
- 2  (store): Stores the Teletext pages.
- 3  (size): Displays the teletext on the upper half of the screen in double-size. To move the text to the lower half of the screen, press it again. For normal display, press it once again.
- 4  (hold): Holds the display at the current page, in the case that there are several secondary pages that follow automatically. To undo, press it again.
- 5 Colour buttons (red, green, yellow, blue): If the FASTEXT system is used by the broadcasting company, the different topics on a Teletext page are colour-coded and can be selected by pressing the coloured buttons. Press the colour corresponding to the topic of your choice. A new colour-coded page is displayed. Items can be selected in the same way. To display the previous or next page, press the corresponding coloured button.
- 6  (mode): Selects the Teletext mode (LIST/ FLOF). If pressed during LIST mode, switches the mode to List save mode. In List save mode, you can save a Teletext page into a list using the  (store) button.
- 7  (sub-page): Displays the available sub-page.



- 8  (page up): Displays the next Teletext page.
- 9  (page down): Displays the previous Teletext page.
- 10  (index): Displays the index (contents) page at any time while you are viewing Teletext.
- 11  (reveal): Displays the hidden text (answers to quiz games, for example). To display the normal screen, press it again.
- 12  (cancel): Shrinks the Teletext display to overlap with the current broadcast.

Typical Teletext page

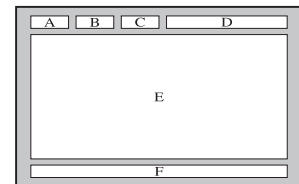

| Part | Contents |
|------|--|
| A | Selected page number. |
| B | Broadcasting channel identity. |
| C | Current page number or search indications. |
| D | Date and time. |
| E | Text. |
| F | Status information. FASTEXT information. |

Assembling the Cables

Stand Type

Enclose the cables in the Cable Tie so that the cables are not visible through the transparent stand.

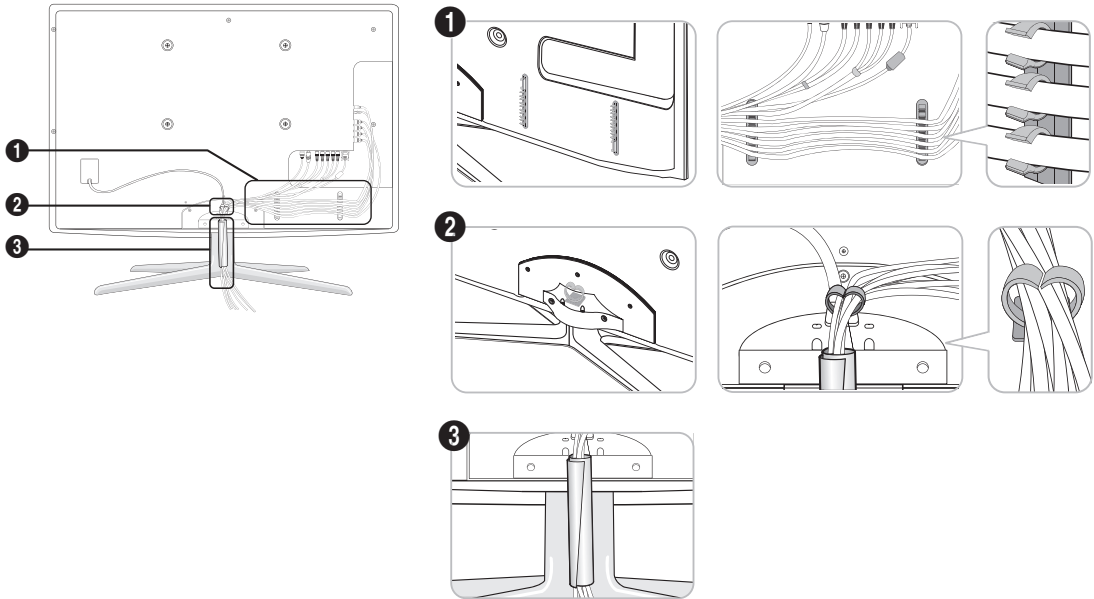

Wall-Mount Type

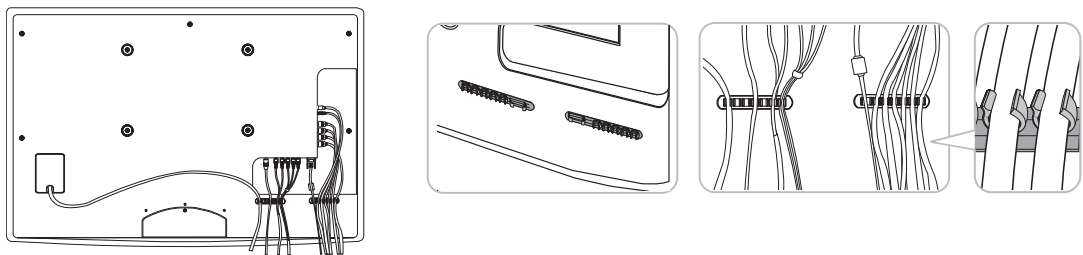

 Do not pull the cables too hard when arranging them. This may cause damage to the product's connection terminals.

Installing the Wall Mount

Assembling the Blanking Bracket

When installing the TV onto a wall, attach the Blanking Bracket as shown.

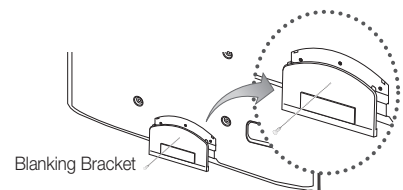

Other Information

Preparing before installing Wall-Mount

To install a wall-mount from another manufacturer, use the Holder-Ring.

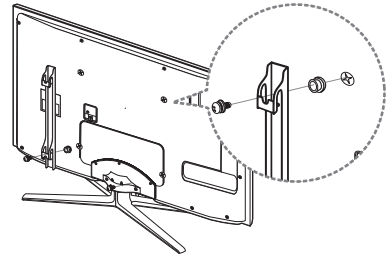

To install a wall-mount, use the Holder-Ring ❶.

Installing the Wall Mount Kit

The wall mount kit (sold separately) allows you to mount the TV on the wall.

For detailed information on installing the wall mount, see the instructions provided with the wall mount. Contact a technician for assistance when installing the wall mount bracket.

Samsung Electronics is not responsible for any damage to the product or injury to yourself or others if you elect to install the TV on your own.

Wall Mount Kit Specifications (VESA)

The wall mount kit is not supplied, but sold separately.

Install your wall mount on a solid wall perpendicular to the floor. When attaching to other building materials, please contact your nearest dealer. If installed on a ceiling or slanted wall, it may fall and result in severe personal injury.

NOTE

- Standard dimensions for wall mount kits are shown in the table below.
- When purchasing our wall mount kit, a detailed installation manual and all parts necessary for assembly are provided.
- Do not use screws that do not comply with the VESA standard screw specifications.
- Do not use screws that are longer than the standard dimension or do not comply with the VESA standard screw specifications. Screws that are too long may cause damage to the inside of the TV set.
- For wall mounts that do not comply with the VESA standard screw specifications, the length of the screws may differ depending on the wall mount specifications.
- Do not fasten the screws that are too strongly; this may damage the product or cause the product to fall, leading to personal injury. Samsung is not liable for these kinds of accidents.
- Samsung is not liable for product damage or personal injury when a non-VESA or non-specified wall mount is used or the consumer fails to follow the product installation instructions.
- Do not mount the TV at more than a 15 degree tilt.

| Product Family | inches | VESA Spec. (A * B) | Standard Screw | Quantity |
|------------------------|--------|--------------------|----------------|----------|
| LED-TV [Ultra-Slim] | 19~22 | 75 X 75 | M4 | 4 |
| | 23~29 | 200 X 100 | M8 | |
| | 32~37 | 200 X 200 | | |
| | 40~55 | 400 X 400 | | |
| | 56~65 | 600 X 400 | | |

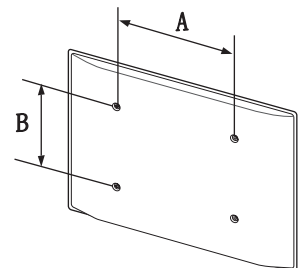

Do not install your Wall Mount Kit while your TV is turned on. It may result in personal injury due to electric shock.

Anti-theft Kensington Lock

The Kensington Lock is not supplied by Samsung. It is a device used to physically fix the system when using it in a public place. The appearance and locking method may differ from the illustration depending on the manufacturer. Refer to the manual provided with the Kensington Lock for additional information on proper use.

 Please find a “K” icon on the rear of the TV. A Kensington slot is beside the “K” icon.

1. Insert the locking device into the Kensington slot **1** on the LED TV and turn it in the as shown **2**.
2. Connect the Kensington Lock cable **3**.
3. Fix the Kensington Lock to a desk or a heavy stationary object.

 The locking device has to be purchased separately.

 The location of the Kensington slot may be different depending on the TV model.

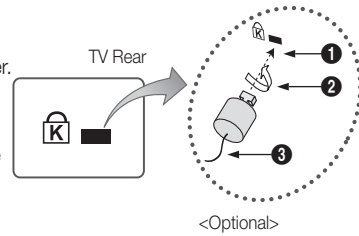





Securing the TV to the wall



Caution: Pulling, pushing, or climbing onto the TV may cause the TV to fall. In particular, ensure that your children do not hang over or destabilize the TV; doing so may cause the TV to tip over, resulting in serious injuries or death. Follow all safety precautions provided in the included Safety Flyer. For added stability and safety, install the anti-fall device as follows.

To Avoid the TV from Falling

1. Put the screws into the clamps and firmly fasten them onto the wall. Confirm that the screws have been firmly installed onto the wall.
 -  You may need additional material such as an anchor depending on the type of wall.
 -  Since the necessary clamps, screws, and string are not supplied, please purchase these additionally.
2. Remove the screws from the back centre of the TV, put the screws into the clamps, and then fasten the screws onto the TV again.
 -  Screws may not be supplied with the product. In this case, please purchase the screws of the following specifications.
 -  Screw Specifications
 - For a 19 ~ 22 inch: M4
 - For a 23 ~ 65 inch: M8
3. Connect the clamps fixed onto the TV and the clamps fixed onto the wall with a strong cable and then tie the string tightly.
 -  **NOTE**
 - Install the TV near to the wall so that it does not fall backwards.
 - It is safe to connect the string so that the clamps fixed on the wall are equal to or lower than the clamps fixed on the TV.
 - Untie the string before moving the TV.
4. Verify all connections are properly secured. Periodically check connections for any sign of fatigue for failure. If you have any doubt about the security of your connections, contact a professional installer.

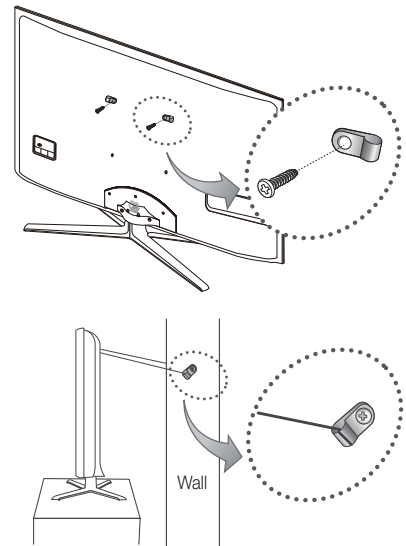

Other Information

Troubleshooting

If you have any questions about the TV, first refer to this list. If none of these troubleshooting tips apply, please visit “www.samsung.com,” then click on Support, or contact the call centre listed on the back-cover of this manual.

| Issues | Solutions and Explanations |
|--|--|
| Picture Quality | First of all, please perform the Picture Test and confirm that your TV is properly displaying test image. (go to MENU - Support - Self Diagnosis - Picture Test) (p. 24) If the test image is properly displayed, the poor picture may be caused by the source or signal. |
| The TV image does not look as good as it did in the store. | <ul style="list-style-type: none"> • If you have an analogue cable/set top box, upgrade to a digital set top box. Use HDMI or Component cables to deliver HD (high definition) picture quality. • Cable/Satellite subscribers: Try HD stations from the channel line up. • Antenna connection: Try HD stations after performing Auto programme.  Many HD channels are up scaled from SD(Standard Definition) contents. • Adjust the Cable/Set top box video output resolution to 1080i or 720p. • Make sure you are watching the TV at the minimum recommended distance based on the size and definition of the signal. |
| The picture is distorted: macro block error, small block, dots, pixelization | <ul style="list-style-type: none"> • Compression of video contents may cause picture distortion especially in fast moving pictures such as sports and action movies. • Low signal level or bad quality can cause picture distortion. This is not a TV issue. |
| Colour is wrong or missing. | <ul style="list-style-type: none"> • If you're using a component connection, make sure the component cables are connected to the correct jacks. Incorrect or loose connections may cause colour problems or a blank screen. |
| There is poor colour or brightness. | <ul style="list-style-type: none"> • Adjust the Picture options in the TV menu. (go to Picture mode / Colour / Brightness / Sharpness) (p. 15) • Adjust Energy Saving option in the TV menu. (go to MENU - Picture - Eco Solution - Energy Saving) (p. 15) • Try resetting the picture to view the default picture settings. (go to MENU - Picture - Picture Reset) (p. 19) |
| There is a dotted line on the edge of the screen. | <ul style="list-style-type: none"> • If the picture size is set to Screen Fit, change it to 16:9. (p. 16) • Change cable/set top box resolution. |
| The picture is black and white. | <ul style="list-style-type: none"> • If you are using an AV composite input, connect the video cable (yellow) to the Green jack of component input 1 on the TV. |
| When changing channels, the picture freezes or is distorted or delayed. | <ul style="list-style-type: none"> • If connected with a cable box, please try to reset the cable box. Reconnect the AC cord and wait until the cable box reboots. It may take up to 20 minutes. • Set the output resolution of the cable box to 1080i or 720p. |
| Sound Quality | First of all, please perform the Sound Test to confirm that your TV audio is properly operating. (go to MENU - Support - Self Diagnosis - Sound Test) (p. 24) If the audio is OK, the sound problem may be caused by the source or signal. |
| There is no sound or the sound is too low at maximum volume. | <ul style="list-style-type: none"> • Please check the volume of the external device connected to your TV. |
| The picture is good but there is no sound. | <ul style="list-style-type: none"> • Set the Speaker Select option to TV Speaker in the Sound menu. (p. 21) • If you are using an external device, make sure the audio cables are connected to the correct audio input jacks on the TV. • If you are using an external device, check the device's audio output option (ex. you may need to change your cable box's audio option to HDMI when you have a HDMI connected to your TV). • If you are using a DVI to HDMI cable, a separate audio cable is required. • If your TV has a headphone jack, make sure there is nothing plugged into it. |
| The speakers are making an inappropriate noise. | <ul style="list-style-type: none"> • Check the cable connections. Make sure a video cable is not connected to an audio input. • For antenna or cable connections, check the signal strength. Low signal level may cause sound distortion. |

| Issues | Solutions and Explanations |
|--|---|
| No Picture, No Video | |
| The TV won't turn on. | <ul style="list-style-type: none"> • Make sure the AC power cord is securely plugged in to the wall outlet and the TV. • Make sure the wall outlet is working. • Try pressing the POWER button on the TV to make sure the problem is not the remote. If the TV turns on, refer to "The remote control does not work" below. |
| The TV turns off automatically. | <ul style="list-style-type: none"> • Ensure the Sleep Timer is set to Off in the Setup menu. (p. 22) • If your PC is connected to the TV, check your PC power settings. • Make sure the AC power cord is plugged in securely to the wall outlet and the TV. • When watching TV from an antenna or cable connection, the TV will turn off after 10 ~ 15 minutes if there is no signal. |
| There is picture/Video. | <ul style="list-style-type: none"> • Check cable connections (remove and reconnect all cables connected to the TV and external devices). • Set your external devices' (Cable/Set top Box, DVD, Blu-ray etc) video outputs to match the connections to the TV input. For example, if an external device's output is HDMI, it should be connect to an HDMI input on the TV. • Make sure your connected devices are powered on. • Be sure to select the TV's correct source by pressing the SOURCE button on the TV remote. |
| RF(Cable/Antenna) Connection | |
| The TV is not receiving all channels. | <ul style="list-style-type: none"> • Make sure the Antenna cable is connected securely. • Please try Plug & Play (Initial setup) to add available channels to the channel list. Go to MENU - Setup - Plug & Play (Initial setup) and wait for all available channels to be stored (p. 7). • Verify the Antenna is positioned correctly. |
| The picture is distorted: macro block error small block, dots, pixelization | <ul style="list-style-type: none"> • Compression of video contents may cause picture distortion, especially with fast moving pictures such as sports and action movies. • A low signal can cause picture distortion. This is not a TV issue. |
| PC Connection | |
| A "Mode Not Supported" message appears. | <ul style="list-style-type: none"> • Set your PC's output resolution and frequency so they match the resolutions supported by the TV. (p. 26) |
| "PC" is always shown on the source list, even if a PC is not connected. | <ul style="list-style-type: none"> • This is normal; "PC" is always shown on the source list, regardless of whether a PC is connected. |
| The video is OK but there is no audio. | <ul style="list-style-type: none"> • If you are using a HDMI connection, check the audio output setting on your PC. |
| Network Connection (Depending on Models) | |
| Wireless network connection failed. | <ul style="list-style-type: none"> • Samsung Wireless USB dongle is required to use a wireless network. • Make sure the Network Connection is set to Wireless (p. 29). • Make sure the TV is be connected to a wireless IP sharer (router). |

Other Information

| Issues | Solutions and Explanations |
|--|---|
| Others | |
| The picture won't display in full screen. | <ul style="list-style-type: none"> • HD channels will have black bars on either side of the screen when displaying up scaled SD (4:3) contents. • Black bars on the top and bottom will appear during movies that have aspect ratios different from your TV. • Adjust the picture size options on your external device or TV to full screen. |
| The remote control does not work. | <ul style="list-style-type: none"> • Replace the remote control batteries with the poles (+/-) in the right direction. • Clean the sensor's transmission window on the remote. • Try pointing the remote directly at the TV from 5~6 feet away. |
| The cable/set top box remote control doesn't turn the TV on or off, or adjust the volume. | <ul style="list-style-type: none"> • Programme the Cable/Set top box remote control to operate the TV. Refer to the Cable/Set user manual for the SAMSUNG TV code. |
| A "Mode Not Supported" message appears. | <ul style="list-style-type: none"> • Check the supported resolution of the TV, and adjust the external device's output resolution accordingly. Refer to the resolution settings on page 25 of this manual. |
| There is a plastic smell from the TV. | <ul style="list-style-type: none"> • This smell is normal and will dissipate over time. |
| The TV Signal Information is unavailable in the Self Diagnostic Test menu. | <ul style="list-style-type: none"> • This function is only available with digital channels from an Antenna / RF/Coax connection (p. 24). |
| The TV is tilted to the side. | <ul style="list-style-type: none"> • Remove the base stand from the TV and reassemble it. |
| There are difficulties assembling the stand base. | <ul style="list-style-type: none"> • Make sure the TV is placed on a flat surface. If you can not remove the screws from the TV, unnecessary use a magnetized screw driver. |
| The channel menu is greyed out. (unavailable) | <ul style="list-style-type: none"> • The Channel menu is only available when the TV source is selected. |
| Your settings are lost after 30 minutes or every time the TV is turned off. | <ul style="list-style-type: none"> • If the TV is in the Store Demo mode, it will reset audio and picture settings every 30 minutes. Change the settings from Store Demo mode to Home Use mode in the Plug & Play (Initial setup) procedure. Press the SOURCE button to select TV mode, and go to MENU → Setup → Plug & Play (Initial setup) → ENTER ↵ (p. 7). |
| You have intermittent loss of audio or video. | <ul style="list-style-type: none"> • Check the cable connections and reconnect them. • Loss of audio or video can be caused by using overly rigid or thick cables. Make sure the cables are flexible enough for long term use. If mounting the TV to the wall, we recommend using cables with 90 degree connectors. |
| You see small particles when you look closely at the edge of the frame of the TV. | <ul style="list-style-type: none"> • This is part of the product's design and is not a defect. |
| The PIP menu is not available. | <ul style="list-style-type: none"> • PIP functionality is only available when you are using a HDMI, PC or components source (p. 24). |
| The message "Scramble signal" or "Weak Signal/No Signal" appears. | <ul style="list-style-type: none"> • If you are using a CAM CARD (CI/CI+), check that it is installed into the common interface slot. • If there is still a problem, pull the CAM CARD out of the TV and insert it into the slot again. |
| You turned the TV off 45 minutes ago, and it turned on again. | <ul style="list-style-type: none"> • It is normal. The TV operates the OTA (Over The Aerial) function itself to upgrade firmware downloaded whilst your watching TV. |
| There are recurrent picture/sound issues. | <ul style="list-style-type: none"> • Check and change the signal/source. |
| A reaction may occur between the rubber cushion pads on the base stand and the top finish of some furniture. | <ul style="list-style-type: none"> • To prevent this, use felt pads on any surface of the TV that comes in direct contact with furniture. |

 This TFT LED panel uses a panel consisting of sub pixels which require sophisticated technology to produce. However, there may be a few bright or dark pixels on the screen. These pixels will have no impact on the performance of the product.

Licence



Manufactured under licence from Dolby Laboratories. Dolby and the double-D symbol are trademarks of Dolby Laboratories.



TheaterSound, SRS and the  symbol are trademarks of SRS Labs, Inc. TheaterSound technology is incorporated under license form SRS Lab, Inc.



Manufactured under licence under U.S. Patent #'s: 5,451,942; 5,956,674; 5,974,380; 5,978,762; 6,487,535 & other U.S. and worldwide patents issued & pending. DTS and the Symbol are registered trademarks. & DTS 2.0 Channel and the DTS logos are trademarks of DTS, Inc. Product Includes software. © DTS, Inc. All Rights Reserved.



DivX Certified to play DivX video up to HD 1080p, including premium content.

ABOUT DIVX VIDEO: DivX® is a digital video format created by DivX, Inc. This is an official DivX Certified device that plays DivX video. Visit www.divx.com for more information and software tools to convert your files into DivX video.

ABOUT DIVX VIDEO-ON-DEMAND: This DivX Certified® device must be registered in order to play DivX Video-on-Demand (VOD) content. To generate the registration code, locate the DivX VOD section in the device setup menu.

Go to vod.divx.com with this code to complete the registration process and learn more about DivX VOD.

Pat. 7,295,673; 7,460,688; 7,519,274

Open Source Licence Notice

In the case of using open source software, Open Source Licences are available on the product menu.

Other Information

Specifications

| | | | |
|------------------------------|-------------------------------|---------------------------|---------------------------|
| Panel native | 1920 x 1080 @ 60 Hz | | |
| Environmental Considerations | 10°C to 40°C (50°F to 104°F) | | |
| Operating Temperature | 10% to 80%, non-condensing | | |
| Operating Humidity | -20°C to 45°C (-4°F to 113°F) | | |
| Storage Temperature | 5% to 95%, non-condensing | | |
| Storage Humidity | | | |
| Model Name | UA40C7000 | UA46C7000 | UA55C7000 |
| Screen Size | 40 inches | 46 inches | 55 inches |
| Sound (Output) | 10W x 2 | 10W x 2 | 15W x 2 |
| Dimensions (WxDxH) | | | |
| Body | 957.4 X 26.5 X 578.7 mm | 1092.3 X 653.2 X 26.5 mm | 1283.4 X 26.5 X 762.3 mm |
| With stand | 957.4 X 267.7 X 648.4 mm | 1092.3 X 302.9 X 724.3 mm | 1283.4 X 302.2 X 833.4 mm |
| Weight | | | |
| Without Stand | 13.2 kg | 16.8 kg | 22.2 kg |
| With Stand | 15.4 kg | 19.1 kg | 24.5 kg |

 Design and specifications are subject to change without prior notice.

 For information about power supply, and more about power consumption, refer to the label attached to the product.

A

| | |
|------------------|----|
| AllShare | 50 |
| Amplify | 20 |
| Anynet+ | 42 |
| AUDIO OUT | 10 |
| Auto Adjustment | 20 |
| Auto Volume | 21 |

B

| | |
|------------------|----|
| Background Music | 41 |
| Balance L/R | 20 |
| Basic View | 40 |
| Batteries | 6 |
| Black Tone | 15 |
| Blanking Bracket | 53 |
| Brightness | 15 |

C

| | |
|-------------------------------|-------|
| Cable Tie | 4, 53 |
| Change PIN | 22 |
| Channel Menu | 13 |
| Clock | 22 |
| Colour Tone | 16 |
| Component | 9 |
| Connecting to a PC | 26 |
| Connecting to an Audio Device | 10 |

D

| | |
|--------------------------|--------|
| DIGITAL AUDIO OUT | 10, 42 |
| DivX® VOD | 41 |
| D-sub | 26 |
| Dynamic | 15 |
| Dynamic Contrast | 15 |

E

| | |
|------------------|----|
| Eco Sensor | 15 |
| Edit Name | 10 |
| Editing Channels | 14 |
| Energy Saving | 15 |
| Equalizer | 20 |
| External Speaker | 21 |

F

| | |
|-------------------|----|
| Favourite Channel | 13 |
| Film Mode | 17 |
| Fine Tune | 14 |
| Flesh Tone | 16 |
| Frequency | 13 |

H

| | |
|--------------|--------|
| HDMI | 8, 42 |
| Headphones | 10 |
| Home Theatre | 10, 42 |

I

| | |
|--------------------|----|
| Installation Space | 2 |
| Internet@TV | 46 |

L

| | |
|----------|----|
| Language | 23 |
| License | 59 |
| Lock | 14 |

M

| | |
|-------------------|----|
| Media Play | 34 |
| Melody | 23 |
| Menu Transparency | 23 |
| Music | 39 |

N

| | |
|--------------------|----|
| Navigate | 11 |
| Network Connection | 27 |
| Network Setup | 28 |

O

| | |
|----------------------|----|
| ON/OFF button | 6 |
| Optimal resolution | 26 |

P

| | |
|--------------------------|--------|
| Password | 47 |
| Photos | 40 |
| Picture Size | 16, 42 |
| PIP (Picture in Picture) | 24 |
| Plug & Play | 7 |
| Power Indicator | 5 |

R

| | |
|----------------|----|
| Receiver | 44 |
| Recording | 44 |
| Remote Control | 6 |
| Repeat Mode | 41 |
| RGB Only Mode | 15 |
| Rotate | 41 |

S

| | |
|--------------------|----|
| Select All | 14 |
| Self Diagnosis | 24 |
| Sharpness | 15 |
| Signal Information | 24 |
| Sleep Timer | 22 |
| Slide Show | 40 |
| Software Upgrade | 24 |
| Source List | 10 |
| Speaker Select | 21 |
| Specifications | 60 |
| Standby mode | 5 |
| Subtitle | 23 |
| Symbol | 3 |

T

| | |
|-----------------|----|
| Timer | 22 |
| Title | 40 |
| Tools | 3 |
| Troubleshooting | 56 |
| TV Speaker | 21 |

U

| | |
|-----------|--------|
| USB Drive | 25, 34 |
|-----------|--------|

V

| | |
|---------------|----|
| Video Formats | 38 |
| Videos | 38 |
| Volume | 5 |

W

| | |
|---------------|----|
| Wall Mount | 53 |
| Warm | 16 |
| White Balance | 16 |

***This page is intentionally
left blank.***