



NP700G7C

700G7C

***SERVICE* MANUAL**

70G7C

Contents



1. Precaution
2. Introduction
3. Disassembly and Reassembly
4. Trouble shooting
5. System Wire Diagram

Refer to the service manual in the GSPN (see the rear cover) for more information.

Contents

| | |
|---|--------|
| 1. Precaution..... | 1 – 1 |
| 1.1. General After-Sales Service Precautions..... | 1 – 1 |
| 1.2. Safety Precautions | 1 – 2 |
| 1.3. Ground | 1 – 3 |
| 1.4. Static Electricity Precautions..... | 1 – 4 |
| 2. Introduction | 2 – 1 |
| 2.1. Product Features..... | 2 – 1 |
| 2.2. Specification..... | 2 – 3 |
| 2.3. Comparing product specifications | 2 – 9 |
| 2.4. Option part List..... | 2 – 10 |
| 2.5. Function of Product..... | 2 – 14 |
| 2.6. Hardware – New H/W | 2 – 20 |
| 2.7. SW List | 2 – 29 |
| 2.8. System Setup (Bios Setup)..... | 2 – 31 |
| 2.9. Main Board Information..... | 2 – 37 |
| 3. Desassembly and Reassembly..... | 3 – 1 |
| 3.1. MainSystem..... | 3 – 1 |
| 3.2. LCD Part..... | 3 – 4 |
| 4. Trouble shooting | 4 – 1 |
| 4.1. General spec | 4 – 1 |
| 4.2. Debugging Flow Chart..... | 4 – 2 |
| 4.3. System Diagnosis | 4 – 5 |
| 4.4. Diagnostic Program..... | 4 – 6 |
| 4.5. Hardware Troubleshooting | 4 – 8 |
| 4.5.1. LCD | 4 – 8 |
| 4.5.2. Main System | 4 – 10 |
| 4.6. RTC Battery Reset | 4 – 17 |
| 4.7. CPU FAN Control..... | 4 – 18 |
| 4.8. Battery Use time..... | 4 – 21 |
| 4.9. Bios Update..... | 4 – 24 |
| 4.10. H/W Upgrade | 4 – 25 |
| 5. System Wire Diagram | 5 – 1 |
| 5.1. System Layout | 5 – 1 |
| 5.2. Board Component..... | 5 – 4 |

1. Precaution

1.1. General After-Sales Service Precautions

- 1) Do not let customers repair the product themselves..
 - › There is a danger of injury and the product life time may be shortened.
- 2) Make sure to disconnect the power cord from the wall outlet before repairing the product (especially for after-sales service of electric parts).
 - › There is a danger of electric shock.
- 3) Do not let customers plug several electric home appliances into a single wall outlet at the same time.
 - › There is a danger of fire due to overheating.
- 4) Check if the power plug or wall outlet are damaged in any way.
 - › If a defect is found, repair or replace it immediately.
(There is a danger of electric shock or fire)
- 5) Make sure that it is properly grounded.
(Check the ground of the wall outlet)
 - › Electricity leakage may cause electric shock.

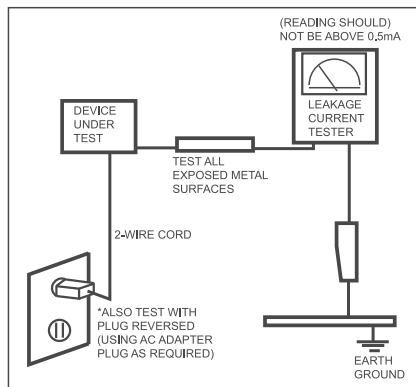

Figure 1.1 Leakage Current Test Circuit

- 6) Do not spray water on to the product to clean it.
 - › There is a danger of electric shock or fire and it may shorten the lifetime of the product..
- 7) Check the assembly status of the product after the after-sales service..
 - › The assembly status of the product must be the same as before the after-sales service.
- 8) Unplug the power cord holding the power plug (and not the cord).
 - › If the cord is disconnected, it may cause electric shock or fire.
- 9) Repair the product using only authorized parts
- 10) Keep the product away from heating devices such as heaters.
 - › Exposure to heaters may cause deformation of the product or fire.

1.2. Safety Precautions

1) EMI

This device has been registered regarding EMI for residential use. It can be used in all areas.

2) Circuit Test (Logic Test) Precautions

The LSI and MSI used in this product are semiconductor integrated circuits based on MOS-FET or CMOS. Since these types of devices are highly susceptible to static electricity or current leakage, an isolation break may be caused. Therefore read and follow the instructions below.

- a) When handling an LSI or MSI, make sure your body is grounded through a few mega-ohms of resistance. In addition, wear gloves and a jacket made of cotton and not of synthetic fibers that easily generate static electricity.
- b) When repairing the product, place a conductive material (e.g. aluminum foil) grounded to the earth on the worktable.
- c) You must use a soldering iron without a leakage current.
- d) Do not touch the pin of an IC and carefully insert the IC into the black plastic package.
- e) When inserting an IC into a PCB, be careful with the direction of the IC. When installing an IC in the wrong direction, it might become damaged.
- f) When carrying an IC, package the IC with conducting material such as aluminum foil or conducting sponge so as to keep the voltage level of each of the terminals the same.
- g) Since the storage temperature of an IC is between $-20 \sim +70$ degrees, keep it at room temperature, if possible.
- h) Since the storage temperature of an IC is between $-20 \sim +70$ degrees, keep it at room temperature, if possible.
- i) When soldering an IC, solder it in as short a time as possible so that unnecessary heat is not applied to the device.
- j) Avoid leaving excessive amounts of flux within a custom IC or between the pins when soldering a custom IC.
- k) Take care to not damage the board when installing or separating an Option Board.
- l) Take care to not break the printed circuit pattern on the PCB when separate an IC.

1.3. Ground

The product must be grounded to protect it from static electricity and other dangers. When using a multitap, please use a multi tap with a ground terminal only.

If you use a 220V wall outlet with a ground terminal, you do not need to ground it additionally. Avoid using wall outlets if they are not grounded even if they have a ground terminal.

To ground the product, connect the ground to an exclusive ground terminal or metal water pipe. Connect the ground cable to the ground terminal at the rear of the main body. To ground the product, connect the ground terminal of the product to a metal water pipe, wall outlet or exclusive ground terminal with an electric wire equal to or thicker than #18.

Never ground the product to a PVC water pipe, phone line, TV, radio antenna, aluminum window or gas pipe, because this does not actually ground the product and may be dangerous.

※ If the product is damaged by grounding unused : Paid service response

When using the AC power plug

Connect the power plug pins perpendicular into the center of the power outlet.

- If the plug pins are not inserted into the center of the holes, the plug pins are only inserted up to half their length. In this case, reconnect the power plug.
- You have to insert the power plug into the outlet when the power indicator (LED) of the power outlet is lit green. If the power is connected properly, the power indicator (LED) remains green.

Otherwise, the power indicator (LED) is turned off. In this case, unplug the power, check if the power indicator (LED) is green, and then reconnect the power plug.

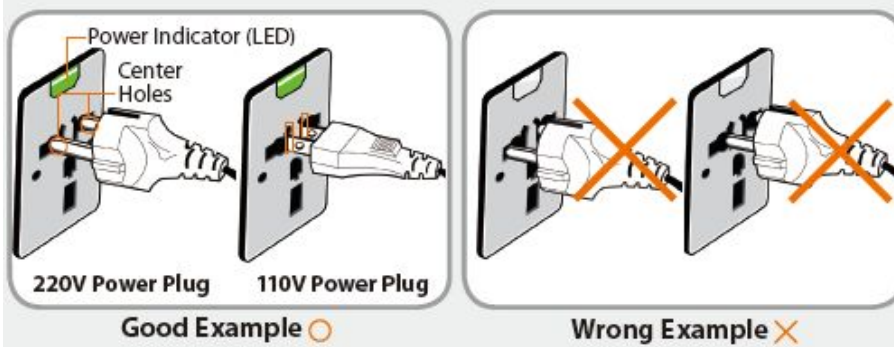

1.4. Static Electricity Precautions

Many parts of the system are susceptible to static electricity. Using an electrostatic discharge (ESD) device is very important for the safety of the user and the user's surroundings. Using an ESD device increases the probability of a successful repair and lowers the expenses for damaged parts.

To prevent static electricity, follow the instructions below.



- 1) Perform the repair in a location without static electricity.
- 2) Touch your hands to a metal water pipe or some metal object connected to the ground to discharge any static Electricity from your body before handling the parts.
- 3) Touch only the edges of the board, if possible.
- 4) Do not touch any parts unless absolutely necessary
- 5) Disassemble the parts on the anti-static-electricity pad.
- 6) When a board is not installed in the system, package the board with an anti-static-electricity packaging.

2. Introduction

2.1. Product Features

● Gamers for PC

- 20% performance compared to existing Gfx Upgrade!!
- Desire for Performance
- 20s(46%), Students, Young Gamers

| Smarter Tablet for Tech Trend Setters | Ultimate Gaming PC for Gamers |
|---|---|
|  <p>Turbo Cooling Mode - Control thermal by turbo cooling</p>  <p>Ultimate Gaming PC - Can play any games with full Option.</p>  <p>Work - Support Library Mode for silent use</p> | <p>Powerful as Premium Gaming PC - Core i7, Express Cache(8G), 16GB RAM(Max),</p> <p>Support Turbo Gaming Mode -When playing games, change a mode to Game Mode (Touch pad off / Turbo cooling enable, ETC...)</p> <p>Best Key board adopted - D/T Like Arrow key / Backlit support / High Key stroke</p> |

Performance

- Intel Core i5
- Intel Chief River Platform
- NVIDIA GeForce 675M
- AMD-7970M(TBD)
- Full HD 3D Support LCD (option)

Usability

- Windows 7
- Fn.Key

Connectivity

- Bluetooth™ BT V4.0
- USB Chargeable
- 7-in-1

Design

- 2012 new Color(Yellow Option)
- FHD 3D LCD

** Factory Option*

Family Entertainment Note PC with Enhancing Connectivity

2.2. Specification

| | |
|---|---|
| Processor and Motherboard | |
| CPU*** (Upgrade Not, Use one kind of) | Intel® Core™ i7 Processor 3610QM (2.30 GHz, 6 MB) |
| | Intel® Core™ i7 Processor 3720QM (2.60 GHz, 6 MB) |
| | Intel® Core™ i7 Processor 3820QM (2.70 GHz, 6 MB) |
| Socket | Socket G2(rPGA988B) |
| Manufacturing process | 0.022 micron |
| Cache | L2 : 6MB |
| Intel Turbo Boost | i7-3610QM - Max 3.3Ghz |
| | i7-3720QM - Max 3.6Ghz |
| | i7-3610QM - Max 3.7Ghz |
| Chipset | Intel HM76 |
| BIOS | 64 Mbit SPI flash |
| Thermal Design Performance | MAX. 45W |
| Memory | |
| Memory*** / Max. Memory | MAX. 16GB (Max 4GB per SODIMM) |
| Memory type | PC3-12800(1600MHz) DDR3 SODIMM |
| | ※ PC3-10600(1333Mhz) Memory reliability / compatibility verification is complete |
| Memory Modules | 4 GB SODIMM 8 GB SODIMM 16 GB SODIMM |
| Sockets | 4-slot SODIMMs |
| Display and Graphics | |
| LCD*** | 17.3" FHD+ (16:9) Glare |
| Vendor | Samsung LCD |
| Type | LED LCD with Glare |
| LCD Viewable Area | 381.888 (H) x 214.812 (V) (17.3 "diagonal) |
| LCD Panel | TN |
| LCD Resolution | FHD (1920 x 1080) |
| Pixel Pitch | 0.2175 (H) x 0.2088 (V) (TYP.) |
| Viewing angle | Horizontal 65°/65° , Vertical 45°/50°(TYP.) |
| Color Gamut | 72%(TYP.) |
| Brightness | 400 cd/m2 |
| Response time | 5ms (typ) |
| The maximum opening angle LCD | 145° |
| | |
| Graphics Controller*** | nVidia 675M (N13E-GS1, MXM) |
| Video Memory | 2GB gDDR5 Descreted graphic memory |
| GPU TDP | Max. 75W |
| Max.Resolution for LFP LVDS | dual link resolution of 1920 X 1200 per link / a maximum theoretical pixel rate of 224 MP/s |

| | |
|----------------------------------|---|
| Max. resolution for VGA | Max resolution of 2,048 x 1,536 at 85Hz refresh rate (ext.) (640x480,800x600, 1024x768, 1152x864, 1280x800,1280x960, 1280x1024, 1400x1050, 1440x900,1600x1024,1600x1200, 1680x1050, 1920x1200, 1920x1440, 2048x1536) [Ext.monitor resolutions Supported by EDID information] |
| Max. resolution for HDMI | Support v1.4a compliant / a resolution of 2048x1536pixels with 32-bit color at 75 Hz [Ext.monitor resolutions Supported by EDID information] |
| Max. resolution for Display Port | Support DP++ / a resolution of 2048x1536pixels with 32-bit color at 75 Hz [Ext.monitor resolutions Supported by EDID information] |
| 3D Function | Not support |
| Audio and Video | |
| Sound | |
| Chipset | REALTEK ALC269Q-VB2-GR |
| Codec | HD Audio Codec, ALC269Q-VB2-GR |
| Conversion | Built-in high performance 24-bit ADC & 24-bit DAC |
| Sound effect | Dolby |
| Internal Interfaces | Embedded stereo speakers & integrated mono microphone |
| Speaker Power Rating | 2 speakers x 2 W with enclosure each + Woofer 3W |
| External Interfaces | Microphone, Headphone, SPDIF NOT SUP |
| Controls | Keyboard volume control |
| Microphone | |
| Type | 1 integrated mono microphone |
| Sensitivity | .-42dB [0dB=1V/Pa, at 1KHz] |
| Output impedace | Max. 2,200 Ohm at 1KHz |
| Noise supression | Noise supression |
| Camera | |
| Type | 2.0 FHD Web-Cam (interface : USB 2.0) |
| Chipset | SC_20FHL11146M(MCNEX) |
| Image sensor | .1/6" Color CMOS 2.0M FHD(1920X1080) |
| Still Image Capture Resolution | 1920 x 1080(FullHD 1080P), 1280 x 720 (HD 720P), 800 x 600 (SVGA), 640 x 480 (VGA), 352 x 288 (CIF), 320 x 240 (QVGA), 176 x 144 (QCIF) 160 x 120 (QQVGA) |
| Video Capture Resolution | 1920 x 1080(FullHD 1080P), 1280 x 720 (HD 720P), 800 x 600 (SVGA), 640 x 480 (VGA), 352 x 288 (CIF), 320 x 240 (QVGA), 176 x 144 (QCIF) 160 x 120 (QQVGA) |
| Output Video Format | Uncompressed –based on Camera H/W |
| UVC Support | Supproted |
| Storage | |

| | |
|-----------------------------------|---|
| Hard Disk Drive-7200rpm*** | 9.5mmH 2.5" SATA HDD, Removable |
| HDD Vendor | HGST, Fujitsu, Samsung Storage, Toshiba , WD |
| Type | 9.5 mm Height 2.5" S-ATA |
| Supports | SATA host controller support 48bit LBA (HDD Interface supports SATA1 - 1st HDD / SATA2 - 2nd HDD) |
| Average Access Time | 13m sec. |
| Speed | 5400rpm/7200rpm SATA |
| Capacity | 500GB, 750GB, 1TB, 1.5TB, 2TB(F.option) |
| | * SSD Support (1st HDD : SATA 3 / 2nd HDD : SATA2 Support) |
| 2nd HDD Assy Unit | BA96-05817A - included in bundle UNIT_BRACKET-HDD_SUPPORT RUBBER-HDD SCREW-MACHINE MANUAL-1SHEET_GUIDE LABEL-PPID_E |
| Express Cache (ISSD) | Sandisk Express Cache i100 adpot (Interface : P5 : SATA3, P4 : SATA2) |
| Speed | Maximum Host transfer Rate 6Gb/s |
| Capacity | 8GB |
| Optical Driver Modules | |
| Optical Disk Driver*** | Blue-ray Combo Drive 1(Blue-ray Read only) - SATA2 Interface |
| Vendor | TSST / PLDS |
| Module type | 12.7 mm Fixed type, S-ATA |
| Speed | 4x BD-R/ BD-RE, 2x BD-R DL/ BD-RE DL, 5x DVD-RAM, 8x DVD±R, 6x DVD±R DL, 8x DVD+RW, 6x DVD-RW, 24x CD-R/RW, 8xDVD, 24x CD |
| Average Access Time | BD 250~400ms, DVD 150~350ms., CD 150~170ms. |
| Weight | 175g +/- 5g |
| S/W Supplied | Cyberlink Media Suite 8 Bluray Disc 3D , Bluray, Supermulti(F. option) |
| Security | RPC-II Regional Encoding |
| | |
| Optical Disk Driver*** | Super Multi Dual Layer |
| Vendor | TSST / TEAC / PLDS |
| Module type | 12.7 mm, S-ATA, Fixed type |
| Speed | Writing(CD-R 24X/CD-RW 24X/DVD±R 8X/DVD+RW 8X(4X)/DVD-RW 6X/DVD-RAM 5X), Reading(CD 24X/DVD 8X) |
| Average Access Time | DVD 130~160ms Typ, CD 130~160ms Typ |
| Weight | max.140g |
| S/W Supplied | Cyberlink DVD Solution |
| Security | RPC-II Regional Encoding |

| | |
|--|--|
| Network Tools | |
| LAN*** | Integrated 10/100/1000 Mbps Ethernet |
| Chipset | RTL8111E |
| Features | RJ45 Output |
| Combo module*** | Intel Jacksonpeak2 WLAN+BT Combo |
| Type | Intel Jackson Peak2, 802.11a/g/n 2x2 WiFi _ Bluetooth(4.0) Combo card (Vendor : Intel) |
| MaxSpeed | 300Mbps (Link Speed is only standard value, Actually value will decided by each environmant) |
| Interface | Half Mini card type |
| Chipset | 1. Jackson-Peak2 MAC/BB Silicon 2. Jackson-Peak2 2x2 Wi-Fi-BT Radio Silicon |
| Antenna | 2 Antenna Support : WLAN (2TX, 2RX), BT(1TX/RX) |
| Bluetooth Module | |
| Type | Intel 802.11agn (2x2) + Bluetooth 4.0 (Half MiniCard STD) |
| Vendor | Intel |
| Interface | PCIe(WLAN) + USB(Bluetooth) |
| I/O Interface | |
| Memory card slot Memory card chip | 7-in-1 RTS5209 |
| Vendor | Realtek |
| Support | (SD / SDHC / SDXC / XD / MMC / Memorystick / Memorystick Pro) tested up to 32GB |
| Size | 27mm * 5mm |
| | |
| I/O Ports | |
| USB Port | 2 x USB 2.0 ports and 2 x USB 3.0 ports (incl. 1 Chargeable) |
| VGA Port | 1 CRT |
| Audio Jacks | HeadPhone-out, MIC-in |
| LAN | RJ45 |
| TV | 1 HDMI(15mm * 6mm), 1DP(16mm*7mm) |
| Security | Kensington Lock (8mm * 3mm) |
| Power | 1x DC-in jack for AC adapter (12.8 pie) |
| Input Devices | |
| Key board | "100 (KOR, RUS, UKR, US) 101 (UK, FR, GM, SP)" |
| └ Num Keypad | Yes |
| Touchpad | ELAN touchpad (with gesture function) |
| Power and Power Management | |
| System power management | |
| Power management features | ACPI V2.0 compliant, Standby(S3), Hibernate(S4) |
| | |
| Standard battery*** | |
| Model code | AA-PBAN8AB |

| | |
|--------------------------------|---------------------------------------|
| Type | Li-ion |
| Details of cell | 8 cells |
| Battery capacity | 5,900 mAh |
| Voltage | 15.1 V |
| Battery rating | 89Wh |
| Color | Black / Yellow |
| Dimension | 140 x 85 x 30.0 mm (W x H x D) |
| Weight | Max. 400 g |
| Recharge time | Approx. 3.0 hours |
| | |
| AC Adapter*** | A11-200P1A |
| Output Power | 200W |
| Dimension | 170 X 85 X 35 mm (W x H x D) |
| Weight (AC Adapter) | Typ. 750g |
| Worldwide Compatibility | Auto-sensing 110 - 240 VAC |
| Line Frequency | 50 Hz / 60Hz |
| Adapter Rating - Input | 100 VAC ~ 240 VAC, 1.5A |
| Adapter Rating - Output | 19.0 VDC, 10.5A |
| System Dimensions | |
| Dimensions (W X D X H) | W409.84 x L284.8 x H32.99~52.6 |
| Weight | 3.81KG(3.4KG without battery) |
| Condition | SM-DL , 8cell battery, 2.5" 500GB HDD |
| Package Dimensions (W X D X H) | |
| Package Weight | 6.6 kg |
| Condition | SM-DL , 8cell battery, 2.5" 500GB HDD |
| Materials | PC/ABS |
| | |
| Design | |
| LCD Back | NCVM Safe plastic film support |
| LCD Front | UV Coat |
| System Top | UV Molding |
| System Bottom | PC+ABS |
| Protect Film | |
| System Top | Yes |
| System | Yes |
| LCD - BACK | YES |
| | |
| O/S | |
| XP Driver | N/A (Because 3D function) |
| Label Location | |

2. Introduction

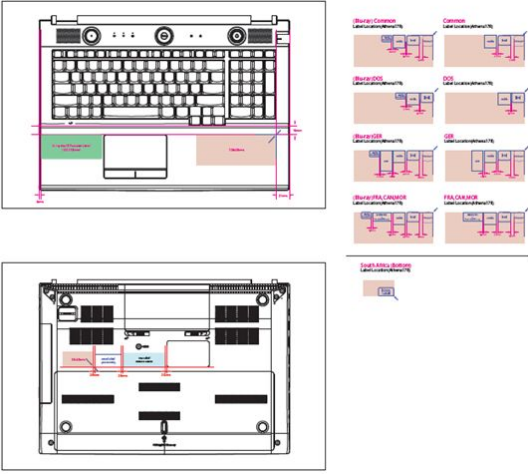
| | |
|-------------------------------|---|
| |  |
| <p>Accessories</p> | |
| <p>Accessories in the box</p> | <p>Battery, Adapter, Power Code, Installation Guide(paper), OS CD, S/W Media, TCO Sheet, 3D glasses(option, rechargeable)</p> |

2.3. Comparing product specifications

| ITEM | 700G7A | 700G7C |
|---------------|--|--|
| | Ext. Gfx. | Ext. Gfx. |
| Processor | Huron River i7 | Chief River i7 |
| Chipset | HM65 | HM76 |
| Memory | DDR3 4GB~16GB (Max Clock 1333Mhz) | DDR3 4GB~16GB (Max Clock 1600Mhz) |
| LCD | 17.3" FHD LED (Glare, 400nit) | ← |
| Gfx. | AMD Radeon HD 6970M | nVIDIA Geforce 675M (N13E – GS1) AMD 7970M(TBD) |
| HDD | 500GB ~ 1.5TB (SATA 5400, 7200rpm) | 500GB ~ 2TB (SATA 5400, 7200rpm) |
| ODD | Super Multi / Bluray | ← |
| LAN / WLAN | Gigabit Mbps , abg/n | ← |
| BT | Bluetooth v.3.0 High Speed | Bluetooth v.4.0 High Speed |
| I/O Port | USB3.0 x 2(USB2.0x2) , 7-in-1 | ← |
| Convergence | Easy Content share (3Screen), Easy file share (PC-PC) | ← |
| Size / Weight | W409.84 x L284.8 x H32.99~52.6/3.81kg | ← |
| AV Button | Power on/off,Wireless on/off Lighting On/OffMute, Volumn Up/Down Mode Dial | ← |
| Design | A : LCD Back Pattern IMR / B : RTCM / C : Vacuum Plating IMR / D : Spray | |

2.4. Option part List

□ Front

Front View

- The pictures used for the cover and the main body in the User Manual are those of the representative model of each series. Therefore the colors and appearance of the pictures may differ from the actual appearance of the product depending on the model.
- The actual color and appearance of the computer may differ from the pictures used in this guide.
- This may not be supported for some devices.



| | | |
|---|-------------------------------|--|
| 1 | Camera (Optional) | Using this camera, you can take still pictures and record video. |
| 2 | LCD | The screen images are displayed here. |
| 3 | Power Button | Turns the computer on and off. |
| 4 | Speaker | A device used to generate sound. |
| 5 | Keyboard | A device to enter data by pressing the keys. |
| 6 | Touchpad/ Touchpad Buttons | The touchpad and touchpad buttons provide functions similar to the mouse ball and buttons. |
| 7 | Status Indicators | Shows the operating status of the computer. The corresponding operating LED is lit when the corresponding function operates. |
| 8 | Microphone | You can use the built-in microphone. |
| 9 | Touch sensor buttons | Touch them with your finger slightly to configure the corresponding functions. |

Using the camera, web cam
Using the Cyberlink YouCam program (optional), you can take pictures or record video by using the computer's built-in camera by adding the balloon talk or frame effect.

□ Status Indicators

Status Indicators



| | | |
|---|---------------|---|
| 1 | HDD/ODD | This turns when either the HDD or ODD is being accessed. |
| 2 | Caps Lock | This turns on when the Caps Lock key is pressed allowing capital letters to be typed without holding the Shift button down. On: Upper-case alphabetic input Off: Lower-case alphabetic input |
| 3 | Charge Status | This shows the power source and the battery charge status. Green: When the battery is fully charged or the battery is not installed. Orange: When the battery is being charged. Off: When the computer is running on battery power without being connected to AC adapter. |
| 4 | Power | This shows the computer operating status. On: When the computer is operating. Blinks: When the computer is in Sleep mode. |

Touch sensors buttons

Touch sensors buttons



| | | |
|---|--------------------|--|
| 1 | Volume control | Controls the volume. |
| 2 | Mute | Mutes the sound. |
| 3 | Wireless Network | <p>Easily turns on or off the several wireless network settings at the same time.</p> <p>- You also can set up a specific wireless network device with the + key combination.</p> <p>On : Shows that any wireless network devices are turned on.</p> <p>Off : Shows that no wireless network device is turned on.</p> <p> If the device cannot search wireless network while this button shows On, press the + key combination to search and configure it manually.</p> |
| 4 | Keyboard backlight | Turns the keyboard backlight on or off. The red LED blinks whenever you touch this. |

Right Side

Right View



| | | |
|---|---------------------------|--|
| 1 | USB Port | You can connect USB devices to the USB port such as a keyboard/mouse, digital camera, etc. |
| 2 | CD Drive (ODD) (Optional) | Plays CD or DVD titles. Since an ODD(Optical Disk Drive) is optional, the installed drive depends on the computer model. |
| 3 | Jog dial | <p>You can configure the various computer modes.</p> <ul style="list-style-type: none"> • Gaming Mode: High-performance mode • Balanced Mode: Samsung-optimized mode • Library Mode: Silent mode • Green Mode: Maximum power-saving mode |

Left Side

Left View



What is a Chargeable USB port?

- USB device accessing and charging functions are supported.
- The USB charging function is supported regardless of whether the power is turned on or off.
- Charging a device through a Chargeable USB port may take longer than general charging.
- Using the Chargeable USB function when the computer is running on battery power reduces the battery usage time.
- The user cannot evaluate the charging status of the USB device from the computer.
- This may not be supported for some USB devices.

1 Security Slot

You can secure the computer by connecting a lock and cable to the Security Slot.

| | | |
|----|--|---|
| 2 | DC Jack | A jack to connect the AC adapter that supplies power to the computer. |
| 3 | Wired LAN Port (Optional) | Connect the Ethernet cable to this port. |
| 4 | Monitor Port | A port used to connect a monitor, TV or projector supporting a 15pin D-SUB interface. |
| 5 | HDMI port | You can connect an HDMI cable to this port. Using this port, you can enjoy digital video and audio on the TV. |
| 6 | Display port | You can connect a Display Cable to this port. Using this port, you can enjoy digital video and audio on the TV. |
| 7 | USB 3.0 Port or Chargeable USB Port (Optional) | USB ports to which you can connect USB devices as well as a Chargeable USB port are provided. Using a Chargeable USB port, you can access or charge a USB device. The port can be distinguished by the figure () printed on the port of the product. |
| 8 | Multi Card Slot (Optional) | A card slot supports multi cards. |
| 9 | Microphone Jack | A jack used to connect the microphone. |
| 10 | Headphone Jack | A jack used to connect the headphones. |

Back

Back View

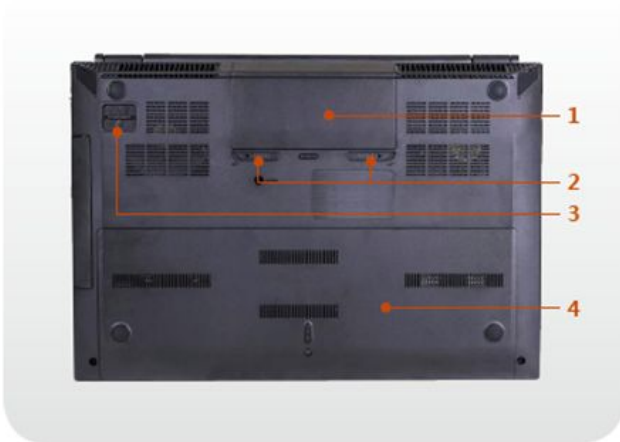

| | | |
|---|--|---|
| 1 | Battery | This is a Lithium-Ion rechargeable battery that supplies power to the computer. |
| 2 | Battery Latches | The latch used to remove or install the battery. |
| 3 | Sub-Woofer Speaker (Optional) | A device used to produce mid and low frequency sound louder. |
| 4 | Memory Compartment Cover/Hard Disk Drive Compartment Cover | The main memory and hard disk drive is installed inside the cover. |

▶ **KBD**

Keyboard arrangement and size can differ to by each country



 **KBD Water Check sheet Location**

2.5. Function of Product

►KBD Backlit

KBD Backlit



Default Lighting Scenario
 - Gaming Mode : Blue light On (W,A,S,D with RED)
 - Balanced Mode : White Light ON
 - Library / ECO Mode : Light Off (User can adjust On/Off)

In Easy Setting, User can modify KBD Backlit's brightness & time
 : Easy setting → General → Keyboard backlit

How to change brightness with KBD



►Mode Shift

ModeShift is pre-installed on Samsung laptops. ModeShift program is automatically launched in the background at the startup.

To select a particular mode, roll the Mode Dial up or down. When the mode is selected, the corresponding icon is flashed on the screen.



Note: Mode Dial is situated above the keypad on the right hand side. Refer to the above figure to know the exact location of Mode Dial.

Table below gives the different modes available and their corresponding icons that are flashed when the mode is selected.

| Mode | ICON/Screen | Mode Description |
|---------------|-------------|---|
| Game Mode | | Game Mode is ideal when you are gaming. With this mode of operation, you can configure the desktop background, screen transition, and cursor design of your laptop. With its variety of screen transition animations, life-like graphics, amazing sounds, and LED keyboard light, Game Mode guarantees you a wonderful gaming experience. |
| Balanced Mode | | Balanced Mode is Samsung laptop-optimized mode. In this mode, white keyboard Backlit is turned on. |
| Library Mode | | Library Mode reduces the noise from your system so that your laptop functions without any disturbance to the surrounding environment. To reduce the system noise, this mode reduces the fan speeds and CPU speeds. In Library Mode, sound and keyboard Backlit feature is deactivated. |
| Green Mode | | Green Mode allows you to change power option settings and turn Bluetooth and Wireless LAN devices off. You can perform simple tasks such as document management in this mode. |

The different options available in Game Mode are:

Input Device: To control the functioning of the keyboard and touchpad

Keyboard LED: To switch the keyboard LED light on or off

Visual Effects: To apply different visual effects to the display

Service: To control functioning of services

Screen Color: To optimize color

Caution

- Mode Shift Function work with Mode Dial(Jog Dial) .
It only support for Athena model. If uninstall Mode Shift, it doesn't work.
If you want to reinstall, use the SW Media DVD in Bundle.
- In Mode Shift User can modify Touch Pad On/Off on Game mode.
If user told like this " I can't use the T/P in Gaming Mode ",
let them know it can be modified in Mode shift Program.
- KBD Backlit can turn on and off,
But in Gaming mode support only Blue LED,
in other mode, not support Blue LED but also White LED.

| | USB3.0 (SuperSpeed USB) | USB2.0 |
|-----------------------------|--|---|
| Speed (Data rate) | 5.0 Gbps | Low-speed (1.5 Mbps) Full-speed (12 Mbps) High-Speed (480 Mbps) |
| Data Interface | . 4-wire differential signaling separate from USB2.0 signaling . Simultaneous bi-directional data flows | . 2-wire differential signaling . Uni-directional data flow with negotiated directional bus transactions |
| Cable Signal Count | 4 for SuperSpeed data 2 for non-SuperSpeed data | 2 for low/full/high-speed data |

- USB 3.0 Cable

-

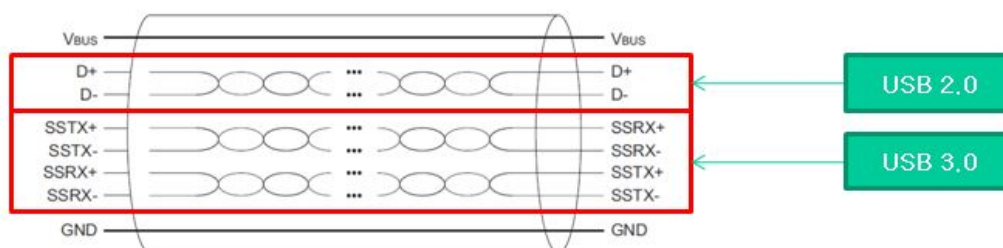





- USB 3.0 has the backward compatibility for USB 2.0

►Jog Dial

Turn the jog dial up and down to select a computer mode. To play games, select Gaming Mode.



| Mode | Icon | Major Functions |
|---------------|--|---|
| Gaming Mode |  | This is a high-performance gaming mode. This mode configures the settings as follows. <ul style="list-style-type: none"> • The keyboard backlit is turned on: Blue, Red(W, A, S, D) • The Desktop and icons are changed. • The Turbo Mode LED, Sound EQ LED and Touchpad LED are turned on. • The Touchpad and Windows keys are locked. You can configure the major functions by clicking Start > All Programs > Samsung > Mode Shift . |
| Balanced Mode |  | This is Samsung-optimized mode. The keyboard backlit is turned on white. |
| Library Mode |  | This is silent mode. The sound is muted and the keyboard backlit is turned off so that users can use the computer quietly. |
| Green Mode |  | This is the maximum power-saving mode. All major functions are turned off. |

► Using 3D

Using the 3D function

You can use the 3D function of the Samsung 3D computer after connecting the 3D glasses to the computer through a Bluetooth connection.

1 In the 3D program, run a 3D video, 3D game or 3D photo.

For the battery-operated glasses, insert the battery and remove the protective film before use.

! The 3D function is only provided in full screen mode. (The 3D function does not work in window mode.)



3D/2D Mode Selection and 3D Display Settings Button



3D/2D Mode Selection and 3D Display Settings Button

2 If you put on the 3D active glasses and press the 3D button, the data exchange begins between the glasses and the software (hereafter, referred to as pairing).

- Only when a 3D video or 3D game is executed can the pairing process be done.
- More than one person can watch pictures in 3D at the same time using more than one pair of glasses.
- A chargeable pair of 3D active glasses may not work if the battery is discharged. In this case, charge the glasses before use.
- For chargeable 3D active glasses, if the glasses do not start working immediately when you put them on in 3D mode, lightly touch the 'sensor pad' of the glasses or press and hold the 3D button for 3~5 seconds to reattempt pairing.
- For battery-operated 3D active glasses, you have to press and hold the 3D button for 4~5 seconds or longer when you perform pairing for the first time.

3 Now, you can enjoy videos or games in 3D.

The LED indicator for the battery-operated 3D active glasses

| | |
|---|---|
| On | If you press the power button, the LED turns yellow for 3 seconds and then turns off. |
| Off | If you press the power button, the LED turns red for 3 seconds and then turns off. |
| When the pairing process is in progress | The LED blinks yellow. |
| When the pairing progress has been completed | The LED alternates between blinking yellow and red for 3 seconds each. |
| When the battery needs to be replaced | The LED blinks red continuously. |

The LED indicator for the chargeable 3D active glasses

The LED indicator of the glasses changes depending on the operating conditions.

| | |
|---|--|
| Turning the power on | If you put the glasses on, the power is automatically turned on and the LED is lit green for 3 seconds. |
| Turning the power off | If you take the glasses off, the power is automatically turned off and the LED is lit red for 3 seconds. |
| When pairing is in progress | The LED alternates between green and red. |
| When charging the battery is necessary | The LED blinks red at 2 second intervals. In this case, charge the glasses with the micro USB cable. |
| When the battery is being charged | The LED blinks amber at 1 second intervals. |
| When the battery is fully charged | The LED blinks green at 2 second intervals. |

SAFETY PRECAUTIONS

Warning

Failure to follow instructions marked with this symbol may cause personal injury and even fatality.

- A parent or child minder should keep an eye on any children or infirm persons on a regular basis while they watch 3D content. Children and even some adults may experience eye strain, headaches, dizziness or nausea while watching 3D content. In this case, stop watching 3D content and take a rest.
- Do not use the 3D glasses for any purpose other than watching 3D TV, such as general eyeglasses, sunglasses, protective goggles, etc.
- Watching 3D images for an extended period of time may cause eye strain. If you feel eye strain, stop viewing the 3D content, remove the 3D glasses and take a rest.
- Do not use the 3D function or 3D glasses while walking or moving around. Using the 3D function or 3D Active Glasses while moving around may result in an injury due to running into objects, tripping, and/or falling.
- Take care that your children do not touch or swallow the battery installed in the battery-operated 3D glasses.

Charging the chargeable 3D glasses

If the LED blinks red at a 2 second interval, charge the glasses with the micro USB cable.

When the battery is fully charged, the LED blinks green at a 2 second interval.







Caution

Failure to follow instructions marked with this symbol may cause slight injury or damage to the product.

- Do not apply force to the lenses of the 3D glasses. Do not drop or bend the product. This may result in a product malfunction.
- Never disassemble, repair or modify the 3D glasses yourself. Do not use the glasses when they are out of order or broken.
- When wearing the 3D glasses, take care that you do not bump into other persons.
- When cleaning the glasses, do not spray water or cleaner directly onto the surface of the product. This may result in fire or electric shock, damage to the product surface, or result in the indication labels peeling from the product surface.
- When you wear the 3D glasses over normal glasses, take care of contact between each set of lenses.
- When you watch 3D content under inconsistent illumination (blinking fluorescent), fluorescent light (50~60Hz) or 3-wavelength light, you may notice that the screen flickers.

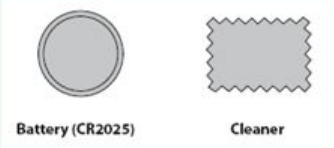
▶ 3D glassed

| Model | SSG-3100GB | SSG-M3750CR |
|---------|--|---|
| Drawing |  |  |
| Package |  Battery (CR2025) Cleaner |  Shade Micro USB Cable Cleaner |
| Power | Lithium/Manganese Battery 3V (CR2025) | Built-in 3.7V Lithium/polymer battery |
| Type | Battery exchange | Rechargeable battery |
| Weight | 35.8g (Including Battery : 35.1g) | 30g |

2.6. Hardware – New H/W

►ISSD (Express Cache)

The SanDisk® integrated Solid State Drive (iSSD)

A fast, light weight and affordable storage solution for Smartbooks, Ultra-thin PCs and Tablets that require high performance combined with an innovative form factor and low cost.



As social networking increases, a market need has developed for a storage solution that will not only provide mobile benefits such as smaller designs, cooler and quiet operation and lower power consumption, but one that will also deliver enhanced user performance.

The SanDisk iSSD drive delivers all the benefits of SSD: it is rugged and reliable, power efficient and small in size. In addition, being an SSD in a BGA form factor and tiny in size, enables the SanDisk iSSD drive to be embedded into a larger variety of new thinner and slicker devices, such as smartbooks, Ultra-thin PCs and media tablets, with surprising and new innovative designs.

Such thinner and lighter computing devices are also enabled due to SanDisk iSSD drive's embedded design which allows manufactures to avoid the additional weight and thickness required by a connector based SSD solution. Thinner storage solutions like the SanDisk iSSD drive also enable fan less designs and greater airflow contributing to a cooler device operation, an additional benefit for the user on the go.

Moreover, with a SATA interface, commonly found in PC devices, the SanDisk iSSD drive enables easy system integration with mobile PC devices as well as high productivity capabilities. Thus, allowing end users to reap the benefits of optimized PC performance and user experience even in the smallest computing devices and when they are away from home.

Product highlights

- ▶ Cost Efficient
- ▶ Performance: Sequential R/W up to 160 MB/s / 100 MB/s ^{1,2}
- ▶ Size: 16 mm x 20 mm x 1.85 mm
- ▶ Form Factor: 157 ball BGA with 0.5 mm pitch
- ▶ Weight: As low as 0.83g
- ▶ Capacity: 4GB, 8GB, 16GB, 32GB, 64GB²
- ▶ Interface: SATA
- ▶ Quiet and cool operation

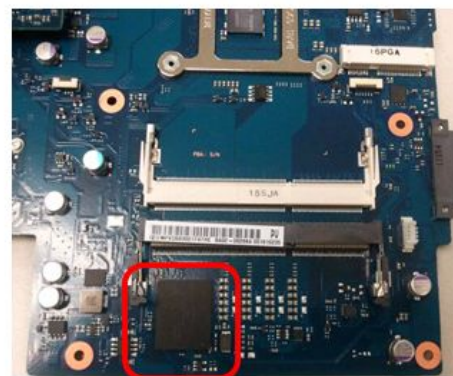
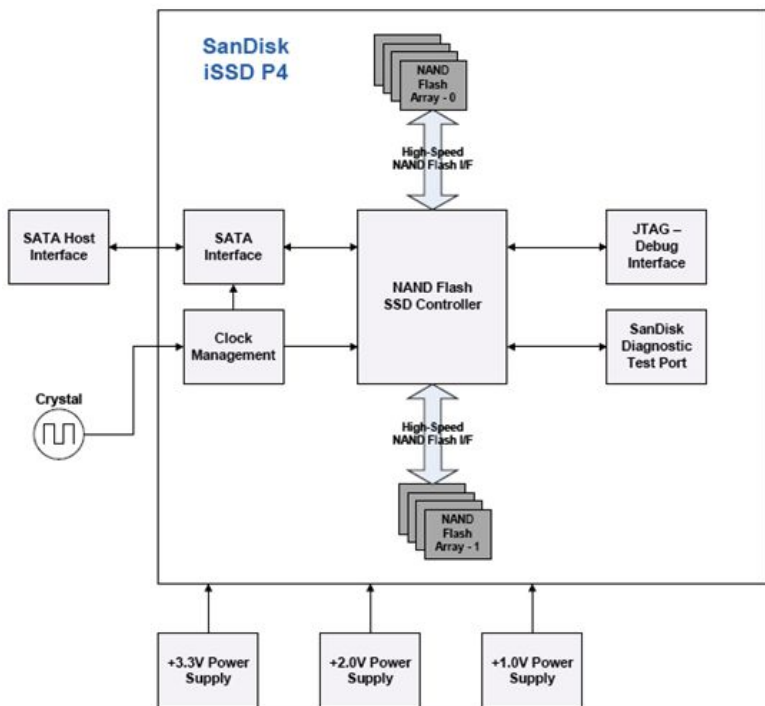

ISSD is located in Main B'D TOP SIDE.

ISSD (Summary)

- Advantage : More faster booting speed.(up to 25%)

| Table | With ISSD | Without ISSD |
|--|-----------|--------------|
| BIOS Post | 4.88 | 4.87 |
| Boot complete | 16.73 | 30.1 |
| Boot time (BIOS Post + Boot complete) | 21.61 | 34.88 |

- More faster application speed
- –Control & work
 - Express Cache Driver Control by self, User can only turn on/off/On Easy Setting, can turn on/off /Default setting is ON.(Game,Balance,Library,Eco)
- If it eliminated in device manager, there is no problem on system .But to use Express Cache again, reinstall the Driver.(included in SW MEDIA DVD)
- -Caution
 - On the BIOS,don't change the booting sequence.
 - ISSD is only cache . It's not an HDD for OS.

NEW H/W Platform

(1) Intel's 2012 Mobile Platform : Chief River

| | Huron River (2011) | Chief River (2012) |
|--------------------------------------|---|---|
| Processor & Graphics | Sandy Bridge QC Intel HD Graphics Sandy Bridge DC Intel HD Graphics Sandy Bridge LV & ULV Intel HD Graphics | Ivy Bridge QC Intel HD Graphics Ivy Bridge DC Intel HD Graphics Ivy Bridge LV & ULV Intel HD Graphics |
| Platform Controller Hub (PCH) | Cougar Point PCH Cougar Point SFF PCH | Panther Point PCH Panther Point SFF PCH |
| Comms | Kilmer & Kelsey Peak WIMAX/Wi-Fi combo Condor/Taylor/Puma Peak Wi-Fi Rainbow Peak Wi-Fi + BT combos Lewisville GbE LAN | Kilmer & Kelsey Peak WIMAX/Wi-Fi combo Jackson 1 & 2/Canyon Peak Wi-Fi + BT combo Puma/Taylor/Marble/Canyon Peak Wi-Fi Lewisville GbE LAN Thunderbolt™ Technology* |
| Extended Platform Features | Intel® Wireless Display Technology 2.0 Intel® My WiFi Technology 2011 Intel® Xtreme Tuning Utility – 2011 Premium Audio 2011 Intel® Active Management Technology 7.0 Intel® Identity Protection Technology Intel® Anti-Theft Technology 3.0 | 2011 Features plus: Intel® Smart Response Technology ¹ Intel® Rapid Start Technology ² Intel® Smart Connect Technology ³ Intel® Wireless Display Technology v3 Intel® Identity Protection Technology Intel® AMT 8.0 Intel® Small Business Advantage Intel® Anti-Theft Technology 4.0 |

Driving Innovation with Chief River

(1) Intel's 2012 Mobile Platform : key point of Panther Point (PCH)

Performance

USB 3.0 = 10x the speed of USB 2.0

Responsiveness

Intel® Smart Response Technology gives similar Gb/s as a larger SSD at a much lower cost

Display

Simultaneously view up to 3 independent screens

Compatibility / Scalability

Chief River motherboards with the Panther Point PCH support both IVB and SNB processors to give customers flexibility

USB 3.0, Responsiveness, and Scalability

(1) Intel's 2011 Mobile Platform : **Ivy Bridge(CPU)**

Ivy Bridge



Processor, Graphics and
Memory Controller on
22nm Die!



Performance

- Projecting up to 10%-15% increase in CPU performance**
- ULV Targeting >70% of SV performance**
- Support for up to DDR3 1600 memory



Power Efficiency

- Lower average power for SV and ULV**
- DDR3L support
- Support for extended battery life techniques



Innovation

- ULV with Configurable TDP and Low Power Mode for flexible and thin designs

22nm delivers balance of performance and power efficiency!

(1) Intel's 2012 Mobile Platform : **Chief River**

Chief River Platform Summary

Performance & Media Capabilities

Sleek Form Factors

Long Battery Life

Fast System Response

- Chief River enables platform innovation
 - Expecting up to 10-%15% Ivy Bridge IA performance gain over Sandy Bridge**
 - Targeting lower average power vs. Sandy Bridge** plus Configurable TDP for ULV
 - Next generation Intel processor graphics delivers faster media processing and 3D graphics** plus DX11, OCL1.1 and OGL3.1 support
 - Faster peripheral connections with USB 3.0 & Thunderbolt™ Technology*
 - Extended platform features speed up system response

NEW H/W Graphic

- nVIDIA 675M (N13E-GS1)

Chipset Specification

| Specification | Description |
|-----------------------------------|--|
| Chip | NVIDIA N13E-GS1/GS1-LP |
| MXM module | P1314 |
| Core clock | N13E-GS1: 620 MHz (see Note) |
| | N13E-GS1-LP: 598 MHz (see Note) |
| Memory clock | N13E-GS1: 1500 MHz (see Note) |
| | N13E-GS1-LP: 1500 MHz (see Note) |
| Frame buffer | 1.5 GB/2GB/3GB/4GB |
| Memory I/O | 192 bit/256 bit |
| Memory type | 12/16 pcs of 64M × 16 or 128M × 16 GDDR5 |
| Maximum module power | See Table 3 for details |
| Connector | MXM v 3.0 |
| Mean time between failures (MTBF) | <ul style="list-style-type: none"> Controlled environment: TBD hours at 35 °C Uncontrolled environment: TBD hours at 35 °C |

Note:

Preliminary frequencies, final values may change.

H/W WLAN

- **Jackson Peak 802.11abg/n (2x2) Combo**
 Form factor: Mini Card haft size
 Chipset: Intel Jackson Peak (2X2) N6235



TOP



Bottom

WLAN (Bluetooth)

qBT 4.0

- PC Side: BLE Device in connection with the existing BT 3.0 features were added.
- Device Side: This model is applied not only BT 3.0 but also BLE(Bluetooth Low Energy) only.
- Device characteristics of BLE only
 - The controller is implemented as a simple structure. Chip/Device(Affordable price)
 - Low power consumption. The device's battery life increased dramatically.
(For example) A number of Coin Cell can use the BT Keyboard with BLE Technology more than a year months)
 - The device with BLE only is not compatible with Classic Bluetooth(BT 3.0)
- Single Mode
 - BLE supports only
 - Simple structure, Affordable price, It is easy to apply.
 - Peripheral device is used.
Ex) BT KBD, MOUSE, Heart Rate Monitor
- Dual Mode
 - Classic BT and simultaneous support BLE.
 - HOST device uses
§Ex) PC, Phone

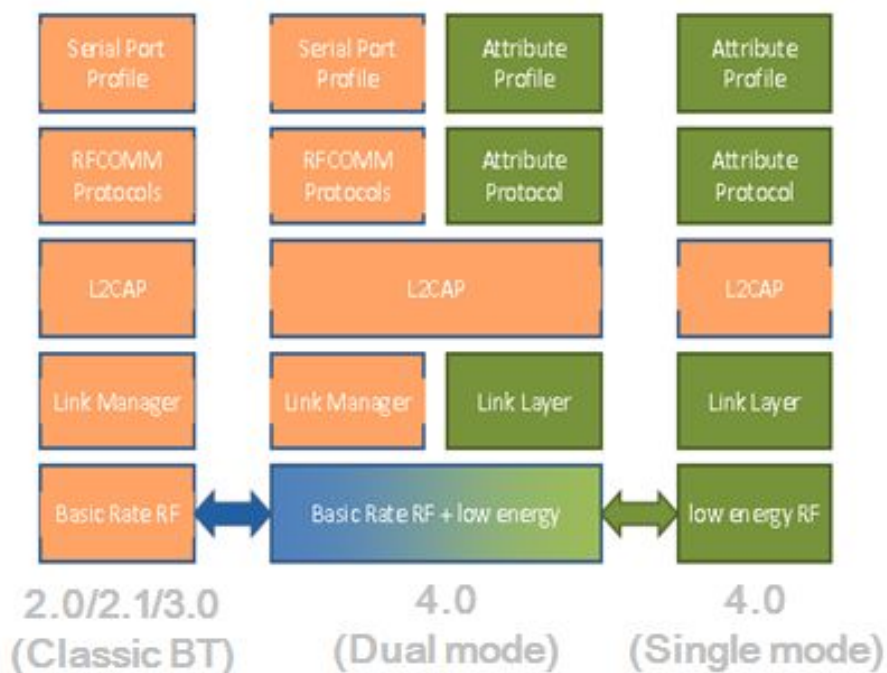

H/W BT

| | 2.0+EDR | 3.0 | 3.0+HS |
|-----------------------------|--|---|---|
| Max Throughput | 3Mbps | 3Mbps | 24Mbps if using AMP |
| Unicast connectionless data | Not support | Support | Support |
| Read Encryption key size | Not support | Support | Support |
| Enhanced power control | 1 level change Increase 1 level Decrease 1 level | New command added Increase to Max Decrease to Min | New command added Increase to Max Decrease to Min |

H/W USB 3.0

USB 3.0 HOST CONTROLLER



FEATURES

- Compliant with Universal Serial Bus 3.0 specification Revision 1.0, which is released by USB Implementers Forum, Inc
 - Supports the following speed data rate as follows; Low-speed (1.5 Mbps) / Full-speed (12 Mbps) / High-speed (480 Mbps) / Super-speed (5 Gbps)
 - Supports 2 downstream ports for all speeds
 - Supports all USB compliant data transfer type as follows; Control / Bulk / Interrupt / Isochronous transfer
- Compliant with Intel's eXtensible Host Controller Interface (xHCI) Specification Revision 0.96
- Support USB legacy function
- Compliant with PCI Express Base Specification Revision 2.0
- Supports ExpressCard™ Standard Release 1.0
- Supports PCI Express Card Electromechanical Specification Revision 2.0
- Supports PCI Bus Power Management Interface Specification Revision 1.2
- Operational registers are direct-mapped to PCI memory space
- Supports Serial Peripheral Interface (SPI) type ROM
- System clock: 24 MHz crystal or 48 MHz external clock.
- 3.3 V and 1.05 V power supply

| Characteristic | Super Speed USB 3.0 | USB 2.0 |
|------------------|---|--|
| Data rate | Super Speed(5G.0bit/s) | Low-speed(1.5Mbit/s), Full-speed(12Mbit/s) And High-Speed(480Mbit/s) |
| Signaling | Dual-simplex four wire differential signaling | Unidirectional data flow + negotiated directional bus transitions |
| Data Flows | Simultaneous bi-directional data flow | Unidirectional data flow + negotiated directional bus transitions |
| Cables | 6 Total 4 x <u>SuperSpeed</u> 2 x <u>non-SuperSpeed</u> | 2 x <u>low,full,high-speed</u> |
| Traffic Flow | Asynchronous | Polled |
| Packet Traffic | Explicitly routed | Broadcast to all devices |
| Power Management | Multi-level which supports idle, sleep, and suspend. | Port-level that has two levels of entry/exit latency |
| Bus Power | 50% more than USB 2.0 80% more with configured power | |

Software: Enhanced functions

The full features for multimedia work and play



Performance

High Performance for Multimedia
Enhanced CPU Performance
- Support Graphic Memory up to 2GB*
- Support HDD with enhanced speed (7200RPM)*
- Support HD+ Image (Blu-ray)*
Provide enhanced performance
Easy Speedup Manager
Provide a lot of information on the clear screen





Expandability

Support Full photo/video storage
Facilitate the multimedia data transfer easily
- **USB3.0** : 10 times speed
- **Easy File Transfer**
HD quality image on TV
Support connection between laptop and HD TV using HDMI Port



Multimedia

Watch video without external speaker
- Rich volume : 1.5Wx2 Speaker
- Surround sound effect : SRS Premium Sound
Webcam in the dark available
- Apply high sensitivity WebCam(1.3M)
- More bright and vivid image quality



* Factory Option

2.7. SW List

| Driver List | Version |
|---|--------------------------|
| Windows7-Marvell LAN Driver[GbE Fast] | 5.60.350.21 |
| Chipset(Huron-River) | 5.60.350.21 |
| Intel Rapid Storage Technology | 6.3.0.7000_PSTOBE_MM2007 |
| ASMEDIA USB 3.0 Host Controller Driver | 9.2.0.1016 |
| Elan Touch Pad Driver | 2.0.30.0 (U1U2 Disable) |
| Universal Scan Driver | 8.17.12.6598 No-WHQL |
| Universal Print Driver | 8.17.12.6598-No WHQL |
| Realtek ALC26X Windows7 Sound Driver | 6.0.1.6264LogoSRS10.3 |
| Realtek RTS5209 CardReader driver | 8.0.7.1_WHQL |
| AMD Windows7 HDMI Sound Driver | 7.33.1125.2010 |
| SW List | Version |
| WildTangent Game Console | 9.1.0.163 |
| Microsoft Office Starter 2010 | 1.0.0.11 |
| Windows Live | 1.3.0.0(32,64bit) |
| MS Bing Toolbar | 13 |
| MSN Homepage | 1.0.6 |
| Norton Internet Security (EXP: 60 days Trial, KOR : 1Year Trial) | 3.1.0.3509 |
| Norton Online Backup (30-day Trial) | 2.2.01 |
| Skype | 3.2.5.9 |
| Adobe Reader | 4.0.4.6 |
| Absolute Data Protection | 2.2.3.2 |
| Far filed Pick Up Solution | 2.1.1.1 |
| Kindle for PC(Amazon Reader) | 10.0.0.1046PV |
| Intel Appup | 18.0.0.128 |
| CJ | 18.1.0.37 |
| Kies | - |
| All Share | 20101114 |
| Intel Compute Continuum | 3.1.5 |
| Samsung Support Center | 2.2.2 |
| Samsung Recovery Solution (KOR) Samsung Recovery Solution (EXP) -Updated | 5.0.0.8 |
| Samsung Internet Service Short cut | 1.1.2.1 |
| Easy Partition Manager | 1.0.0.2 |
| Electronic Manual (E-Manual) | 3.0.0.17 |
| Samsung Theme (Samsung Wall Paper) | 1.2.0.8 |
| Samsung Theme (Samsung Screen Saver) | v.7600 |
| Survey Icon | 2.0.82.0 |
| AnyWeb | 1.0.1.4 |

2. Introduction

| | |
|--|----------|
| Universal Printer/Sacnner Driver | 1.0 |
| MultiMedia POP | 1.0.2.0 |
| Phone Share | 1.0.0.11 |
| Smartview (TV share) | 20101114 |
| Easy File Share (PC Share) | 3.1.5 |
| Easy Migration | 2.2.2 |
| Easy Software Manager | 5.0.0.8 |
| Software Launcher | 1.1.2.1 |
| Cyberlink Media Suite (3D or non 3D) | 1.0.0.2 |
| DDD Tridef Shell | 3.0.0.17 |
| Cyberlink Youcam | 1.2.0.8 |
| Dolby 3D | v.7600 |
| Easy Settings (Control center) | 2.0.82.0 |
| Mode Shift (Mode Change with Jog Dial) | 1.0.1.4 |

S/W (Previous SW/New SW): [For more information, product descriptions and installation training manuals refer to Chap.2]

S/W (Consultation stage of development) : Please refer that [Consulting Script] -> [Consultation]

2.8. System Setup (Bios Setup)

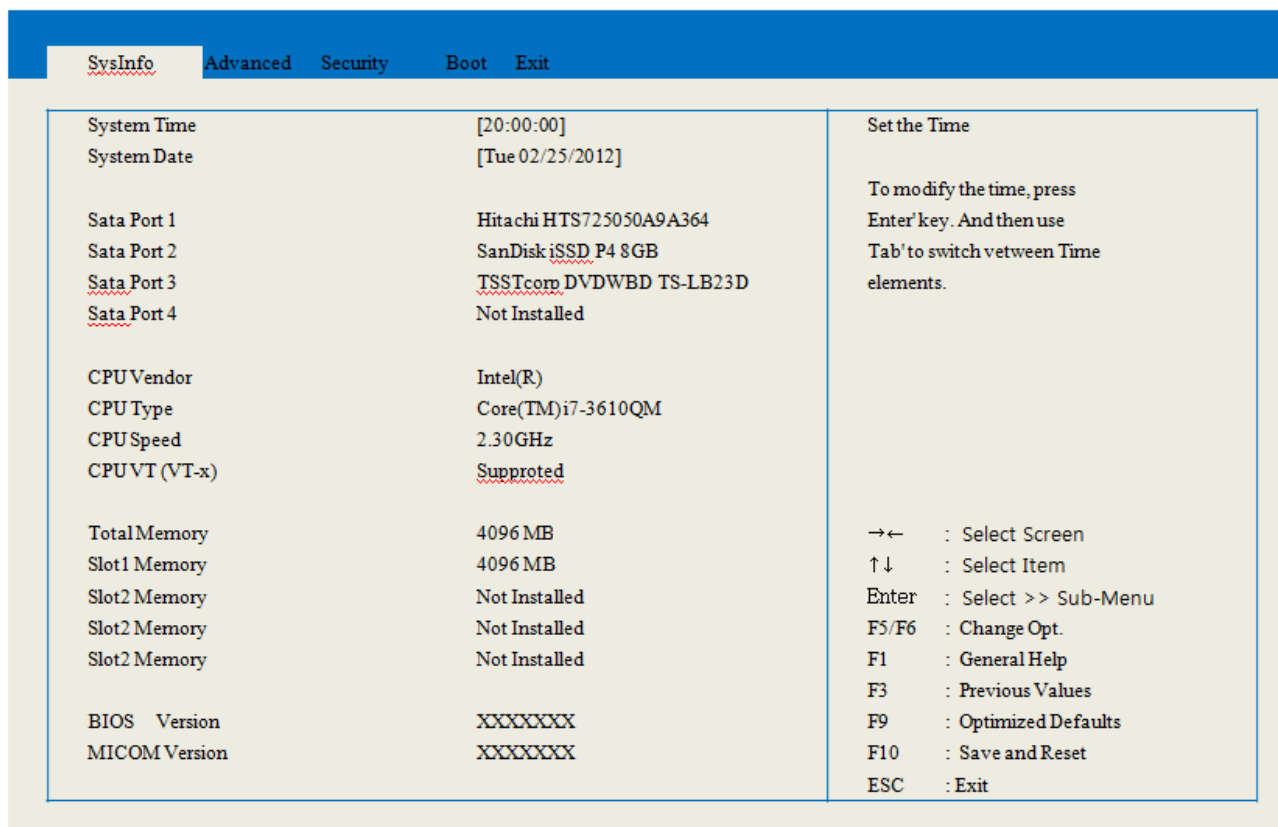

SATA Port 1

=> HDD model name is displayed in this item for SATA Port 1.

SATA Port 2

=> Express Cache Memory model name is displayed in this item for SATA Port 2.

SATA Port 3

=> HDD Or ODD model name is displayed in this item for SATA Port 3.

SATA Port 4

=> HDD Or ODD model name is displayed in this item for SATA Port 4.

Total Memory

=> Total memory size of the system.

Slot1 Memory

=> Memory size of the slot 1

Slot2 Memory

=> Memory size of the slot 2

Slot3 Memory

=> Memory size of the slot 3

Slot4 Memory

=> Memory size of the slot 4

ISSD

- 1. User can not setting. (Sata port2), SMT type
- 2. ISSD to speed the execution of the basic program will allow

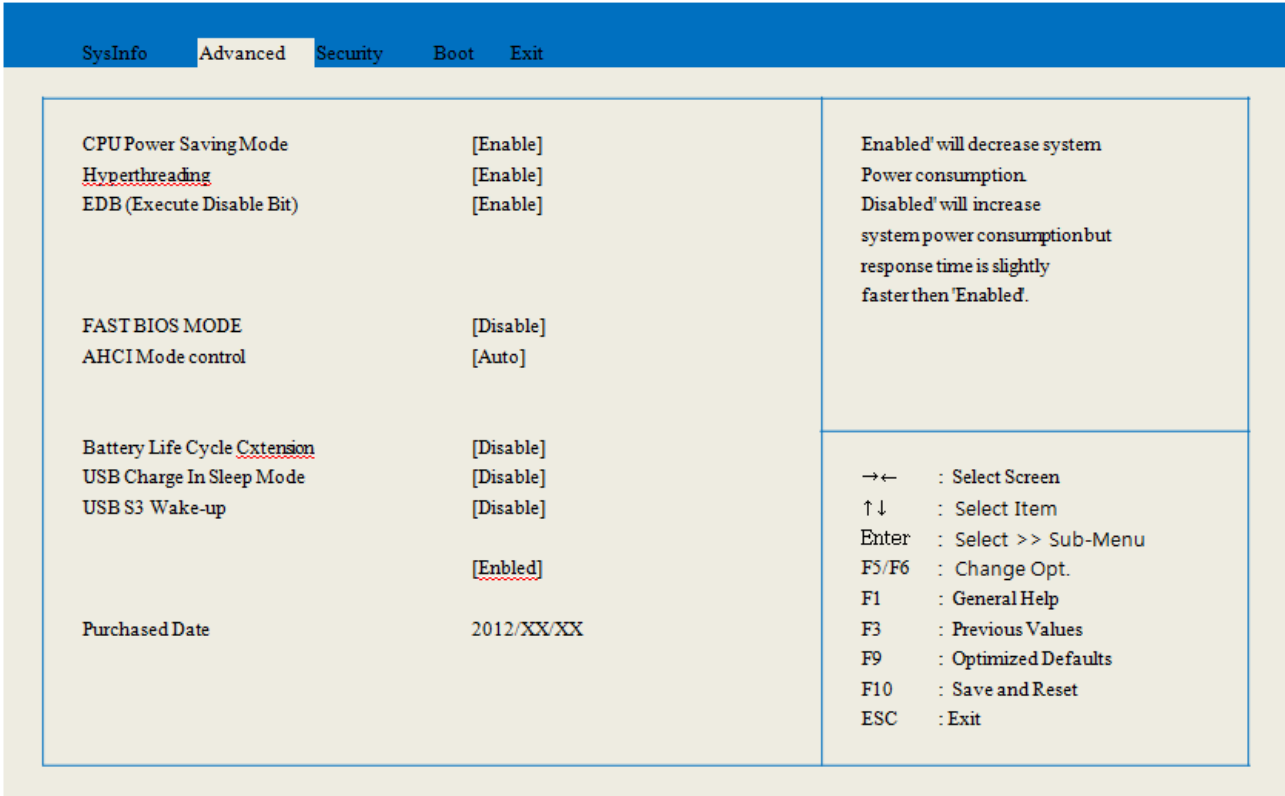

CPU Power Saving Mode

=> 'Enabled' will decrease system power consumption.

Hyperthreading

=> This selects whether Intel® CPU performance will improve.

EDB (Execute Disable Bit)

=> supports the Data Execution Prevention (DEP) feature. DEP is a set of H/W & S/W technologies that perform additional checks on memory to help prevent malicious code from running on a system.

FASST BIOS MODE

=> Legacy Universal Serial Bus (USB), SATA CD does not enable support for.

It is to reduce the BIOS POST hours

=> Not boot DOS mode. (Default ODD and USB memory.) The default setting when you purchase the [Disable]

AHCI Mode Control

=> AHCI mode. When you select Auto Mode, OS will automatically select AHCI mode.

(Win7-Enable, WinXP-Disable)

When you select Manual Mode, Set AHCI Mode allows the user to specify.

(Enable: Always use AHCI Mode, Disable: Always AHCI Mode disable)

Battery Life Cycle Extension

=> 'Enabled' means that the system will charge the battery up to 80% for extending the battery life cycle.

=> 'Disabled' means that the system will charge the battery up to 100%

USB Charge In Sleep Mode

=> 'Enabled' means that the system supports the USB charge feature at the port which has the special icon, in the sleep mode.

=> 'Disabled' means that the system doesn't support the USB charge feature in the sleep mode.

USB S3 Wake-up

=> Select Enabled to support that system can be waked up from ACPI S3 state by USB activities.

=> Select Disabled not to use USB wake-up capability from ACPI S3 state.

(Vista/Win7 Only.)

Software Manager Auto-Install

=> Easy Software Manager is an application for effortless software and driver installation. 'Enabled' Supports auto-installation of Easy Software Manager 'Disabled' turns off the auto – installation of Easy Software Manager.

Purchased Date

=> Purchased date is displayed after 10 times boot.

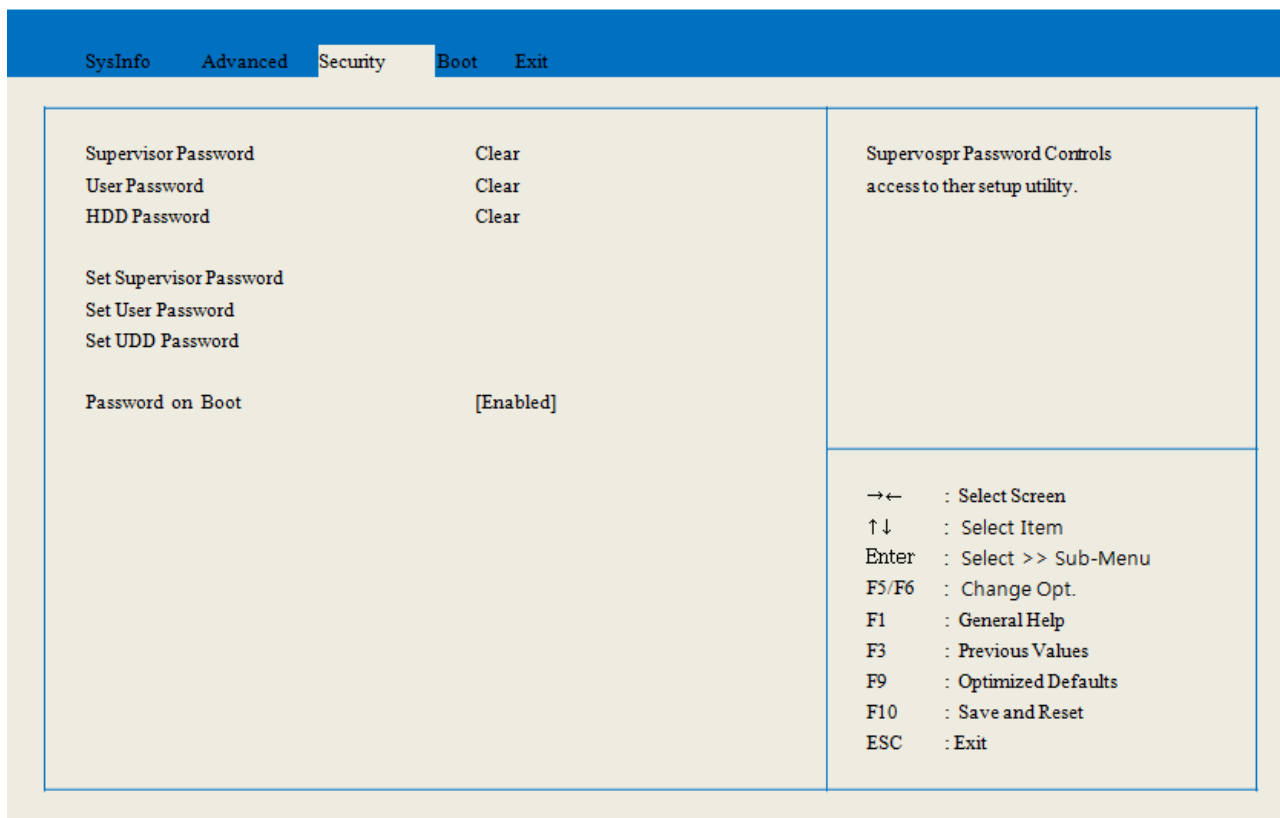

Set Supervisor Password

=> Supervisor Password controls access to the setup utility.

Set User Password

=> User Password controls access to a few items in the setup utility.

Set HDD Password

=> User can set a password of a HDD.

Password on Boot

=> Supervisor Password controls access to system boot.

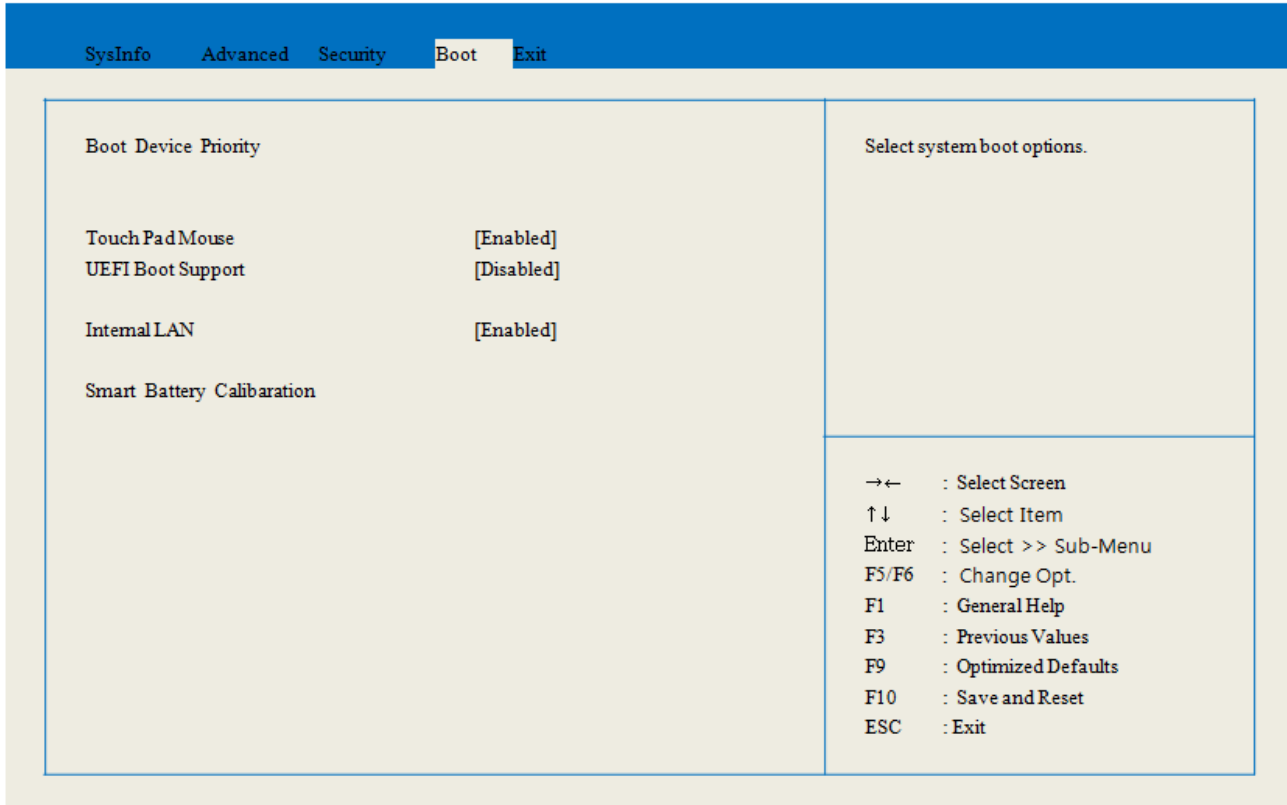

Boot Device Priority

=> Select system boot options.

Touch Pad Mouse

=> 'Disabled' prevents installed Touch Pad mouse from functioning, but frees up IRQ 12. 'Enabled' forces the Touch Pad mouse to be enabled.

UEFI Boot Support

=> Enabled means that the system can boot Legacy PS or UEFI OS.

Disabled means that the system can boot Legacy OS only.

Internal LAN

=> "Enabled" will allow the internal LAN to operate correctly.

Smart Battery Calibration

=> If you select this option, the system battery will be discharged completely for more accurate battery level detection. This option only works with SMART battery.

ISSD

1. When setting the boot option is raised to a higher ISSD cursor is blinking.
2. Please set up the boot option is set to a sub

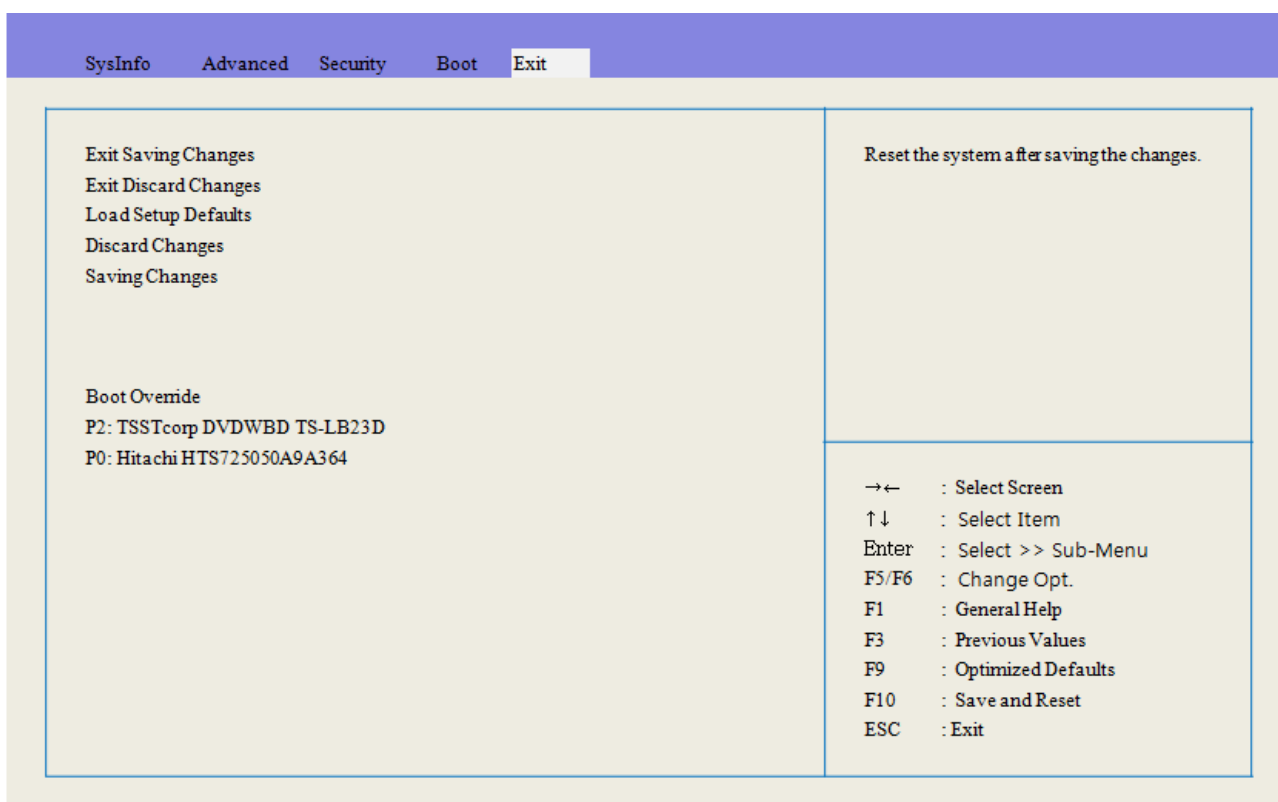
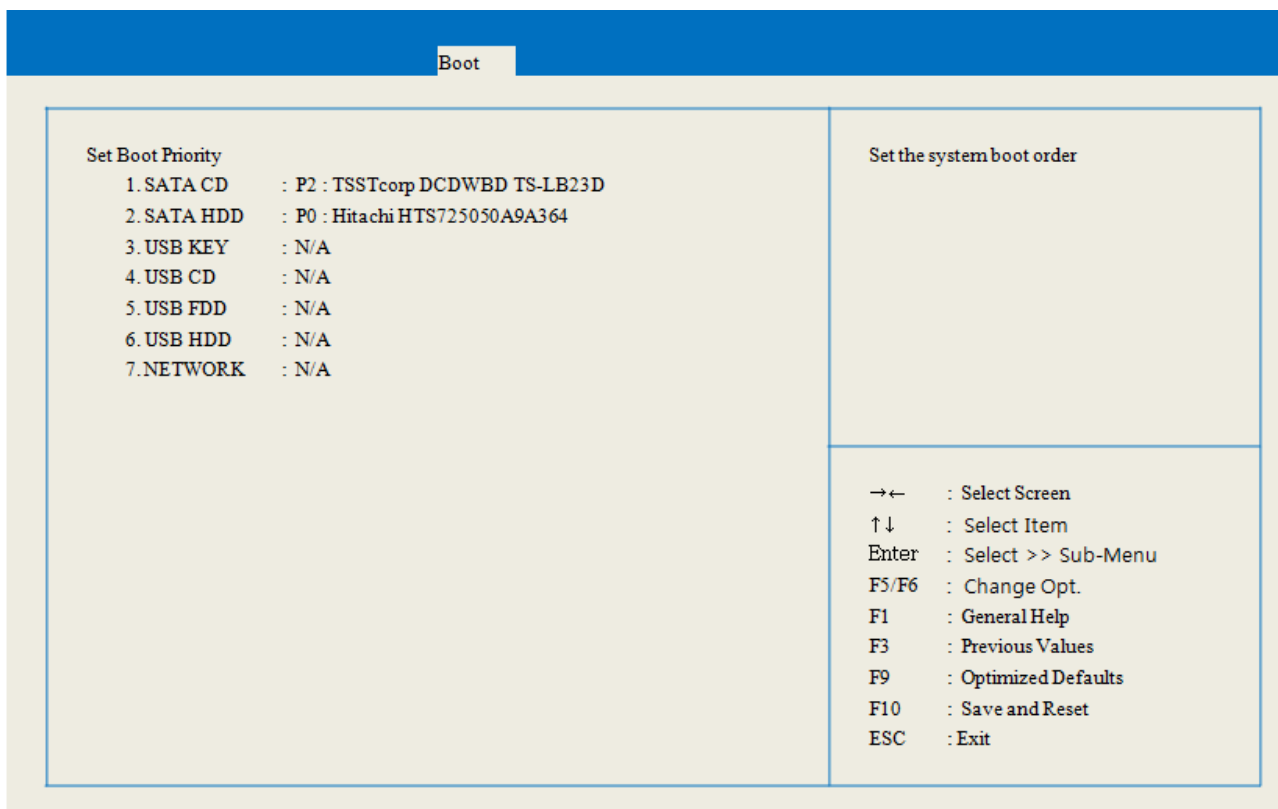

Exit Saving changes

=> Exit System Setup and save your changes to CMOS.

Exit Discarding Changes

=>Exit utility without saving Setup data to CMOS.

Load Setup Defaults

2. Introduction

=> Load default values for all SETUP items.

Discard Changes

=> Load previous values from CMOS for all SETUP items.

Save Changes

=> Save Setup Data to CMOS.

Boot Override

=> Boot with selected device

2.9. Main Board Information

H/W Basic



Basic Items / Eléments livrés de série / Hauptkomponenten / Elementos básicos / Componenti principali

}



Computer
 Ordinateur
 Computer
 Ordenador(computador)
 Computer



Standard Battery
 Batterie standard
 Standardakku
 Batería estándar
 Batteria standard



AC Adapter
 Adaptateur CA
 Wechselstromadapter
 Adaptador CA/CC
 (Fuente de alimentación)
 Adattatore CA



Power Cable
 Cordon d'alimentation
 Netzkabel
 Cable de alimentación
 Cavo di alimentazione

| | PIC | ITEM | CODE | Q'ty | Ver |
|---------------|---|--------------------|--------------------------|------|-----|
| MANUAL |  | Battery | BA43-00319A (5900mAh) | 1 | BLK |
| |  | Power Cord | 3903-000452 | 1 | |
| |  | AC Adapter | BA44-00280A 200W | 1 | |
| |  | Installation Guide | BA81-08874A | 1 | |
| |  | CDS Sheet | BA99-14999A | 1 | |

H/W Option Component

700G7C the following optional components to add or replace.

The type of component can be added later.

- 3D glasses(option)
- HDD
- ODD
- LCD
- CPU
- MEMORT
- WLAN

3D glasses : BA68-07572A

Package Contents

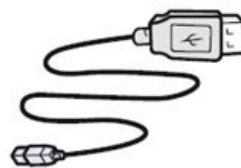
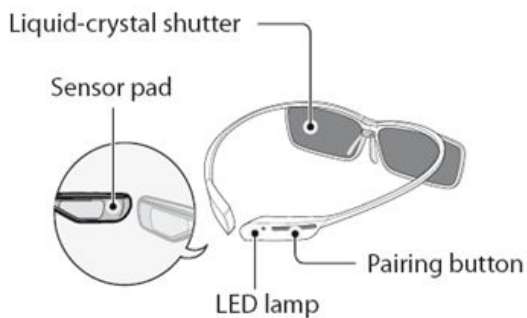

Micro USB Cable





Cleaner

| HDD | | |
|---|------------------------|---|
|  | | |
| BA59-02873A | 500G(7.2_HGST) | 500GB, HTS725050A9A364, S16, 383, H16, C63, 9.5mm, 2.5inch, SATA, 7200RPM, 250G/P, FDB |
| BA59-02980A | 750GB(7.2_HGST) | 750GB, HTS547575A9E384, S16, 383, H16, C63, 9.5mmH, 2.5inch, SATA, 5400RPM, 375G/P, FDB |

| ODD | | |
|--------------------|-----------------------|--|
| DVD | | |
| BA59-02834A | DVD-SUPERMULTI | TS-L633J, 8X, 170, SATA, 1.5MB, 6.5W, 5V |
| BA59-02828A | DVD-SUPERMULTI | DS-8A5SH, 8X, 130ms, SATA, 1.5MB, 6.5W, 5V |
| Blue-ray Combo | | |
| BA59-02991A | BD-COMBO | TS-LB23D, 6X, 250MS, SATA, 2M, 9.6W, 5V |

| LCD PANEL | | |
|---|-------------------------|---|
|  | | |
| BA59-02996A | LCD PANEL-173FHD | LCD PANEL-173FHD_3D; LTN173HT02-C, 3D, 17.3 |

| CPU | | |
|---|--------------------------|---|
|  | | |
| 0902-002710 | IC-MICROPROCESSOR | FF8062700999401, 2.1GHz, rPGA, 988P, TR, Plastic, 1.05V, 45W, 0to+100C, 6MB, i7-2630M |

| Memory | | |
|---|-----------------------|---|
|  | | |
| 1105-002211 | IC-DRAM MODULE | M471B5273CH0-CH9, DDR3 4G SODIMM, 4GByte, 512Mx64bits, SODIMM, 204P, 67.6x30mm, 8ns, 1.5V, +-0.075V, 0to+95C, 320mA, TR |
| 1105-002217 | IC-DRAM MODULE | M471B5773CH8-CH9, DDR3 2G SODIMM, 2GByte, 256Mx64bits, SODIMM, 204P, 67.6x30.00mm, +-0.075V, 0to+95C, 280mA, TR |

WLAN Combo. Module



TOP

Bottom

| | | |
|--------------------|--|-------|
| BA59-02889A | IEEE 802.11 bgn Standard 2x2 WLAN/BT Combo | INTEL |
|--------------------|--|-------|

3. Desassembly and Reassembly

3.1. MainSystem

- 1. Turn off the power and remove the Battery before disassembling the system.

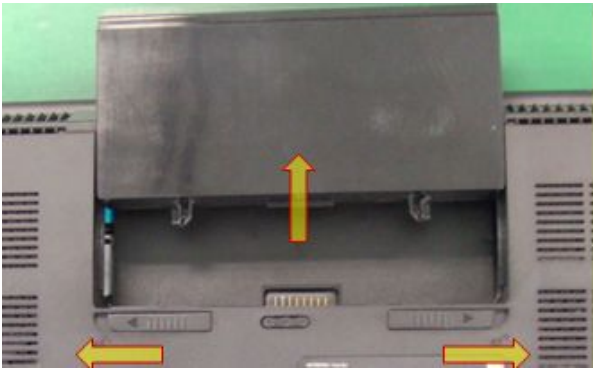

- 2. Remove the dummy-SD CARD before disassembling.



- 3. At the bottom side, Remove 10 Screw to disassemble .

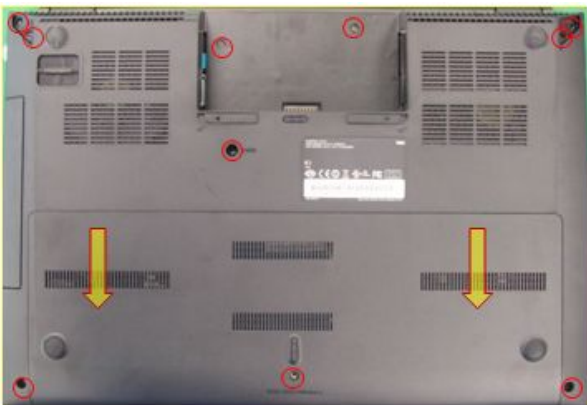

- 4. Open the HDD door to disassemble. And remove 12 Screw & HDD protect cover.

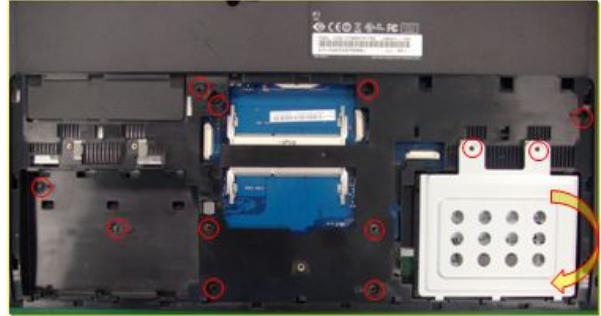

- 5. HDD Removal : Disconnect the HDD Cable and remove the HDD from system.



- 5-1. Remove remain 2 screws to disassemble.



6. Disassemble ODD from system. Pull ODD to left.

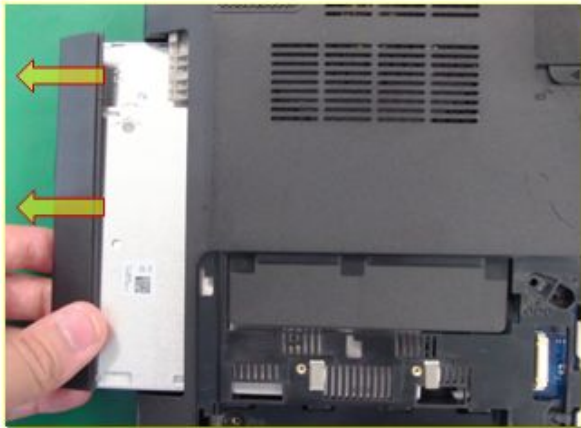

- 6-1. Remove the 2 remain screw.



7. Push each point with pinset, and flip the keyboard to disconnect the FFC Cable.



- 7-1. After Reverse the Keyboard, Disconnect two FFC Cable. This connector is straight type. Before remove FFC Cable, pull the connector.

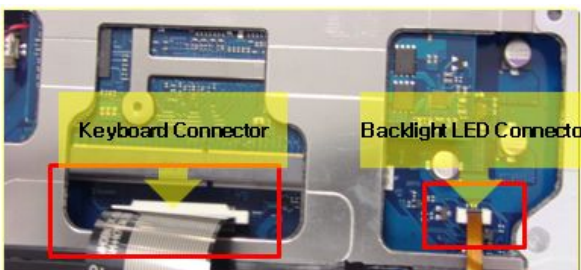

8. Remove 3 screws, at ○ point. Disconnect 2 FFC Cable & 2 speaker Cable, at □ Point. After this, open the top assy from bottom.

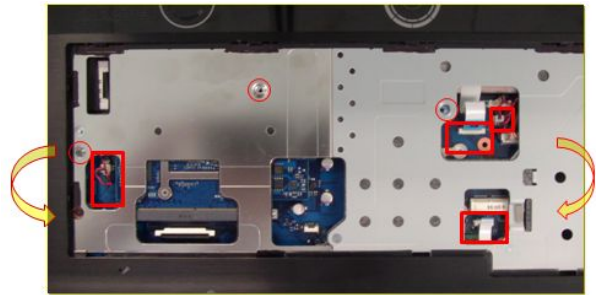

9. Remove 7 screw to disassemble.

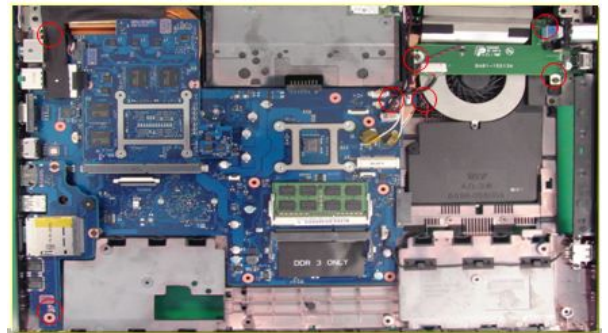

10. Remove 2 Cables, DC Cable & LCD Cable

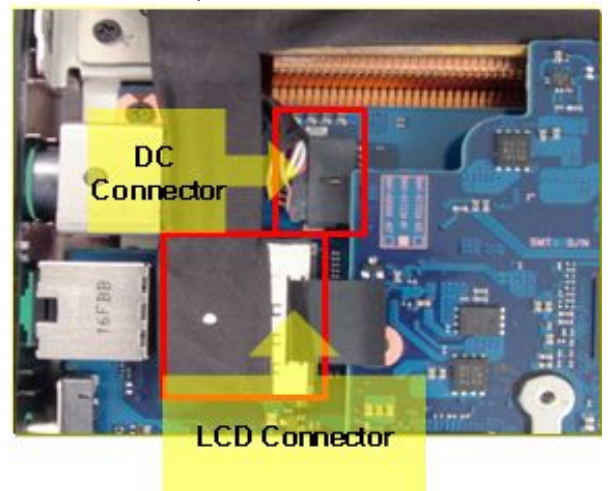

11. Remove 1 screw to disassemble. and Disconnect Antenna cable from WLAN Module

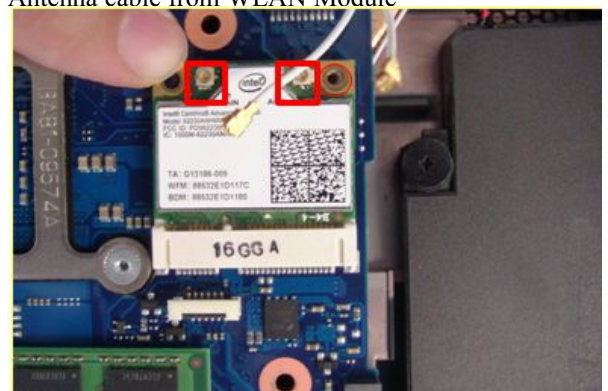

12. Disconnect 3 cable from M/B.

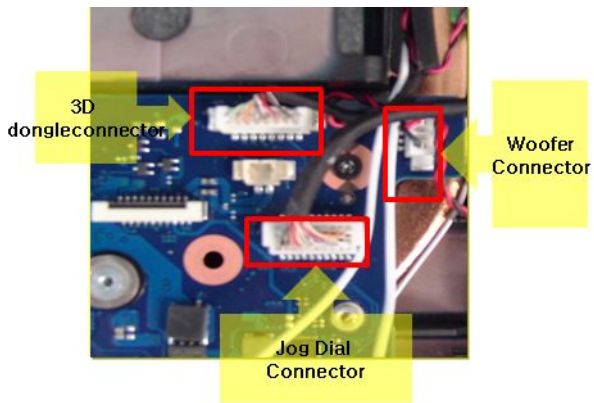

13. After disconnect, you can separate M/B from Bottom ASSY. And Disconnect Fan Cable and Heat Sin.

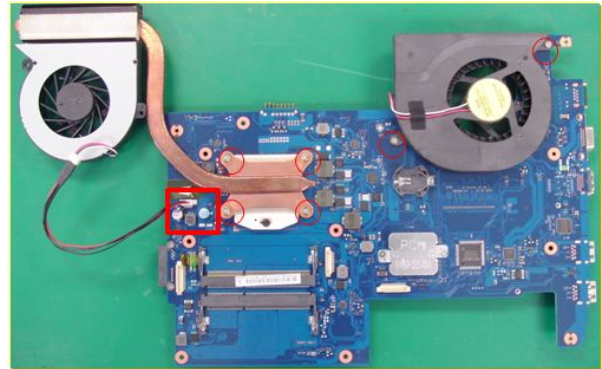

3.2. LCD Part

1. First remove 2 rubber and remove 2 screw.



2. Pull the LCD bezel from top side, then it can be Separated from LCD Assy.



3. Remove all screw and remove LCD Bracket. And Lift the LCD From LCD BACK ASSY.

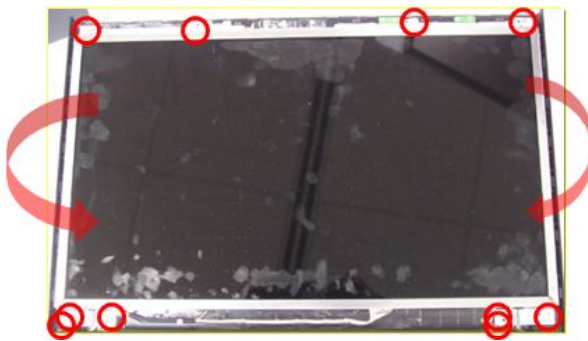

4. Disconnect the LCD Cable from LCD. And disassemble LCD Bracket from LCD.



5. To disassemble the SAMSUNG LOGO lighting Sub Board, just dispatch it from LCD BACK.

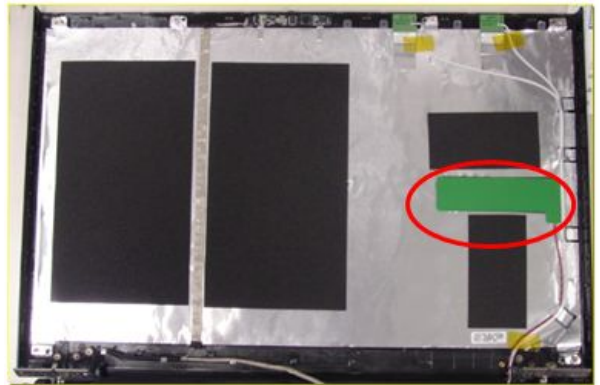

4. Trouble shooting

4.1. General spec

Tools used for repairing the product.

- System Diagnostics Disk
- MS-DOS Booting Disk
- System Diagnostics Card
- Screwdrivers (+, —)
- Tweezers
- Multi-meter
- Oscilloscope
- Logic Analyzer

Replace Units (FRU: Field Replaceable Unit)

- DDR3 RAM Module
- 2.5" SATA HDD
- ODD – Super multi Dual layer drive or DVD Combo Drive or Etc.
- Wireless LAN Module
- Key Board
- System Fan
- Touch Pad
- LCD Panel
- Camera Module
- Main Board
- Harness Cable
- - Touchpad FFC, MainboardFFC, LCD+Camera Cable, Wireless LAN Antenna 2types, Mic, Power-in

4.2. Debugging Flow Chart

※Training manual how to use the side of the fault diagnosis please refer.

Debugging Flow of our company computer product does same as between product universally.

Refer to attachment Debugging Flowchart more content



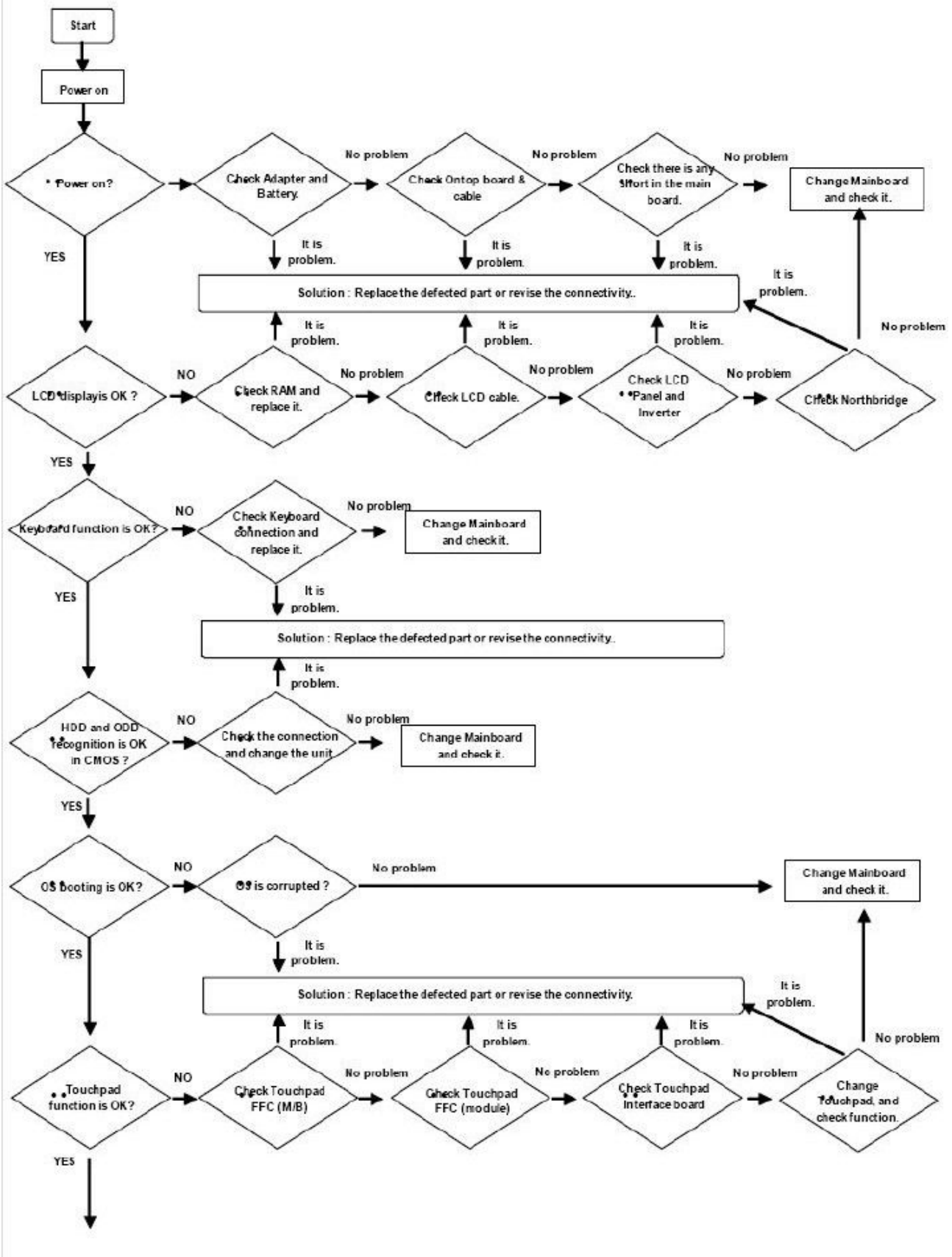

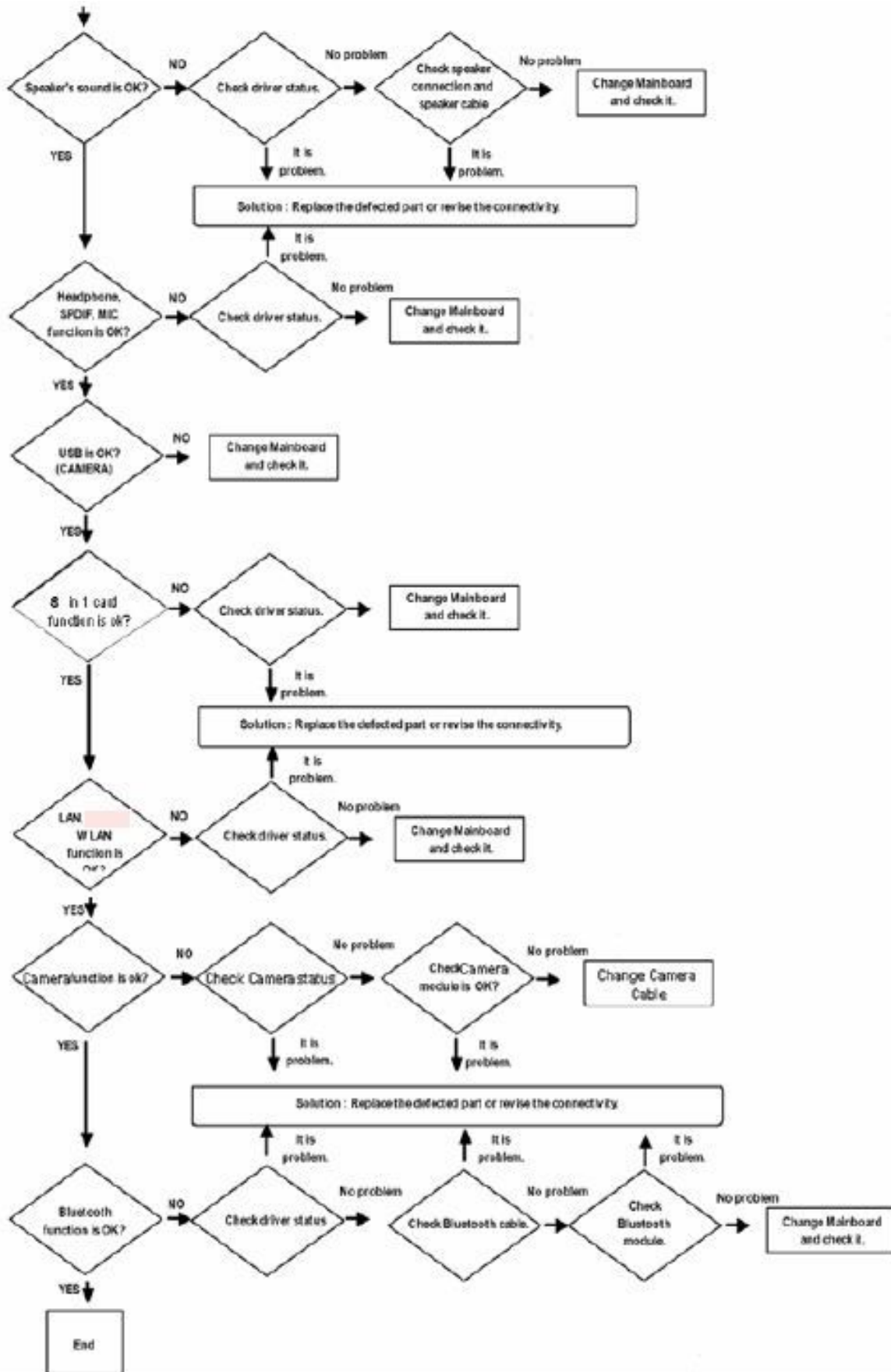

4.3. System Diagnosis

System Diagnostics Card

The Diagnostics Card shows the system operations during the POST (Power On Self Test) in a 2 digit hexadecimal number by connecting the cable to the 10 pin connector below the PCMCIA slot after separating the Top part. The card is used to evaluate the reason for the malfunction without disassembling the system when the system malfunctions and to test if the system operates normally after replacing a defective FRU.

How to use

<VGA Port VGA Dongle plugged in and then connect to the 80 Port.>

Debugging Code

In general, if a defect of the circuit or part is detected during the system test, the system stops at a particular code. The error codes for each part of the system are listed in the following table

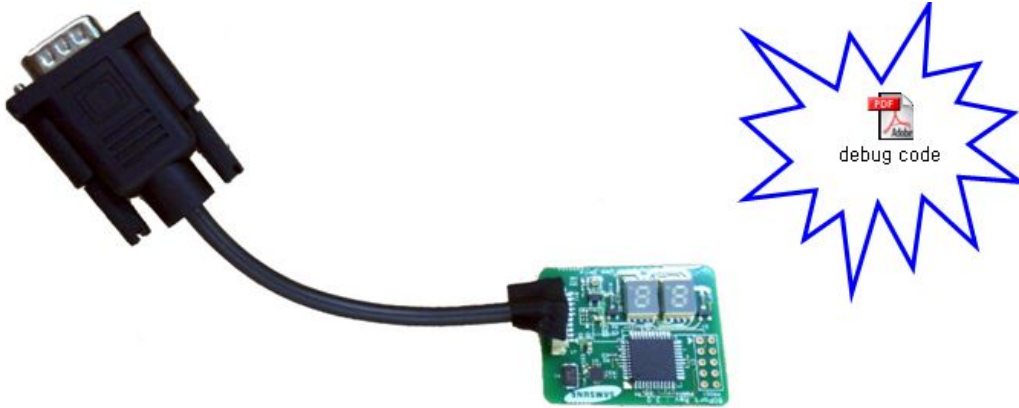

4.4. Diagnostic Program

□ WinDiag4 (lease Refer to the Training manual chapter4. Trouble Shooting.)

- 1) WinDiag4 is a Diagnostic tool that tests overall computer's H/Ws and functions for Windows 7.
- 2) Precondition : UAC(User Account Control) should be disabled.
- 3) Installation : When you double-click SvcDiag.bat file, this program will be installed in C:\WinDiag4. After installation, WinDiag4 will automatically start testing the system.
- 4) Uninstallation : After terminating the program, Just delete C:\WinDiag4 folder.

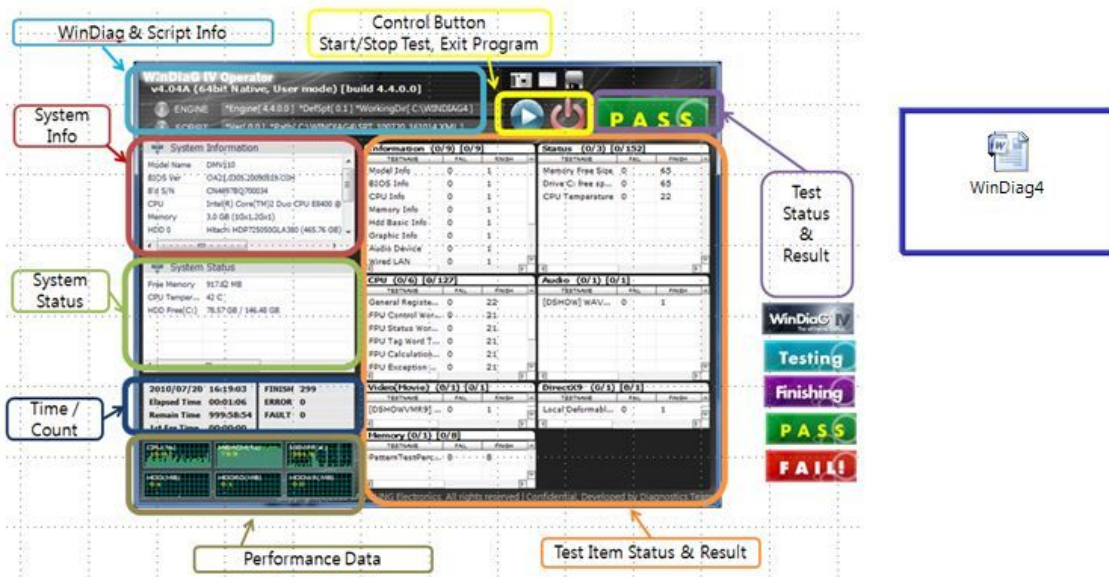

| ① Status (2/7) [12/28] | | | | | | | |
|------------------------|------|--------|-------|----------|-------|-------|-----|
| TESTNAME | FAIL | FINISH | FAULT | A/S TIME | STATE | PROG. | CO |
| Memory Free Size | 0 | 6 | 0 | 0.11 | 06 | n/a | 015 |
| Drive C: free sp... | 0 | 6 | 0 | 0.08 | 06 | n/a | 016 |
| CPU Temperature | 0 | 2 | 0 | 0.02 | 01 | n/a | 017 |
| FAN Status | 1 | 1 | 0 | 1.51 | 02 | n/a | 018 |
| HDD 0 Tempera... | 0 | 2 | 0 | 0.34 | n/a | n/a | 019 |
| Battery Status | 11 | 11 | 0 | 0.04 | 02 | n/a | 020 |
| Heating System | 0 | 0 | 0 | 0.0 | 02 | n/a | 021 |

◇ Group Info : It displays Group Item Name and Test Count. If there is any FAIL or FAULT in the Group Item, the color of title will be changed to Red.

◇ Test Item : It displays Test items included in this Group. If there is any FAIL or FAULT in this test item, the color of the test item will be changed to Red.

4. Trouble shooting

□ **Pyxis** (lease Refer to the Training manual chapter4. Trouble Shooting.)

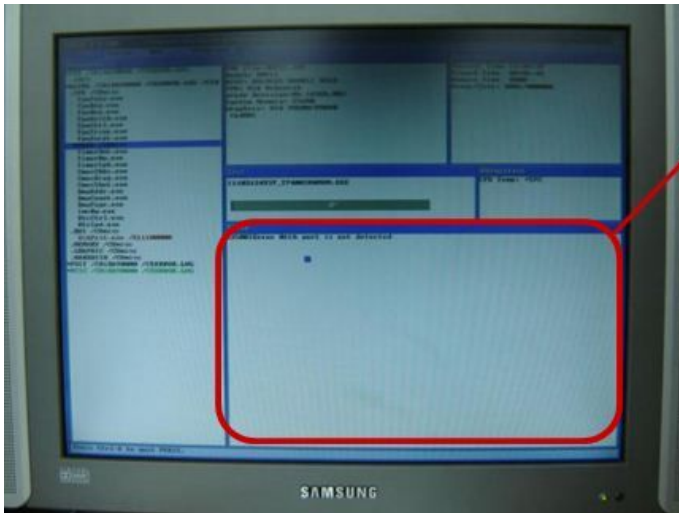

- 1) Pyxis is a software that diagnose computer's H/W components in DOS environment.
- 2) How to use Pyxis
 - First, make Dos bootable USB memory or CD.
 - Copy all released files to the Dos bootable device.
 - After you boot using the Dos bootable device, Select the menu that you want to execute.



If any error happen during the test, you can look at error log in this window.

4.5. Hardware Troubleshooting

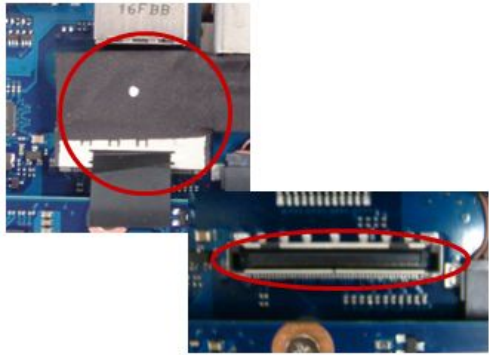
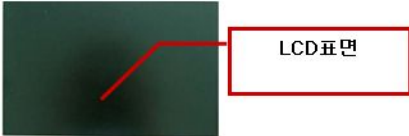
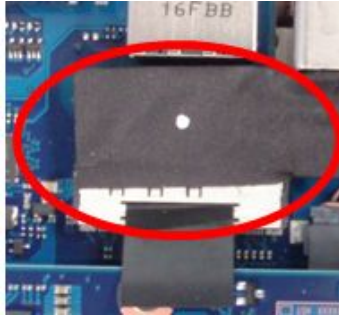
4.5.1. LCD

| 1. The screen is dark or the colors of the screen are distorted. | |
|--|--|
| 1) Check the connection status <ul style="list-style-type: none"> • LCD Module LCD Cable • LCD Cable and Main board LCD Connector → Connect Cable and Connector perfectly |  |
| 2. Replace the LCD cable | Defectiveness confirmation |
| 3. Check if there is a part of the LCD that is bent or broken due to impact → Replace the LCD |  |
| 2. No picture appears on the screen. | |
| 1) Check the connection status <ul style="list-style-type: none"> • LCD Module LCD Cable • LCD Cable and Main board LCD Connector → Connect Cable and Connector perfectly → LCD cable replace |  |
| 2. Check if the System LED of the main board is blinking |  |
| 3. Check if the memory module is out of order | Re-fixation or Replacement other Memory Card . |
| 4. Check if the Power button can be normally pressed. | Check operating or not |

4. Trouble shooting

3. The LCD blinks while the system is in operation.

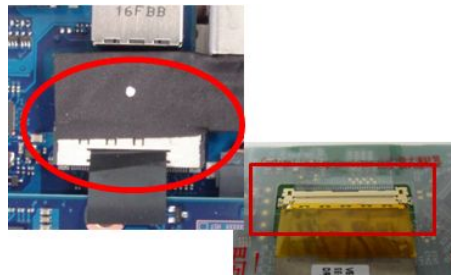

1. Check if there is a magnetic body near the touch pad button or the system or check if there is an exterior defect to the LCD.







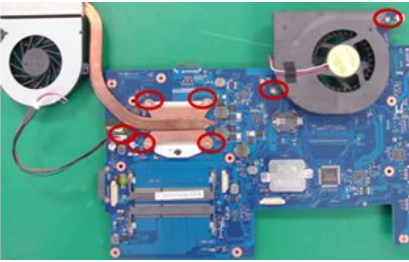

2. Replace the LCD cable



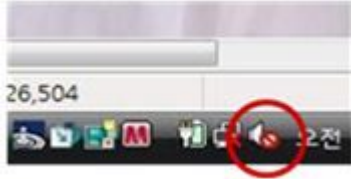

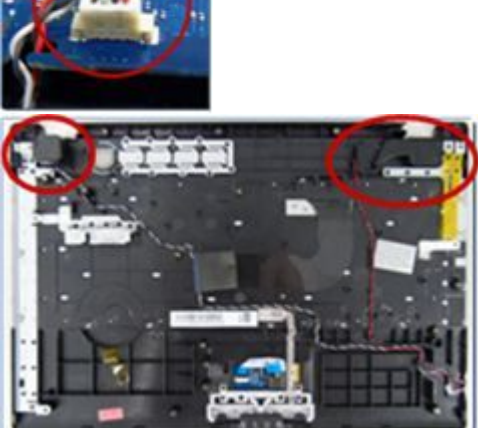

Defectiveness confirmation

4.5.2. Main System



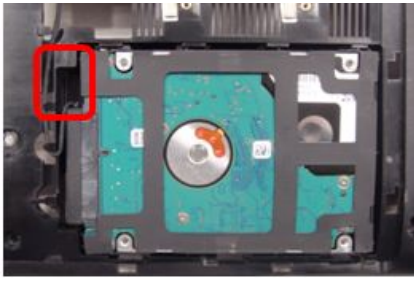

| | |
|---|---|
| 1. The system is not turned on. | |
| 1. Check if the AC adapter LED is lit and if the adapter is properly connected to the system. | <p>Check the adapter LED.</p>  |
| 2. If the AC adapter is not connected, check the charge status of the battery. Even if the battery is charged, if the remaining battery charge is too low, the system may not be turned on. | <p>Check the AC Adapter connection the remain of battery</p>  |
| 3. Check if there are any alien substances in the Power switch. if have, change the LED. |  |
| 4. Replace Main Board | Check operating or not. |
| 2. the system does not boot or immediately turns off after being turned on. | |
| 1. Since this may be a short circuit in the system. | <p>Disconnect the power immediately, disassemble the system and check if there are any conducting alien objects such as a screw inside.</p> |
| 2. Check the connection status between the CPU and the RHE. |  |
| 3. Replace the memory module. | * Check if it is out of order. |
| 4. RTC Reset. | * Check if it is out of order. |
| 5. Replace Main Board. | * Check if it is out of order. |
| 3. There is no sound from the speaker. | |



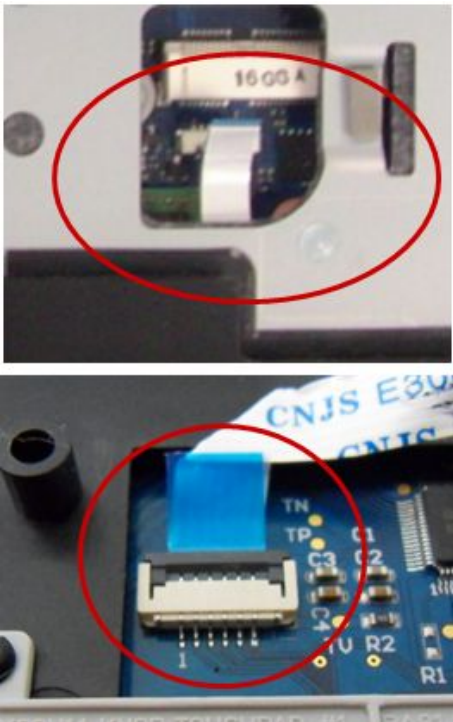
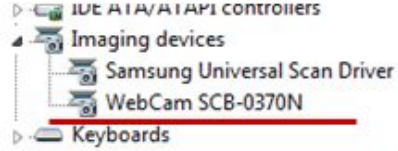

4. Trouble shooting

| | |
|--|--|
| <p>1. Check if the sound is muted after booting up Windows. → Fn + F6 (Mute cancellation)</p> |  |
| <p>2. Control panel confirmation. → Speaker Setting.</p> |  |
| <p>3. Check the connection status of the speaker cable and check if the speaker is out of order.</p> |  |
| <p>4. Check if there is a magnetic object near the speaker.</p> |  |
| <p>5. Replace Main Board.</p> | <p>* Check if it is out of order.</p> |
| <p>4. I cannot hear sound through the headphones.</p> | |
| <p>1. Check if the sound is muted after booting up Windows. → Fn + F6 (Mute cancellation)</p> |  |
| <p>2. Control panel confirmation → Speaker Setting.</p> |  |
| <p>3. Turn the volume up. → Fn key volume adjustment</p> |  |

| | |
|---|--|
| <p>4. Check the Headphone jack.</p> |  |
| <p>5. Replace Main Board.</p> | <p>* Check if it is out of order.</p> |
| <p>5. external/Internal microphone does not work normally.</p> | |
| <p>1. Check the audio driver settings and change them if necessary</p> |  |
| <p>2. Check the connection status of the MIC connector and check if the speaker is out of order</p> |  |
| <p>3. Check the Mic jack.</p> |  |
| <p>4. Replace Main Board.</p> | <p>* Check if it is out of order.</p> |
| <p>6. The HDD is not recognized.</p> | |
| <p>1. Check the connection status of the HDD connector. fixup HDD, check whether the system can be found. if not,change the connector on the motherboard and check again.</p> |  |
| <p>2. If the 'Operating system not found' message appears during the booting process even though the HDD is recognized by CMOS, the operating system of the HDD may be corrupted or the HDD is out of order</p> | <p>Format the HDD and reinstall the operating System Replace the HDD with a new one.</p> |
| <p>7. HDMI port does not work normally.</p> | |
| <p>System manager confirmation . (Video / Sound / Controller confirmation) → HDMI driver Re-install.</p> |  |

4. Trouble shooting

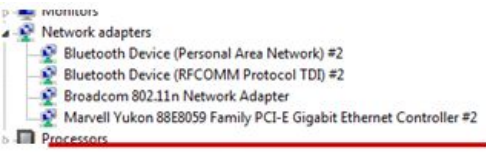

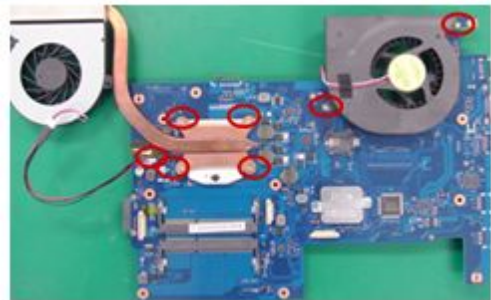
| | |
|---|--|
| <p>2. Check the Display Manager work normally. → Display Manager program Re-install.</p> |  |
| <p>3. Check the Control panel. → Check HDMI section enable.</p> |  |
| <p>Replace Main Board.</p> | <p>* Check if it is out of order.</p> |
| <p>8. Touch Pad does not work normally.</p> | |
| <p>1. Check the connection status of Touch Pad FFC. 2. Check the connection status of Touch Pad cable. 3. Check the connection status of Touch Pad Module. 4. Replace Touch-Pad Module.</p> |  |
| <p>9. Camera does not work normally.</p> | |
| <p>1. Check the driver status of Camera (Check the system manager)</p> |  |
| <p>2. Check the connection status between LCD Cable and main board.</p> |  |

| | |
|--|--|
| <p>3. Check the connection between Camera cable and Camera module</p> |  |
| <p>4. Replace Camera module</p> | <p>* Check if it is out of order.</p> |
| <p>5. Replace Main Board</p> | <p>* Check if it is out of order.</p> |
| <p>10.WLAN does not work normally.</p> | |
| <p>1. Check the damage status of WLAN Cable → Replace WLAN Cable</p> |  |
| <p>2. Check the driver status of WLAN → Re-Install WLAN driver.</p> |  |
| <p>3. Check the damage status of WLAN Jack. → Replace WLAN module.</p> |  |
| <p>4. Replace Main Board.</p> | <p>* Check if it is out of order.</p> |
| <p>11. The Fan does not work normally.</p> | |
| <p>1. Check the system by using SAFC(Samsung Advanced Fan Control)program.</p> | <p>* Tool Program reference</p> |
| <p>2. Check the connection status of Heat sink → Screw fixation 6EA</p> |  |

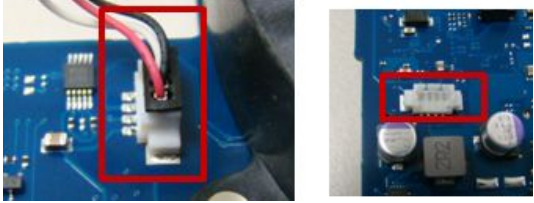
4. Trouble shooting

| | |
|---------------------------------------|--|
| 3. Check the connection status of FAN |  |
| 4. Replace FAN | * Check if it is out of order. |
| 5. Replace Main Board. | * Check if it is out of order. |

3D Function error

| | |
|--|---|
| 3D Function does not work normally. | |
| 1. Check the connecting status between cable and 3D BT Module. |  |
| 2. Check the connection status between cable and Main Board . |  |
| Change Module | * Check if it is out of order. |
| Check the 3D glasses battery | * Check if it is out of order. |

Mode dial error

| | |
|--|--|
| Mode dial does not work normally. | |
| 1. Check the connecting status between cable and Mode dial board |  |

| | |
|---|--|
| 2. Check the connection status between cable and Main Board |  |
| 3. Change Module | * Check if it is out of order. |
| 4. Check the cable | * Check if it is out of order. |

4.6. RTC Battery Reset



RTC Reset

- Disassemble the system.
- Find RST Reset node next to the Mainboard Memory slot.
- Using the tool like as tweezer, connect two nodes for about 20~30sec. Then Bios rom will be reseted.

Caution
password is not released when
remove and reconnect the
cable
(Chipset limitation)
If you lose your password,
AS A separate contact centers.

4.7. CPU FAN Control

CPU FAN Troubleshooting

If FAN doesn't work well

- 1) Check thermal Fan locked well
- 2) Check FAN cable plugged well
- 3) change FAN.

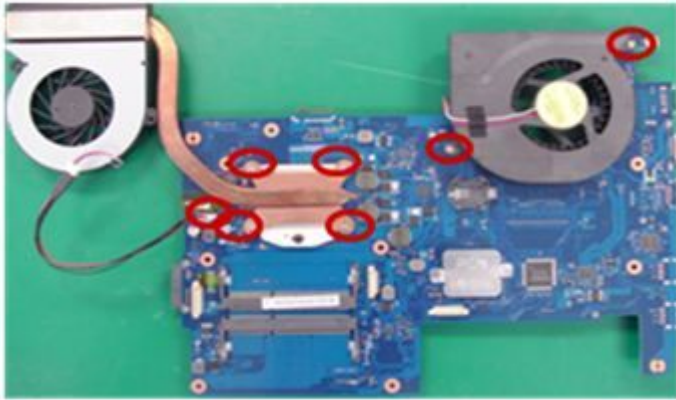

CPU FAN Troubleshooting

One can turn the fan on & off and check the fan's operational conditions without system disassembly.

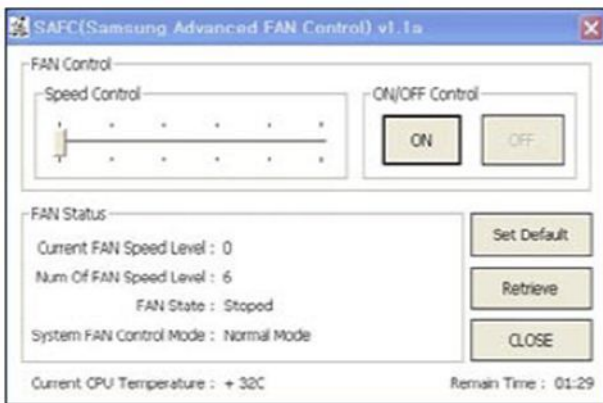

그림(1) Fan off 상태

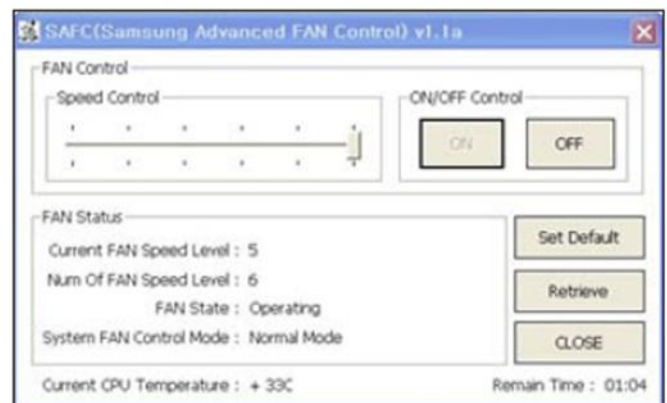

그림(2) Fan on 상태

- SAFC's default setting is "Fan off" or "Minimum Fan Speed".
 - Press "ON" in "ON/OFF Control" Fan is turned on to maximum fan speed
 - Press "OFF" in "ON/OFF Control" Fan returns to default setting.

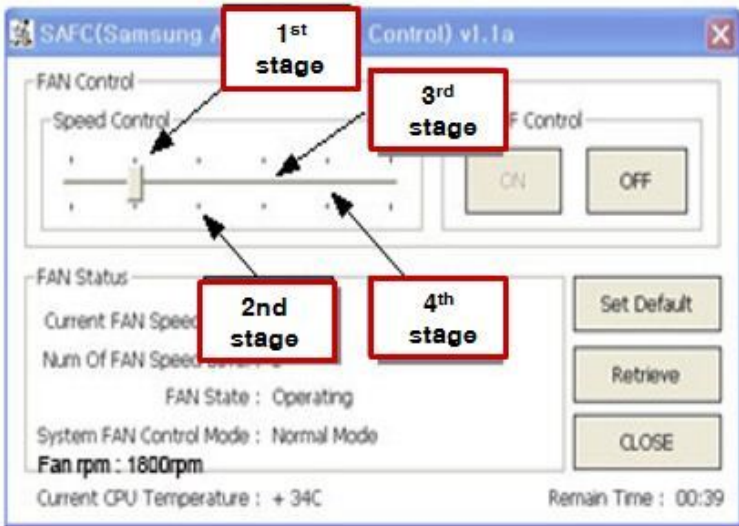

Fan Voltage Measurement

- Read Fan RPM indicated in SAFC.

Fan Voltage Pass/Fail determination

- If Fan RPM satisfies "rpm spec +/-10%", then Fan test is "PASS" .

CPU FAN Troubleshooting

(1) Normal mode

| Mode | 14" Fan Speed | 15"/17" Fan Speed |
|---------|---------------|-------------------|
| OFF | 0 | 0 |
| Low | 2048 | 2119 |
| Middle1 | 2318 | 2297 |
| Middle2 | 2587 | 2482 |
| Middle3 | 2926 | 2700 |
| Middle4 | - | 2926 |
| High | 3511 | 3321 |

(2) Silent Mode (Auto)

| Mode | 14" Fan Speed | 15"/17" Fan Speed |
|---------|---------------|-------------------|
| OFF | 0 | 0 |
| Low | 2048 | 2119 |
| Middle1 | 2318 | 2297 |
| Middle2 | 2587 | 2482 |
| Middle3 | 2926 | 2700 |

(3) Silent mode (Low)

| Mode | 14" Fan Speed | 15"/17" Fan Speed |
|-------------|----------------------|--------------------------|
| OFF | 0 | 0 |
| Low | 2048 | 2119 |
| Middle1 | 2318 | 2297 |
| Middle2 | 2587 | 2482 |
| Middle3 | 2926 | 2700 |

(4) Battery Mode

| Mode | 14" Fan Speed | 15"/17" Fan Speed |
|-------------|----------------------|--------------------------|
| OFF | 0 | 0 |
| Low | 2048 | 2119 |
| Middle1 | 2318 | 2297 |
| Middle2 | 2587 | 2482 |
| Middle3 | 2926 | 2700 |
| High | 3511 | 2926 |

4.8. Battery Use time

Battery Use Time

Check the following check lists for systems where the battery use time is too short to diagnose problems.

Check the battery

Check if the battery is out of order referring to the Battery check program distributed to Service

1) Battery Check List

Please mark "✓" in the box (□) of each applicable items, after checking the battery status with the "battery checking program"

- Does the battery communicate normally with system?
 - PASS
 - FAIL
- Is the battery charged normally?
 - PASS
 - FAIL
- Is the battery discharged normally?
 - PASS
 - FAIL
- Is the battery still in warranty?
 - Excess than 6 months : Out of warranty
 - Excess than 300 Cycles : Out of warranty
 - Less than 6 months : PASS
 - Less than 6 months : FAIL

2) Criteria for each of the check lists

1. Does the battery communicate normally with system?

PASS FAIL

①: Data displayed in the data window. ②: The code 65535 displayed

③: Available capacity displayed : 0 ~ 100% ④: Displayed the error message in Korean
"통신이 원활 하지 않습니다"

☞ recommended : When the communication failed, please set a normal battery to the system and check first which -battery or system- has the problem.

2. Is the battery charged normally?

PASS FAIL

①: Pass, if the CURR values are within 35 ~ 3500 ②: Fail, if the CURR values are 0 and the battery status is in Charging.

③: Pass, even if the CURR value is 0 but the battery is in status of Full Charge ④: If the CURR value is 0 and in status of Charging, please reconfirm the "fail" after 2-3 times of Retest.

3. Is the battery discharged normally?

PASS FAIL

① ②: Pass, if the CURR values are within -50 ~ -5000 and the battery status is in Discharging. Fail, if the System is off status when the adaptor is removed from the System

4. Is the battery still in warranty?

Excess than 6 months : Out of warranty

Excess than 300 cycles : Out of warranty

☞ Warranty period : Within 6 months after sales date, more than 60% of initial electric capacity after 300 cycles.

* Reference : If a battery is out of warranty, the battery can not be considered as "defected". So if a customer requests to exchange his battery in this case, the battery should be provided **generously with sales price**. So please persuade customer to use continuously his battery, with the explanation of effective capacity of his battery, if the battery have no defect but only small decrease of capacity.

Less than 6 months : PASS

Less than 6 months : FAIL

☞ ①Please refer to "Capacity Standard Table" (or ②Capacity Standard Graph). Please judge Pass or Fail after checking the sales date of a battery. Pass, if the capacity of the battery is over than the value of corresponded date of "Available Capacity" column in the Table. Fail, if the capacity is lower than the value.

* Reference : The battery capacity can have individual error according to the user's circumstance of the battery. So it is recommended that the battery should be checked (with Battery Check Program) after calibration (Smart Battery Calibration: Full charge/discharge or Full discharge/charge)

[Example]

Less than 6 months: PASS Less than 6 months: FAIL

①: Available Capacity: 93% ②: Available Capacity: 51%

Duration of Use : 1month(30days) Duration of Use : 1month(30days)

Available Capacity of warranty: 87.8% Available Capacity of warranty: 87.8%

* Reference : If the sale date is 2004.5.10 and service receipt date is 2004.6.10, the Duration of Use is regarded as 1 month(30days)

3) Battery capacity Table.

| Duration of Use | Available Capacity(%) |
|---------------------------|-----------------------|
| Within 0.5month (15days) | More than 93.6 % |
| Within 1.0month (30days) | More than 87.8 % |
| Within 1.5month (45days) | More than 82.5 % |
| Within 2.0month (60days) | More than 77.8 % |
| Within 2.5month (75days) | More than 73.6 % |
| Within 3.0month (90days) | More than 70.0 % |
| Within 3.5month (105days) | More than 66.9 % |
| Within 4.0month (120days) | More than 64.4 % |
| Within 4.5month (135days) | More than 62.5 % |
| Within 5.0month (150days) | More than 61.1 % |
| Within 5.5month (165days) | More than 60.3 % |
| Within 6.0month (180days) | More than 60.0 % |

* Reference

Duration of Use : The using period from the sales date of the system (with battery)

Available Capacity(%) : The real capacity of the battery, decreased from the design capacity by the user's circumstance, keeping status or etc.

4) Batterycheck program

① Battery Status: Full Charge, in Charging, Full Discharge, in Discharging

② FCC: Full Charge Capacity. Expected capacity when the battery will be charged fully.

③ C.C: The times of full discharge after full charge

④ DATE: Sales date of the System year/month

⑤ VOLT: The voltage of charge or discharge of the battery

⑥ CURR: The current of charge or discharge of the battery

⑦ TEMP: The temperature of battery

⑧ Available Capacity: The percentage of present maximum available capacity compared to design capacity. Or "통신이 원활 하지 않습니다": the error message when System MICOM can not communicate with battery.

Battery Troubleshooting

- 1) Generally, the battery usage time in advertisements by notebook manufacturers refers to the maximum battery use time. Since the system specifications and the usage environment may differ, the user's battery usage time may differ from the advertisement even if there is no problem with the system.
.
- 2) Conditions for the company's maximum battery use time
 - Minimum LCD brightness, base system, the wireless LAN R/F is turned off, BatteryManager-Maximum Battery Mode
 - Measuring Tool: BatteryMark v.4.0.1
- 3) If a customer complains about the battery usage time, let them know that the battery usage time may differ depending on the model specifications and the usage environment and recommend the following usage environment for longer battery time.
 - Use the company's power-saving program, BatteryManager, and set BatteryManager to Maximum Battery Mode.
 - . LCD brightness: Set to the minimum level as long as the user does not experience inconvenience.
 - . Disable unnecessary devices : Turn the wireless LAN R/F switch off and disable USB devices (DMB, fingerprint recognition and Bluetooth)

4.9. Bios Update

Set-up Method

- 1) DOS Mode Update
 - a) Make a Dos booting disk -> Copy Packing file to Disk -> boot from DOS disk ->

BIOS update: C:\>amiflash XXXX.rom /c /x /bbl /force

MICOM update : C:\>up111m XXXX.bin

Packing file : C:\>XXXX.exe /s /c

(XXXX.exe is the packing file merging BIOS and MICOM -> ABXX.exe)
- 2) update in the Windows

Windows boot -> Run Samsung update plus -> check update profile -> Click 'BIOS update'
- 3) BIOS setup guide
- 4) Delete Password



RTC Reset

- Disassemble the system.
- Find RST Reset node next to the Mainboard Memory slot.
- Using the tool like as tweezer, connect two nodes for about 20~30sec. Then Bios rom will be reseted.

Caution

password is not released when remove and reconnect the cable
(Chipset limitation)
If you lose your password, AS A separate contact centers.

4.10. H/W Upgrade

HDD

This computer may have one or two hard disk drives depending on the product.

If there is only one hard disk drive, you can add a hard disk drive to the auxiliary hard disk drive compartment.

-  The pictures used for the descriptions are those of a representative model and may differ from the actual product.
- You can only install a 2.5-inch 9.5mmH S-ATA2 type hard disk drive for a note PC. (You have to purchase the drive separately.)
- When you install an additional hard disk drive, you have to use the separately provided parts, i.e. the rubber case, connector, fixing cover and fixing screws.

- 1** Shut the computer down completely and separate the AC adapter and the battery from the main body.
- 2** Remove the screw fixing the hard disk drive compartment cover at the bottom of the computer with a screw driver to separate the cover.

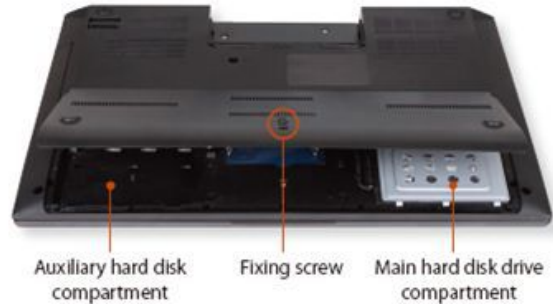

- 3** Insert the hard disk drive to be added into the rubber cover and connect one end of the connector to the hard disk drive.



- 4** Insert the hard disk drive into the auxiliary hard disk compartment and connect the connector to the connector port of the computer so that the white mark faces in the right-hand direction.



- 5** Insert the fixing cover aligning the one side of the cover with the three holes of the main body and fix the other side of the cover by fastening 2 fixing screws.



- 6** Close the hard disk drive compartment cover and fasten the screw.

 After installing a separately purchased hard disk drive, format the drive referring to the hard disk drive manual, if necessary.

| HDD  | | |
|---|-----------------|---|
| BA59-02873A | 500G(7.2_HGST) | 500GB, HTS725050A9A364, S16, 383, H16, C63, 9.5mm, 2.5inch, SATA, 7200RPM, 250G/P, FDB |
| BA59-02980A | 750GB(7.2_HGST) | 750GB, HTS547575A9E384, S16, 383, H16, C63, 9.5mmH, 2.5inch, SATA, 5400RPM, 375G/P, FDB |

Memory

One or more memory modules are installed on the computer. There are 4 memory slots in total. Users can replace the memory modules or add new memory modules using 2 of the slots.

- Replace or install new memory only after shutting the computer down completely. Do not replace or install memory when the computer is in Sleep mode. Disconnect main power plug and remove the battery before continuing.
- To utilize the dual channel feature, using memory modules with the same specifications (of the same capacity and from the same manufacturer) is recommended.
- The images used for the illustration are of a representative model, therefore the images may differ from the the actual product.

Adding or Replacing Memory Modules

- 1 Remove the screw on the memory compartment cover at the bottom of the computer using a screw driver.



- 2 Insert a new memory module into the memory slot at an angle of approximately 30 degrees aligning it to the angle of the memory slot.



- 3 Push the memory module down so that it is completely fixed. If the memory does not fit easily, push the memory module down while pulling the memory module latches outward.



- 4 Close the memory compartment cover and fasten the screw.

Removing a memory module

- Pull the memory module latches outward. The memory module will pop up.
- Remove the memory module out at an angle of 30 degrees.



| Memory | | |
|---|----------------|--|
|  | | |
| 1105-002211 | IC-DRAM MODULE | M471B5273CH0-CH9,DDR3 4G SODIMM,4GByte,512Mx64bits,SODIMM,204P,67.6x30mm,8ns,1.5V,+ -0.075V,0to+95C,320mA,TR |
| 1105-002217 | IC-DRAM MODULE | M471B5773CHS-CH9,DDR3 2G SODIMM,2GByte,256Mx64bits,SODIMM,204P,67.6x30.00mm,-1.5V,+ -0.075V,0to95C,280mA,TR |

5. System Wire Diagram

5.1. System Layout

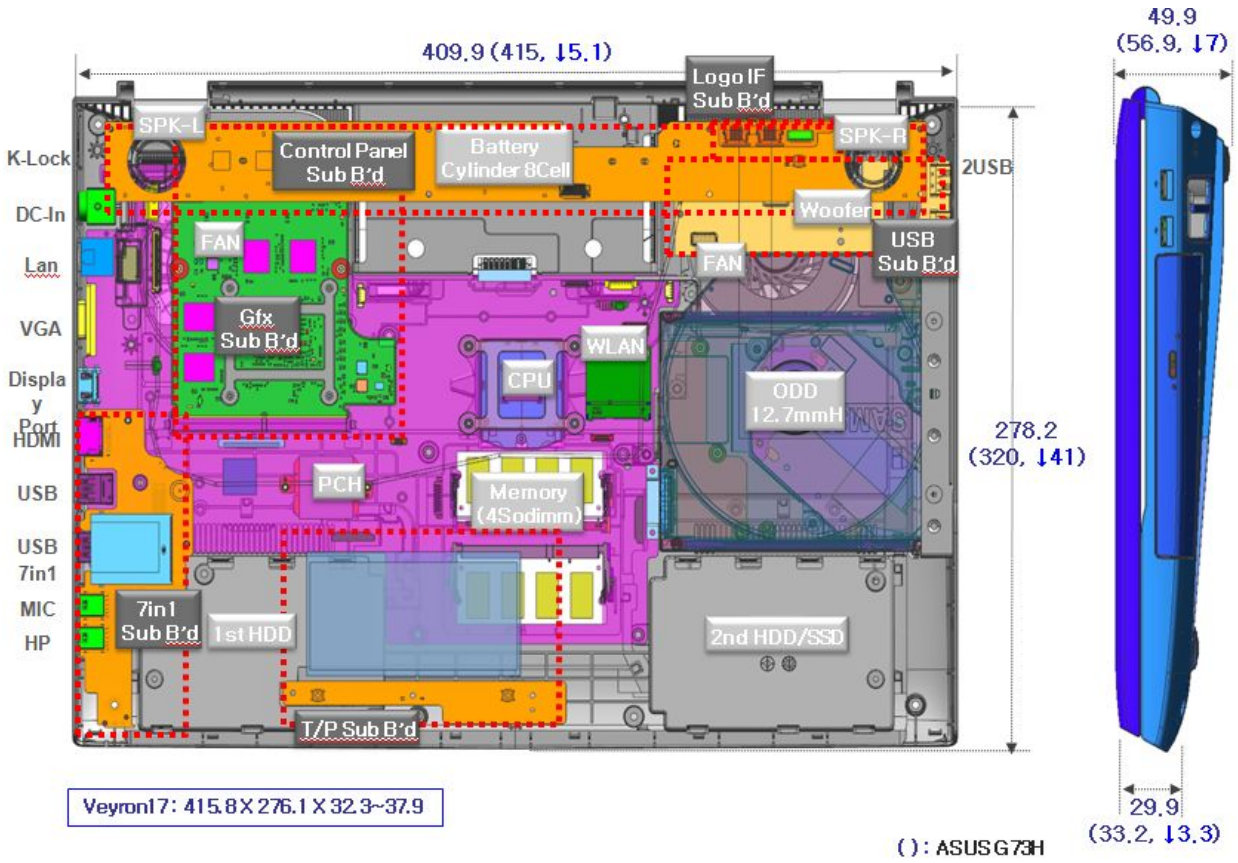

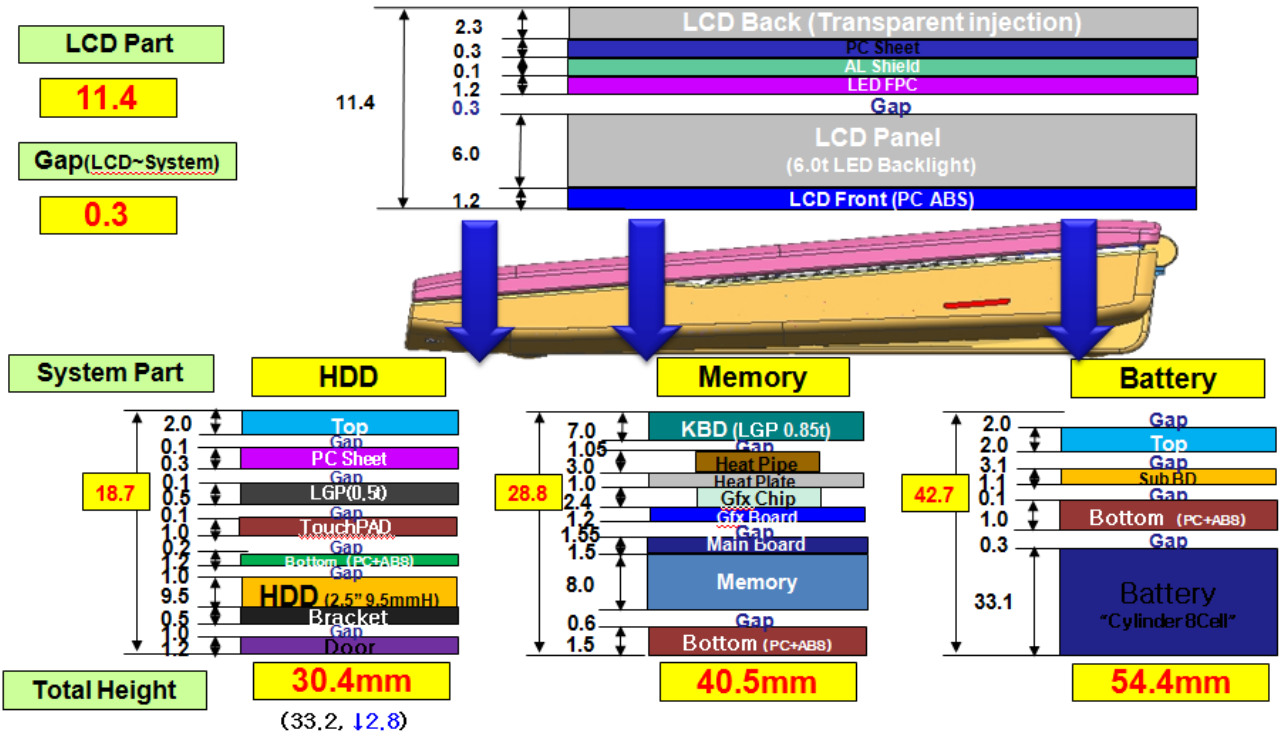

() : ASUS G73H (56.9, 12.5)

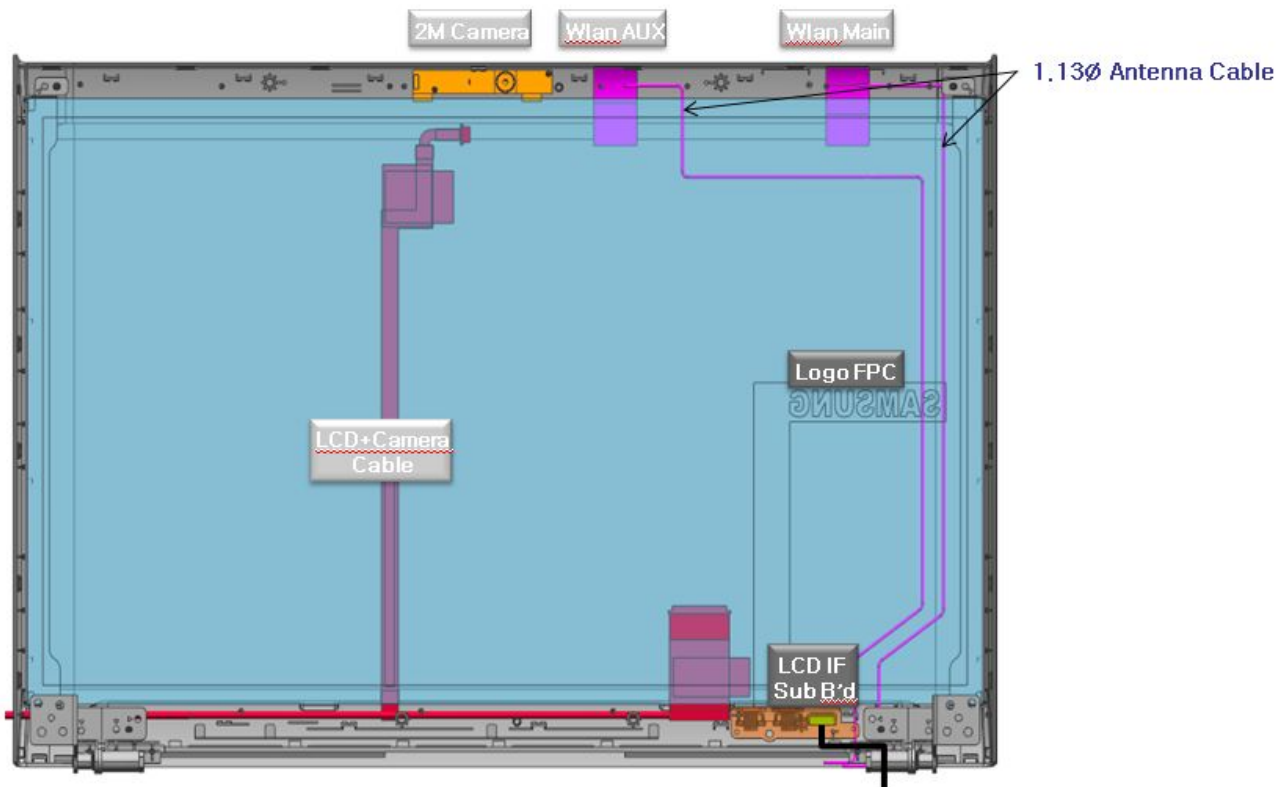

5. System Wire Diagram

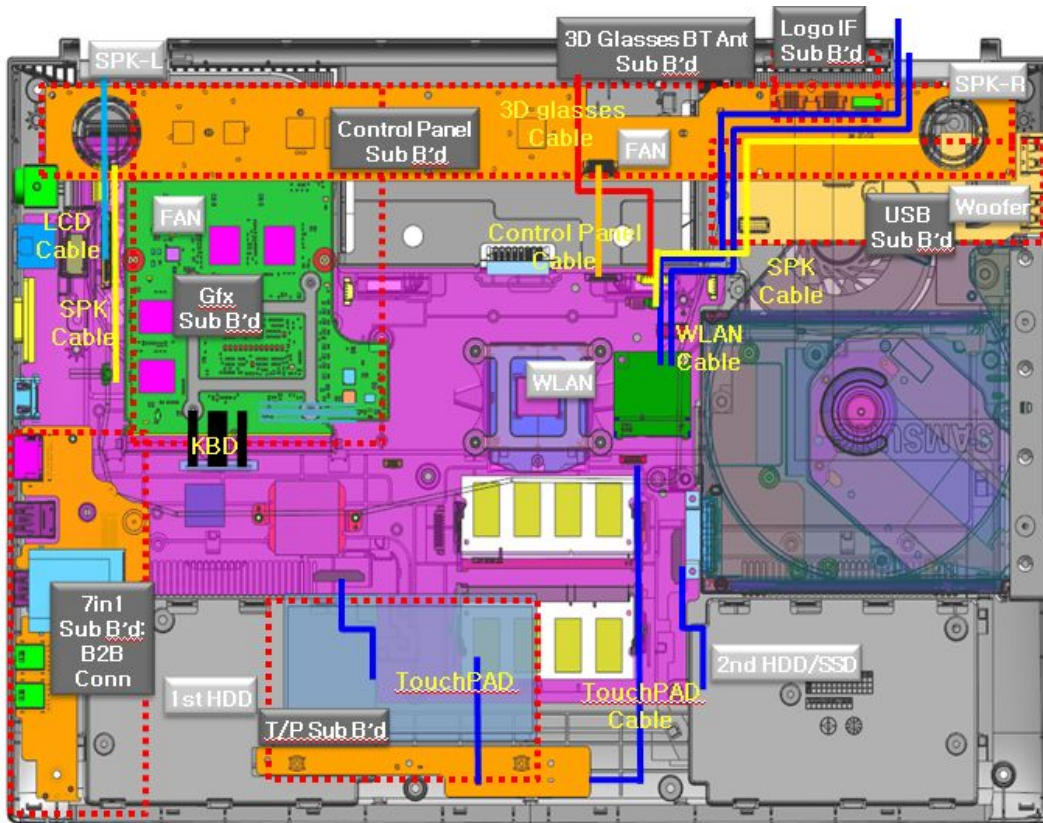

5.2. Board Component

Board Component- Bottom

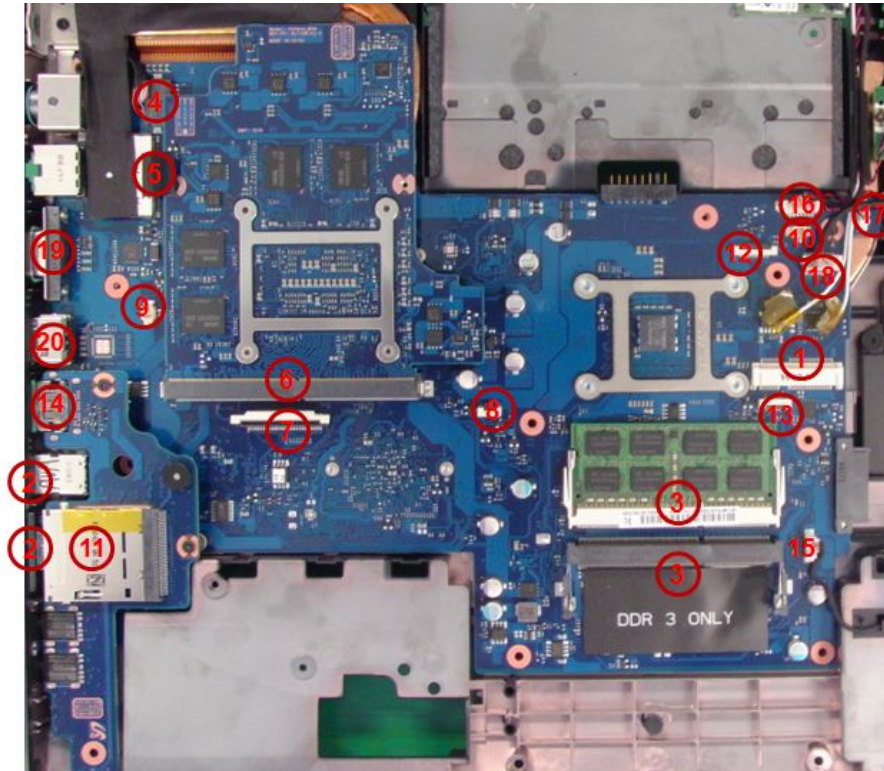

- | | |
|------------------------|-------------------------|
| 1.WLAN Conn. | 11.7-in-1 slot |
| 2.USB3.0 Conn. | 12.Human I/F Connector |
| 3.SoDIMMConn. | 13.Touch Pad Sub B'D |
| 4.DC Conn | 14.Display Port Conn |
| 5.LCD Conn | 15.USB 2.0 Sub B'D Conn |
| 6.MXM Conn | 16.3D Dongle Connector |
| 7.KBD Conn. | 17.Woofers Conn |
| 8.KBD Backlit Conn | 18.Jog Sub B'D Conn |
| 9.Speaker Conn(Left). | 19.VGA Conn |
| 10.Speaker Conn(Right) | 20.HDMI Conn |

Board Component- Top

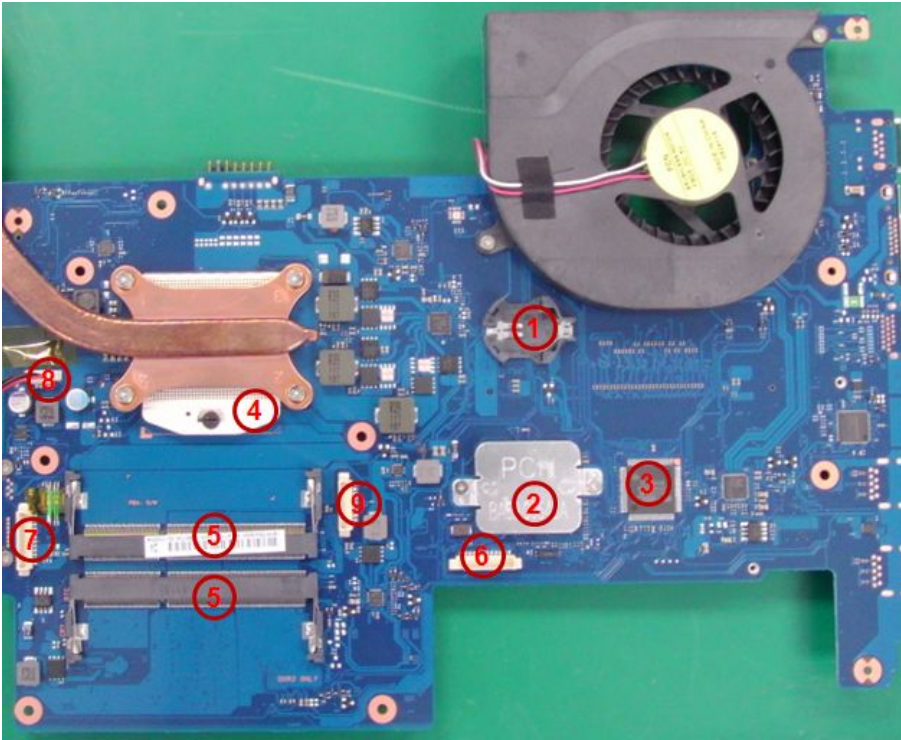

- 1.RTC BATTERY Conn
- 2.PCH Chipset
- 3.Micom
- 4.CPU Socket
- 5.SodimmSocket
- 6.HDD Connector(1st)
- 7.HDD Connector(2nd)
- 8.CPU Fan Conn
- 9.Debug Conn

Board Component- Sub board

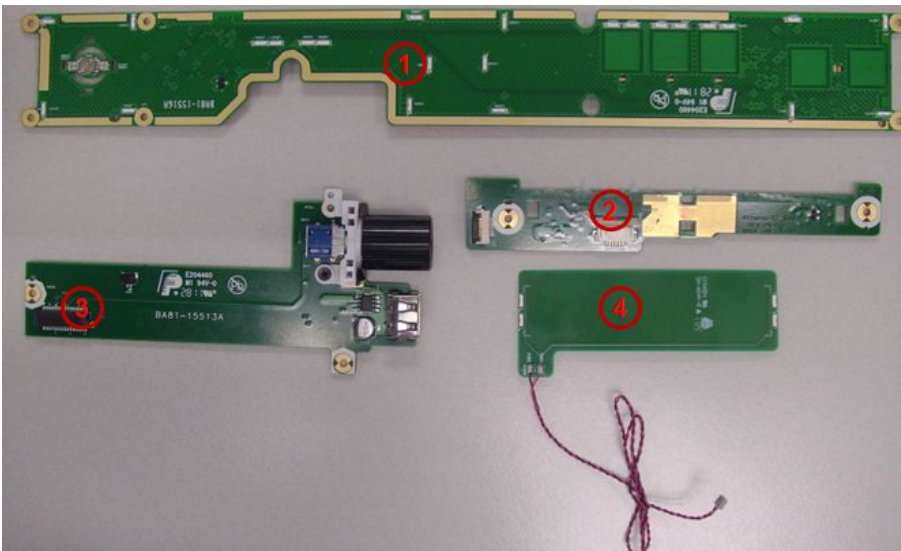

- 1.Human I/F Sub B'D
- 2.Touch Pad Sub B'D
- 3.Jog Dial Sub B'D(including USB 2.0 X 1 Port)
- 4.Logo Sub Board

KBD

Keyboard layout and size can vary by each country.



 KBD Water Check sheet Location



GSPN (GLOBAL SERVICE PARTNER NETWORK)

| Area | Web Site |
|---------------------------------|---|
| Europe, MENA, CIS, Africa | https://gspn1.samsungsportal.com |
| E.Asia, W.Asia, China, Japan | https://gspn2.samsungsportal.com |
| N.America, S.America | https://gspn3.samsungsportal.com |

This Service Manual is a property of Samsung Electronics Co.,Ltd.
Any unauthorized use of Manual can be punished under applicable International and/or domestic law.

© 2012 Samsung Electronics Co.,Ltd.
All rights reserved.
Printed in Korea
Code No.: