

User's Guide

Samsung Printer *Xpress*

C41x series

BASIC

This guide provides information concerning the installation, basic operation and troubleshooting on windows.

ADVANCED

This guide provides information about the installation, advanced configuration, operation and troubleshooting on various OS environments.

Some features may not be available depending on models or countries.

BASIC



1. Introduction

Key benefits	4
Features by models	6
Useful to know	9
About this user's guide	10
Safety information	11
Machine overview	17
Control panel overview	20
Turning on the machine	21
Installing the driver locally	22
Reinstalling the driver	23



2. Learning the Basic Usage

Printing a demo page	25
Media and tray	26
Basic printing	33



3. Maintenance

Ordering supplies and accessories	39
-----------------------------------	----

Available supplies	40
Available maintenance parts	42
Storing the toner cartridge	43
Redistributing toner	45
Replacing the toner cartridge	47
Replacing the waste toner container	49
Replacing the imaging unit	51
Cleaning the machine	53
Tips for moving & storing your machine	55



4. Troubleshooting

Tips for avoiding paper jams	57
Clearing paper jams	58
Understanding the status LED	62



5. Appendix

Specifications	66
Regulatory information	75
Copyright	85



1. Introduction

This chapter provides information you need to know before using the machine.

- **Key benefits** 4
- **Features by models** 6
- **Useful to know** 9
- **About this user's guide** 10
- **Safety information** 11
- **Machine overview** 17
- **Control panel overview** 20
- **Turning on the machine** 21
- **Installing the driver locally** 22
- **Reinstalling the driver** 23

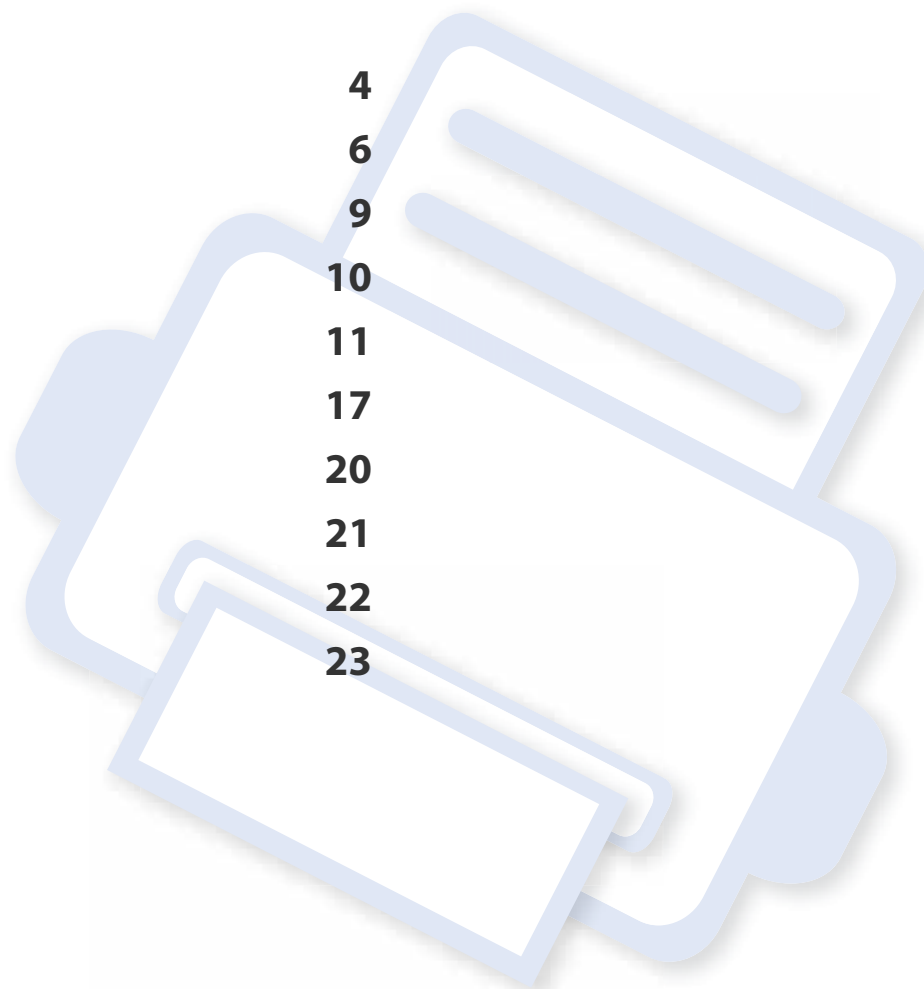

Key benefits

Environmentally friendly



- To save toner and paper, this machine supports the Eco feature (see "Easy Eco Driver" on page 163).
- To save paper, you can print multiple pages on a single sheet of paper (see "Using advanced print features" on page 148).
- To save paper, you can print on both sides of the paper (manual double-sided printing) (see "Using advanced print features" on page 148).
- To save electricity, this machine automatically conserves electricity by substantially reducing power consumption when not in use.
- We recommend using recycled paper for saving energy.

Print with excellent quality and speed



- You can print in a full range of colors using cyan, magenta, yellow, and black.
- You can print with a resolution of up to 2,400 x 600 dpi effective output (600 x 600 x 2 bit).

- Fast, on-demand printing.
 - For single-side black and white printing, 18 ppm (A4) or 19 ppm (Letter).
 - For single-side color printing, 4 ppm (A4 or Letter).

Convenience



- Simply touch your cell phone on the NFC tag on your printer and get the print job done (see "Using the NFC feature" on page 140).
- You can print on the go from your smartphone or computer using Google Cloud Print enabled apps (see "Google Cloud Print" on page 142).
- Easy Capture Manager allows you to easily edit and print whatever you captured using the Print Screen key on the keyboard (see "Easy Capture Manager" on page 160).
- Samsung Easy Printer Manager and Samsung Printer Status are a program that monitors and informs you of the machine's status and allows you to customize the machine's settings (see "Using Samsung Easy Printer Manager" on page 167 or "Using Samsung Printer Status" on page 170).
- AnyWeb Print helps you screen-capture, preview, scrap, and print the screen more easily than when you use the ordinary program (see "Samsung AnyWeb Print" on page 162).
- Smart Update allows you to check for the latest software and install the latest version during the printer driver installation process. This is available only for Windows OS users.

Key benefits

- If you have Internet access, you can get help, support application, machine drivers, manuals, and order information from the Samsung website, www.samsung.com > find your product > Support or Downloads.

Wide range of functionality and application support



- Supports various paper sizes (see "Print media specifications" on page 68).
- Print watermark: You can customize your documents with words, such as "**CONFIDENTIAL**" (see "Using advanced print features" on page 148).
- Print posters: The text and pictures of each page of your document are magnified and printed across the multiple sheets of paper and can then be taped together to form a poster (see "Using advanced print features" on page 148).
- You can print in various operating systems (see "System requirements" on page 71).
- Your machine is equipped with a USB interface and/or a network interface.

Supports various wireless network setting method



- Using the WPS (Wi-Fi Protected Setup™) button
 - You can easily connect to a wireless network using the WPS button on the machine and the access point (a wireless router).
- Using the USB cable or a network cable
 - You can connect and set various wireless network settings using a USB cable or a network cable.
- Using the Wi-Fi Direct
 - You can conveniently print from your mobile device using the Wi-Fi or Wi-Fi Direct feature.



See "Introducing wireless set up methods" on page 108.

Features by models

Some features and optional goods may not be available depending on model or country.

Operating System

Operating System	C41xW
Windows	•
Mac	•
Linux	•

Features by models

Software



You can install the printer driver and software when you insert the software CD into your CD-ROM drive.

For Windows, select the printer driver and software in the **Select Software to Install** window.

Software	C41xW
SPL printer driver	•
XPS printer driver ^a	•
Samsung Easy Printer Manager ^a	•
Samsung Easy Color Manager ^a	•
Samsung Anyweb Print ^a	•
Samsung Printer Status	•
SyncThru™ Web Service	•

- a. Download the software from the Samsung website and install it: (<http://www.samsung.com> > find your product > Support or Downloads). Before installing, check whether your computer's OS support the software.

Features by models

Variety feature

Features	C41xW
Hi-Speed USB 2.0	●
Network Interface Ethernet 10/100 Base TX wired LAN	●
Network Interface 802.11b/g/n wireless LAN ^a	●
IPv6	●
NFC printing	●
Google Cloud Print	●
Eco printing (Easy Eco Driver) ^b	●
Wi-Fi Protected Setup™ (WPS)	●
Manual duplex (2-sided) printing ^c	●

a. Depending on your country, wireless LAN card may not be available. For some counties, only 802.11 b/g can be applied. Contact your local Samsung dealer or the retailer where you bought your machine.

b. Setting the ECO settings is available from the windows driver.

c. Available for Windows OS users only.

(●: Included, Blank: Not available)

Useful to know



Where can I download the machine's driver?

- Visit www.samsung.com/printer to download the latest machine's driver, and install it on your system.



Where can I purchase accessories or supplies?

- Inquire at a Samsung distributor or your retailer.
- Visit www.samsung.com/supplies. Select your country/region to view product service information.



The status LED flashes or remains constantly on.

- Turn the product off and on again.
- Check the meanings of LED indications in this manual and troubleshoot accordingly (see "Understanding the status LED" on page 62).



A paper jam has occurred.

- Open and close the top cover (see "Front view" on page 18).
- Check the instructions on removing jammed paper in this manual and troubleshoot accordingly (see "Clearing paper jams" on page 58).



Printouts are blurry.

- The toner level might be low or uneven. Shake the toner cartridge.
- Try a different print quality setting.
- Replace the toner cartridge.



The machine does not print.

- Open the print queue list and remove the document from the list (see "Canceling a print job" on page 34).
- Remove the driver and install it again (see "Installing the driver locally" on page 22).
- Select your machine as your default machine in your Windows.

About this user's guide

This user's guide provides information for your basic understanding of the machine as well as detailed steps to explain machine usage.



- Read the safety information before using the machine.
- If you have a problem using the machine, refer to the troubleshooting chapter.
- Terms used in this user's guide are explained in the glossary chapter.
- All illustrations in this user's guide may differ from your machine depending on its options or model you purchased.
- The screenshots in this user's guide may differ from your machine depending on the machine's firmware/driver version.
- The procedures in this user's guide are mainly based on Windows 7.

Conventions

Some terms in this guide are used interchangeably, as below:

- Document is synonymous with original.
- Paper is synonymous with media, or print media.
- Machine refers to printer or MFP.

General icons



Icon	Text	Description
	Caution	Gives users information to protect the machine from possible mechanical damage or malfunction.
	Note	Provides additional information or detailed specification of the machine function and feature.

Safety information

These warnings and precautions are included to prevent injury to you and others, and to prevent any potential damage to your machine. Be sure to read and understand all of these instructions before using the machine. After reading this section, keep it in a safe place for future reference.

Important safety symbols

Explanation of all icons and signs used in this chapter

	Warning	Hazards or unsafe practices that may result in severe personal injury or death.
	Caution	Hazards or unsafe practices that may result in minor personal injury or property damage.
		Do not attempt.

Operating environment

Warning



Do not use if the power cord is damaged or if the electrical outlet is not grounded.

This could result in electric shock or fire.



Do not place anything on top of the machine (water, small metal or heavy objects, candles, lit cigarettes, etc.).

This could result in electric shock or fire.

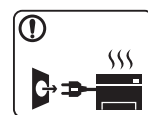

- If the machine gets overheated, it releases smoke, makes strange noises, or generates an odd odor, immediately turn off the power switch and unplug the machine.

- The user should be able to access the power outlet in case of emergencies that might require the user to pull the plug out.

This could result in electric shock or fire.



Do not bend, or place heavy objects on the power cord.

Stepping on or allowing the power cord to be crushed by a heavy object could result in electric shock or fire.







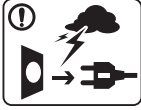

Do not remove the plug by pulling on the cord; do not handle the plug with wet hands.

This could result in electric shock or fire.





Safety information

Caution



	<p>During an electrical storm or for a period of non-operation, remove the power plug from the electrical outlet.</p> <p>This could result in electric shock or fire.</p>
	<p>Be careful, the paper output area is hot.</p> <p>Burns could occur.</p>
	<p>If the machine has been dropped, or if the cabinet appears damaged, unplug the machine from all interface connections and request assistance from qualified service personnel.</p> <p>Otherwise, this could result in electric shock or fire.</p>
	<p>If the machine does not operate properly after these instructions have been followed, unplug the machine from all interface connections and request assistance from qualified service personnel.</p> <p>Otherwise, this could result in electric shock or fire.</p>
	<p>If the plug does not easily enter the electrical outlet, do not attempt to force it in.</p> <p>Call an electrician to change the electrical outlet, or this could result in electric shock.</p>
	<p>Do not allow pets to chew on the AC power, telephone or PC interface cords.</p> <p>This could result in electric shock or fire and/or injury to your pet.</p>

Operating method

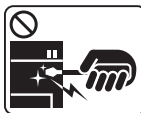
Caution

	<p>Do not forcefully pull the paper out during printing.</p> <p>It can cause damage to the machine.</p>
	<p>Be careful not to put your hand between the machine and paper tray.</p> <p>You may get injured.</p>
	<p>This machine's power reception device is the power cord.</p> <p>To switch off the power supply, remove the power cord from the electrical outlet.</p>
	<p>Be careful when replacing paper or removing jammed paper.</p> <p>New paper has sharp edges and can cause painful cuts.</p>
	<p>When printing large quantities, the bottom part of the paper output area may get hot. Do not allow children to touch.</p> <p>Burns can occur.</p>
	<p>When removing jammed paper, do not use tweezers or sharp metal objects.</p> <p>It can damage the machine.</p>

Safety information

	Do not allow too many papers to stack up in the paper output tray. It can damage the machine.
	Do not block or push objects into the ventilation opening. This could result in elevated component temperatures which can cause damage or fire.
	Use of controls or adjustments or performance of procedures other than those specified herein may result in hazardous radiation exposure.

Installation / Moving

Warning

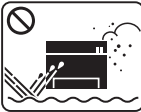
	Do not place the machine in an area with dust, humidity, or water leaks. This could result in electric shock or fire.
--	--

Caution



Before moving the machine, turn the power off and disconnect all cords. The information below are only suggestions based on the units weight.

If you have a medical condition that prevents you from lifting, do not lift the machine. Ask for help, and always use the appropriate amount of people to left the device safety.

Then lift the machine:

- If the machine weighs under 20 kg (44.09 lbs), lift with 1 person.
- If the machine weighs 20 kg (44.09 lbs) - 40kg (88.18 lbs), lift with 2 people.
- If the machine weighs more than 40 kg (88.18 lbs), lift with 4 or more people.

The machine could fall, causing injury or machine damage.

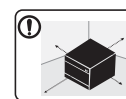







Choose a flat surface with enough space for ventilation to place the machine. Also consider the space required to open the cover and trays.

The place should be well-ventilated and be far from direct light, heat, and humidity.



When using the machine for a long period of time or printing a large number of pages in a non-ventilated space, it could pollute the air and be harmful to your health. Place the machine in a well-ventilated space or open a window to circulate the air periodically.





Safety information

	<p>Do not place the machine on an unstable surface.</p> <p>The machine could fall, causing injury or machine damage.</p>
	<p>Use only No.26 AWG^a or larger, telephone line cord, if necessary.</p> <p>Otherwise, it can cause damage to the machine.</p>
	<p>Use the power cord supplied with your machine for safe operation. If you are using a cord which is longer than 2 meters (6 feet) with a 110 V machine, then the gauge should be 16 AWG or larger.</p> <p>Otherwise, it can cause damage to the machine, and could result in electric shock or fire.</p>
	<p>Make sure you plug the power cord into a grounded electrical outlet.</p> <p>Otherwise, this could result in electric shock or fire.</p>
	<p>Do not overload wall outlets and extension cords.</p> <p>This can diminish performance, and could result in electric shock or fire.</p>
	<p>Do not put a cover over the machine or place it in an airtight location, such as a closet.</p> <p>If the machine is not well-ventilated, this could result in fire.</p>
	<p>The machine should be connected to the power level which is specified on the label.</p> <p>If you are unsure and want to check the power level you are using, contact the electrical utility company.</p>



a. AWG: American Wire Gauge

Maintenance / Checking

Caution

	<p>Unplug this product from the wall outlet before cleaning the inside of the machine. Do not clean the machine with benzene, paint thinner or alcohol; do not spray water directly into the machine.</p> <p>This could result in electric shock or fire.</p>
	<p>When you are working inside the machine replacing supplies or cleaning the inside, do not operate the machine.</p> <p>You could get injured.</p>
	<p>Keep cleaning supplies away from children.</p> <p>Children could get hurt.</p>
	<p>Do not disassemble, repair or rebuild the machine by yourself.</p> <p>It can damage the machine. Call a certified technician when the machine needs repairing.</p>





Safety information

	<ul style="list-style-type: none">Do not remove any covers or guards that are fastened with screws.Fuser units should only be repaired by a certified service technician. Repair by non-certified technicians could result in fire or electric shock.The machine should only be repaired by a Samsung service technician.
	<p>To clean and operate the machine, strictly follow the user's guide provided with the machine.</p> <p>Otherwise, you could damage the machine.</p>
	<p>Keep the power cable and the contact surface of the plug clean from dust or water.</p> <p>Otherwise, this could result in electric shock or fire.</p>

Supply usage

Caution

	<p>Do not disassemble the toner cartridge.</p> <p>Toner dust can be dangerous if inhaled or ingested.</p>
--	---

	<p>Do not burn any of the supplies such as toner cartridge or fuser unit.</p> <p>This could cause an explosion or uncontrollable fire.</p>
	<p>When storing supplies such as toner cartridges, keep them away from children.</p> <p>Toner dust can be dangerous if inhaled or ingested.</p>
	<p>Using recycled supplies, such as toner, can cause damage to the machine.</p> <p>In case of damage due to the use of recycled supplies, a service fee will be charged.</p>
	<p>For supplies that contain toner dust (toner cartridge, waste toner bottle, imaging unit, etc.) follow the instructions below.</p> <ul style="list-style-type: none">When disposing of the supplies, follow the instructions for disposal. Refer to the reseller for disposal instructions.Do not wash the supplies.For a waste toner bottle, do not reuse it after emptying the bottle. <p>If you do not follow the instructions above, it may cause machine malfunction and environmental pollution. The warranty does not cover damages caused by a user's carelessness.</p>
	<p>When changing the toner cartridge or removing jammed paper, be careful not to let toner dust touch your body or clothes.</p> <p>Toner dust can be dangerous if inhaled or ingested.</p>

Safety information



When toner gets on your clothing, do not use hot water to wash it.

Hot water sets toner into fabric. Use cold water.

Machine overview

Accessories



Power cord

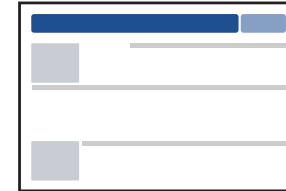

Quick installation guide

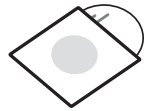

Software CD^a

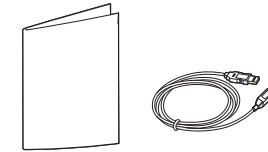

Misc. accessories^b

a. The software CD contains the printer drivers and software applications.

b. Miscellaneous accessories included with your machine may vary by country of purchase and specific model.

Machine overview

Front view



- This illustration may differ from your machine depending on its model.
- Some features and optional goods may not be available depending on model or country (see "Features by models" on page 6).

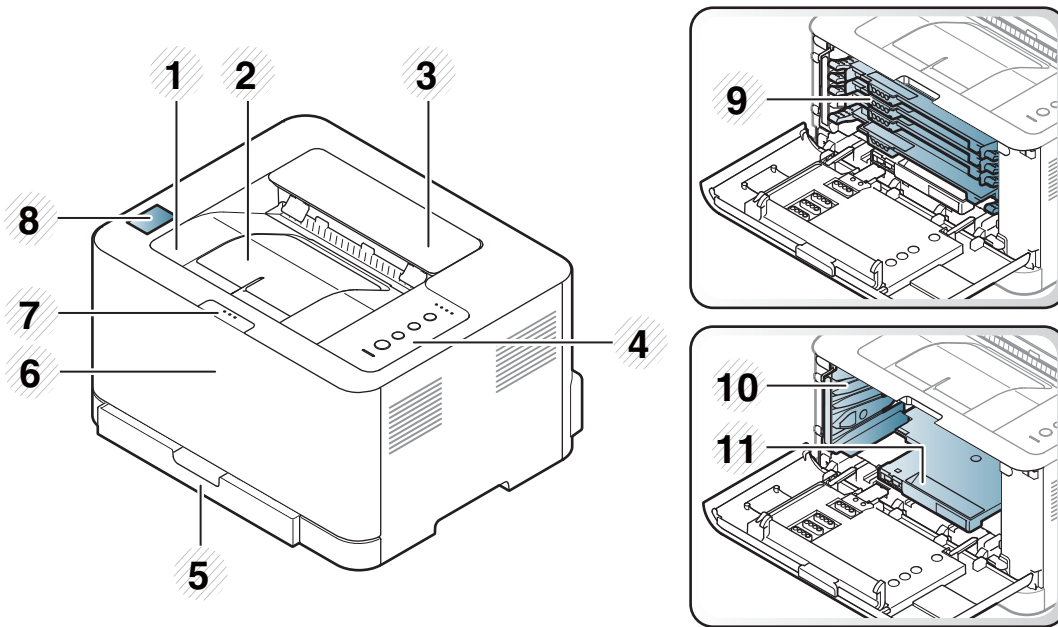

1	Output tray	2	Output support	3	Top cover	4	Control Panel	5	Tray
6	Front cover	7	Front cover release button	8	NFC tag	9	Toner cartridges	10	Waster toner container
11	Imaging unit								

Machine overview

Rear view



- This illustration may differ from your machine depending on its model.
- Some features and optional goods may not be available depending on model or country (see "Features by models" on page 6).

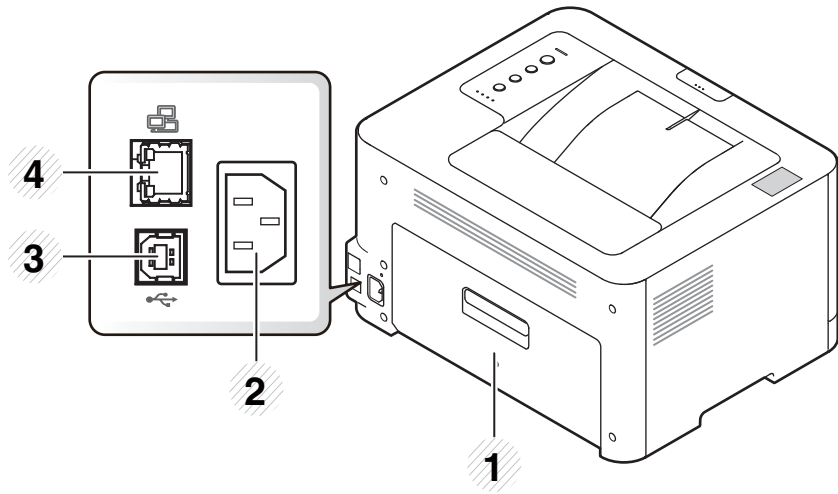

1	Rear cover	2	Power receptacle	3	USB port	4	Network port
---	------------	---	------------------	---	----------	---	--------------





Control panel overview

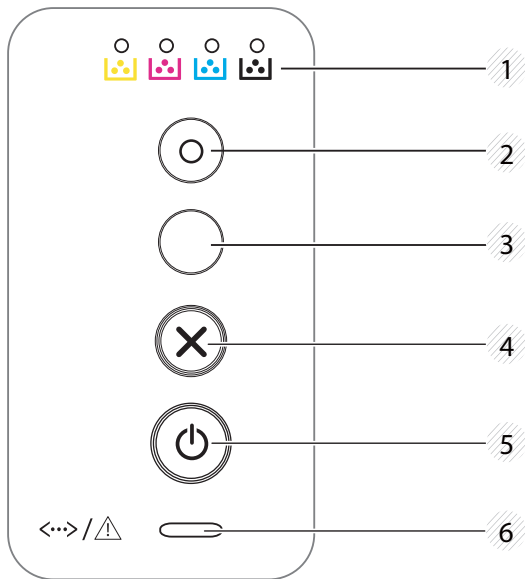

This control panel may differ from your machine depending on its model. There are various types of control panels.



1	Toner LED	Shows the status of the toner (see "Status LED" on page 63).
2	Eco	Turn into eco mode to reduce toner consumption and paper usage when pc-printing only (see "Eco printing" on page 36).

3	 (WPS)	<p>Configures the wireless network connection easily without a computer (see "Wireless network setup" on page 107).</p> <ul style="list-style-type: none"> • Manual print <ul style="list-style-type: none"> - Press this button each time you load a sheet of paper in the tray if you have selected Manual Feeder for Source in your printer driver.
4	 (Cancel)	<p>You can stop an operation at any time. You also can do the following functions.</p> <ul style="list-style-type: none"> • Configuration sheet <ul style="list-style-type: none"> - Press and hold this button for about 2 seconds until the green LED blinks slowly, and release. • Prints event log report / usage counter <ul style="list-style-type: none"> - Press and hold this button for about 4 seconds until the green LED blinks quickly, and release. • Prints supplies info report <ul style="list-style-type: none"> - Press and hold this button for about 6 seconds until the green LED on, and release.
5	 (Power/ Wakeup)	<p>You can turn the power off or wake the machine up from the sleep mode with this button.</p>
6	 (Status LED)	<p>Shows the status of your machine (see "Status LED" on page 63).</p>

Turning on the machine

- 1 Connect the machine to the electricity supply first.

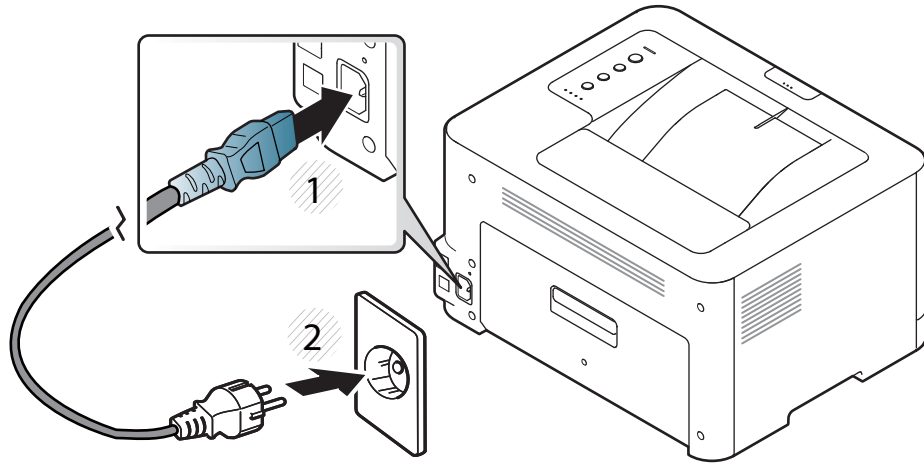

- 2 press  (**Power/Wakeup**) on the control panel.

 If you want to turn the power off, press  (**Power/Wakeup**) on the control panel.

Installing the driver locally

A locally connected machine is a machine directly attached to your computer using the cable. If your machine is attached to a network, skip the following steps below and go on to installing a network connected machine's driver (see Advanced Guide).



- If you are a Mac or Linux operating systems user, refer to the "Installation for Mac" on page 90 or "Installation for Linux" on page 92.
- The installation window in this User's Guide may differ depending on the machine and interface in use.
- Only use a USB cable no longer than 3 meters (118 inches).

Windows

- 1 Insert the supplied software CD into your CD-ROM drive.

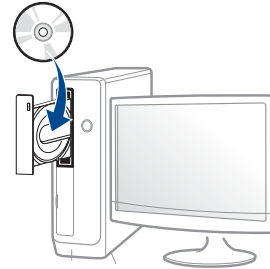

If the installation window does not appear, click **Start > All programs > Accessories > Run**.

X:**Setup.exe** replacing "X" with the letter, which represents your CD-ROM drive and click **OK**.

- 2 Review and accept the installation agreements in the installation window. Then, click **Next**.
- 3 Select **USB connection** on the **Printer Connection Type** screen. Then, click **Next**.
- 4 Follow the instructions in the installation window.



You can select the software applications in the **Select Software to Install** Window.

Reinstalling the driver

If the printer driver does not work properly, follow the steps below to reinstall the driver.

Windows

- 1** From the **Start** menu, select **Programs** or **All Programs** > **Samsung Printers** > **Uninstall Samsung Printer Software**.
- 2** Follow the instructions in the installation window.
- 3** Insert the software CD into your CD-ROM drive and install the driver again (see "Installing the driver locally" on page 22).



2. Learning the Basic Usage

After installation is complete, you may want to set the machine's default settings. Refer to the next section if you would like to set or change values. This chapter provides information about the overall menu structure and the basic setup options.

- **Printing a demo page** 25
- **Media and tray** 26
- **Basic printing** 33



Printing a demo page

Print a demo page to make sure that the machine is operating correctly (Windows only).

To print a demo page:

- Open the **Printing Preferences** (see "Opening printing preferences" on page 34) > **Samsung** tab > **Demo page**.

Media and tray

This chapter provides information on how to load print media into your machine.



- Using print media that does not meet these specifications may cause problems or require repairs. Such repairs are not covered by Samsung's warranty or service agreements.
- Make sure not to use the inkjet photo paper with this machine. It could cause damage to the machine.
- Using inflammable print media can cause a fire.
- Use designated print media (see "Print media specifications" on page 68).



The use of inflammable media or foreign materials left in the printer may lead to overheating of the unit and, in rare cases may cause a fire.

Tray overview

To change the size, you need to adjust the paper guide.

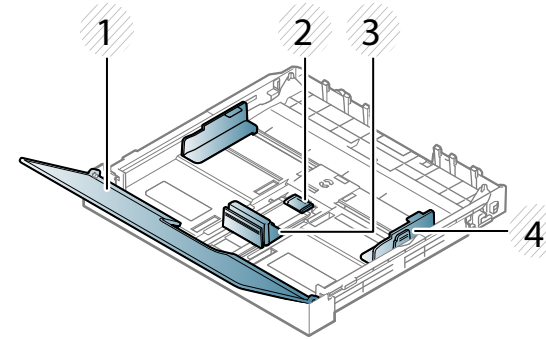

- 1 Paper cover
- 2 Guide lock
- 3 Paper length guide
- 4 Paper width guide



If you do not adjust the guide, it may cause paper registration, image skew, or jamming of the paper.

Media and tray

Loading paper in the tray

- 1 Pull out the paper tray (see "Tray overview" on page 26).

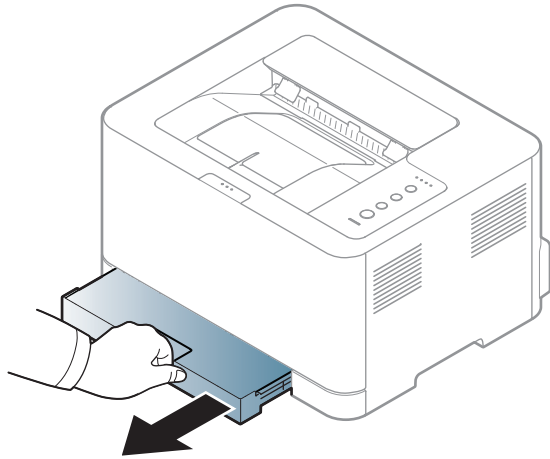

- 2 Open the paper cover.

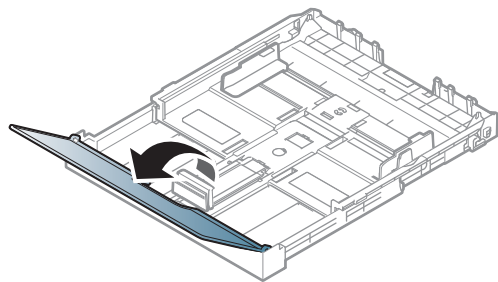

- 3 Press and unlatch the guide lock in the tray, pull the tray out manually. Then adjust the paper length guide and paper width guide.

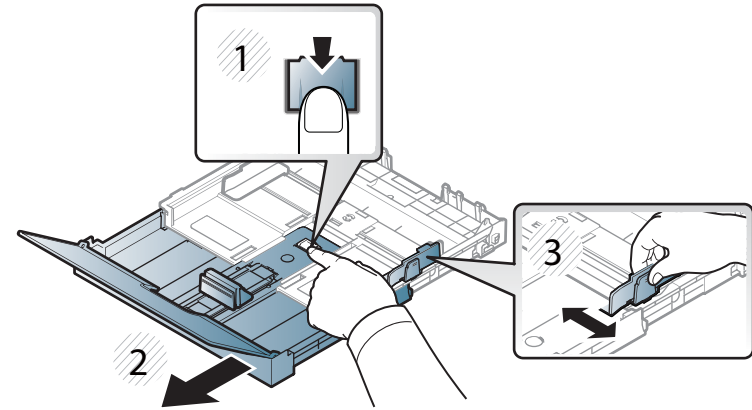

- 4 Flex or fan the edge of the paper stack to separate the pages before loading papers.

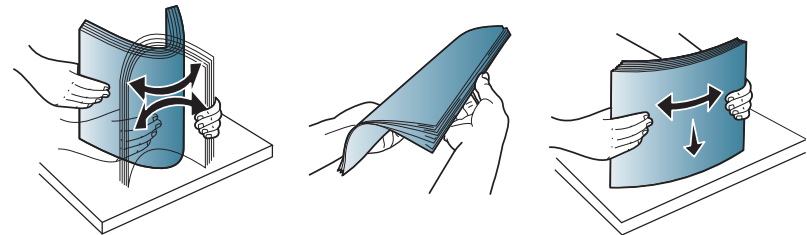

Media and tray

- 5 Place the paper with the side you want to print facing up.

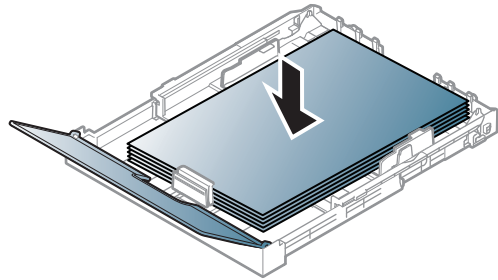

For paper smaller than Letter-sized, press and unlatch the guide lock in the tray, push the tray in manually. Then adjust the paper length guide and paper width guide.

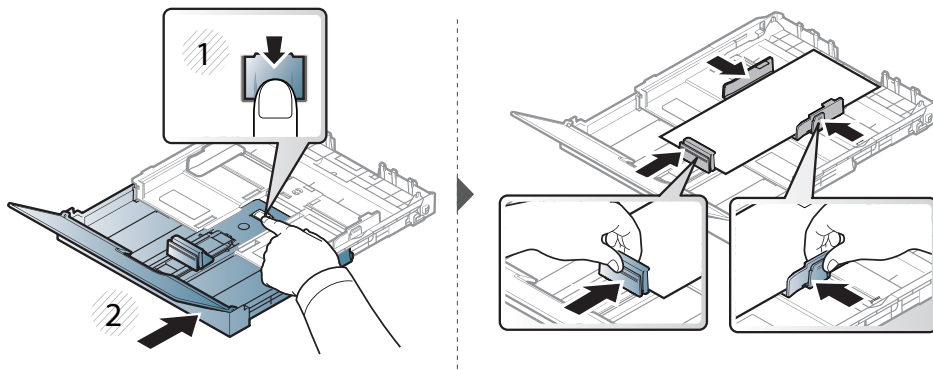

For paper longer than Legal-sized, press and unlatch the guide lock in the tray, pull the tray out manually. Then adjust the paper length guide and paper width guide.

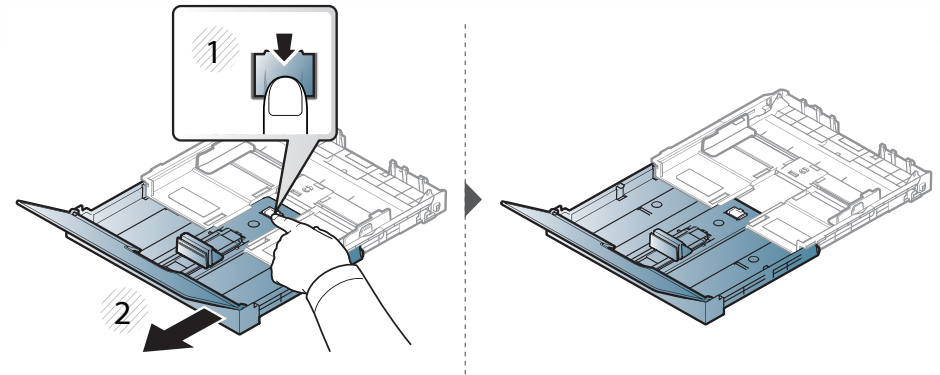

- Do not push the paper width guide too far causing the media to warp.
- Do not use a paper with a leading-edge curl, it may cause a paper jam or the paper can be wrinkled.
- If you do not adjust the paper width guide, it may cause paper jams.

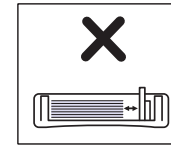
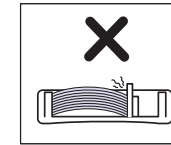
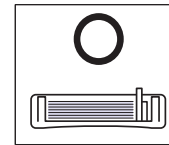

Media and tray

- 6 Squeeze the paper width guide and slide it to the edge of the paper stack without causing it to bend.

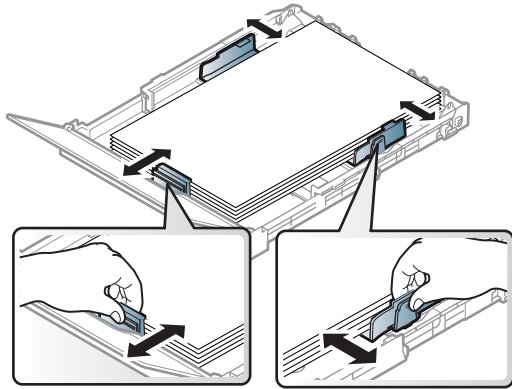

- 7 Close the paper cover.

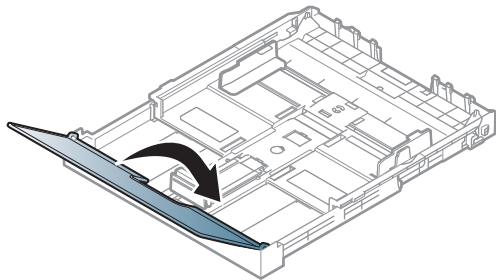

- 8 Insert the paper tray.

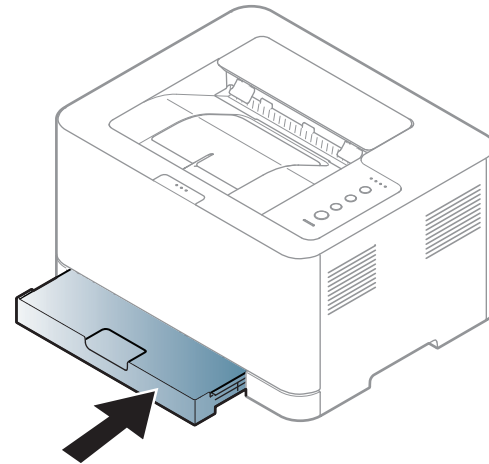

- 9 When you print a document, set the paper type and size for the tray (see "Setting the paper size and type" on page 32).

Printing on special media

The table below shows the special media usable in tray.

The paper setting in the machine and driver should match to print without a paper mismatch error.

To change the paper setting set in the machine, from the **Samsung Easy Printer Manager** select  **(Switch to advanced mode) > Device Settings**.

Then, set the paper type from the **Printing preferences** window > **Paper** tab > **Paper Type** (see "Opening printing preferences" on page 34).

Media and tray



When using special media, we recommend you feed one sheet at a time (see "Print media specifications" on page 68).

To see for paper weights for each sheet, refer to "Print media specifications" on page 68.

Types	Tray ^a
Plain	●
Thick	●
Thin	●
Bond	●
Color	●
CardStock	●
Labels	●
Preprinted	●
Cotton	●
Recycled	●
Archive	●
Glossy Photo	●
Matte Photo	●

a. The paper types available manual feeding in tray.

(●: Included, Blank: Not available)

Labels

To avoid damaging the machine, use only labels designed for use in laser printers.

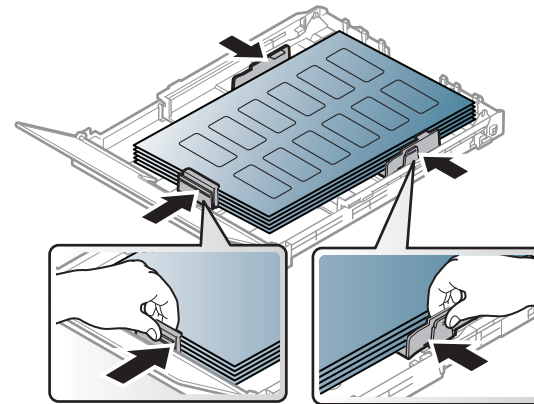

- When selecting labels, consider the following factors:
 - **Adhesives:** Should be stable at your machine's fusing temperature. Check your machine's specifications to view the fusing temperature (about 170°C (338°F)).
 - **Arrangement:** Only use labels with no exposed backing between them. Labels can peel off sheets that have spaces between the labels, causing serious jams.
 - **Curl:** Must lie flat with no more than 5 mm of curl in any direction.

Media and tray

- **Condition:** Do not use labels with wrinkles, bubbles, or other indications of separation.
- Make sure that there is no exposed adhesive material between labels. Exposed areas can cause labels to peel off during printing, which can cause paper jams. Exposed adhesive can also cause damage to machine components.
- Do not run a sheet of labels through the machine more than once. The adhesive backing is designed for only a single pass through the machine.
- Do not use labels that are separating from the backing sheet or are wrinkled, bubbled, or otherwise damaged.

Card stock/ Custom-sized paper

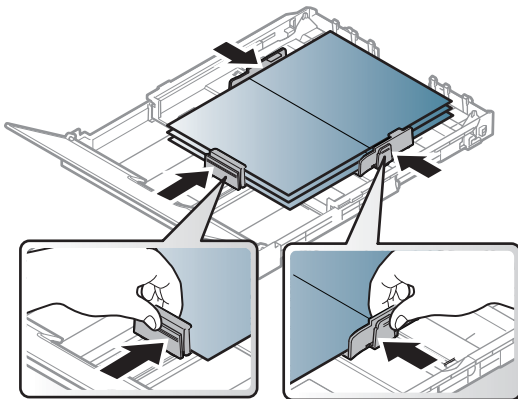

- In the software application, set margins at least 6.4 mm (0.25 inches) away from the edges of the material.

Preprinted paper

When loading preprinted paper, the printed side should be facing up with an uncurled edge at the front. If you experience problems with paper feeding, turn the paper around. Note that print quality is not guaranteed.

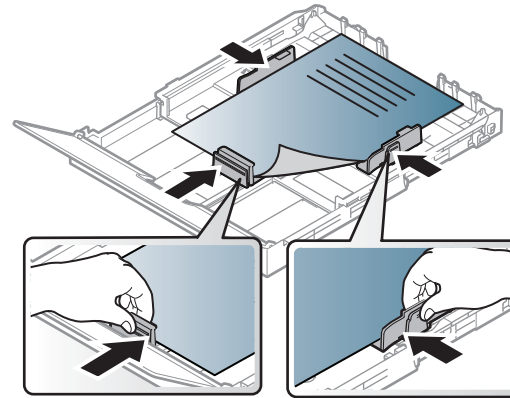

- Must be printed with heat-resistant ink that will not melt, vaporize, or release hazardous emissions when subjected to the machine's fusing temperature for 0.1 second (about 170°C (338°F)).
- Preprinted paper ink must be non-flammable and should not adversely affect machine rollers.
- Before you load preprinted paper, verify that the ink on the paper is dry. During the fusing process, wet ink can come off preprinted paper, reducing print quality.

Media and tray

Setting the paper size and type

After loading paper in the paper tray, set the paper size and type.

The paper setting in the machine and driver should match to print without a paper mismatch error.

To change the paper setting set in the machine, from the **Samsung Easy Printer Manager** select  **(Switch to advanced mode) > Device Settings.**

Then, set the paper type from the **Printing preferences** window > **Paper** tab > **Paper Type** (see "Opening printing preferences" on page 34).



If you want to use special-sized paper such as billing paper, select **Custom** in the **Paper** tab in the **Printing Preferences** (see "Opening printing preferences" on page 34).

Basic printing



For special printing features, refer to the Advanced Guide (see "Using advanced print features" on page 148).

Printing



If you are a Mac or Linux user, refer to the "Mac printing" on page 155 or "Linux printing" on page 157.

The following **Printing Preferences** window is for Notepad in Windows 7.

- 1 Open the document you want to print.
- 2 Select **Print** from the **File** menu.

- 3 Select your machine from the **Select Printer** list.

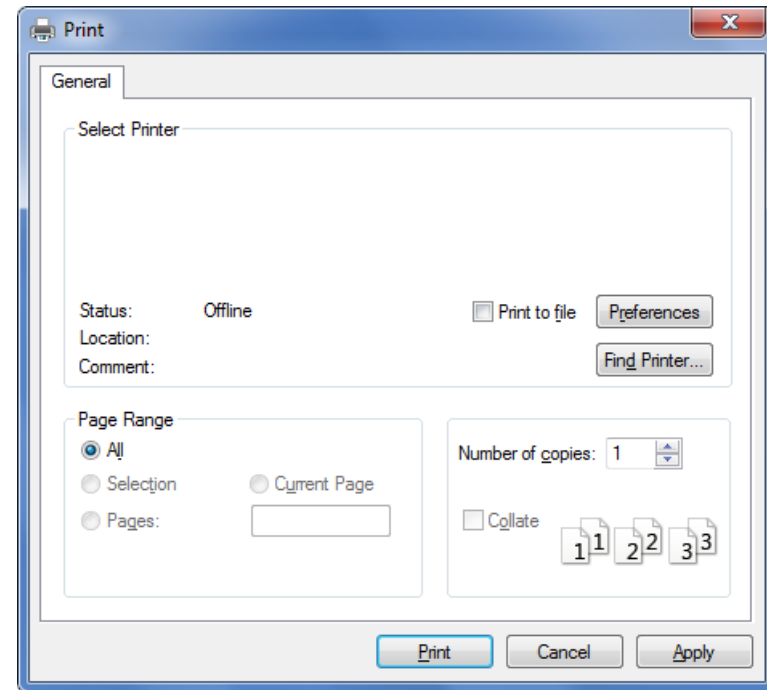

- 4 The basic print settings including the number of copies and print range are selected within the **Print** window.





To take advantage of the advanced printing features, click **Properties** or **Preferences** from the **Print** window (see "Opening printing preferences" on page 34).

- 5 To start the print job, click **OK** or **Print** in the **Print** window.

Basic printing





Canceling a print job

If the print job is waiting in the print queue or print spooler, cancel the job as follows:

- You can access this window by simply double-clicking the machine icon () in the Windows task bar.
- You can also cancel the current job by pressing  (**Cancel**) on the control panel.

Opening printing preferences



- The **Printing Preferences** window that appears in this user's guide may differ depending on the machine in use. However, the composition of the **Printing Preferences** window is similar.
- When you select an option in **Printing Preferences**, you may see a warning mark  or . An  mark means you can select that certain option but it is not recommended, and an  mark means you cannot select that option due to the machine's setting or environment.

- 1 Open the document you want to print.
- 2 Select **Print** from the file menu.
- 3 Select your machine from the **Select Printer**.
- 4 Click **Properties** or **Preferences**.

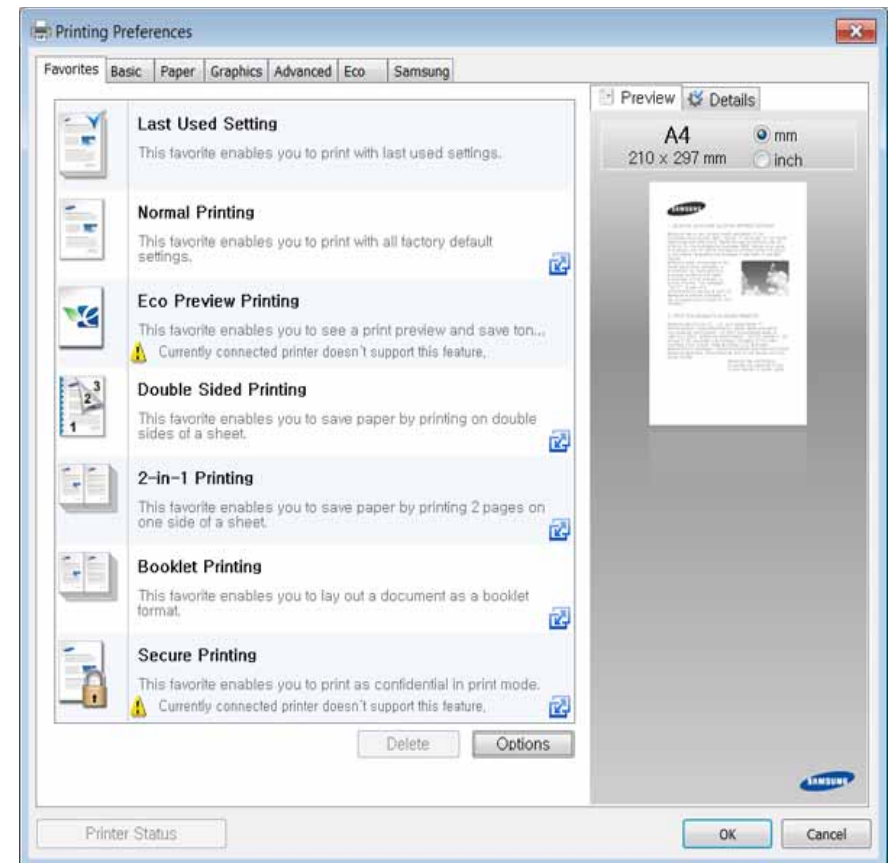

Basic printing



- You can apply **Eco** features to save paper and toner before printing (see "Easy Eco Driver" on page 163).
- You can check the machine's current status using the **Printer Status** button (see "Using Samsung Printer Status" on page 170).

Using a favorite setting

The **Favorites** option, which is visible on each preferences tab except for the **Samsung** tab, allows you to save the current preferences for future use.

To save a **Favorites** item, follow these steps:

- 1 Change the settings as needed on each tab.
- 2 Enter a name for the item in the **Favorites** input box.

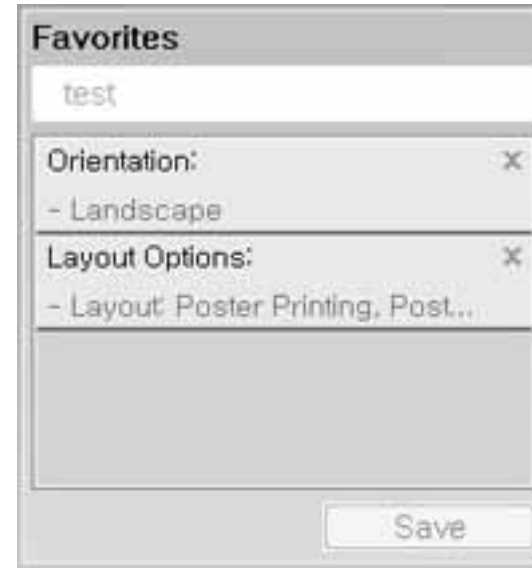

- 3 Click **Save**.
- 4 Enter name and description, and then select the desired icon.
- 5 Click **OK**. When you save **Favorites**, all current driver settings are saved.



To use a saved setting, select it in the **Favorites** tab. The machine is now set to print according to the settings you have selected.

To delete saved settings, select it in the **Favorites** tab and click **Delete**.

Basic printing

Using help

Click the option you want to know on the **Printing Preferences** window and press **F1** on your keyboard.

Eco printing

The **Eco** function cuts toner consumption and paper usage. The **Eco** function allows you to save print resources and lead you to eco-friendly printing. Some features may not be available depending on the model.

Setting Eco mode on the control panel

If you press the **Eco** button from the control panel, eco mode is enabled. The default setting of Eco mode is **Multiple Pages per Side (2)** and **Toner Save**.



You can set the machine's settings by using the **Device Settings** in Samsung Easy Printer Manager program.

- For Windows and Mac users, you set from **Samsung Easy Printer Manager** >  **(Switch to advanced mode)** > **Device Settings**, see "Device Settings" on page 168.

Setting eco mode on the driver

Open the Eco tab to set Eco mode. When you see the eco image () , that means the eco mode is currently enabled.

Another way for Eco printing is to use the Easy Eco Driver application. See "Easy Eco Driver" on page 163.

Eco options

- **Printer Default:** Follows the settings from the machine's control panel.
- **None:** Disables Eco mode.
- **Eco Printing:** Enables eco mode. Activate the various Eco items you want to use.
- **Password:** If the administrator fixed to enable the Eco mode, you have to enter the password to change the status.



Password button: You can set from SyncThru™ Web Service (**Settings** tab > **Machine Settings** > **System** > **Eco** > **Settings**) or Samsung Easy Printer Manager (**Device Settings** > **Eco**), the password button is activated. To change the print settings, click on this button, enter the password or need to contact the administrator.

Basic printing

Result simulator

Result Simulator shows the results of reduced emission of carbon dioxide, used electricity, and the amount of saved paper in accordance with the settings you selected.

- The results are calculated on the basis that the total number of printed paper is one hundred without a blank page when the Eco mode is disabled.
- Refers to the calculation coefficient about CO₂, energy, and paper from **IEA**, the index of Ministry of Internal Affairs and Communication of Japan and www.remanufacturing.org.uk. Each model has a different index.
- The power consumption in printing mode refers to the average printing power consumption of this machine.
- The actual amount displayed is only an estimate as the actual amount may differ depending on the operating system used, computing performance, application software, connection method, media type [thickness], media size, job complexity, etc.



3. Maintenance

This chapter provides information about purchasing supplies, accessories and maintenance parts available for your machine.

- **Ordering supplies and accessories** 39
- **Available supplies** 40
- **Available maintenance parts** 42
- **Storing the toner cartridge** 43
- **Redistributing toner** 45
- **Replacing the toner cartridge** 47
- **Replacing the waste toner container** 49
- **Replacing the imaging unit** 51
- **Cleaning the machine** 53
- **Tips for moving & storing your machine** 55

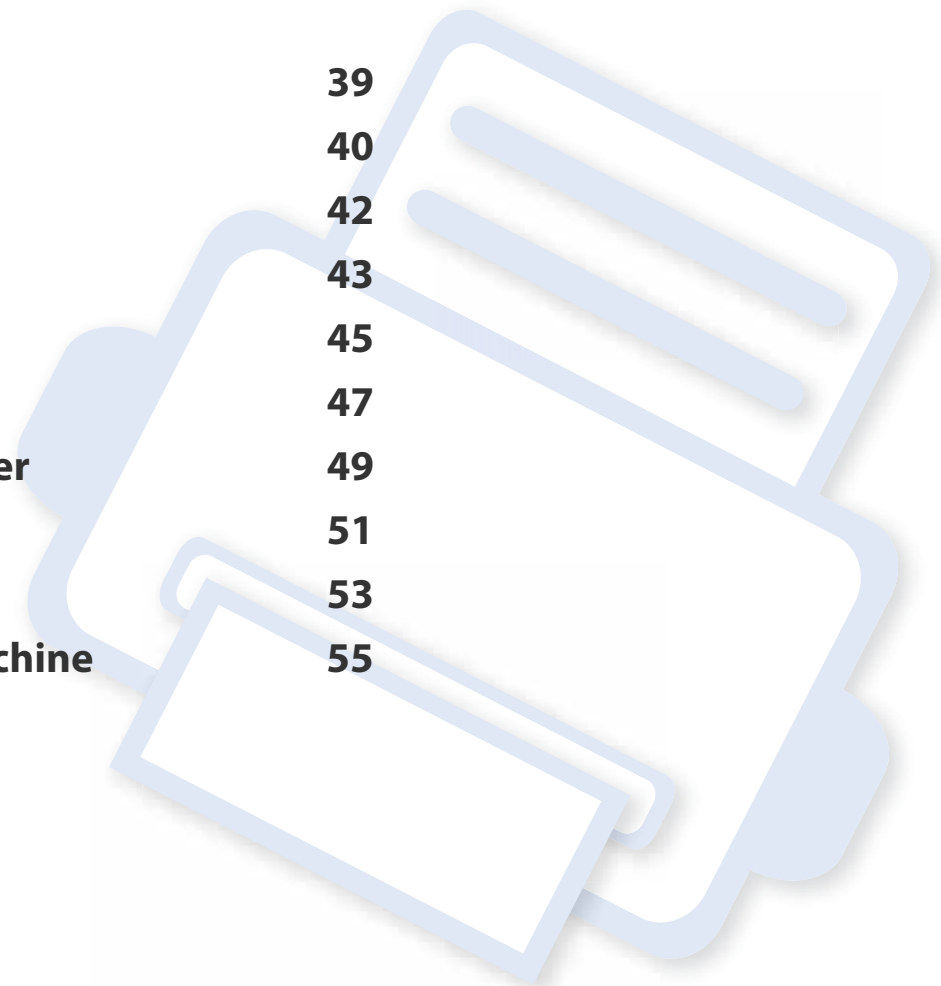

Ordering supplies and accessories



Available accessories may differ from country to country. Contact your sales representatives to obtain the list of available supplies, and maintenance parts.

To order Samsung-authorized supplies, accessories, and maintenance parts, contact your local Samsung dealer or the retailer where you purchased your machine. You can also visit www.samsung.com/supplies, and then select your country/region to obtain the contact information for service.

Available supplies

When supplies reach the end of their life spans, you can order the following types of supplies for your machine:

Type	Average yield ^a	Part name
Toner cartridge	<ul style="list-style-type: none">• Average continuous black cartridge yield: Approx. 1,500 standard pages (Black)• Average continuous color cartridge yield: Approx. 1,000 standard pages (Yellow/Magenta/Cyan)	<ul style="list-style-type: none">• K406 (CLT-K406S): Black• C406 (CLT-C406S): Cyan• M406 (CLT-M406S): Magenta• Y406 (CLT-Y406S): Yellow
Imaging unit	Approx. 16,000 images ^b	CLT-R406
Waste toner container	Approx. 7,000 images ^b	CLT-W406

a. Declared yield value in accordance with ISO/IEC 19798. The number of pages may be affected by operating environment, printing interval, graphics, media type and media size.

b. Image counts based on one color on each page. If you print documents in full color (Cyan, Magenta, Yellow, Black), the life of this item will be reduced by 25%.



Depending on the options, percentage of image area, and job mode used, the toner cartridge's lifespan may differ.



When purchasing new toner cartridges or other supplies, these must be purchased in the same country as the machine you are using. Otherwise, new toner cartridges or other supplies will be incompatible with your machine due to different configurations of toner cartridges and other supplies according to the specific country conditions.

Available supplies



Samsung does not recommend using non-genuine Samsung toner cartridge such as refilled or remanufactured toner. Samsung cannot guarantee non-genuine Samsung toner cartridge's quality. Service or repair required as a result of using non-genuine Samsung toner cartridges will not be covered under the machine's warranty.

Available maintenance parts

To purchase maintenance parts, contact the source where you bought the machine. Replacing maintenance parts can be performed only by an authorized service provider, dealer, or the retailer where you bought the machine. The warranty does not cover the replacement of any maintenance parts once it has reached its “Average yield”.

Maintenance parts are replaced at specific intervals to avoid print quality and paper feed problems resulting from worn parts, see table below. The purpose of which is to maintain your machine in top working condition. The maintenance parts below should be replaced when the life span of each item has been met.

Parts	Average yield^a
Fuser unit	Approx. 20,000 pages for black and white mode or 5,000 pages for color mode
Transfer roller	Approx. 20,000 pages
Feed roller	Approx. 20,000 pages
Pickup roller	Approx. 20,000 pages
Intermediate Transfer Belt (ITB)	Approx. 20,000 pages for black and white mode or 5,000 pages for color mode

a. It will be affected by the operating system used, computing performance, application software, connecting method, media type, media size and job complexity.

Storing the toner cartridge

Toner cartridges contain components that are sensitive to light, temperature and humidity. Samsung suggests users follow these recommendations to ensure optimal performance, highest quality, and longest life from your new Samsung toner cartridge.

Store this cartridge in the same environment in which the printer will be used. This should be in controlled temperature and humidity conditions. The toner cartridge should remain in its original and unopened package until installation – if original packaging is not available, cover the top opening of the cartridge with paper and store in a dark cabinet.

Opening the cartridge package prior to use dramatically shortens its useful shelf and operating life. Do not store on the floor. If the toner cartridge is removed from the printer, follow the instructions below to store the toner cartridge properly.

- Store the cartridge inside the protective bag from the original package.
- Store lying flat (not standing on end) with the same side facing up as if it were installed in the machine.
- Do not store consumables in any of the following conditions:
 - Temperature greater than 40°C (104°F).
 - Humidity range less than 20% and greater than 80%.
 - An environment with extreme changes in humidity or temperature.
 - Direct sunlight or room light.
 - Dusty places.
 - A car for a long period of time.
 - An environment where corrosive gases are present.
 - An environment with salty air.

Storing the toner cartridge

Handling instructions

- Do not touch the surface of the photoconductive drum in the cartridge.
- Do not expose the cartridge to unnecessary vibrations or shock.
- Never manually rotate the drum, especially in the reverse direction; this can cause internal damage and toner spillage.

Toner cartridge usage

Samsung Electronics does not recommend or approve the use of non-Samsung brand toner cartridges in your printer including generic, store brand, refilled, or remanufactured toner cartridges.



Samsung's printer warranty does not cover damage to the machine caused by the use of a refilled, remanufactured, or non-Samsung brand toner cartridges.

Estimated cartridge life

Estimated cartridge life the life of the toner cartridge (or imaging unit) yield depends on the amount of toner that print jobs require. The actual print yield may vary depending on the print density of the pages you print on, operating environment, percentage of image area, printing interval, media type and/or media size. For example, if you print a lot of graphics, the consumption of the toner is higher and you may need to change the cartridge more often.

Redistributing toner

When the toner cartridge is near the end of its life:

- White streaks or light printing occurs and/or density variation side to side.
- The **Toner** LED blinks orange.

If this happens, you can temporarily improve print quality by redistributing the remaining toner in the cartridge. In some cases, white streaks or light printing will still occur even after you have redistributed the toner.



- Before opening the top cover, close the output support first.
- If toner gets on your clothing, wipe it off with a dry cloth and wash clothing in cold water. Hot water sets toner into fabric.
- Printing even after the toner empty status can cause serious damage to your machine.

Redistributing toner

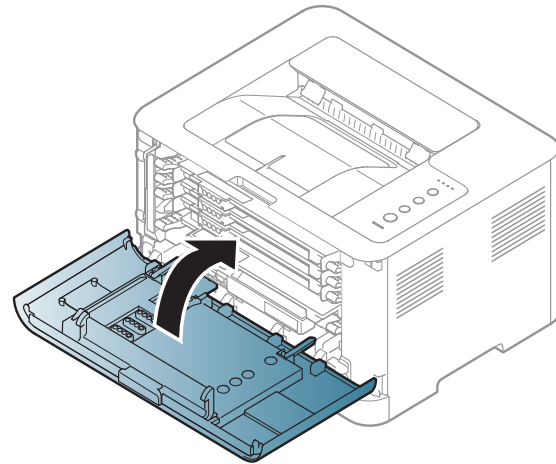
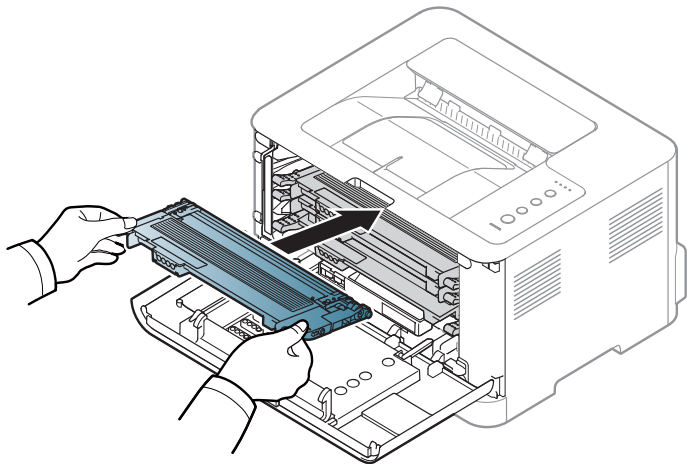
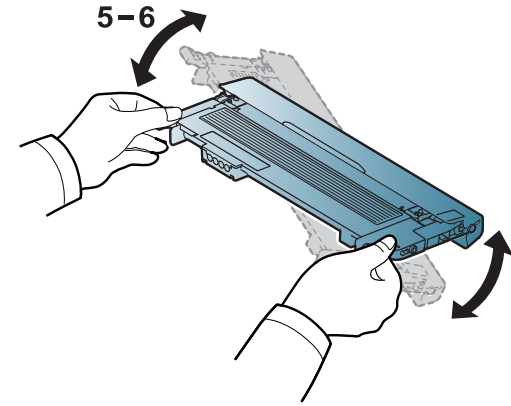
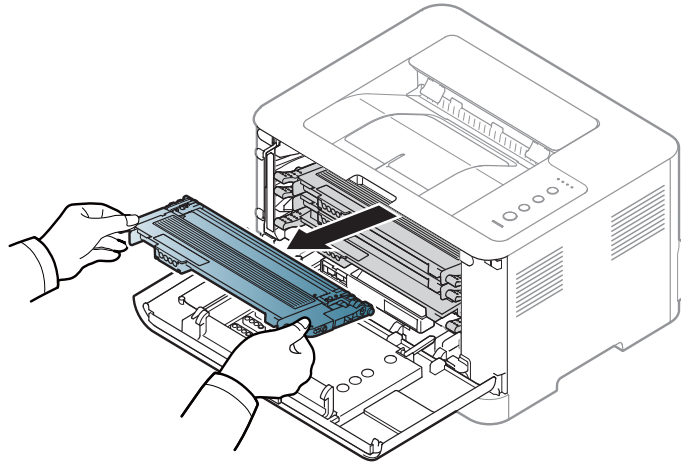
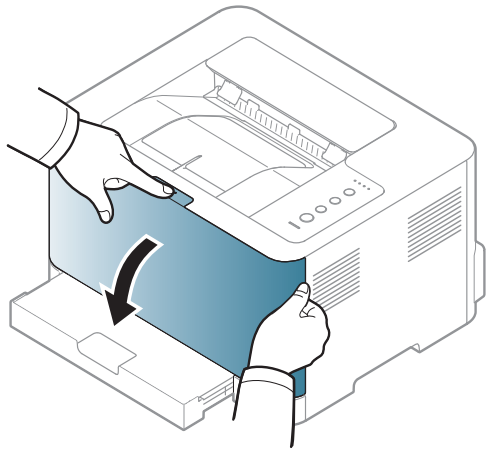

Replacing the toner cartridge



- Before opening the top cover, close the output support first.
- Do not use sharp objects such as a knife or scissors to open the toner cartridge package. They might scratch the drum of the cartridge.
- If toner gets on your clothing, wipe it off with a dry cloth and wash clothing in cold water. Hot water sets toner into fabric.
- Shake the toner cartridge thoroughly, it will increase the initial print quality.
- Do not touch the green underside of the toner cartridge. Use the handle on the cartridge to avoid touching this area.
- Printing even after the toner empty status can cause serious damage to your machine.

Replacing the toner cartridge

When a toner cartridge has reached the end of life, the Printing Status window appears on the computer, indicating the toner cartridge needs to be placed.

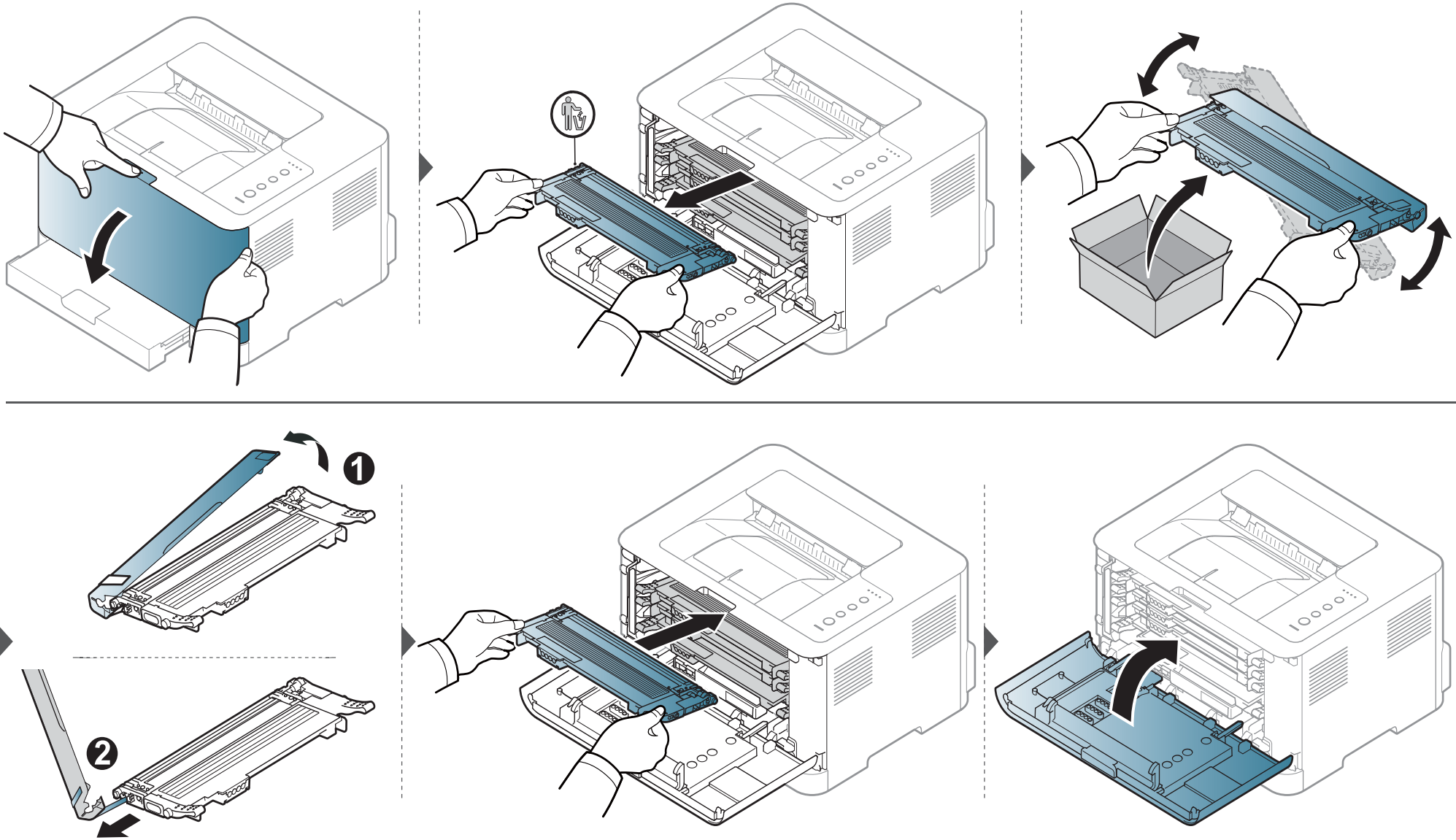

Replacing the waste toner container

When the life span of the waste toner container has expired, the Smart Panel program window appears on the computer, indicating the waste toner container needs to be placed. Otherwise your printer stops printing.



- Toner particles can be released inside the machine but it does not mean the machine is damaged. Contact a service representative when print quality problems occur.
- When you pull out the waste toner container out of the machine, move the container carefully not to drop it from your hands.
- Make sure that you lay the waste toner container on a flat surface so that the toner does not spill.



Do not tilt or turn over the container.

Replacing the waste toner container

The order information is provided for optional accessories (see "Available supplies" on page 40).

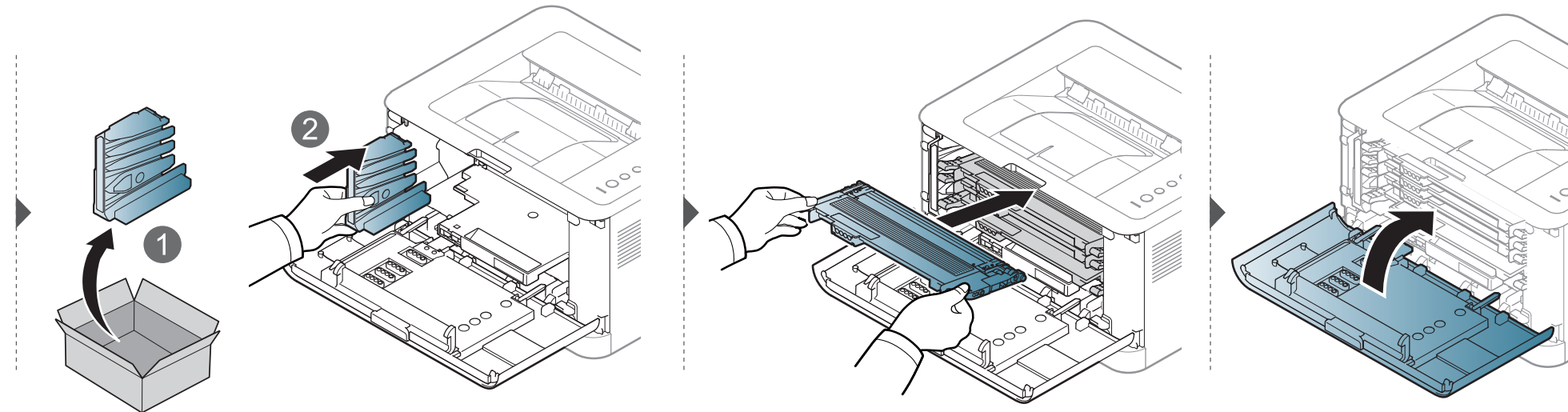
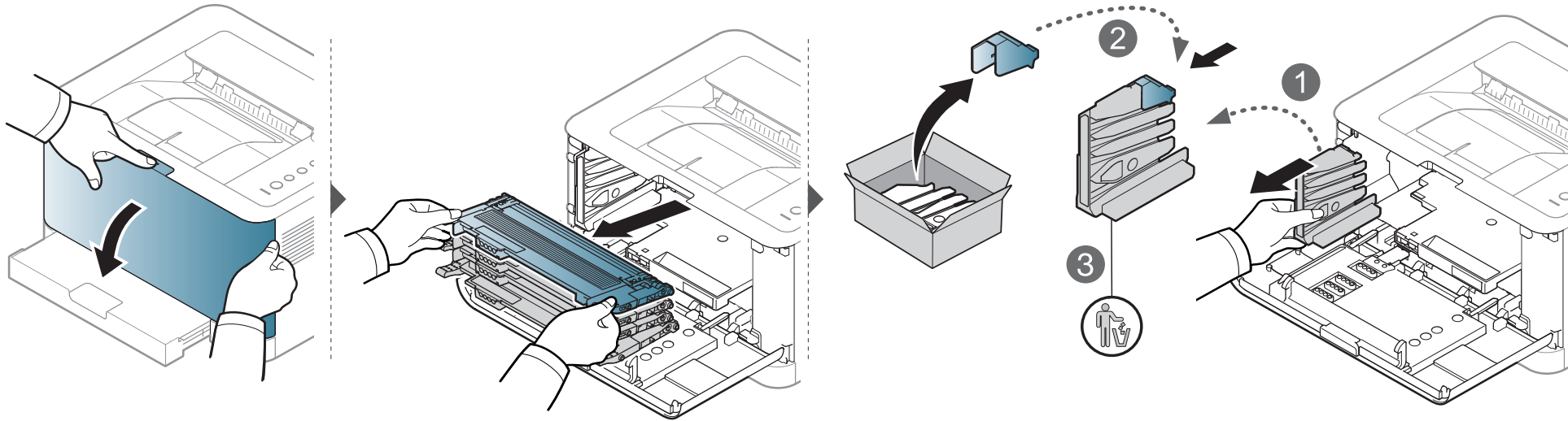

Replacing the imaging unit

When the life span of the imaging unit has expired, the Smart Panel program window appears on the computer, indicating the imaging unit needs to be placed. Otherwise, your machine stops printing.



- Don't use sharp objects such as a knife or scissors to open the imaging unit package. You could damage the surface of the imaging unit.
- Be careful not to scratch the surface of the imaging unit.
- To prevent damage, do not expose the imaging unit to light for more than a few minutes. Cover it with a piece of paper to protect it if necessary.
- Before closing the front cover, make sure all toner cartridges are installed properly.

Replacing the imaging unit

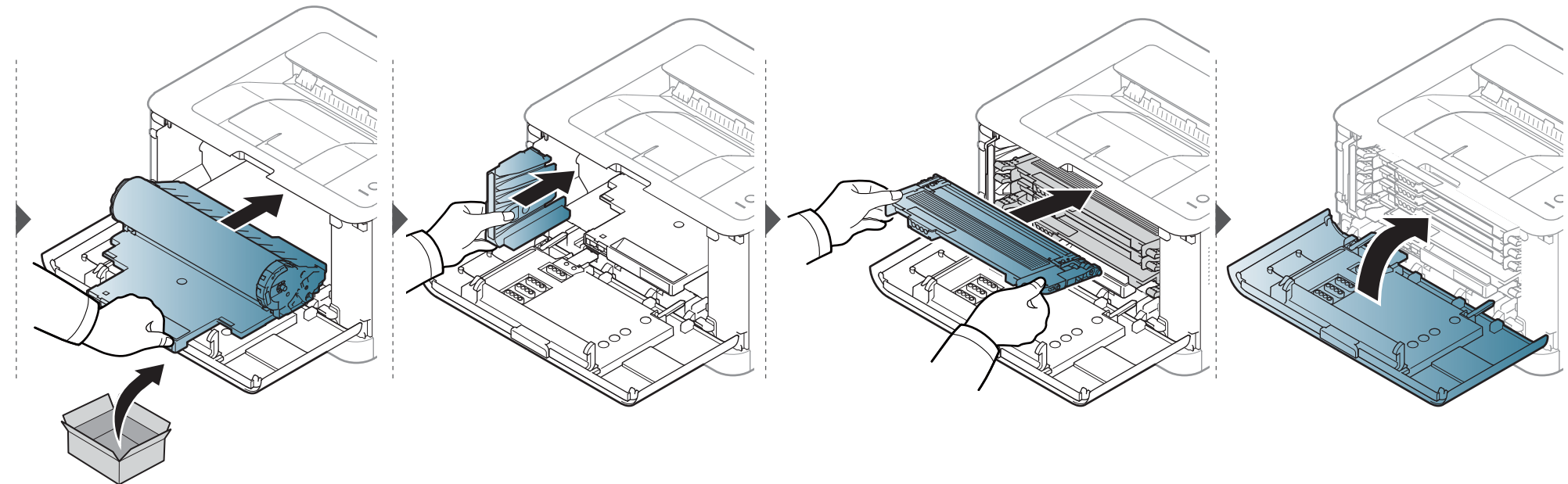
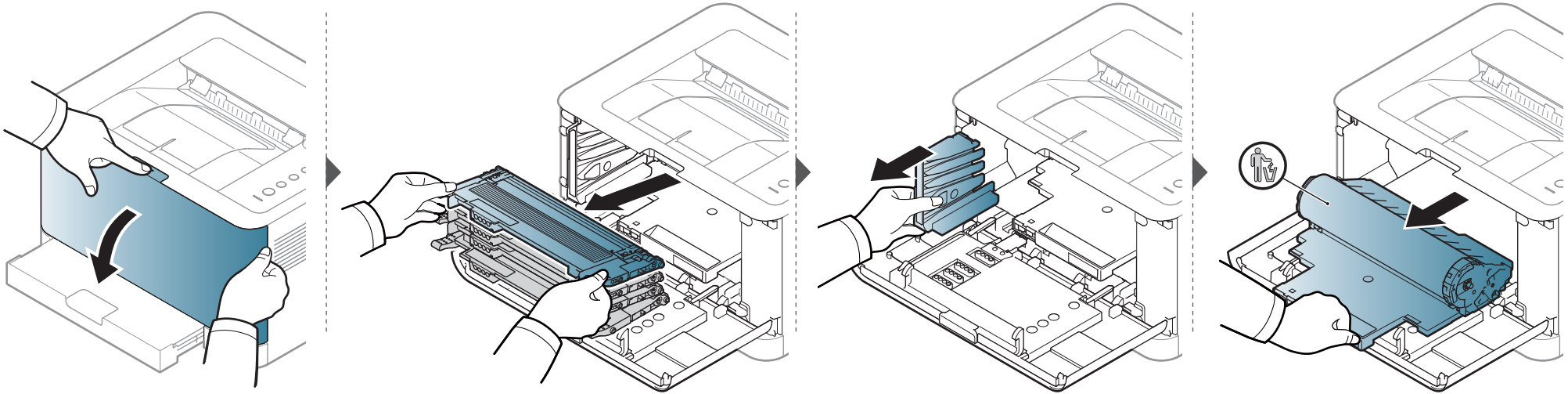

Cleaning the machine

If printing quality problems occur or if you use your machine in a dusty environment, you need to clean your machine regularly to keep it in the best printing condition and use your machine longer.



- Cleaning the cabinet of the machine with cleaning materials containing large amounts of alcohol, solvents, or other strong substances can discolor or distort the cabinet.
- If your machine or the surrounding area is contaminated with toner, we recommend you use a cloth or tissue dampened with water to clean it. If you use a vacuum cleaner, toner blows in the air and might be harmful to you.
- During the printing process, paper, toner, and dust particles can accumulate inside the machine. This buildup can cause print quality problems, such as toner specks or smearing. Cleaning the inside of the machine clears and reduces these problems.

Cleaning the outside

Clean the machine cabinet with a soft, lint-free cloth. Dampen the cloth slightly with water, but be careful not to let any water drip onto or into the machine.

Cleaning the inside

During the printing process, paper, toner, and dust particles can accumulate inside the machine. This buildup can cause print quality problems, such as toner specks or smearing. Cleaning the inside of the machine clears and reduces these problems.

Cleaning the machine



- Use a dry lint-free cloth to clean the machine.
- If your machine has a power switch, turn the power switch off before cleaning the machine.
- Before opening the top cover, close the output support first.

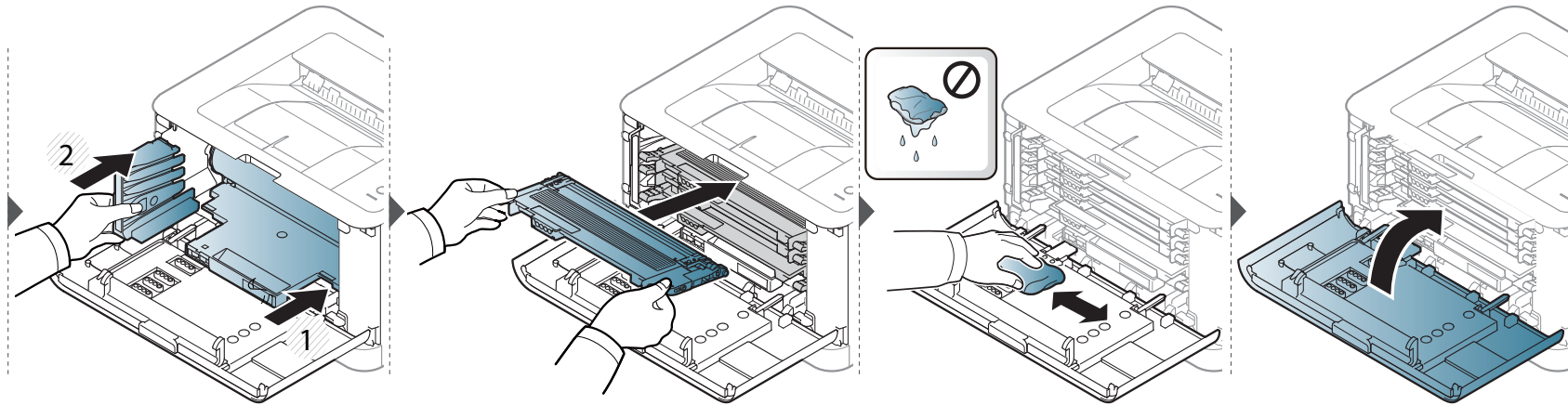
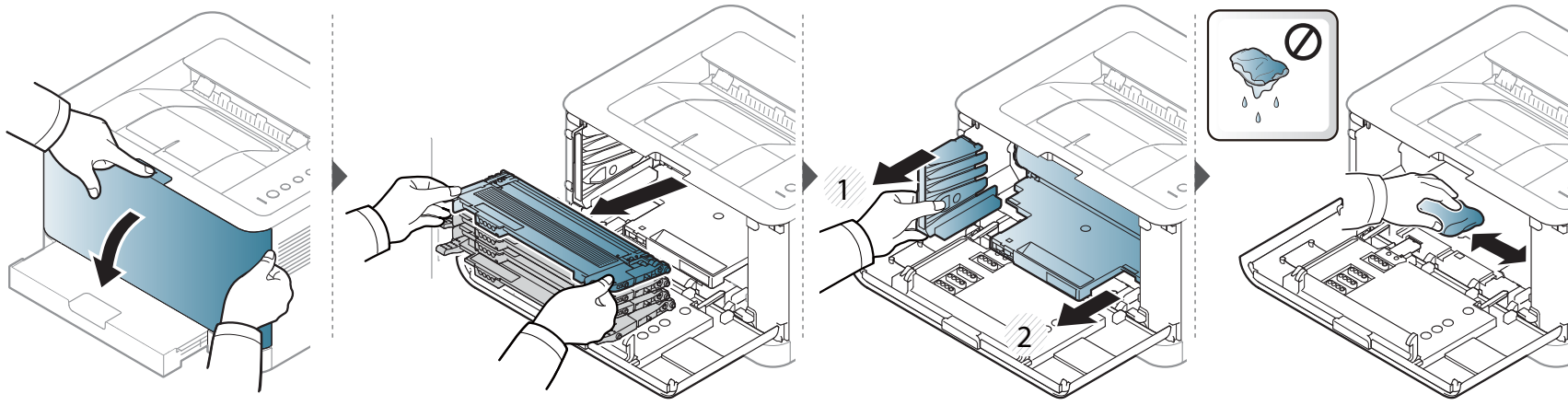

Tips for moving & storing your machine

- When moving the machine, do not tilt or turn it upside down. Otherwise, the inside of the machine may be contaminated by toner, which can cause damage to the machine or reduce print quality.
- When moving the machine, make sure at least two people are holding the machine securely.



4. Troubleshooting

This chapter gives helpful information for what to do if you encounter an error.

- **Tips for avoiding paper jams** 57
- **Clearing paper jams** 58
- **Understanding the status LED** 62



This chapter gives helpful information for what to do if you encounter an error.

If your machine has a display screen, check the message on the display screen first to solve the error. If you cannot find a solution to your problem in this chapter, refer to the **Troubleshooting** chapter in the Advanced User's Guide (see "Troubleshooting" on page 175).

If you cannot find a solution in the User's Guide or the problem persists, call for service.

Tips for avoiding paper jams

By selecting the correct media types, most paper jams can be avoided. To avoid paper jams, refer to the following guidelines:

- Ensure that the adjustable guides are positioned correctly (see "Tray overview" on page 26).
- Do not overload the tray. Ensure that the paper level is below the paper capacity mark on the inside of the tray.
- Do not remove paper from the tray while your machine is printing.
- Flex, fan, and straighten paper before loading.
- Do not use creased, damp, or highly curled paper.
- Do not mix paper types in a tray.
- Use only recommended print media (see "Print media specifications" on page 68).

Clearing paper jams



To avoid tearing the paper, pull the jammed paper out slowly and gently.

Clearing paper jams

In tray

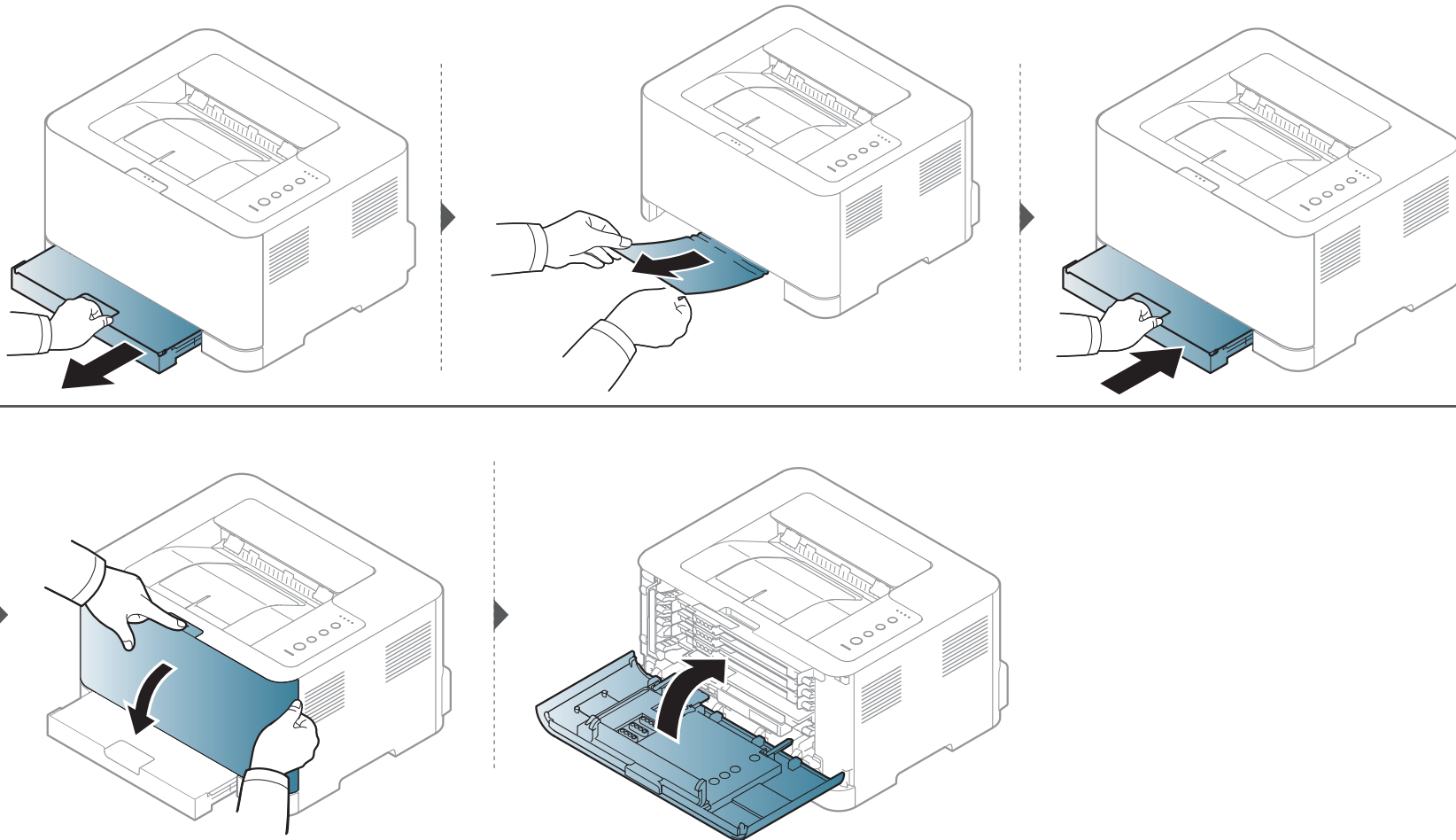

Clearing paper jams

Inside the machine



- The fuser area is hot. Take care when removing paper from the machine.

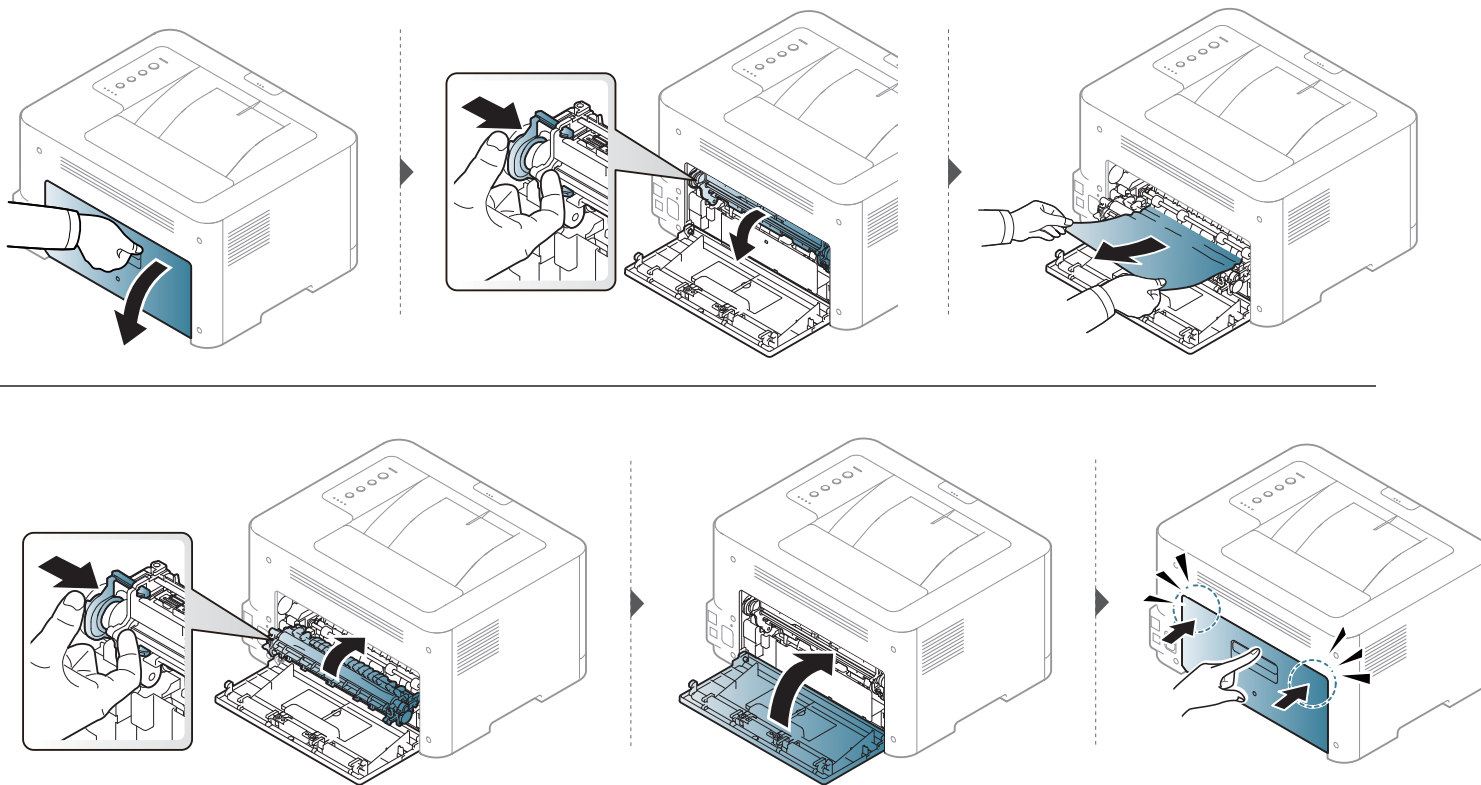

Clearing paper jams

In exit area



- The fuser area is hot. Take care when removing paper from the machine.

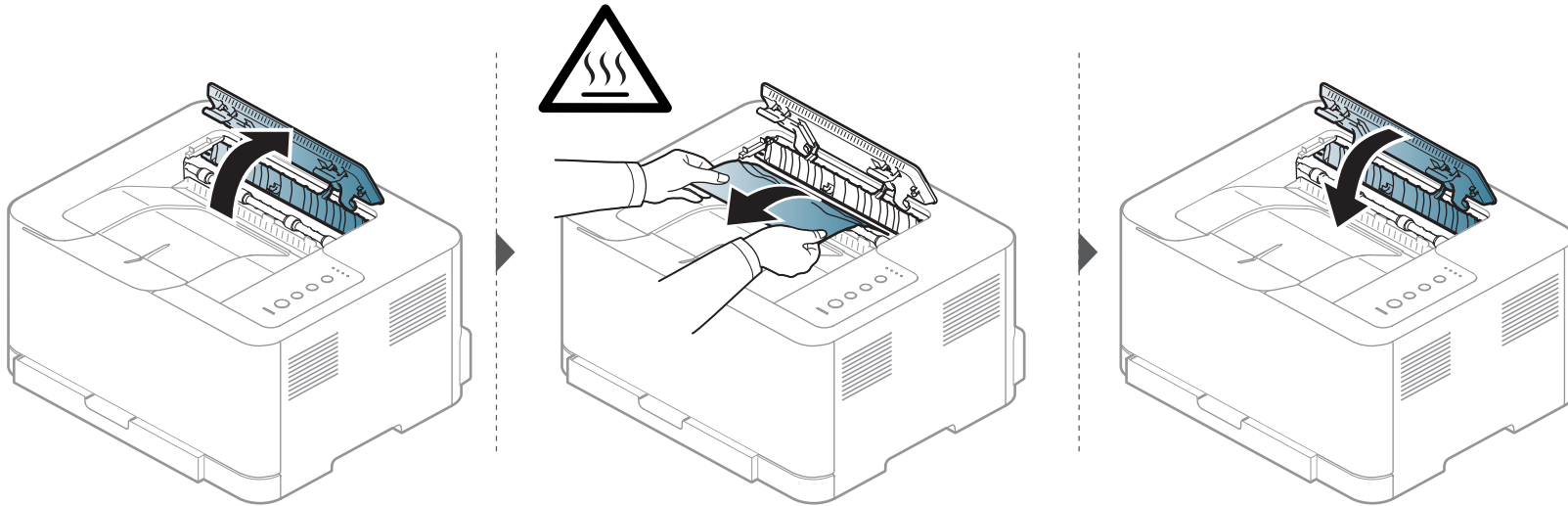

Understanding the status LED

The color of the LED indicates the machine's current status.



- Some LEDs may not be available depending on model or country (see "Control panel overview" on page 20).
- To resolve the error, look at the error message and its instructions from the troubleshooting part (see "Troubleshooting" on page 175).
- You also can resolve the error with the guideline from the computer's Samsung Printing Status program window (see "Using Samsung Printer Status" on page 170).
- If the problem persists, call a service representative.



Understanding the status LED

Status LED

Status		Description	
 (Status LED)	Off	The machine is off-line or save mode.	
	Green	Blinking	<ul style="list-style-type: none">• The machine is receiving data from the computer.• The machine is printing data.
		On	The machine is on-line and can be used.
	Red	Blinking	The machine is on manual printing or manual duplex printing.
		On	<ul style="list-style-type: none">• The cover is opened. Close the cover (see "Machine overview" on page 17).• There is no paper in the tray when receiving or printing data. Load paper in the tray (see "Loading paper in the tray" on page 27).• The machine has stopped due to a major error.
	Orange	Blinking	Upgrading firmware.
		On	A paper jam has occurred (see "Clearing paper jams" on page 58).

Understanding the status LED

Toner / WPS / Power / Eco LED

Status		Description
 (Toner LED)	Orange	Blinking Small amount of toner is left in the cartridge. The estimated cartridge life of toner is close. Prepare a new cartridge for replacement. You may temporarily increase the printing quality by redistributing the toner (see "Redistributing toner" on page 45).
		On <ul style="list-style-type: none"> A toner cartridge has almost reached its estimated cartridge life^a. It is recommended to replace the toner cartridge (see "Replacing the toner cartridge" on page 47). The toner cartridge is not installed or the wrong toner cartridge is installed (see "Replacing the toner cartridge" on page 47).
		Off All toner cartridges are at normal capacity.
 (WPS LED)^b	Blue	Blinking The machine is connecting to a wireless network.
		On The machine is connected to a wireless network (see "Using the WPS button" on page 110).
		Off The machine is disconnected from a wireless network.
 (Power/Wakeup LED)	Blue	On The machine is in power save mode.
		Off The machine is in ready mode or the machine's power is off.
Eco	Green	On Eco mode is on (see "Eco printing" on page 36).
		Off Eco mode is off.

a. Estimated cartridge life means the expected or estimated toner cartridge life, which indicates the average capacity of print-outs and is designed pursuant to ISO/IEC 19798. The number of pages may be affected by operating environment, printing interval, graphics, media type and media size. Some amount of toner may remain in the cartridge even when red LED is on and the printer stops printing.

b. Wireless model only (see "Features by models" on page 6).



5. Appendix

This chapter provides product specifications and information concerning applicable regulations.

- **Specifications** 66
- **Regulatory information** 75
- **Copyright** 85

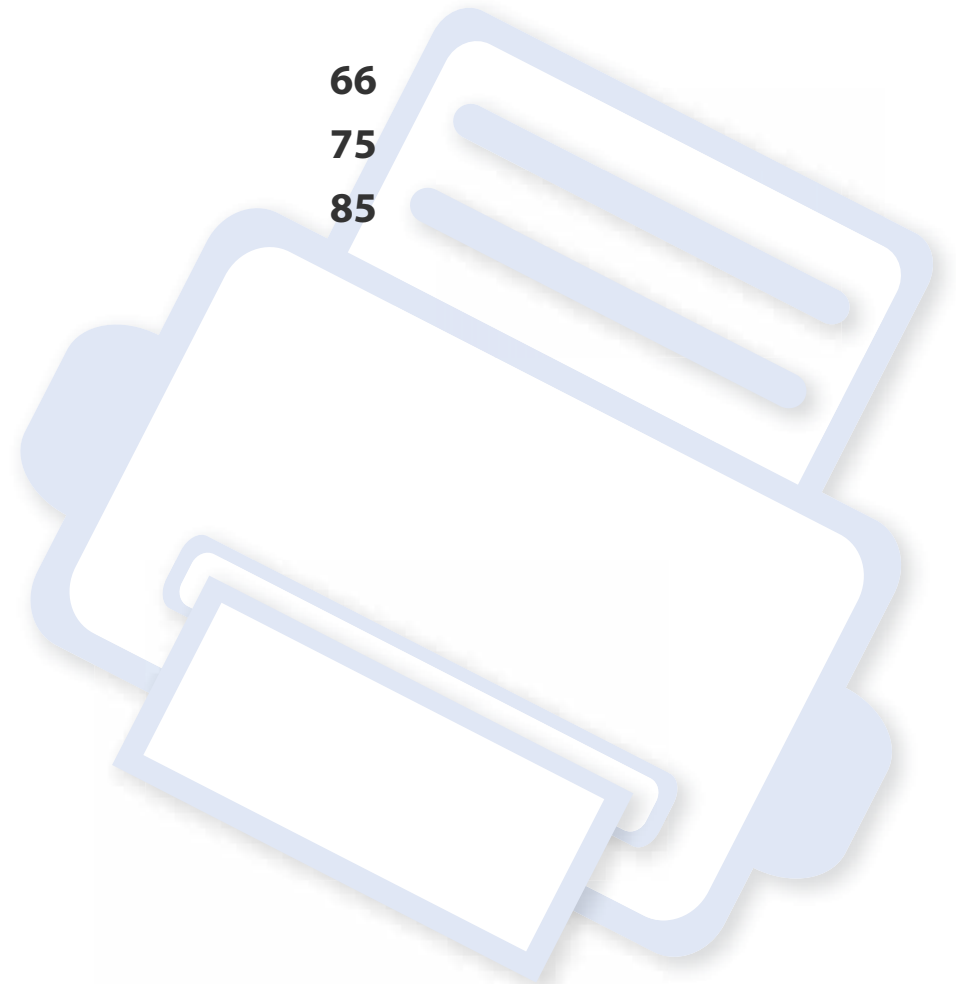

Specifications

General specifications



The specification values listed below are subject to change without notice. See www.samsung.com for possible changes in information.

Items		Description
Dimension	Width x Length x Height	382 x 309 x 211 mm (15.0 x 12.2 x 8.3 inches)
Weight	Machine with consumables	9.84 kg (21.69 lbs)
Noise Level^a	Ready mode	background noise level
	Print mode	<ul style="list-style-type: none">• color printing: Less than 45 dB (A)• black and white printing: Less than 48 dB (A)
Temperature	Operation	10 to 30°C (50 to 86°F)
	Storage (packed)	-20 to 40°C (-4 to 104°F)
Humidity	Operation	20 to 80% RH
	Storage (packed)	10 to 90% RH
Power rating^b	110 volt models	AC 110 - 127 V
	220 volt models	AC 220 - 240 V

Specifications

	Items	Description
Power consumption	Average operating mode	Less than 290W
	Ready mode	Less than 60 W
	Power save mode^c	Less than 1.4 W
	Power off mode^d	0.45 W
Wireless^e	Module	SPW-B4319S

a. Sound Pressure Level, ISO 7779. Configuration tested: basic machine installation, A4 paper, simplex printing.

b. See the rating label on the machine for the correct voltage (V), frequency (hertz) and type of current (A) for your machine.

c. The power consumption of power save mode may be affected by machine's status, setting conditions, operating environment.

d. Power consumption can be completely avoided only when power cable is not connected.

e. Wireless model only (see "Features by models" on page 6).

Specifications

Print media specifications

Type	Size	Dimensions	Print media weight/Capacity ^a
			Tray
Plain paper	Letter	216 x 279 mm (8.5 x 11 inches)	60 to 85 g/m ² (16 to 23 lbs bond)
	Legal	216 x 356 mm (8.5 x 14 inches)	• 150 sheets of 75 g/m ² (20 lbs bond)
	US Folio	216 x 330 mm (8.5 x 13 inches)	
	A4	210 x 297 mm (8.27 x 11.69 inches)	
	Oficio	216 x 343 mm (8.5 x 13.5 inches)	
	JIS B5	182 x 257 mm (7.17 x 10.12 inches)	
	ISO B5	176 x 250 mm (6.93 x 9.84 inches)	
	Executive	184 x 267 mm (7.25 x 10.5 inches)	
	A5	148 x 210 mm (5.83 x 8.27 inches)	
	A6	105 x 148 mm (4.13 x 5.83 inches)	
Thick paper	Refer to the Plain paper section	Refer to the Plain paper section	86 to 120 g/m ² (23 to 32 lbs bond) • 5 sheets
Thin paper	Refer to the Plain paper section	Refer to the Plain paper section	60 to 70 g/m ² (16 to 19 lbs bond) • 150 sheets of 60 g/m ² (16 lbs bond)

Specifications

Type	Size	Dimensions	Print media weight/Capacity ^a
			Tray
Cotton	Refer to the Plain paper section	Refer to the Plain paper section	75 to 90 g/m ² (20 to 24 lbs bond) • 150 sheets of 75 g/m ² (20 lbs bond)
Colored, Pre-printed, Recycled	Refer to the Plain paper section	Refer to the Plain paper section	60 to 85 g/m ² (16 to 24 lbs bond) • 150 sheets of 75 g/m ² (20 lbs bond)
Labels^b	Letter, Legal, Oficio, US Folio, A4, JIS B5, ISO B5, Executive, A5	Refer to the Plain paper section	120 to 150 g/m ² (32 to 40 lbs bond) • 5 sheets
Card stock	Letter, Legal, Oficio, US Folio, A4, JIS B5, ISO B5, Executive, A5, Postcard 4x6	Refer to the Plain paper section	121 to 163 g/m ² (32 to 43 lbs bond) • 5 sheets
Bond paper	Refer to the Plain paper section	Refer to the Plain paper section	105 to 120 g/m ² (28 to 32 lbs bond) • 10 sheets
Archive	Refer to the Plain paper section	Refer to the Plain paper section	70 to 90 g/m ² (18.6 to 24 lbs bond) • 100 sheets
Glossy Photo, Matte Photo	Letter, A4, Postcard 4x6	Refer to the Plain paper section	111 to 220 g/m ² (30 to 58 lbs bond) • 1 sheets

Specifications

Type	Size	Dimensions	Print media weight/Capacity ^a
			Tray
Minimum size (custom)		76 x 152 mm (3 x 6 inches)	60 to 120 g/m ² (16 to 32 lbs bond)
Maximum size (custom)		216 x 356 mm (8.5 x 14 inches)	

a. Maximum capacity may differ depending on media weight, thickness, and environmental conditions.

b. The smoothness of the labels used in this machine is 100 to 250 (sheffield). This means the numeric level of smoothness.

 If media weight is over 120 g/m² (32 lbs bond), load a paper into the tray one by one.

Specifications

System requirements

Microsoft® Windows®

Operating system	Requirement (recommended)		
	CPU	RAM	free HDD space
Windows® XP	Intel® Pentium® III 933 MHz (Pentium IV 1 GHz)	128 MB (256 MB)	1.5 GB
Windows Server® 2003	Intel® Pentium® III 933 MHz (Pentium IV 1 GHz)	128 MB (512 MB)	1.25 GB to 2 GB
Windows Server® 2008	Intel® Pentium® IV 1 GHz (Pentium IV 2 GHz)	512 MB (2 GB)	10 GB
Windows Vista®	Intel® Pentium® IV 3 GHz	512 MB (1 GB)	15 GB
Windows® 7	Intel® Pentium® IV 1 GHz 32-bit or 64-bit processor or higher	1 GB (2 GB)	16 GB
	<ul style="list-style-type: none">• Support for DirectX® 9 graphics with 128 MB memory (to enable the Aero theme).• DVD-R/W Drive		
Windows Server® 2008 R2	Intel® Pentium® IV 1 GHz (x86) or 1.4 GHz (x64) processors (2 GHz or faster)	512 MB (2 GB)	10 GB
Windows® 8	Intel® Pentium® IV 1 GHz 32-bit or 64-bit processor or higher	1 GB (2 GB)	16 GB
	<ul style="list-style-type: none">• Support for DirectX® 9 graphics with 128 MB memory (to enable the Aero theme).• DVD-R/W Drive		

Specifications



- Internet Explorer 6.0 or higher is the minimum requirement for all Windows operating systems.
- Users who have administrator rights can install the software.
- **Windows Terminal Services** is compatible with your machine.

Mac

Operating system	Requirements (Recommended)		
	CPU	RAM	Free HDD space
Mac OS X 10.5	<ul style="list-style-type: none">• Intel® processors• 867 MHz or faster Power PC G4/ G5	512 MB (1 GB)	1 GB
Mac OS X 10.6	<ul style="list-style-type: none">• Intel® processors	1 GB (2 GB)	1 GB
Mac OS X 10.7-10.8	<ul style="list-style-type: none">• Intel® processors	2 GB	4 GB

Specifications

Linux

Items	Requirements
Operating system	Redhat® Enterprise Linux WS 4, 5, 6 (32/64 bit) Fedora 5 ~ 15 (32/64 bit) OpenSuSE® 10.2, 10.3, 11.0, 11.1, 11.2, 11.3, 11.4 (32/64 bit) Mandriva 2007, 2008, 2009, 2009.1, 2010 (32/64 bit) Ubuntu 6.06, 6.10, 7.04, 7.10, 8.04, 8.10, 9.04, 9.10, 10.04, 10.10, 11.04 (32/64 bit) SuSE Linux Enterprise Desktop 10, 11 (32/64 bit) Debian 4.0, 5.0, 6.0 (32/64 bit)
CPU	Pentium IV 2.4GHz (Intel Core™2)
RAM	512 MB (1 GB)
Free HDD space	1 GB (2 GB)

Specifications

Network environment



Network and wireless models only (see "Features by models" on page 6).

You need to set up the network protocols on the machine to use it as your network machine. The following table shows the network environments supported by the machine.

Items	Specifications
Network interface	<ul style="list-style-type: none">• Ethernet 10/100 Base-TX Wired Lan• 802.11b/g/n Wireless LAN
Network operating system	<ul style="list-style-type: none">• Windows® XP, Windows Server® 2003, Windows Vista®, Windows® 7, Windows® 8, Windows Server® 2008 R2• Various Linux OS• Mac OS X 10.5 - 10.8
Network protocols	<ul style="list-style-type: none">• TCP/IPv4• DHCP, BOOTP• DNS, WINS, Bonjour, SLP, UPnP• Standard TCP/IP Printing (RAW), LPR, IPP, WSD• SNMPv 1/2/3, HTTP• TCP/IPv6 (DHCP, DNS, RAW, LPR, SNMPv 1/2/3, HTTP)
Wireless security	<ul style="list-style-type: none">• Authentication: Open System, Shared Key, WPA Personal, WPA2 Personal (PSK)• Encryption: WEP64, WEP128, TKIP, AES

Regulatory information

This machine is designed for a normal work environment and certified with several regulatory statements.

Laser safety statement

The printer is certified in the U.S. to conform to the requirements of DHHS 21 CFR, chapter 1 Subchapter J for Class I(1) laser products, and elsewhere is certified as a Class I laser product conforming to the requirements of IEC 60825-1 : 2007.

Class I laser products are not considered to be hazardous. The laser system and printer are designed so there is never any human access to laser radiation above a Class I level during normal operation, user maintenance or prescribed service condition.

Warning

Never operate or service the printer with the protective cover removed from laser/scanner assembly. The reflected beam, although invisible, can damage your eyes.

When using this product, these basic safety precautions should always be followed to reduce risk of fire, electric shock, and injury to persons:



CAUTION - CLASS 3B, INVISIBLE LASER RADIATION WHEN OPEN, AVOID EXPOSURE TO THE BEAM.
DANGER - INVISIBLE LASER RADIATION WHEN OPEN, AVOID DIRECT EXPOSURE TO BEAM.
DANGER - KLASSE 3B, UNSICHTBARE LASERSTRAHLUNG, WENN OFFEN, STRAHLENAUSSETZUNG VERMEIDEN.
VORSICHT - UNSICHTBARE LASERSTRAHLUNG KLASSE 3 B, WENN ABDECKUNG GEÖFFNET, NICHT DEM STRAHL AUSSETZEN.
ATTENZIONE - CLASSE 3B, RADIAZIONI LASER INVISIBILI CON IL DISPOSITIVO APERTO, EVITARE L'ESPOSIZIONE AL RAGGIO.
PRECAUCIÓN - RADIACIÓN LÁSER INVISIBLE DE CLASE 3B PRESENTE AL ABRIR, EVITE LA EXPOSICIÓN AL HAZ.
PERIGO - CLASSE 3B, RADIAÇÃO LASER INVISÍVEL AO ABRIR, EVITE EXPOSIÇÃO DIRECTA AO FEIXE.
GEVAAR - KLASSE 3B, ONZICHTBARE LASERSTRALING INDIEN GEOPEND, VERMIJD BLOOTSTELLING AAN DE STRAAL.
ADVARSEL - KLASSE 3B, USYNLIG LASERSTRÅLING VED ÅBNING, UNDGÅ UDSÆTTELSE FOR STRÅLING.
ADVARSEL - KLASSE 3B, USYNLIG LASERSTRÅLING NÅR DEKSEL ÅPNES, UNNGÅ EKSPONERING FOR STRÅLEN.
VARNING - KLASSE 3B OSYNLIG LASERSTRÅLNING NÅR DENNA DEL ÄR ÖPPNAD, STRÅLEN ÄR FARLIG.
VAROITUS - LUOKAN 3B NÄKYMÄTTÖMÄLLE LASER-SÄTEILYÄ AVATTUNA, VÄLTÄ ALTISTUMISTA SÄTEELLE.
注意 - CLASS 3B。严禁打开，以免被不可见激光辐射泄漏灼伤
주의 - 열리면 등급 3B 비가시 레이저 방사선 이 방출됩니다. 광선에 노출을 피하십시오.

Ozone safety



This product's ozone emission rate is under 0.1 ppm. Because ozone is heavier than air, keep the product in a place with good ventilation.

Regulatory information

Correct disposal of this product (Waste electrical & electronic equipment)

(Applicable in countries with separate collection systems)



This marking on the product, accessories or literature indicates that the product and its electronic accessories (e.g. charger, headset, USB cable) should not be disposed of with other household waste at the end of their working life. To prevent possible harm to the environment or human health from uncontrolled waste disposal, please separate these items from other types of waste and recycle them responsibly to promote the sustainable reuse of material resources.

Household users should contact either the retailer where they purchased this product, or their local government office, for details of where and how they can take these items for environmentally safe recycling.

Business users should contact their supplier and check the terms and conditions of the purchase contract. This product and its electronic accessories should not be mixed with other commercial wastes for disposal.

The United States of America only

Dispose unwanted electronics through an approved recycler. To find the nearest recycling location, go to our website: www.samsung.com/recyclingdirect Or call, (877) 278 - 0799

State of California Proposition 65 Warning (US Only)

The California Safe Drinking Water and Toxic Enforcement Act requires the Governor of California to publish a list of chemicals known to the State of California to cause cancer or reproductive toxicity and requires businesses to warn of potential exposure to such chemicals.

WARNING: This product contains chemicals known to the State of California to cause cancer, birth defects or other reproductive harm.
This appliance can cause low-level exposure to the chemicals, which can be minimized by operating the appliance in a well ventilated area.

Radio frequency emissions

FCC information to the user

This device complies with Part 15 of the FCC Rules. Operation is subject to the following two conditions:

- This device may not cause harmful interference, and
- This device must accept any interference received, including interference that may cause undesired operation.

Regulatory information

This equipment has been tested and found to comply with the limits for a Class B digital device, pursuant to Part 15 of the FCC Rules. These limits are designed to provide reasonable protection against harmful interference in a residential installation. This equipment generates, uses and can radiate radio frequency energy and, if not installed and used in accordance with the instructions, may cause harmful interference to radio communications. However, there is no guarantee that interference will not occur in a particular installation. If this equipment does cause harmful interference to radio or television reception, which can be determined by turning the equipment off and on, the user is encouraged to try to correct the interference by one or more of the following measures:

- Reorient or relocate the receiving antenna.
- Increase the separation between the equipment and receiver.
- Connect the equipment into an outlet on a circuit different from that to which the receiver is connected.
- Consult the dealer or experienced radio TV technician for help.



Change or modifications not expressly approved by the manufacturer responsible for compliance could void the user's authority to operate the equipment.

Canadian radio interference regulations

This digital apparatus does not exceed the Class B limits for radio noise emissions from digital apparatus as set out in the interference-causing equipment standard entitled "Digital Apparatus", ICES-003 of the Industry and Science Canada.

Cet appareil numérique respecte les limites de bruits radioélectriques applicables aux appareils numériques de Classe B prescrites dans la norme sur le matériel brouilleur: "Appareils Numériques", ICES-003 édictée par l'Industrie et Sciences Canada.

United states of america

Federal communications commission (FCC)

Intentional emitter per FCC Part 15

Low power, Radio LAN type devices (radio frequency (RF) wireless communication devices), operating in the 2.4 GHz/5 GHz Band, may be present (embedded) in your printer system. This section is only applicable if these devices are present. Refer to the system label to verify the presence of wireless devices.

Wireless devices that may be in your system are only qualified for use in the United States of America if an FCC ID number is on the system label.

Regulatory information

The FCC has set a general guideline of 20 cm (8 inches) separation between the device and the body, for use of a wireless device near the body (this does not include extremities). This device should be used more than 20 cm (8 inches) from the body when wireless devices are on. The power output of the wireless device (or devices), which may be embedded in your printer, is well below the RF exposure limits as set by the FCC.

This transmitter must not be collocated or operation in conjunction with any other antenna or transmitter.

Operation of this device is subject to the following two conditions: (1) This device may not cause harmful interference, and (2) this device must accept any interference received, including interference that may cause undesired operation of the device.



Wireless devices are not user serviceable. Do not modify them in any way. Modification to a wireless device will void the authorization to use it. Contact manufacturer for service.

FCC statement for wireless LAN use:



While installing and operating this transmitter and antenna combination the radio frequency exposure limit of 1 m W/cm² may be exceeded at distances close to the antenna installed. Therefore, the user must maintain a minimum distance of 20cm from the antenna at all times. This device cannot be collocated with another transmitter and transmitting antenna.

Russia only



Germany only

Das Gerät ist nicht für die Benutzung am Bildschirmarbeitsplatz gemäß BildscharbV vorgesehen.

Regulatory information

Turkey only

- RoHS
EEE Yönetmeliğine Uygundur.
This EEE is compliant with RoHS.
- Bu ürünün ortalama yaşam süresi 7 yıl, garanti süresi 2 yıldır.

Thai only

This telecommunication equipment conforms to NTC technical requirement.

Replacing the fitted plug (for UK only)

Important

The mains lead for this machine is fitted with a standard (BS 1363) 13 amp plug and has a 13 amp fuse. When you change or examine the fuse, you must re-fit the correct 13 amp fuse. You then need to replace the fuse cover. If you have lost the fuse cover, do not use the plug until you have another fuse cover.

Contact the people from you purchased the machine.

The 13 amp plug is the most widely used type in the UK and should be suitable. However, some buildings (mainly old ones) do not have normal 13 amp plug sockets. You need to buy a suitable plug adaptor. Do not remove the moulded plug.



If you cut off the moulded plug, get rid of it straight away.

You cannot rewire the plug and you may receive an electric shock if you plug it into a socket.

Important warning:



You must earth this machine.

The wires in the mains lead have the following color code:

- **Green and Yellow:** Earth
- **Blue:** Neutral
- **Brown:** Live

If the wires in the mains lead do not match the colors marked in your plug, do the following:

You must connect the green and yellow wire to the pin marked by the letter “E” or by the safety ‘Earth symbol’ or colored green and yellow or green.

You must connect the blue wire to the pin which is marked with the letter “N” or colored black.

Regulatory information

You must connect the brown wire to the pin which is marked with the letter “L” or colored red.

You must have a 13 amp fuse in the plug, adaptor, or at the distribution board.

Declaration of conformity (European countries)

Approvals and Certifications



Hereby, Samsung Electronics, declares that this [Xpress C41xW] is in compliance with the essential requirements and other relevant provisions of R&TTE Directive 1999/5/EC.

The declaration of conformity may be consulted at **www.samsung.com**, go to Support > Download center and enter your printer (MFP) name to browse the EuDoC.

January 1, 1995: Council Directive 2006/95/EC Approximation of the laws of the member states related to low voltage equipment.

January 1, 1996: Council Directive 2004/108/EC, approximation of the laws of the Member States related to electromagnetic compatibility.

March 9, 1999: Council Directive 1999/5/EC on radio equipment and telecommunications terminal equipment and the mutual recognition of their conformity. A full declaration, defining the relevant Directives and referenced standards can be obtained from your Samsung Electronics Co., Ltd. representative.

EC Certification

Certification to 1999/5/EC Radio Equipment & Telecommunications Terminal Equipment Directive (FAX)

This Samsung product has been self-certified by Samsung for pan-European single terminal connection to the analogue public switched telephone network (PSTN) in accordance with Directive 1999/5/EC. The product has been designed to work with the national PSTNs and compatible PBXs of the European countries:

In the event of problems, you should contact the Euro QA Lab of Samsung Electronics Co., Ltd. in the first instance.

The product has been tested against TBR21. To assist in the use and application of terminal equipment which complies with this standard, the European Telecommunication Standards Institute (ETSI) has issued an advisory document (EG 201 121) which contains notes and additional requirements to ensure network compatibility of TBR21 terminals. The product has been designed against, and is fully compliant with, all of the relevant advisory notes contained in this document.

Regulatory information

European radio approval information (for products fitted with EU-approved radio devices)

Low power, Radio LAN type devices (radio frequency (RF) wireless communication devices), operating in the 2.4 GHz/5 GHz band, may be present (embedded) in your printer system which is intended for home or office use. This section is only applicable if these devices are present. Refer to the system label to verify the presence of wireless devices.



Wireless devices that may be in your system are only qualified for use in the European Union or associated areas if a CE mark is on the system label.

The power output of the wireless device or devices that may be embedded in your printer is well below the RF exposure limits as set by the European Commission through the R&TTE directive.

European states qualified under wireless approvals:

EU countries

European states with restrictions on use:

EU

EEA/EFTA countries

No limitations at this time

Regulatory compliance statements

Wireless guidance

Low power, Radio LAN type devices (radio frequency (RF) wireless communication devices), operating in the 2.4 GHz/5 GHz Band, may be present (embedded) in your printer system. The following section is a general overview of considerations while operating a wireless device.

Additional limitations, cautions, and concerns for specific countries are listed in the specific country sections (or country group sections). The wireless devices in your system are only qualified for use in the countries identified by the Radio Approval Marks on the system rating label. If the country you will be using the wireless device in, is not listed, contact your local Radio Approval agency for requirements. Wireless devices are closely regulated and use may not be allowed.

The power output of the wireless device or devices that may be embedded in your printer is well below the RF exposure limits as known at this time. Because the wireless devices (which may be embedded into your printer) emit less energy than is allowed in radio frequency safety standards and recommendations, manufacturer believes these devices are safe for use. Regardless of the power levels, care should be taken to minimize human contact during normal operation.

Regulatory information

As a general guideline, a separation of 20 cm (8 inches) between the wireless device and the body, for use of a wireless device near the body (this does not include extremities) is typical. This device should be used more than 20 cm (8 inches) from the body when wireless devices are on and transmitting.

This transmitter must not be collocated or operation in conjunction with any other antenna or transmitter.

Some circumstances require restrictions on wireless devices. Examples of common restrictions are listed below:



Radio frequency wireless communication can interfere with equipment on commercial aircraft. Current aviation regulations require wireless devices to be turned off while traveling in an airplane. IEEE 802.11 (also known as wireless Ethernet) and Bluetooth communication devices are examples of devices that provide wireless communication.



In environments where the risk of interference to other devices or services is harmful or perceived as harmful, the option to use a wireless device may be restricted or eliminated. Airports, Hospitals, and Oxygen or flammable gas laden atmospheres are limited examples where use of wireless devices may be restricted or eliminated. When in environments where you are uncertain of the sanction to use wireless devices, ask the applicable authority for authorization prior to use or turning on the wireless device.



Every country has different restrictions on the use of wireless devices. Since your system is equipped with a wireless device, when traveling between countries with your system, check with the local Radio Approval authorities prior to any move or trip for any restrictions on the use of a wireless device in the destination country.



If your system came equipped with an internal embedded wireless device, do not operate the wireless device unless all covers and shields are in place and the system is fully assembled.



Wireless devices are not user serviceable. Do not modify them in any way. Modification to a wireless device will void the authorization to use it. Contact manufacturer for service.



Only use drivers approved for the country in which the device will be used. See the manufacturer System Restoration Kit, or contact manufacturer Technical Support for additional information.

Israel only

מס' אישור אלחוטי של משרד התקשורת הוא 51-29003
אסור להחליף את האנטנה המקורית של המכשיר,
ולא לעשות בו כל שינוי טכני אחר.

Regulatory information

China only

产品中有毒有害物质或元素的名称及含量

部件名称	有毒有害物质或元素					
	铅 (Pb)	汞 (Hg)	镉 (Cd)	六价铬 (Cr ⁶⁺)	多溴联苯 (PBB)	多溴联苯醚 (PBDE)
塑料	○	○	○	○	○	○
金属 (机箱)	X	○	○	○	○	○
印刷电路部件 (PCA)	X	○	○	○	○	○
电缆 / 连接器	X	○	○	○	○	○
电源设备	X	○	○	○	○	○
电源线	X	○	○	○	○	○
机械部件	X	○	○	○	○	○
卡盒部件	X	○	○	○	○	○
定影部件	X	○	○	○	○	○
扫描仪部件 - CCD (如果有)	X	X	○	○	○	○
扫描仪部件 - 其它 (如果有)	X	○	○	○	○	○
印刷电路板部件 (PBA)	X	○	○	○	○	○
墨粉	○	○	○	○	○	○
滚筒	○	○	○	○	○	○

○：表示该有毒有害物质在该部件所有均质材料中的含量均在 SJ/T 11363-2006 标准规定的限量要求以下。

×：表示该有毒有害物质至少在该部件的某一均质材料中的含量超出 SJ/T 11363-2006 标准规定的限量要求。

以上表为目前本产品含有有毒有害物质的信息。本信息由本公司的配套厂家提供，经本公司审核后而做成，本产品的部分部件含有有毒有害物质，这些部件是在现有科学技术水平下暂时无可替代物质，但三星电子将会一直为满足 SJ/T 11363-2006 标准而做不懈的努力。

Copyright

© 2013 Samsung Electronics Co., Ltd. All rights reserved.

This user's guide is provided for information purposes only. All information included herein is subject to change without notice.

Samsung Electronics is not responsible for any direct or indirect damages, arising from or related to use of this user's guide.

- Samsung and the Samsung logo are trademarks of Samsung Electronics Co., Ltd.
- Microsoft, Windows, Windows Vista, Windows 7, Windows 8 and Windows Server 2008 R2 are either registered trademarks or trademarks of Microsoft Corporation.
- Google, Picasa, Google Docs, Android and Gmail are either registered trademarks or trademarks of Google Inc.
- Google Cloud Print is a trademark of Google Inc.
- iPad, iPhone, iPod touch, Mac and Mac OS are trademarks of Apple Inc., registered in the U.S and other countries. AirPrint and the AirPrint logo are trademarks of Apple Inc.
- All other brand or product names are trademarks of their respective companies or organizations.

Refer to the '**LICENSE.txt**' file in the provided CD-ROM for the open source license information.

REV.1.01

User's Guide

Samsung Printer *Xpress*

C41x series

ADVANCED

This guide provides information about installation, advanced configuration, operation and troubleshooting on various OS environments.

Some features may not be available depending on models or countries.

BASIC

This guide provides information concerning installation, basic operation and troubleshooting on windows.



1. Software installation

Installation for Mac	90
Reinstallation for Mac	91
Installation for Linux	92
Reinstallation for Linux	93



2. Using a network-connected

Useful network programs	95
Wired network setup	96
Installing driver over the network	99
IPv6 configuration	104
Wireless network setup	107
Samsung Mobile Print	139
Using the NFC feature	140
Google Cloud Print	142



3. Special features

Altitude adjustment	145
---------------------	-----

Changing the default print settings	146
Setting your machine as a default machine	147
Using advanced print features	148
Mac printing	155
Linux printing	157



4. Useful management tools

Easy Capture Manager	160
Samsung Easy Color Manager	161
Samsung AnyWeb Print	162
Easy Eco Driver	163
Using SyncThru™ Web Service	164
Using Samsung Easy Printer Manager	167
Using Samsung Printer Status	170
Using the Linux Unified Driver Configurator	172



5. Troubleshooting

Paper feeding problems	176
Power and cable connecting problems	177
Printing problems	178
Printing quality problems	182

ADVANCED

Operating system problems

190



1. Software installation

This chapter provides instructions for installing essential and helpful software for use in an environment where the machine is connected via a cable. A locally connected machine is a machine directly attached to your computer using the cable. If your machine is attached to a network, skip the following steps below and go on to installing a network connected machine's driver (see Installing driver over the network⁹⁹).

- **Installation for Mac** **90**
- **Reinstallation for Mac** **91**
- **Installation for Linux** **92**
- **Reinstallation for Linux** **93**



- If you are a Windows OS user, refer to the "Installing the driver locally" on page 22 for installing the machine's driver.
- Only use a USB cable no longer than 3 meter (118 inches).

Installation for Mac

1 Make sure that the machine is connected to your computer and powered on.

2 Insert the supplied software CD into your CD-ROM drive.

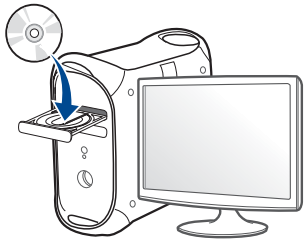

3 Double-click the CD-ROM icon that appears on your Mac desktop.

- For Mac OS X 10.8, double-click the CD-ROM that appears on **Finder**.

4 Double-click the **MAC_Installer** folder > **Installer OS X** icon.

5 Click **Continue**.

6 Read the license agreement and click **Continue**.

7 Click **Agree** to agree to the license agreement.

8 Click **Install**. All components necessary for machine operations will be installed.

If you click **Customize**, you can choose individual components to install.

9 Enter the password and click **OK**.

10 Select **USB Connected Printer** on the **Printer Connection Type** and click **Continue**.

11 Click **Add Printer** button to select your printer and add it to your printer list.

12 After the installation is finished, click **Close**.

Reinstallation for Mac

If the printer driver does not work properly, uninstall the driver and reinstall it.

- 1 Open the **Applications** folder > **Samsung** > **Printer Software Uninstaller**.
- 2 To uninstall printer software, click **Continue**.
- 3 Check the program you want to delete and click **Uninstall**.
- 4 Enter the password and click **OK**.
- 5 After the uninstallation is finished, click **Close**.



If a machine has already been added, delete it from the **Print Setup Utility** or **Print & Fax**.

Installation for Linux

You need to download Linux software packages from the Samsung website to install the printer software (<http://www.samsung.com> > find your product > Support or Downloads).

The installation program added the Unified Driver Configurator desktop icon and the Unified Driver group to the system menu for your convenience. If you have any difficulties, consult the on-screen help that is available through your system menu or from the driver package Windows applications, such as **Unified Driver Configurator** or **Image Manager**.

Installing the Unified Linux Driver

- 1 Make sure that the machine is connected to your computer and powered on.
- 2 When the **Administrator Login** window appears, type "root" in the **Login** field and enter the system password.



You must log in as a super user (root) to install the machine software. If you are not a super user, ask your system administrator.

- 3 From the Samsung website, download the Unified Linux Driver package to your computer.
- 4 Right-click the **Unified Linux Driver** package and extract the package.
- 5 Double click **cdroot** > **autorun**.
- 6 When the welcome screen appears, click **Next**.
- 7 When the installation is complete, click **Finish**.

Reinstallation for Linux

If the printer driver does not work properly, uninstall the driver and reinstall it.

- 1 Make sure that the machine is connected to your computer and powered on.
- 2 When the **Administrator Login** window appears, type "root" in the **Login** field and enter the system password.
You must log in as a super user (root) to uninstall the printer driver. If you are not a super user, ask your system administrator.
- 3 Open the Terminal program. When the Terminal screen appears, type in the following.

```
[root@localhost root]#cd /opt/Samsung/mfp/uninstall/  
[root@localhost uninstall]#./uninstall.sh
```
- 4 Click **Next**.
- 5 Click **Finish**.



2. Using a network-connected machine

This chapter gives you step-by-step instructions for setting up a network connected machine and software.

- **Useful network programs** 95
- **Wired network setup** 96
- **Installing driver over the network** 99
- **IPv6 configuration** 104
- **Wireless network setup** 107
- **Samsung Mobile Print** 139
- **Using the NFC feature** 140
- **Google Cloud Print** 142



Supported optional devices and features may differ according to your model (see "Features by models" on page 6).

Useful network programs

There are several programs available to setup the network settings easily in a network environment. For the network administrator especially, managing several machines on the network is possible.



- Before using the programs below, set the IP address first.
- Some features and optional goods may not be available depending on model or country (see "Features by models" on page 6).

SyncThru™ Web Service

The web server embedded on your network machine allows you to do the following tasks (see "Using SyncThru™ Web Service" on page 106):

- Check the supplies information and status.
- Customize machine settings.
- Set the email notification option. When you set this option, the machine status (toner cartridge shortage or machine error) will be sent to a certain person's email automatically.
- Configure the network parameters necessary for the machine to connect to various network environments.

SyncThru™ Web Admin Service

Web-based machine management solution for network administrators. SyncThru™ Web Admin Service provides you with an efficient way of managing network devices and lets you remotely monitor and troubleshoot network machines from any site with corporate internet access.

- Download this program from <http://solution.samsungprinter.com>.

SetIP

This utility program allows you to select a network interface and manually configure the IP addresses for use with the TCP/IP protocol.

- See "IPv4 configuration using SetIP (Windows)" on page 96.
- See "IPv4 configuration using SetIP (Mac)" on page 97.
- See "IPv4 configuration using SetIP (Linux)" on page 98.



- The machine that does not support the network interface, it will not be able to use this feature (see "Rear view" on page 19).
- TCP/IPv6 is not supported by this program.

Wired network setup

You must set up the network protocols on your machine to use it on your network.

You can use network after connecting network cable to a corresponding port on your machine.

- For models that do not have the display screen on the control panel, use the SyncThru™ Web Service or SetIP program.
 - See "Using SyncThru™ Web Service" on page 164.
 - See "Setting IP address" on page 96.

Printing a network configuration report

You can print **Network Configuration Report** from the machine's control panel that will show the current machine's network settings. This will help you to set up a network.

- **The machine does not have the display screen:** Press the ⊗ (**Cancel** or **Stop/Clear**) button for two seconds on the control panel.

Using this **Network Configuration Report**, you can find your machine's MAC address and IP address.

For example:

- MAC Address: 00:15:99:41:A2:78
- IP Address: 165.254.192.192

Setting IP address



- The machine that does not support the network interface, it will not be able to use this feature (see "Rear view" on page 19)
- TCP/IPv6 is not supported by this program.

First, you have to set up an IP address for network printing and managements. In most cases a new IP address will be automatically assigned by a DHCP (Dynamic Host Configuration Protocol) server located on the network.

IPv4 configuration using SetIP (Windows)

Before using the SetIP program, disable the computer firewall from **Control Panel > Security Center > Windows Firewall**.



The following instructions may differ for your model.

- 1 Download the software from the Samsung website then unpack and install it: (<http://www.samsung.com> > find your product > Support or Downloads).
- 2 Follow the instructions in the installation window.
- 3 Connect your machine to the network with a network cable.

Wired network setup

- 4 Turn on the machine.
- 5 From the Windows **Start** menu, select **All Programs > Samsung Printers > SetIP > SetIP**.
- 6 Click the  icon (third from left) in the SetIP window to open the TCP/IP configuration window.
- 7 Enter the machine's new information into the configuration window. In a corporate intranet, you may need to have this information assigned by a network manager before proceeding.



Find the machine's MAC address from the **Network Configuration Report** (see "Printing a network configuration report" on page 96) and enter it without the colons. For example, 00:15:99:29:51:A8 becomes 0015992951A8.

- 8 Click **Apply**, and then click **OK**. The machine will automatically print the **Network Configuration Report**. Confirm that all the settings are correct.

IPv4 configuration using SetIP (Mac)

Before using the SetIP program, disable the computer firewall from **System Preferences > Security > Firewall**.



The following instructions may vary from your model.

- 1 Connect your machine to the network with a network cable.
- 2 Insert the supplied software CD into your CD-ROM drive.

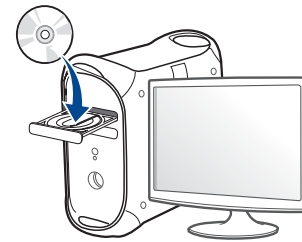

- 3 Double-click the CD-ROM icon that appears on your Mac desktop.
 - For Mac OS X 10.8, Double-click the CD-ROM that appears on Finder.
- 4 Double-click the **MAC_Installer** folder > **Installer OS X** icon.
- 5 Click **Continue**.
- 6 Read the license agreement and click **Continue**.
- 7 Click **Agree** to agree to the license agreement.
- 8 Click **Install**. All components necessary for machine operations will be installed.
If you click **Customize**, you can choose individual components to install.

Wired network setup

- 9 Enter the password and click **OK**.
- 10 When the message that warns that all applications will close on your computer appears, click **Continue**.
- 11 Select **Network Connected Printer(Wired or Wireless)** on the **Printer Connection Type** and click **Set IP Address** button.
- 12 Click the  icon (third from left) in the SetIP window to open the TCP/IP configuration window.
- 13 Enter the machine's new information into the configuration window. In a corporate intranet, you may need to have this information assigned by a network manager before proceeding.



Find the machine's MAC address from the **Network Configuration Report** (see "Printing a network configuration report" on page 96) and enter it without the colons. For example, 00:15:99:29:51:A8 becomes 0015992951A8.

- 14 Click **Apply**, and then click **OK**. The machine will automatically print the **Network Configuration Report**. Confirm that all the settings are correct.

IPv4 configuration using SetIP (Linux)

Before using the SetIP program, disable the computer firewall from **System Preferences** or **Administrator**.



The following instructions may vary from your model or operating systems.

- 1 Open **/opt/Samsung/mfp/share/utils/**.
- 2 Double-click the **SetIPApplet.html** file.
- 3 Click to open the TCP/IP configuration window.
- 4 Enter the machine's new information into the configuration window. In a corporate intranet, you may need to have this information assigned by a network manager before proceeding.



Find the machine's MAC address from the **Network Configuration Report** (see "Printing a network configuration report" on page 96) and enter it without the colons. For example, 00:15:99:29:51:A8 becomes 0015992951A8.

- 5 The machine will automatically print the **Network Configuration Report**.

Installing driver over the network



- Some features and optional goods may not be available depending on model or country (see "Features by models" on page 6).
- The machine that does not support the network interface, it will not be able to use this feature (see "Rear view" on page 19).
- You can install the printer driver and software when you insert the software CD into your CD-ROM drive.

For Windows, select the printer driver and software in the **Select Software to Install** window.

Windows



The firewall software might be blocking network communication. Before connecting the device to the network, disable the computer's firewall.

1 Make sure that the machine is connected to the network and powered on. Also, your machine's IP address should have been set (see "Setting IP address" on page 96).

2 Insert the supplied software CD into your CD-ROM drive.

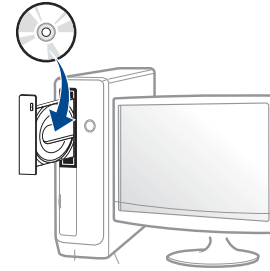

3 Review and accept the installation agreements in the installation window. Then, click **Next**.

4 Select **Network connection** on the **Printer Connection Type** screen. Then, click **Next**.

5 Follow the instructions in the installation window.

Silent installation Mode

Silent installation mode is an installation method that does not require any user intervention. Once you start the installation, the machine driver and software are automatically installed on your computer. You can start the silent installation by typing **/s** or **/S** in the command window.

Installing driver over the network

Command-line Parameters

Following table shows commands that can be used in the command window.



Following command-line are effective and operated when command is used with **/s** or **/S**. But **/h**, **/H** or **/?** are exceptional commands that can be operated solely.

Command- line	Definition	Description
<code>/s</code> or <code>/S</code>	Starts silent installation.	Installs machine drivers without prompting any UIs or user intervention.
<code>/p"<port name>"</code> or <code>/P"<port name>"</code>	Specifies printer port. Network Port will be created by use of Standard TCP/IP Port monitor. For local port, this port must exist on system before being specified by command.	Printer port name can be specified as IP address, hostname, USB local port name or IEEE1284 port name. For example <ul style="list-style-type: none"> <code>/p"xxx.xxx.xxx.xxx"</code> in where, "xxx.xxx.xxx.xxx" means IP address for network printer. / <code>p"USB001"</code>, <code>/P"LPT1:"</code>, / <code>p"hostname"</code>

Command- line	Definition	Description
<code>/a"<dest_path>"</code> or <code>/A"<dest_path>"</code>	Specifies destination path for installation. The destination path should be a fully qualified path.	Since machine drivers should be installed on the OS specific location, this command applies to only application software.
<code>/n"<Printer name>"</code> or <code>/N"<Printer name>"</code>	Specifies printer name. Printer instance shall be created as specified printer name.	With this parameter, you can add printer instances as your wishes.
<code>/nd</code> or <code>/ND</code>	Commands not to set the installed driver as a default machine driver.	It indicates installed machine driver will not be the default machine driver on your system if there are one or more printer drivers installed. If there is no installed machine driver on your system, then this option won't be applied because Windows OS will set installed printer driver as a default machine driver.

Installing driver over the network

Command- line	Definition	Description
/x or /X	Uses existing machine driver files to create printer instance if it is already installed.	This command provides a way to install a printer instance that uses installed printer driver files without installing an additional driver.
/up"<printer name>" or /UP"<printer name>"	Removes only specified printer instance and not the driver files.	This command provides a way to remove only specified printer instance from your system without effecting other printer drivers. It will not remove printer driver files from your system.
/d or /D	Uninstalls all device drivers and applications from your system.	This command will remove all installed device drivers and application software from your system.
/v"<share name>" or /V"<share name>"	Shares installed machine and add other available platform drivers for Point & Print.	It will install all supported Windows OS platform's machine drivers to system and share it with specified <share name> for point and print.
/o or /O	Opens Printers and Faxes folder after installation.	This command will open Printers and Faxes folder after the silent installation.

Command- line	Definition	Description
/h, /H or /?	Shows Command-line Usage.	

Mac

- 1 Make sure that the machine is connected to your network and powered on.
- 2 Insert the supplied software CD into your CD-ROM drive.

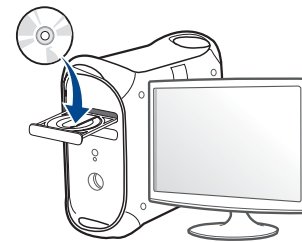

- 3 Double-click the CD-ROM icon that appears on your Mac desktop.
 - For Mac OS X 10.8, double-click the CD-ROM that appears on **Finder**.
- 4 Double-click the **MAC_Installer** folder > **Installer OS X** icon.
- 5 Click **Continue**.
- 6 Read the license agreement and click **Continue**.

Installing driver over the network

- 7 Click **Agree** to agree to the license agreement.
- 8 Click **Install**. All components necessary for machine operations will be installed.
If you click **Customize**, you can choose individual components to install.
- 9 Enter the password and click **OK**.
- 10 Select **Network Connected Printer(Wired or Wireless)** on the **Printer Connection Type** and click **Continue**.
- 11 Click **Add Printer** button to select your printer and add it to your printer list.
- 12 Click **IP** and select **HP Jetdirect - Socket** in **Protocol**.
- 13 Enter the machine's IP address in the **Address** input field.
- 14 Enter the queue name in the **Queue** input field. If you cannot determine the queue name for your machine server, try using the default queue first.
- 15 If Auto Select does not work properly, choose **Select Printer Software** and your machine name in **Print Using**.
- 16 Click **Add**.
- 17 After the installation is finished, click **Close**.

Linux

You need to download Linux software packages from the Samsung website to install the printer software (www.samsung.com > find your product > Support or Downloads).

Install the Linux driver and add network printer

- 1 Make sure that the machine is connected to your network and powered on. Also, your machine's IP address should have been set.
- 2 Download the Unified Linux Driver package from the Samsung website.
- 3 Extract the Unified Linux Driver package and open the new directory.
- 4 Double-click the **cdroot** folder > **autorun**.
- 5 The Samsung installer window opens. Click **Next**.
- 6 The add printer wizard window opens. Click **Next**.
- 7 Select network printer and click **Search** button.
- 8 The machine's IP address and model name appears on list field.
- 9 Select your machine and click **Next**.

Installing driver over the network

- 10 Input the printer description and **Next**.
- 11 After the machine is added, click **Finish**.
- 12 When installation is done, click **Finish**.

Add a network printer

- 1 Double-click the **Unified Driver Configurator**.
- 2 Click **Add Printer**.
- 3 The **Add printer wizard** window opens. Click **Next**.
- 4 Select **Network printer** and click the **Search** button.
- 5 The printer's IP address and model name appears on list field.
- 6 Select your machine and click **Next**.
- 7 Enter the printer description and click **Next**.
- 8 After the machine is added, click **Finish**.

IPv6 configuration



IPv6 is supported properly only in Windows Vista or higher.



If the IPv6 network seems to not be working, set all the network setting to the factory defaults and try again using **Clear Setting**.

In the IPv6 network environment, follow the next procedure to use the IPv6 address.

From the control panel

- 1 Connect your machine to the network with a network cable.
- 2 Turn on the machine.
- 3 Print a **Network Configuration Report** that will check IPv6 addresses (see "Printing a network configuration report" on page 96).
- 4 Select **Start > Control Panel > Printers and Faxes**.
- 5 Click **Add a printer** in the left pane of the **Printers and Faxes** windows.
- 6 Click **Add a local printer** in the **Add Printer** windows.

7

The **Add Printer Wizard** window appears. Follow the instructions in the window.



If the machine does not work in the network environment, activate IPv6. Refer to the next section followed by.

Activating IPv6

- 1 Press the  (**Menu**) button on the control panel.
- 2 Press **Network > TCP/IP (IPv6) > IPv6 Activate**.
- 3 Select **On** and press **OK**.
- 4 Turn the machine off and turn it on again.
- 5 Reinstall your printer driver.

IPv6 configuration

Setting IPv6 addresses

The machine supports the following IPv6 addresses for network printing and managements.

- **Link-local Address:** Self-configured local IPv6 address (Address starts with FE80).
- **Stateless Address:** Automatically configured IPv6 address by a network router.
- **Stateful Address:** IPv6 address configured by a DHCPv6 server.
- **Manual Address:** Manually configured IPv6 address by a user.

DHCPv6 address configuration (Stateful)

If you have a DHCPv6 server on your network, you can set one of the following options for default dynamic host configuration.

- 1 Press the  (**Menu**) button on the control panel.
- 2 Press **Network > TCP/IP (IPv6) > DHCPv6 Config**.
- 3 Press **OK** to select the required value you want.
 - **DHCPv6 Addr.:** Always use DHCPv6 regardless of router request.
 - **DHCPv6 Off:** Never use DHCPv6 regardless of router request.
 - **Router:** Use DHCPv6 only when requested by a router.

From the SyncThru™ Web Service



For models that do not have the display screen on the control panel, you need to access **SyncThru™ Web Service** first using the IPv4 address and follow the below procedure to use IPv6.

- 1 Access a web browser, such as Internet Explorer, from Windows. Enter the machine IP address (http://xxx.xxx.xxx.xxx) in the address field and press the Enter key or click **Go**.
- 2 If it's your first time logging into **SyncThru™ Web Service** you need to log-in as an administrator. Type in the below default ID and password. We recommend you to change the default password for security reasons.
 - **ID: admin**
 - **Password: sec00000**
- 3 When the **SyncThru™ Web Service** window opens, move the mouse cursor over the **Settings** of the top menu bar and then click **Network Settings**.
- 4 Click **TCP/IPv6** on the left pane of the website.
- 5 Check the **IPv6 Protocol** check box to activate IPv6.

IPv6 configuration

- 6 Check the **Manual Address** check box. Then, the **Address/Prefix** text box is activated.
- 7 Enter the rest of the address (e.g.,:3FFE:10:88:194::**AAAA**. "A" is the hexadecimal 0 through 9, A through F).
- 8 Choose the DHCPv6 configuration.
- 9 Click the **Apply** button.

Using SyncThru™ Web Service

- 1 Start a web browser, such as Internet Explorer, that supports IPv6 addressing as a URL.
- 2 Select one of the IPv6 addresses (**Link-local Address, Stateless Address, Stateful Address, Manual Address**) from **Network Configuration Report** (see "Printing a network configuration report" on page 96).
- 3 Enter the IPv6 addresses (e.g.,: http://[FE80::215:99FF:FE66:7701]).



Address must be enclosed in '['] brackets.

Wireless network setup



- Make sure your machine supports wireless networking. Wireless networking may not be available depending on the model (see "Features by models" on page 6).
- If the IPv6 network seems to not be working, set all the network settings to the factory defaults and try again using **Clear Setting**.

Getting started

Understanding your network type

Typically, you can only have one connection between your computer and the machine at a time.

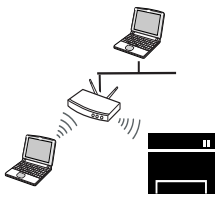

Infrastructure mode

This is an environment generally used for homes and SOHOs (Small Office/ Home Office). This mode uses an access point to communicate with the wireless machine.

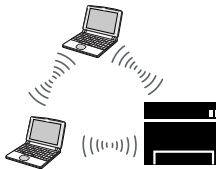

Ad hoc mode

This mode does not use an access point. The wireless computer and wireless machine communicate directly.

Wireless network name and network password

Wireless networks require higher security, so when an access point is first set up, a network name (SSID), the type of security used, and a Network Password are created for the network. Ask your network administrator about this information before proceeding with the machine installation.



Wireless network setup

Introducing wireless set up methods



You can set wireless settings either from the machine or the computer. Choose the setting method from the below table.

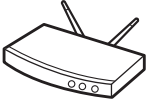

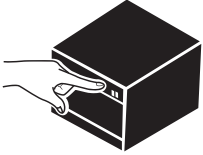
Some wireless network installation types may not be available depending on the model or country.

Set up method	Connecting method	Description & Reference
With Access Point 	From the computer 	Windows user, see "Access point via USB cable" on page 114. Windows user, see "Access point without a USB cable (recommended)" on page 117. <ul style="list-style-type: none">• Mac user, see "Access point via USB cable" on page 122.• Mac user, see "Access point without a USB cable (recommended)" on page 125 See "Using a network cable" on page 130.
	From the machine's control panel 	<ul style="list-style-type: none">• See "Machines with a display screen" on page 111.• See "Machines without a display screen" on page 112. See "Using the menu button" on page 113.

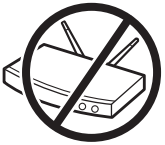
Wireless network setup

Set up method	Connecting method	Description & Reference
Without Access Point 	From the computer	Windows user, see "Ad hoc via USB cable" on page 120. Mac user, see "Ad hoc via USB cable" on page 127.
	Ad-hoc  Wi-Fi Direct setup Wi-Fi Direct 	See "Setting up Wi-Fi Direct" on page 133.



- If problems occur during wireless set up or driver installation, refer to the troubleshooting chapter (see "Troubleshooting" on page 135).
- It is strongly recommended that you set the password on Access Points. If you do not set the password on Access Points, they might be exposed to illegal access from unknown machines including PCs, smart phones and printers. Refer to the Access Point user's guide for password settings.

Wireless network setup

Using the WPS button

If your machine and an access point (or wireless router) support Wi-Fi Protected Setup™ (WPS), you can easily configure the wireless network settings by pressing the  (WPS) button on the control panel without a computer.





- If you want to use the wireless network using the infrastructure mode, make sure that the network cable is disconnected from the machine. Using the **WPS (PBC)** button or entering the PIN from the computer to connect to the access point (or wireless router) varies depending on the access point (or wireless router) you are using. Refer to the user's guide of the access point (or wireless router) you are using.
- When using the WPS button to set the wireless network, security settings may change. To prevent this, lock the WPS option for the current wireless security settings. The option name may differ depending on the access point (or wireless router) you are using.

Items to prepare

- Check if the access point (or wireless router) supports Wi-Fi Protected Setup™ (WPS).
- Check if your machine supports Wi-Fi Protected Setup™ (WPS).
- Networked computer (PIN mode only)

Choosing your type

There are two methods available to connect your machine to a wireless network using the  (WPS) button on the control panel.



The **Push Button Configuration (PBC)** method allows you to connect your machine to a wireless network by pressing both the  (WPS) button on the control panel of your machine and the WPS (PBC) button on a Wi-Fi Protected Setup™ WPS-enabled access point (or wireless router) respectively.

The **Personal Identification Number (PIN)** method helps you connect your machine to a wireless network by entering the supplied PIN information on a Wi-Fi Protected Setup™ WPS-enabled access point (or wireless router).

Factory default in your machine is **PBC** mode, which is recommended for a typical wireless network environment.



If your machine doesn't have a display screen, you can enable or disable the Wi-Fi Direct feature with the **WPS** button.

- Press and hold the  (WPS) button on the control panel for about 10-15 seconds. Wi-Fi Direct feature turns on.
- Press and hold the  (WPS) button on the control panel for more than 15 seconds. Wi-Fi Direct feature turns off.
- To get more information about the Wi-Fi Direct feature, read the "Setting the Wi-Fi Direct for mobile printing" on page 133.

Wireless network setup



You can change the WPS mode in control panel (☰ **(Menu)** > **Network** > **Wireless** > **OK** > **WPS Setting**).

Machines with a display screen

Connecting in PBC mode

- 1 Press and hold the  (WPS) button on the control panel for more than 2 seconds.

The machine starts waiting for up to two minutes until you press the WPS (PBC) button on the access point (or wireless router).

- 2 Press the **WPS (PBC)** button on the access point (or wireless router).

The messages are displayed on the display screen in the order below:

- a Connecting:** The machine is connecting to the access point (or wireless router).
- b Connected:** When the machine is successfully connected to the wireless network, the WPS LED light stays on.
- c AP SSID:** After completing the wireless network connection process, the AP's SSID information appears on the display.

- 3 Insert the supplied software CD into your CD-ROM drive, and follow the instructions in the window to set up the wireless network.

Connecting in PIN mode

- 1 Press and hold the  (WPS) button on the control panel for more than 2 seconds.

- 2 The eight-digit PIN appears on the display.

You need to enter the eight-digit PIN within two minutes on the computer that is connected to the access point (or wireless router).

The messages are displayed on the display screen in the order below:

- a Connecting:** The machine is connecting to the wireless network.
- b Connected:** When the machine is successfully connected to the wireless network, the WPS LED light stays on.
- c SSID Type:** After completing the wireless network connection process, the AP's SSID information is displayed on the LCD display.

- 3 Insert the supplied software CD into your CD-ROM drive, and follow the instructions in the window to set up the wireless network.

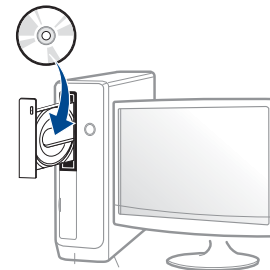

Wireless network setup

Machines without a display screen

Connecting in PBC mode

- 1 Press and hold the  (WPS) button on the control panel for about 2 - 4 seconds until the status LED blinks quickly.

The machine starts connecting to the wireless network. The LED blinks slowly for up to two minutes until you press the PBC button on the access point (or wireless router).

- 2 Press the **WPS (PBC)** button on the access point (or wireless router).
 - a The light blinks fast on the WPS LED. The machine is connecting to the access point (or wireless router).
 - b When the machine is successfully connected to the wireless network, the WPS LED light stays on.



- 3 Insert the supplied software CD into your CD-ROM drive, and follow the instructions in the window to set up the wireless network.



Connecting in PIN mode

- 1 The network configuration report, including PIN, must be printed (see "Printing a network configuration report" on page 96).

In ready mode, Press the  (**Cancel or Stop/Clear**) button for more than five seconds on the control panel.

The machine without the  (**Cancel or Stop/Clear**) button: Press the (**WPS**)  button for more than ten seconds on the control panel.

You can find your machine's PIN.

- 2 Press and hold the  (WPS) button on the control panel for more than 4 seconds until the status LED stays on.

The machine starts connecting to the access point (or wireless router).

- 3 You need to enter the eight-digit PIN within two minutes on the computer that is connected to the access point (or wireless router).

The LED blinks slowly for up to two minutes until you enter the eight-digit PIN.

The WPS LED blinks in the order below:

- a The light blinks fast on the WPS LED. The machine is connecting to the access point (or wireless router).
- b When the machine is successfully connected to the wireless network, the WPS LED light stays on.

Wireless network setup

- 4 Insert the supplied software CD into your CD-ROM drive, and follow the instructions in the window to set up the wireless network.

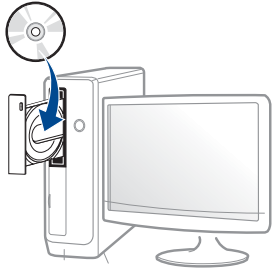

Re-connecting to a network



When the wireless function is off, the machine automatically tries to re-connect to the access point (or wireless router) with the previously used wireless connection settings and address.



In the following cases, the machine automatically re-connects to the wireless network:

- The machine is turned off and on again.
- The access point (or wireless router) is turned off and on again.

Canceling the connection process

To cancel the wireless network connection when the machine is connecting to the wireless network, press and release the  (**Cancel** or **Stop/Clear**) or  (**Power/Wakeup**) button on the control panel. **You need to wait 2 minutes to re-connect to the wireless network.**

Disconnecting from a network

To disconnect the wireless network connection, press the  (WPS) button on the control panel for more than two seconds.

- **When the Wi-Fi network is in idle mode:** The machine is immediately disconnected from the wireless network and the WPS LED turns off.
- **When the Wi-Fi network is being used:** While the machine waits until the current job is finished, the light blinks fast on the WPS LED. Then, the wireless network connection is automatically disconnected and the WPS LED turns off.

Using the menu button



Some menus may not appear in the display depending on options or models. If so, it is not applicable to your machine

Wireless network setup

Before starting, you will need to know the network name (SSID) of your wireless network and the network key if it is encrypted. This information was set when the access point (or wireless router) was installed. If you do not know about your wireless environment, please ask the person who set up your network.



After completing the wireless network connection, you need to install a machine driver to print from an application (see "Installing driver over the network" on page 99).

- 1 Press the  (**Menu**) button on the control panel.
- 2 Press **Network > Wireless > WLAN Settings**.
- 3 Press the **OK** to select the setup method you want.
 - **Wizard** (recommended): In this mode, the setup is automatic. The machine will display a list of available networks from which to choose. After a network is chosen then printer will prompt for the corresponding security key.
 - **Custom**: In this mode, users can give or edit manually their own SSID, or choose the security option in detail.

Setup using Windows



Shortcut to the **Samsung Easy Wireless Setup** program without the CD: If you have installed the printer driver once, you can access the **Samsung Easy Wireless Setup** program without the CD (see "Accessing management tools" on page 210).

Access point via USB cable

Items to prepare

- Access point
- Network-connected computer
- Software CD that was provided with your machine
- A machine installed with a wireless network interface
- USB cable

Creating the infrastructure network

- 1 Check whether the USB cable is connected to the machine.
- 2 Turn on your computer, access point, and machine.

Wireless network setup

- 3 Insert the supplied software CD into your CD-ROM drive.

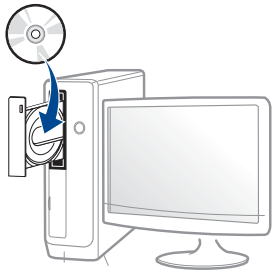

If the installation window does not appear, click **Start > All programs > Accessories > Run**.

X:\Setup.exe replacing "X" with the letter, which represents your CD-ROM drive and click **OK**.

- 4 Review and accept the installation agreements in the installation window. Then, click **Next**.

- 5 Select **Wireless network connection** on the **Printer Connection Type** screen. Then, click **Next**.



- 6 On the **Are you setting up your printer for the first time?** screen, select **Yes, I will set up my printer's wireless network**. Then, click **Next**.

If your printer is already connected on the network, select **No, my printer is already connected to my network**.

Wireless network setup

- 7 Select **Using a USB cable** on the **Select the Wireless Setup Method** screen. Then, click **Next**.

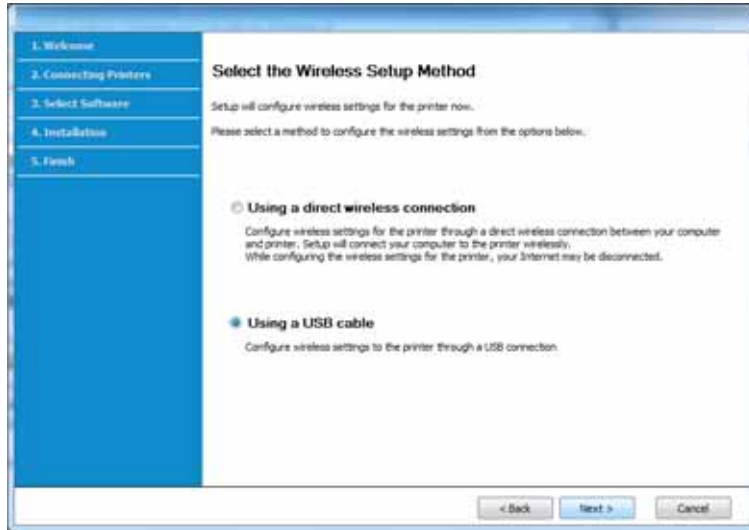

- 8 After searching, the window shows the wireless network devices. Select the name (SSID) of the access point you want to use and click **Next**.



If you cannot find the network name you want to choose, or if you want to set the wireless configuration manually, click **Advanced Setting**.

- **Enter the wireless Network Name:** Enter the SSID of the access point (SSID is case-sensitive).
- **Operation Mode:** Select **Infrastructure**.

- **Authentication:** Select an authentication type.
 - Open System:** Authentication is not used, and encryption may or may not be used, depending on the need for data security.
 - Shared Key:** Authentication is used. A device that has a proper WEP key can access the network.
 - WPA Personal or WPA2 Personal:** Select this option to authenticate the print server based on a WPA Pre-Shared Key. This uses a shared secret key (generally called Pre Shared Key pass phrase), which is manually configured on the access point and each of its clients.
- **Encryption:** Select the encryption (None, WEP64, WEP128, TKIP, AES, TKIP AES).
- **Network Password:** Enter the encryption network password value.
- **Confirm Network Password:** Confirm the encryption network password value.
- **WEP Key Index:** If you are using WEP Encryption, select the appropriate **WEP Key Index**.



The wireless network security window appears when the access point has security settings.

Enter the Network Password of the access point (or router).

Wireless network setup

- 9 If your printer supports Wi-Fi Direct and this function is disabled, its corresponding screen will appear.

Click **Next**.



- Wi-Fi Direct option appears on the screen only if your printer supports this feature.
- Can start to build Wi-Fi Direct by using Samsung Easy Printer Manager (see "Setting up Wi-Fi Direct" on page 133).
- **Wi-Fi Direct Name:** The default Wi-Fi Direct Name is the model name and the maximum length is 22 characters.
- **Password setting** is the numeric string, and the size is 8 ~ 64 characters.

- 10 When the wireless network set up is completed, disconnect the USB cable between the computer and machine. Click **Next**.

- 11 Follow the instructions in the installation window.

Access point without a USB cable (recommended)

Items to prepare

- WiFi-enabled PC running Windows 7 or higher and an access point (router)
- Software CD that was provided with your machine
- A machine installed with a wireless network interface



While setting the wireless network, the machine uses PC's wireless LAN. You might not be able to connect to the Internet.

Wireless network setup

Creating the infrastructure network

- 1 Turn on your computer, access point, and machine.
- 2 Insert the supplied software CD into your CD-ROM drive.



If the installation window does not appear, click **Start > All programs > Accessories > Run**.

X:**Setup.exe** replacing "X" with the letter, which represents your CD-ROM drive and click **OK**.

- 3 Review and accept the installation agreements in the installation window. Then, click **Next**.

- 4 Select **Wireless network connection** on the **Printer Connection Type** screen. Then, click **Next**.

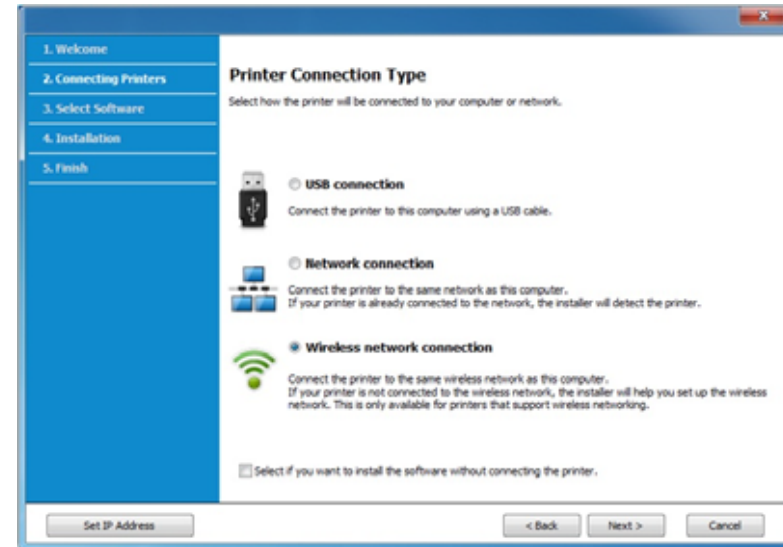

- 5 On the **Are you setting up your printer for the first time?** screen, select **Yes, I will set up my printer's wireless network**. Then, click **Next**.

If your printer is already connected on the network, select **No, my printer is already connected on my network**.

Wireless network setup

- 6 Select **Using a direct wireless connection** on the **Select the Wireless Setup Method** screen. Then, click **Next**.

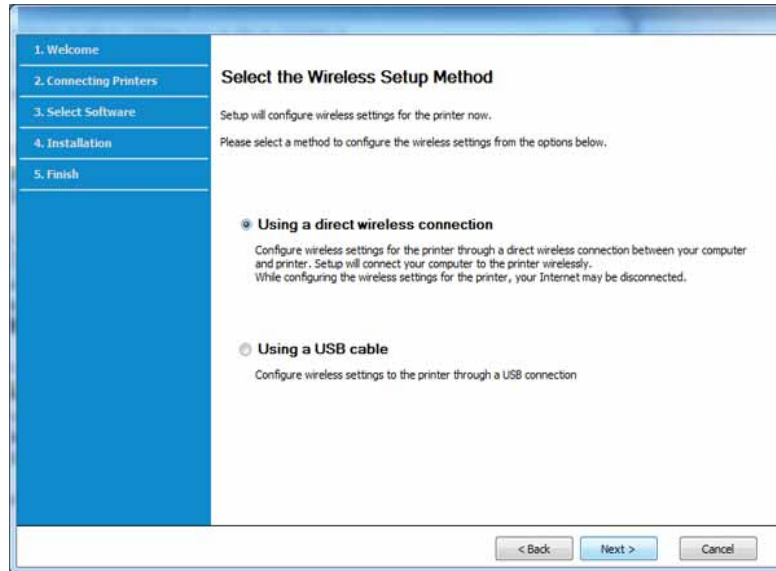

Even if your computer is running Windows 7 or higher, you cannot use this feature if your PC does not support wireless network. Set the wireless network using a USB cable (see "Access point via USB cable" on page 114).

If below screen appears, press the  (WPS) button from the control panel within 2 minutes.



- 7 When the wireless network set up is completed, click **Next**.
- 8 Follow the instructions in the installation window.

Wireless network setup

Ad hoc via USB cable

If you do not have an access point (AP), you may still connect the machine wirelessly to your computer by setting up an ad-hoc wireless network by following the simple steps below.

Items to prepare

- Network-connected computer
- Software CD that was provided with your machine
- A machine installed with a wireless network interface
- USB cable

Creating the ad hoc network in Windows

- 1 Turn on your computer and the wireless network machine.
- 2 Insert the supplied software CD into your CD-ROM drive.

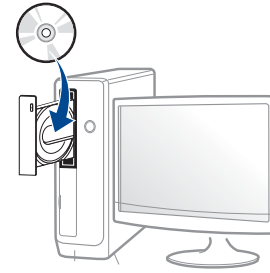

If the installation window does not appear, click **Start > All programs > Accessories > Run**.

X:**Setup.exe** replacing "X" with the letter, which represents your CD-ROM drive and click **OK**.

- 3 Review and accept the installation agreements in the installation window. Then, click **Next**.

Wireless network setup

- 4 Select **Wireless network connection** on the **Printer Connection Type** screen. Then, click **Next**.

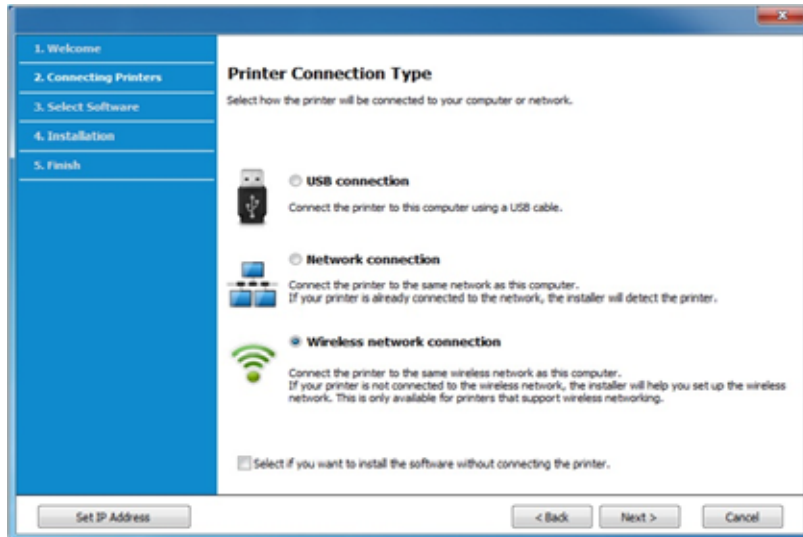

- 5 On the **Are you setting up your printer for the first time?** screen, select **Yes, I will set up my printer's wireless network**. Then, click **Next**.
If your printer is already connected on the network, select **No, my printer is already connected on my network**.
- 6 Select **Using a USB cable** on the **Select the Wireless Setup Method** screen. Then, click **Next**.
- 7 After searching the wireless networks, a list of wireless networks your machine has searched appears. Click **Advanced Setting**.



- **Enter the wireless Network Name:** Enter the SSID name you want (SSID is case-sensitive).
- **Operation Mode:** Select ad hoc.
- **Channel:** Select the channel. (**Auto Setting** or 2412 MHz to 2467 MHz).
- **Authentication:** Select an authentication type.
Open System: Authentication is not used, and encryption may or may not be used, depending on the need for data security.
Shared Key: Authentication is used. A device that has a proper WEP key can access the network.
- **Encryption:** Select the encryption (None, WEP64, WEP128).
- **Network Password:** Enter the encryption network password value.
- **Confirm Network Password:** Confirm the encryption network password value.
- **WEP Key Index:** If you are using WEP Encryption, select the appropriate **WEP Key Index**.

The wireless network security window appears when the ad hoc network has security enabled.

Select **Open System** or **Shared Key** for the authentication and click **Next**.

- WEP (Wired Equivalent Privacy) is a security protocol preventing unauthorized access to your wireless network. WEP encrypts the data portion of each packet exchanged on a wireless network using a 64-bit or 128-bit WEP encryption key.

- 8 The window showing the wireless network setting appears. Check the settings and click **Next**.

Wireless network setup



Before entering the IP address for the machine, you must know the computer's network configuration information. If the computer's network configuration is set to DHCP, the wireless network setting should also be DHCP. Likewise, if the computer's network configuration is set to Static, the wireless network setting should also be Static.

If your computer is set to DHCP and you want to use the Static wireless network setting, you must contact the network administrator to get the static IP address.

- **For the DHCP method**

If the IP address assignment method is DHCP, check if DHCP is shown in the **Wireless Network Setting Confirm** window. If it shows Static, click **Change TCP/IP** to change the assignment method to **Receive IP address automatically (DHCP)**.

- **For the Static method**

If the IP address assignment method is Static, check if Static is shown in the **Wireless Network Setting Confirm** window. If it shows DHCP, click **Change TCP/IP** to enter the IP address and other network configuration values for the machine.

For example,

If the computer's network information is as shown follows:

- IP address: 169.254.133.42
- Subnet Mask: 255.255.0.0

Then, the machine's network information should be as below:

- IP address: 169.254.133.**43**
- Subnet Mask: 255.255.0.0 (Use the computer's subnet mask.)
- Gateway: 169.254.133.**1**

- 9 The **Wireless Network Setting Complete** window appears. Click **Next**.
- 10 When the wireless network settings are completed, disconnect the USB cable between the computer and machine. Click **Next**.
- 11 Follow the instructions in the installation window.

Setup using Mac

Access point via USB cable

Items to prepare

- Access point
- Network-connected printer
- Software CD that was provided with your machine
- A machine installed with a wireless network interface
- USB cable

Wireless network setup

1 Make sure that the machine is connected to your computer and powered on.

2 Insert the supplied software CD into your CD-ROM drive.

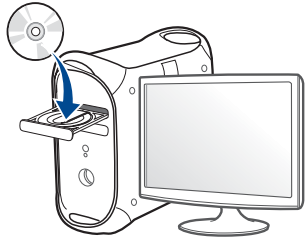

3 Double-click the CD-ROM icon that appears on your Mac desktop.

- For Mac OS X 10.8, double-click the CD-ROM that appears on **Finder**.

4 Double-click the **MAC_Installer** folder > **Installer OS X** icon.

5 Click **Continue**.

6 Read the license agreement and click **Continue**.

7 Click **Agree** to agree to the license agreement.

8 Click **Install**. All components necessary for machine operations will be installed.

If you click **Customize**, you can choose individual components to install.

9 Enter the password and click **OK**.

10 Select **Configuration of Wireless network** on the **Printer Connection Type** and click **Continue**.

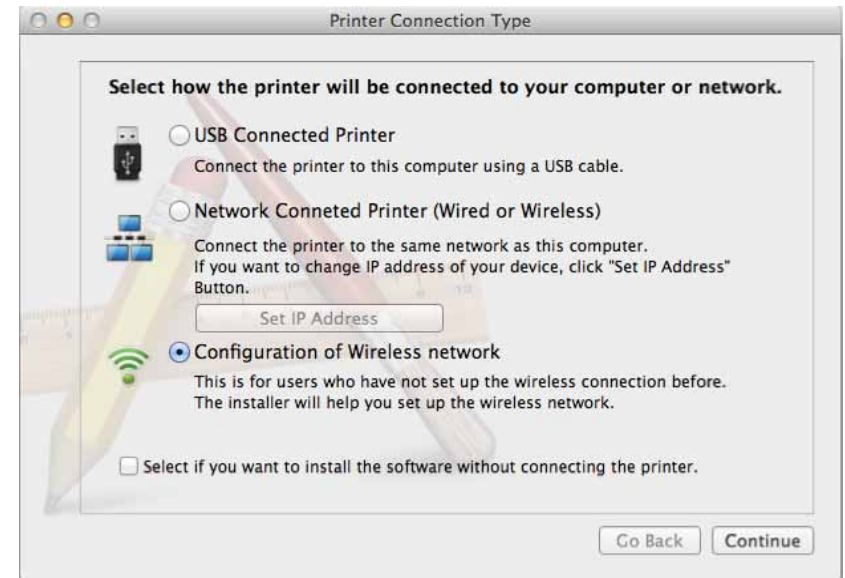

Wireless network setup

- 11** If **Wireless Settings** screen appears, select **Using a USB cable** and click **Next**.

If the screen does not appear, go to step 15.

Wireless Settings

Select the Wireless Setup Method

Setup will configure wireless settings for the printer now.
Please select a method to configure the wireless settings from the options below.

Using a direct wireless connection
Configure wireless settings for the printer through a direct wireless connection between your computer and printer. Setup will connect your computer to the printer wirelessly.
While configuring the wireless settings for the printer, your Internet may be disconnected.

Using a USB cable
Configure wireless settings to the printer through a USB connection

< Back Next > Cancel

- 12** After searching, the window shows the wireless network devices. Select the name (SSID) of the access point you want to use and click **Next**.



When you set the wireless configuration manually, click **Advanced Setting**.

- **Enter the wireless Network Name:** Enter the SSID of the access point (SSID is case-sensitive).
- **Operation Mode:** Select **Infrastructure**.

- **Authentication:** Select an authentication type.
 - Open System:** Authentication is not used, and encryption may or may not be used, depending on the need for data security.
 - Shared Key:** Authentication is used. A device that has a proper WEP key can access the network.
 - WPA Personal or WPA2 Personal:** Select this option to authenticate the print server based on the WPA Pre-Shared Key. This uses a shared secret key (generally called Pre Shared Key pass phrase) that is manually configured on the access point and each of its clients.
- **Encryption:** Select the encryption. (None, WEP64, WEP128, TKIP, AES, TKIP, AES)
- **Network Password:** Enter the encryption network password value.
- **Confirm Network Password:** Confirm the encryption network password value.
- **WEP Key Index:** If you are using WEP Encryption, select the appropriate **WEP Key Index**.

The wireless network security window appears when the access point has security enabled.

Enter the Network Password of the access point (or router).

- 13** The window showing the wireless network setting appears. Check the settings and click **Next**.



- Wi-Fi Direct option appears on the screen only if your printer supports this feature.
- Can start to build Wi-Fi Direct by using Samsung Easy Printer Manager (see "Setting up Wi-Fi Direct" on page 133).

Wireless network setup

- **Wi-Fi Direct Name:** The default Wi-Fi Direct Name is the model name and the maximum length is 22 characters.
- **Password setting** is the numeric string, and the size is 8 ~ 64 characters.

14 The **Wireless Network Setting Complete** window appears. Click **Next**.

15 When the wireless network settings are completed, disconnect the USB cable between the computer and machine. Click **Next**.

Access point without a USB cable (recommended)

Items to prepare

- WiFi-enabled Mac running Mac OS 10.7 or higher and an access point (router)
- Software CD that was provided with your machine
- A machine installed with a wireless network interface

1 Make sure that the machine is connected to your computer and powered on.

2 Insert the supplied software CD into your CD-ROM drive.

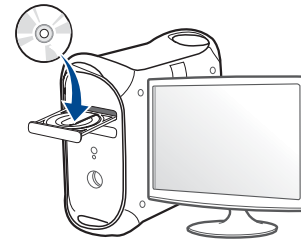

3 Double-click the CD-ROM icon that appears on your Mac desktop.

- For Mac OS X 10.8, double-click the CD-ROM that appears on **Finder**.

4 Double-click the **MAC_Installer** folder > **Installer OS X** icon.

5 Click **Continue**.

6 Read the license agreement and click **Continue**.

7 Click **Agree** to agree to the license agreement.

8 Click **Install**. All components necessary for machine operations will be installed.

If you click **Customize**, you can choose individual components to install.

9 Enter the password and click **OK**.

Wireless network setup

- 10** Select **Configuration of Wireless network** on the **Printer Connection Type** and click **Continue**.



- 11** If **Wireless Settings** screen appears, select **Using a direct wireless connection** and click **Next**.

If the screen does not appear, go to step 13.

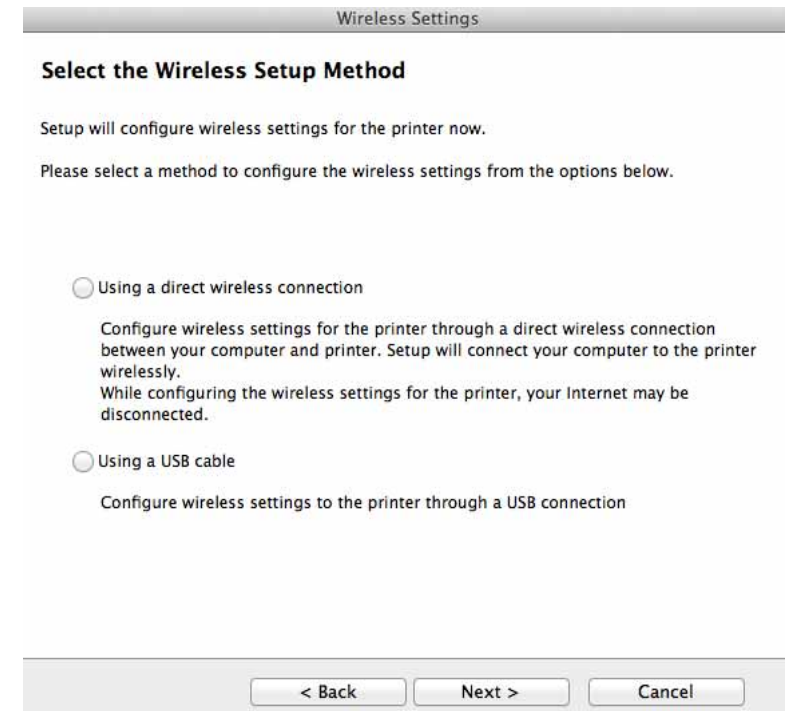

Wireless network setup



If below screen appears, press the  (WPS) button from the control panel within 2 minutes.



12 When the wireless network set up is completed, click **Next**.

13 After the installation is finished, click **Close**.

Ad hoc via USB cable

If you do not have an access point (AP), you may still connect the machine wirelessly to your computer by setting up an ad hoc wireless network by following these simple directions.

Items to prepare

- Network-connected computer
- Software CD that was provided with your machine
- A machine installed with a wireless network interface
- USB cable

Creating the ad hoc network in Mac

- 1** Make sure that the machine is connected to your computer and powered on.
- 2** Insert the supplied software CD into your CD-ROM drive.

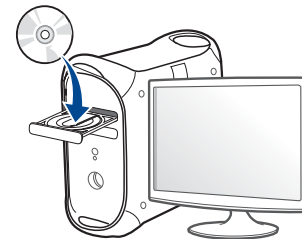

Wireless network setup

- 3 Double-click the CD-ROM icon that appears on your Mac desktop.
 - For Mac OS X 10.8, double-click the CD-ROM that appears on **Finder**.
- 4 Double-click the **MAC_Installer** folder > **Installer OS X** icon.
- 5 Click **Continue**.
- 6 Read the license agreement and click **Continue**.
- 7 Click **Agree** to agree to the license agreement.
- 8 Click **Install**. All components necessary for machine operations will be installed.
If you click **Customize**, you can choose individual components to install.
- 9 Enter the password and click **OK**.

- 10 Select **Configuration of Wireless network** on the **Printer Connection Type** and click **Continue**.



- 11 After searching the wireless networks, a list of wireless networks your machine has searched appears. Click **Advanced Setting**.



- **Enter the wireless Network Name:** Enter the SSID name (SSID is case-sensitive).
- **Operation Mode:** Select ad hoc.
- **Channel:** Select the channel (**Auto Setting** or 2412 MHz to 2467 MHz).
- **Authentication:** Select an authentication type.
 - Open System:** Authentication is not used, and encryption may or may not be used, depending on the need for data security.
 - Shared Key:** Authentication is used. A device that has a proper WEP key can access the network.

Wireless network setup

- **Encryption:** Select the encryption (None, WEP64, WEP128).
- **Network Password:** Enter the encryption network password value.
- **Confirm Network Password:** Confirm the encryption network password value.
- **WEP Key Index:** If you are using WEP Encryption, select the appropriate **WEP Key Index**.

The wireless network security window appears when the ad hoc network has security setting.

Select **Open System** or **Shared Key** for the authentication and click **Next**.

- WEP (Wired Equivalent Privacy) is a security protocol preventing unauthorized access to your wireless network. WEP encrypts the data portion of each packet exchanged on a wireless network using a 64-bit or 128-bit WEP encryption key.

12 The window showing the wireless network settings appears. Check the settings and click **Next**.



Before entering the IP address for the machine, you must know the computer's network configuration information. If the computer's network configuration is set to DHCP, the wireless network setting should also be DHCP. Likewise, if the computer's network configuration is set to Static, the wireless network setting should also be Static.

If your computer is set to DHCP and you want to use Static wireless network setting, you must contact the network administrator to get the static IP address.

- **For the DHCP method**

If the IP address assignment method is DHCP, check if DHCP is shown in the **Wireless Network Setting Confirm** window. If it shows Static, click **Change TCP/IP** to change the assignment method to **Receive IP address automatically (DHCP)**.

- **For the Static method**

If the IP address assignment method is Static, check if Static is shown in the **Wireless Network Setting Confirm** window. If it shows DHCP, click **Change TCP/IP** to enter the IP address and other network configuration values for the machine.

For example,

If the computer's network information is shown as follows:

- IP address: 169.254.133.42
- Subnet Mask: 255.255.0.0

Then, the machine's network information should be as shown below:

- IP address: 169.254.133.**43**
- Subnet Mask: 255.255.0.0 (Use the computer's subnet mask.)
- Gateway: 169.254.133.**1**

Wireless network setup

13 When the window that tells you that the network cable connection is confirmed appears, disconnect the network cable and click **Next**.

If the network cable is connected, it may have trouble finding the machine when configuring the wireless network.

14 The wireless network connects according to the network configuration.

15 Wireless network set up is completed. After installation is finished, click **Quit**.



After completing the wireless network connection, you need to install a machine driver to print from an application (see "Installation for Mac" on page 90).

Using a network cable



Machines that do not support the network interface will not be able to use this feature (see "Rear view" on page 19).

Your machine is a network compatible machine. To enable your machine to work with your network, you will need to perform some configuration procedures.



- After completing the wireless network connection, you need to install a machine driver to print from an application (see "Installing driver over the network" on page 99).
- See your network administrator, or the person that set up your wireless network, for information about your network configuration.

Items to prepare

- Access point
- Network-connected computer
- Software CD that was provided with your machine
- A machine installed with a wireless network interface
- Network cable

Printing a network configuration report

You can identify the network settings of your machine by printing a network configuration report.

See "Printing a network configuration report" on page 96.

Wireless network setup

IP setting using SetIP Program (Windows)

This program is used to manually set the network IP address of your machine using its MAC address to communicate with the machine. The MAC address is the hardware serial number of the network interface and can be found in the **Network Configuration Report**.

See "Setting IP address" on page 96.

Configuring the machine's wireless network

Before starting you will need to know the network name (SSID) of your wireless network and the network key if it is encrypted. This information was set when the access point (or wireless router) was installed. If you do not know about your wireless environment, please ask the person who set up your network.

To configure wireless parameters, you can use **SyncThru™ Web Service**.

Using SyncThru™ Web Service

Before starting wireless parameter configuration, check the cable connection status.

- 1 Check whether or not the network cable is connected to the machine. If not, connect the machine with a standard network cable.
- 2 Start a web browser such as Internet Explorer, Safari, or Firefox and enter your machine's new IP address in the browser window.

For example,



- 3 Click **Login** on the upper right of the SyncThru™ Web Service website.
- 4 If it's your first time logging into **SyncThru™ Web Service** you need to log-in as an administrator. Type in the below default ID and password. We recommend you to change the default password for security reasons.
 - **ID: admin**
 - **Password: sec00000**
- 5 When the **SyncThru™ Web Service** window opens, click **Network Settings**.
- 6 Click **Wireless > Wizard**.



Wizard will help you setup the wireless network configuration. However, if you want to set the wireless network directly, select **Custom**.

Wireless network setup

7 Select the one **Network Name(SSID)** in the list.

- **SSID:** SSID (Service Set Identifier) is a name that identifies a wireless network, access points, and wireless devices attempting to connect to a specific wireless network must use the same SSID. The SSID is case sensitive.
- **Operation Mode: Operation Mode** refers to the type of wireless connections (see "Wireless network name and network password" on page 107).
 - **Ad-hoc:** Allows wireless devices to communicate directly with each other in a peer-to-peer environment.
 - **Infrastructure:** Allows wireless devices to communicate with each other through an access point.



If your network's **Operation Mode** is **Infrastructure**, select the SSID of the access point. If the **Operation Mode** is **Ad-hoc**, select the machine's SSID.

8 Click **Next**.

If the wireless security setting window appears, enter the registered password (network password) and click **Next**.

9 The confirmation window appears, please check your wireless setup. If the setup is right, click **Apply**.



Disconnect the network cable (standard or network). Your machine should then start communicating wirelessly with the network. In case of Ad-hoc mode, you can use a wireless LAN and wired LAN simultaneously.

10 Insert the supplied software CD into your CD-ROM drive, and follow the instructions in the window to set up the wireless network.

Turning the Wi-Fi network on/off



If your machine has a display, you can also turn on/off the Wi-Fi from the machine's control panel using the **Network** menu.

- 1 Check whether the network cable is connected to the machine. If not, connect the machine with a standard network cable.
- 2 Start a web browser such as Internet Explorer, Safari, or Firefox and enter your machine's new IP address in the browser window.

For example,

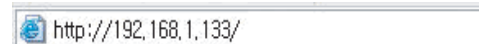

http://192.168.1.133/

- 3 Click **Login** on the upper right of the SyncThru™ Web Service website.

Wireless network setup

4 If it's your first time logging into **SyncThru™ Web Service** you need to log-in as an administrator. Type in the below default ID and password. We recommend you to change the default password for security reasons.

- **ID: admin**
- **Password: sec00000**

5 When the **SyncThru™ Web Service** window opens, click **Network Settings**.

6 Click **Wireless > Custom**.

You can also turn the Wi-Fi network on/off.

Setting the Wi-Fi Direct for mobile printing

Wi-Fi Direct is an easy-to-setup peer-to-peer connection method between the Wi-Fi Direct certified printer and a mobile device that provides a secure connection and better throughput than ad hoc mode.

With Wi-Fi Direct, you can connect your printer to a Wi-Fi Direct network while concurrently connecting to an access point, You can also use a wired network and a Wi-Fi Direct network simultaneously so multiple users can access and print documents both from Wi-Fi Direct and from a wired network.



- You cannot connect your mobile device to the internet through the printer's Wi-Fi Direct.
- The supported protocol list may differ from your model, Wi-Fi Direct networks do NOT support IPv6, network filtering, IPSec, WINS, and SLP services.
- The maximum number of devices that can be connected via Wi-Fi Direct is 3.

Setting up Wi-Fi Direct

You can enable Wi-Fi Direct feature by one of the following methods.

From the USB cable-connected computer (recommended)

After the driver installation is complete, Samsung Easy Printer Manager can be used to change Wi-Fi Direct settings.



Samsung Easy Printer Manager is Available for Windows and Mac OS users only.

- From the **Start** menu, select **Programs** or **All Programs > Samsung Printers > Samsung Easy Printer Manager > Device Settings > Network**.
 - **Wi-Fi Direct On/Off:** Select **On** to enable.



Wireless network setup

- **Device Name:** Enter the printer's name for searching for your printer on a wireless network. By default, the device name is the model name.
- **IP Address:** Enter the IP address of the printer. This IP address is used only for the local network and not for the infrastructure wired or wireless network. We recommend using the default local IP address (the default local IP address of the printer for Wi-Fi Direct is 192.168.3.1)
- **Group Owner:** Activate this option to assign the printer the Wi-Fi Direct group's owner. The **Group Owner** acts similar to a wireless access point. We recommend activating this option.
- **Network Password:** If your printer is a **Group Owner**, a **Network Password** is required for other mobile devices to connect to your printer. You can configure a network password yourself, or can remember the given Network Password that is randomly generated by default.

From the machine (Machines with a display screen)

- Select **Network > Wireless > Wi-Fi Direct** from the control panel.
- Enable **Wi-Fi Direct**.

From the machine (Machines without a display screen)

- Press and hold the  (WPS) button on the control panel for about 10- 15 seconds. Wi-Fi Direct feature turns on.
- Press and hold the  (WPS) button on the control panel for more than 15 seconds. Wi-Fi Direct feature turns off.

From the network-connected computer

If your printer is using a network cable or a wireless access point, you can enable and configure Wi-Fi Direct from SyncThru™ Web Service.

- Access **SyncThru™ Web Service**, select **Settings > Network Settings > Wireless > Wi-Fi Direct**.
- Enable or disable **Wi-Fi Direct** and set other options.



- For Linux OS users,
 - Print an IP network configuration report to check the output (see "Printing a network configuration report" on page 96).
 - Access **SyncThru Web Service**, select **Settings > Network Settings > Wireless > Wi-Fi Direct**.
 - Enable or disable **Wi-Fi Direct**.

Setting up the mobile device

- After setting up Wi-Fi Direct from the printer, refer to the user manual of the mobile device you are using to set its Wi-Fi Direct.
- After setting up Wi-Fi Direct, you need to download the mobile printing application (For example: Samsung Mobile printer) to print from your smartphone.

Wireless network setup



- When you have found the printer you want to connect to from your mobile device, select the printer and the printer's LED will blink. Press the WPS button on the printer and it will be connected to your mobile device.
- If your mobile device does not support WPS, you need to enter the "Network Key" of a printer instead of pushing the WPS button.

Troubleshooting

Problems during setup or driver installation

Printers Not Found

- Your machine may not be turned on. Turn on your computer and the machine.
- USB cable is not connected between your computer and machine. Connect the machine to your computer using the USB cable.
- The machine does not support wireless networking. Check the machine's user's guide included on the software CD supplied with your machine and prepare a wireless network machine.

Connecting Failure - SSID Not Found

- The machine is unable to find the network name (SSID) you have selected or entered. Check the network name (SSID) on your access point and try connecting again.
- Your access point is not turned on. Turn on your access point.

Wireless network setup

Connecting Failure - Invalid Security

- Security is not configured correctly. Check the configured security on your access point and machine.

Connecting Failure - General Connection Error

- Your computer is not receiving a signal from your machine. Check the USB cable and your machine's power.

Connecting Failure - Connected Wired Network

- Your machine is connected with a wired network cable. Remove the wired network cable from your machine.

Connecting Failure - Assigning the IP address

- Cycle the power for the access point (or wireless router) and machine.

PC Connection Error

- The configured network address is unable to connect between your computer and machine.
 - For a DHCP network environment
The receives the IP address automatically (DHCP) when computer is configured to DHCP.



If the printing job is not working in DHCP mode, the problem may be caused by the automatically changed IP address. Compare the IP address between

the product's IP address and the printer port's IP address.

How to compare:

- 1 Print the network information report of your printer, and then check the IP address (see "Printing a network configuration report" on page 96).
- 2 Check the printer port's IP address from your computer.
 - a Click the Windows **Start** menu.
 - b For Windows XP/Server 2003, select **Printer and Faxes**.
 - For Windows Server 2008/Vista, select **Control Panel > Hardware and Sound > Printers**.
 - For Windows 7, select **Control Panel > Devices and Printers**.
 - For Windows Server 2008 R2, select **Control Panel > Hardware > Devices and Printers**.
 - c Right-click your machine.
 - d For Windows XP/2003/2008/Vista, press **Properties**.
For Windows 7 and Windows Server 2008 R2, from context menus, select the **Printer properties**.
If **Printer properties** item has ► mark, you can select other printer drivers connected with selected printer.
 - e Click **Port** tab.
 - f Click **Configure Port..** button.
 - g Check if **Printer Name** or **IP Address:** is the IP address on the network configuration Sheet.
- 3 Change the printer port's IP address if it is different from the network information report's.
If you want to use the software installation CD to change the port IP, connect to a network printer. Then reconnect the IP address.

Wireless network setup

- For a Static network environment

The machine uses the static address when the computer is configured to static address.

For example,

If the computer's network information is as shown below:

- IP address: 169.254.133.42
- Subnet Mask: 255.255.0.0

Then the machine's network information should be as below:

- IP address: 169.254.133.**43**
- Subnet Mask: 255.255.0.0 (Use the computer's subnet mask.)
- Gateway: 169.254.133.1

Other problems

If problems occur while using the machine on a network, check the following:



For information on the access point (or wireless router), refer to its own user's guide.

- You cannot enable wired and wireless networks at the same time.
- Your computer, access point (or wireless router), or machine may not be turned on.

- Check the wireless reception around the machine. If the router is far from the machine or there is an obstacle, you might have difficulty receiving the signal.
- Cycle the power for the access point (or wireless router), machine, and computer. Sometimes cycling the power can recover network communication.
- Check whether firewall software (V3 or Norton) is blocking the communication.

If the computer and the machine are connected on the same network and it cannot be found when searching, firewall software might be blocking the communication. Refer to the user's guide for the software to turn it off and try searching for the machine again.

- Check whether the machine's IP address is allocated correctly. You can check the IP address by printing the network configuration report.
- Check whether the access point (or wireless router) has a configured security (password). If it has a password, refer to the access point (or wireless router) administrator.
- Check the machine's IP address. Reinstall the machine driver and change the settings to connect to the machine on the network. Due to the characteristics of DHCP, the allocated IP address could change if the machine is not used for a long time or if the access point has been reset.

Register the product's MAC address when you configure the DHCP server on the access point (or wireless router). Then you can always use the IP address that is set with the MAC address. You can identify the Mac address of your machine by printing a network configuration report (see "Printing a network configuration report" on page 96).

Wireless network setup

- Check the wireless environment. You might not be able to connect to the network in the infrastructure environment where you need to type in a user's information before connecting to the access point (or wireless router).
- This machine only supports IEEE 802.11 b/g/n and Wi-Fi. Other wireless communication types (e.g., Bluetooth) are not supported.
- When using the ad hoc mode, in operating systems such as Windows Vista, you might need to set the wireless connection setting every time you use the wireless machine.
- You cannot use infrastructure mode and ad hoc mode at the same time for Samsung wireless network machines.
- The machine is within the range of the wireless network.
- The machine is located away from obstacles that could block the wireless signal.

Remove any large metal objects between the access point (or wireless router) and the machine.

Make sure the machine and wireless access point (or wireless router) are not separated by poles, walls, or support columns containing metal or concrete.

- The machine is located away from other electronic devices that may interfere with the wireless signal.
Many devices can interfere with the wireless signal, including a microwave oven and some Bluetooth devices.
- Whenever the configuration of your access point (or wireless router) changes, you must do the product's wireless network setup again.
- The maximum number of device that can be connected via **Wi-Fi Direct** is 3.

- If **Wi-Fi Direct** is **ON**, this machine only supports IEEE 802.11 b/g.
- If the access point is set to work with the 802.11n standard only, it may not connect to your machine.

Samsung Mobile Print

What is Samsung Mobile Print?

Samsung Mobile Print is a free application that enables users to print photos, documents, and web pages directly from your smartphone or tablet. **Samsung Mobile Print** is not only compatible with your Android and iOS smart phones but also with your iPod Touch and tablet PC. It connects your mobile device to a network connected Samsung printer or to a wireless printer through a Wi-Fi access point. Installing a new driver or configuring network settings isn't necessary – just simply install the **Samsung Mobile Print** application, and it will automatically detect compatible Samsung printers. Besides printing photos, web pages, and PDFs, scanning is also supported. If you have Samsung multifunction printer, scan any document into a JPG, PDF, or PNG format for quick and easy viewing on your mobile device.

Downloading Samsung Mobile Print

To download **Samsung Mobile Print**, go to the application store (Samsung Apps, Play Store, App Store) on your mobile device, and just search for "**Samsung Mobile Print**." You can also visit iTunes for Apple devices on your computer.



Supported Mobile OS

- Android OS 2.1 or higher
- iOS 4.0 or higher

Supported devices

- **iOS 4.0 or higher:** iPod Touch, iPhone, iPad
- **Android 2.1 or higher:** Galaxy series and Android mobile devices

Using the NFC feature

The NFC (Near Field Communication) printer allows you to directly print from your cell phone just by holding your cell phone over the NFC tag on your printer. It does not require installing print driver or connecting to an access point. You just need NFC supported cell phone. In order to use this feature, Samsung Mobile Print app needs to be installed on your cell phone.



- Depending on the material of the cell phone cover, NFC recognition may not work properly.
- Depending on the cell phone you are using, the transmission speed may differ.

Requirements

- NFC and Wi-Fi Direct enabled, Mobile Print app installed cell phone with Android OS 4.0 or higher.



Only Android OS 4.1 or higher will automatically enable the Wi-Fi Direct feature on your cell phone when you enable the NFC feature. We recommend you to upgrade your cell phone to Android OS 4.1 or higher to use the NFC feature.

- Wi-Fi Direct feature enabled printer. Wi-Fi Direct feature is enabled by default.

Printing

- 1 Check that NFC and Wi-Fi Direct feature are enabled on your cell phone and Wi-Fi Direct feature is enabled on your printer (see "Setting up Wi-Fi Direct" on page 133).
- 2 Tag the NFC antenna on your cell phone (usually located on the back of the cell phone) over the NFC tag (NFC) on your printer.

Wait few seconds for the Samsung Mobile Print app to start.

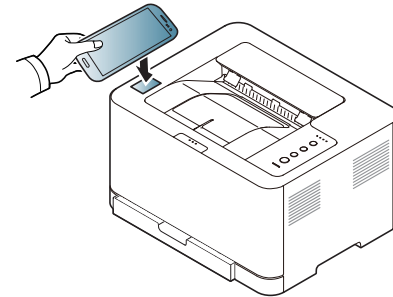

- For some cell phones, NFC antenna might not be located at the back of the cell phone. Check the location of the NFC antenna on your cell phone before tagging.
- If error message about changed PIN number appears, enter a changed PIN number and press OK. Follow the instruction on the app screen to update the PIN number.
- If you do not have Samsung Mobile Print app installed on your cell phone, it automatically connects to Samsung Mobile Print app download page. Download the app and try again.

Using the NFC feature

- 3 Select the content you want to print.

If necessary, change the print option by pressing the .

- 4 Tag the NFC antenna on your cell phone(usually located on the back of the cell phone) over the NFC tag() on your printer.

Wait few seconds for the cell phone to connect to the printer.

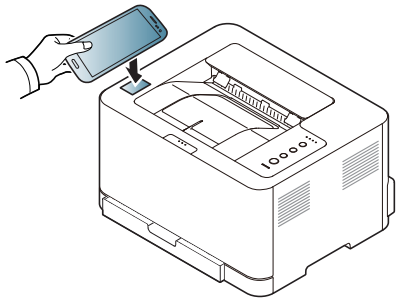

- For some cell phones, NFC antenna might not be located at the back of the cell phone. Check the location of the NFC antenna on your cell phone before tagging.
- If error message about changed PIN number appears, enter a changed PIN number and press OK. Follow the instruction on the app screen to update the PIN number.

- 5 The printer starts printing.

Google Cloud Print

Google Cloud Print™ is a service that allows you to print to a printer using your mobile phone, tablet, or any other web-connected devices. Just register your Google account with the printer, and you are ready to use the Google Cloud Print service. You can print your document or email with Chrome OS, Chrome browser, or a Gmail/ GOOGLE DOCS application on your mobile device, so you don't need to install the printer driver on the mobile device. Refer to the Google website (<http://support.google.com/cloudprint>) for more information about Google Cloud Print™.

Registering your Google account to the printer



- Make sure the printer machine is turned on and connected to a wired or wireless network that has access to the Internet.
- You should create your Google account in the advance.

- 1 Open the Chrome browser.
- 2 Visit www.google.com.
- 3 Sign in to the Google website with your Gmail™ address.
- 4 Start Chrome and enter your printer's IP address in the browser window.
- 5 Click **Login** in the upper right corner of the SyncThru™ Web Service website.

- 6 If it's your first time logging into **SyncThru™ Web Service** you need to log-in as an administrator. Type in the below default **ID** and **Password**. We recommend you to change the default password for security reasons.

- **ID: admin**
- **Password: sec00000**



If the network environment is using a proxy server, you need to configure the proxy's IP and port number from **Settings > Network Settings > Google Cloud Print > Proxy Setting**. Contact your network service provider or network administrator for more information.

- 7 When the **SyncThru™ Web Service** window opens, click **Settings > Network Settings > Google Cloud Print**.
- 8 Enter your printer's name and description.
- 9 Click **Register**.
The confirmation pop-up window appears.



If you set the browser to block pop-ups, the confirmation window will not appear. Allow the site to show pop-ups.

- 10 Click **Finish printer registration**.

Google Cloud Print

11 Click **Manage your printers**.

Now your printer is registered with Google Cloud Print service.

Google Cloud Print-ready devices will appear in the list.

Printing with Google Cloud Print

The printing procedure varies depending on the application or the device you are using. You can see the application list that supports Google Cloud Print service.



Make sure the printer is turned on and connected to a wired or wireless network that has access to the Internet.



Printing from an application on mobile device

The following steps are an example of using the GOOGLE DOCS app from Android mobile phone.

1 Install the Cloud Print application on your mobile device.



If you do not have the application, download it from the application store such as Android Market or App Store.

- 2 Access the GOOGLE DOCS application from your mobile device.
- 3 Tap the option  button of the document that you want to print.
- 4 Tap the send  button.
- 5 Tap the Cloud Print ( button).
- 6 Set the printing options if you want.
- 7 Tap **Click here to Print**.

Printing from the Chrome browser

The following steps are an example of using the Chrome browser.

- 1 Run Chrome.
- 2 Open the document or email that you want to print.
- 3 Click the wrench icon () in the browser's top right corner.
- 4 Click **Print**. A new tab for printing appears.
- 5 Select **Print with Google Cloud Print**.
- 6 Click the **Print** button.



3. Special features

This chapter explains special printing features.

- **Altitude adjustment** 145
- **Changing the default print settings** 146
- **Setting your machine as a default machine** 147
- **Using advanced print features** 148
- **Mac printing** 155
- **Linux printing** 157



The procedures in this chapter are mainly based on Windows 7.

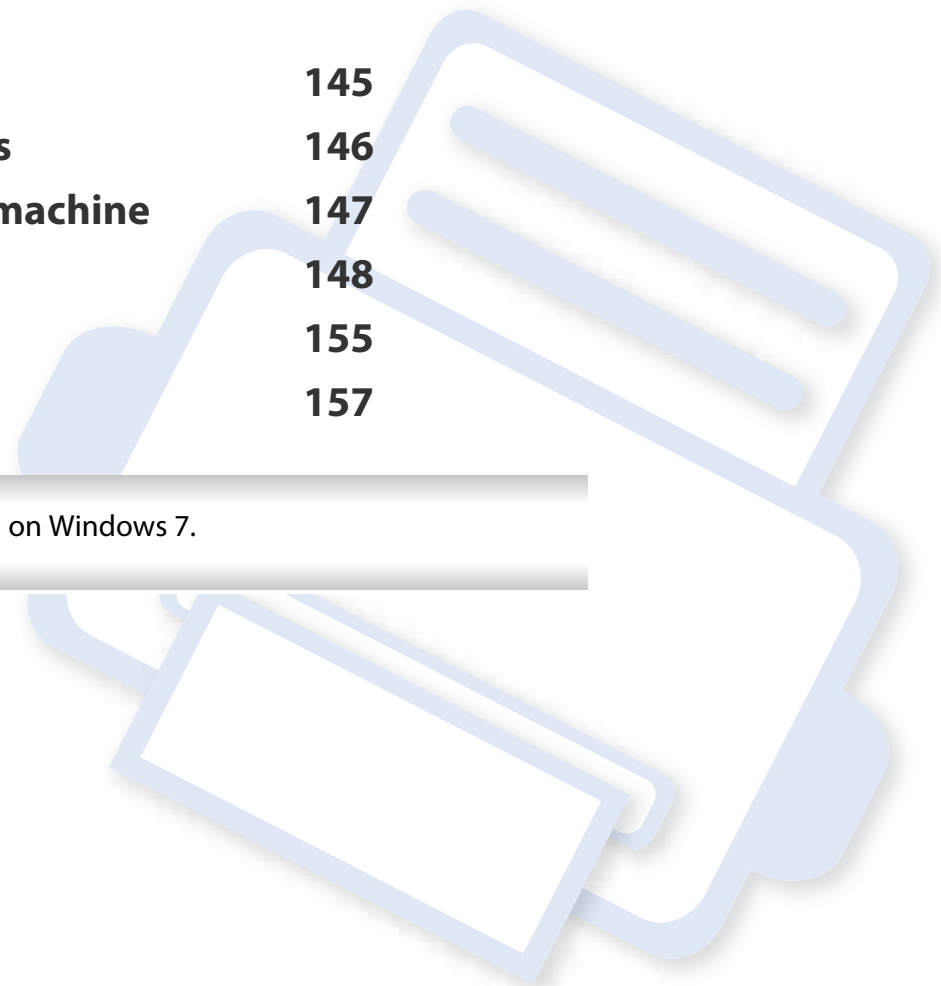

Altitude adjustment

Print quality is affected by atmospheric pressure, which is determined by the height of the machine above sea level. The following information will guide you on how to set your machine for the best print quality.

Before you set the altitude value, determine the altitude where you are.

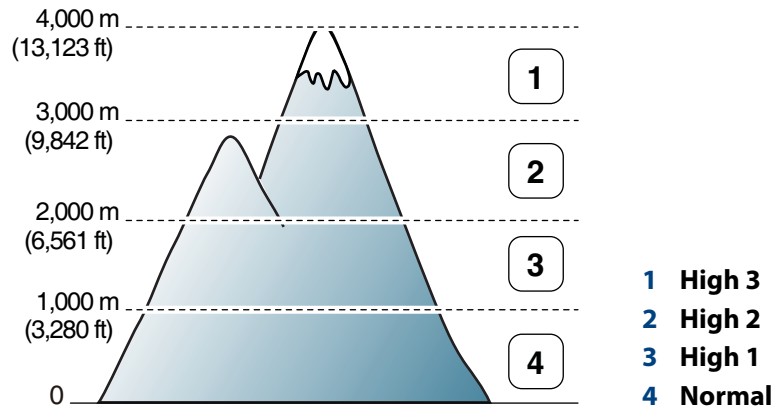

- For Windows and Mac users, you set from **Samsung Easy Printer Manager**
 - >  **(Switch to advanced mode)** > **Device Settings**. See "Device Settings" on page 168.



- If your machine is connected to the network, you can set the altitude via SyncThru™ Web Service (see "Using SyncThru™ Web Service" on page 164).

Changing the default print settings

- 1 Click the Windows **Start** menu.
- 2 For Windows XP/Server 2003, select **Printer and Faxes**.
 - For Windows Server 2008/Vista, select **Control Panel > Hardware and Sound > Printers**.
 - For Windows 7, select **Control Panel > Devices and Printers**.
 - For Windows Server 2008 R2, select **Control Panel > Hardware > Devices and Printers**.
- 3 Right-click on your machine.
- 4 For Windows XP/Server 2003/Server 2008/Vista, select **Printing Preferences**.
For Windows 7 or Windows Server 2008 R2, from context menus, select **Printing preferences**.



If **Printing preferences** has a ►, you can select other printer drivers connected to the selected printer.

- 5 Change the settings on each tab.
- 6 Click **OK**.



If you want to change the settings for each print job, change it in **Printing Preferences**.

Setting your machine as a default machine

- 1 Click the Windows **Start** menu.
- 2 For Windows XP/Server 2003, select **Printer and Faxes**.
 - For Windows Server 2008/Vista, select **Control Panel > Hardware and Sound > Printers**.
 - For Windows 7, select **Control Panel > Devices and Printers**.
 - For Windows Server 2008 R2, select **Control Panel > Hardware > Devices and Printers**.
- 3 Select your machine.
- 4 Right-click your machine and select **Set as Default Printer**.



For Windows 7 or Windows Server 2008 R2, if **Set as default printer** has a ►, you can select other printer drivers connected to the selected printer.

Using advanced print features



XPS printer driver: used to print XPS file format.

- See "Features by models" on page 6.
- The XPS printer driver can be installed only on Windows Vista OS or higher.
- Install optional memory when an XPS job does not print because the printer is out of memory.
- You can install the XPS printer driver when you insert the software CD into your CD-ROM drive. When the installation window appears, select **Custom Installation**. You can select the XPS printer driver in the **Select Software** window.
- For models that provide XPS driver from the Samsung website, www.samsung.com > find your product > Support or downloads.

Printing to a file (PRN)

You will sometimes need to save the print data as a file.

- 1 Check the **Print to file** box in the **Print** window.

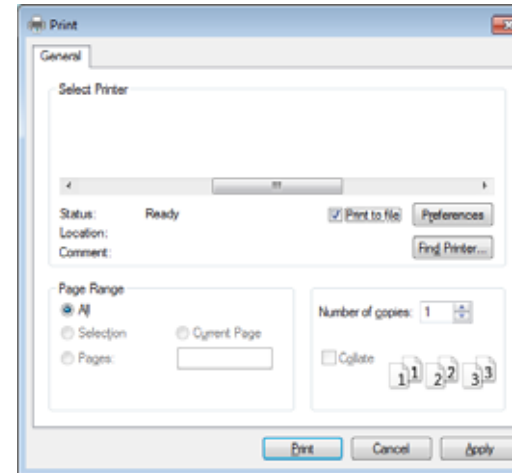

- 2 Click **Print**.
- 3 Type in the destination path and the file name, and then click **OK**.
For example, **c:\Temp\file name**.



If you type in only the file name, the file is automatically saved in **My Documents**, **Documents and Settings**, or **Users**. The saved folder may differ, depending on your operating system or the application you are using.

Using advanced print features

Understanding special printer features

You can use advanced printing features when using your machine.





To take advantage of the printer features provided by your printer driver, click **Properties** or **Preferences** in the application's **Print** window to change the print settings. The machine name, that appears in the printer properties window may differ depending on the machine in use.

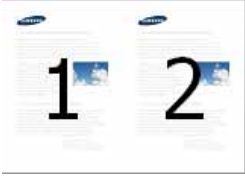

- Some menus may not appear on the display depending on options or models. If so, it is not applicable to your machine.
- Select the **Help** or click the  button from the window or press **F1** on your keyboard and click on any option you want to know about (see "Using help" on page 36).

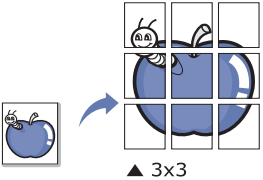
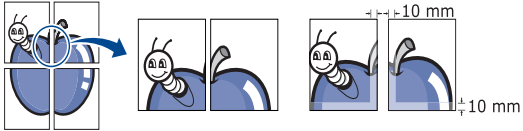
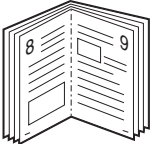
Item	Description
<p data-bbox="49 865 376 896">Multiple Pages per Side</p> 	<p data-bbox="465 865 2190 938">Selects the number of pages to print on a single sheet of paper. To print more than one page per sheet, the pages will be reduced in size and arranged in the order you specify. You can print up to 16 pages on one sheet.</p>



Using advanced print features

Item	Description
<p>Poster Printing</p> 	<p>Prints a single-page document onto 4 (Poster 2x2), 9 (Poster 3x3), or 16 (Poster 4x4) sheets of paper, for the purpose of pasting the sheets together to form one poster-size document.</p> <p>Select the Poster Overlap value. Specify Poster Overlap in millimeters or inches by selecting the radio button on the upper right of Basic tab to make it easier to paste the sheets together.</p> 
<p>Booklet Printing^a</p> 	<p>Prints your document on both sides of a sheet of paper and arranges the pages so that the paper can be folded in half after printing to produce a booklet.</p> <p>If you want to make a booklet, you need to print on Letter, Legal, A4, US Folio, or Oficio sized print media.</p> <div data-bbox="488 826 2190 1082" style="background-color: #f0f0f0; padding: 10px;"><p> The Booklet Printing option is not available for all paper sizes. Select the available paper Size option under the Paper tab to see what paper sizes are available.</p><p>If you select an unavailable paper size, this option can be automatically canceled. Select only available paper (paper without  or  mark).</p></div>

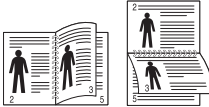
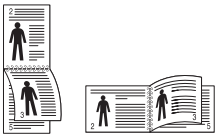

Using advanced print features

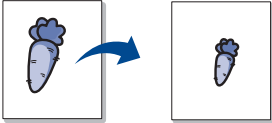
Item	Description
<ul style="list-style-type: none">• Double-sided Printing^a• Double-sided Printing (Manual)^a	<p>Print on both sides of a sheet of paper (duplex). Before printing, decide how you want your document oriented.</p> <div data-bbox="465 352 2197 699" style="background-color: #f0f0f0; padding: 10px;"><ul style="list-style-type: none">• You can use this feature with Letter, Legal, A4, US Folio or Oficio sized paper• If your machine does not have a duplex unit, you should complete the printing job manually. The machine prints every other page of the document first. After that, a message appears on your computer.• Skip Blank Pages feature does not work when you select the duplex option.• We recommend not to print on both sides of the special media, such as labels, envelopes, or thick paper. It may cause a paper jam or damage the machine.</div> <ul style="list-style-type: none">• Printer Default: If you select this option, this feature is determined by the settings you have selected on the control panel of the machine. This option is available only when you use the PCL / XPS printer driver (see "Features by models" on page 6).• None: Disables this feature.• Long Edge: This option is the conventional layout used in bookbinding. • Short Edge: This option is the conventional layout used in calendars. • Reverse Double-Sided Printing: Check this option to reverse the print order when duplex printing. This option is not available when you use the Reverse Double-Sided Printing (Manual).

Using advanced print features

Item	Description
<p data-bbox="51 272 253 304">Paper Options</p> 	<p data-bbox="461 272 2130 344">Changes the size of a document to appear larger or smaller on the printed page by entering in a percentage by which to enlarge or decrease the document.</p>
<p data-bbox="51 501 210 533">Watermark</p> 	<p data-bbox="461 501 2190 574">The watermark option allows you to print text over an existing document. For example, you use it when you want to have large gray letters reading "DRAFT" or "CONFIDENTIAL" printed diagonally across the first page or all pages of a document.</p>
<p data-bbox="51 775 367 863">Watermark (Creating a watermark)</p>	<ul data-bbox="461 775 1944 938" style="list-style-type: none">a To change the print settings from your software application, access Printing Preferences.b Click the Advanced tab, select Edit from the Watermark drop-down list. The Edit Watermarks window appears.c Enter a text message in the Watermark Message box. You can enter up to 256 characters. The message displays in the preview window.
<p data-bbox="51 973 349 1061">Watermark (Editing a watermark)</p>	<ul data-bbox="461 973 2069 1182" style="list-style-type: none">a To change the print settings from your software application, access Printing Preferences.b Click the Advanced tab, select Edit from the Watermark drop-down list. The Edit Watermarks window appears.c Select the watermark you want to edit from the Current Watermarks list and change the watermark message and options.d Click Update to save the changes.e Click OK or Print until you exit the Print window.
<p data-bbox="51 1214 367 1302">Watermark (Deleting a watermark)</p>	<ul data-bbox="461 1214 1944 1377" style="list-style-type: none">a To change the print settings from your software application, access Printing Preferences.b Click the Advanced tab, select Edit from the Watermark drop-down list. The Edit Watermarks window appears.c Select the watermark you want to delete from the Current Watermarks list and click Delete.d Click OK or Print until you exit the Print window.

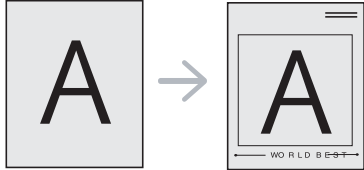
Using advanced print features

Item	Description
<p data-bbox="53 411 174 443">Overlay^a</p> 	<p data-bbox="465 272 1621 304">This option is available when you use the PCL/SPL printer driver (see "Software" on page 7).</p> <p data-bbox="465 328 2190 485">An overlay is text and/or images stored in the computer hard disk drive (HDD) as a special file format that can be printed on any document. Overlays are often used to take the place of letterhead paper. Rather than using preprinted letterhead, you can create an overlay containing exactly the same information that is currently on your letterhead. To print a letter with your company's letterhead, you do not need to load preprinted letterhead paper in the machine: just print the letterhead overlay on your document.</p> <p data-bbox="465 509 1615 541">To use a page overlay, you must create a new page overlay containing your logo or image.</p> <div data-bbox="465 592 2197 790" style="background-color: #f0f0f0; padding: 10px;"><ul data-bbox="562 624 2145 746" style="list-style-type: none">• The overlay document size must be the same as the document you print with the overlay. Do not create an overlay with a watermark.• The resolution of the overlay document must be the same as that of the document you will print with the overlay.</div>
<p data-bbox="53 826 344 951">Overlay (Creating a new page overlay)</p>	<ol data-bbox="465 826 2130 1118" style="list-style-type: none">a To save the document as an overlay, access Printing Preferences.b Click the Advanced tab, and select Edit from the Text drop-down list. Edit Overlay window appears.c In the Edit Overlay window, click Create.d In the Save As window, type a name in the File name box. Select the destination path, if necessary (The default is C:\Formover).e Click Save. The name appears on the Overlay List.f Click OK or Print until you exit the Print window. The file is not printed. Instead, it is stored on your computer hard disk drive.

Using advanced print features

Item	Description
Overlay (Using a page overlay)	<ul style="list-style-type: none">a Click the Advanced tab.b Select the desired overlay from the Text drop-down list.c If the overlay file you want does not appear in the Text drop-down list, select Edit... from the list and click Load. Select the overlay file you want to use. If you have stored the overlay file you want to use in an external source, you can also load the file when you access the Open window. After you select the file, click Open. The file appears in the Overlay List box and is available for printing. Select the overlay from the Overlay List box.d If necessary, check Confirm Page Overlay When Printing box. If this box is checked, a message window appears each time you submit a document for printing, asking you to confirm printing an overlay on your document. If this box is not checked and an overlay has been selected, the overlay automatically prints with your document.e Click OK or Print until you exit the Print window.
Overlay (Deleting a page overlay)	<ul style="list-style-type: none">a In the Printing Preferences window, click the Advanced tab.b Select Edit in the Text drop down list.c Select the overlay you want to delete from the Overlay List box.d Click Delete.e When a confirming message window appears, click Yes.f Click OK or Print until you exit the Print window. You can delete page overlays that you no longer use.

a. This option is not available when you use XPS driver.

Mac printing



Some features may not be available depending on models or options. It means that the features are not supported.

Printing a document

When you print with a Mac, you need to check the printer driver settings in each application you use. Follow the steps below to print from a Mac:

- 1 Open the document to print.
- 2 Open the **File** menu and click **Page Setup** (**Document Setup** in some applications).
- 3 Choose your paper size, orientation, scaling, other options, and make sure that your machine is selected. Click **OK**.
- 4 Open the **File** menu and click **Print**.
- 5 Choose the number of copies and indicate which pages to print.
- 6 Click **Print**.

Changing printer settings

You can use advanced printing features when using your machine.

Open an application and select **Print** from the **File** menu. The machine name, which appears in the printer properties window, may differ depending on the machine in use. Except for the name, the composition of the printer properties window is similar to the following.

Printing multiple pages on one sheet

You can print more than one page on a single sheet of paper. This feature provides a cost-effective way to print draft copies.

- 1 Open an application, and select **Print** from the **File** menu.
- 2 Select **Layout** from the drop-down list under **Orientation**. In the **Pages per Sheet** drop-down list, select the number of pages you want to print on one sheet of paper.
- 3 Select the other options to use.
- 4 Click **Print**.
The machine prints the selected number of pages to print on one sheet of paper.

Mac printing

Printing on both sides of the paper



Some features may not be available depending on models or options. It means that the features are not supported.

Before printing in the duplex mode, decide on which edge you will be binding your finished document. The binding options are, as follows:

- **Long-Edge Binding:** This option is the conventional layout used in book binding.
- **Short-Edge Binding:** This option is the type often used with calendars.

- 1 From your Mac application, select **Print** from the **File** menu.
- 2 Select **Layout** from the drop-down list under **Orientation**.
- 3 Select a binding orientation from the **Two-Sided** option.
- 4 Select the other options to use.
- 5 Click **Print** and the machine prints on both sides of the paper.



If you print more than 2 copies, the first copy and the second copy might print on the same sheet of paper. Avoid printing on both sides of paper when you are printing more than 1 copy.

Using help

Click the question mark on the bottom-left corner of the window and click on the topic you want to know about. A pop-up window appears with information about that option's feature, which is provided from the driver.

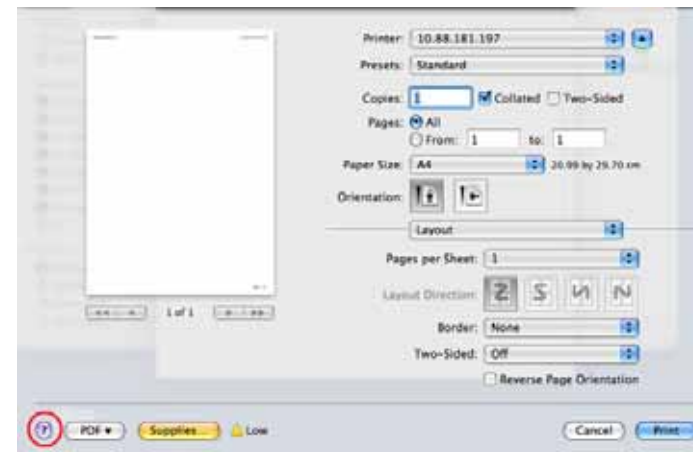

Linux printing



Some features may not be available depending on models or options. It means that the features are not supported.

Printing from applications

There are a lot of Linux applications that allow you to print using Common UNIX Printing System (CUPS). You can print on your machine from any such application.

- 1 Open the document to print.
- 2 Open the **File** menu and click **Page Setup (Print Setup** for some applications).
- 3 Choose your paper size, orientation, and make sure that your machine is selected. Click **Apply**.
- 4 Open the **File** menu and click **Print**.
- 5 Select your machine to print.
- 6 Choose the number of copies and indicate which pages to print.
- 7 Change other printing options in each tab, if necessary.

8

Click **Print**.



Automatic duplex printing may not be available depending on models. You can alternatively use the lpr printing system or other applications for odd-even printing (see "Features by models" on page 6).

Printing files

You can print text, image, pdf files on your machine using the standard

CUPS directly from the command line interface. The CUPS lp or lpr utility allows you to do that. You can print these files by using below command format.

"lp -d <printer name> -o <option> <file name>"

Please refer to lp or lpr man page on your system for more details.

Linux printing

Configuring Printer Properties

Using the **Printer Properties** window provided by the **Printers configuration**, you can change the various properties for your machine as a printer.

1 Open the **Unified Driver Configurator**.

If necessary, switch to **Printers configuration**.

2 Select your machine on the available printers list and click **Properties**.

3 The **Printer Properties** window appears.

The following five tabs display at the top of the window:

- **General:** Allows you to change the printer location and name. The name entered in this tab displays on the printer list in **Printers configuration**.
- **Connection:** Allows you to view or select another port. If you change the machine port from USB to parallel or vice versa while in use, you must re-configure the machine port in this tab.
- **Driver:** Allows you to view or select another machine driver. By clicking **Options**, you can set the default device options.
- **Jobs:** Shows the list of print jobs. Click **Cancel job** to cancel the selected job and select the **Show completed jobs** check box to see previous jobs on the job list.

- **Classes:** Shows the class that your machine is in. Click **Add to Class** to add your machine to a specific class or click **Remove from Class** to remove the machine from the selected class.

4 Click **OK** to apply the changes and close the **Printer Properties** window.



4. Useful management tools

This chapter introduces management tools provided to help you make full use of your machine.

- **Easy Capture Manager** 160
- **Samsung Easy Color Manager** 161
- **Samsung AnyWeb Print** 162
- **Easy Eco Driver** 163
- **Using SyncThru™ Web Service** 164
- **Using Samsung Easy Printer Manager** 167
- **Using Samsung Printer Status** 170
- **Using the Linux Unified Driver Configurator** 172

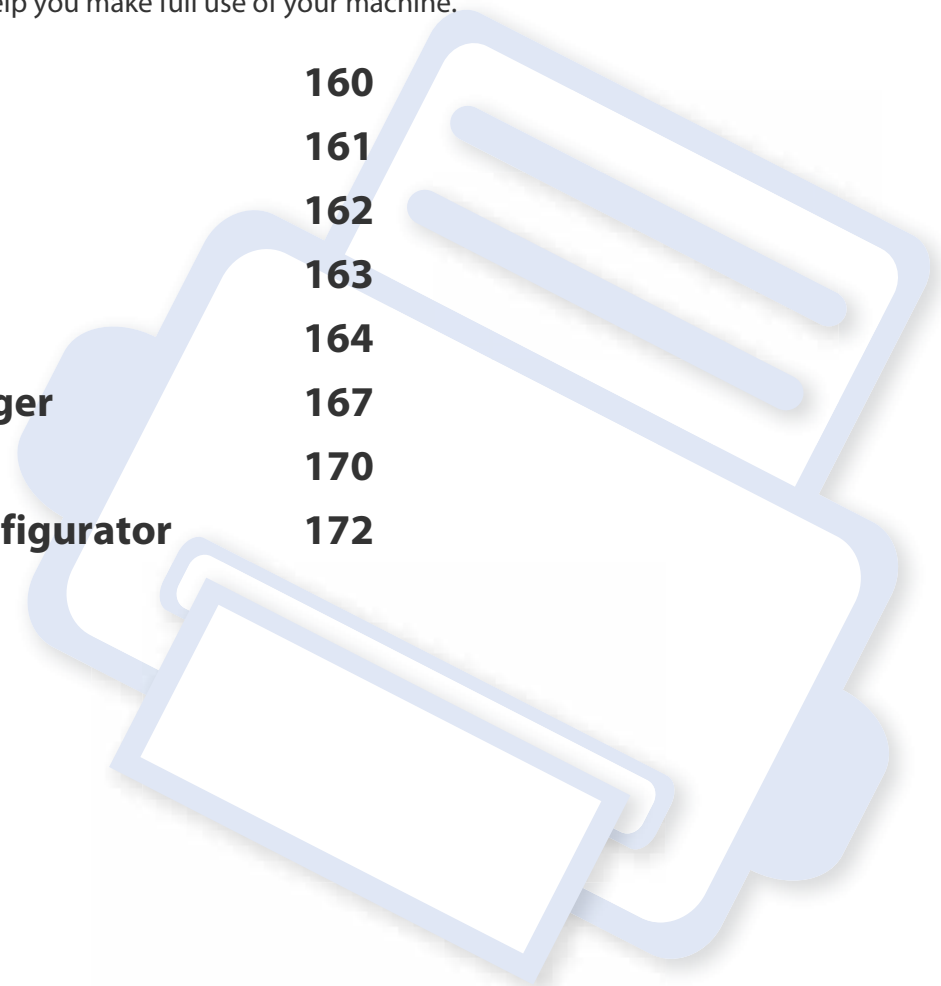

Easy Capture Manager



- This feature may not be available depending on model or optional goods (see "Software" on page 7).
- Available for Windows OS users only (see "Software" on page 7).

Capture your screen and launch Easy Capture Manager by simply pressing the Print Screen key on the keyboard. Now you can easily print your captured screen as captured or edited.

Samsung Easy Color Manager

Samsung Easy Color Manager helps users do fine adjustments with 6 color tones and other properties, such as brightness, contrast, and saturation. Color tone changes can be saved as a profile and can be used from the driver or from inside of the machine.



- This feature may not be available depending on model or optional goods (see "Software" on page 7).
- Available for Windows and Mac OS users only (see "Software" on page 7).

Helps Samsung color laser printer users to adjust color as they like.

Download the software from the Samsung website then unpack and install it: (<http://www.samsung.com> > find your product > Support or Downloads).

Samsung AnyWeb Print



Available for Windows and Mac OS users only.

This tool helps you screen-capture, preview, scrap, and print pages more easily, than when you use an ordinary program.

Download the software from the Samsung website then unpack and install it: (<http://www.samsung.com> > find your product > Support or Downloads).

Easy Eco Driver

With the Easy Eco Driver, you can apply Eco features to save paper and toner before printing.

Easy Eco Driver also allows you simple editing such as removing images and texts, and more. You can save frequently used settings as a preset.



Available for Windows OS users only.

How to use:

- 1 Open a document to print.
- 2 Open printing preference window (see "Opening printing preferences" on page 34).
- 3 From the **Favorites** tab, select **Eco Printing Preview**.
- 4 Click **OK > Print** in the window.
A preview window appears.
- 5 Select the options you want to apply to the document.
You can see the preview of the applied features.
- 6 Click **Print**.



If you want to run Easy Eco Driver every time you print, check **Start Easy Eco Driver before printing job** checkbox in the **Basic** tab of the printing preference window.

Using SyncThru™ Web Service



- Internet Explorer 6.0 or higher is the minimum requirement for SyncThru™ Web Service.
- SyncThru™ Web Service explanation in this user's guide may differ from your machine depending on its options or models.
- Network model only.

Accessing SyncThru™ Web Service

- 1 Access a web browser, such as Internet Explorer, from Windows.
Enter the machine IP address of your printer (<http://xxx.xxx.xxx.xxx>) in the address field and press the Enter key or click **Go**.
- 2 Your machine's embedded website opens.

Logging into SyncThru™ Web Service

Before configuring options in SyncThru™ Web Service, you need to log-in as an administrator. You can still use SyncThru™ Web Service without logging in but you won't have access to **Settings** tab and **Security** tab.

- 1 Click **Login** on the upper right of the SyncThru™ Web Service website.
- 2 If it's your first time logging into **SyncThru™ Web Service** you need to log-in as an administrator. Type in the below default ID and password. We recommend you to change the default password for security reasons.
 - **ID: admin**
 - **Password: sec00000**

SyncThru™ Web Service overview



Information

Settings

Security

Maintenance



Some tabs may not appear depending on your model.

Using SyncThru™ Web Service

Information tab

This tab gives you general information about your machine. You can check things, such as remaining amount of toner. You can also print reports, such as an error report.

- **Active Alerts:** Shows the alerts that have occurred in the machine and their severity.
- **Supplies:** Shows how many pages are printed and amount of toner left in the cartridge.
- **Usage Counters:** Shows the usage count by print types: simplex and duplex.
- **Current Settings:** Shows the machine's and network's information.
- **Print information:** Prints reports such as system related reports and font reports.

Settings tab

This tab allows you to set configurations provided by your machine and network. You need to log-in as an administrator to view this tab.

- **Machine Settings** tab: Sets options provided by your machine.
- **Network Settings** tab: Shows options for the network environment. Sets options such as TCP/IP and network protocols.

Security tab

This tab allows you to set system and network security information. You need to log-in as an administrator to view this tab.

- **System Security:** Sets the system administrator's information and also enables or disables machine features.
- **Network Security:** Sets settings for IPv4/IPv6 filtering.

Maintenance tab

This tab allows you to maintain your machine by upgrading firmware and setting contact information for sending emails. You can also connect to Samsung website or download drivers by selecting the **Link** menu.

- **Firmware Upgrade:** Upgrade your machine's firmware.
- **Contact Information:** Shows the contact information.
- **Link:** Shows links to useful sites where you can download or check information.

Setting the system administrator's information

This setting is necessary for using the e-mail notification option.

Using SyncThru™ Web Service

- 1** Start a web browser, such as Internet Explorer, from Windows.
Enter the machine IP address (http://xxx.xxx.xxx.xxx) in the address field and press the Enter key or click **Go**.
- 2** Your machine's embedded website opens.
- 3** From the **Security** tab, select **System Security** > **System Administrator**
- 4** Enter the name of the administrator, phone number, location, and email address.
- 5** Click **Apply**.

Using Samsung Easy Printer Manager

Samsung Easy Printer Manager is an application that combines Samsung machine settings into one location. Samsung Easy Printer Manager combines device settings as well as printing environments, settings/actions and launching. All of these features provide a gateway to conveniently use your Samsung machine. Samsung Easy Printer Manager provides two different user interfaces for the user to choose from: the basic user interface and the advanced user interface. Switching between the two interfaces is easy: just click  button.



- Available for Windows or Mac OS users only.
- For Windows, Internet Explorer 6.0 or higher is the minimum requirement for Samsung Easy Printer Manager.

Understanding Samsung Easy Printer Manager

To open the program:

For Windows,

Select **Start > Programs** or **All Programs > Samsung Printers > Samsung Easy Printer Manager**.

For Mac,

Open the **Applications** folder > **Samsung** folder > **Samsung Easy Printer Manager**.

The Samsung Easy Printer Manager interface is comprised of various basic sections as described in the table that follows:





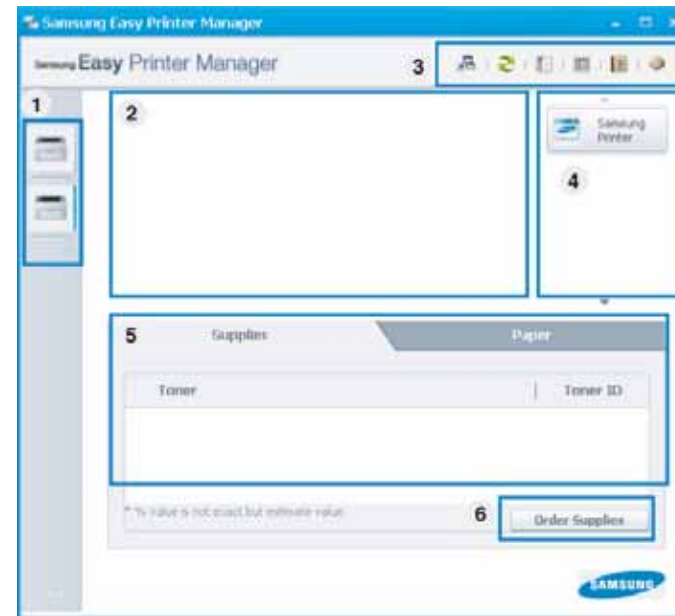

The screenshot may differ depending on operating system you are using.



1	Printer List	The printer list displays the installed printer icons on your computer.
---	---------------------	---

Using Samsung Easy Printer Manager

2	Printer Information	<p>This area gives you general information about your machine. You can check information, such as the machine's model name, IP address (or Port name), and machine status.</p> <p> User's Guide button: This button opens Troubleshooting Guide when an error occurs. You can directly open the necessary section in the user's guide.</p>
3	Application information	<p>Includes links for changing to the advanced settings (switching UI), refresh, preference setting, summary, help, and about.</p> <p> The  button is used to change the user interface to the advanced settings user interface.</p>
4	Quick links	<p>Displays Quick links to machine specific functions. This section also includes links to applications in the advanced settings.</p> <p> If you connect your machine to a network, the SyncThru™ Web Service icon is enabled.</p>

5	Contents Area	Displays information about the selected machine, remaining toner level, and paper. The information will vary based on the machine selected. Some machines do not have this feature.
6	Order Supplies	Click on the Order button from the supply ordering window. You can order replacement toner cartridge(s) from online.



Click the **Help**  button from the upper-right corner of the window and click on any option you want to know about.

Advanced settings user interface overview

The advanced user interface is intended to be used by the person responsible for managing the network and machines.

Device Settings

You can configure various machine settings such as machine setup, paper, layout, emulation, network, and print information.

Using Samsung Easy Printer Manager

Alert Settings (Windows only)

This menu includes settings related to error alerting.

- **Printer Alert:** Provides settings related to when alerts will be received.
- **Email Alert:** Provides options relating to receiving alerts via email.
- **History Alert:** Provides a history of device and toner related alerts.

Job Accounting

Provides querying of quota information of the specified job accounting user. This quota information can be created and applied to devices by job accounting software such as SyncThru™ or CounThru™ admin software.

Using Samsung Printer Status

The Samsung Printer Status is a program that monitors and informs you of the machine status.



- Available for Windows users.
- The Samsung Printer Status window and its contents shown in this user's guide may differ depending on the machine or operating system in use.
- Check the operating system(s) that are compatible with your machine (see "System requirements" on page 71).

Samsung Printer Status overview

If an error occurs while operating, you can check the error from the Samsung Printer Status. Samsung Printer Status is installed automatically when you install the machine software.

You can also launch Samsung Printer Status manually. Go to the **Printing Preferences**, click the **Basic** tab > **Printer Status** button.

These icons appear on the Windows task bar:

Icon	Mean	Description
	Normal	The machine is in ready mode and experiencing no errors or warnings.
	Warning	The machine is in a state where an error might occur in the future. For example, it might be in toner low status, which may lead to toner empty status.
	Error	The machine has at least one error.

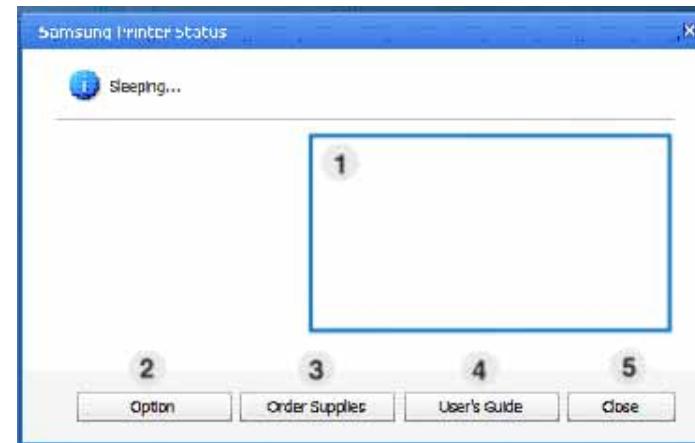

1	Toner Level	You can view the level of toner remaining in each toner cartridge. The machine and the number of toner cartridge(s) shown in the above window may differ depending on the machine in use. Some machines do not have this feature.
2	Option	You can set Printing Job Alert related settings.

Using Samsung Printer Status

3	Order Supplies	You can order replacement toner cartridge(s) from online.
4	User's Guide	<p>You can view the online User's Guide.</p> <div data-bbox="421 395 1079 638"> This button opens the Troubleshooting Guide when an error occurs. You can directly open the troubleshooting section in the user's guide.</div>
5	Close	Close the window.

Using the Linux Unified Driver Configurator

The Unified Driver Configurator is a tool primarily intended for configuring machine devices. You need to install Unified Linux Driver to use Unified Driver Configurator (see "Installation for Linux" on page 92).

After the driver is installed on your Linux system, the Unified Driver Configurator icon will automatically be created on your desktop.

Opening Unified Driver Configurator

- 1 Double-click the **Unified Driver Configurator** on the desktop.
You can also click the **Startup** Menu icon and select **Samsung Unified Driver > Unified Driver Configurator**.
- 2 Click each button on the left to switch to the corresponding configuration window.

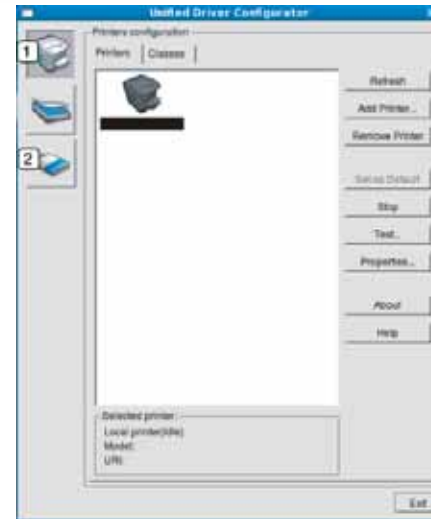

- 1 **Printer Configuration**
- 2 **Port Configuration**



To use the on screen help, click **Help**.

- 3 After changing the configurations, click **Exit** to close the **Unified Driver Configurator**.

Printers configuration

Printers configuration has the two tabs: **Printers** and **Classes**.

Using the Linux Unified Driver Configurator

Printers tab

View the current system's printer configuration by clicking on the machine icon button on the left side of the **Unified Driver Configurator** window.



- | | |
|---|--|
| 1 | Switches to Printers configuration . |
| 2 | Shows all of the installed machines. |
| 3 | Shows the status, model name, and URI of your machine. |

The printer control buttons are, as follows:

- **Refresh:** Renews the available machines list.
- **Add Printer:** Allows you to add a new machines.
- **Remove Printer:** Removes the selected machine.

- **Set as Default:** Sets the current selected machine as a default machine.
- **Stop/Start:** Stops/starts the machine.
- **Test:** Allows you to print a test page to ensure the machine is working properly.
- **Properties:** Allows you to view and change the printer's properties.

Classes tab

The Classes tab shows a list of available machine classes.



Using the Linux Unified Driver Configurator

- | | |
|---|--|
| 1 | Shows all of the machine classes. |
| 2 | Shows the status of the class and the number of machines in the class. |

- **Refresh:** Renews the classes list.
- **Add Class:** Allows you to add a new machine class.
- **Remove Class:** Removes the selected machine class.

Ports configuration

In this window, you can view the list of available ports, check the status of each port and release a port that is stalled in a busy state when its owner has terminated the job for any reason.



- | | |
|---|--|
| 1 | Switches to Ports configuration . |
| 2 | Shows all of the available ports. |
| 3 | Shows the port type, device connected to the port, and status. |

- **Refresh:** Renews the available ports list.
- **Release port:** Releases the selected port.



5. Troubleshooting

This chapter gives helpful information for what to do if you encounter an error.

- **Paper feeding problems** 176
- **Power and cable connecting problems** 177
- **Printing problems** 178
- **Printing quality problems** 182
- **Operating system problems** 190

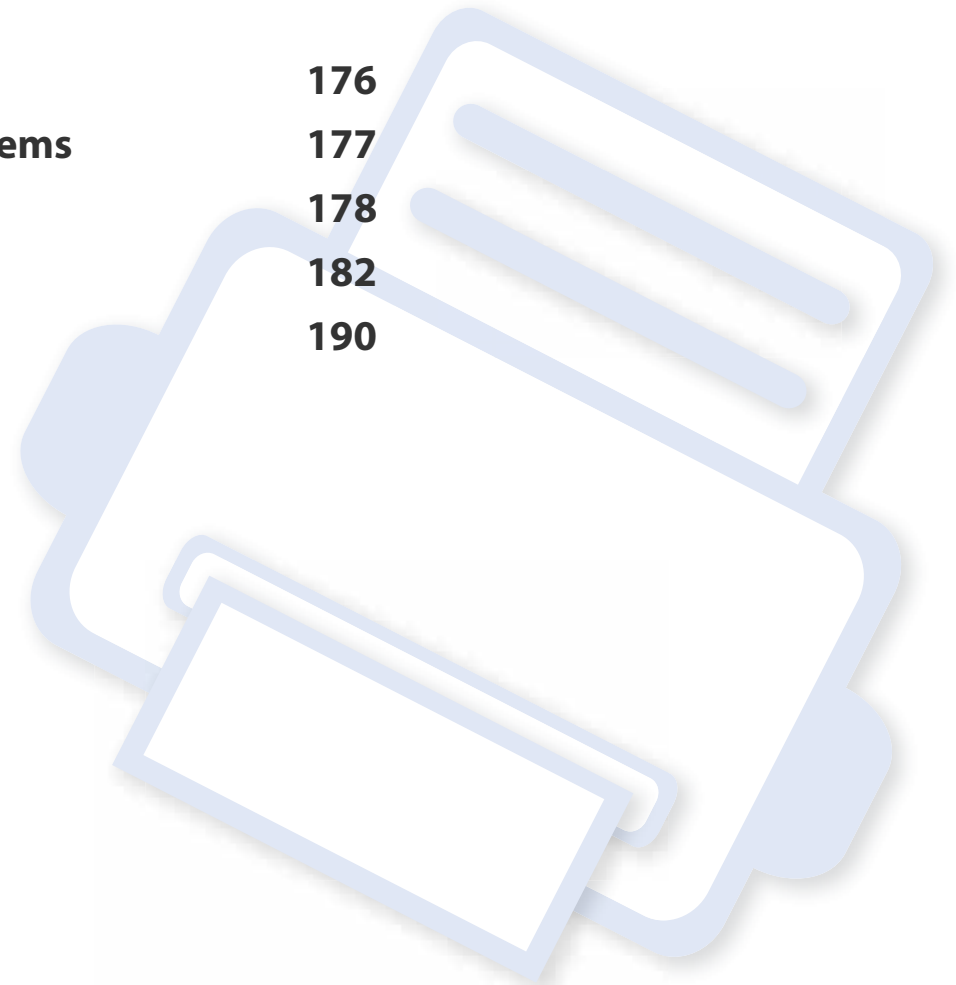

Paper feeding problems

Condition	Suggested solutions
Paper jams during printing.	Clear the paper jam.
Paper sticks together.	<ul style="list-style-type: none">• Check the maximum paper capacity of the tray.• Make sure that you are using the correct type of paper.• Remove paper from the tray and flex or fan the paper.• Humid conditions may cause some paper to stick together.
Multiple sheets of paper do not feed.	Different types of paper may be stacked in the tray. Load paper of only one type, size, and weight.
Paper does not feed into the machine.	<ul style="list-style-type: none">• Remove any obstructions from inside the machine.• Paper has not been loaded correctly. Remove paper from the tray and reload it correctly.• There is too much paper in the tray. Remove excess paper from the tray.• The paper is too thick. Use only paper that meets the specifications required by the machine.
The paper keeps jamming.	<ul style="list-style-type: none">• There is too much paper in the tray. Remove excess paper from the tray. If you are printing on special materials, feed manually in the tray.• An incorrect type of paper is being used. Use only paper that meets the specifications required by the machine.• There may be debris inside the machine. Open the top cover and remove any debris.

Power and cable connecting problems

Condition	Suggested solutions
The machine is not receiving power, or the connection cable between the computer and the machine is not connected properly.	<ul style="list-style-type: none">• Connect the machine to the electricity supply first and press the  (Power/Wakeup) button on the control panel.• Disconnect the machine's cable and reconnect it.

Printing problems

Condition	Possible cause	Suggested solutions
The machine does not print.	The machine is not receiving power.	Check the power cord connections. Check the power switch and the power source.
	The machine is not selected as the default machine.	Select your machine as your default machine in Windows.
	Check the machine for the following: <ul style="list-style-type: none">• The top cover is not closed. Close the top cover.• Paper is jammed. Clear the paper jam (see "Clearing paper jams" on page 58).• No paper is loaded. Load paper (see "Loading paper in the tray" on page 27).• The toner cartridge is not installed. Install the toner cartridge (see "Replacing the toner cartridge" on page 47).• Make sure the protect cover and sheets are removed from the toner cartridge (see "Replacing the toner cartridge" on page 47). If a system error occurs, contact your service representative.	
	The connection cable between the computer and the machine is not connected properly.	Disconnect the machine cable and reconnect it (see "Rear view" on page 19).
	The connection cable between the computer and the machine is defective.	If possible, attach the cable to another computer that is working properly and print a job. You can also try using a different machine cable.
	The port setting is incorrect.	Check the Windows printer settings to make sure that the print job is sent to the correct port. If the computer has more than one port, make sure that the machine is attached to the correct one.
	The machine may be configured incorrectly.	Check the Printing Preferences to ensure that all of the print settings are correct.

Printing problems

Condition	Possible cause	Suggested solutions
The machine does not print.	The printer driver may be incorrectly installed.	Uninstall and reinstall the machine's driver.
	The machine is malfunctioning.	Check the display message on the control panel to see if the machine is indicating a system error. Contact a service representative.
	The document size is so big that the hard disk space of the computer is insufficient to access the print job.	Get more hard disk space and print the document again.
	The output tray is full.	Once the paper is removed from the output tray, the machine resumes printing.
The machine selects print materials from the wrong paper source.	The paper option that was selected in the Printing Preferences may be incorrect.	For many software applications, the paper source selection is found under the Paper tab within the Printing Preferences (see "Opening printing preferences" on page 34). Select the correct paper source. See the printer driver help screen (see "Using help" on page 36).
A print job is extremely slow.	The job may be very complex.	Reduce the complexity of the page or try adjusting the print quality settings.
Half the page is blank.	The page orientation setting may be incorrect.	Change the page orientation in your application (see "Opening printing preferences" on page 34). See the printer driver help screen (see "Using help" on page 36).
	The paper size and the paper size settings do not match.	Ensure that the paper size in the printer driver settings matches the paper in the tray. Or, ensure that the paper size in the printer driver settings matches the paper selection in the software application settings you use (see "Opening printing preferences" on page 34).

Printing problems

Condition	Possible cause	Suggested solutions
The machine prints, but the text is wrong, garbled, or incomplete.	The machine cable is loose or defective.	Disconnect the machine cable and reconnect. Try a print job that you have already printed successfully. If possible, attach the cable and the machine to another computer that you know works and try a print job. Finally, try a new machine cable.
	The wrong printer driver was selected.	Check the application's printer selection menu to ensure that your machine is selected.
	The software application is malfunctioning.	Try printing a job from another application.
	The operating system is malfunctioning.	Exit Windows and reboot the computer. Turn the machine off and back on again.
Pages print, but they are blank.	The toner cartridge is defective or out of toner.	Redistribute the toner, if necessary. If necessary, replace the toner cartridge. <ul style="list-style-type: none">• See "Redistributing toner" on page 45.• See "Replacing the toner cartridge" on page 47.
	The file may have blank pages.	Check the file to ensure that it does not contain blank pages.
	Some parts, such as the controller or the board, may be defective.	Contact a service representative.
The machine does not print PDF files correctly. Some parts of graphics, text, or illustrations are missing.	Incompatibility between the PDF file and the Acrobat products.	Printing the PDF file as an image may enable the file to print. Turn on Print As Image from the Acrobat printing options.  It will take longer to print when you print a PDF file as an image.
The print quality of photos is not good. Images are not clear.	The resolution of the photo is very low.	Reduce the photo size. If you increase the photo size in the software application, the resolution will be reduced.

Printing problems

Condition	Possible cause	Suggested solutions
Before printing, the machine emits vapor near the output tray.	Using damp paper can cause vapor during printing.	This is not a problem. Just keep printing.
The machine does not print special-sized paper, such as billing paper.	Paper size and paper size setting do not match.	Set the correct paper size in the Custom in Paper tab in Printing Preferences (see "Opening printing preferences" on page 34).
The printed billing paper is curled.	The paper type setting does not match.	Change the printer option and try again. Go to Printing Preferences , click Paper tab, and set type to Thick (see "Opening printing preferences" on page 34).

Printing quality problems

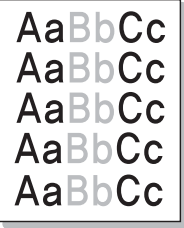
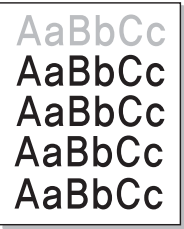

If the inside of the machine is dirty or paper has been loaded improperly, there might be a reduction in print quality. See the table below to clear the problem.

Condition	Suggested Solutions
<p data-bbox="51 357 322 389">Light or faded print</p> 	<ul data-bbox="506 357 2186 847" style="list-style-type: none">• If a vertical white streak or faded area appears on the page, the toner supply is low. Install a new toner cartridge (see "Replacing the toner cartridge" on page 47).• If a vertical white streak or faded area still appears on the page even though the machine has enough toner supply, open and close the front door 3 ~ 4 times (see "Machine overview" on page 17).• The paper may not meet paper specifications; for example, the paper may be too moist or rough.• If the entire page is light, the print resolution setting is too low or the toner save mode is on. Adjust the print resolution and turn the toner save mode off. See the help screen of the printer driver.• A combination of faded or smeared defects may indicate that the toner cartridge needs cleaning. Clean the inside of your machine (see "Cleaning the machine" on page 53).• The surface of the LSU part inside the machine may be dirty. Clean the inside of your machine (see "Cleaning the machine" on page 53). If these steps do not correct the problem, contact a service representative.
<p data-bbox="51 879 472 991">The top half of the paper is printed lighter than the rest of the paper</p> 	<p data-bbox="506 879 1249 911">The toner might not adhere properly to this type of paper.</p> <ul data-bbox="506 935 2186 1007" style="list-style-type: none">• Change the printer option and try again. Go to Printing Preferences, click the Paper tab, and set the paper type to Recycled (see "Opening printing preferences" on page 34).

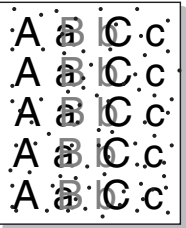
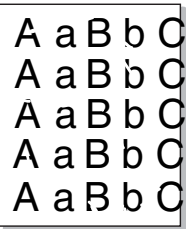
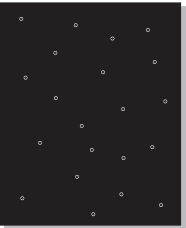
Printing quality problems

Condition	Suggested Solutions
<p>Toner specks</p> 	<ul style="list-style-type: none">• The paper may not meet specifications; for example, the paper may be too moist or rough.• The transfer roller may be dirty. Clean the inside of your machine (see "Cleaning the machine" on page 53).• The paper path may need cleaning. Contact a service representative (see "Cleaning the machine" on page 53).
<p>Dropouts</p> 	<p>If faded areas, generally rounded, occur randomly on the page:</p> <ul style="list-style-type: none">• A single sheet of paper may be defective. Try reprinting the job.• The moisture content of the paper is uneven or the paper has moist spots on its surface. Try a different brand of paper.• The paper lot is bad. The manufacturing processes can cause some areas to reject toner. Try a different kind or brand of paper.• Change the printer option and try again. Go to Printing Preferences, click the Paper tab, and set type to Thick or Thicker (see "Opening printing preferences" on page 34). <p>If these steps do not correct the problem, contact a service representative.</p>
<p>White Spots</p> 	<p>If white spots appear on the page:</p> <ul style="list-style-type: none">• The paper is too rough and a lot of dirt from paper falls to the inner components within the machine, so the transfer roller may be dirty. Clean the inside of your machine (see "Cleaning the machine" on page 53).• The paper path may need cleaning. Clean the inside of your machine (see "Cleaning the machine" on page 53). <p>If these steps do not correct the problem, contact a service representative.</p>

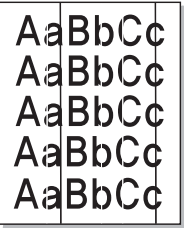
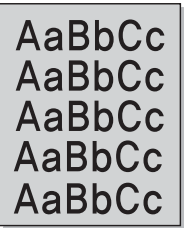
Printing quality problems

Condition	Suggested Solutions
<p>Vertical lines</p> 	<p>If black vertical streaks appear on the page:</p> <ul style="list-style-type: none">• The surface (drum part) of the imaging unit inside the machine has probably been scratched. Remove the toner cartridge and install a new one (see "Replacing the imaging unit" on page 51). <p>If white vertical streaks appear on the page:</p> <ul style="list-style-type: none">• The surface of the LSU part inside the machine may be dirty. Clean the inside of your machine (see "Cleaning the machine" on page 53). If these steps do not correct the problem, contact a service representative.
<p>Black background</p> 	<p>If the amount of background shading becomes unacceptable:</p> <ul style="list-style-type: none">• Change to a lighter weight paper.• Check the environmental conditions: very dry conditions or a high level of humidity (higher than 80% RH) can increase the amount of background shading.• Remove the old imaging unit and install a new one (see "Replacing the imaging unit" on page 51).• Thoroughly redistribute the toner (see "Redistributing toner" on page 45).
<p>Toner smear</p> 	<ul style="list-style-type: none">• Clean the inside of the machine (see "Replacing the toner cartridge" on page 47).• Check the paper type and quality.• Remove the old imaging unit and install a new one (see "Replacing the imaging unit" on page 51).

Printing quality problems

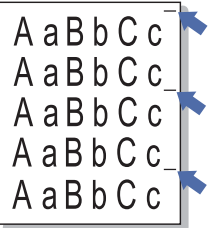
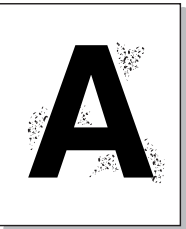
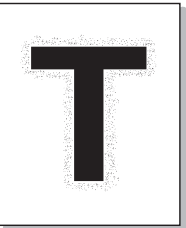
Condition	Suggested Solutions
<p data-bbox="49 272 405 304">Vertical repetitive defects</p> 	<p data-bbox="504 272 1473 304">If marks repeatedly appear on the printed side of the page at even intervals:</p> <ul data-bbox="504 328 2190 544" style="list-style-type: none"><li data-bbox="504 328 2190 400">• The imaging unit may be damaged. If you still have the same problem, remove the imaging unit and, install a new one (see "Replacing the imaging unit" on page 51).<li data-bbox="504 416 2190 488">• Parts of the machine may have toner on them. If the defects occur on the back of the page, the problem will likely correct itself after a few more pages.<li data-bbox="504 504 1464 544">• The fusing assembly may be damaged. Contact a service representative.
<p data-bbox="49 612 322 644">Background scatter</p> 	<p data-bbox="504 612 1621 644">Background scatter results from bits of toner randomly distributed on the printed page.</p> <ul data-bbox="504 668 2190 927" style="list-style-type: none"><li data-bbox="504 668 2190 740">• The paper may be too damp. Try printing with a different batch of paper. Do not open packages of paper until necessary so that the paper does not absorb too much moisture.<li data-bbox="504 756 2190 876">• If background scatter covers the entire surface area of a printed page, adjust the print resolution through your software application or in Printing Preferences (see "Opening printing preferences" on page 34). Ensure the correct paper type is selected. For example: If Thicker Paper is selected, but Plain Paper actually used, an overcharging can occur causing this copy quality problem.<li data-bbox="504 892 1868 927">• If you are using a new toner cartridge, redistribute the toner first (see "Redistributing toner" on page 45).
<p data-bbox="49 959 479 1031">Toner particles are around bold characters or pictures</p> 	<p data-bbox="504 959 1249 991">The toner might not adhere properly to this type of paper.</p> <ul data-bbox="504 1015 2190 1174" style="list-style-type: none"><li data-bbox="504 1015 2190 1086">• Change the printer option and try again. Go to Printing Preferences, click the Paper tab, and set the paper type to Recycled (see "Opening printing preferences" on page 34).<li data-bbox="504 1102 2190 1174">• Ensure the correct paper type is selected. For example: If Thicker Paper is selected, but Plain Paper actually used, an overcharging can occur causing this copy quality problem.

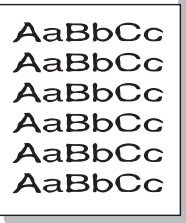
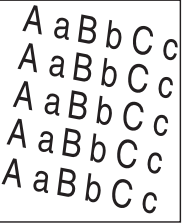
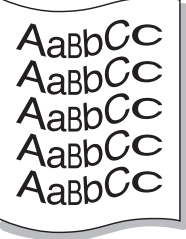

Printing quality problems

Condition	Suggested Solutions
<p data-bbox="49 272 353 304">Misformed characters</p> 	<ul data-bbox="504 272 2072 304" style="list-style-type: none">• If characters are improperly formed and producing hollow images, the paper stock may be too slick. Try different paper.
<p data-bbox="49 608 203 639">Page skew</p> 	<ul data-bbox="504 608 1518 743" style="list-style-type: none">• Ensure that the paper is loaded properly.• Check the paper type and quality.• Ensure that the guides are not too tight or too loose against the paper stack.
<p data-bbox="49 951 226 983">Curl or wave</p> 	<ul data-bbox="504 951 1729 1086" style="list-style-type: none">• Ensure that the paper is loaded properly.• Check the paper type and quality. Both high temperature and humidity can cause paper curl.• Turn the stack of paper over in the tray. Also try rotating the paper 180° in the tray.

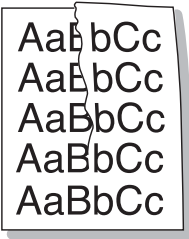
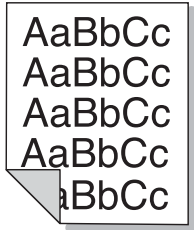
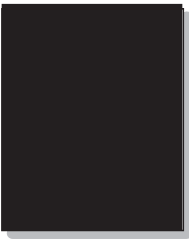
Printing quality problems

Condition	Suggested Solutions
<p data-bbox="49 272 318 304">Wrinkles or creases</p> 	<ul data-bbox="504 272 1601 411" style="list-style-type: none">• Ensure that the paper is loaded properly.• Check the paper type and quality.• Turn the stack of paper over in the tray. Also try rotating the paper 180° in the tray.
<p data-bbox="49 619 414 651">Back of printouts are dirty</p> 	<ul data-bbox="504 619 1787 651" style="list-style-type: none">• Check for leaking toner. Clean the inside of the machine (see "Cleaning the machine" on page 53).
<p data-bbox="49 986 407 1018">Solid color or black pages</p> 	<ul data-bbox="504 986 2197 1125" style="list-style-type: none">• The imaging unit may not be installed properly. Remove the imaging unit and reinsert it.• The imaging unit may be defective. Remove the imaging unit and install a new one (see "Replacing the imaging unit" on page 51).• The machine may require repairing. Contact a service representative.

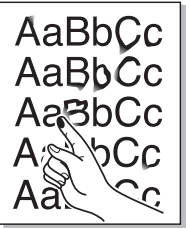
Printing quality problems

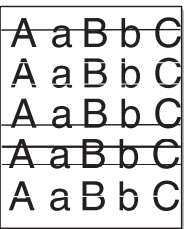
Condition	Suggested Solutions
<p>Loose toner</p> 	<ul style="list-style-type: none">• Clean the inside of the machine (see "Cleaning the machine" on page 53).• Check the paper type and quality.• Remove the imaging unit and then, install a new one (see "Replacing the imaging unit" on page 51). <p>If the problem persists, the machine may require repair. Contact a service representative.</p>
<p>Character voids</p> 	<p>Character voids are white areas within parts of characters that should be solid black:</p> <ul style="list-style-type: none">• You may be printing on the wrong surface of the paper. Remove the paper and turn it around.• The paper may not meet paper specifications.
<p>Horizontal stripes</p> 	<p>If horizontally aligned black streaks or smears appear:</p> <ul style="list-style-type: none">• The imaging unit may be installed improperly. Remove the imaging unit and reinsert it.• The imaging unit may be defective. Remove the imaging unit and install a new one (see "Replacing the imaging unit" on page 51). <p>If the problem persists, the machine may require repairing. Contact a service representative.</p>

Printing quality problems

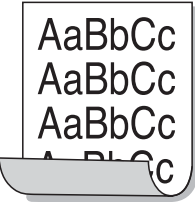
Condition	Suggested Solutions
<p>Curl</p> 	<p>If the printed paper is curled or paper does not feed into the machine:</p> <ul style="list-style-type: none">• Turn the stack of paper over in the tray. Also try rotating the paper 180° in the tray.• Change the printer's paper option and try again. Go to Printing Preferences, click the Paper tab, and set type to Thin (see "Opening printing preferences" on page 34).
<ul style="list-style-type: none">• An unknown image repetitively appears on a few sheets• Loose toner• Light print or contamination occurs	<p>Your machine is probably being used at an altitude of 1,000 m (3,281 ft) or above.</p> <p>The high altitude may affect the print quality, such as loose toner or light imaging. Change the altitude setting for your machine (See "Altitude adjustment" on page 145).</p>

Operating system problems

Common Windows problems

Condition	Suggested solutions
“File in Use” message appears during installation.	Exit all software applications. Remove all software from the startup group, then restart Windows. Reinstall the printer driver.
“General Protection Fault”, “Exception OE”, “Spool 32”, or “Illegal Operation” messages appear.	Close all other applications, reboot Windows and try printing again.
“Fail To Print”, “A printer timeout error occurred” message appear.	These messages may appear during printing. Just keep waiting until the machine finishes printing. If the message appears in ready mode or after printing has completed, check the connection and/or whether an error has occurred.



Refer to the Microsoft Windows User's Guide that came with your computer for further information on Windows error messages.

Operating system problems

Common Mac problems

Condition	Suggested solutions
The machine does not print PDF files correctly. Some parts of graphics, text, or illustrations are missing.	<p>Printing the PDF file as an image may enable the file to print. Turn on Print As Image from the Acrobat printing options.</p> <p> It will take longer to print when you print a PDF file as an image.</p>
Some letters are not displayed normally during cover page printing.	<p>Mac OS cannot create the font while printing the cover page. The English alphabet and numbers are displayed normally on the cover page.</p>
When printing a document in Mac with Acrobat Reader 6.0 or higher, colors print incorrectly.	<p>Make sure that the resolution setting in your machine driver matches the one in Acrobat Reader.</p>



Refer to the Mac User's Guide that came with your computer for further information on Mac error messages.

Operating system problems

Common Linux problems

Condition	Suggested solutions
The machine does not print.	<ul style="list-style-type: none">• Check if the printer driver is installed in your system. Open Unified Driver Configurator and switch to the Printers tab in Printers configuration window to look at the list of available machines. Make sure that your machine is displayed on the list. If not, open Add new printer wizard to set up your device.• Check if the machine is started. Open Printers configuration and select your machine on the printers list. Look at the description in the Selected printer pane. If its status contains Stopped string, press the Start button. After that normal operation of the machine should be restored. The “stopped” status might be activated when some problems in printing occur.• Check if your application has special print option such as “-oraw”. If “-oraw” is specified in the command line parameter, then remove it to print properly. For Gimp front-end, select “print” -> “Setup printer” and edit command line parameter in the command item.
Some color images come out all black.	This is a known bug in Ghostscript (until GNU Ghostscript version 7.05) when the base color space of the document is indexed color space and it is converted through CIE color space. Because Postscript uses CIE color space for Color Matching System, you should upgrade Ghostscript on your system to at least GNU Ghostscript version 7.06 or later. You can find recent Ghostscript versions at www.ghostscript.com .
Some color images come out in unexpected color.	This is a known bug in Ghostscript (until GNU Ghostscript version 7.xx) when the base color space of the document is indexed RGB color space and it is converted through CIE color space. Because Postscript uses CIE color space for Color Matching System, you should upgrade Ghostscript on your system to at least GNU Ghostscript version 8.xx or later. You can find recent Ghostscript versions at www.ghostscript.com .
The machine does not print whole pages, and output is printed on half the page.	It is a known problem that occurs when a color machine is used on version 8.51 or earlier of Ghostscript, 64-bit Linux OS, and has been reported to bugs.ghostscript.com as Ghostscript Bug 688252. The problem is solved in AFPL Ghostscript v. 8.52 or above. Download the latest version of AFPL Ghostscript from http://sourceforge.net/projects/ghostscript/ and install it to solve this problem.

Operating system problems

Condition	Suggested solutions
“Cannot open port device file” error message appears when printing a document.	Avoid changing print job parameters (via LPR GUI, for example) while a print job is in progress. Known versions of CUPS server break the print job whenever print options are changed and then try to restart the job from the beginning. Since Unified Linux Driver locks the mfp port while printing, the abrupt termination of the driver keeps the port locked and unavailable for subsequent print jobs. If this situation occurs, try to release the mfp port by selecting Release port in Port configuration window.



Refer to the Linux User’s Guide that came with your computer for further information on Linux error messages.



Quick Guide for Windows 8 User

This chapter will outline features specific to the Windows 8 OS. This chapter applies to users running Windows 8.

- **Understanding the screen** 195
- **System requirements** 196
- **Installing the driver locally** 197
- **Installing the driver over the network** 199
- **Installing the driver over the wireless network** 201
- **Uninstalling the driver** 203
- **Using Samsung Printer Experience** 204
- **Accessing management tools** 210
- **Installing accessories** 211
- **Troubleshooting** 212



- The screen may appear somewhat different depending on the model or interface in use.
- Since this guide has been prepared based on Windows 8, some of the instructions may differ depending on the version. It may also be modified without prior notice.

Understanding the screen

Windows 8 provides both the new **Start** screen mode and the **Desktop** screen mode of the existing OS.

Start Screen



Desktop Screen



System requirements

Operating system	Requirement (recommended)		
	CPU	RAM	Free HDD Space
Windows® 8	Intel® Pentium® IV 1 GHz 32-bit or 64-bit processor or higher	1 GB (2 GB)	16 GB
	<ul style="list-style-type: none">• Support for DirectX® 9 graphics with 128 MB memory (to enable the Aero theme).• DVD-R/W Drive		

Installing the driver locally

A locally connected machine is a machine directly attached to your computer using the cable.



- Only use a USB cable no longer than 3 meters (118 inches).
- **Samsung Printer Experience** app can only be used in the **Start** screen when V4 driver is installed. The V4 driver is automatically downloaded from the Windows Update if your computer is connected to the Internet. If not, you can manually download the V4 driver from Samsung website, www.samsung.com > find your product > Support or downloads.
- If you install the driver using the supplied software CD, V4 driver is not installed. If you want to use the V4 driver in the **Desktop** screen, you can download from the Samsung website, www.samsung.com > find your product > Support or downloads.

From the Start Screen

- 1 Make sure that your computer is connected to the Internet and powered on.
- 2 Make sure that the machine is powered on.
- 3 Connect the computer and the machine with a USB cable.
The driver is automatically installed from the **Windows Update**.



- If you want to install Samsung's printer management tools, you need to install them using the supplied software CD (see "From the Desktop Screen" on page 197).
- You can download Samsung Printer Experience app from the **Windows Store**. You need have a Microsoft account to use the Windows **Store**.
 - 1 From **Charms**, select **Search**.
 - 2 Click **Store**.
 - 3 Search and click **Samsung Printer Experience**.
 - 4 Click **Install**.

From the Desktop Screen



- If you install the driver using the supplied software CD, you cannot use the installed driver from the **Start** screen.

Installing the driver locally

- 1 Insert the supplied software CD into your CD-ROM drive.
If the installation window does not appear, from **Charms**, select **Search** > **Apps** and search for **Run**. Type in X:\Setup.exe, replacing "X" with the letter that represents your CD-ROM drive and click **OK**.



If "**Tap to choose what happens with this disc.**" pop-up window appears, click the window and select **Run Setup.exe**.

- 2 Review and accept the installation agreements in the installation window. Then, click **Next**.
- 3 Select **USB connection** on the **Printer Connection Type** screen. Then, click **Next**.
- 4 Follow the instructions in the installation window.

Installing the driver over the network



- Some features and optional goods may not be available depending on model or country (see "Features by models" on page 6).
- Machine that do not support networking will not be able to use this feature (see "Rear view" on page 19).
- **Samsung Printer Experience** app can only be used in the **Start** screen when V4 driver is installed. The V4 driver is automatically downloaded from the Windows Update if your computer is connected to the Internet. If not, you can manually download the V4 driver from Samsung website, www.samsung.com >find your product > Support or downloads.
- If you install the driver using the supplied software CD, V4 driver is not installed. If you want to use the V4 driver in the **Desktop** screen, you can download from the Samsung website, www.samsung.com >find your product > Support or downloads.



- You can print a Network Configuration Report from the machine's control panel that will show the current machine's host name (see "Printing a network configuration report" on page 130).
- If you want to install Samsung's printer management tools, you need to install them using the supplied software CD (see "From the Desktop Screen" on page 197).
- You can download Samsung Printer Experience app from the **Windows Store**. You need have a Microsoft account to use the Windows **Store**.
 - 1 From **Charms**, select **Search**.
 - 2 Click **Store**.
 - 3 Search and click **Samsung Printer Experience**.
 - 4 Click **Install**.

5 The driver is automatically installed from the **Windows Update**.

From the Start Screen

- 1 Make sure that the machine is connected to the network and powered on. Also, your machine's IP address should have been set (see "Setting IP address" on page 96).
- 2 From **Charms**, select **Settings** > **Change PC settings** > **Devices**.
- 3 Click **Add a device**.
Discovered machines will be shown on the screen.
- 4 Click the model name or host name you wish to use.

From the Desktop Screen



If you install the driver using the supplied software CD, you cannot use the installed driver from the **Start** screen.

Installing the driver over the network

- 1 Make sure that the machine is connected to the network and powered on. Also, your machine's IP address should have been set (see "Setting IP address" on page 96).
- 2 Insert the supplied software CD into your CD-ROM drive.
If the installation window does not appear, from **Charms**, select **Search** > **Apps** and search for **Run**. Type in X:\Setup.exe, replacing "X" with the letter that represents your CD-ROM drive and click **OK**.



If "**Tap to choose what happens with this disc.**" pop-up window appears, click the window and select **Run Setup.exe**.

- 3 Review and accept the installation agreements in the installation window. Then, click **Next**.
- 4 Select **Network connection** on the **Printer Connection Type** screen.
- 5 Follow the instructions in the installation window.

Installing the driver over the wireless network



- **Samsung Printer Experience** app can only be used in the **Start** screen when V4 driver is installed. The V4 driver is automatically downloaded from the Windows Update if your computer is connected to the Internet. If not, you can manually download the V4 driver from Samsung website, www.samsung.com >find your product > Support or downloads.
- If you install the driver using the supplied software CD, V4 driver is not installed. If you want to use the V4 driver in the **Desktop** screen, you can download from the Samsung website, www.samsung.com >find your product > Support or downloads.
- You must set up for wireless network using the supplied software CD in Desktop screen mode.
- If you are using a computer without a CD-ROM, you can set up the wireless network from the machine's control panel (see "Wireless network setup" on page 107).

From the Start Screen

- 1 After completing the wireless network connection, you need to install a machine driver to print from an application.
- 2 From **Charms**, select **Settings** > **Change PC settings** > **Devices**.
- 3 Click **Add a device**.
Discovered machines will be shown on the screen.
- 4 Click the model name or host name you wish to use.



You can print a Network Configuration Report from the machine's control panel that will show the current machine's host name (see "Printing a network configuration report" on page 130).

5 The driver is automatically installed from the **Windows Update**.



- If you want to install Samsung's printer management tools, you need to install them using the supplied software CD (see "From the Desktop Screen" on page 197).
- You can download Samsung Printer Experience app from the **Windows Store**. You need have a Microsoft account to use the Windows **Store**.
 - 1 From **Charms**, select **Search**.
 - 2 Click **Store**.
 - 3 Search and click **Samsung Printer Experience**.
 - 4 Click **Install**.

From the Desktop Screen



If you install the driver using the supplied software CD, you cannot use the installed driver from the **Start** screen.

Installing the driver over the wireless network

1 Turn on your computer, access point, and machine.

2 Insert the supplied software CD into your CD-ROM drive.

If the installation window does not appear, from **Charms**, select **Search** > **Apps** and search for **Run**. Type in X:\Setup.exe, replacing "X" with the letter that represents your CD-ROM drive and click **OK**.



If "**Tap to choose what happens with this disc.**" pop-up window appears, click the window and select **Run Setup.exe**.

3 Review and accept the installation agreements in the installation window. Then, click **Next**.

4 Follow the instructions in the installation window.



For wireless set up or driver installation, refer to the wireless network setup chapter (see "Wireless network setup" on page 107).

Uninstalling the driver

From the Start Screen

- 1 Make sure that the machine is connected to your computer and powered on.
- 2 Click on the **Uninstall Samsung Printer Software** tile in the **Start** screen.
- 3 Follow the instructions in the window.



- If you cannot find a Samsung Printer Software tile, uninstall from the desktop screen mode (see "From the Desktop Screen" on page 203).
- If you want to uninstall Samsung's printer management tools, from the **Start** screen, right-click the app > **Uninstall** > right-click the program you want to delete > **Uninstall** and follow the instruction in the window.

From the Desktop Screen

- 1 From Charms, select **Search** > **Apps**.
- 2 Search and click **Control Panel**.
- 3 Click **Programs and Features**.
- 4 Right-click the driver you want to uninstall and select **Uninstall**.

- 5 Follow the instructions in the window.

Using Samsung Printer Experience

Samsung Printer Experience is a Samsung application that combines Samsung machine settings and machine management into one location. You can set device settings, order supplies, open troubleshooting guides, visit Samsung's web site, and check connected machine information. This application will be automatically downloaded from the Windows **Store** if the machine is connected to a computer with an Internet connection.

Understanding the Samsung Printer Experience

To open the application,

From the **Start** screen, select the **Samsung Printer Experience** () tile.

The **Samsung Printer Experience** interface comprises various useful features as described in the following table:



The screenshot may differ depending on the model you are using.

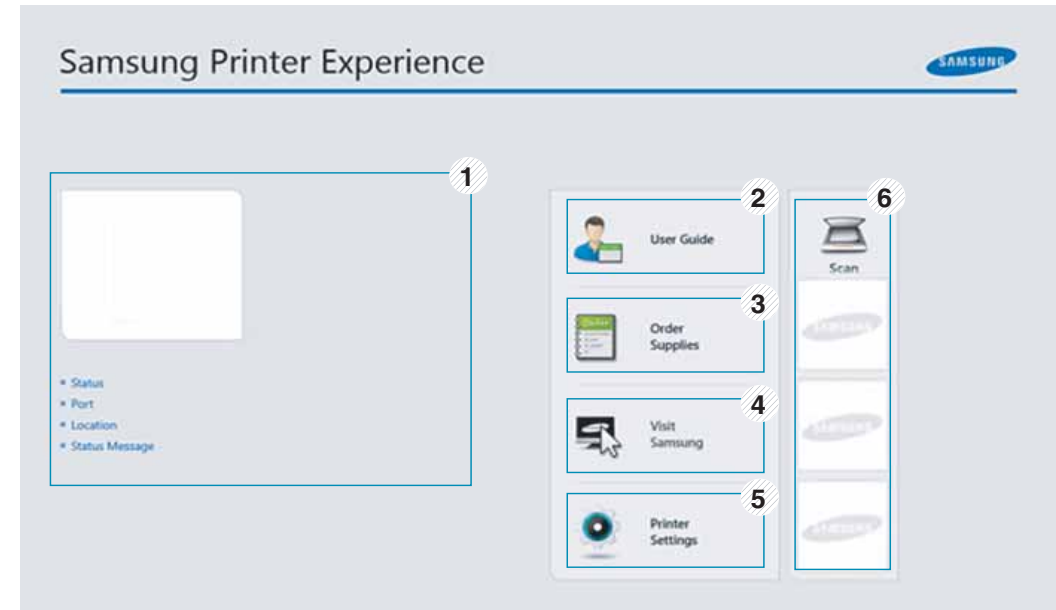

1	Printer Information	This area gives you general information about your machine. You can check information, such as the machine's status, location, IP address, and remaining toner level.
---	----------------------------	---

Using Samsung Printer Experience

2	User Guide	You can view the online User's Guide. You need to be connected to the Internet to use this feature.  This button opens the Troubleshooting Guide when an error occurs. You can directly open the troubleshooting section in the user's guide.
3	Order Supplies	Click on this button to order replacement toner cartridges online. You need to be connected to the Internet to use this feature.
4	Visit Samsung	Links to Samsung printer website. You need to be connected to the Internet to use this feature.
5	Printer Settings	You can configure various machine settings such as machine setup, paper, layout, emulation, networking, and print information through SyncThru™ Web Service . Your machine needs to be connected to a network. This button will be disabled if your machine is connected via USB cable.
6	Device List & Latest Scanned Image	The scan list displays devices that supports Samsung Printer Experience . Under the device, you can see the latest scanned images. Your machine needs to be connected to a network to scan from here. This section is for the users with multi-functional printers.

Adding/Deleting Printers

If you do not have any printer added to the **Samsung Printer Experience**, or if you want to add/delete a printer, follow the instructions below.



You can only add/delete network connected printers.

Adding a printer

- 1 From the **Charms**, select **Settings**.
Or, right-click the **Samsung Printer Experience** page and select **Settings**.
- 2 Select **Add Printer**
- 3 Select the printer you want to add.
You can see the added printer.



If you see  mark, you can also click  mark to add printers.

Using Samsung Printer Experience

Deleting a printer

- 1 From the **Charms**, select **Settings**.
Or, right-click the **Samsung Printer Experience** page and select **Settings**.
- 2 Select **Remove Printer**
- 3 Select the printer you want to delete.
- 4 Click **Yes**.
You can see that the deleted printer is removed from the screen.

Printing from Windows 8

This section explains common printing tasks from the **Start** screen.

Basic printing

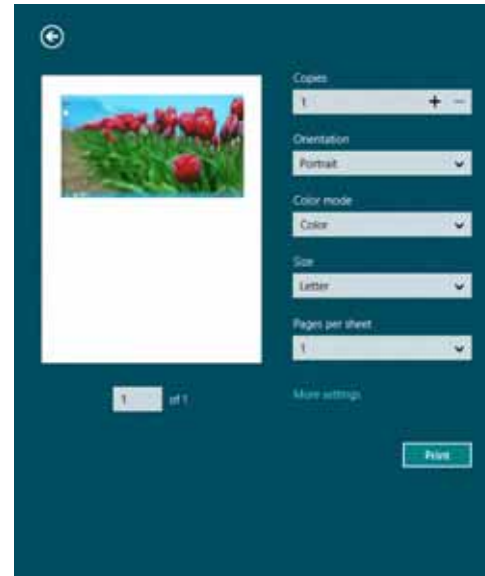

- 1 Open the document to print.
- 2 From the **Charms**, select **Devices**.
- 3 Select your printer from the list

- 4 Select the printer settings, such as the number of copies and orientation.
- 5 Click the **Print** button to start the print job.



Cancelling a print job

If the printing job is waiting in the print queue or print spooler, cancel the job as follows:

- You can access this window by simply double-clicking the machine icon () in the Windows task bar.
- You can also cancel the current job by pressing  (**Cancel** or **Stop/Clear**) button on the control panel.

Using Samsung Printer Experience

Opening more settings



The screen may appear somewhat different depending on the model or options.

You can set up more printing parameters.

- 1 Open the document you want to print.
- 2 From the **Charms**, select **Devices**.
- 3 Select your printer from the list
- 4 Click **More settings**.

Basic tab

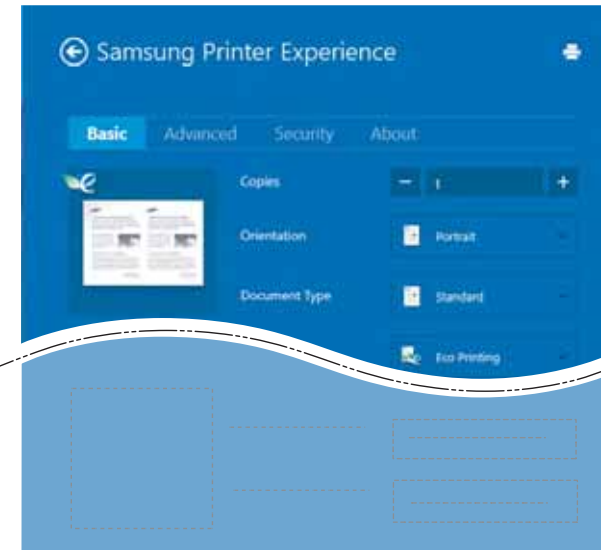

Basic

This option allows you to choose the basic printing settings such as copies, orientation, and document type.

Eco settings

This option allows you to choose multiple pages per side to save media.

Using Samsung Printer Experience

Advanced tab

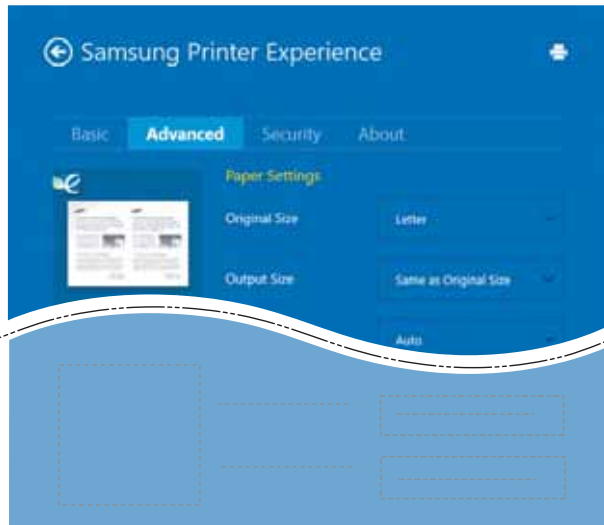

Paper settings

This option allows you to set the basic paper handling specifications.

Layout settings

This option allows you to set the various ways to layout your documents.

Security tab



Some features may not be available depending on the model or options. If this tab is not shown or disabled, it means that these features are not supported.

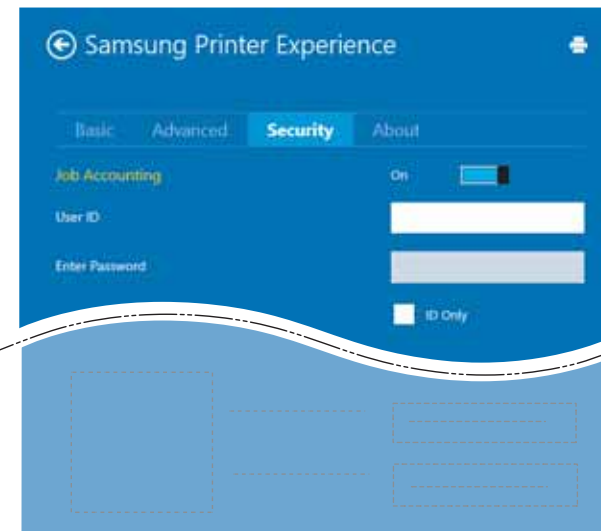

Job Accounting

This option allows you to print with the given permission.

Confidential Printing

This option is used for printing confidential documents. You need to enter a password to print using it.

Using Samsung Printer Experience

Using the sharing feature

Samsung Printer Experience allows you to print from other applications installed on the computer using the sharing feature.



This feature is only available for printing jpeg, bmp, tiff, gif, and png file formats.

- 1 Select the content you want to print from other application.
- 2 From the **Charms**, select **Share > Samsung Printer Experience**.
- 3 Select the printer settings, such as the number of copies and orientation.
- 4 Click the **Print** button to start the print job.

Scanning from Windows 8





This section is for the users with multi-functional printers.

Scanning with your machine lets you turn pictures and text into digital files that can be stored on your computer.

Scanning from Samsung Printer Experience

The most frequently used printing menus are displayed for quick scanning.

- 1 Place a single document face down on the document glass, or load the documents face up into the document feeder.
- 2 Click the **Samsung Printer Experience** tile on the **Start** screen.
- 3 Click **Scan** ().
- 4 Set up the scanning parameters such as image type, document size, and resolution.
- 5 Click **Prescan** () to check the image.
- 6 Adjust the prescanned image with scanning operation functions such as rotate and mirror.
- 7 Click **Scan** () and save the image.



- When you place the originals in the ADF (or DADF), **Prescan** () is not available.
- You can skip step 5, if the Prescan option is selected.

Accessing management tools

Samsung provides a variety of management tools for Samsung printers. For more information on each tool, refer to "Useful management tools" on page 159.

- 1 From the **Charms**, select **Search > Apps**.
- 2 Find **Samsung Printers**.
- 3 Under **Samsung Printers**, you can see installed management tools.
- 4 Click the management tool you want to use.



After installing the driver, for some management tools, you can access them directly from the **Start** screen by clicking on the corresponding tile.

Installing accessories

When you install optional devices, such as optional tray, memory, etc, this machine automatically detects and sets the optional devices. If you cannot use the optional devices you installed in this driver, you can set the optional devices in **Device Settings** to use.

- 1 From the **Charms**, select **Search > Settings**.
- 2 Search for **Devices and Printers**.
- 3 Right-click on your printer icon and select **Printer properties**.



If **Printer properties** item has a ► mark, you can select other printer drivers connected with the selected printer.

- 4 Select **Device Settings**.



The **Printer properties** window may differ depending on the driver or operating system you are using.

- 5 Select the appropriate option.
- 6 Click **OK** until you exit the **Printer properties** window.

Troubleshooting

Problem	Suggested Solutions
Samsung Printer Experience is not shown when you click more settings .	Samsung Printer Experience is not installed. Download the app. from the Windows Store and install it.
Machine information is not displayed when you click the device in the Devices and Printers .	Check the Printer properties . Click the Ports tab. (Control Panel > Devices and Printers > Right-click on your printer icon and select Printer properties) If the port is set to File or LPT, uncheck them and select TCP/IP, USB, or WSD.

Contact SAMSUNG worldwide

If you have any comments or questions regarding Samsung products, contact the Samsung customer care center.

Country/Region	Customer Care Center	WebSite
ANGOLA	91-726-7864	www.samsung.com
ARGENTINA	0800-333-3733	www.samsung.com
ARMENIA	0-800-05-555	www.samsung.com
AUSTRALIA	1300 362 603	www.samsung.com
AUSTRIA	0810-SAMSUNG (7267864, € 0.07/min)	www.samsung.com
AZERBAIJAN	088-55-55-555	www.samsung.com
BAHRAIN	8000-4726	www.samsung.com/ae (English) www.samsung.com/ae_ar (Arabic)
BELARUS	810-800-500-55-500	www.samsung.com
BELGIUM	02-201-24-18	www.samsung.com/be (Dutch) www.samsung.com/be_fr (French)
BOLIVIA	800-10-7260	www.samsung.com
BOSNIA	051 133 1999	www.samsung.com

Country/Region	Customer Care Center	WebSite
BOTSWANA	0800-726-000	www.samsung.com
BRAZIL	0800-124-421 4004-0000	www.samsung.com
BULGARIA	07001 33 11 , normal tariff	www.samsung.com
CAMEROON	7095- 0077	www.samsung.com
CANADA	1-800-SAMSUNG (726-7864)	www.samsung.com/ca (English) www.samsung.com/ca_fr (French)
CHILE	800-SAMSUNG (726-7864) From mobile 02-24 82 82 00	www.samsung.com/cl
CHINA	400-810-5858	www.samsung.com
COLOMBIA	01-8000112112 Bogotá: 6001272	www.samsung.com/co
COSTA RICA	0-800-507-7267	www.samsung.com/latin (Spanish) www.samsung.com/latin_en (English)
CROATIA	062 SAMSUNG (062 726 786)	www.samsung.com
Cote D' Ivoire	8000 0077	www.samsung.com

Contact SAMSUNG worldwide

Country/Region	Customer Care Center	WebSite
CYPRUS	8009 4000 only from landline (+30) 210 6897691 from mobile and land line	www.samsung.com
CZECH	800-SAMSUNG (800-726786)	www.samsung.com
DENMARK	70 70 19 70	www.samsung.com
DOMINICA	1-800-751-2676	www.samsung.com/ latin (Spanish) www.samsung.com/ latin_en (English)
ECUADOR	1-800-10-7267	www.samsung.com/ latin (Spanish) www.samsung.com/ latin_en (English)
EGYPT	08000-726786	www.samsung.com
EIRE	0818 717100	www.samsung.com
EL SALVADOR	800-6225	www.samsung.com/ latin (Spanish) www.samsung.com/ latin_en (English)
ESTONIA	800-7267	www.samsung.com/ee
FINLAND	030-6227 515	www.samsung.com

Country/Region	Customer Care Center	WebSite
FRANCE	01 48 63 00 00	www.samsung.com/fr
GERMANY	0180 5 SAMSUNG bzw. 0180 5 7267864* (*0,14 €/Min. aus dem dt. Festnetz, aus dem Mobilfunk max. 0,42 €/Min.)	www.samsung.com
GEORGIA	8-800-555-555	www.samsung.com
GHANA	0800-10077 0302-200077	www.samsung.com
GREECE	80111-SAMSUNG (80111 726 7864) only from land line (+30) 210 6897691 from mobile and land line	www.samsung.com
GUATEMALA	1-800-299-0013	www.samsung.com/ latin (Spanish) www.samsung.com/ latin_en (English)
HONDURAS	800-27919267	www.samsung.com/ latin (Spanish) www.samsung.com/ latin_en (English)

Contact SAMSUNG worldwide

Country/Region	Customer Care Center	WebSite
HONG KONG	(852) 3698-4698	www.samsung.com/hk (Chinese) www.samsung.com/ hk_en (English)
HUNGARY	06-80-SAMSUNG (726-7864)	www.samsung.com
INDIA	1800 3000 8282 1800 266 8282	www.samsung.com/in
INDONESIA	0800-112-8888 021-5699-7777	www.samsung.com/id
IRAN	021-8255	www.samsung.com
ITALIA	800-SAMSUNG (726-7864)	www.samsung.com
JAMAICA	1-800-234-7267	www.samsung.com
JAPAN	0120-327-527	www.samsung.com
JORDAN	800-22273 065777444	www.samsung.com/ Levant (English)
KAZAKHSTAN	8-10-800-500-55-500 (GSM:7799)	www.samsung.com
KENYA	0800 724 000	www.samsung.com

Country/Region	Customer Care Center	WebSite
KUWAIT	183-2255 (183-CALL)	www.samsung.com/ae (English) www.samsung.com/ ae_ar (Arabic)
KYRGYZSTAN	00-800-500-55-500	www.samsung.com
LATVIA	8000-7267	www.samsung.com/lv
LITHUANIA	8-800-77777	www.samsung.com/lt
LUXEMBURG	261 03 710	www.samsung.com
MALAYSIA	1800-88-9999	www.samsung.com/ my
MEXICO	01-800-SAMSUNG (726-7864)	www.samsung.com
MOLDOVA	0-800-614-40	www.samsung.com
MONGOLIA	+7-800-555-55-55	www.samsung.com
MONTENEGRO	020 405 888	www.samsung.com
MOROCCO	080 100 2255	www.samsung.com
NAMIBIA	8197267864	www.samsung.com
NIGERIA	0800-726-7864	www.samsung.com
NETHERLANDS	0900-SAMSUNG (0900-7267864) (€ 0,10/min)	www.samsung.com
NEW ZEALAND	0800 SAMSUNG (0800 726 786)	www.samsung.com

Contact SAMSUNG worldwide

Country/Region	Customer Care Center	WebSite
NICARAGUA	00-1800-5077267	www.samsung.com/ latin (Spanish) www.samsung.com/ latin_en (English)
NORWAY	815-56 480	www.samsung.com
OMAN	800-SAMSUNG (726-7864)	www.samsung.com/ae (English) www.samsung.com/ ae_ar (Arabic)
PANAMA	800-7267	www.samsung.com/ latin (Spanish) www.samsung.com/ latin_en (English)
PARAGUAY	98005210001	www.samsung.com
PERU	0-800-777-08 (Only from landline) 336-8686 (From HHP & landline)	www.samsung.com

Country/Region	Customer Care Center	WebSite
PHILIPPINES	1-800-10-SAMSUNG(726-7864) for PLDT 1-800-3-SAMSUNG(726-7864) for Digitel 1-800-8-SAMSUNG(726-7864) for Globe 02-5805777	www.samsung.com/ph
POLAND	0 801-1SAMSUNG(172-678) * lub +48 22 607-93-33 ** * (całkowity koszt połączenia jak za 1 impuls według taryfy operatora) ** (koszt połączenia według taryfy operatora)	www.samsung.com/pl
PORTUGAL	808 20-SAMSUNG (808 20 7267)	www.samsung.com
PUERTO RICO	1-800-682-3180	www.samsung.com
QATAR	800-2255 (800-CALL)	www.samsung.com/ae (English) www.samsung.com/ ae_ar (Arabic)
ROMANIA	08008 SAMSUNG (08008 726 7864) TOLL FREE No.	www.samsung.com

Contact SAMSUNG worldwide

Country/Region	Customer Care Center	WebSite
RUSSIA	800-00-0077	www.samsung.com
SAUDI ARABIA	9200-21230	www.samsung.com/sa (Arabic)
SENEGAL	8-800-555-55-55	www.samsung.com
SERBIA	+381 11 321 6899 (old number still active 0700 7267864)	www.samsung.com
SINGAPORE	1800-SAMSUNG (726-7864)	www.samsung.com
SLOVAKIA	0800 - SAMSUNG(0800-726 786)	www.samsung.com
SOUTH AFRICA	0860 SAMSUNG (726-7864)	www.samsung.com
SPAIN	902-1-SAMSUNG(902 172 678)	www.samsung.com
SWEDEN	0771 726 7864 (SAMSUNG)	www.samsung.com
SWITZERLAND	0848-SAMSUNG (7267864, CHF 0.08/min)	www.samsung.com/ch www.samsung.com/ ch_fr/
SYRIA	18252273	www.samsung.com/ Levant (English)
TADJIKISTAN	8-10-800-500-55-500	www.samsung.com
TAIWAN	0800-329-999 0266-026-066	www.samsung.com

Country/Region	Customer Care Center	WebSite
TANZANIA	0685 88 99 00	www.samsung.com
THAILAND	1800-29-3232 02-689-3232	www.samsung.com/th
TRINIDAD & TOBAGO	1-800-SAMSUNG (726-7864)	www.samsung.com
TURKEY	444 77 11	www.samsung.com
U.A.E	800-SAMSUNG (726-7864)	www.samsung.com
U.K	0330 SAMSUNG (726-7864)	www.samsung.com
U.S.A	1-800-SAMSUNG (726-7864)	www.samsung.com
UGANDA	0800 300 300	www.samsung.com
UKRAINE	0-800-502-000	www.samsung.com/ua (Ukrainian) www.samsung.com/ ua_ru (Russian)
URUGUAY	40543733	www.samsung.com
UZBEKISTAN	8-10-800-500-55-500	www.samsung.com
VENEZUELA	0-800-100-5303	www.samsung.com
VIETNAM	1 800 588 889	www.samsung.com
ZAMBIA	211350370	www.samsung.com



The following glossary helps you get familiar with the product by understanding the terminologies commonly used with printing as well as mentioned in this user's guide.

802.11

802.11 is a set of standards for wireless local area network (WLAN) communication, developed by the IEEE LAN/MAN Standards Committee (IEEE 802).

802.11b/g/n

802.11b/g/n can share same hardware and use the 2.4 GHz band. 802.11b supports bandwidth up to 11 Mbps, 802.11n supports bandwidth up to 150 Mbps. 802.11b/g/n devices may occasionally suffer interference from microwave ovens, cordless telephones, and Bluetooth devices.

Access point

Access Point or Wireless Access Point (AP or WAP) is a device that connects wireless communication devices together on wireless local area networks (WLAN), and acts as a central transmitter and receiver of WLAN radio signals.

ADF

An Automatic Document Feeder (ADF) is a scanning unit that will automatically feed an original sheet of paper so that the machine can scan some amount of the paper at once.

AppleTalk

AppleTalk is a proprietary suite of protocols developed by Apple, Inc for computer networking. It was included in the original Mac (1984) and is now deprecated by Apple in favor of TCP/IP networking.

BIT Depth

A computer graphics term describing the number of bits used to represent the color of a single pixel in a bitmapped image. Higher color depth gives a broader range of distinct colors. As the number of bits increases, the number of possible colors becomes impractically large for a color map. 1-bit color is commonly called as monochrome or black and white.

BMP

A bitmapped graphics format used internally by the Microsoft Windows graphics subsystem (GDI), and used commonly as a simple graphics file format on that platform.

BOOTP

Bootstrap Protocol. A network protocol used by a network client to obtain its IP address automatically. This is usually done in the bootstrap process of computers or operating systems running on them. The BOOTP servers assign the IP address from a pool of addresses to each client. BOOTP enables 'diskless workstation' computers to obtain an IP address prior to loading any advanced operating system.

CCD

Charge Coupled Device (CCD) is a hardware which enables the scan job. CCD Locking mechanism is also used to hold the CCD module to prevent any damage when you move the machine.

Collation

Collation is a process of printing a multiple-copy job in sets. When collation is selected, the device prints an entire set before printing additional copies.

Control Panel

A control panel is a flat, typically vertical, area where control or monitoring instruments are displayed. They are typically found in front of the machine.

Coverage

It is the printing term used for a toner usage measurement on printing. For example, 5% coverage means that an A4 sided paper has about 5% image or text on it. So, if the paper or original has complicated images or lots of text on it, the coverage will be higher and at the same time, a toner usage will be as much as the coverage.

CSV

Comma Separated Values (CSV). A type of file format, CSV is used to exchange data between disparate applications. The file format, as it is used in Microsoft Excel, has become a de facto standard throughout the industry, even among non-Microsoft platforms.

DADF

A Duplex Automatic Document Feeder (DADF) is a scanning unit that will automatically feed and turn over an original sheet of paper so that the machine can scan on both sides of the paper.

Default

The value or setting that is in effect when taking a printer out of its box state, reset, or initialized.

DHCP

A Dynamic Host Configuration Protocol (DHCP) is a client-server networking protocol. A DHCP server provides configuration parameters specific to the DHCP client host requesting, generally, information required by the client host to participate on an IP network. DHCP also provides a mechanism for allocation of IP addresses to client hosts.

DIMM

Dual Inline Memory Module (DIMM), a small circuit board that holds memory. DIMM stores all the data within the machine like printing data, received fax data.

DLNA

The Digital Living Network Alliance (DLNA) is a standard that allows devices on a home network to share information with each other across the network.

DNS

The Domain Name Server (DNS) is a system that stores information associated with domain names in a distributed database on networks, such as the Internet.

Dot Matrix Printer

A dot matrix printer refers to a type of computer printer with a print head that runs back and forth on the page and prints by impact, striking an ink-soaked cloth ribbon against the paper, much like a typewriter.

DPI

Dots Per Inch (DPI) is a measurement of resolution that is used for scanning and printing. Generally, higher DPI results in a higher resolution, more visible detail in the image, and a larger file size.

DRPD

Distinctive Ring Pattern Detection. Distinctive Ring is a telephone company service which enables a user to use a single telephone line to answer several different telephone numbers.

Duplex

A mechanism that will automatically turn over a sheet of paper so that the machine can print (or scan) on both sides of the paper. A printer equipped with a Duplex Unit can print on both sides of paper during one print cycle.

Duty Cycle

Duty cycle is the page quantity which does not affect printer performance for a month. Generally the printer has the lifespan limitation such as pages per year. The lifespan means the average capacity of print-outs, usually within the warranty period. For example, if the duty cycle is 48,000 pages per month assuming 20 working days, a printer limits 2,400 pages a day.

ECM

Error Correction Mode (ECM) is an optional transmission mode built into Class 1 fax machines or fax modems. It automatically detects and corrects errors in the fax transmission process that are sometimes caused by telephone line noise.

Emulation

Emulation is a technique of one machine obtaining the same results as another.

An emulator duplicates the functions of one system with a different system, so that the second system behaves like the first system. Emulation focuses on exact reproduction of external behavior, which is in contrast to simulation, which concerns an abstract model of the system being simulated, often considering its internal state.

Ethernet

Ethernet is a frame-based computer networking technology for local area networks (LANs). It defines wiring and signaling for the physical layer, and frame formats and protocols for the media access control (MAC)/data link layer of the OSI model. Ethernet is mostly standardized as IEEE 802.3. It has become the most widespread LAN technology in use during the 1990s to the present.

EtherTalk

A suite of protocols developed by Apple Computer for computer networking. It was included in the original Mac (1984) and is now deprecated by Apple in favor of TCP/IP networking.

FDI

Foreign Device Interface (FDI) is a card installed inside the machine to allow a third party device such as a coin operated device or a card reader. Those devices allow the pay-for-print service on your machine.

FTP

A File Transfer Protocol (FTP) is a commonly used protocol for exchanging files over any network that supports the TCP/IP protocol (such as the Internet or an intranet).

Fuser Unit

The part of a laser printer that fuses the toner onto the print media. It consists of a heat roller and a pressure roller. After toner is transferred onto the paper, the fuser unit applies heat and pressure to ensure that the toner stays on the paper permanently, which is why paper is warm when it comes out of a laser printer.

Gateway

A connection between computer networks, or between a computer network and a telephone line. It is very popular, as it is a computer or a network that allows access to another computer or network.

Grayscale

A shades of gray that represent light and dark portions of an image when color images are converted to grayscale; colors are represented by various shades of gray.

Halftone

An image type that simulates grayscale by varying the number of dots. Highly colored areas consist of a large number of dots, while lighter areas consist of a smaller number of dots.

HDD

Hard Disk Drive (HDD), commonly referred to as a hard drive or hard disk, is a non-volatile storage device which stores digitally-encoded data on rapidly rotating platters with magnetic surfaces.

IEEE

The Institute of Electrical and Electronics Engineers (IEEE) is an international non-profit, professional organization for the advancement of technology related to electricity.

IEEE 1284

The 1284 parallel port standard was developed by the Institute of Electrical and Electronics Engineers (IEEE). The term "1284-B" refers to a specific connector type on the end of the parallel cable that attaches to the peripheral (for example, a printer).

Intranet

A private network that uses Internet Protocols, network connectivity, and possibly the public telecommunication system to securely share part of an organization's information or operations with its employees. Sometimes the term refers only to the most visible service, the internal website.

IP address

An Internet Protocol (IP) address is a unique number that devices use in order to identify and communicate with each other on a network utilizing the Internet Protocol standard.

IPM

The Images Per Minute (IPM) is a way of measuring the speed of a printer. An IPM rate indicates the number of single-sided sheets a printer can complete within one minute.

IPP

The Internet Printing Protocol (IPP) defines a standard protocol for printing as well as managing print jobs, media size, resolution, and so forth. IPP can be used locally or over the Internet to hundreds of printers, and also supports access control, authentication, and encryption, making it a much more capable and secure printing solution than older ones.

IPX/SPX

IPX/SPX stands for Internet Packet Exchange/Sequenced Packet Exchange. It is a networking protocol used by the Novell NetWare operating systems. IPX and SPX both provide connection services similar to TCP/IP, with the IPX protocol having similarities to IP, and SPX having similarities to TCP. IPX/SPX was primarily designed for local area networks (LANs), and is a very efficient protocol for this purpose (typically its performance exceeds that of TCP/IP on a LAN).

ISO

The International Organization for Standardization (ISO) is an international standard-setting body composed of representatives from national standards bodies. It produces world-wide industrial and commercial standards.

ITU-T

The International Telecommunication Union is an international organization established to standardize and regulate international radio and telecommunications. Its main tasks include standardization, allocation of the radio spectrum, and organizing interconnection arrangements between different countries to allow international phone calls. A -T out of ITU-T indicates telecommunication.

ITU-T No. 1 chart

Standardized test chart published by ITU-T for document facsimile transmissions.

JBIG

Joint Bi-level Image Experts Group (JBIG) is an image compression standard with no loss of accuracy or quality, which was designed for compression of binary images, particularly for faxes, but can also be used on other images.

JPEG

Joint Photographic Experts Group (JPEG) is a most commonly used standard method of lossy compression for photographic images. It is the format used for storing and transmitting photographs on the World Wide Web.

LDAP

The Lightweight Directory Access Protocol (LDAP) is a networking protocol for querying and modifying directory services running over TCP/IP.

LED

A Light-Emitting Diode (LED) is a semiconductor device that indicates the status of a machine.

MAC address

Media Access Control (MAC) address is a unique identifier associated with a network adapter. MAC address is a unique 48-bit identifier usually written as 12 hexadecimal characters grouped in pairs (e. g., 00-00-0c-34-11-4e). This address is usually hard-coded into a Network Interface Card (NIC) by its manufacturer, and used as an aid for routers trying to locate machines on large networks.

MFP

Multi Function Peripheral (MFP) is an office machine that includes the following functionality in one physical body, so as to have a printer, a copier, a fax, a scanner and etc.

MH

Modified Huffman (MH) is a compression method for decreasing the amount of data that needs to be transmitted between the fax machines to transfer the image recommended by ITU-T T.4. MH is a codebook-based run-length encoding scheme optimized to efficiently compress white space. As most faxes consist mostly of white space, this minimizes the transmission time of most faxes.

MMR

Modified Modified READ (MMR) is a compression method recommended by ITU-T T.6.

Modem

A device that modulates a carrier signal to encode digital information, and also demodulates such a carrier signal to decode transmitted information.

MR

Modified Read (MR) is a compression method recommended by ITU-T T.4. MR encodes the first scanned line using MH. The next line is compared to the first, the differences determined, and then the differences are encoded and transmitted.

Glossary

NetWare

A network operating system developed by Novell, Inc. It initially used cooperative multitasking to run various services on a PC, and the network protocols were based on the archetypal Xerox XNS stack. Today NetWare supports TCP/IP as well as IPX/SPX.

OPC

Organic Photo Conductor (OPC) is a mechanism that makes a virtual image for print using a laser beam emitted from a laser printer, and it is usually green or rust colored and has a cylinder shape.

An imaging unit containing a drum slowly wears the drum surface by its usage in the printer, and it should be replaced appropriately since it gets worn from contact with the cartridge development brush, cleaning mechanism, and paper.

Originals

The first example of something, such as a document, photograph or text, etc, which is copied, reproduced or translated to produce others, but which is not itself copied or derived from something else.

OSI

Open Systems Interconnection (OSI) is a model developed by the International Organization for Standardization (ISO) for communications. OSI offers a standard, modular approach to network design that divides the required set of complex functions into manageable, self-contained, functional layers. The layers are, from top to bottom, Application, Presentation, Session, Transport, Network, Data Link and Physical.

PABX

A private automatic branch exchange (PABX) is an automatic telephone switching system within a private enterprise.

PCL

Printer Command Language (PCL) is a Page Description Language (PDL) developed by HP as a printer protocol and has become an industry standard. Originally developed for early inkjet printers, PCL has been released in varying levels for thermal, dot matrix printer, and laser printers.

PDF

Portable Document Format (PDF) is a proprietary file format developed by Adobe Systems for representing two dimensional documents in a device independent and resolution independent format.

PostScript

PostScript (PS) is a page description language and programming language used primarily in the electronic and desktop publishing areas. - that is run in an interpreter to generate an image.

Printer Driver

A program used to send commands and transfer data from the computer to the printer.

Print Media

The media like paper, envelopes, labels, and transparencies which can be used in a printer, a scanner, a fax or, a copier.

PPM

Pages Per Minute (PPM) is a method of measurement for determining how fast a printer works, meaning the number of pages a printer can produce in one minute.

PRN file

An interface for a device driver, this allows software to interact with the device driver using standard input/output system calls, which simplifies many tasks.

Protocol

A convention or standard that controls or enables the connection, communication, and data transfer between two computing endpoints.

PS

See PostScript.

PSTN

The Public-Switched Telephone Network (PSTN) is the network of the world's public circuit-switched telephone networks which, on industrial premises, is usually routed through the switchboard.

RADIUS

Remote Authentication Dial In User Service (RADIUS) is a protocol for remote user authentication and accounting. RADIUS enables centralized management of authentication data such as usernames and passwords using an AAA (authentication, authorization, and accounting) concept to manage network access.

Resolution

The sharpness of an image, measured in Dots Per Inch (DPI). The higher the dpi, the greater the resolution.

SMB

Server Message Block (SMB) is a network protocol mainly applied to share files, printers, serial ports, and miscellaneous communications between nodes on a network. It also provides an authenticated Inter-process communication mechanism.

SMTP

Simple Mail Transfer Protocol (SMTP) is the standard for e-mail transmissions across the Internet. SMTP is a relatively simple, text-based protocol, where one or more recipients of a message are specified, and then the message text is transferred. It is a client-server protocol, where the client transmits an email message to the server.

SSID

Service Set Identifier (SSID) is a name of a wireless local area network (WLAN). All wireless devices in a WLAN use the same SSID in order to communicate with each other. The SSIDs are case-sensitive and have a maximum length of 32 characters.

Subnet Mask

The subnet mask is used in conjunction with the network address to determine which part of the address is the network address and which part is the host address.

TCP/IP

The Transmission Control Protocol (TCP) and the Internet Protocol (IP); the set of communications protocols that implement the protocol stack on which the Internet and most commercial networks run.

TCR

Transmission Confirmation Report (TCR) provides details of each transmission such as job status, transmission result and number of pages sent. This report can be set to print after each job or only after failed transmissions.

TIFF

Tagged Image File Format (TIFF) is a variable-resolution bitmapped image format. TIFF describes image data that typically come from scanners. TIFF images make use of tags, keywords defining the characteristics of the image that is included in the file. This flexible and platform-independent format can be used for pictures that have been made by various image processing applications.

Toner Cartridge

A kind of bottle or container used in a machine like a printer which contains toner. Toner is a powder used in laser printers and photocopiers, which forms the text and images on the printed paper. Toner can be fused by a combination of heat/pressure from the fuser, causing it to bind to the fibers in the paper.

TWAIN

An industry standard for scanners and software. By using a TWAIN-compliant scanner with a TWAIN-compliant program, a scan can be initiated from within the program. It is an image capture API for Microsoft Windows and Apple Mac operating systems.

UNC Path

Uniform Naming Convention (UNC) is a standard way to access network shares in Window NT and other Microsoft products. The format of a UNC path is:
\\<servername>\<sharename>\<Additional directory>

URL

Uniform Resource Locator (URL) is the global address of documents and resources on the Internet. The first part of the address indicates what protocol to use, the second part specifies the IP address or the domain name where the resource is located.

USB

Universal Serial Bus (USB) is a standard that was developed by the USB Implementers Forum, Inc., to connect computers and peripherals. Unlike the parallel port, USB is designed to concurrently connect a single computer USB port to multiple peripherals.

Watermark

A watermark is a recognizable image or pattern in paper that appears lighter when viewed by transmitted light. Watermarks were first introduced in Bologna, Italy in 1282; they have been used by papermakers to identify their product, and also on postage stamps, currency, and other government documents to discourage counterfeiting.

WEP

Wired Equivalent Privacy (WEP) is a security protocol specified in IEEE 802.11 to provide the same level of security as that of a wired LAN. WEP provides security by encrypting data over radio so that it is protected as it is transmitted from one end point to another.

WIA

Windows Imaging Architecture (WIA) is an imaging architecture that is originally introduced in Windows Me and Windows XP. A scan can be initiated from within these operating systems by using a WIA-compliant scanner.

WPA

Wi-Fi Protected Access (WPA) is a class of systems to secure wireless (Wi-Fi) computer networks, which was created to improve upon the security features of WEP.

WPA-PSK

WPA-PSK (WPA Pre-Shared Key) is special mode of WPA for small business or home users. A shared key, or password, is configured in the wireless access point (WAP) and any wireless laptop or desktop devices. WPA-PSK generates a unique key for each session between a wireless client and the associated WAP for more advanced security.

WPS

The Wi-Fi Protected Setup (WPS) is a standard for establishing a wireless home network. If your wireless access point supports WPS, you can configure the wireless network connection easily without a computer.

XPS

XML Paper Specification (XPS) is a specification for a Page Description Language (PDL) and a new document format, which has benefits for portable document and electronic document, developed by Microsoft. It is an XML-based specification, based on a new print path and a vector-based device-independent document format.

Index

A	
accessing	
management tools	210
C	
cleaning	
inside	53
outside	53
cleaning a machine	53
control panel	20
convention	10
E	
eco printing	36
F	
favorites settings, for printing	35
features	4
print media feature	68
front view	18
G	
general icons	10
glossary	218

google cloud printing	142
I	
installation	
accessories	211
J	
jam	
clearing paper	58
tips for avoiding paper jams	57
L	
Linux	
common Linux problems	192
driver installation for network connected	102
driver installation for USB cable connected	92
driver reinstallation for USB cable connected	93
printer properties	158
printing	157
unified driver configurator	172
using SetIP	98
loading	

paper in the tray1	27
special media	29
local	
driver installation	22
driver reinstalling	23
M	
Mac	
common Mac problems	191
driver installation for network connected	101
driver installation for USB cable connected	90
driver reinstallation for USB cable connected	91
printing	155
system requirements	72
using SetIP	97
maintenance parts	42
manual feeder/multi-purpose tray	
using special media	29
N	
network	
driver installation	

Index

Linux	102	card stock	31	problems	
Mac	101	labels	30	paper feeding problems	176
Windows	99	output support	68	power problems	177
installing environment	74	preprinted paper	31	printing problems	178
introducing network programs	95	special media	29	printing quality problems	182
IPv6 configuration	104	printer preferences			
SetIP program	96, 97, 98, 131	Linux	158	R	
wireless network setup	107	Printer Status		rear view	19
N-up printing		general information	170	regulatory information	75
Mac	155	Printing	33	S	
O		printing		safety	
overlay printing		changing the default print settings	146	information	11
create	153	Linux	157	symbols	11
delete	154	Mac	155	samsung printer experience	204
print	154	multiple pages on one sheet of paper		service contact numbers	213
P		Mac	155	SetIP program	96, 131
placing a machine		printing a document		special print features	144
adjusting the altitude	145	Windows	33	specifications	66
print		printing on both sides of paper		print media	68
mobile OS	139	Mac	156	stop button	20
mobile print	139	printing to a file	148	supplies	
print media		printing a document		available supplies	40
		Linux	157	estimated toner cartridge life	44
		Mac	155		

Index

ordering	40	driver reinstallation	91, 93	USB cable	
replacing toner cartridge	47	using help	36, 156	driver installation	197
SyncThru Web Service				wireless	
general information	164			driver installation	201
T		W		wireless	
toner cartridge		watermark		ad hoc mode	107
estimated life	44	create	152	Infrastructure mode	107
handling instructions	44	delete	152	USB cable	114, 117
non-Samsung and refilled	44	edit	152	WPS	
redistributing toner	45	Windows		disconnecting	111
replacing the cartridge	47	common Windows problems	190	PBC mode	111
storing	43	driver installation for network connected	99	WPS (the machine does not have a display screen)	
tray		driver installation for USB cable connected	22, 23	PBC	112
adjusting the width and length	26	driver installation for Windows 8 network connected	199	PIN	112
changing the tray size	26	driver installation for Windows 8 USB cable connected	197	wireless network	
troubleshooting	212	driver installation for Windows 8 wireless network	201	network cable	130
U		system requirements	71		
understanding the status LED	62	using SetIP	96, 131		
Unix		Windows 8			
system requirements	73	driver uninstallation	203		
USB cable		network			
driver installation	90, 92	driver installation	199		