

DIGITAL VIDEO RECORDER

User Manual

SDH-B74041

SDH-B74081



SAMSUNG

CE

SAMSUNG

CONTENTS

CHAPTER 1 OVERVIEW OF DVR	6
1.1 FRONT PANEL	6
1.2 REAR PANEL	7
1.3 REMOTE CONTROLLER	8
1.4 INSTALL HARD DRIVE	9
1.5 CONNECT EXTERNAL EQUIPMENT	9
1.6 CONNECT CAMERA	10
1.7 CONNECT DVR	11
1.8 PROTECTION OF CABLE FROM WATER	11
1.9 INSTALLING THE CAMERA	12
CHAPTER 2 DVR BOOT UP	13
2.1 SYSTEM INITIALIZATION	13
2.2 STARTUP WIZARD	13
2.3 MAIN INTERFACE	18
CHAPTER 3 DVR MENU	20
3.1 MAIN MENU GUIDE	21
3.2 MAIN MENU	22
3.2.1 <i>Parameter</i>	22
3.2.2 <i>Record Search</i>	34
3.2.3 <i>Device</i>	40
3.2.4 <i>Cloud Storage</i>	41
3.2.5 <i>System</i>	41
3.2.6 <i>Advanced</i>	45
3.2.7 <i>Shutdown</i>	46
3.3 MENU LOCK	47
3.4 SPLIT MODE	47
3.5 RECORD SEARCH	47

3.6 MUTE	47
3.7 START SEQUENCE.....	47
CHAPTER 4 WEB APPLICATION MANAGER.....	48
4.1 WEB PLUGIN DOWNLOAD AND INSTALLATION	49
4.2 WEB APPLICATION MANAGER LOGIN	55
4.3 LIVE INTERFACE	55
4.3.1 Menu Bar	56
4.3.2 Playback	57
4.3.3 Remote Setting	60
4.3.4 Network.....	65
4.3.6 Device	68
4.3.7 System	69
4.3.8 Advanced	71
4.3.9 Local Setting	74
4.3.10 Logout.....	74
CHAPTER 5 MOBILE APP	74
CHAPTER 6 APPENDIX.....	77
6.1 TROUBLESHOOTING.....	77
6.3 SPECIFICATIONS.....	79
6.4 DIMENSION	83

SAFETY INSTRUCTION

Please carefully read the following safety instruction so as to avoid personal injuries and prevent the equipment and other connection devices from being damaged.

1. Please use the power supply enclosed or specified by the manufacturer.
Never operate the equipment by using unspecified power supply.
2. Never push objects of any kind through openings of DVR so as to avoid electric shock or other accidents.
3. Do not put the equipment in a dusty location.
4. Do not place the equipment under the rain or humid environment like the basement.
If the equipment is accidentally in contact with water, please unplug the power cable and immediately contact technical support.
5. Keep the surface of the equipment clean and dry.
Use a soft damp cloth to clean the outer case of the DVR. (Do not use liquid aerosol cleaners.)
6. Do not operate if any problems are found.
If there is a strange smell or sound from the DVR, unplug the power cable and contact technical support..
7. Do not try to remove the DVR cover to avoid electrical shock.
8. Handle with care.
If DVR does not work properly, please contact technical support for repair or replacement.
9. Install and place the equipment in a well ventilated area. The DVR system includes a HDD, which produces large amount of heat during operation. As a result, do not block the ventilation vents (on the top, bottom, sides and the back of the DVR).
10. The power adapter should only be connected to the DVR. Do not connect it to additional equipment or else the DVR may restart repeatedly due to insufficient power.
11. Do not install near any heat sources such as radiator, stove, and other machinery or devices (including speakers) that produce large amount of heat.
12. If the provided plug does not fit your outlet, please technical support for assistance.
13. Protect the power cord from being walked on or pinched particularly at the plug level and each ends of the cord.
14. Only use attachments/accessories specified by the manufacturer.
15. Only use the cart, stand, tripod, bracket, or table specified by the manufacturer, or sold with the system. When a cart is used, use caution when moving the cart and the device to avoid injury from tip-over.
16. Unplug the device during lightning storms or when unused for long periods of time.
17. Refer all servicing to qualified service personnel. Servicing is required when the device has been damaged in any way, such as power-supply cord or plug is broken, liquid has been spilled or objects have fallen onto the device, exposed to rain or moisture, does not operate normally, or has been dropped.



Standards Approvals



- This equipment has been tested and found to comply with the limits for a Class A digital device, pursuant to part 15 of the FCC Rules. These limits are designed to provide reasonable protection against harmful interference when the equipment is operated in a commercial environment.

This equipment generates, uses, and can radiate radio frequency energy and, if not installed and used in accordance with the instruction manual, may cause harmful interference to radio communications. Operation of this equipment in a residential area is likely to cause harmful interference in which case the user will be required to correct the interference at his own expense.

Chapter 1 Overview of DVR

1.1 Front Panel

P.S: DVR is short for Digital Video Recorder.

Front panel for DVR with 8 channels for SDR-B74301

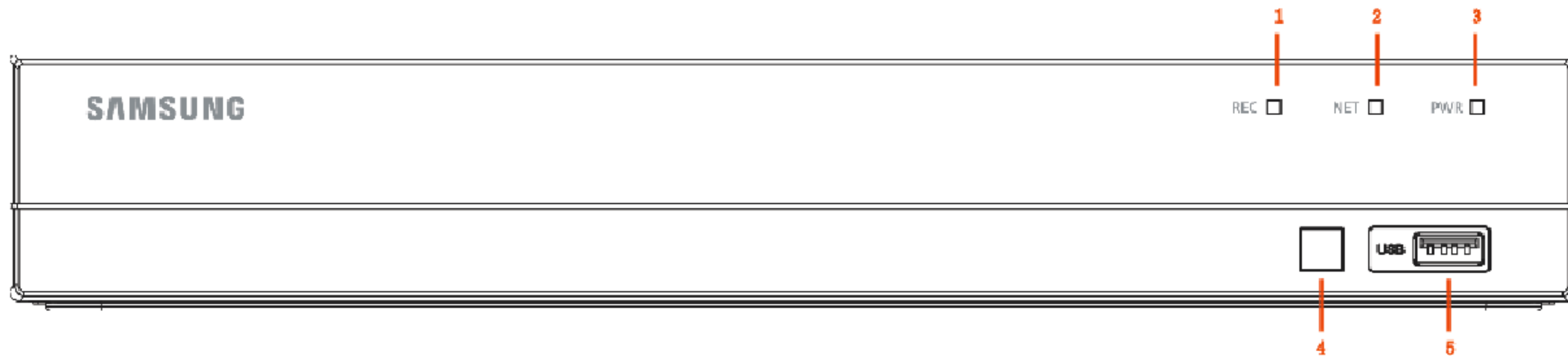

SN	Type	Key or indicator	Identification	Functions
1	Status lamp	HDD indicator	REC	If the "Red" indicator flashes, the hard drive is being read or written to.
2		Net indicator	NET	Display network connection and data transfer status.
3		Power indicator	PWR	If the "Blue" indicator is on, DVR is getting power normally.
4	IR port		<input type="checkbox"/>	Receive IR signal from Remote Controller.
5		USB	USB	USB port

1.2 Rear Panel

Back panel for SDR-B74301

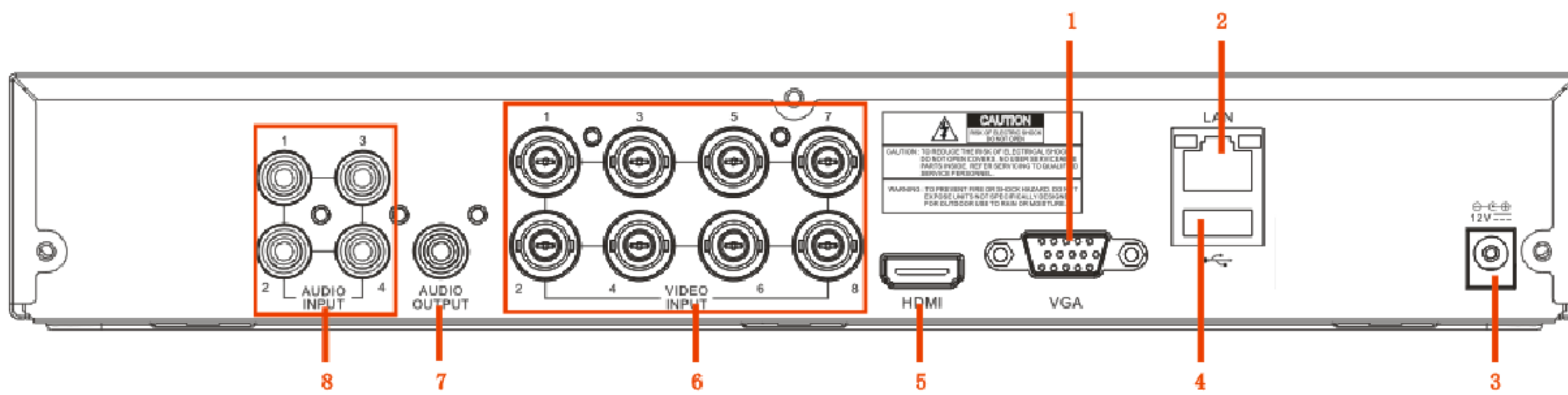

SN	Physical Interface	Connection
1	VGA port	Connect with VGA display devices, such as PC monitor
2	LAN: (RJ45) Network port	Connect with LAN, Ethernet cable.
3	Power port	Connect with the power supply DC12V 2A, included with the device
4	USB port	Connect with USB
5	HDMI	Connect with HDMI display devices, such as PC monitor
6	Video input	Connect with CH1-8 (analog) video input device, standard BNC port
7	Audio output	Audio signal output, RCA port
8	Audio input	Connect with CH1-4 audio input signals, RCA port

1.3 Remote Controller

Operation of remote controller

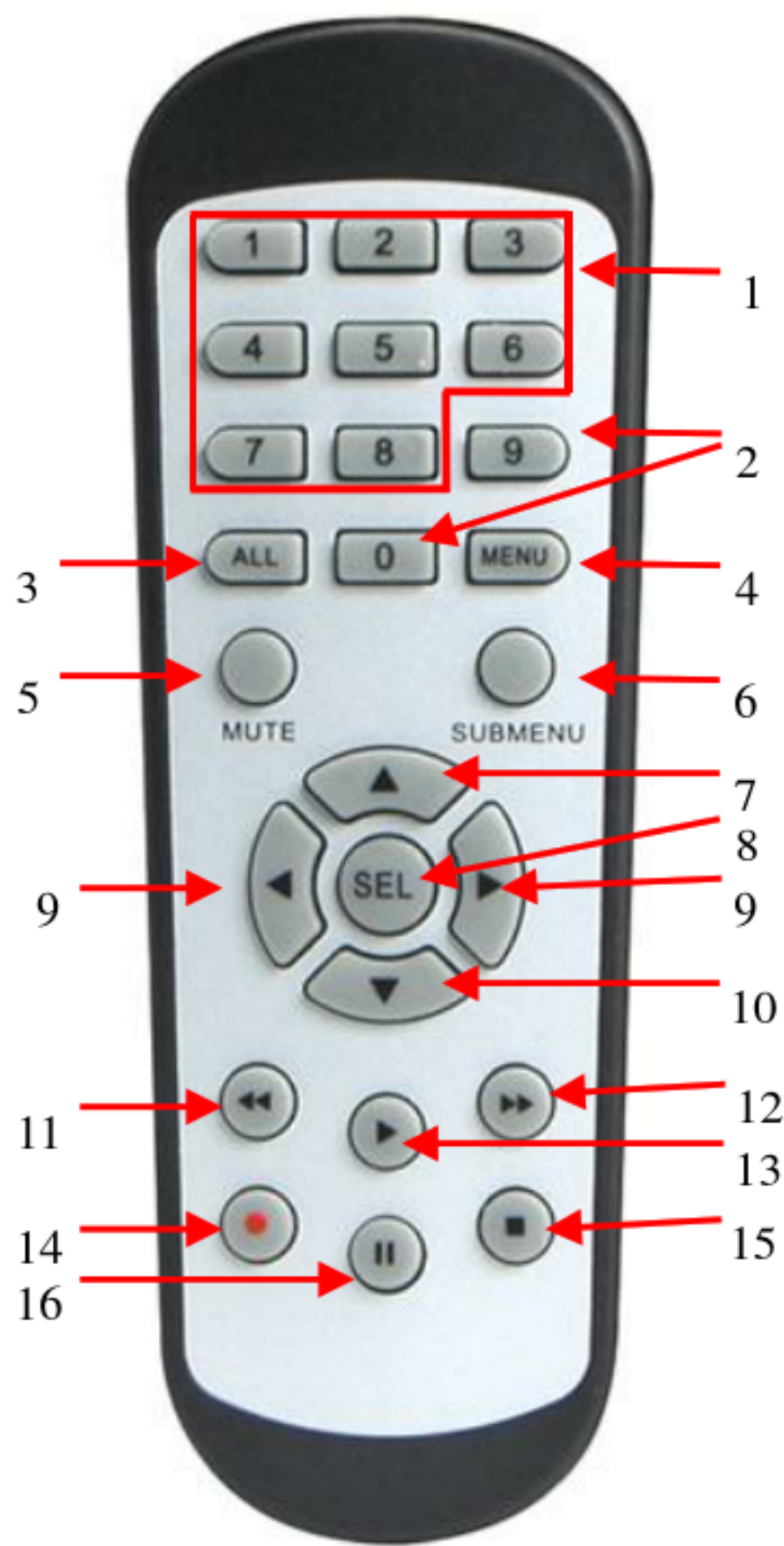

Item	Key title	Key function
1	1-8	Channel select 1-8; Numeric key
2	9/0	Numeric key
3	ALL	Multiple display mode
4	Menu	Enter into Main menu/Exit
5	Mute	Mute on/off
6	Submenu	Go to Submenu
7	▲	Up arrow key, volume increase
8	SEL	Select key/Edit key
9	◀/▶	Left/Right key; Decrease/Increase parameter value of control bar.
10	▼	Down arrow key, Volume decrease
11	◀◀	Rewind key
12	▶▶	Forward key
13	▶	Enter into record search menu / Play key
14	●	Record key
15	■	Stop manual record; stop playing
16		Pause/Step forward key

1.4 Install Hard Drive

Note: HDD is pre-installed. If you want to replace hard disk drive, please refer to the following instruction. Please do not remove the hard drive when DVR is operating.

Installation of Hard Drive:

- (1) Unplug the DVR to turn the power off. Using a screwdriver, remove the screws from the side and back panels, and then remove the top cover.



- (2) Connect data and power cables of hard drive to the motherboard. Mount the hard drive by mounting it onto the rack and connecting the power and data cables. Two groups of screw mounting holes are provided on the base frame of the DVR, respectively for installation of a 3.5" hard drive and 2.5" hard drive. Screw the hard drive in place according to the size of your hard drive.

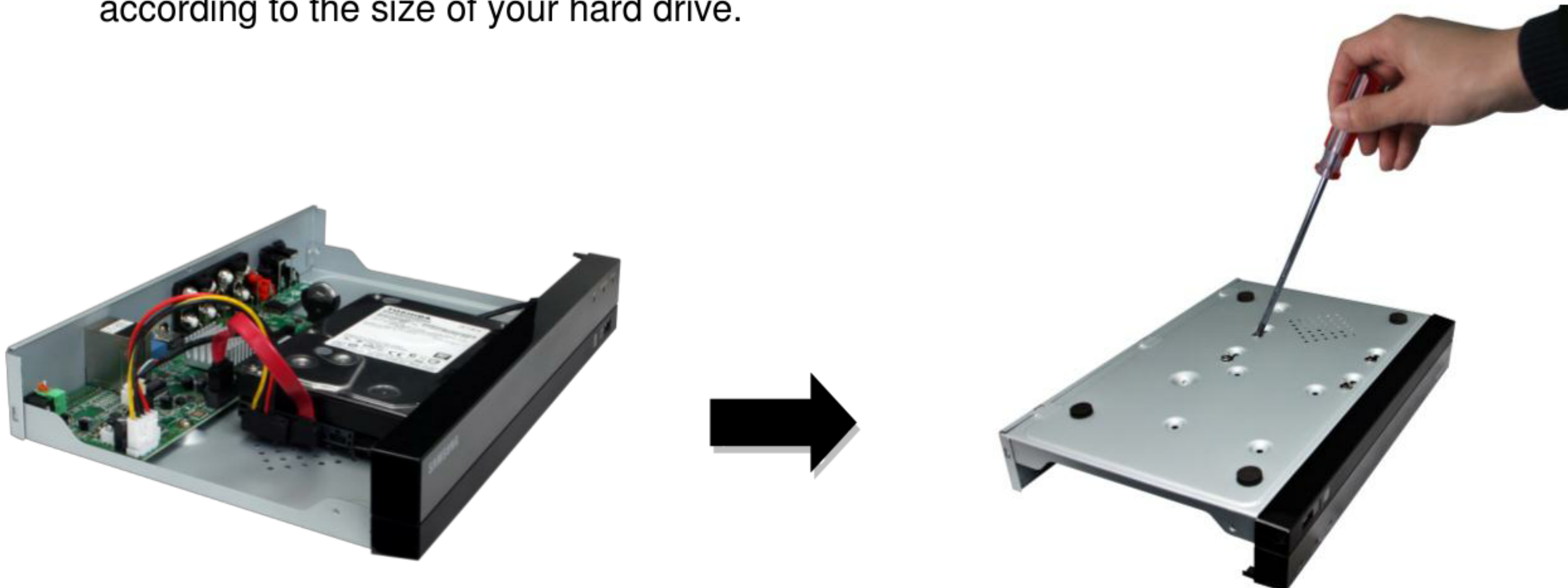

- (3) Next, screw the back panel in place, and then the sides.



1.5 Connect external equipment

Connect camera signal cable to video input port on the DVR via the BNC connectors. Connect your monitor to the DVR using the VGA or HDMI video cable. Connect DVR to the power supply adapter provided. After all connections are completed, plug the DVR in to perform function checks. Be sure that all audio/video I/O ports are connected properly.

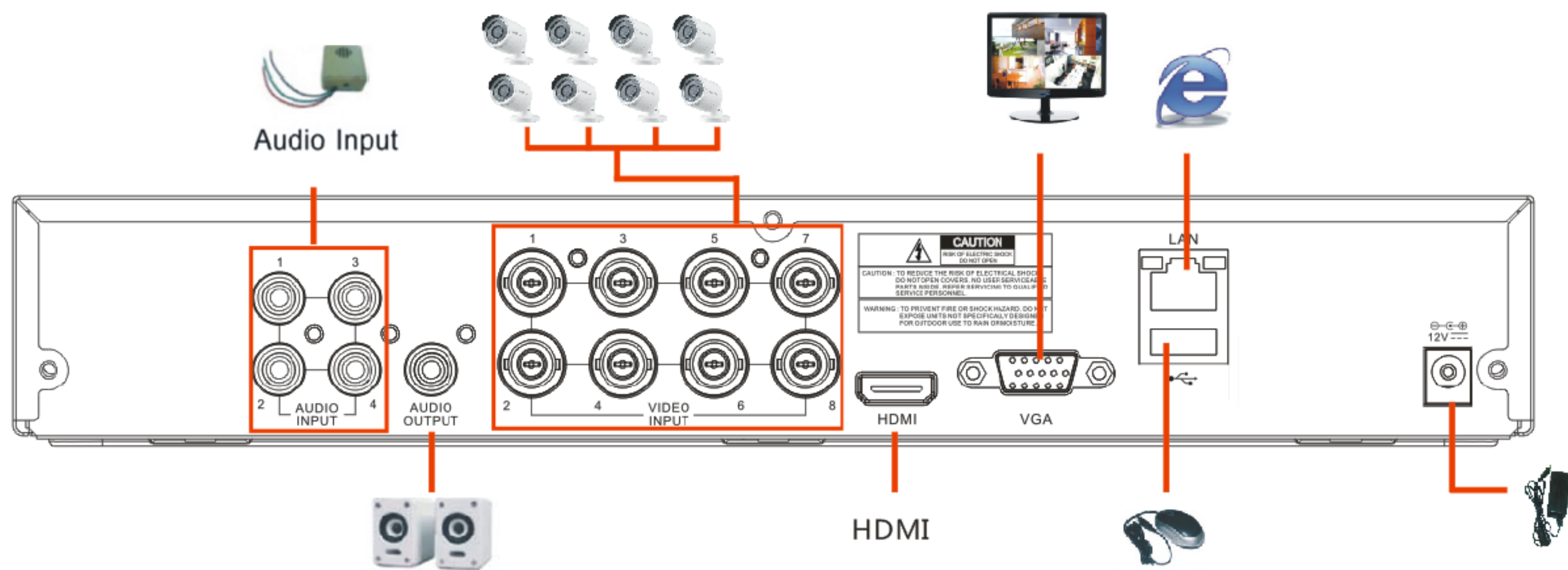

1.6 Connect Camera

Connecting the Camera (SDC-9443BC)

Equipped with the IR LED lights and the illumination sensor, the camera enables you to monitor at all times, day and night. The camera is suitable for both indoor and outdoor use.

Do not fully expose the camera to rain. The camera must be installed under a shelter to avoid exposure to excessive rain or moisture.

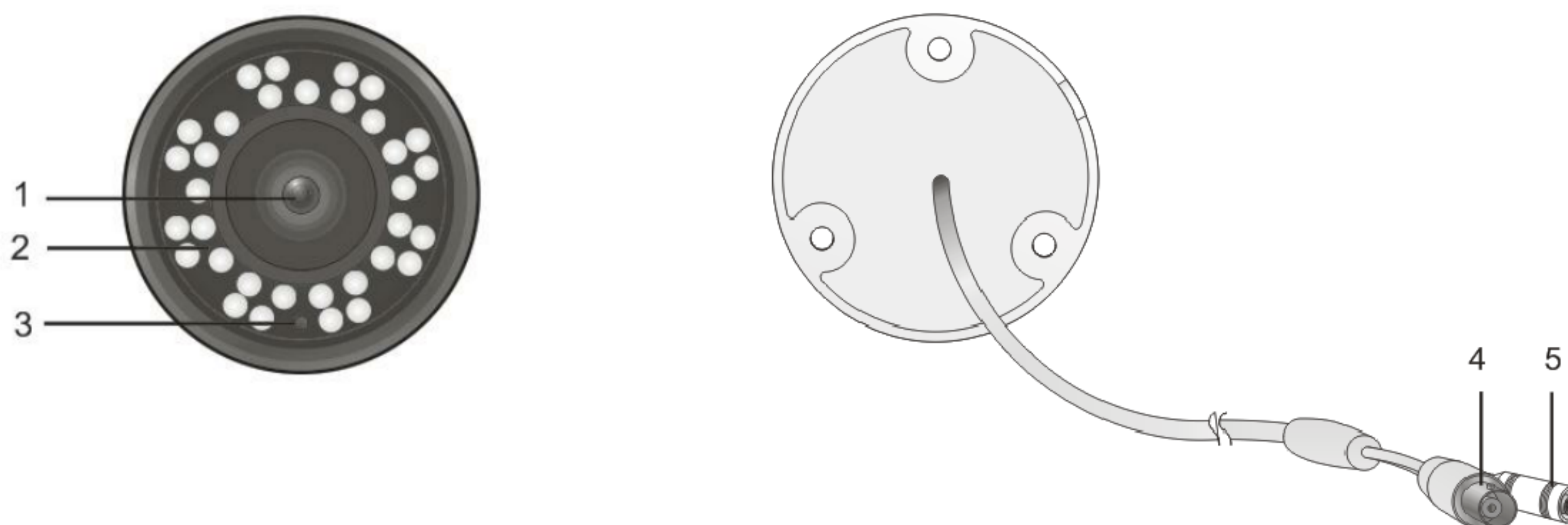

	Name	Description
1	Lens	3.6mm focal length enables you to monitor at a wider field of view
2	IR LED	Infrared LED lights are controlled by the illumination sensor.
3	Illumination Sensor	Detects incoming light to control the IR LED.
4	BNC Cable	BNC terminal for video signal output.
5	Power Cable	Use to power the camera.

1.7 Connect DVR

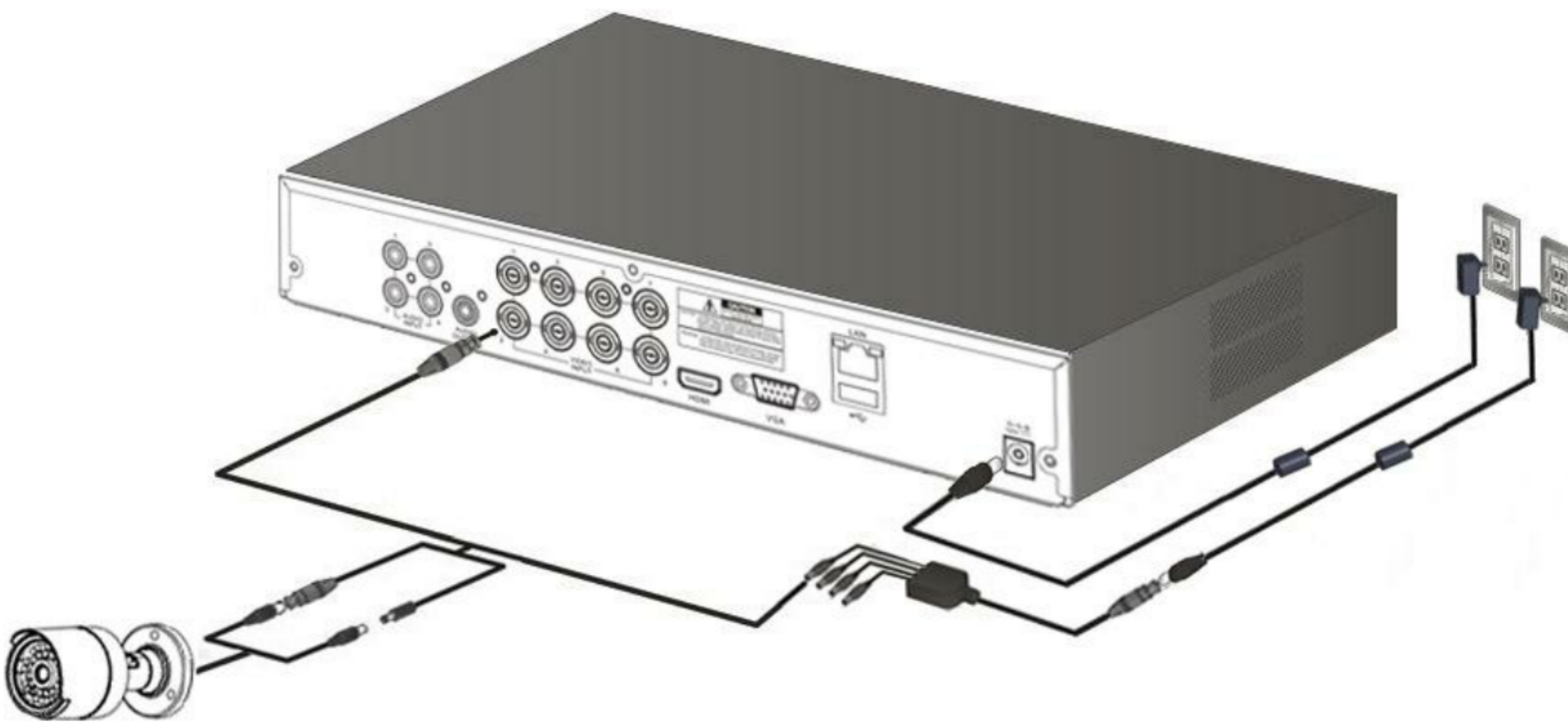

1.8 Protection of Cable from Water

If this product is mounted outdoor, water leakage may occur at gap between cables. As shown below, butyl rubber (available on the market) shall be used to protect from water.

1. Connect power supply and BNC power source.
2. Cover black sheath of the cable (Zone A), and ensure half of butyl rubber can cover the cable joint.

※ Poor water protection at the cable sheath may cause water leakage. Make sure to wrap tightly.

※ The water-proof butyl rubber is made of rubber that expands to twice the original length.

※ If you do not use cable joint, it must be covered with water-proof tape.

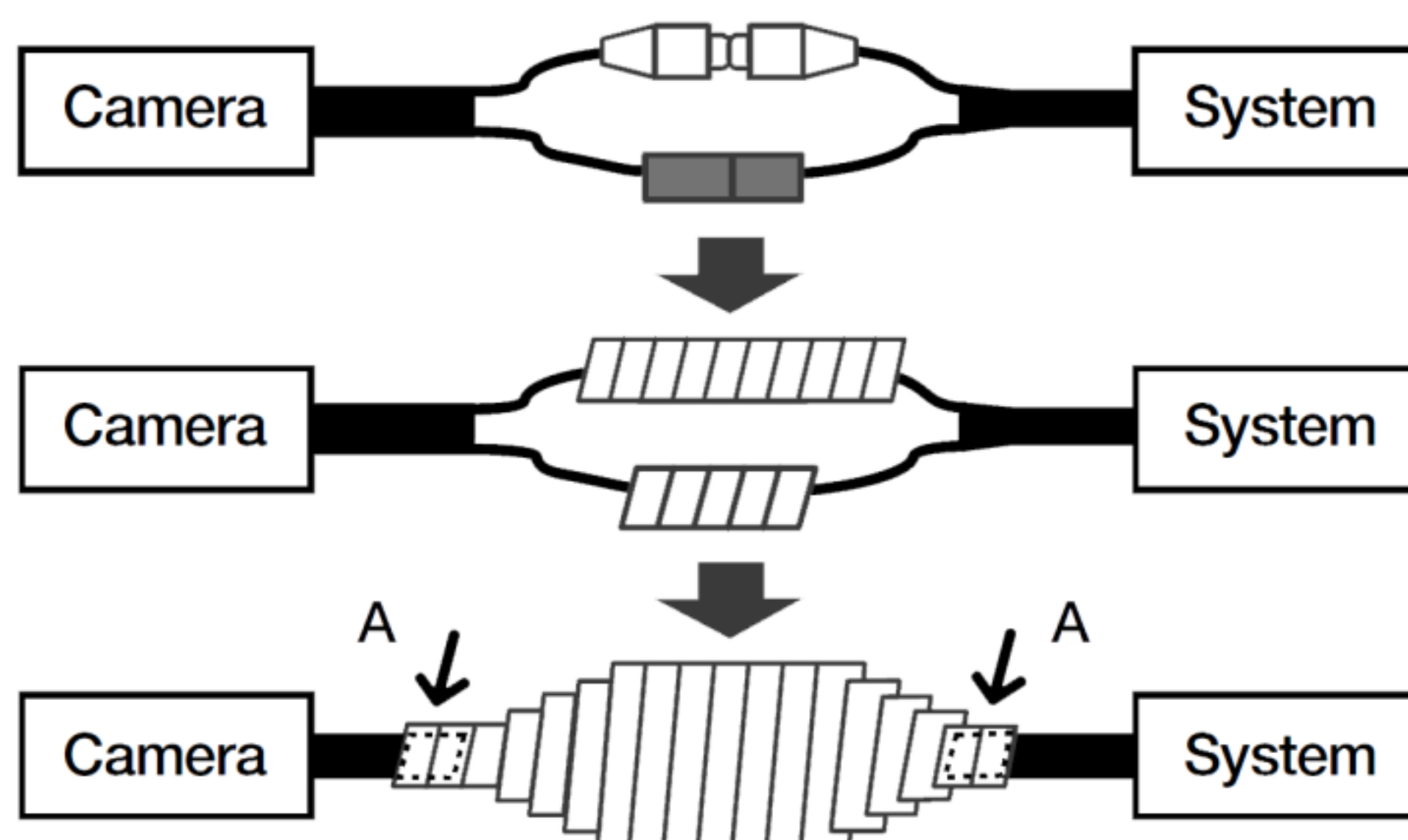

1.9 Installing the camera

The camera can be installed on the wall, ceiling, shelf or a desired position using the provided mounting bracket.

1. Adhere the installation template onto the ceiling and use it as installation locating tool. (Please refer to Page 21 of Quick Guide.)
2. Choose an installation site that can sufficiently support the weight of the camera to be installed.

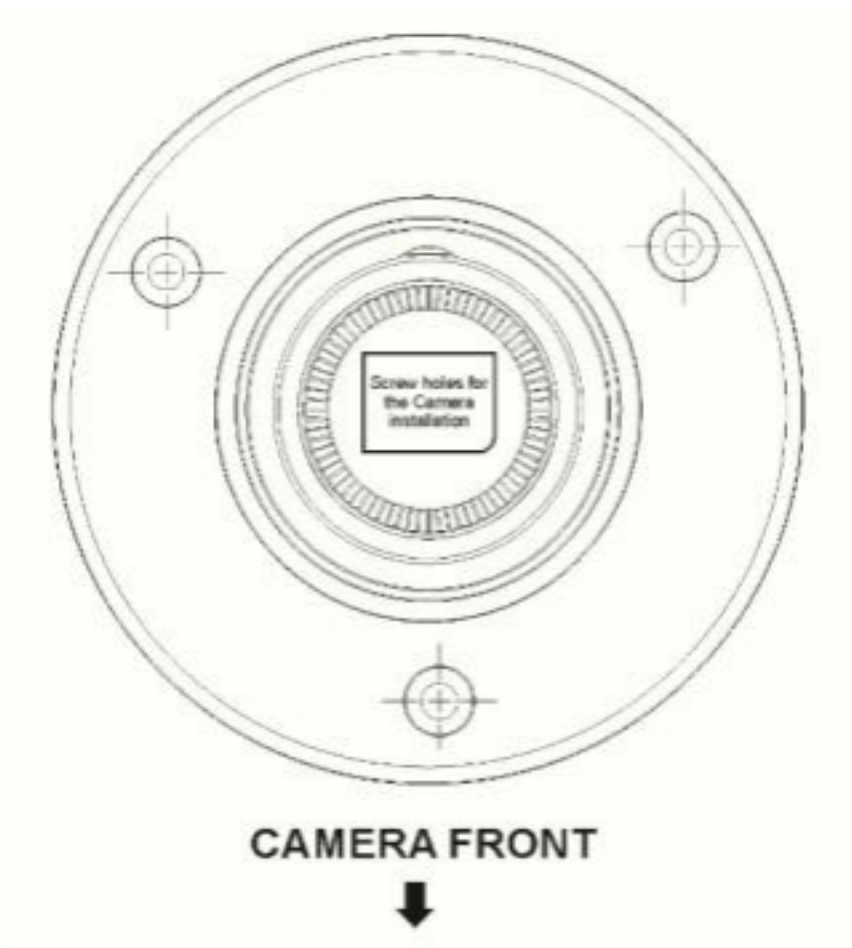

3. Attach the camera mount to the wall using the supplied screws.
4. Adjust the direction of the camera to the desired direction, and tighten the bracket.
5. Adjust camera angle as needed.



6. Connect the camera cable to the camera.

Take caution when installing the camera outdoors because the cable connectors may be wet with moisture or pile up with impurities.

Although the camera is IP66 rated, direct exposure to water or moisture may cause problem such as condensation.

Chapter 2 DVR Boot up

2.1 System Initialization

After connecting the DVR power cable to wall outlet, the DVR system initializing screen will appear.

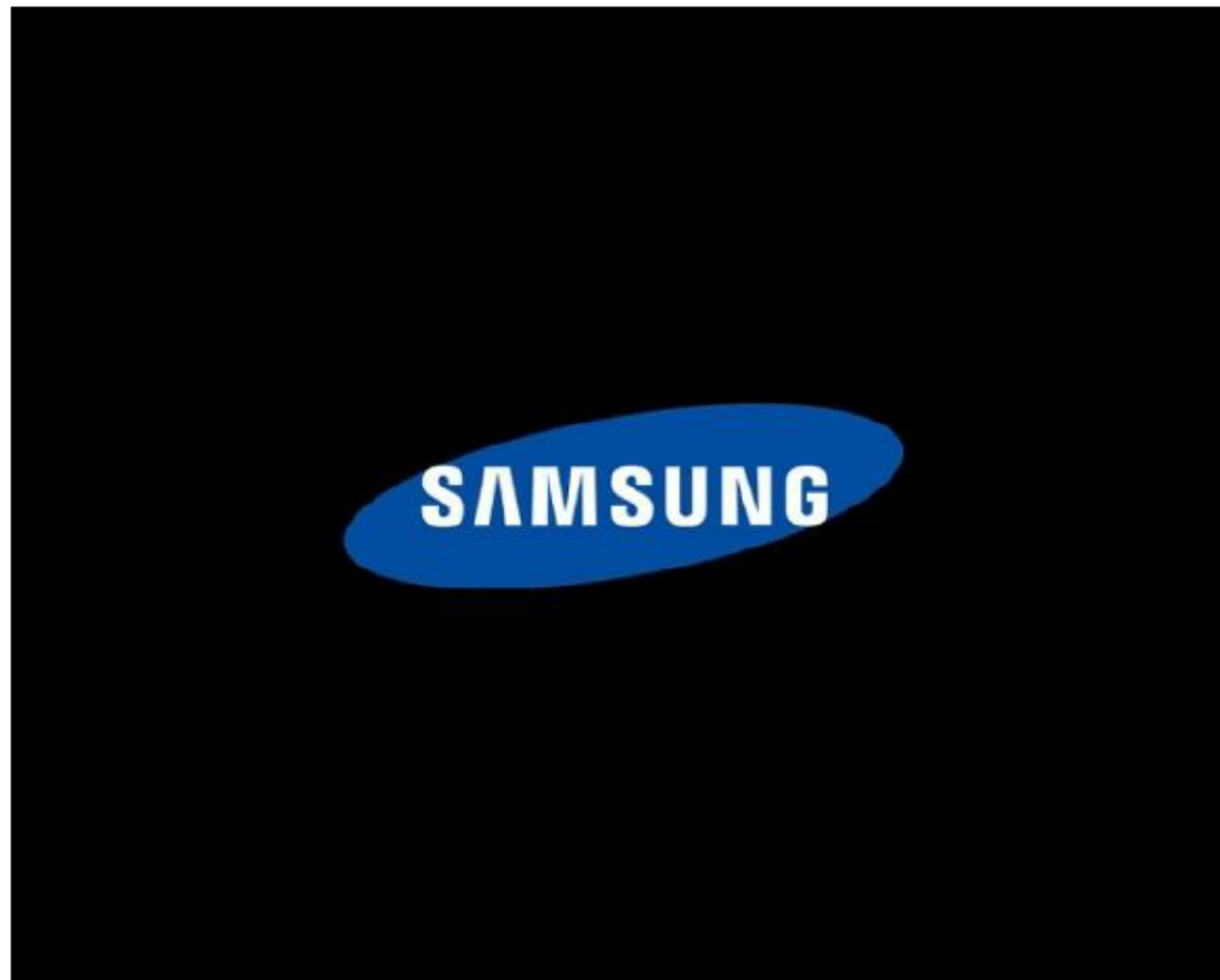

Note: It may take 40 seconds to start up, and the screen may beep 5~6 times.

2.2 Startup Wizard

After the DVR startup is complete, the startup wizard will display.

Wizard setting menu includes: Homepage, admin password setting, hard drive management, video recording schedule, basic system configuration, network setup, e-mail and DDNS setting.

You can click on "Don't show this window next time" if you do not wish to have the wizard setting to appear next time.

1. Set Admin Password: Please create a user name and password for your device. Password MUST be 8~13 characters long, and with at least a combination of two types of characters.

Retype password: Re-enter the password set above

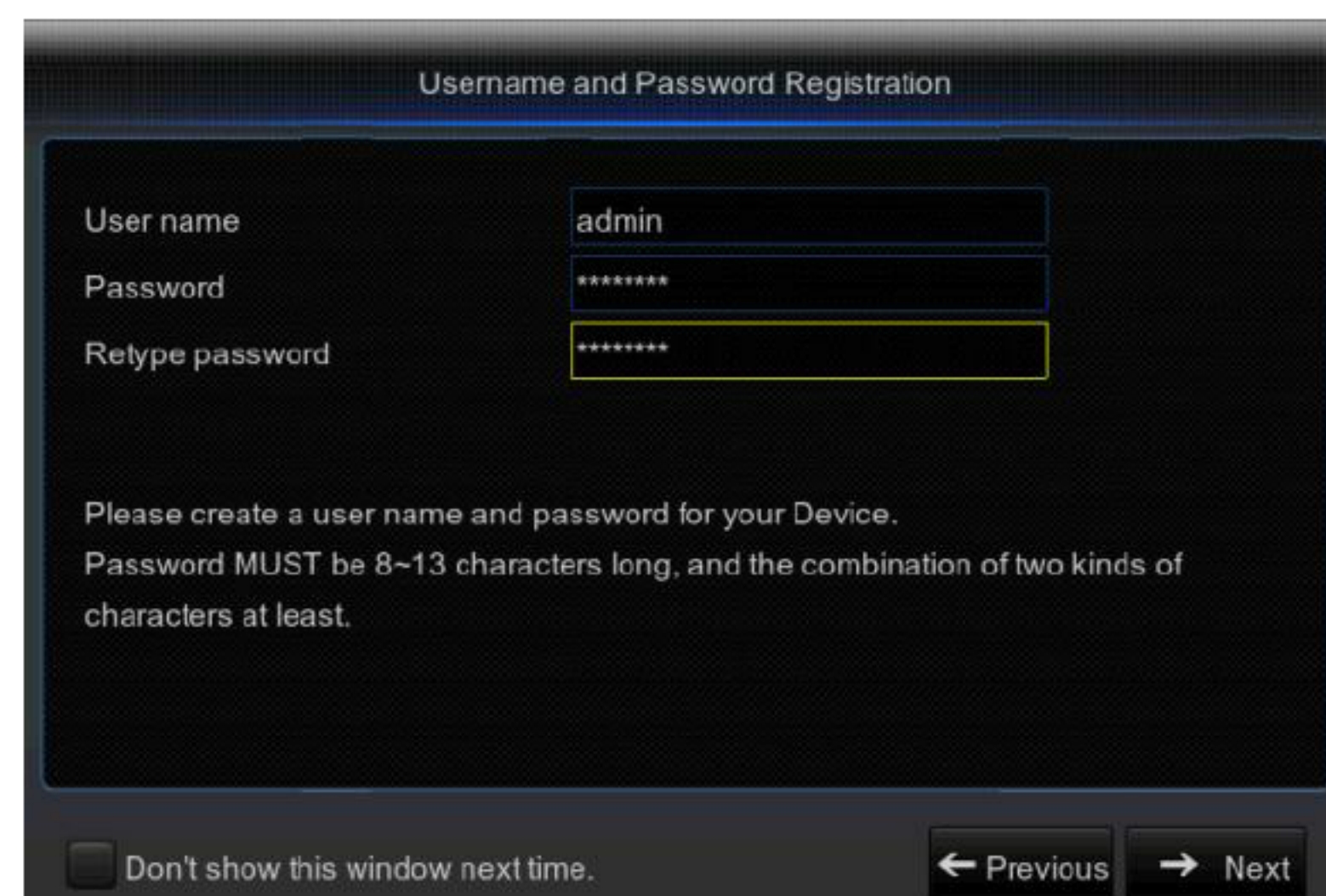

2. Hard Drive Management: Any new disk connected must be formatted before use. Click on “Select” to highlight the hard drive to be formatted. Click on “Format HDD” and the user login box will appear. Enter the password to log in. Click on “OK” to format the disk when the “Entire Data Will Be Erased. Do You Want To Continue?” dialog box appears. Formatting process is complete when the progress bar is full.

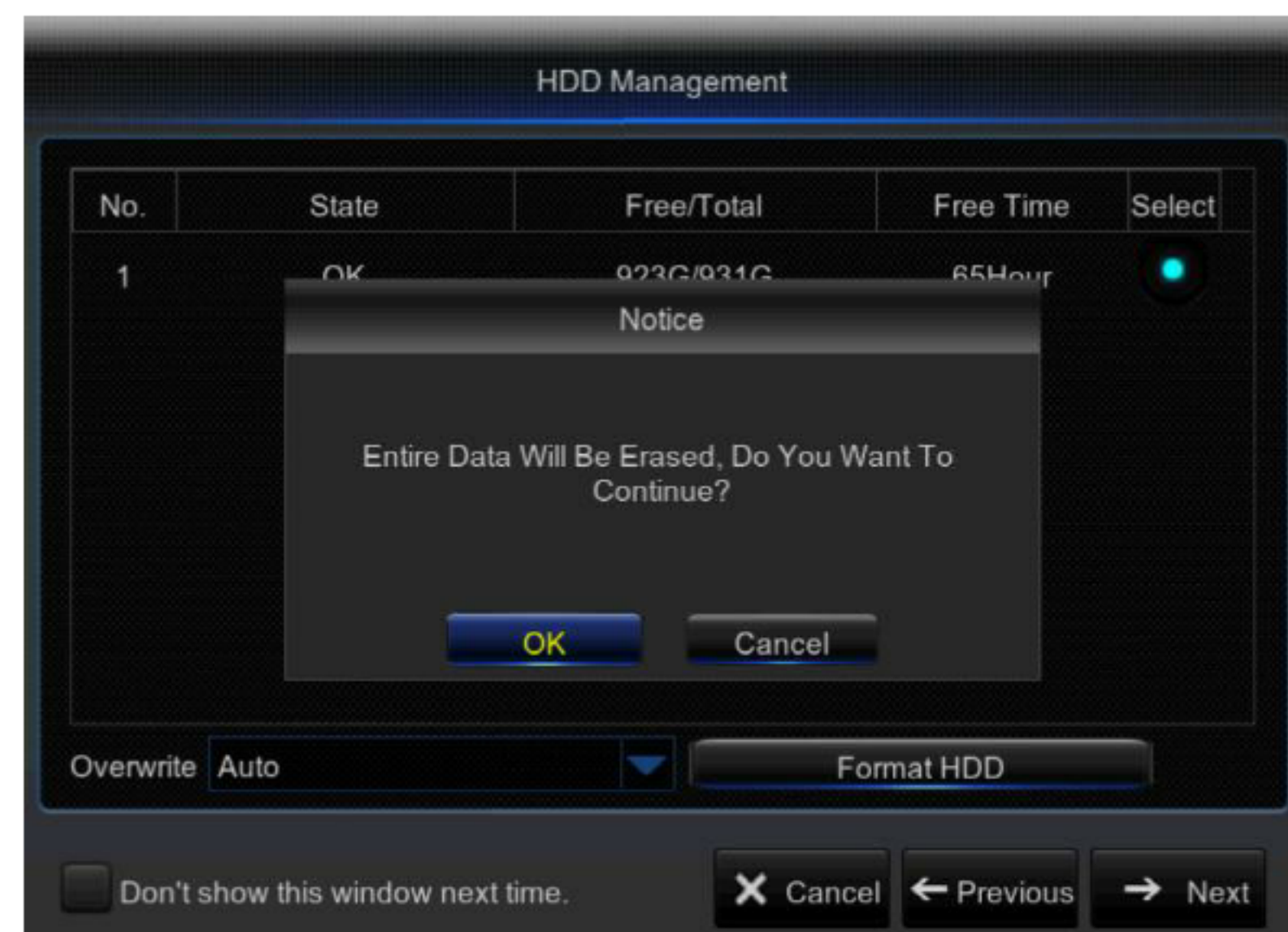
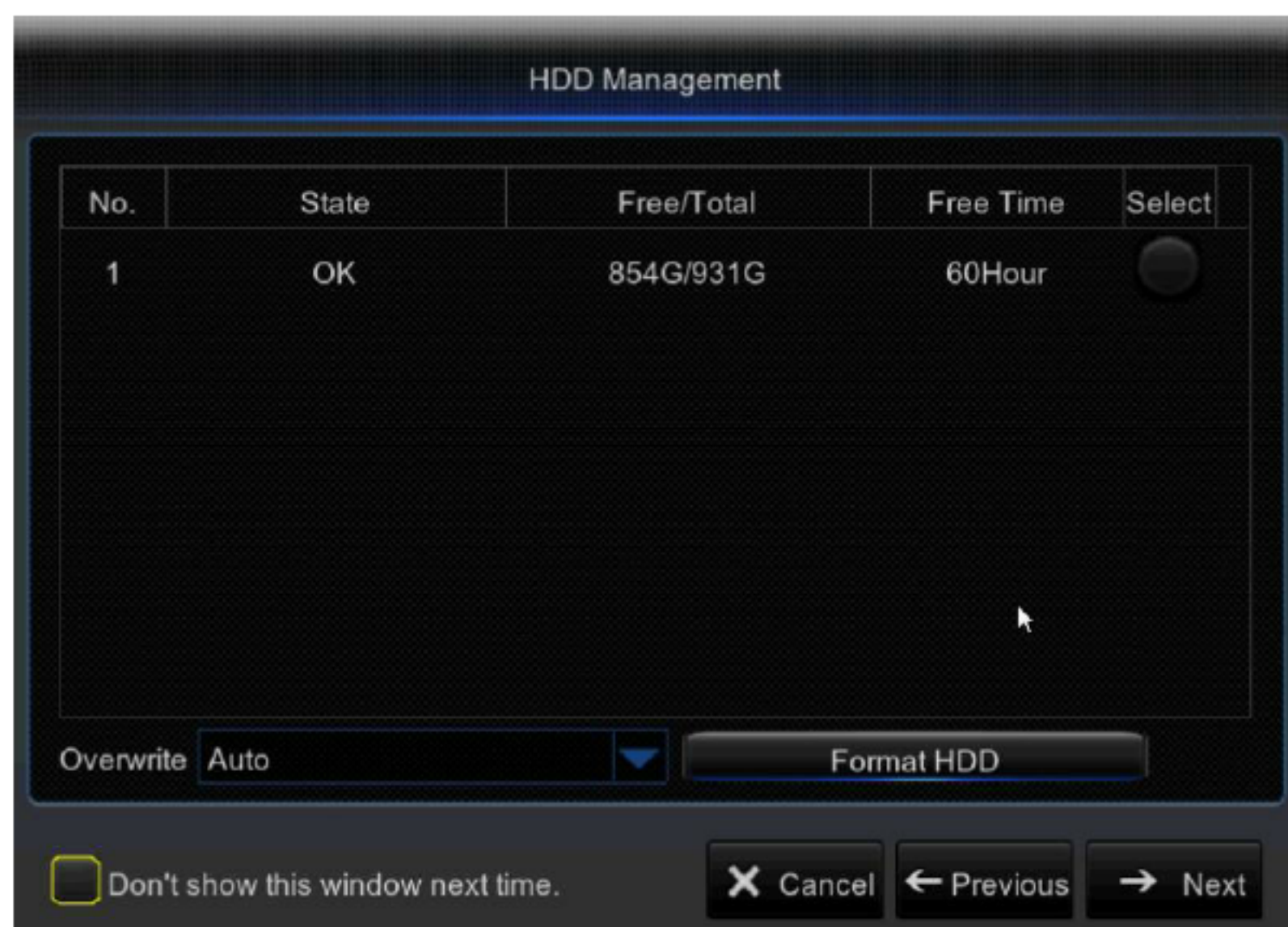

3. Video Recording Schedule: Select the channel and the date to be set. One week's schedule can be set.

The record schedule of the current channel can be copied to any other channel or all channels.

Note:

- 1) In the Record menu and Record Search menu, when no colors are presented, it means there are no recordings during that time.
- 2) “Green” stands for normal record and “yellow” stands for motion record.



4. General System Configuration: Set the date, time, date format, time format, language, video format and menu timeouts.



5. Network Configuration (DHCP): In DHCP mode the router will automatically assign an IP address to DVR. If the DVR fails to obtain an IP address, refer to the DVR Router Guide. If the problem still cannot be resolved, contact technical support.

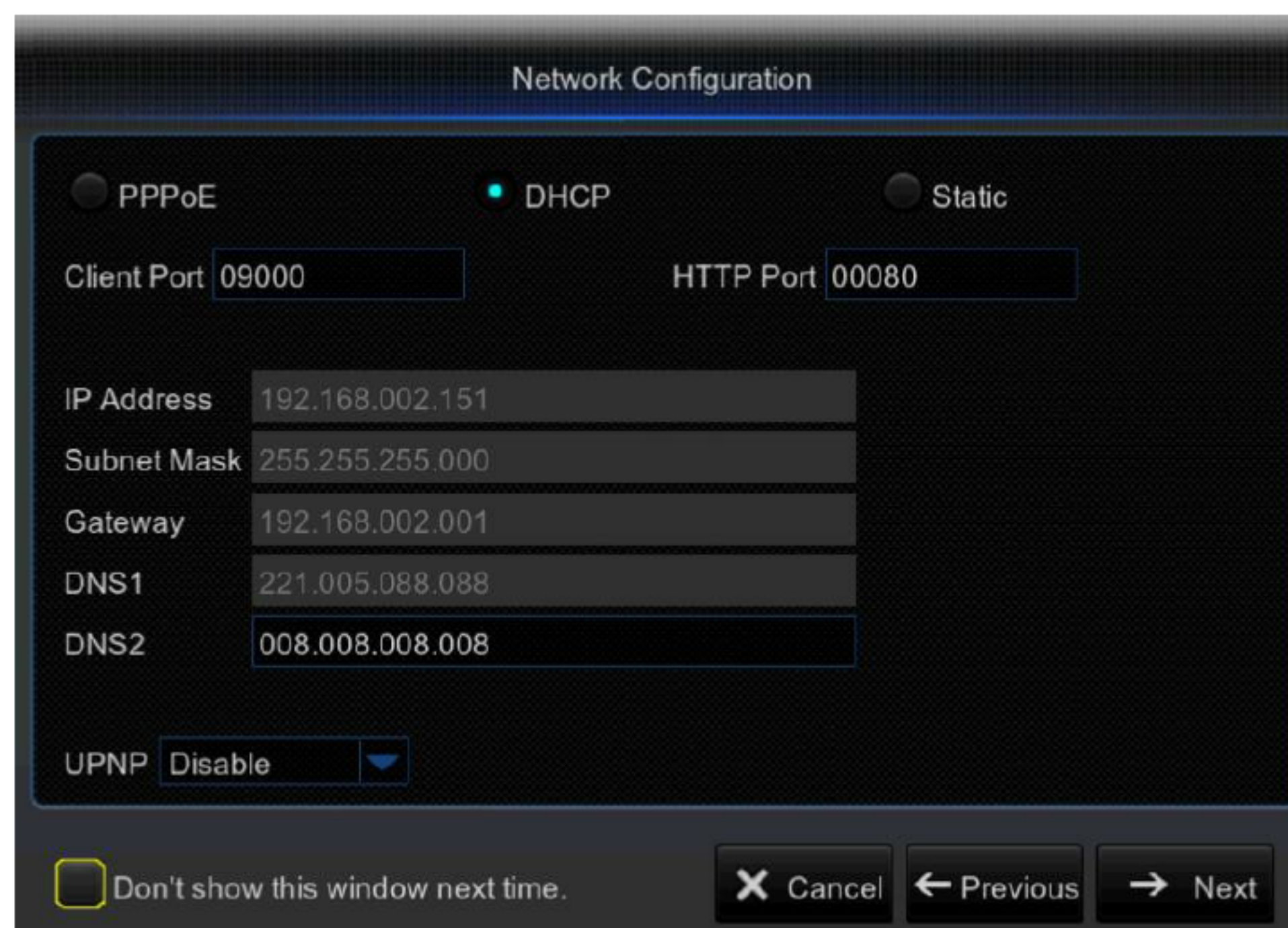

6. Email Configuration: Receive or Send DVR alerts via email.

The screenshot shows the 'Email Configuration' window with the following settings:

- Email: Enable
- SSL: Disable
- SMTP Port: 00025
- SMTP Server: (empty)
- Sender: (empty)
- Sender Password: (empty)
- Receiver: (empty)
- Interval: 3 Min

Buttons: Test Email, Don't show this window next time., Cancel, Previous, Next.

- **SSL (Secure Socket Layer):** This is an industry standard transport protocol that establishes an encrypted link between the web server and browser. This link ensures that all data that passes between the web server and browser remains private and integral. If the setting is incorrect, check you mail server's SMTP port
- **SMTP Port:** The mail sending port used by SMTP (Simple Mail Transfer Protocol) server is generally Port 25, or Port 465.
- **SMTP Server:** Enter address of the mail server you want to connect to.
- **Sender address:** Enter sender's mail address, which must correspond to the server used. For example, mailbox "aaa@gmail.com" should correspond to server "smtp.gmail.com".
- **Recipient address:** Recipient's mail address, used to receive alarm image and message from DVR side. If system alarms continually and sends Email images frequently, save the images to another location or remove them, so as to avoid excessive space occupation and thereby affect your normal use of mailbox.
- **Time interval:** A mail will be sent every three minutes by default. If the time interval for mail notification is set too short, email server may deem mails as junk mails, so they cannot be transferred normally.

7. DDNS SETTING. User may set DDNS under network type of PPPoE/Static/DHCP after applying dynamic domain service. User may remotely access DVR through domain by using browser in the form of http://applied domain: mapped HTTP port number when using DDNS domain name to access DVR.

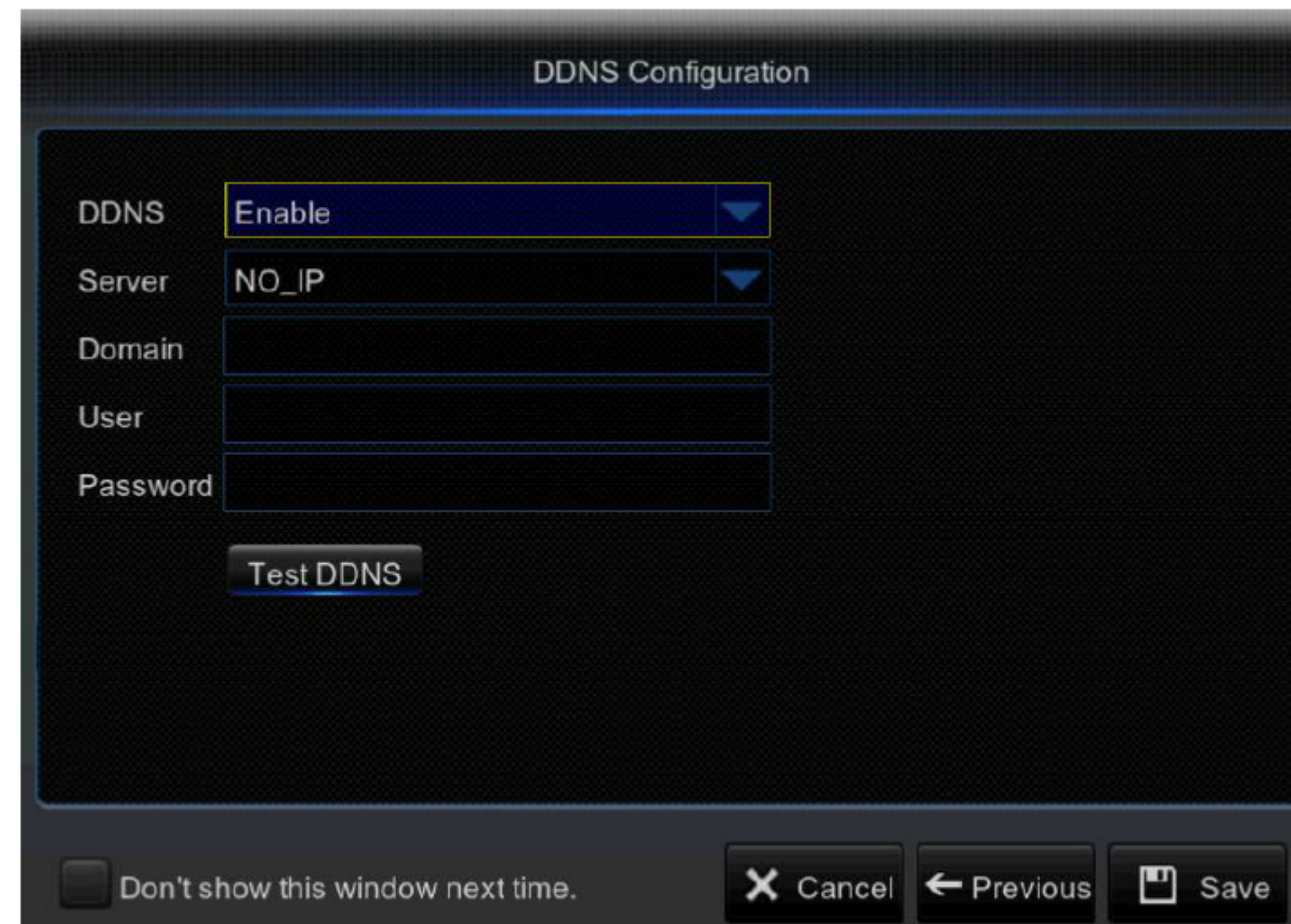

- **Server address:** Select dynamic domain name server provider. Available domain name servers (DDNS_3322, DYNDNS, NO_IP, CHANGEIP, DNSEXIT)
- **Host name:** dynamic domain name of the host obtained from dynamic domain name service provider upon registration, for example, dvr2016.no-ip.org
- **User Name:** The user name registered upon application for dynamic domain name.
- **Password:** The password set upon registration.
- Click on “Test DDNS”. If connection succeeds, it will be indicated that “DDNS Test is Successful!

Perform remote access to DVR by using dynamic domain name, for example,
http://dvr2016.no-ip.org: HTTP port number (e.g. 19010)

8. Click on "Save" to finish setting of startup wizard.

2.3 Main Interface

In real-time preview mode: right click on any area to access the desired menu. Right click on it to open a context menu, whose menu items may vary depending on the specific condition, such as sign-in, sign-out, split screen mode and various operation conditions.

Left click on any channel to access shortcut menu, where operations such as image capture, recording and image zoom-in are available.

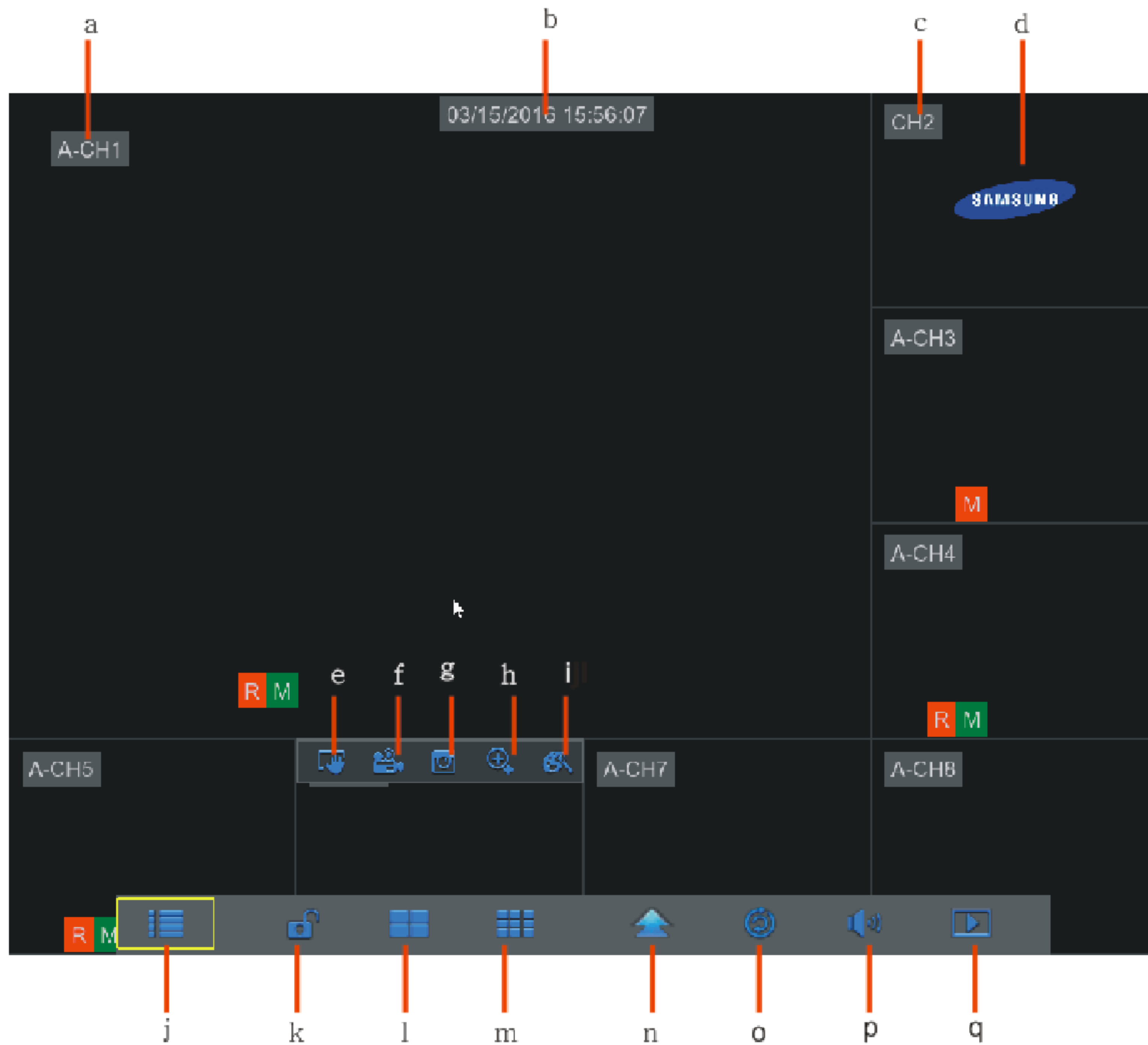

The video recording marks are as shown below:

R means common Recording. **M** means Motion detection recording. **M** means Motion detection without recording.

Component Name		Function
a	Camera Type	A means AHD camera. Absence of it means 960H camera.
b	Date & Time	Display current date and time
c	Channel Name	Display channel name
d	SAMSUNG Logo	The logo of SAMSUNG will display only when video is loss.
e	Image Capture	Make a snapshot of current video
f	Manual Recording	Enable or disable manual recording
g	Quick Playback	Make playback of the last 5 minutes of the video
h	Electronic Zoom-In	Hold and drag mouse cursor to select a frame of current video to zoom in.
i	Channel Color Setting	Set hue, brightness, contrast and saturation of current channel.
j	Main Menu	Access the main menu
k	Lock	Sign out or access sign-in page.
l	Four-Channel Layout	Display four channels of video.
m	Nine-Channel Layout	Display nine channels of video.
n	N-Channel Layout	Display six channels of video.
		Display eight channels of video.
o	Polling	Start or stop polling.
p	Sound	Adjust volume or mute.
q	Playback	Access video retrieval page.

Chapter 3 DVR Menu

Popup Menu

After finishing system initialization, right click the mouse on preview interface or slide the mouse to the bottom of screen to enter into Pop-up Menu. Now you could perform parameter setting and operate on Main Menu, Multi-screen, Record Search, Sequence, Volume and Brightness settings.

The options in the pop-up menu may vary slightly according to different parameter settings and application environment. The options in the menu will be explained in detail in the following chapters.



3.1 Main Menu Guide

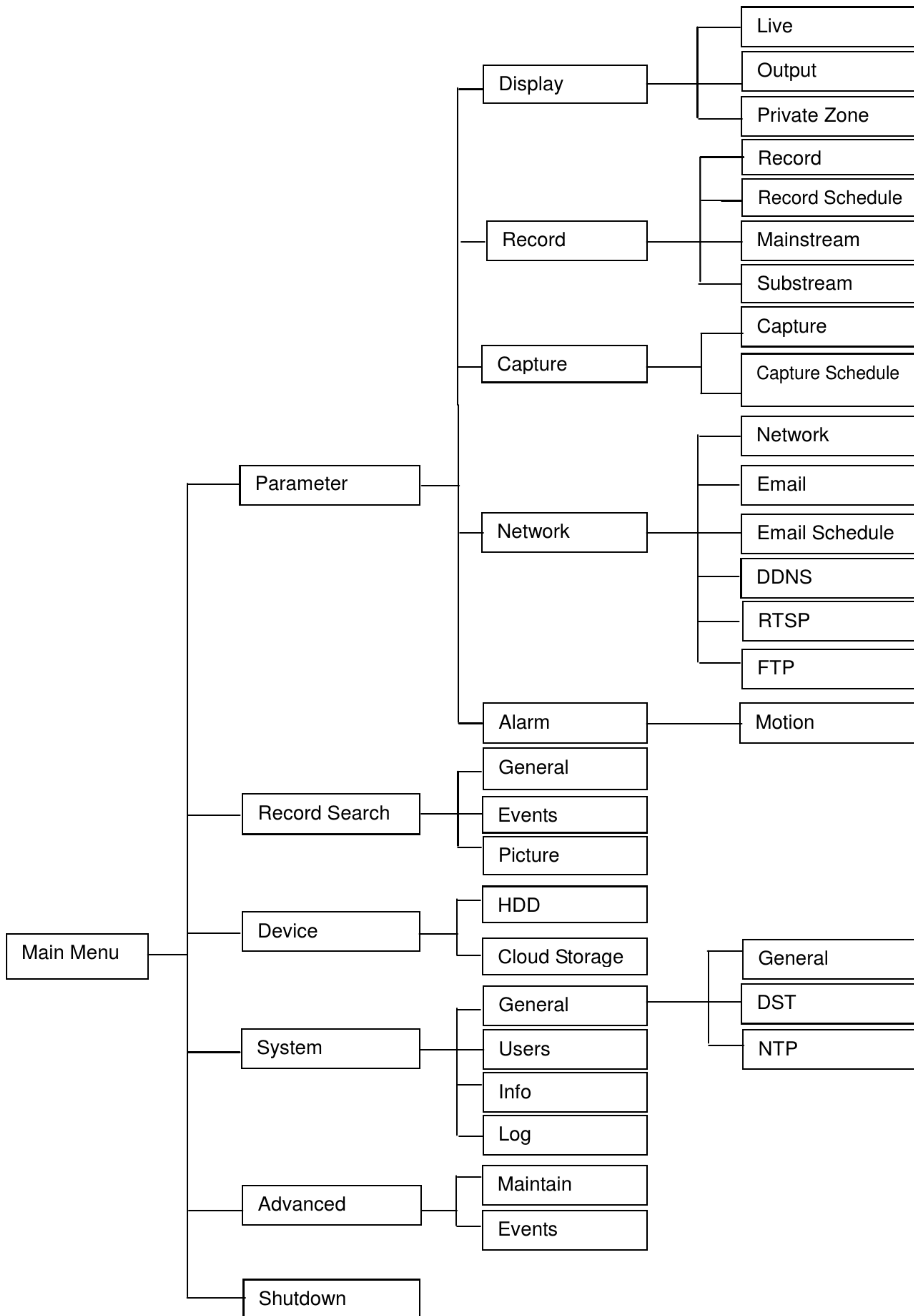

3.2 Main Menu

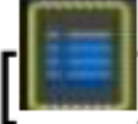
On LIVE mode, click the mouse button, or [Menu] button on the remote controller, or click  icon on the toolbar to enter the main menu screen.

If system interface is locked, refer to section 3.3 to unlock by entering your password.

In Main Menu mode, you can make settings for Parameter, Record Search, Device, System, Advanced and Shutdown.

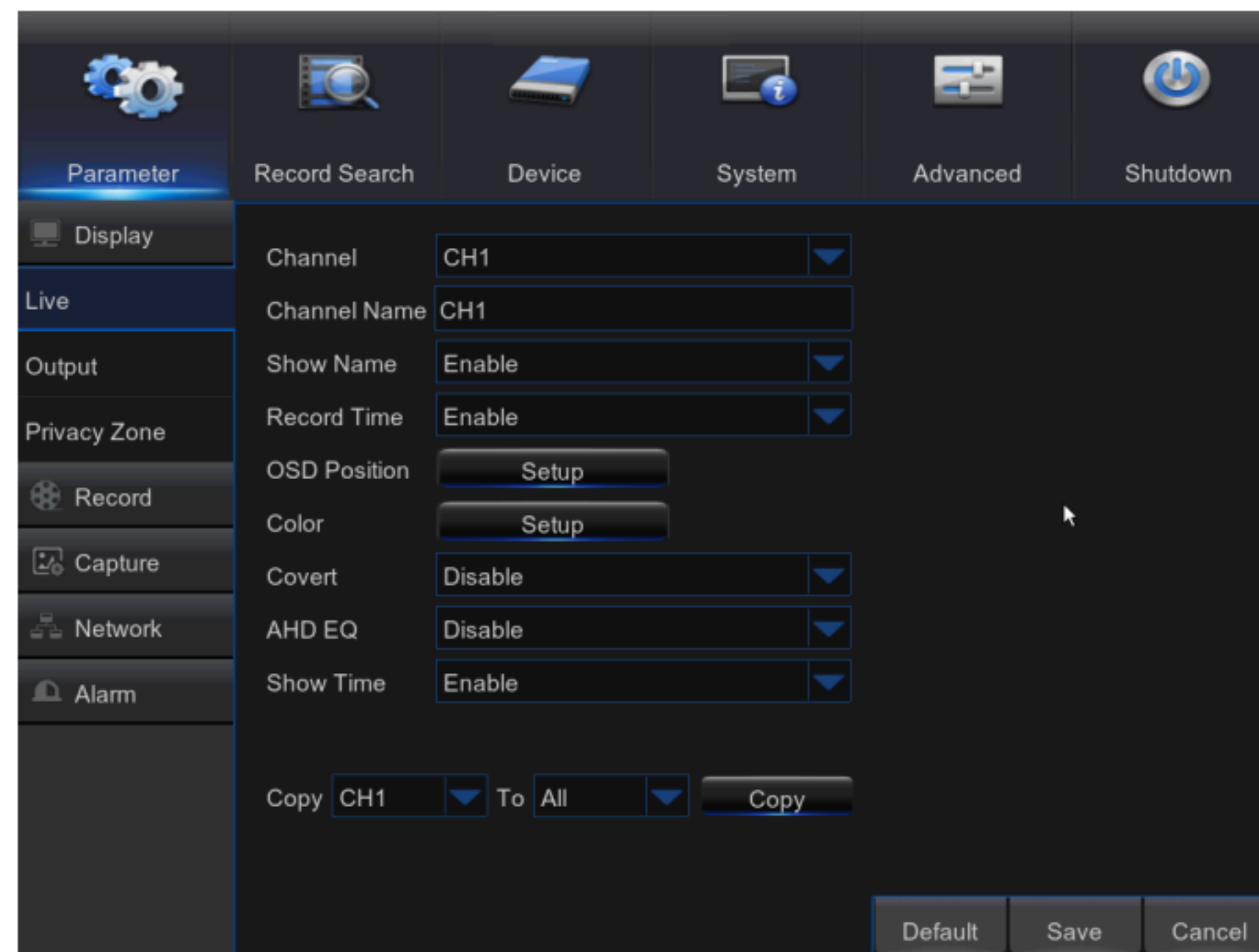

3.2.1 Parameter

1. Live

Go to “Main Menu”→“Parameter”→“Display”→“Live”

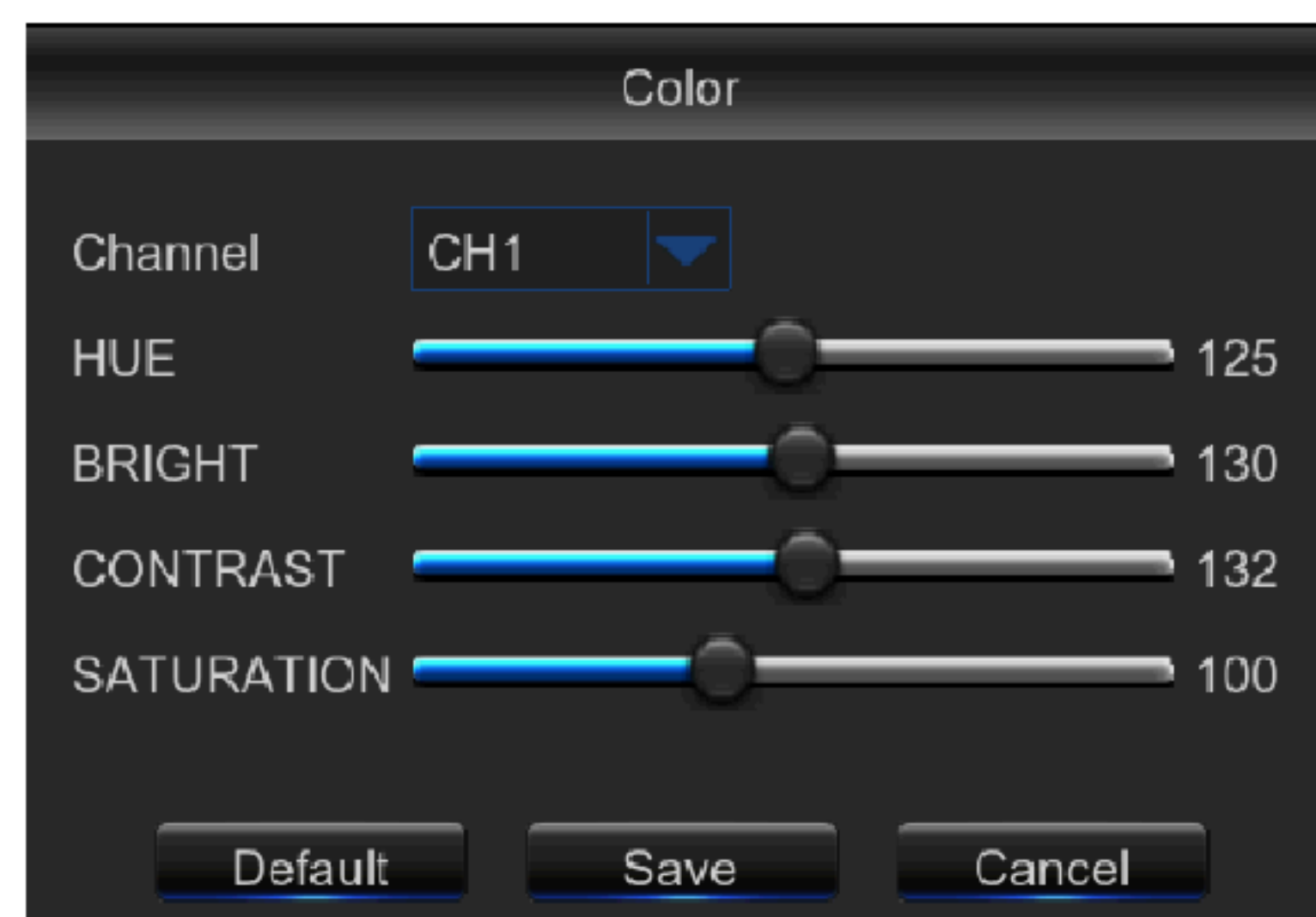
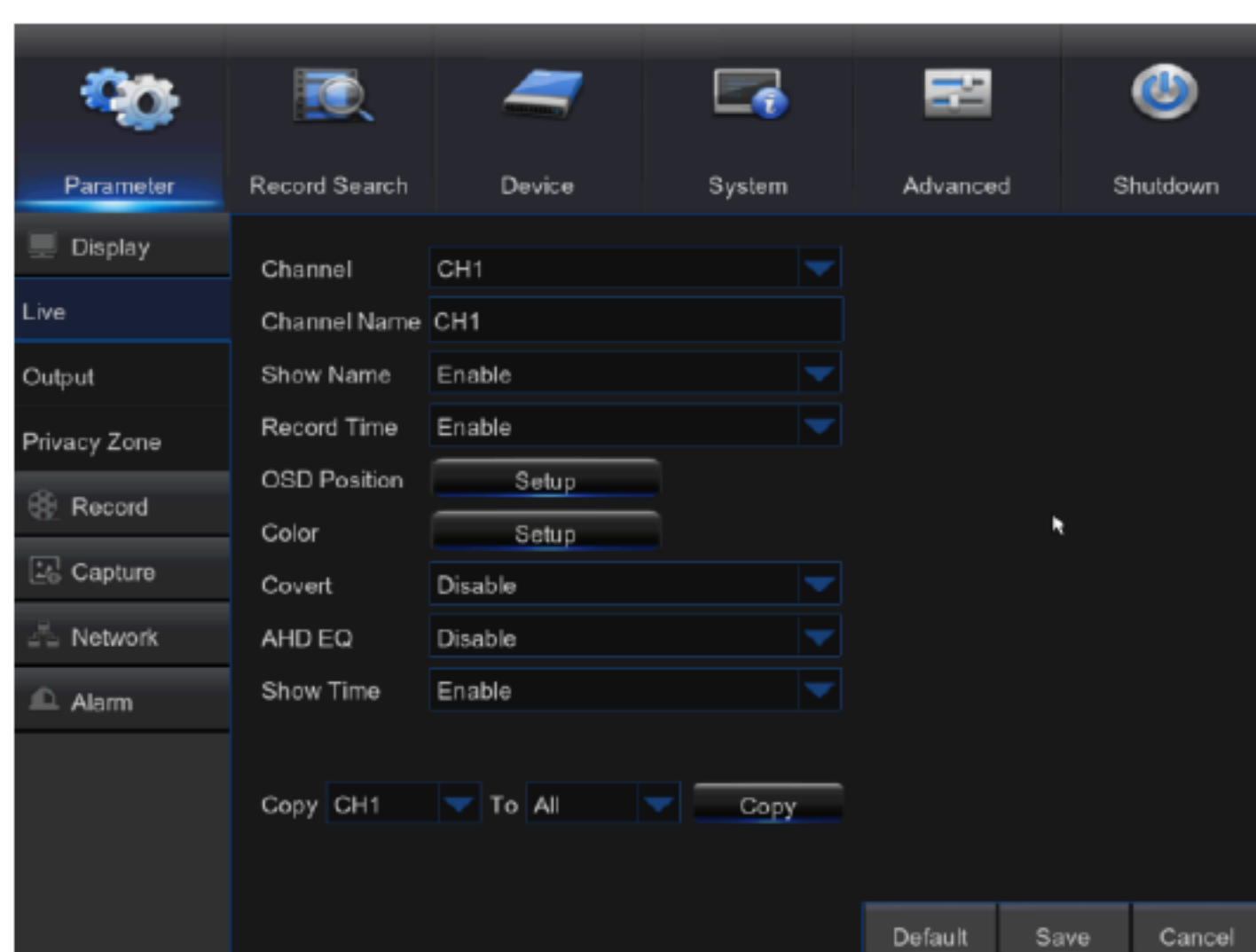

- **Channel:** Select the channel in the drop-down list.
- **Channel Name:** Channel name, support up to 8 characters.
- **Show Name:** Showing Channel name
- **Record Time:** Enable or disable displaying system time in recording.
- **OSD Position:** Adjustment the position of channel name and time display
- **Color:** Click “Setup” to access the color settings
- **Covert:** Enable/Disable Video hiding.
- **AHD EQ:** Switch of AHD signal equalizer.
- **Show Time:** Enable or disable the time displayed in the live interface.
- **Copy:** Copy the parameters in the channel to any other channel or all channels.

Adjust the brightness, hue, contrast and saturation of the image in selected channel in “Live” interface.

Note: To modify the parameter value in sub-menu and make it effective, click “**Save**” after modification and a dialog box with message “Save parameters successful! ” will pop up. Click “OK” in the interface, then “**Exit**” to exit the menu. If you want to cancel the modification, click “Cancel” to exit.

Use Virtual Keyboard

Virtual keyboard window will be displayed for input.. Click on the desired characters to apply them. Press <Shift> to switch to input of upper-case letters.

Press <Shift> again to switch to input of special characters. The virtual keyboard is used in the same way as with physical keyboard.

For input of password, use letters and special characters other than <\> and <">.



2. Output

Go to “Main Menu”→ “Parameter”→ “Display”→ “Output” to enter into the interface.

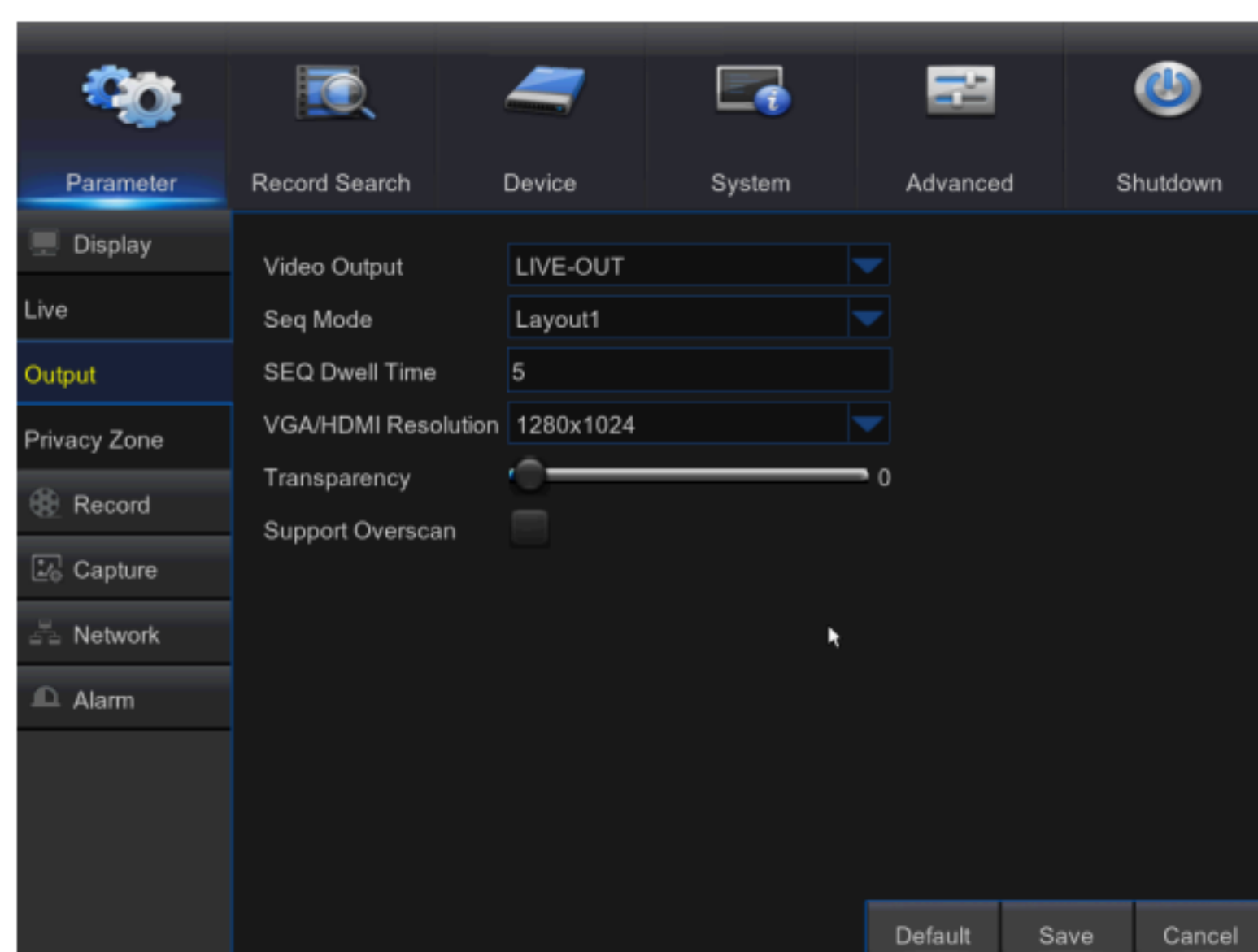

- **Video Output:** Live Output
- **Sequence Mode:** layout1, layout4, layout6
- **SEQ Time:** Sequence time is set 5 seconds by default. User may set it as required up to 300 seconds
- **VGA/HDMI Resolution:** For VGA output or HDMI output, the optional resolution includes 1024×768, 1280×1024, 1440×900, 1280×720, 1920×1080
- **Transparency:** Adjust menu transparency in the range of 0-128.
- **Support Overscan:** Support HDMI overscan

3. Private Zone

Go to “Main Menu” → “Parameter” → “Display” → “Private Zone” to enter into the interface.

Privacy Zone is to block certain area(s) in the camera’s field of view from recording in the selected channel.

1. Select the number of the zone(s) to be blocked (maximum of 4 zones can be set for single channel)
2. Click “Setup” to adjust the position of the zone.
3. After finish setting, right click the mouse to return to the “Privacy Zone” page.
4. Click “Save” to save the setting.

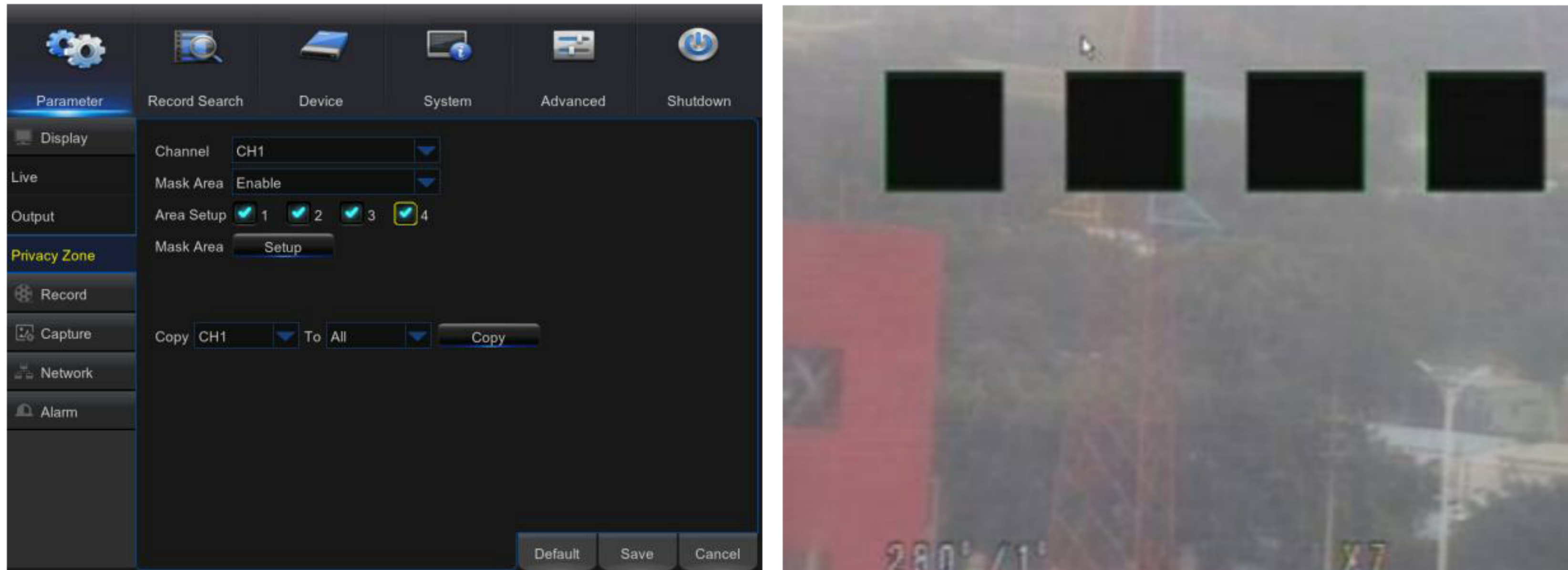

4. Record

Go to “Main Menu”→“Parameter”→“Record”→“Record” to enter into the interface.

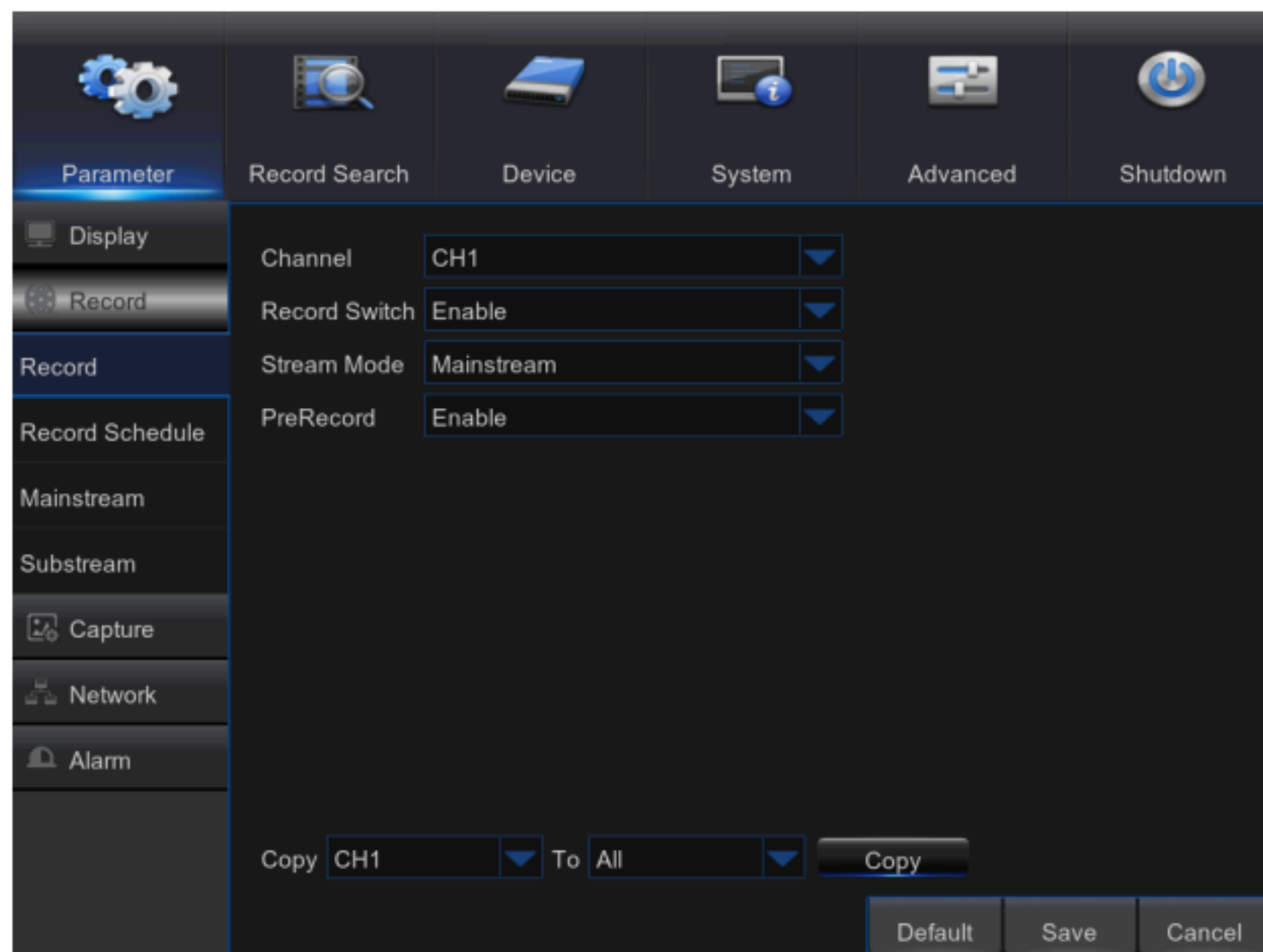

- **Channel:** Set the desired channel in the drop-down menu
- **Record Switch:** Enable/disable record
- **Stream mode:** Mainstream/Substream
- **Pre Record:** Enable to pre-record motion detection record.

5. Record Schedule

Go to “Main Menu” → “Parameter” → “Record” → “Record Schedule” to enter recording schedule for the DVR.

Schedule interface:

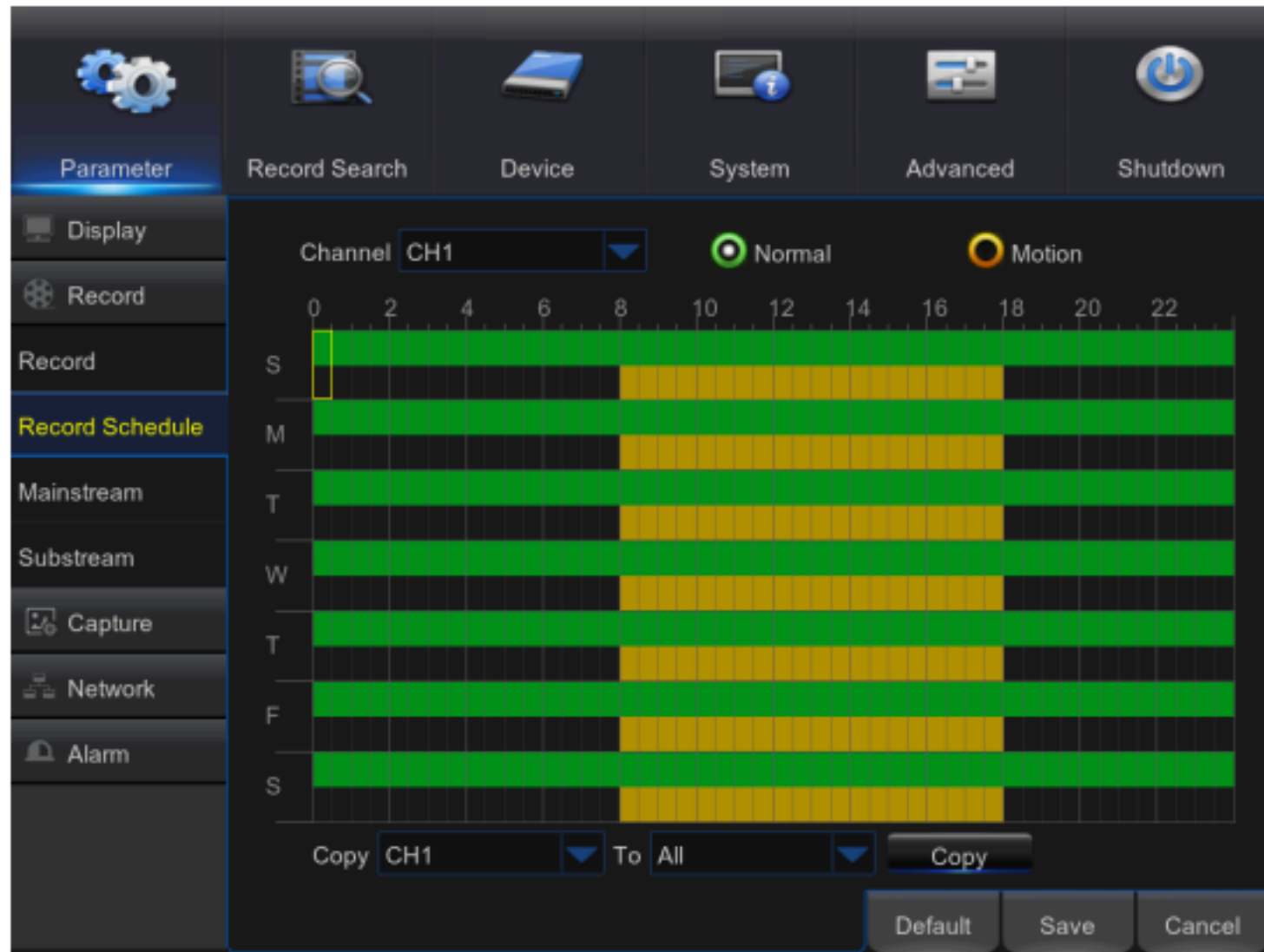

Select the channel and the date to be set. One week's schedule can be set.

The record schedule of the current channel can be copied to any other channel or all channels.

Note:

1. In the Record menu and Record Search menu, when no colors are presented, it means there are no recordings during that time;

6. Mainstream

Go to “Menu” → “Parameter” → “Record” → “Mainstream” to enter into the menu interface.



- **Channel:** Set the desired channel in the drop-down menu.
- **Resolution:** NTSC 960x480/1280x720/1920x1080
- **Note:** In AHD series, the supported record resolution includes 960H/720P/1080P;
- **FPS:** NTSC:1-30FPS
- **Bitrate Control:** Select either constant (CBR) / variable (VBR) bit rate.
- **Bitrate Mode:** Select default/custom bit rate.
- **Bitrate:** Bit rate setting
- **Audio:** Enable audio recording.
- **Resolution:** Only in 1920x1080 resolution Encode FPS is available.
- **Encode FPS:** Encoding frame rate 10~15 fps.
- **Live View:** Adjusted automatically based on frame rate.

7. Substream

Go to “Menu” → “Parameter” → “Record” → “Substream” to enter into the menu interface

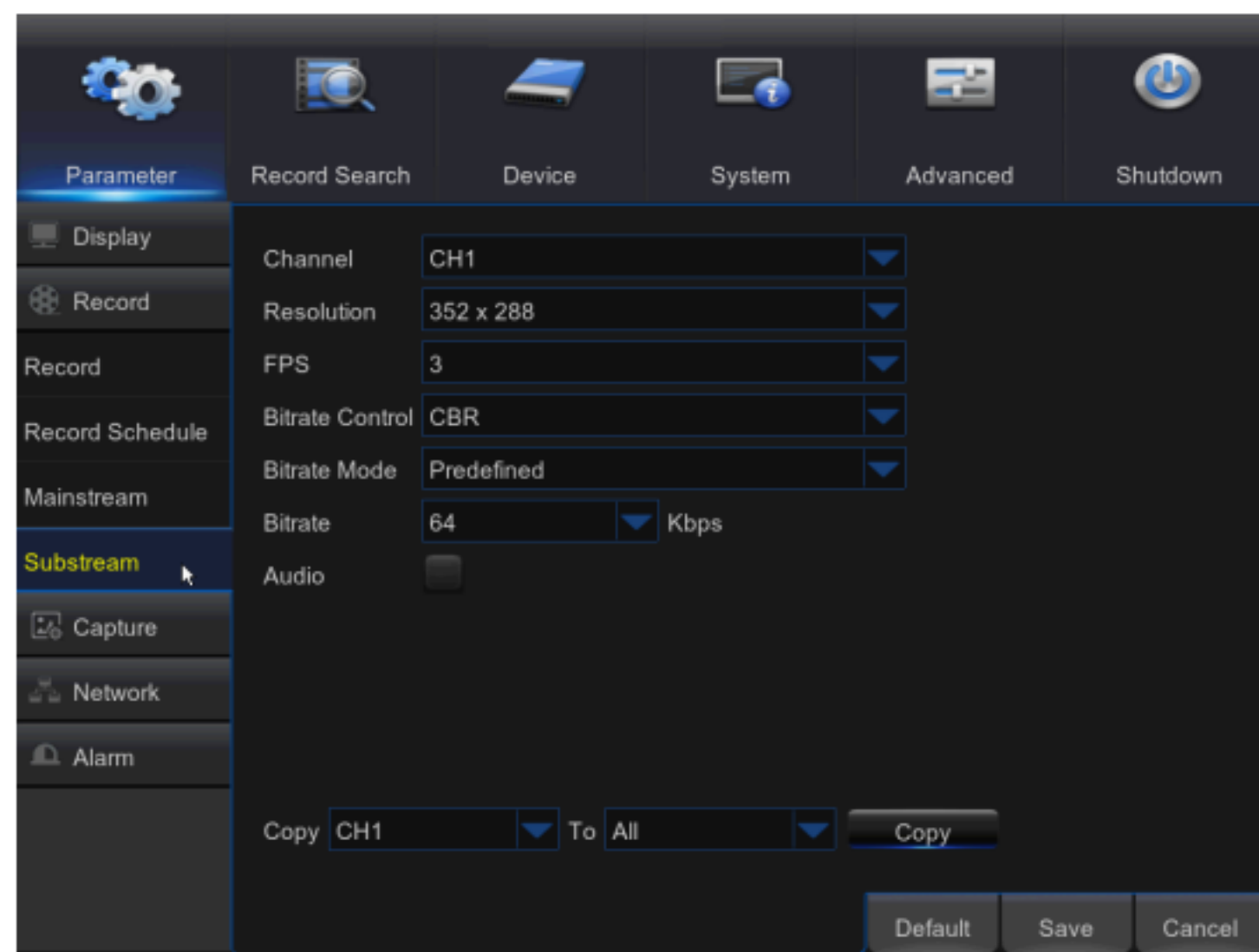

- **Channel:** Select recording channel
- **Resolution:** NTSC352x240/PAL352x288
- **FPS:** Select recording frame rate.
- **Bitrate Control:** Select either constant (CBR) / variable (VBR) bit rate.
- **Bitrate Mode:** Select default/custom bit rate.
- **Bitrate:** Bit rate setting
- **Audio:** Enable audio recording.

8. Capture

Go to “Main Menu”->“Parameter”->Capture.

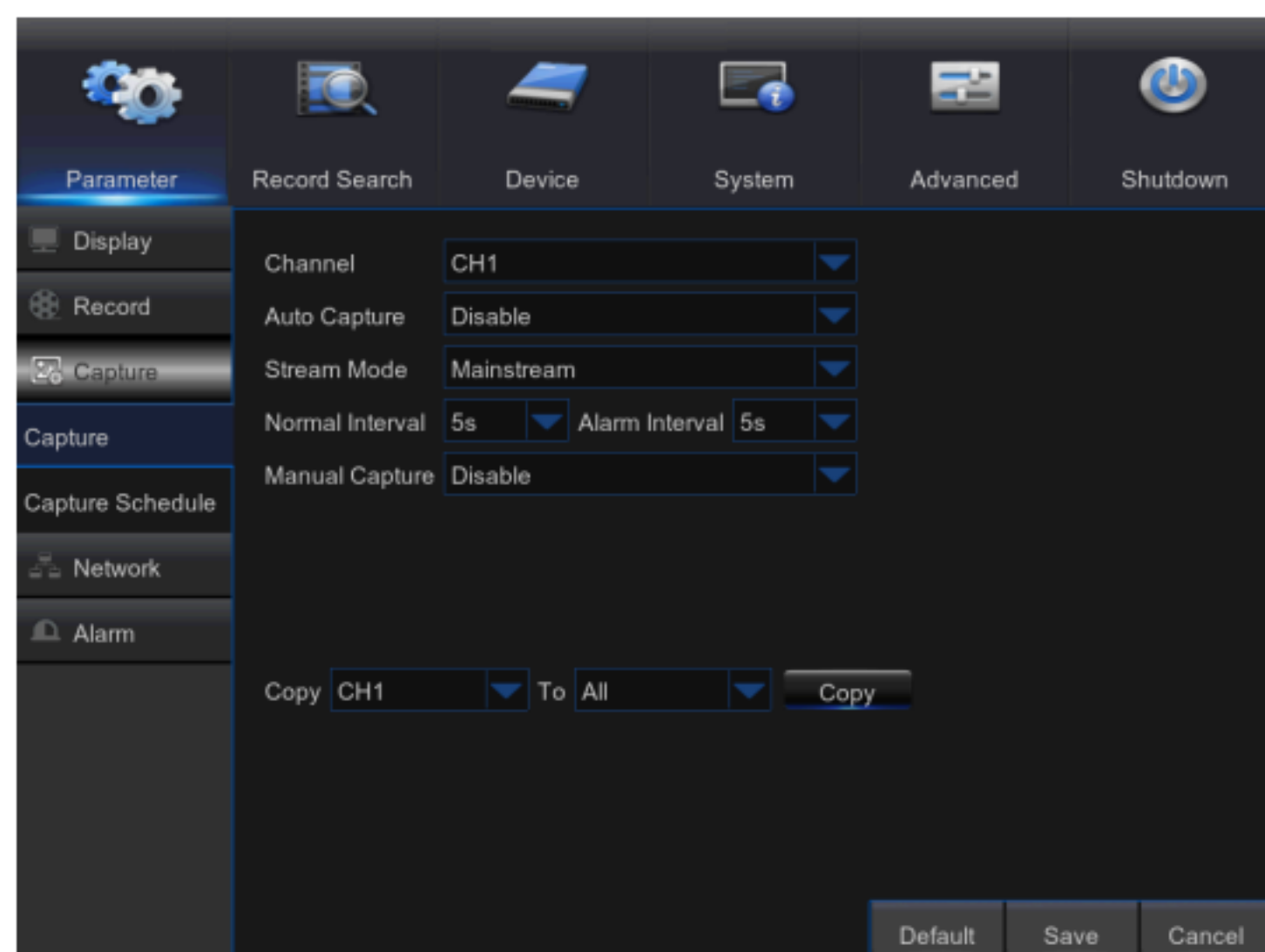

- **Channel:** Select capture channel
- **Auto Capture:** Enable/Disable auto capture.
- **Stream Mode:** Mainstream/Substream
- **Normal Interval:** 5s/10s/30s/1min/10min/30min/1h
- **Alarm Interval:** 5s/10s/30s/1min/10min/30min/1h
- **Manual Capture:** Enable/Disable manual capture

Note: You can click on the icon  in the live window to manually capture the image with your mouse.

9. Capture Schedule

Go to "Main Menu" -> "Parameter" -> Capture Schedule.

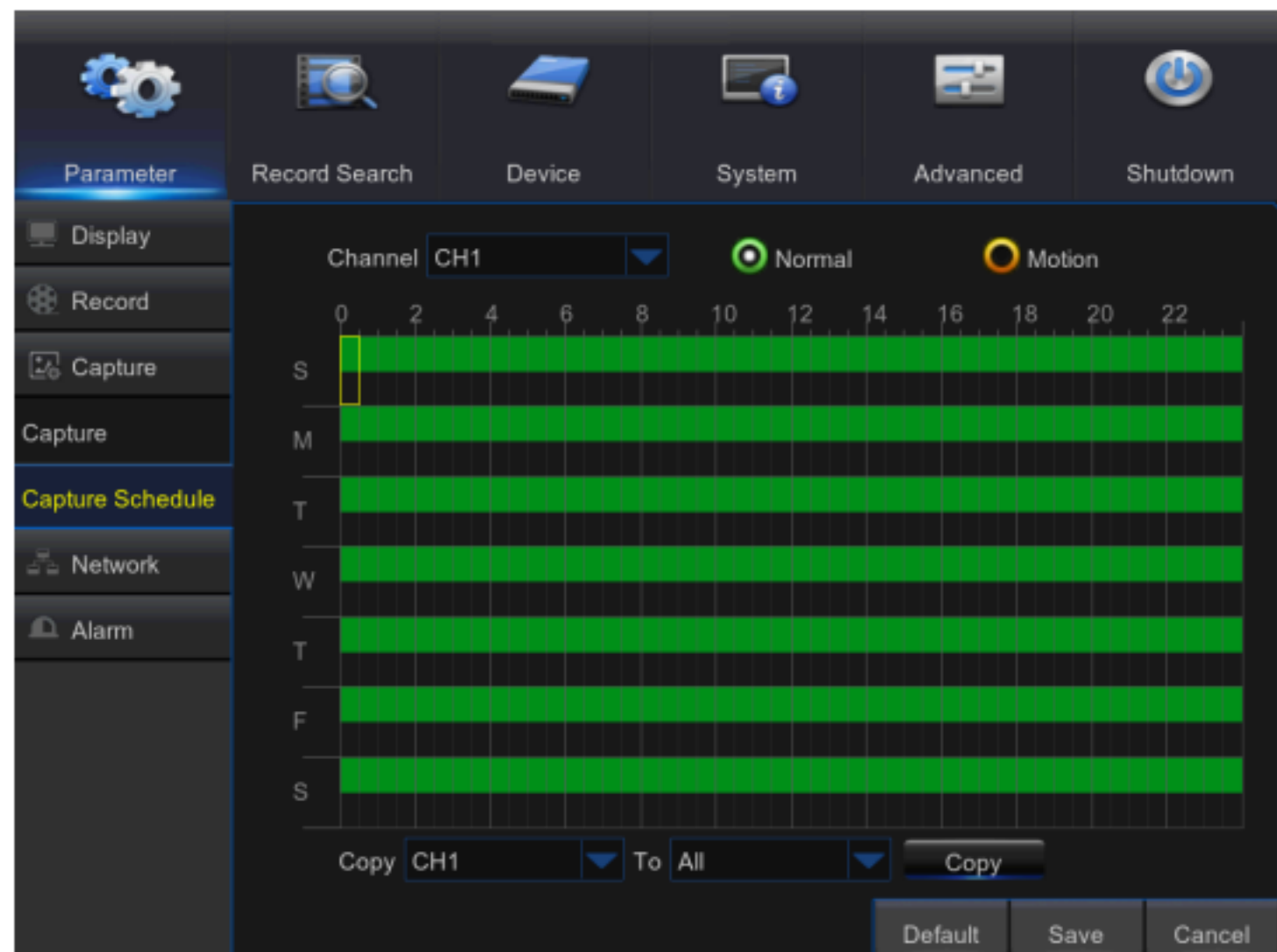

- Normal: Conventional capture setting
- Motion: Motion detect capture setting

10. Network

Go to "Main Menu" → "Parameter" → "Network" → "Network" to enter the interface.

Select the network connection option (PPPOE, DHCP, Static) to set the port. User can view and do the recording, playback or backup of the video remotely.

Take DHCP as an example. In this mode, the router automatically assigns IP address for the DVR. After restarting the DVR or DHCP server, the IP address obtained by the DVR may be different. As a result, you need to check the IP address and port numbers before remote access to the DVR every time. The operation procedure is as follows:

1. Select DHCP, click Save and restart the DVR. Input Client Port and HTTP Port (the two ports must be different).
2. Remotely visit the DVR by using IP address plus HTTP port through web browsers.
http://Public network IP: HTTP port number (such as 00080)
http:// Intranet IP: HTTP port number (such as 00080) (Only available in the same LAN)

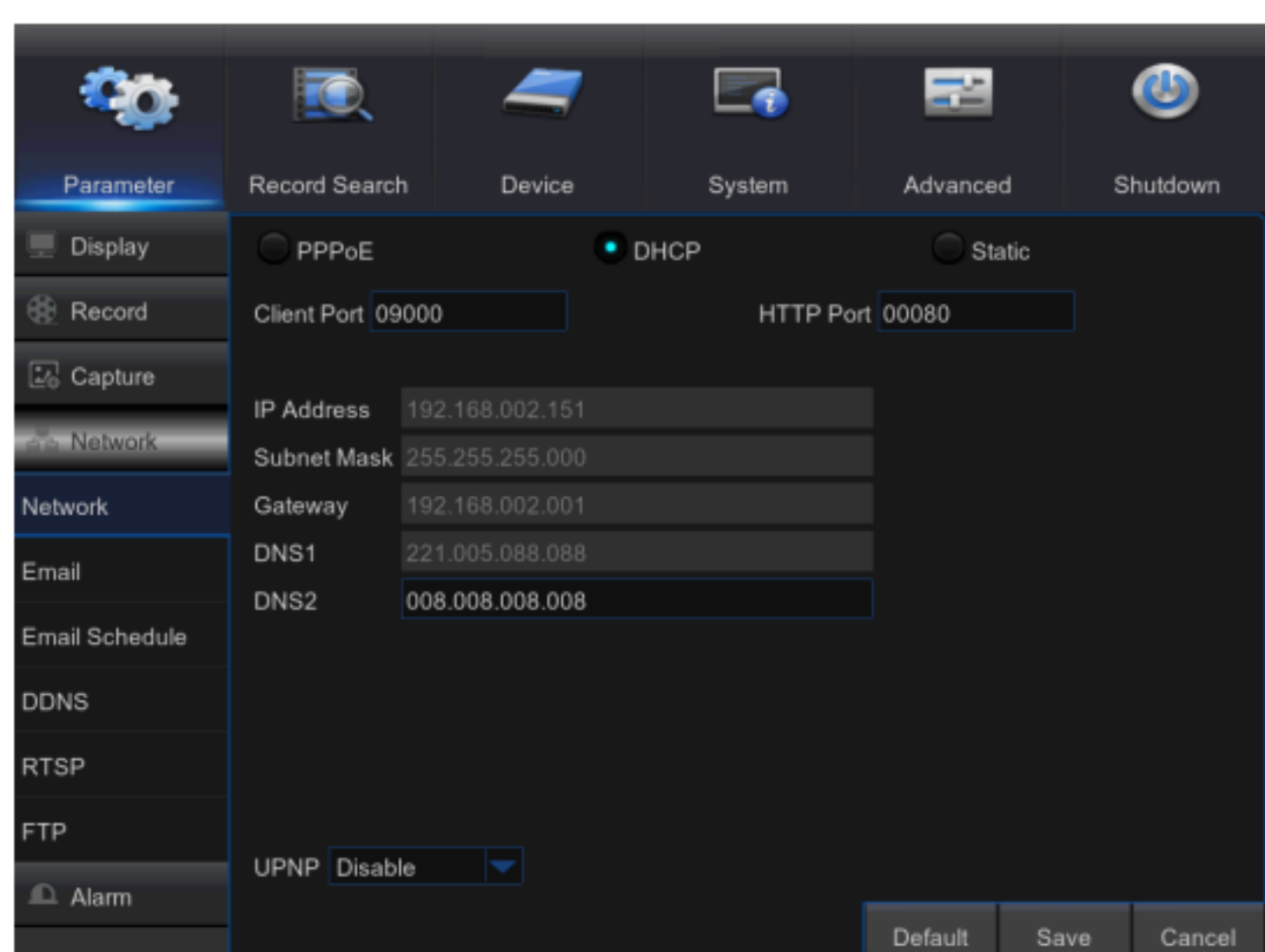

For PPPoE, Static and DHCP, after setting the IP address for the DVR, the extranet port shall be mapped in the router before visiting DVR through public network.

Note: Save the setting to apply the changes made. If there are multiple DVRs in a LAN, make sure their MAC addresses are different.

11. E-mail

Go to “Main Menu” → “Parameter” → “Network” → “Email” to enter into the menu interface. Receive or Send DVR alarm Email and set parameters like Email address, SSL, Email Enable, and Interval.

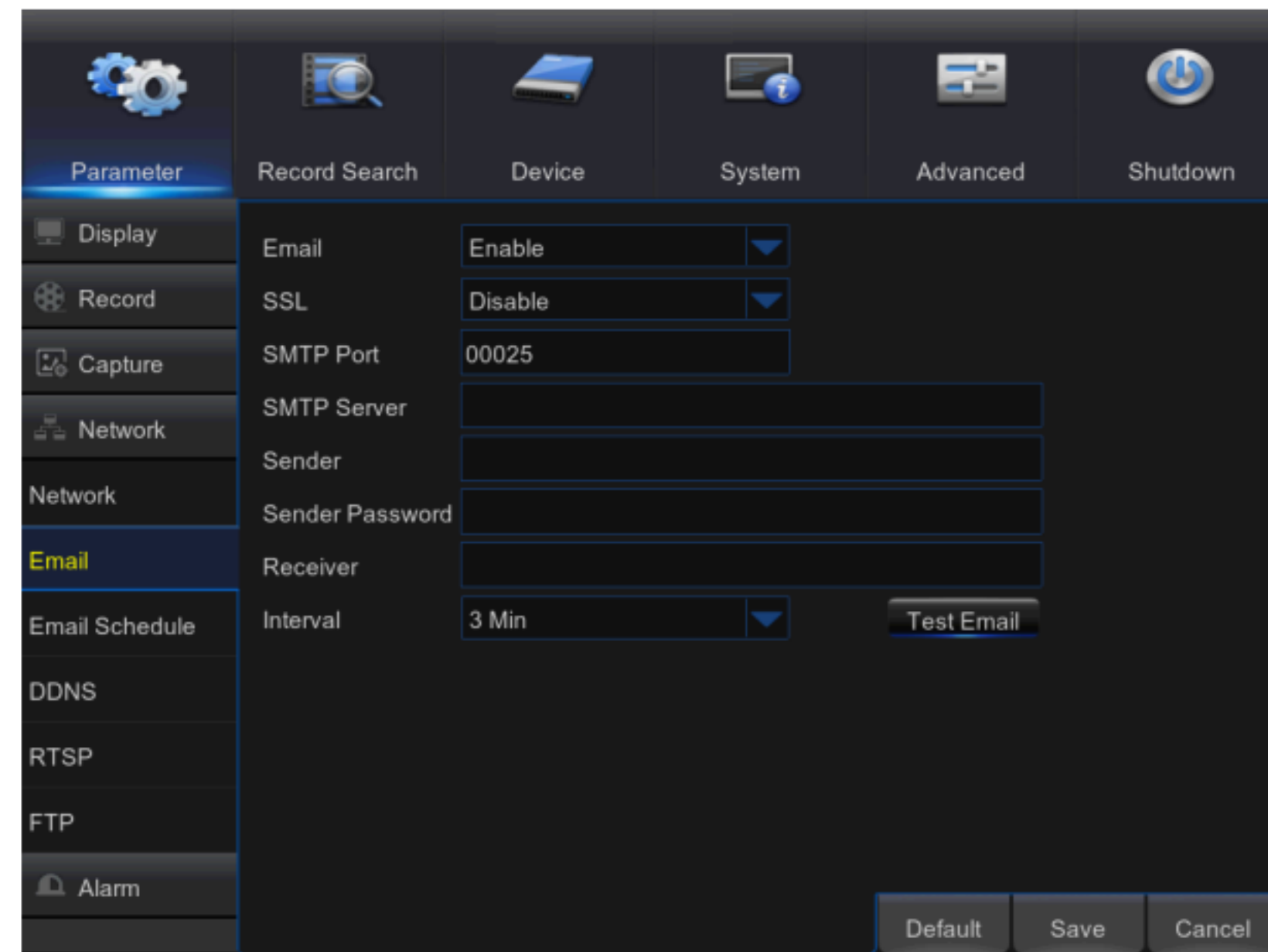

- **SSL:** This is an industry standard transport protocol that establishes an encrypted link between the web server and browser. This link ensures that all data that passes between the web server and browser remains private and integral. If the setting is incorrect, check you mail server's SMTP port
- **SMTP Port:** The mail sending port used by SMTP (Simple Mail Transfer Protocol) server is generally Port 25, or Port 465.
- **SMTP Server:** Enter the address of the server for the mailbox in use.
- **Sender address:** Sender's mail address, which must correspond to the server used. For example, mailbox "aaa@gmail.com" should correspond to server "smtp.gmail.com".
- **Recipient address:** Recipient's mail address, used to receive alarm image and message from DVR side. If system alarms continually and sends email images frequently, save the images to another location or remove them, so as to avoid excessive space occupation and thereby affect your normal use of mailbox.
- **Time interval:** A mail will be sent every three minutes by default. If the time interval for mail notification is set too short, email server may deem mails as junk mails, so they cannot be transferred normally.

Mailbox Setting:

For example, if you are using Gmail, sign in to the GMAIL mailbox. <https://mail.google.com>

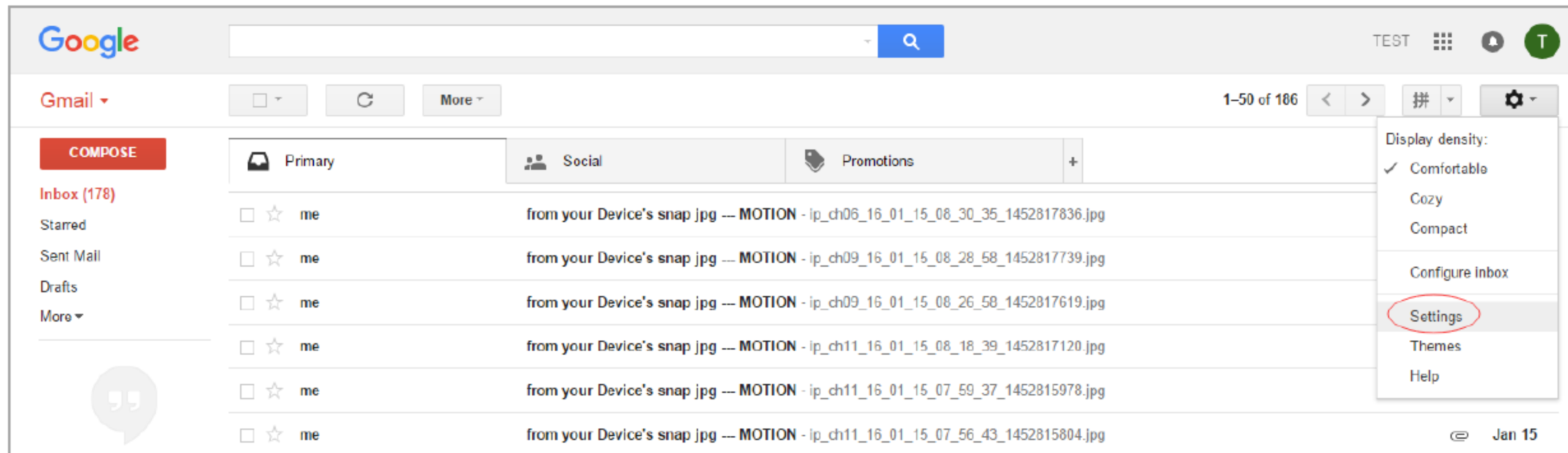

Click on “settings--Forwarding and POP/IMAP”

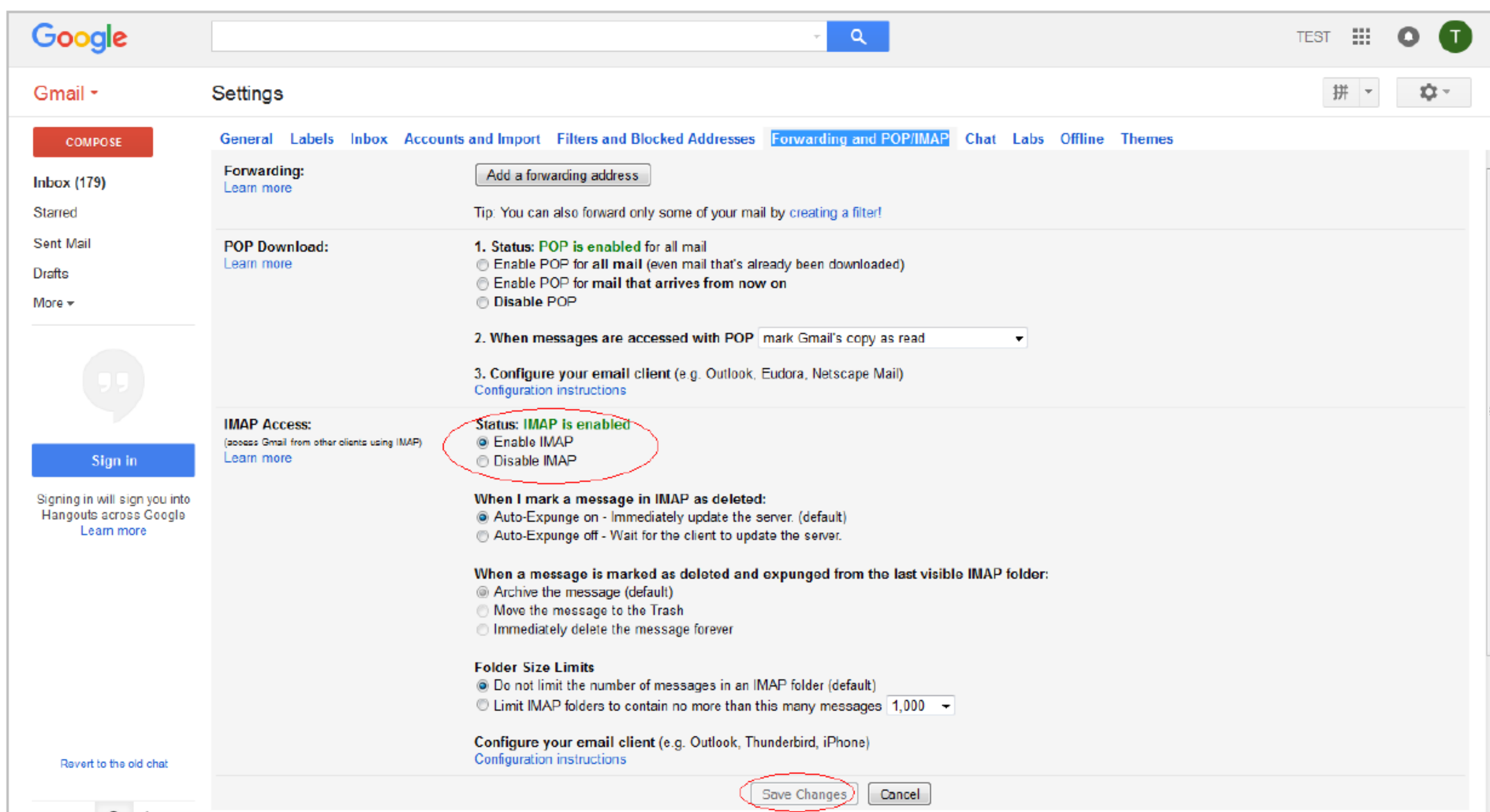

Click on “Enable IMAP--Save Changes”

12. E-mail Schedule

Go to “Main Menu” → “Parameter” → “Network” → “E-mail Schedule” to make Email schedule.

Select the channel and the date to be set. One week’s schedule can be set.

The record schedule of the current channel can be copied to any other channel or all channels.

Note:

1. Green stands for Motion: Email will be sent in case of object motion;
2. Red stands for Exception: Email will be sent in case of exception, e.g. No Space on Disk, Disk Error, Video loss, etc.

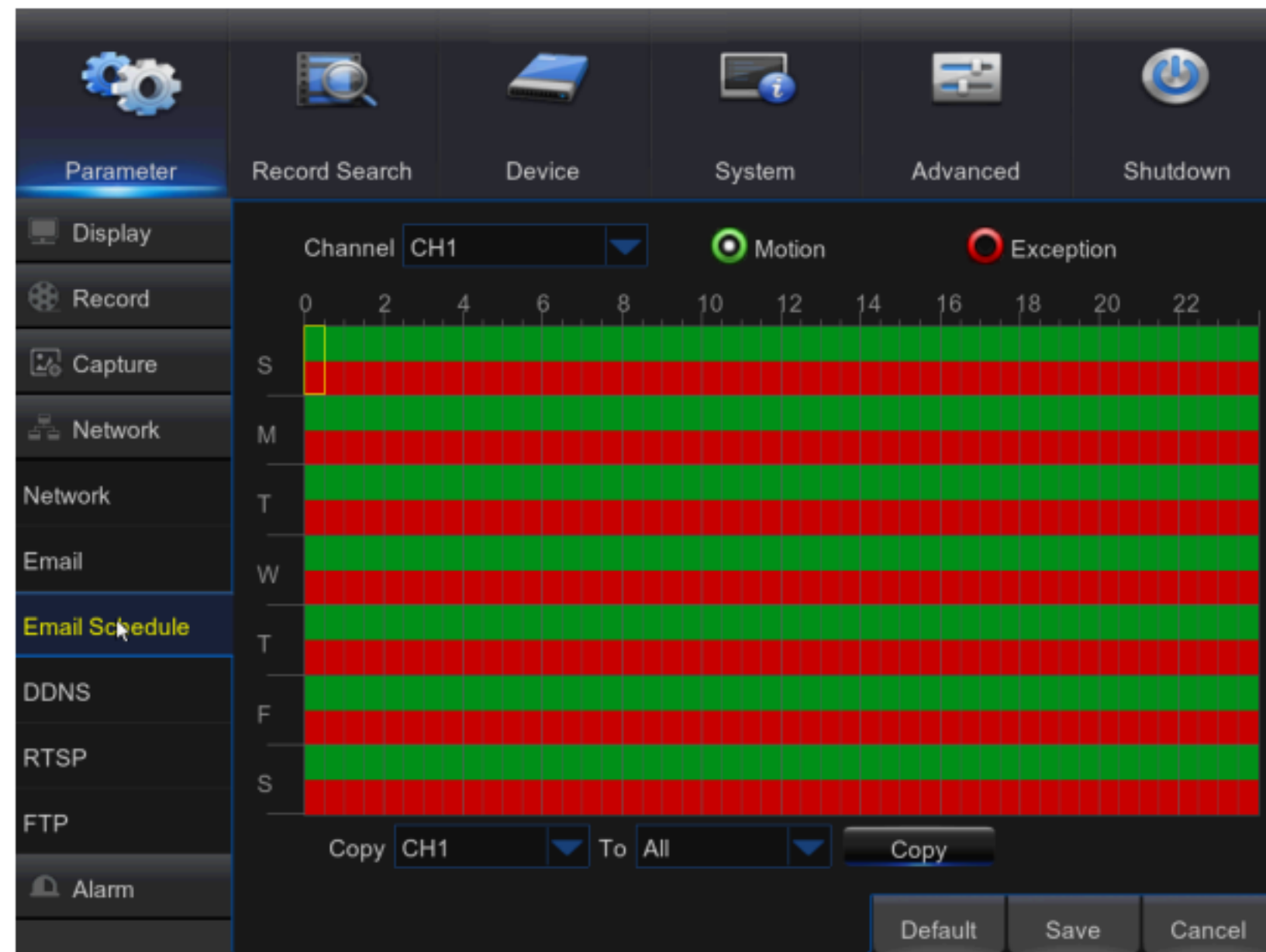

13. DDNS

Go to “Main Menu” → “Parameter” → “Network” → “DDNS” to enter into the menu interface.

User may set DDNS in any one of the above 3 network connection types after applying dynamic domain service. User may remotely access the DVR through domain by using browser in the form of `http://applied domain: mapped HTTP port number`. When using DDNS domain name to access the DVR, user must confirm that the port can be normally connected to current IP on the public network and the settings for server address/host name/user/password/setting should be consistent with the DVR local setting.

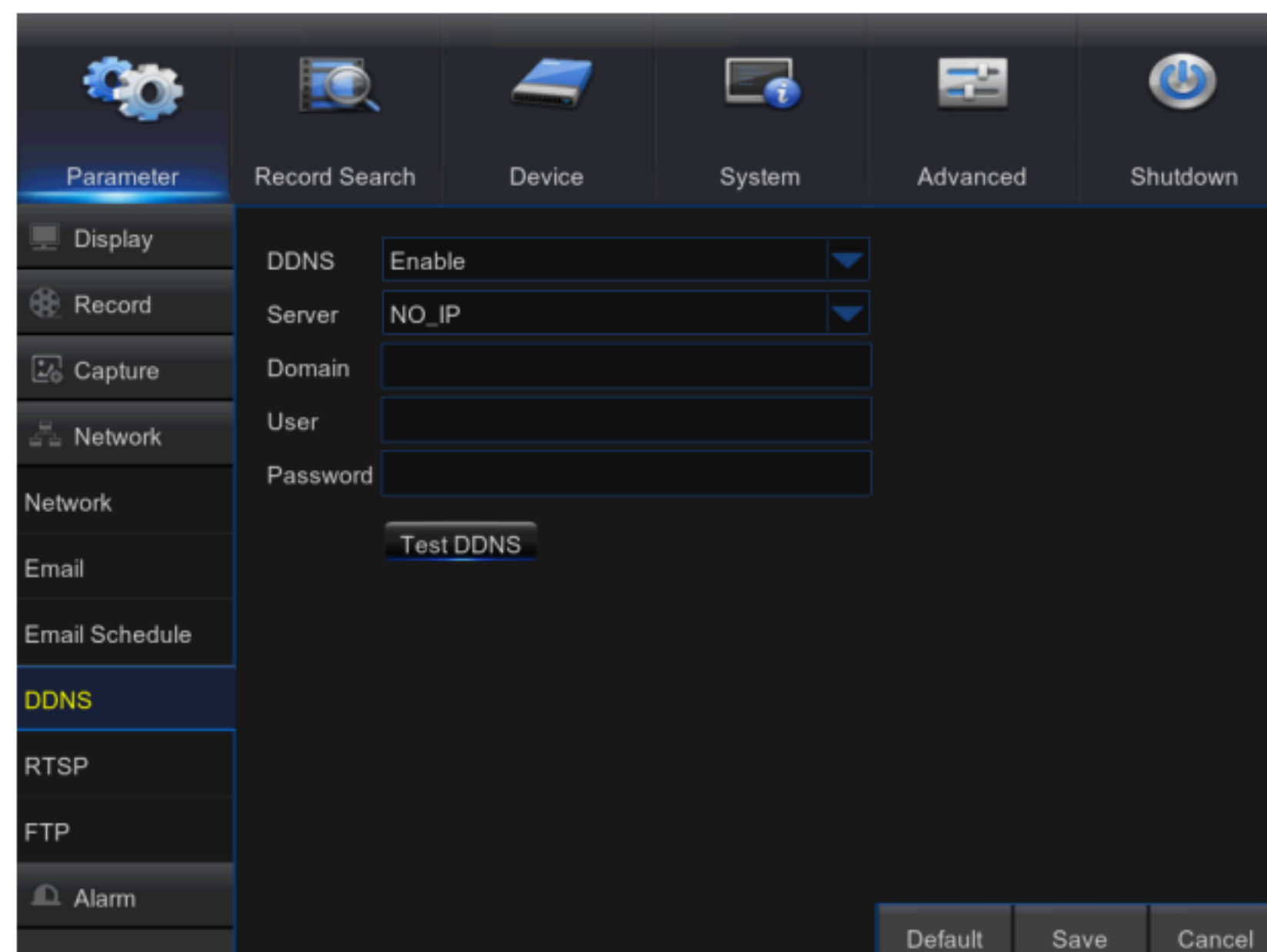

- **Server address:** Select dynamic domain name server provider. Available domain name servers (DDNS_3322, DYNDNS, NO_IP, CHANGEIP, DNSEXIT)
- **Host name:** dynamic domain name of the host obtained from dynamic domain name service provider upon registration, for example, dvr2016.no-ip.org
- **User Name:** The user name registered upon application for dynamic domain name.
- **Password:** The password set upon registration.

Click on “Test DDNS”. If connection succeeds, it will be indicated that "DDNS Test is Successful!"

Perform remote access to the DVR by using dynamic domain name, for example, <http://dvr2016.no-ip.org>: HTTP port number (e.g. 19010)

14. RTSP

Go to “Main Menu” → “Parameter” → “Network” → “RTSP”

Set User Name and Password to view video by PC software VLC.

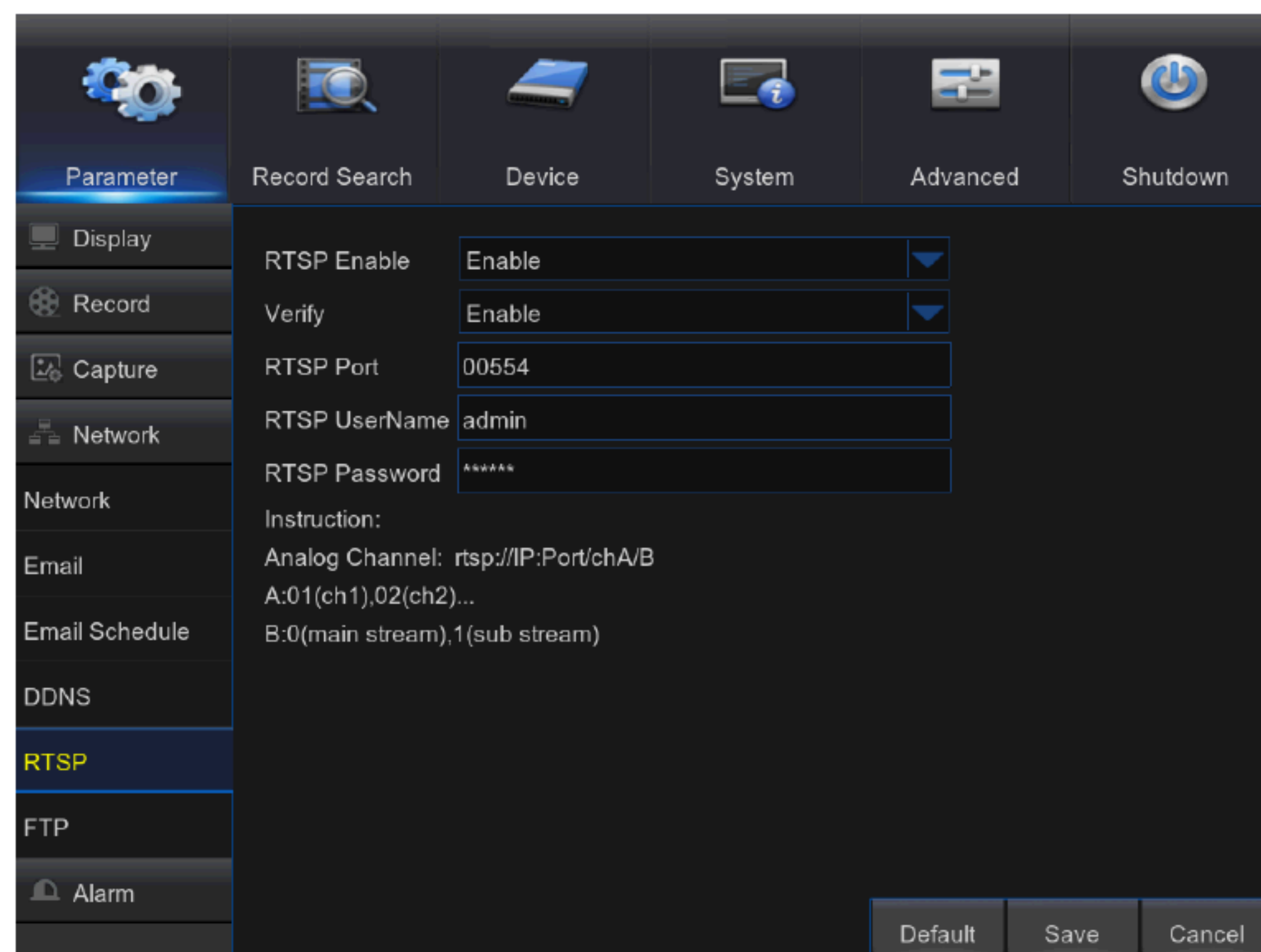

- **RTSP Enable:** Enable/Disable
- **Verify:** Enable/Disable
- **RTSP Port:**00054
- **RTSP User Name:** admin
- **RTSP Password:**111111
- **Analog Channel:** rtsp://IP:Port/chA/B
- **A:**01(ch1),02(ch2)
- **B:**0(main stream),1(sub stream)

Follow the instruction to input IP and port to preview video.

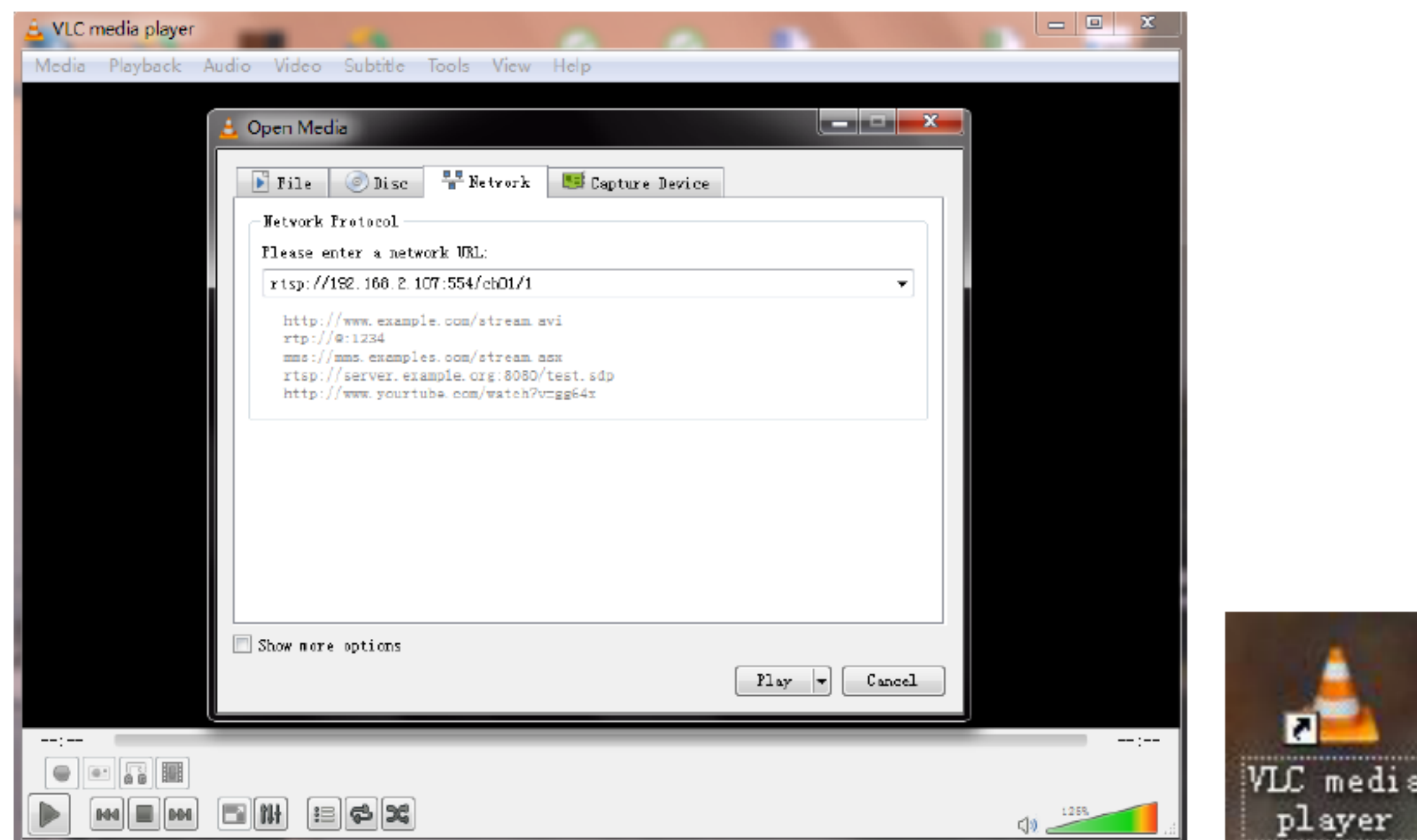

15. FTP

Go to “Main Menu” → “Parameter” → “Network” → “FTP”

Set IP, User Name and Password to view the captured image in the server.

Enter into <ftp://relay.anw.ru/> and input User Name and Password to view the captured images.

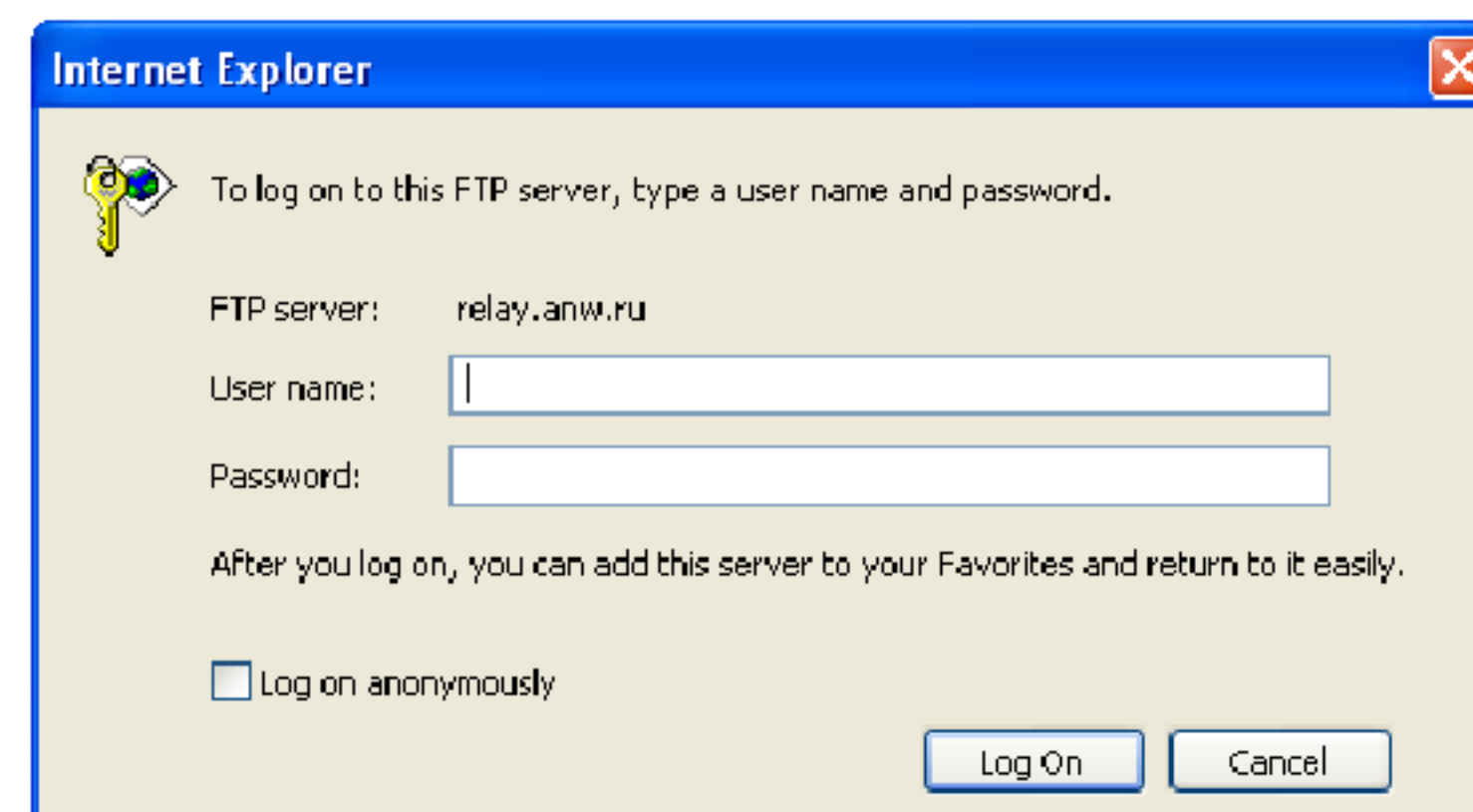
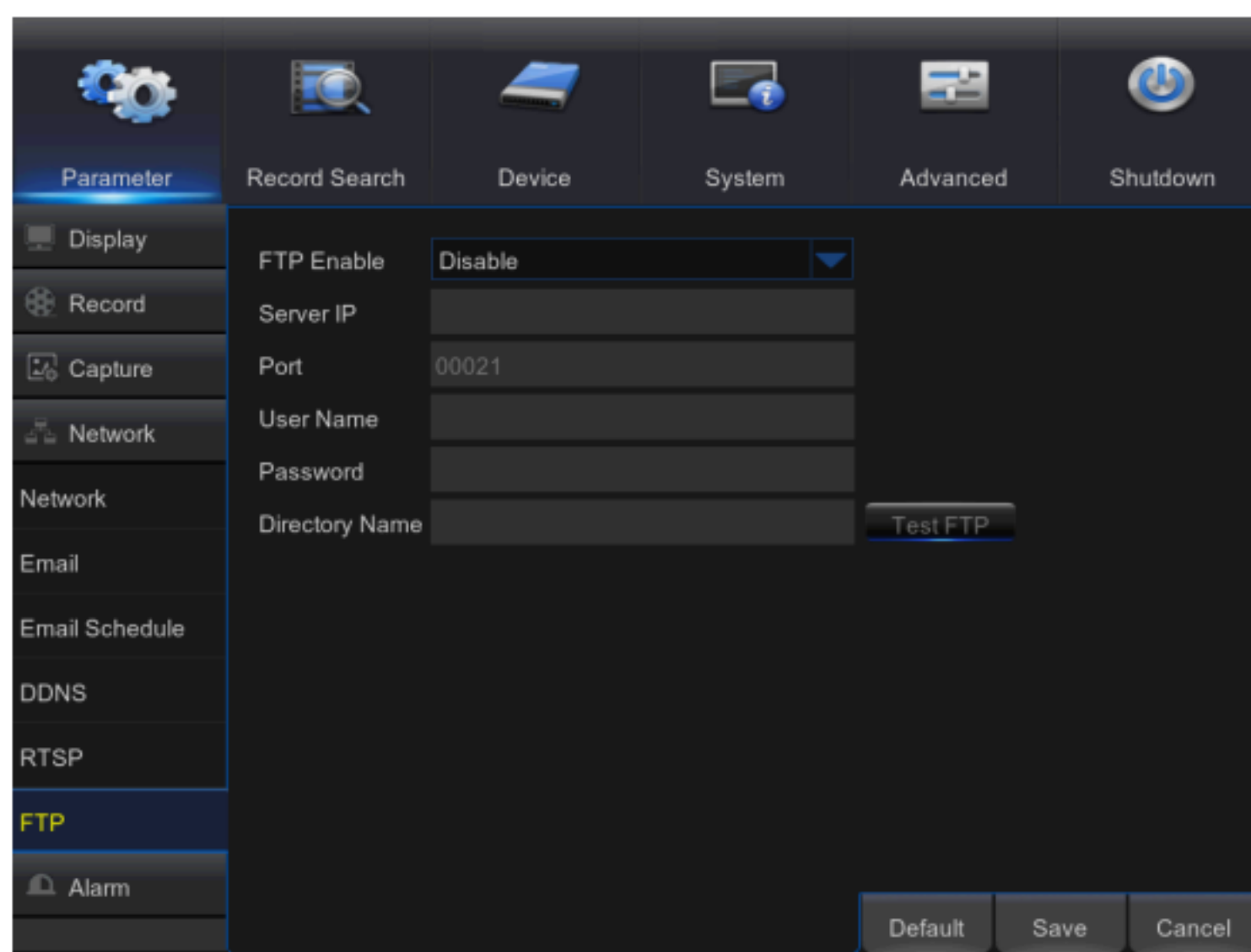

- **FTP Enable:** Enable/Disable
- **Server IP:** Server IP address
- **Port:** Port
- **User Name:** User Name
- **Password:** User password
- **Directory Name:** Directory name

Note

It is recommended to use FTP software Filezilla with open source free of charge. Use of other FTP software may cause image distortion.

16. Motion

Go to “Main Menu” → “Parameter” → “Alarm” → “Motion” to enter into the interface.

- **Channel:** Enable or disable Motion function.
- **Sensitivity:** Support 1-8 level, 8 is the highest level.
- **Buzzer:** When detecting object moving, buzzer makes alarms (disable, 10 seconds, 20 seconds, 40 seconds and 60 seconds).
- **Show Message:** Messages will be displayed on the screen when moving object is detected and alarms are made.
- **Send Email:** When moving object is detected, send Email to the specified Email address.
- **Full Screen:** When moving object is detected, messages will be displayed in full screen.
- **Post Recording:** After the alarm finishes, the duration time of the alarm recording can be set as 30 seconds, 1 minute, 2 minutes and 5 minutes.

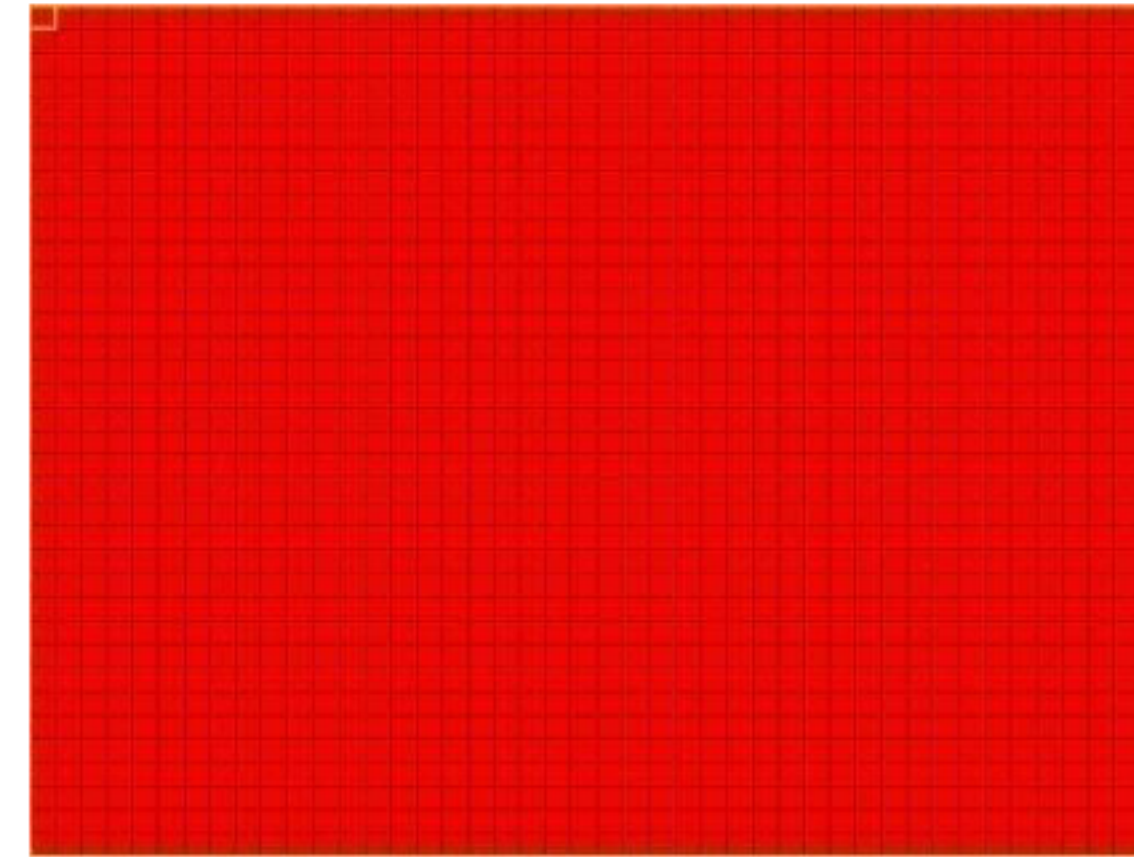
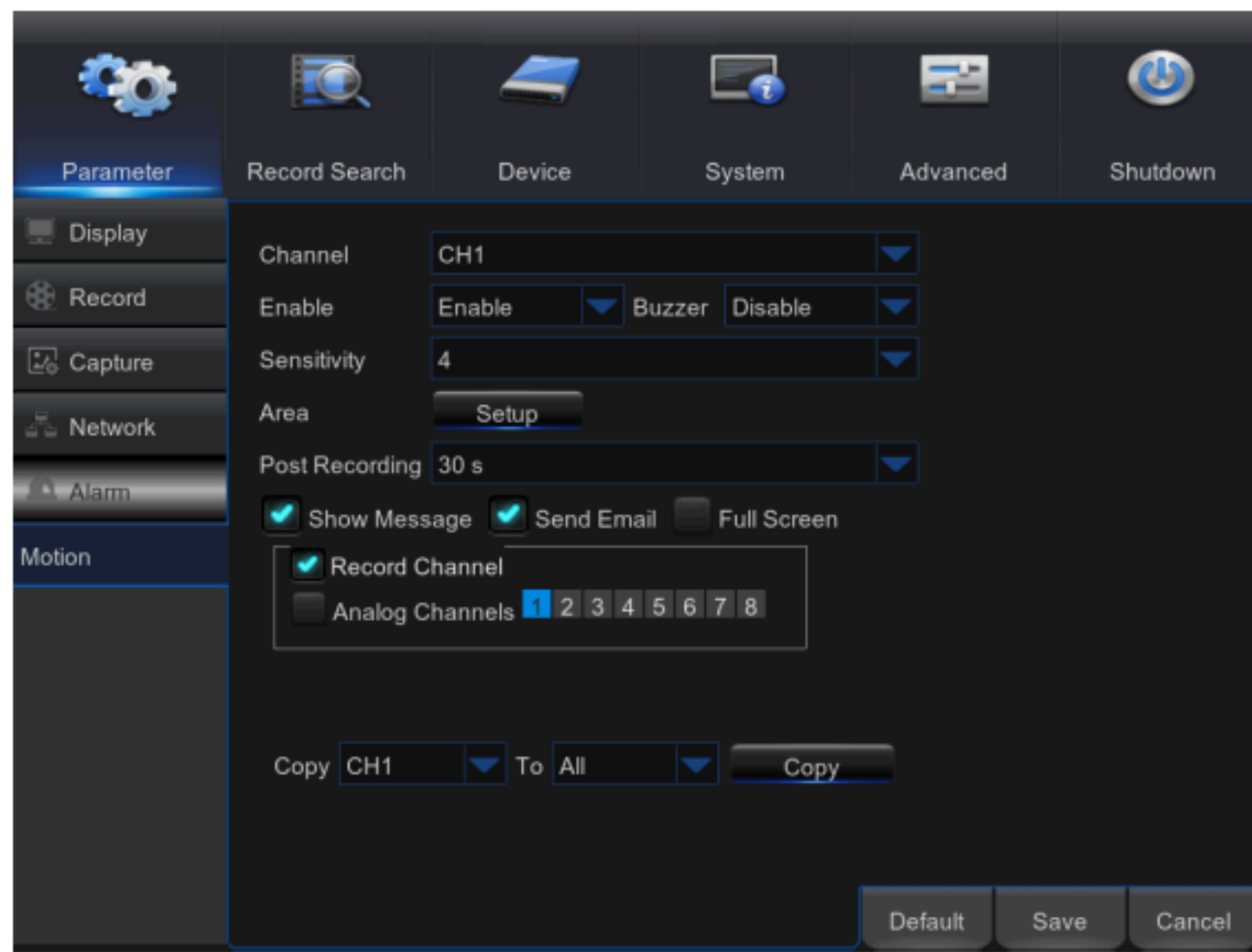

- **Area:** Click it to enter into the interface to set the motion detection area to be monitored intensively.
A single channel is divided into 15×12 (PAL) or 15×10 (NTSC) configurable grids. The red grids indicate that the motion detection in the area is enabled, white semitransparent ones indicate that the motion detection in the area is disabled. After setting is completed, right click the mouse button to return and click Save to make the parameter setting effective.
- **Record Channel:** When object motion is detected, the record channel setting will be activated.
- **Copy:** Allow you copy current channel parameters to any other channel (setting of record channel cannot be copied).

Alarm Type	Functions & Descriptions
Video Loss	When the DVR fails to receive video signals due to some problems (camera damage, line dropout or damage, power failure), the alarm will appear.
Motion Detection	When camera detects object moving, alarm will be activated. Sensitivity is subject to the actual application environment test. Sensitivity is adjusted according to the sensitivity of moving object detection and parameters are modified by combining the area setting .
HDD Status	Alarm will appear when the HDD does not work due to damage, power failure, HDD auto-overwrite off and insufficient space.

3.2.2 Record Search

1. General

Go to “Main Menu” → “Record Search” → “Record Search” to enter into the interface.

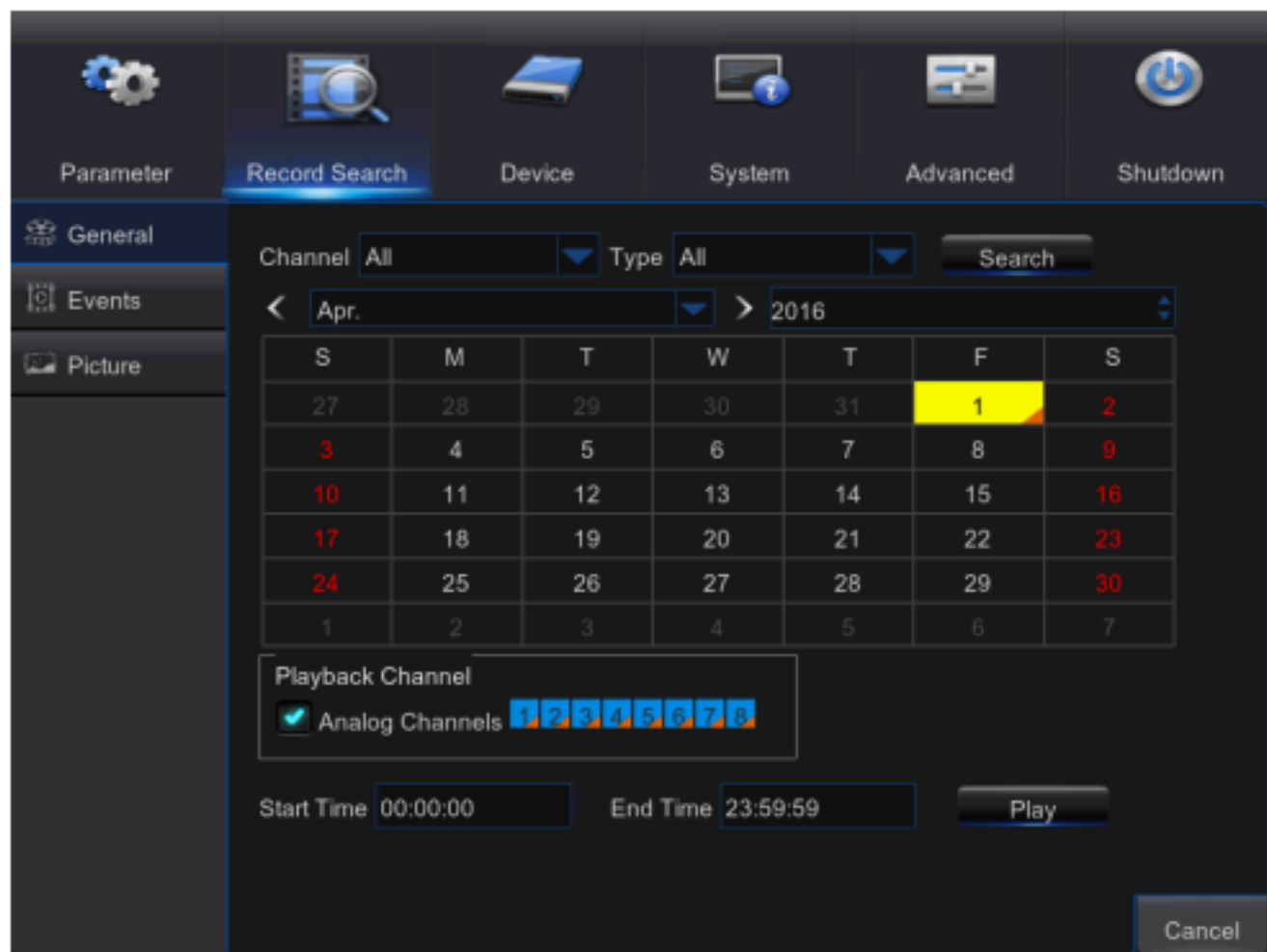

- **Channel:** Select the channel you want to search.
- **Type:** Select the type the playback record. There are three options: All, Normal and Motion.
- **Start Time/End Time:** Select the specific period of time. The default setting is from 0:00 to 24:00.
- **Playback Channel:** Click a date and select corresponding channel in Playback Channel. The selected channels must not be more than 16.
- **Playback:** Select the desired year and month and click “Search”. If there are any records, a yellow corner mark which shows the recording at specific date will appear at the down-right corner of the date sheet. Select the date checkbox and select playback channel and click Playback to enter into the interface.
- **Playback interface:** You can use the Playback Control bar to operate the Fast Forward (X2, X4, X8 and X16), Rewind (X2, X4, X8 and X16), Slow play (1/2, 1/4, 1/8 and 1/16 speed), Play, Pause/Frame. You can click or drag the volume control bar to adjust volume. When playback ends, DVR will remain in the playback interface.

Time Axis setup, file clip and zoom in/out

The DVR supports the processing control bar function when playing back record files.

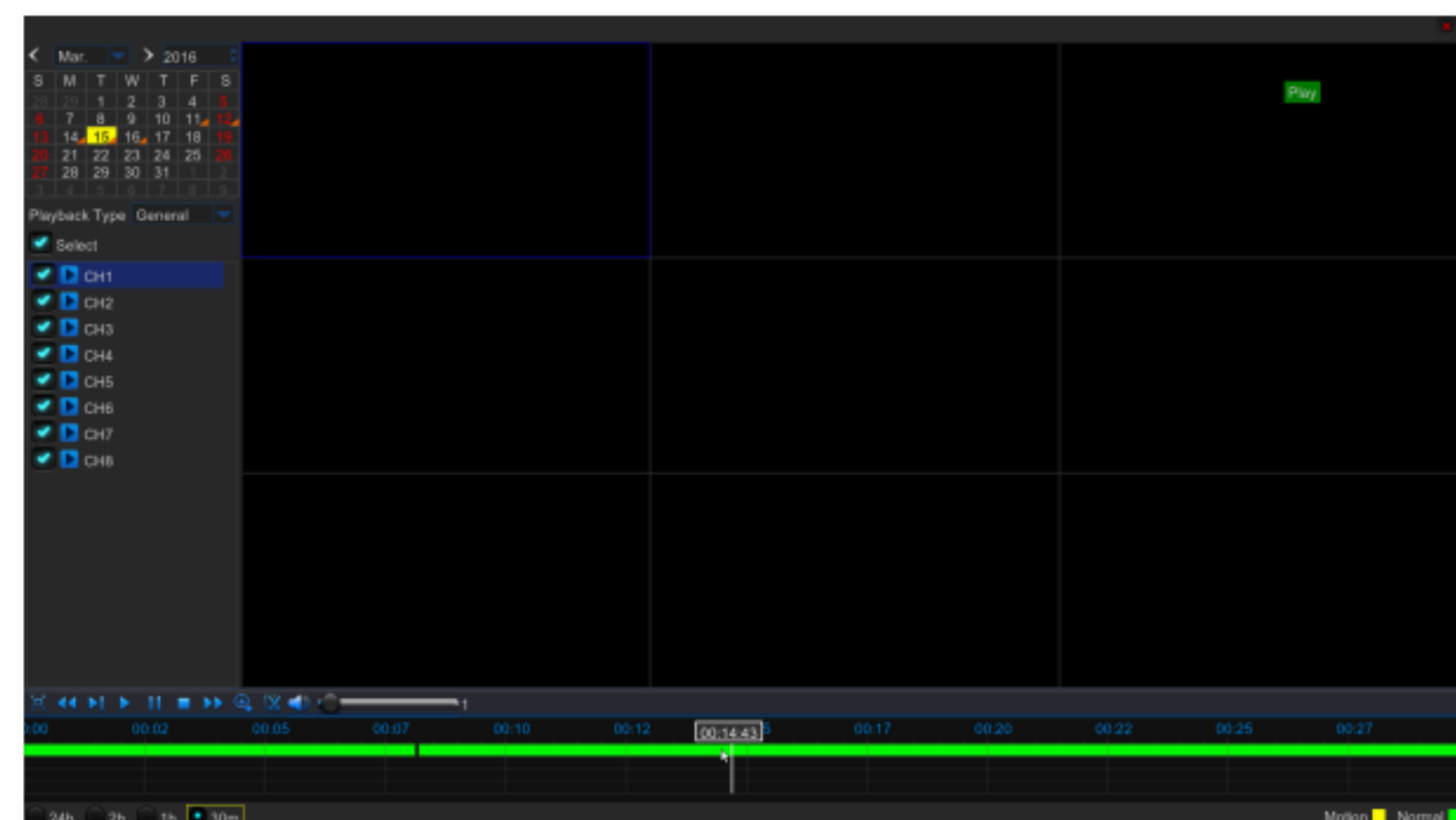



Time Axis zoom: Default value is 24hours. Allow user to select 2 hours, 1 hour, 30 minutes or user-defined.

➤ **Detailed Operation:**

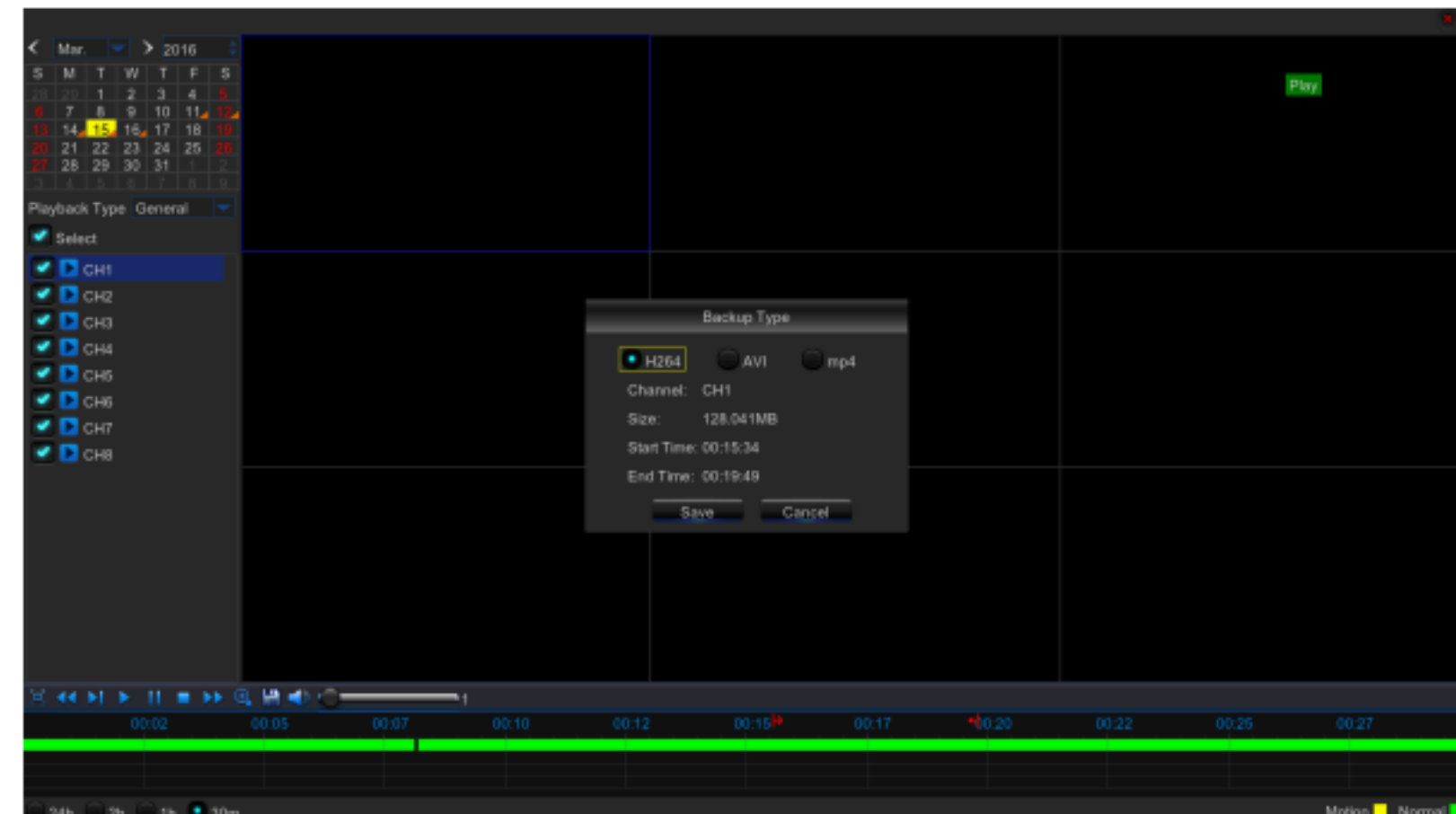
Fixed time axis: If you select [**2h**] option, that means the processing control bar covers two hour of video content. The time range refers to 1 hour before and after the middle point. Record clip and backup function and playback zoom in/out function.



- **Clip and backup:** When it is under single channel playback, the [] icon will appear in the Play Control bar. Click the icon to start video clip function, click the icon again to end the function and pop up the dialog. Now, you may save the clipped video file.
- **Zoom out:** When it is under single channel playback, the [] icon will appear in the Play Control bar. Click the icon to zoom in certain area of the playback screen and right click mouse to return the Playback page.

2. Events

Go to “Main Menu” → “Record Search” → “Events” to enter into the interface.

In this page, user may search details by date, time, channel and record type. The relevant operations are as follows:

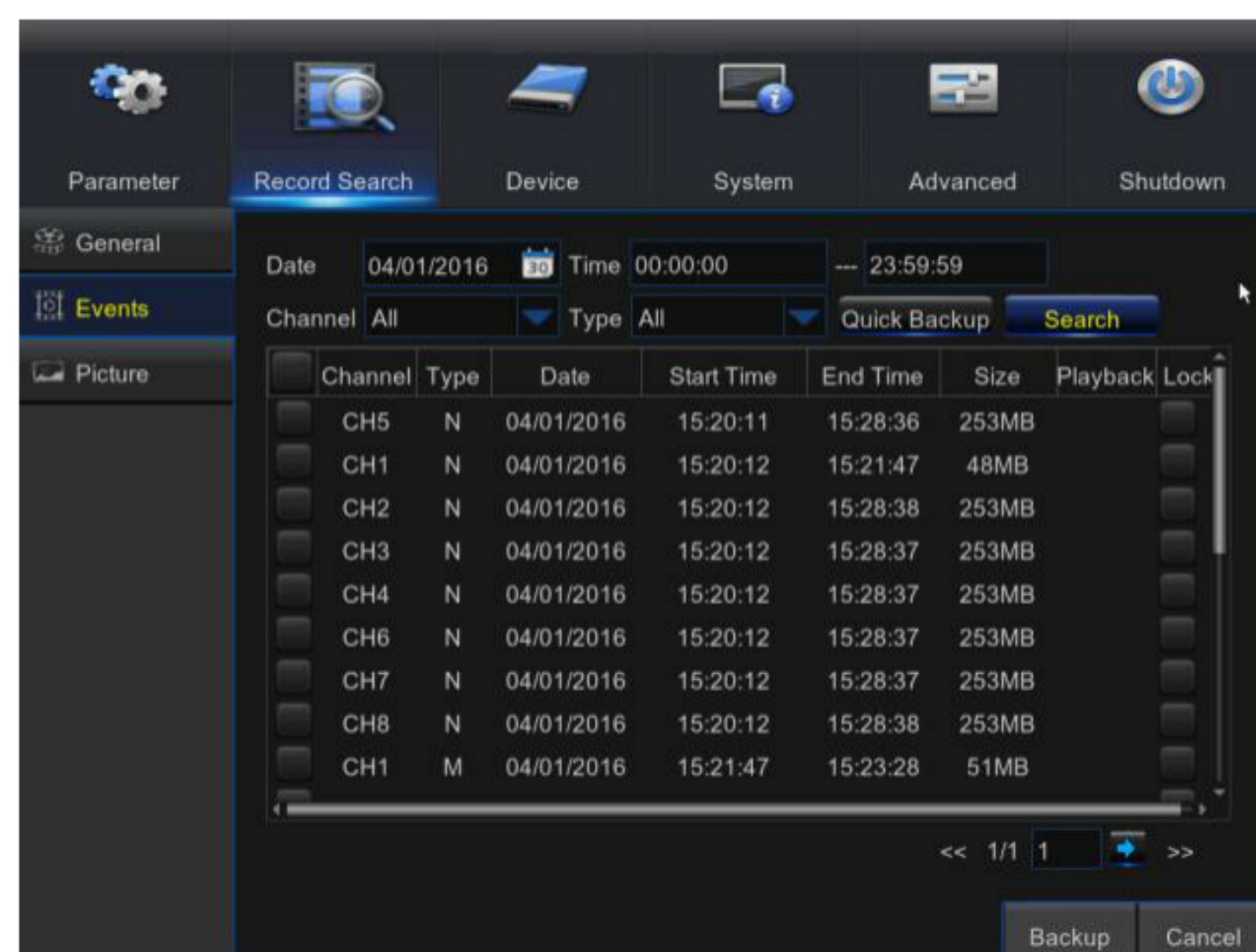

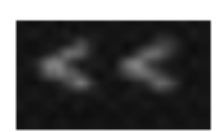
 : Previous page; Click the button to go to previous page when viewing events (except the first page). When viewing the first page, click this button to display the event list in the first page.

 : Next page; Click the button to go to next page when viewing events (except the last page). When viewing the last page, click this button to display the event list in the last page.

 : Jump; Input the desired record event page in the input box and click arrow button to jump to the input page.

Two types of backup: Quick Backup and Backup

If you want to back up a record in the detailed file list, you may check the checkbox at the left of the record (“√” means it has been selected) and click “Backup” to enter into “Select backup type” (Make sure USB flash drive or other portable storage device are connected).

If you want to back up with USB, select USB and click OK to start processing and you will see the backup progress.

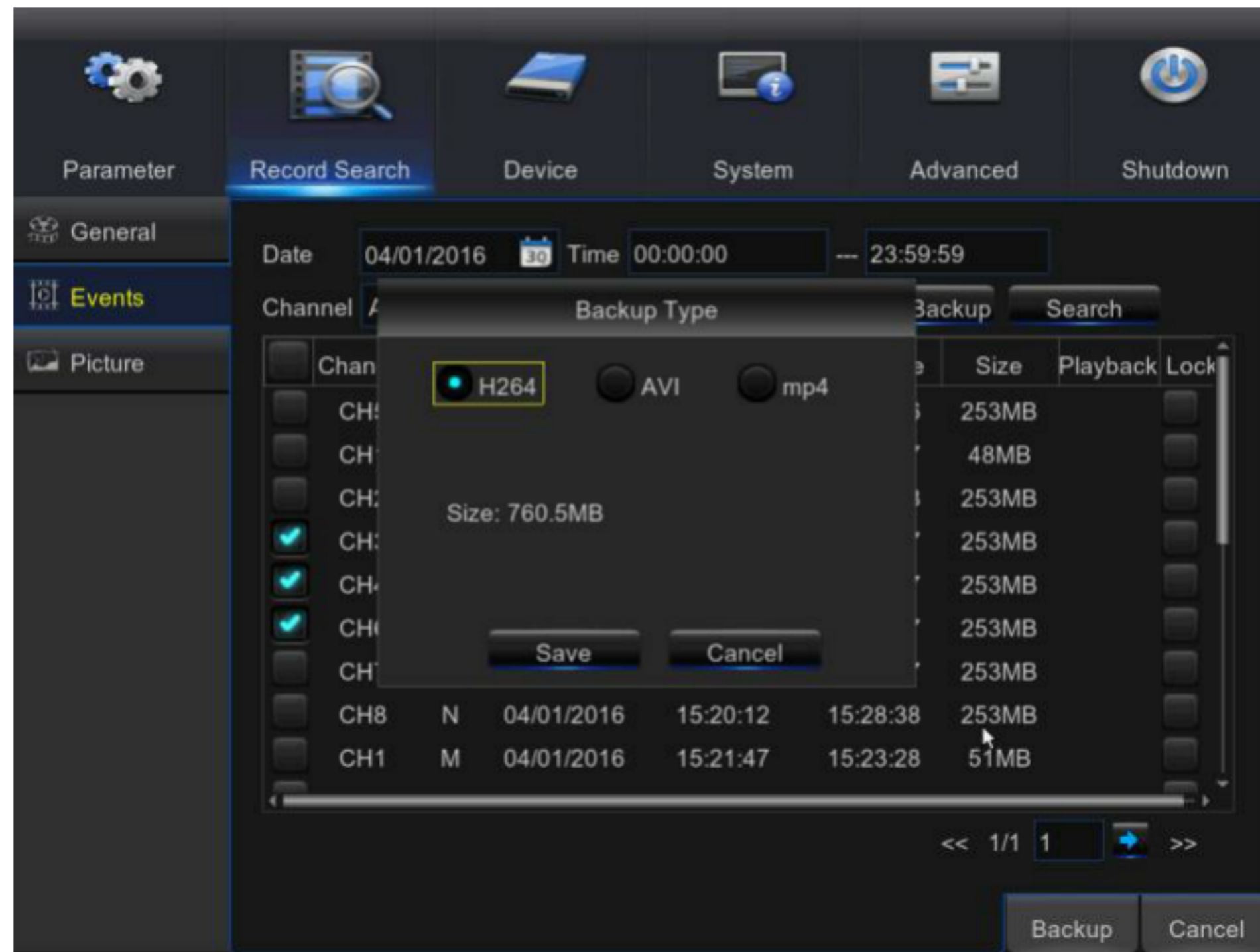

After backup finishes, message Backup Finishes will appear at down-right corner.

Note: Before backup, connect devices for backup (USB flash drive or other mobile storage devices with USB interface)

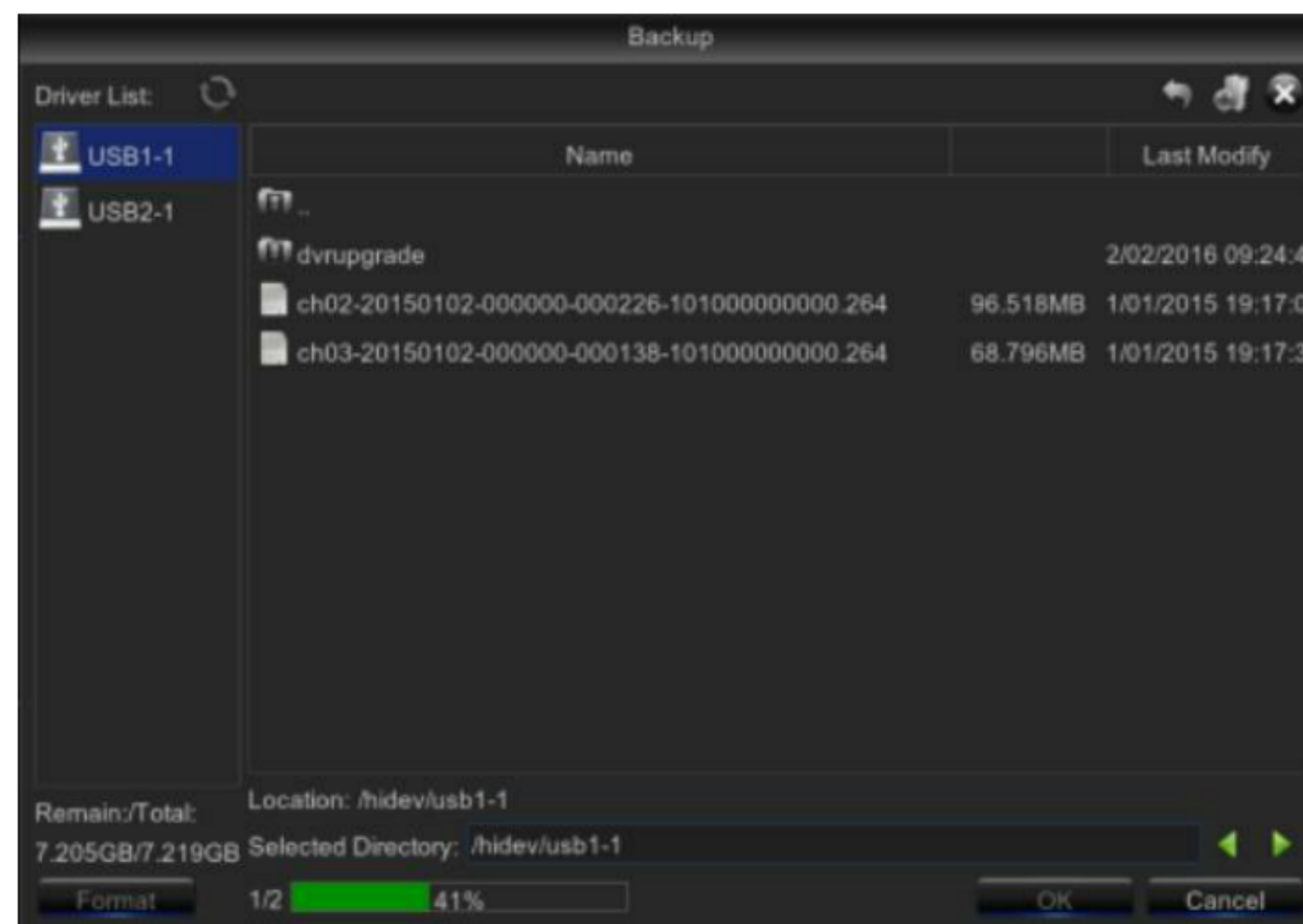







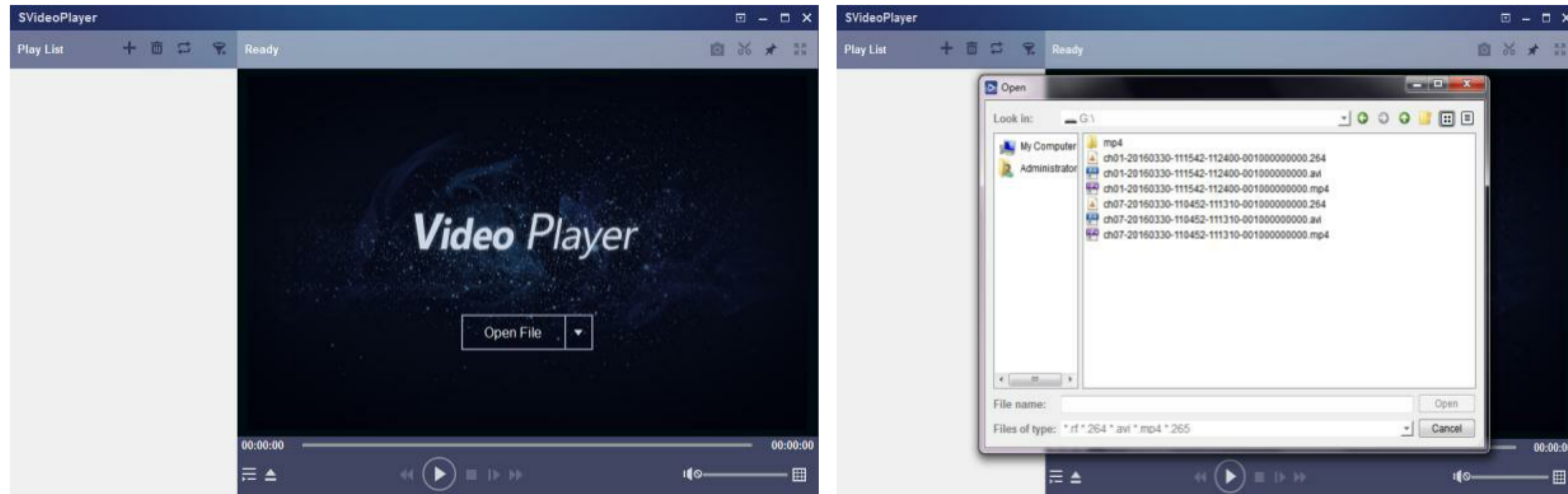









3. Play Backup Files

1. Copy backup files to the computer.

2. Open SVideo player and click “+” or “**Open File**”. For example, if you want to choose *.264, *.avi, *.mp4, add backup file and select a file to play.



-  Play: Click to play file
-  Pause: Click to pause.
-  Stop: Click to stop playback.
-  Frame Forward: step forward by frame
-  Slow forward: Click to play at 8x,4x,2x,1x,1/2,1/4,1/8,1/16 speed.
-  Fast forward: Click to play at 16x,8x,4x,2x,1x,1/2x,1/4x,1/8x speed
-  Open file/Open Directory
-  Expand/pack up the list.
-  Screenshot: Save path: C:\Users\Administrator\SVideoPlayer\picture
-  Cut: Save path: C:\Users\Administrator\SVideoPlayer\video
-  Full screen display
-  Never on top
-  Always on top
-  On top during playing
-  Adjust volume
-  Window Division,



1/4/9/16 channels optional.



Add folder or file.



Playback mode, Single, Order, Repeat one, Repeat ALL are optional



Delete all files in the list.



Search File



Language/Settings

Basic Settings: Set on-top mode

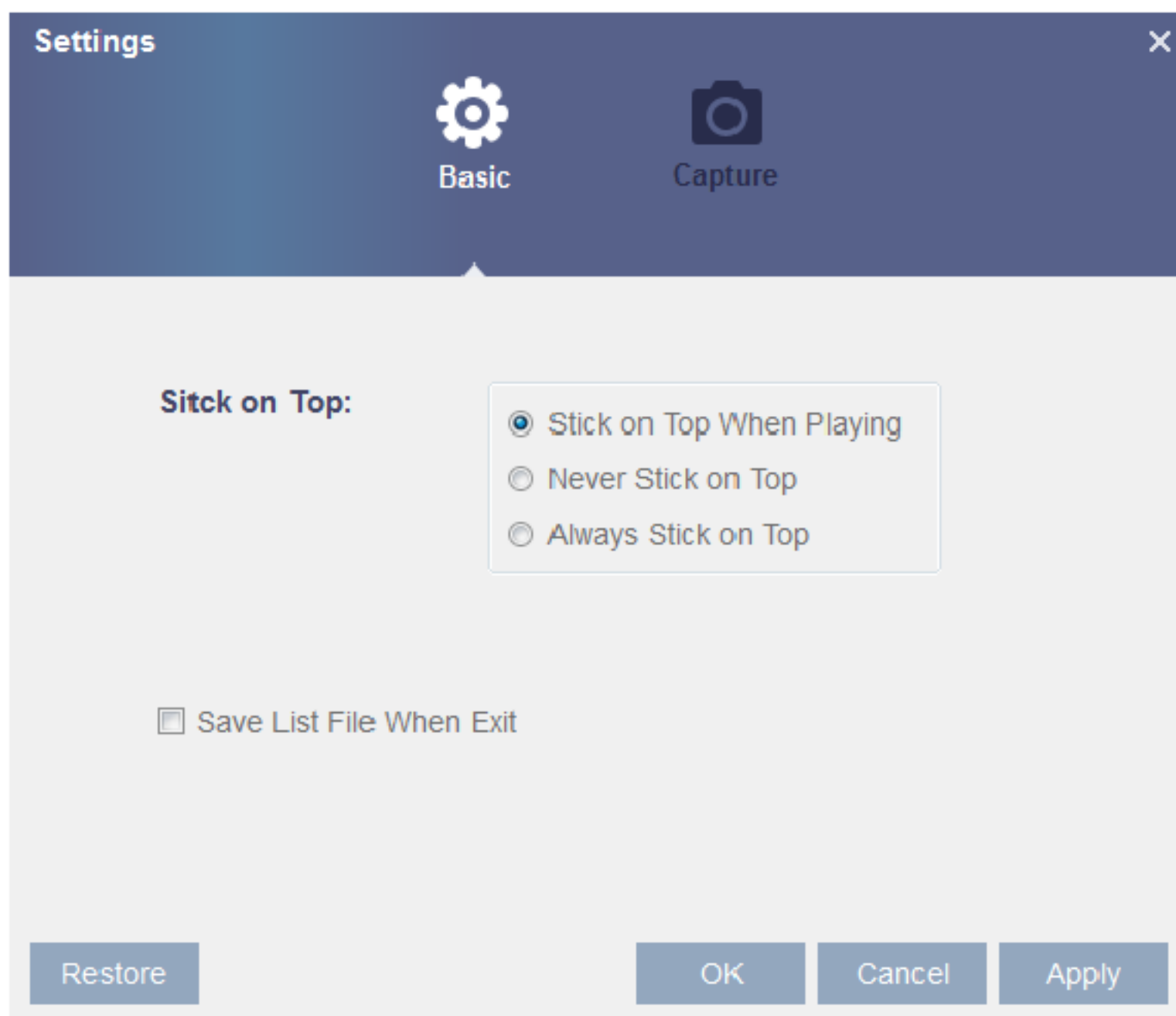

Capture Settings: Set the path to save image

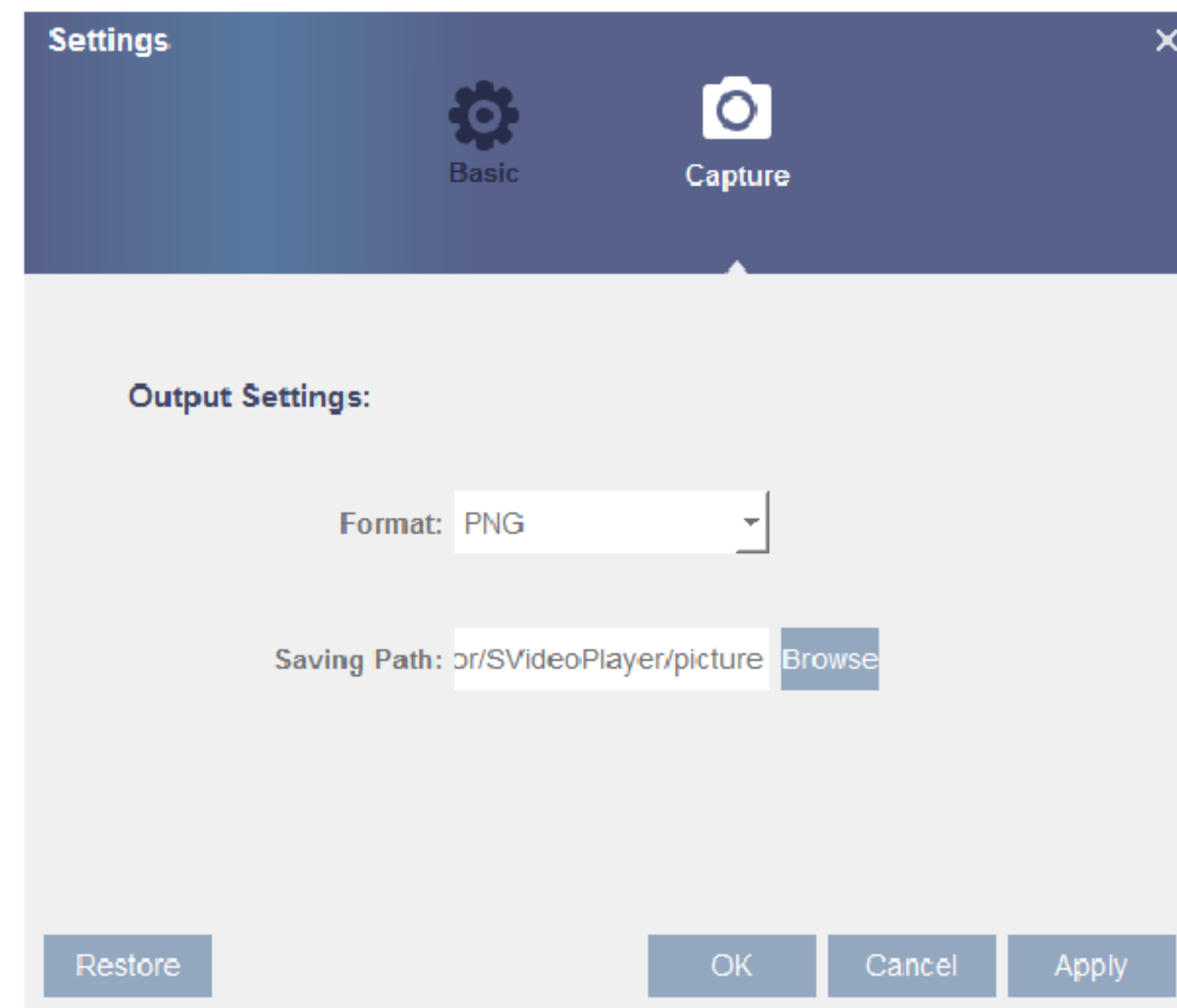

Note:

It is recommended to use SVideo Player contained in compact disk for playback. Use of any other player may cause compatibility problem.

4. Picture

Go to “Main Menu”→“Parameter”

Support search picture for 5000pcs each time. If the picture number greater than this value, please adjust the date (time) of the current search and search again.

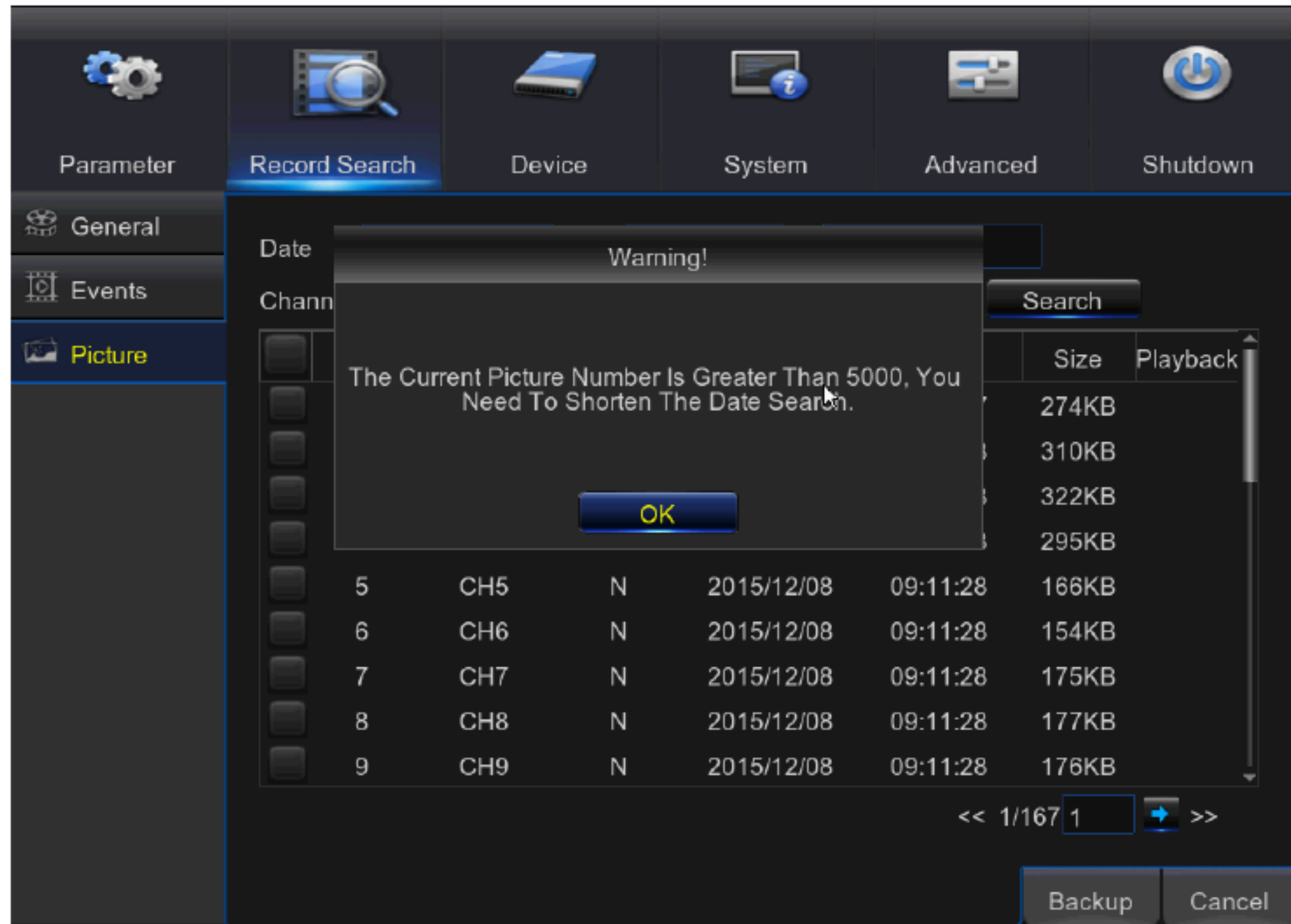

Go to “Main Menu” → “Record Search” → “picture” to enter into the interface.

In this page, user may search details by date, time, channel and record type. The relevant operations are as follows:

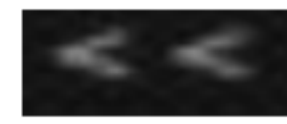
 : Previous page; Click the button to go to previous page when viewing events (except the first page). When viewing the first page, click this button to display the event list in the first page.

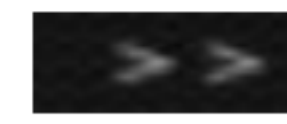
 : Next page; Click the button to go to next page when viewing events (except the last page). When viewing the last page, click this button to display the event list in the last page.

 : Jump; Input the desired record event page in the input box and click arrow button to jump to the input page.

Two types of backup: Quick Backup and Backup

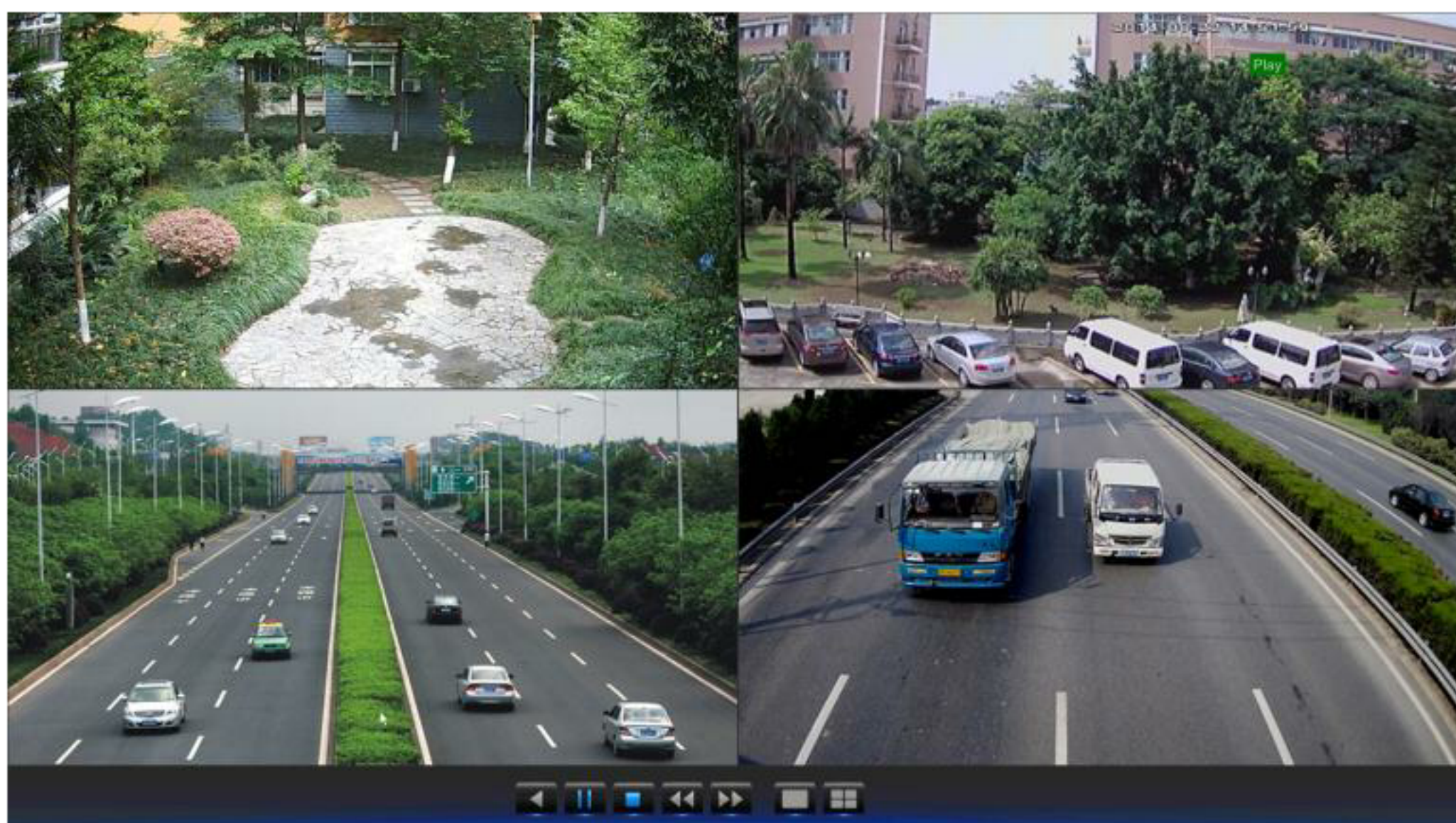

 : Step Forward

 : Play

 : Stop

 : Rewind

 : Fast Forward

 : Single/Quad View.

3.2.3 Device

1. HDD

Go to “Main Menu” → “Device” → “HDD” to enter into the interface.

When HDD is connected, the system will automatically detect if the HDD is normal or not; if the HDD needs to be formatted, select the HDD and format it. If the system detects the HDD is normal, the HDD status will be shown as “Normal”.

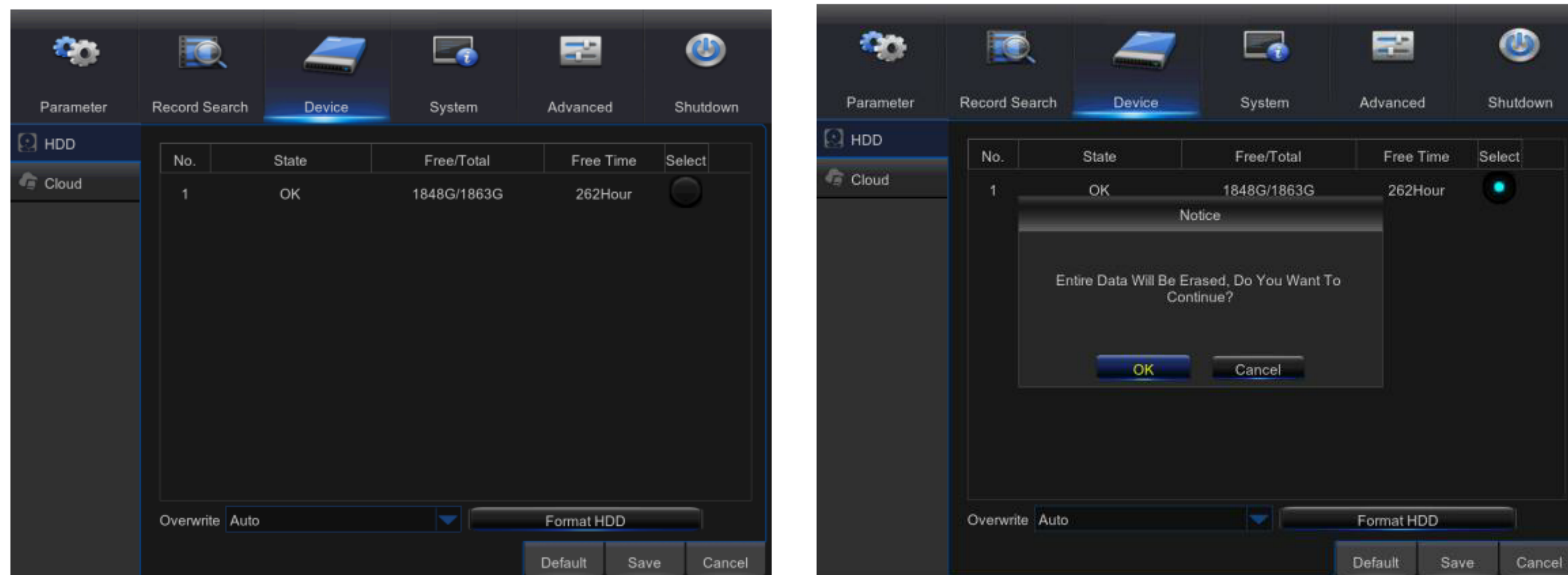

- **No.:** Number of HDD connected to system.
- **Status:** It shows the current status of the HDD. It will be available only when the HDD is “Normal”.
- **Free/Total Space:** Remaining or total space of the HDD
- **Free Time:** Remaining time for the HDD recording according to current setting for “Resolution”, “Encoding Rate” and “Frame Rate” of image.
- **Auto-overwrite:** When set to ENABLE and the hard drive is full, the DVR will overwrite the oldest files on the hard drive. When set to DISABLE and the hard drive is full, the DVR will stop recording.
- **Format HDD:** Format HDD for the first use.

Note: Recording can only be performed when the HDD is in “Normal” state.

3.2.4 Cloud Storage

1. Cloud Storage

Cloud: Cloud Space (Network HDD). It can upload the DVR periodically captured pictures and motion detection captured pictures to Dropbox

- 1) Register in Dropbox website, <https://www.dropbox.com/>
- 2) Configure network to ensure the normal operation of the DVR network.
- 3) Configure Cloud: Enable Cloud and set the channel and interval for the DVR periodically captured pictures; Enable Motion Detection to get captured pictures for motion detection.
- 4) Driver Name refers to the name created in the folder of Dropbox and the name can be defined by the user, e.g. CloudDVR000. The folder will store the periodically captured pictures.
- 5) Click [Advanced E-mail Setup] to set the Email box. Enter email address.
- 6) Click [Active Cloud] to activate Cloud and Email will receive the URL related to Cloud

User input the registered user name to visit the above website and the following interface will be popped up.

- 7) Click the icon at the upper-left to view the folder (CloudDVR000) made in Step 4.
- 8) Enter the folder to view the DVR captured pictures.

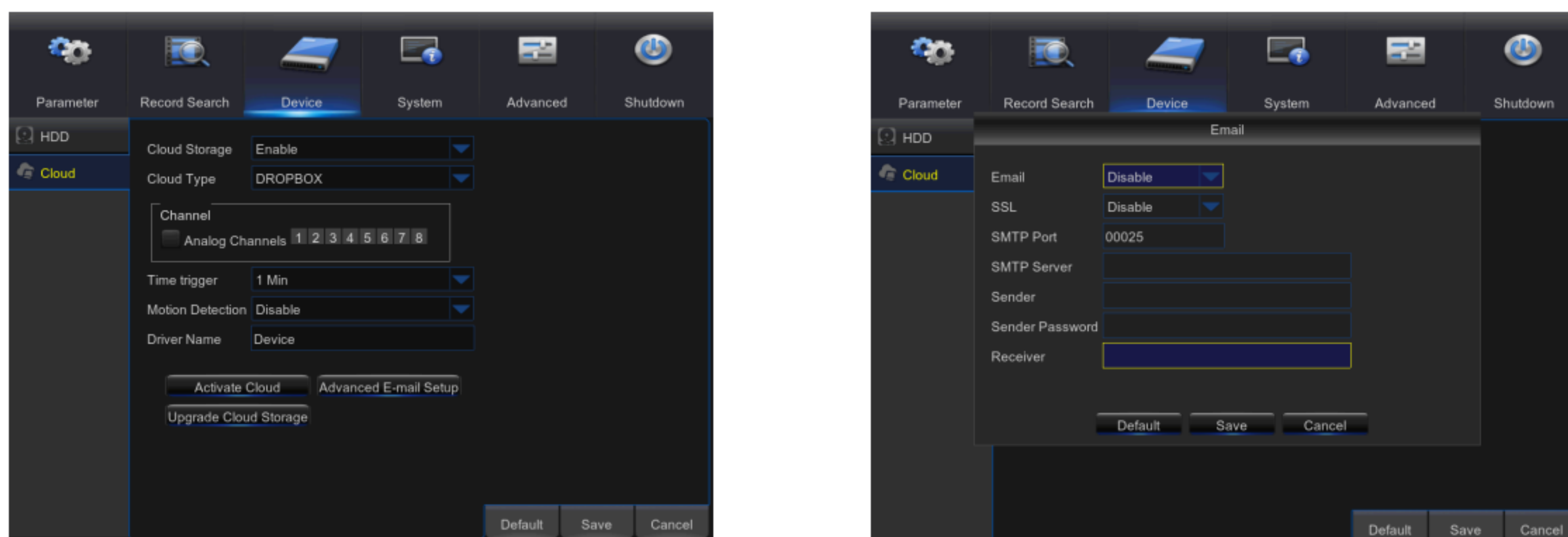

3.2.5 System

1. General

Go to “Main Menu” → “System” → “General” → “General” to enter into the interface.

User may set Date, Time, Date Format, Time Format, Language, Video Format, Menu Timeouts and Show Wizard on this page.

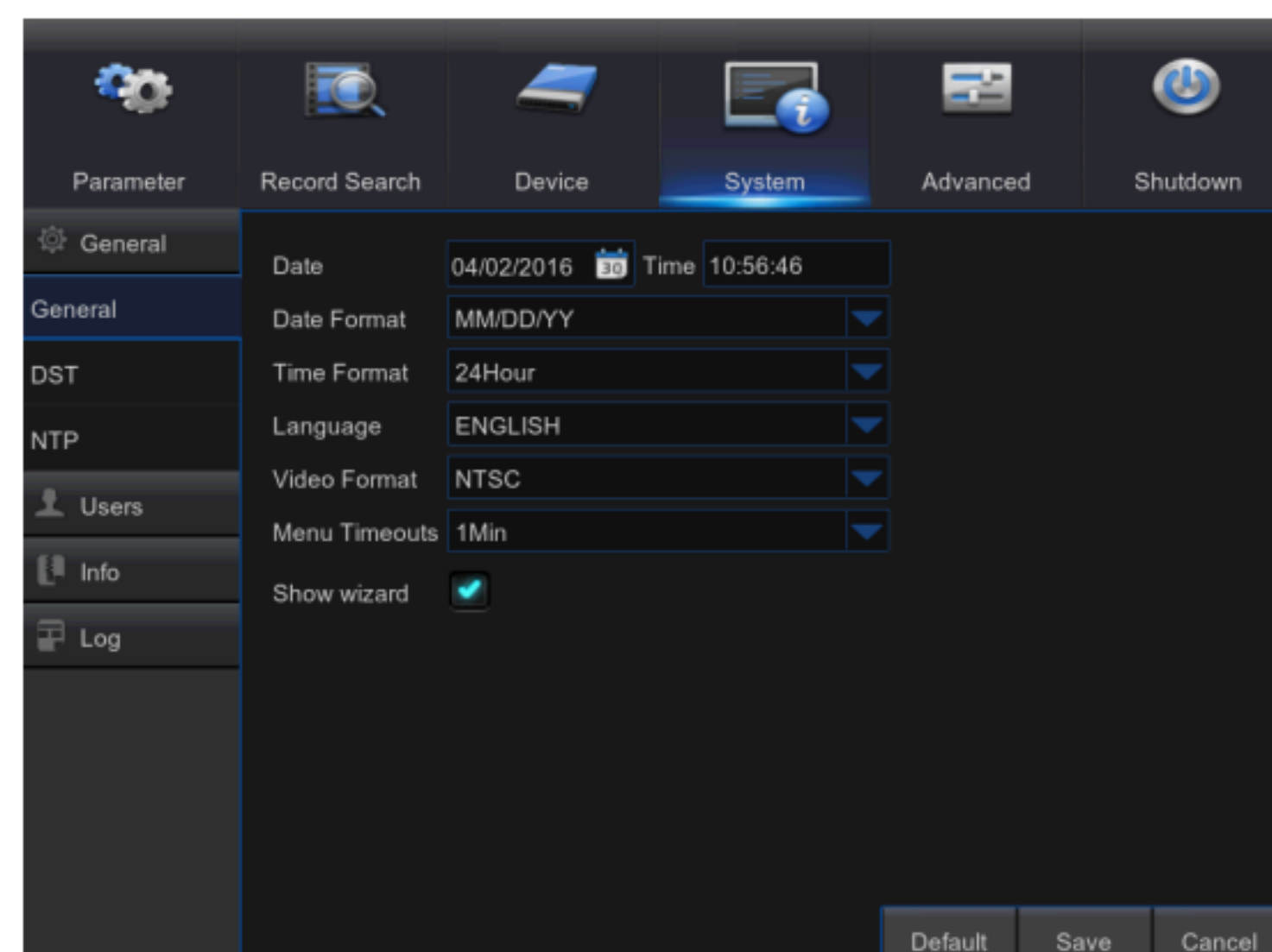

2. DST

Go to “Main Menu” → “System” → “General” → “DST”.

Enter into the interface to set DST, Time Offset, Start Time and End Time.

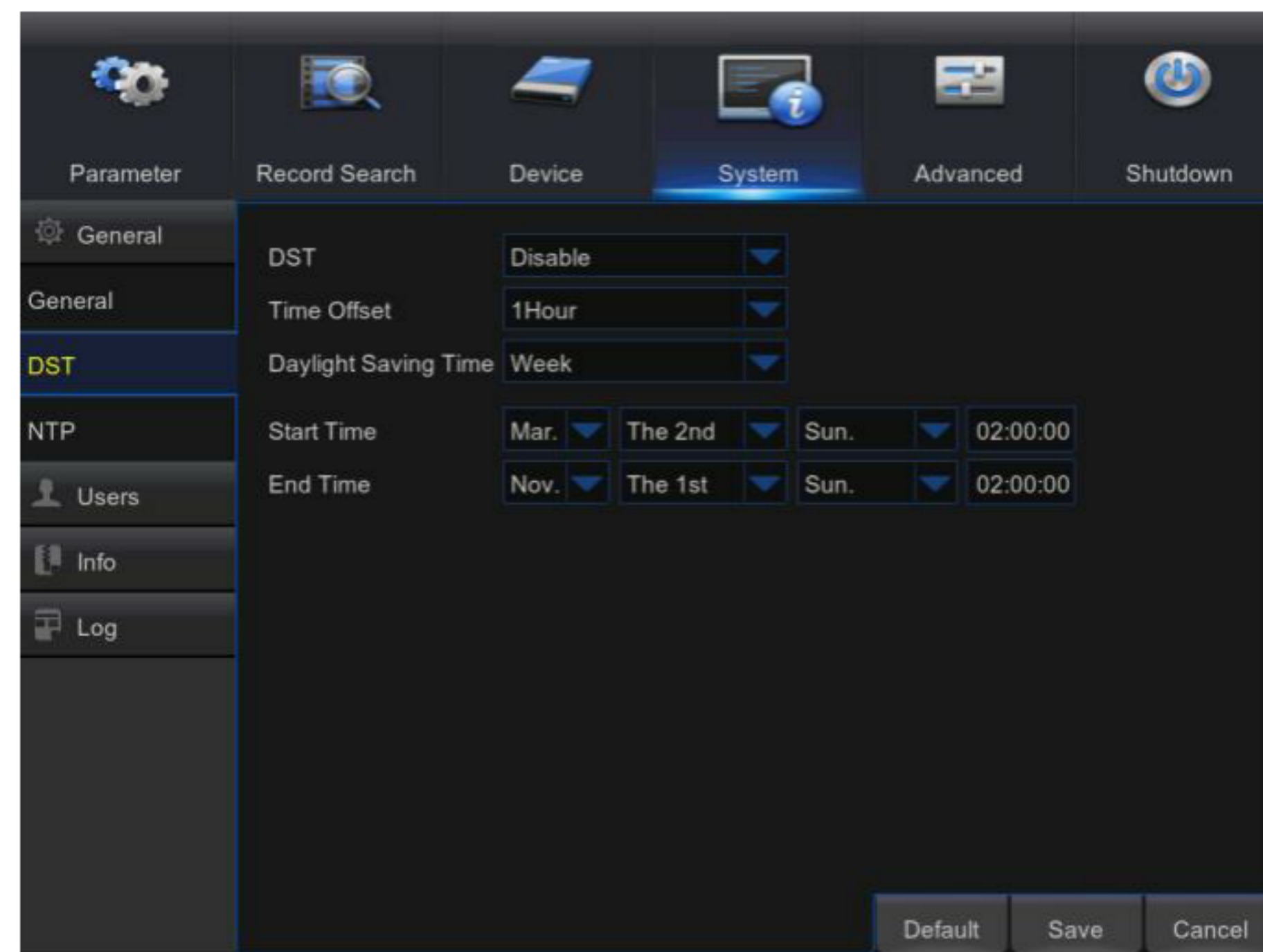

3. NTP

Go to “Main Menu” → “System” → “General” → “NTP”.

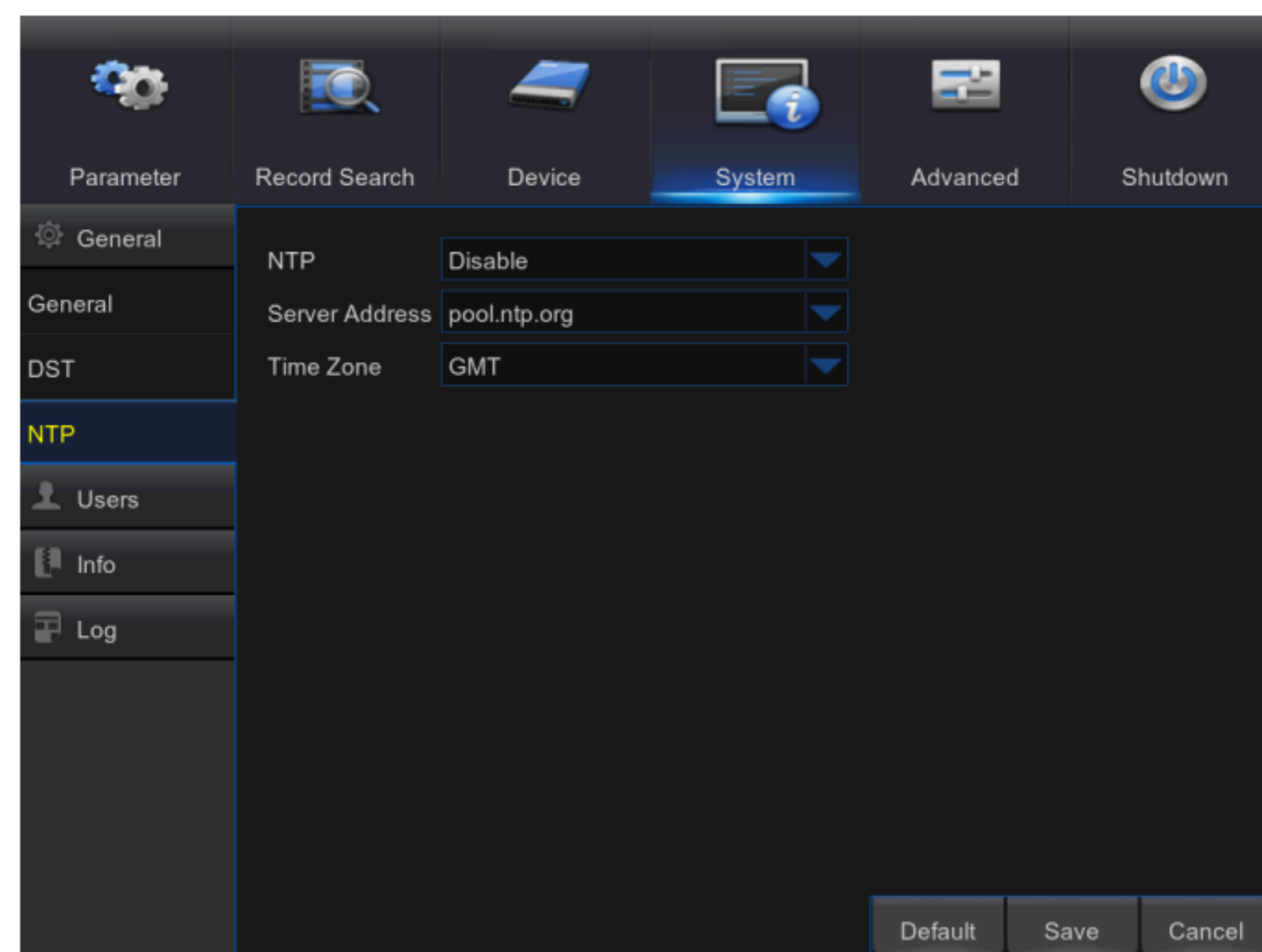

- **NTP service:** Enable/Disable NTP function.
- **Server Address:** Select NTP server (time.windows.com, time.nist.gov, pool.ntp.org).
- **Time Zone:** Corresponding time zones for various nations or regions.
- **Update Time:** Enable NTP function and save parameters and click Update Time to calibrate the system time.

Note: When NTP function is set to “Enable”, system will calibrate the system time at every 00:07:50 and every start-up.

4. Users

Go to “Main Menu” → “System” → “Users” to enter into the User interface.

It supports up to seven users, including one administrator and six users. Click [Edit] button to enter into the [User Edit] interface to input user name and password.

User Name consists of 8 characters and password is composed by number 0-9 with max length of 8 numbers.

Set user password. Administer is authorized to set user common user’s authority.

- **Log Search:** allow you check all the system logs.
- **Parameter:** allow you set all the parameters.
- **Maintain:** allow you update version, recover ex-factory value, device reboot and shut down.
- **Disk Management:** allow you manage and control the HDD and USB drive.
- **Remote Login:** allow you remotely login DVR.
- **SEQ Control:** allow you sequence live screens for all the channels.
- **Manual Record:** allow you manually start/stop record.
- **Manual Capture:** Allow you to manually take a snapshot
- **Backup:** Tick-select the ENABLE “√”option and select channel for backup, the user is allowed to back up the record in the selected channel.
- **Live:** Tick-select the ENABLE “√”option and select a channel and the user is allowed to view all the live images in the selected channel.
- **Playback:** Tick-select the ENABLE “√”option of Playback and the common user is allowed to playback the selected record in the channel.

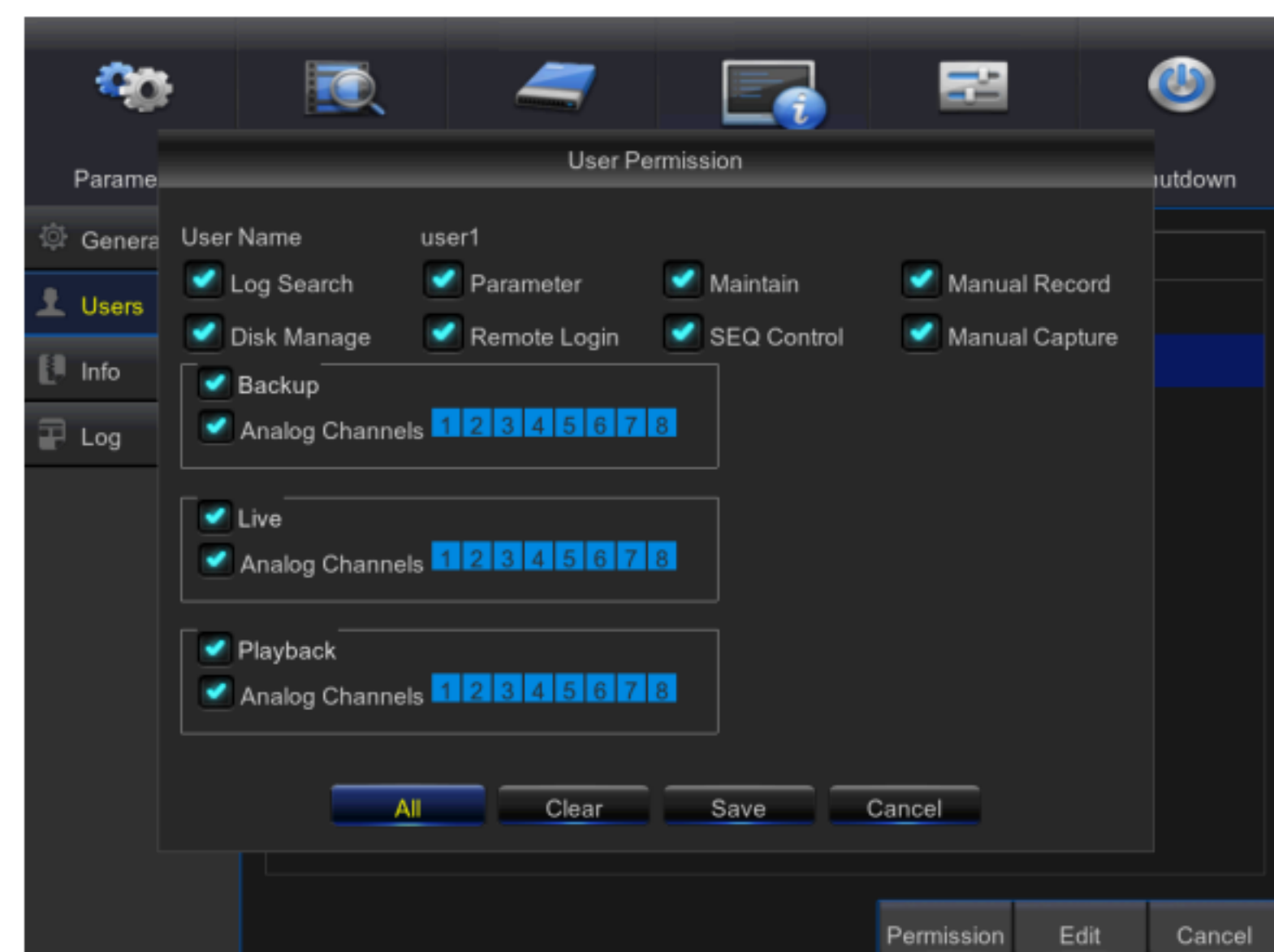
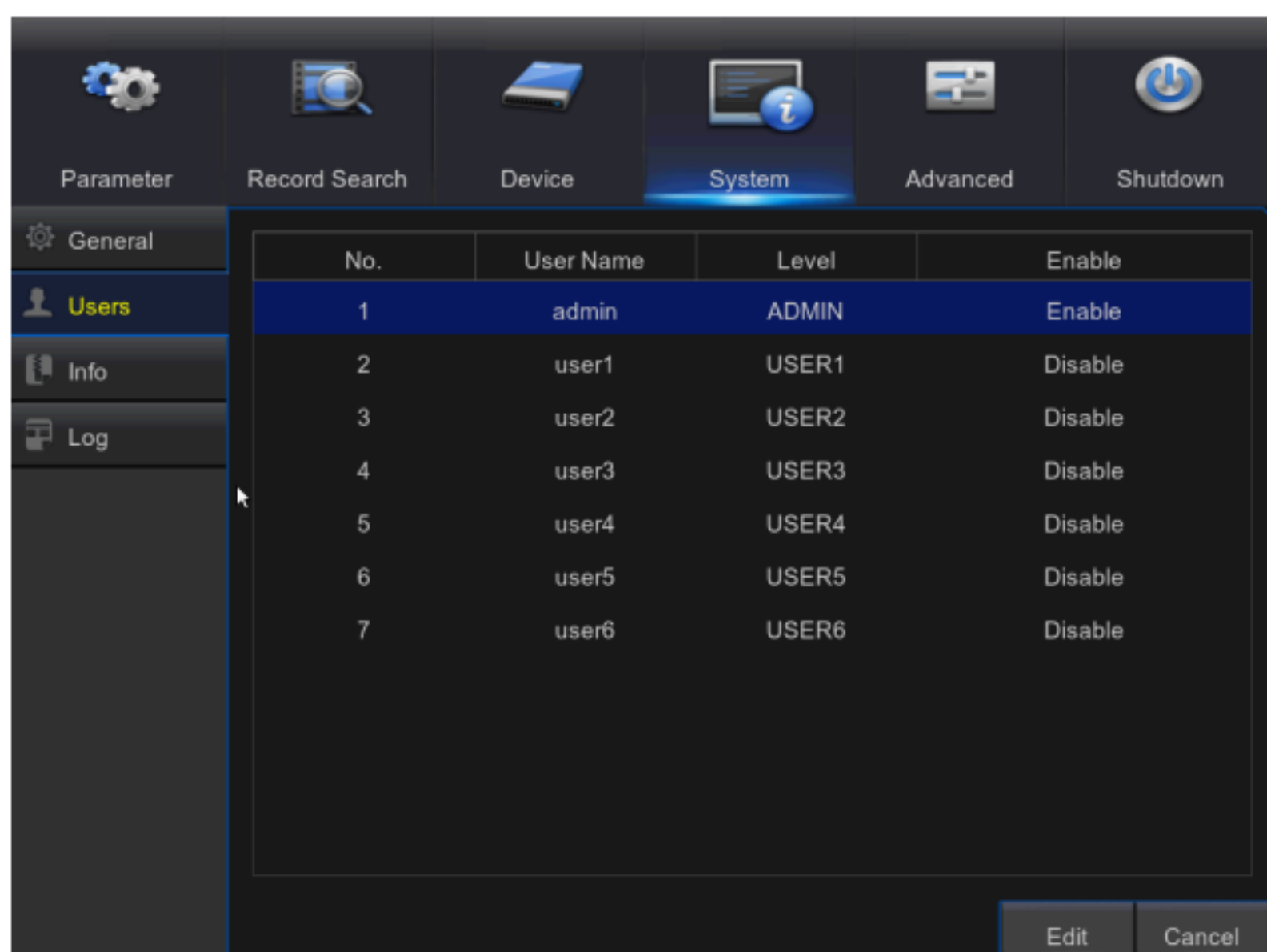

5. User Edit

User may enable or disable the function or set password.

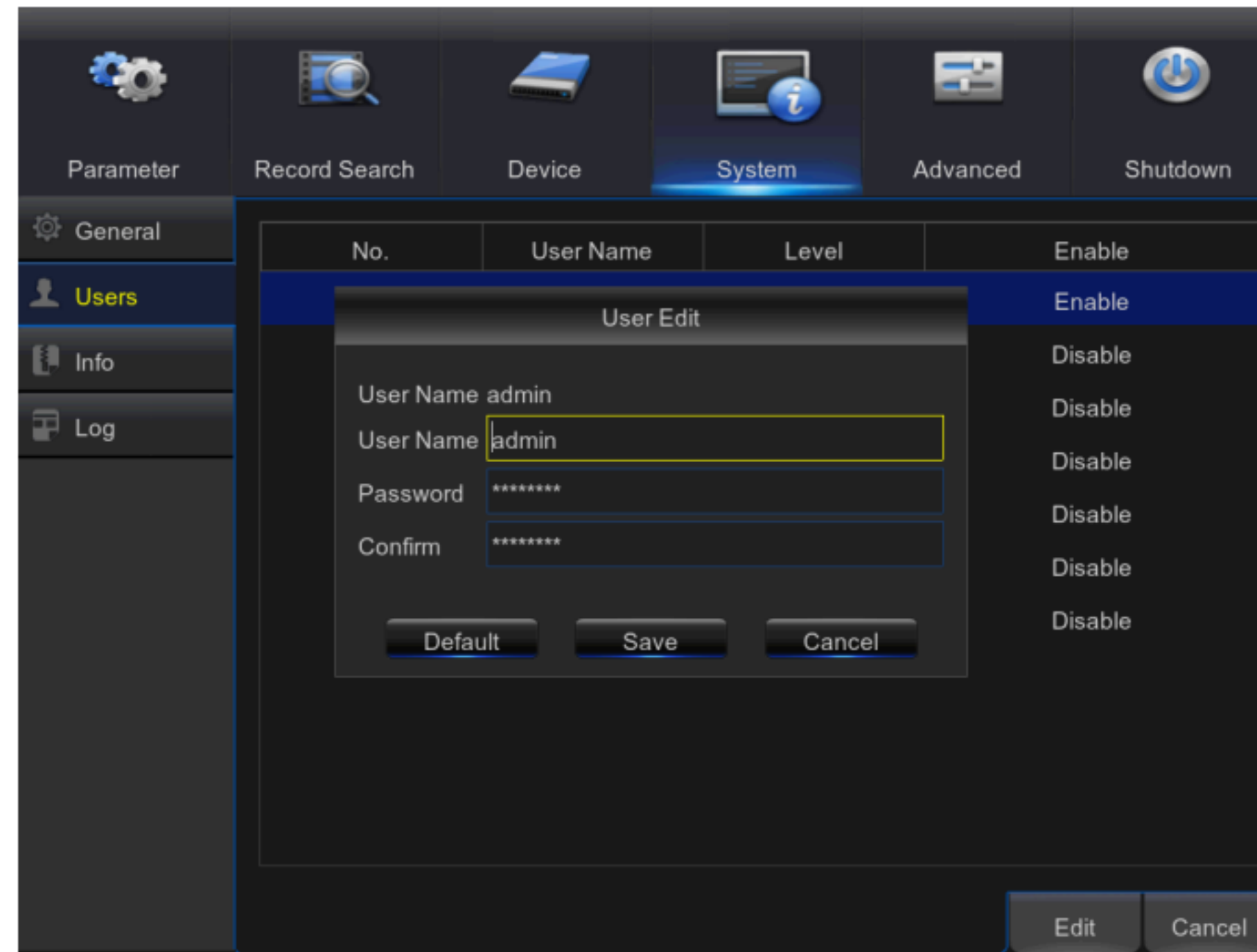

6. Info

Go to "Main Menu" → "System" → "Info" to enter into the interface.

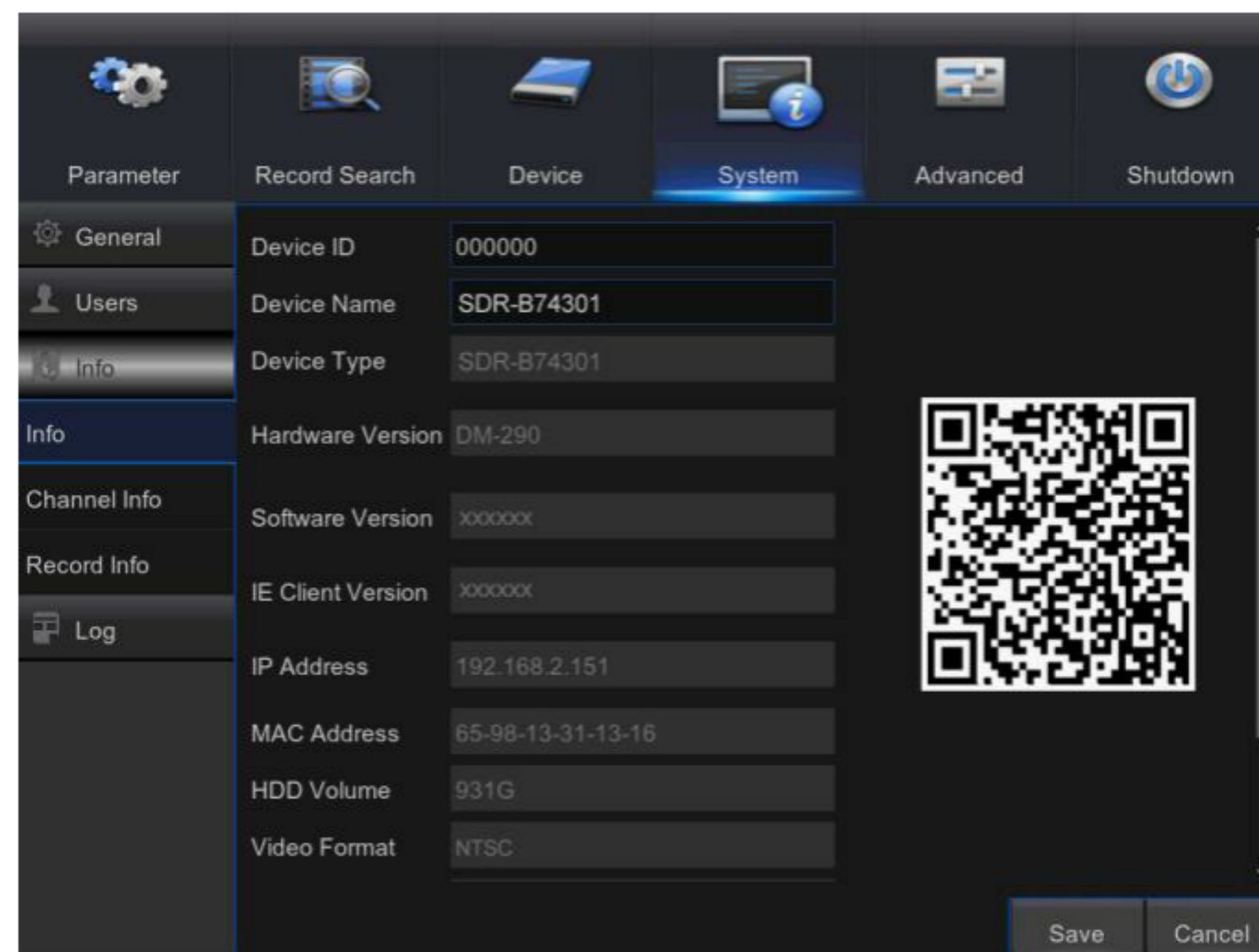

7. Log

Go to “Main Menu” → “System” → “Log”.

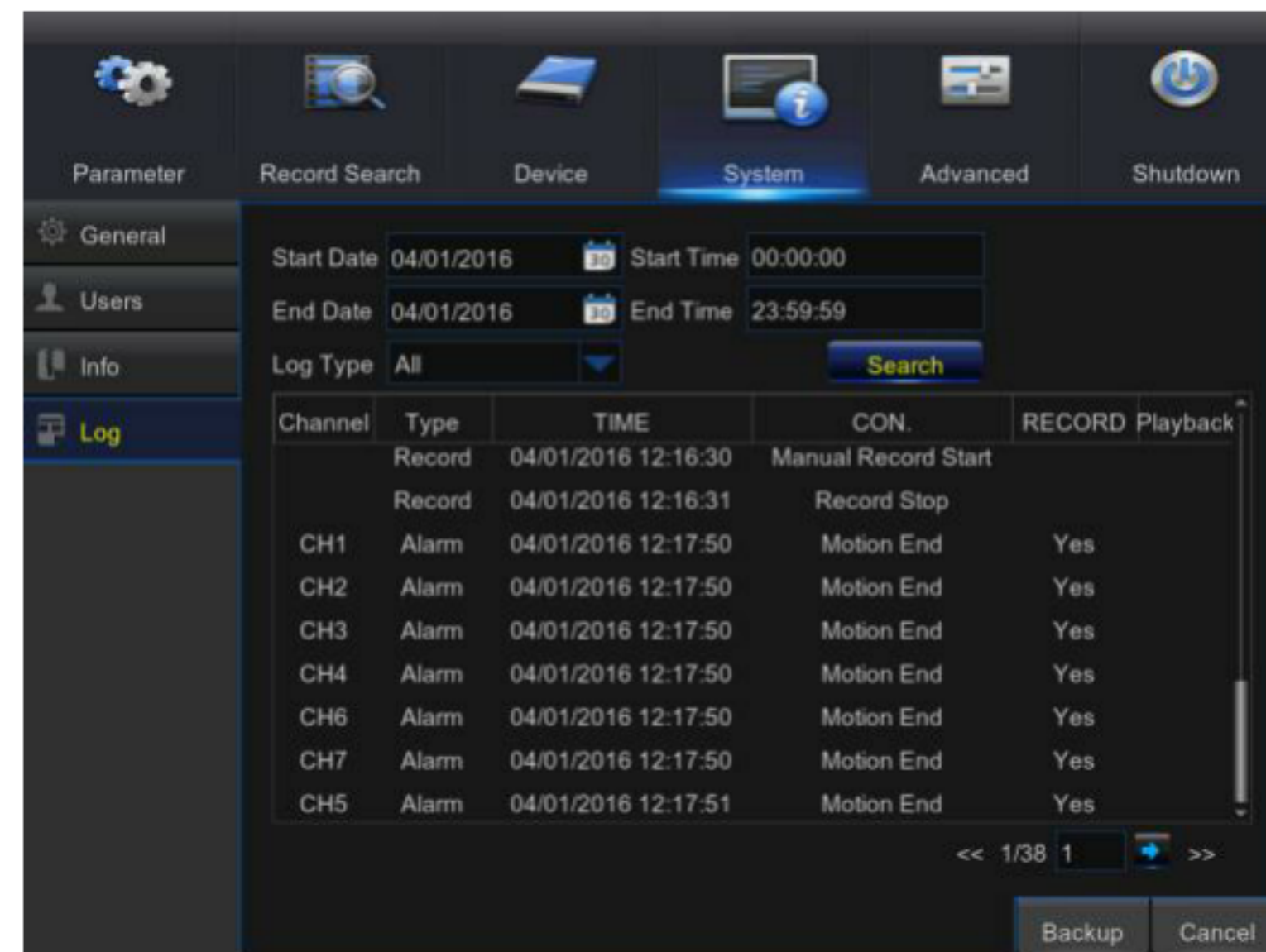

User may search log information in different period of time. Click “Backup” to save all the log information.

3.2.6 Advanced

1. Maintain

Go to “Main Menu” → “Advanced” → “Maintain” to enter into the interface.

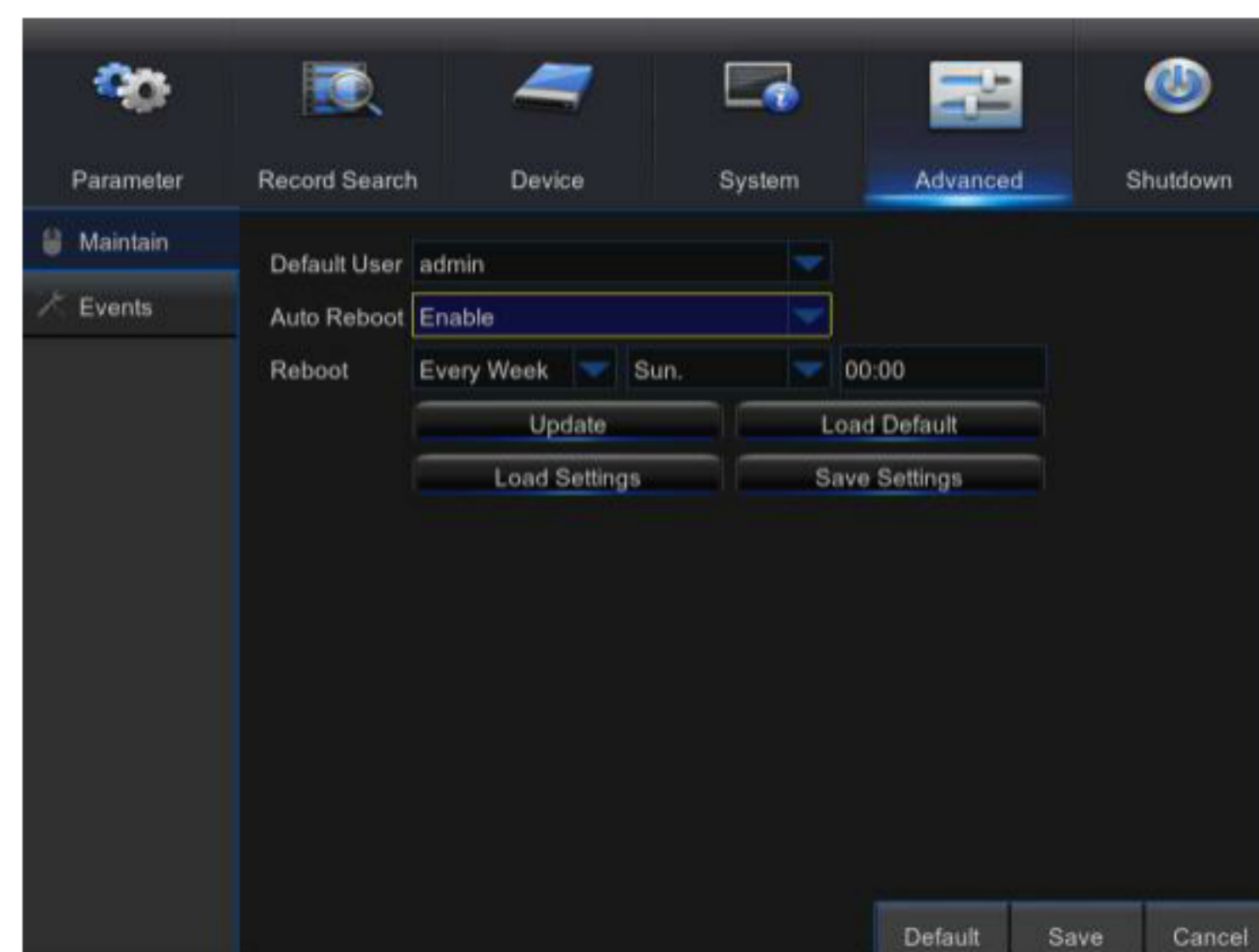

- **Auto Reboot:** Enable the auto maintenance function to reboot system regularly at every day/week/month. When Auto Reboot is enabled, DVR should be in the main interface and no user operation.
- **Update:** Click Update to enter the Device interface and select the updating file in USB to execute.
- **Load Default:** If [Load Default] is selected, you can initialize the system to the ex-factory default. Click “Load Default” and select items to be restored
- **Load Settings:** Load parameters in the removable storage device to DVR.
- **Save Settings:** Save the set parameters of user’s DVR to the removable storage device.

Note: Do not take out the USB memory or cut off the power during upgrading. When the update is done, system will be automatically restarted. After about 5 minutes, the upgrading will be finished. It is recommended to load ex-factory default after upgrading. The auto maintain function can be effective only when DVR returns back to Preview mode with no any operation within the set auto maintain time.

2. Events

Go to “Main Menu” → “Advance” → “Events” to enter into the interface.

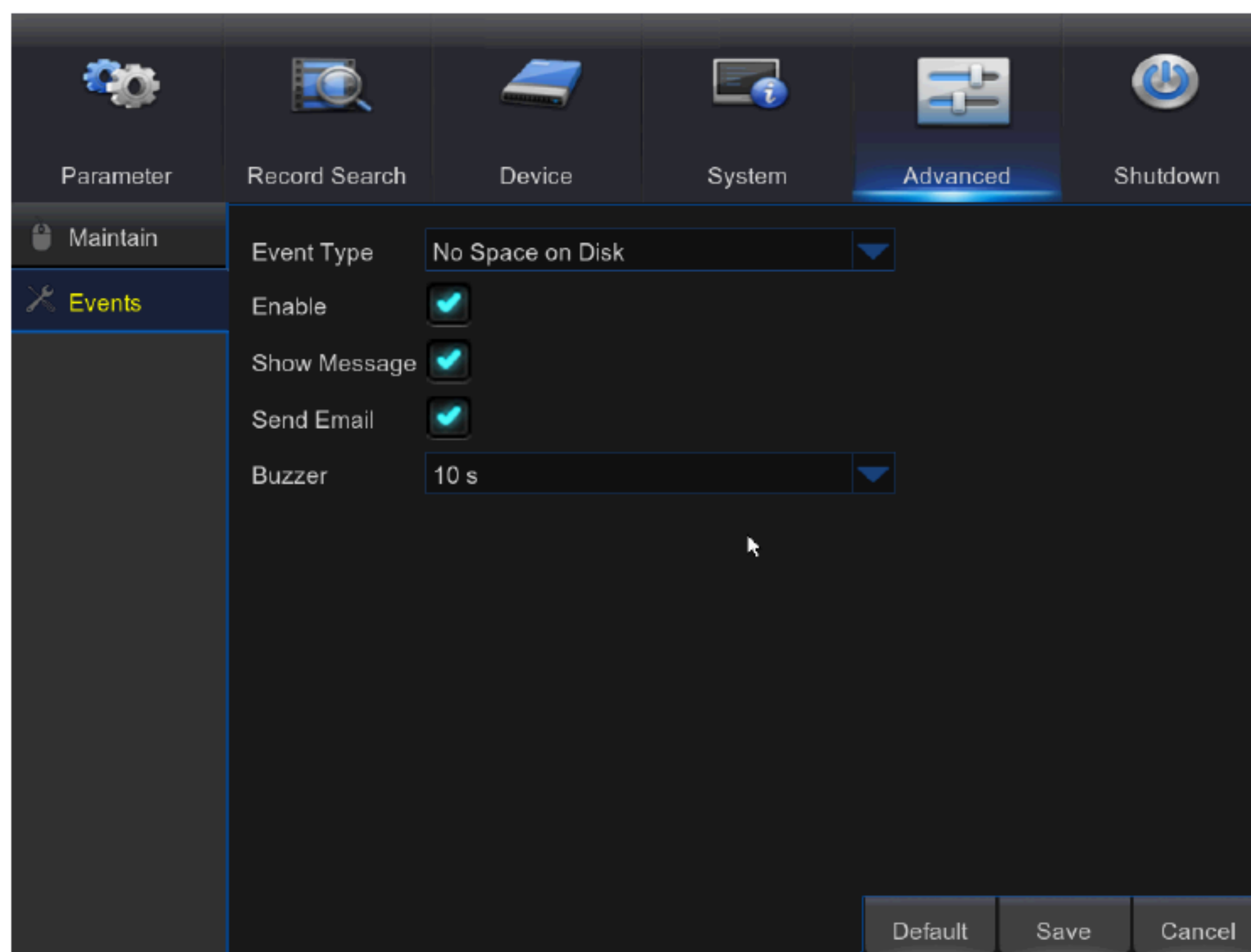

- **Event Type:** Support three abnormal types: Disk Full, Disk Error and Video Loss.
- **Enable:** Active alarms for abnormal situations.
- **Show Message:** You can set show message on the screen when sensor alarm is detected.
- **Buzzer:** How long the buzzer will sound (10s, 20s, 40s, 60s).
- **Send Email:** Select to send Email to specified Email address when abnormal events appear.

3.2.7 Shutdown

Go to “Main Menu” → “Shutdown” to enter into the interface.

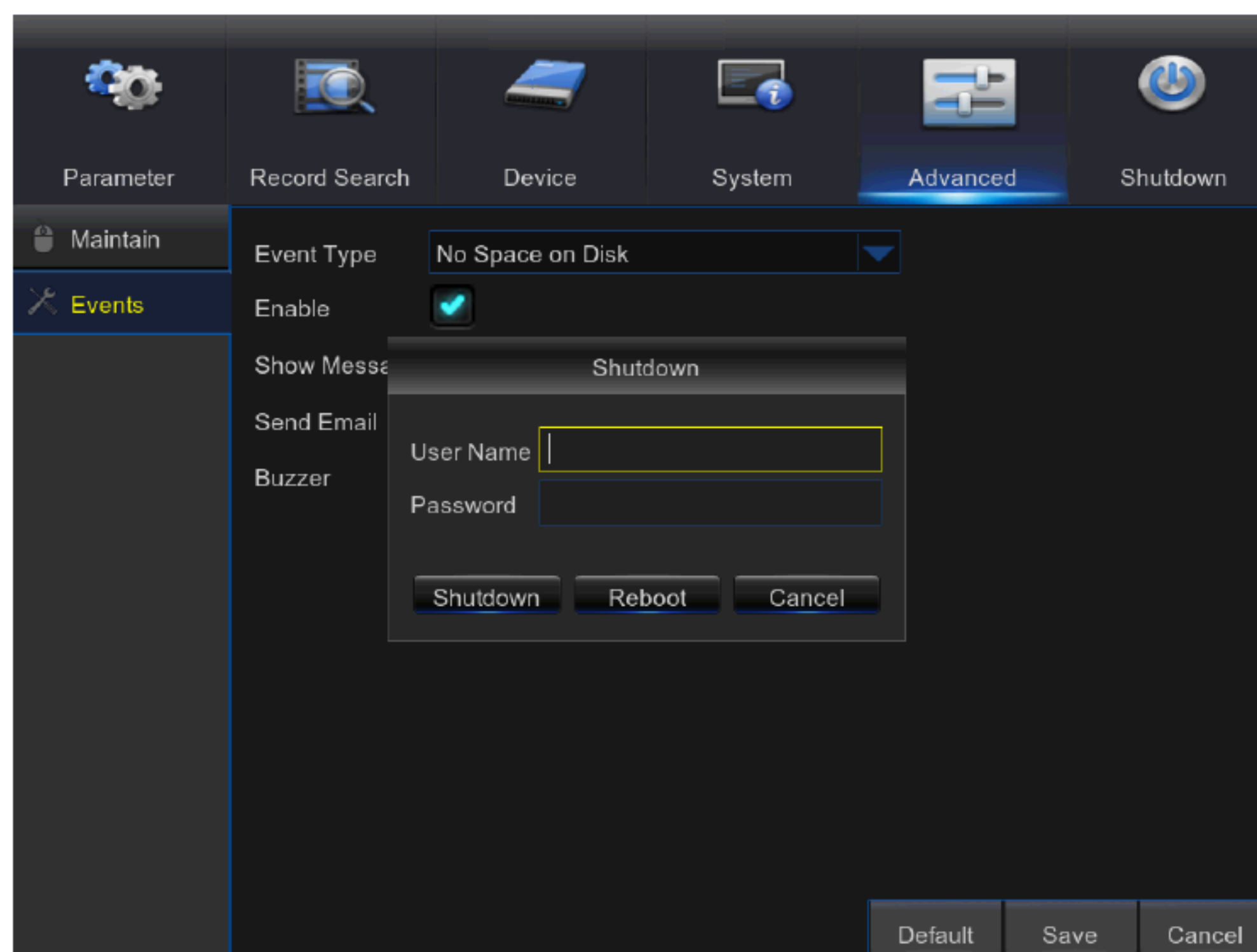

3.3 Menu Lock

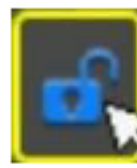
In consideration of system safety, user may click the icon  on the toolbar when he leaves away from DVR and the system interface will be locked. User has to input Device ID, User Name and Password on the login interface to unlock. In case that the password is forgotten, contact the technical personnel.

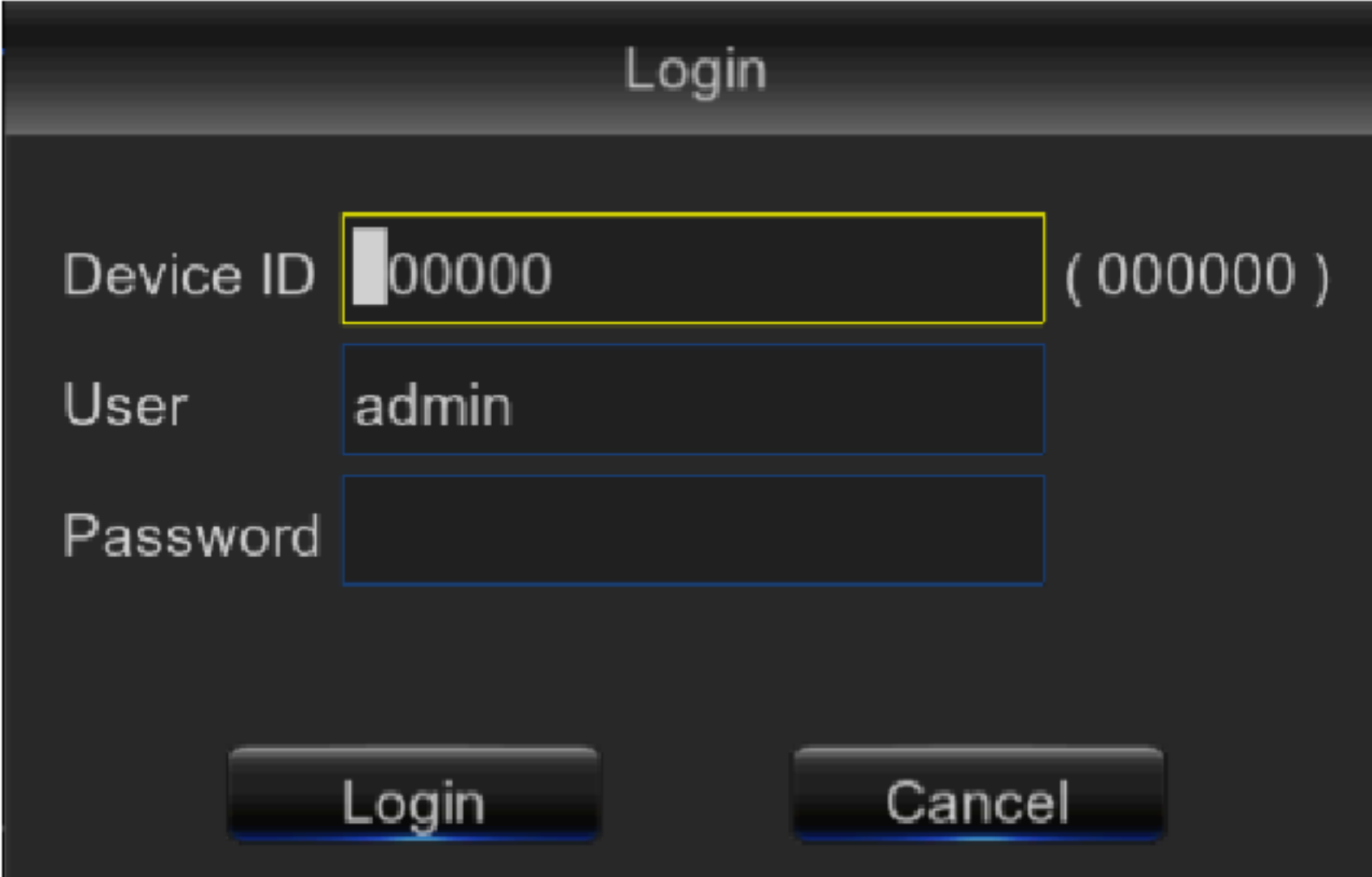

The image shows a 'Login' dialog box with a dark background. It contains three input fields: 'Device ID' with the value '00000' and a '(000000)' label to its right; 'User' with the value 'admin'; and 'Password' which is empty. At the bottom, there are two buttons: 'Login' and 'Cancel'.

Note: Administrator has all authorization of menu operation and users have limitations for authorization and have to get authorization from administrator.

3.4 Split Mode

There are many display modes in video channel, including single channel display, SEQ display and split mode.

3.5 Record Search

Click  icon on the toolbar to enter into the Record Search interface to search and playback. Refer to former section for specific operating method.

3.6 Mute

Click  icon on the toolbar or remote controller to control the mute of DVR.

3.7 Start Sequence

After set channel sequence time, click Start Sequence icon  on the toolbar to start sequence.

Chapter 4 Web Application Manager

System Environment Requirements

The minimum requirements for hardware and OS required to run Web Application are given below.

	Minimum	Recommended
CPU	Intel i3	Intel i7 or higher
RAM	4G or more	8G or more
Hard Drive	500G or more	1000G or more
Display RAM	2G or more	4G or more
Display Resolution	1280*1024	1920*1080
OS	Windows® Vista, Windows® 7 ,Windows® 8 Mac OS X® 10.9 and above Microsoft Internet Explorer (Ver. 11,10,9,8), Mozilla Firefox43.0.4,Google Chrome™ V42 Safari®5.1 and above	
DirectX	DirectX 11	
Direct3D	Acceleration Function	
Ethernet Adapter	10/100M Ethernet Adapter	
IE	Microsoft Internet Explorer (Ver. 11,10,9,8)	

4.1 Web Plugin Download and Installation

If your computer system is Windows 7, you may need to setup the user authority for remote control, or you may be unable to backup or record.

Vista System: Start→Setup→Control Panel. Set user authority in control panel as the following picture. Remove the Tick “√” in front of the option “Use UAC to help protect your computer” and confirm OK.

WIN7:

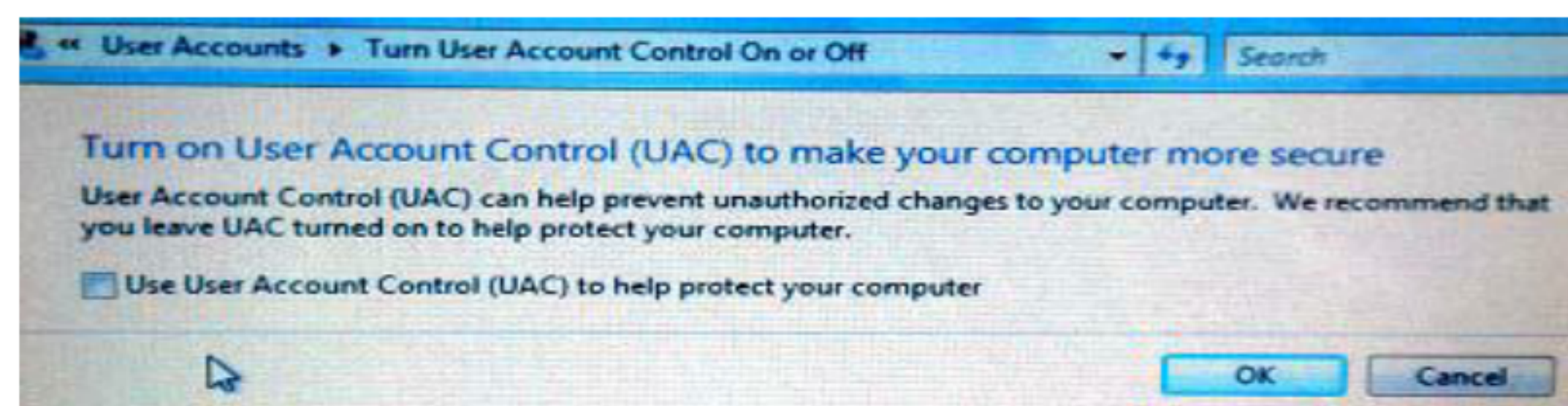
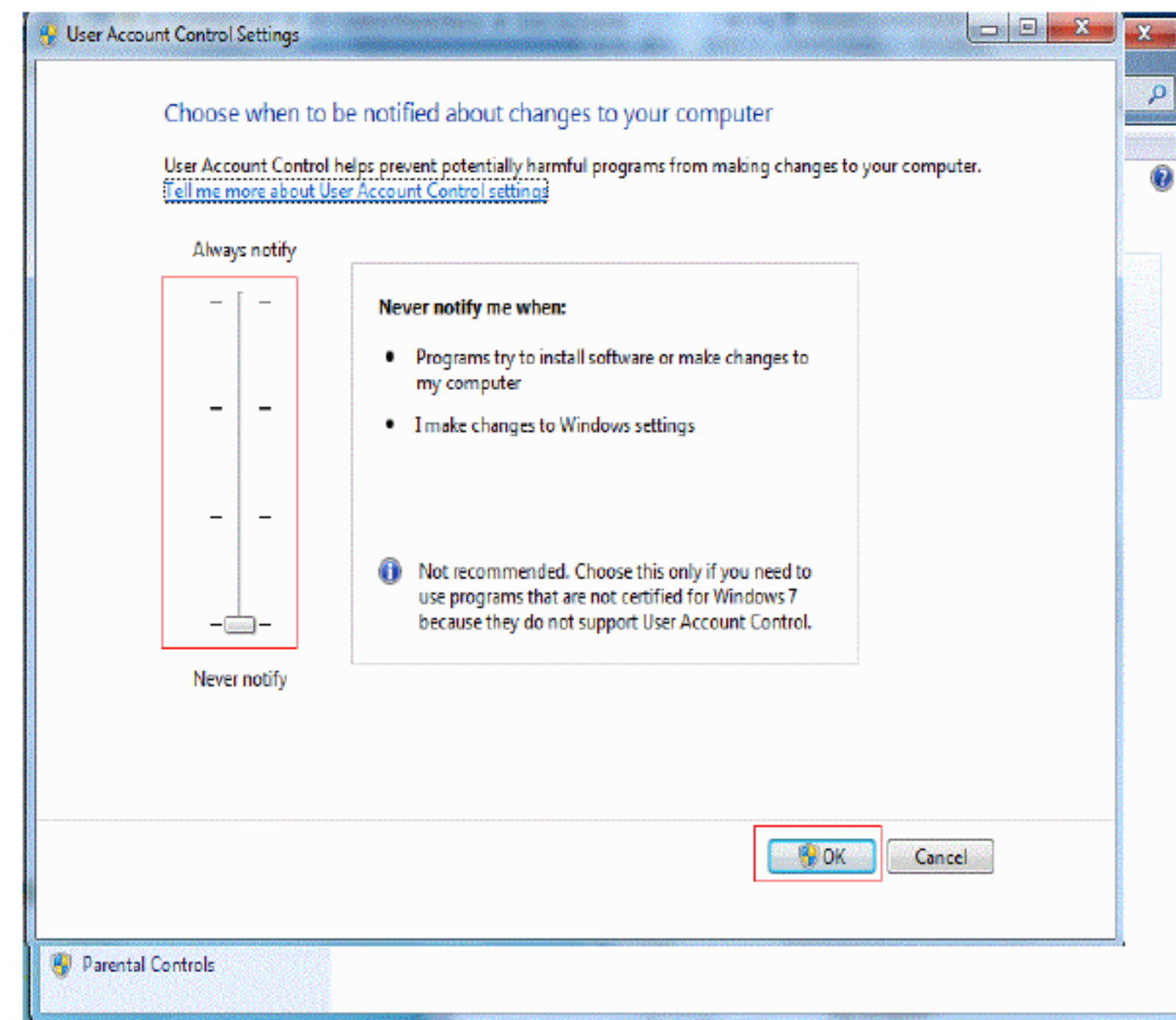
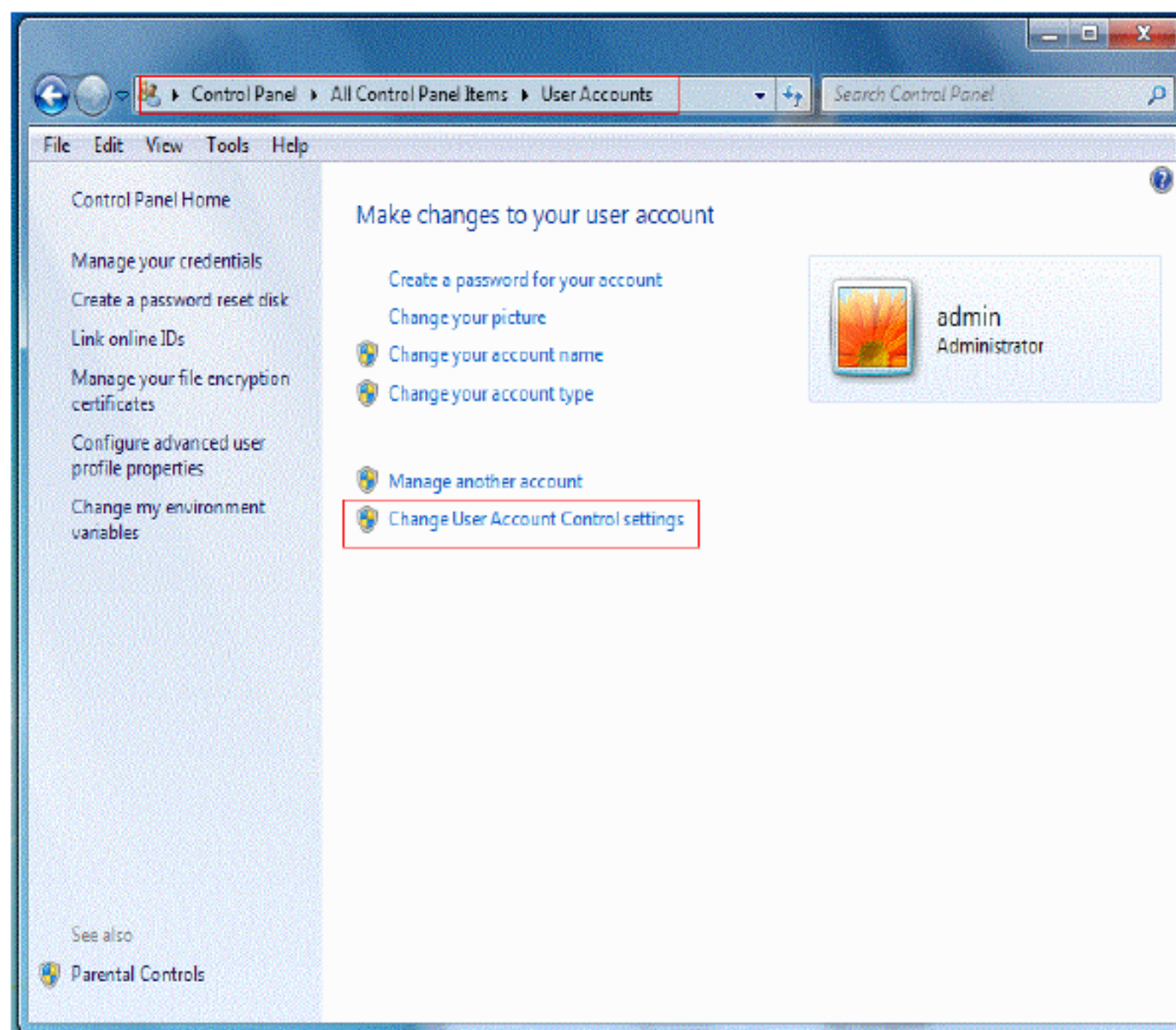

Vista

Note: If the Web plugins is not downloaded successfully, please check if your browser’s safety level or firewall setting is set too high. Please open IE browser→ [Menu Bar] Tools→ Internet options→ Security → Internet →Custom level→Enable the options.



1. Download and installation of plugin for IE

Enter IP address of DVR in address bar of IE, for example, <http://192.168.2.173:80>

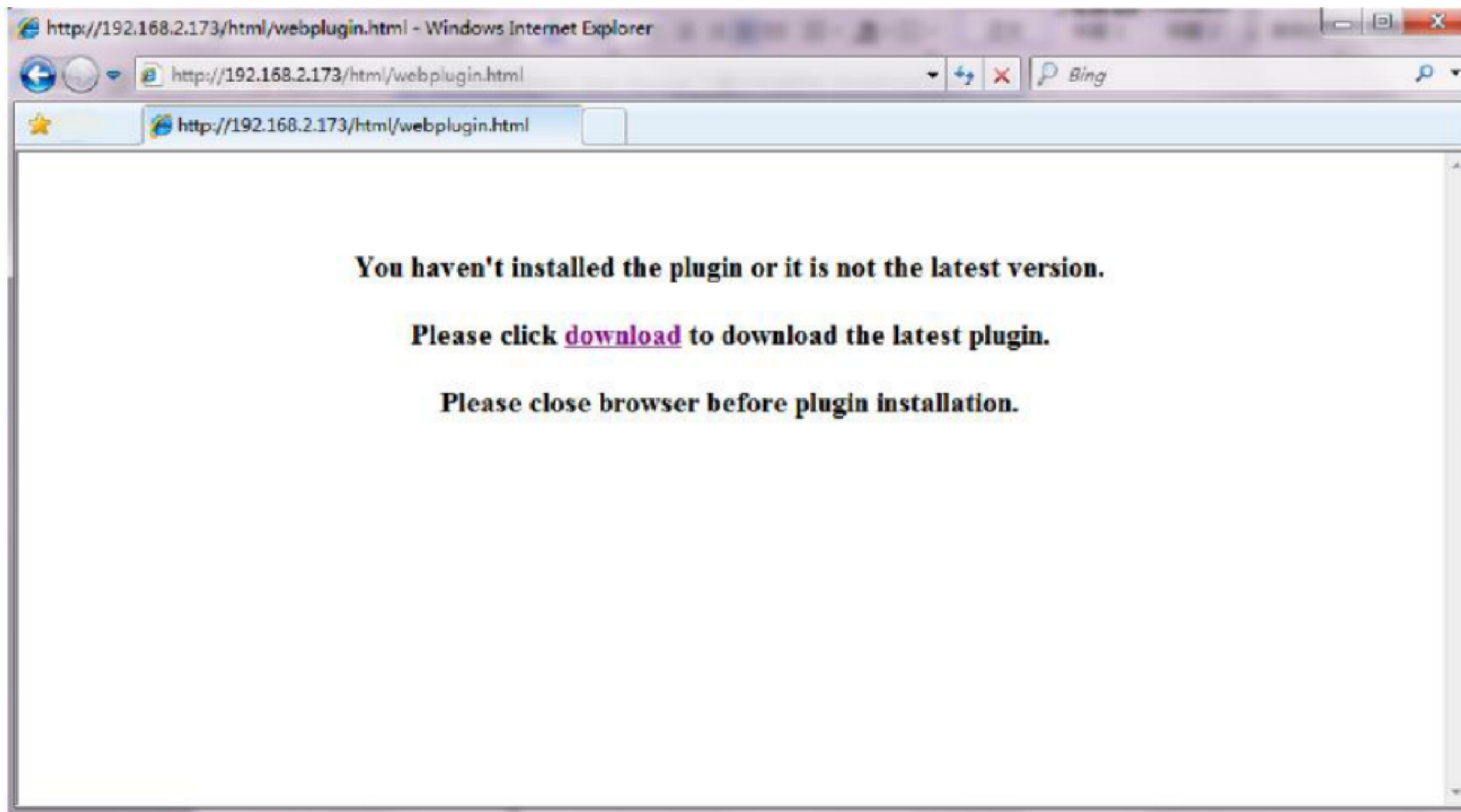

Click on "Download", and then click on "Run" in being Downloaded File - Security Warning box"

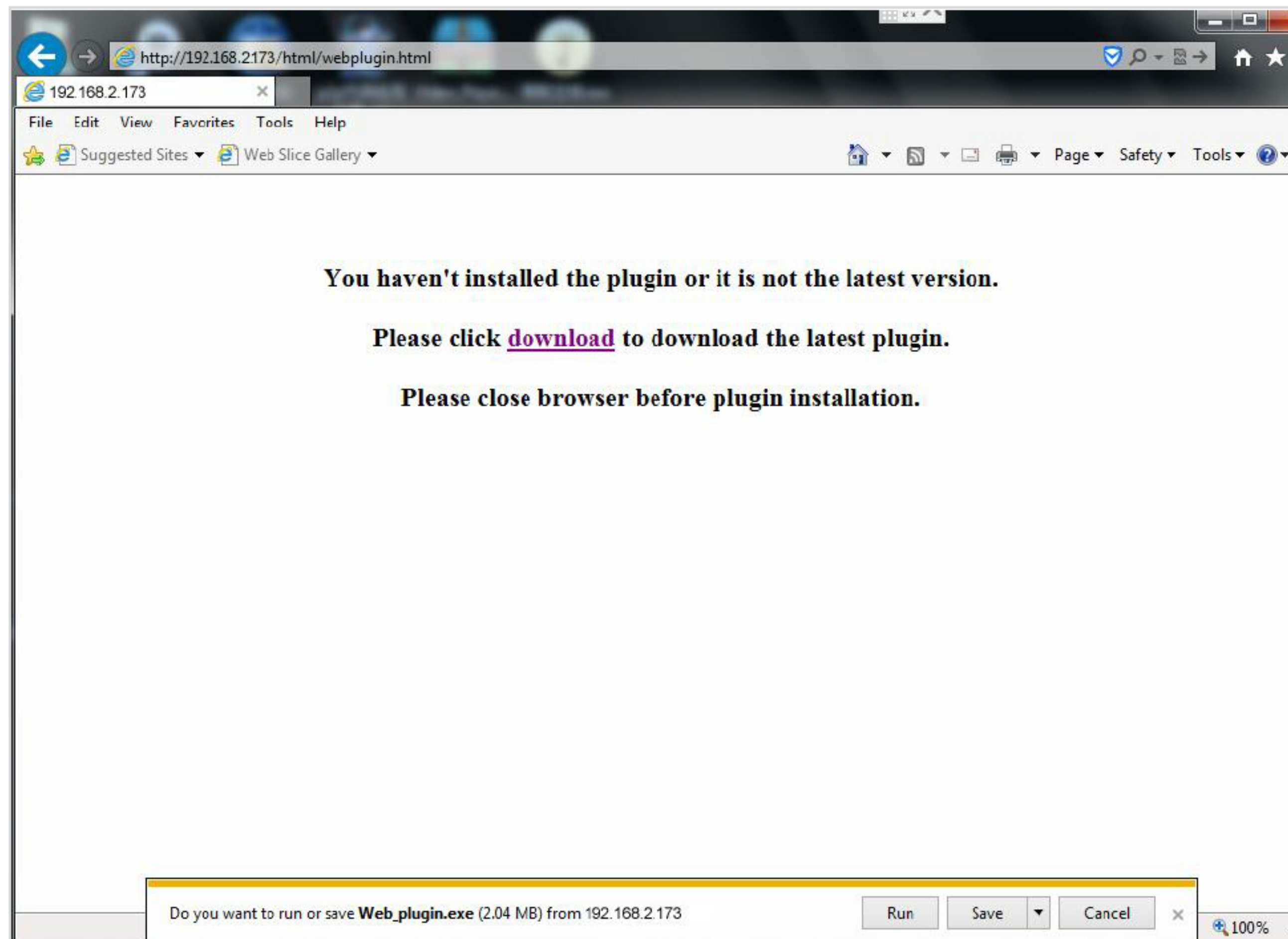

Click on "Run" in warning box reading "Do you want to run this software?"

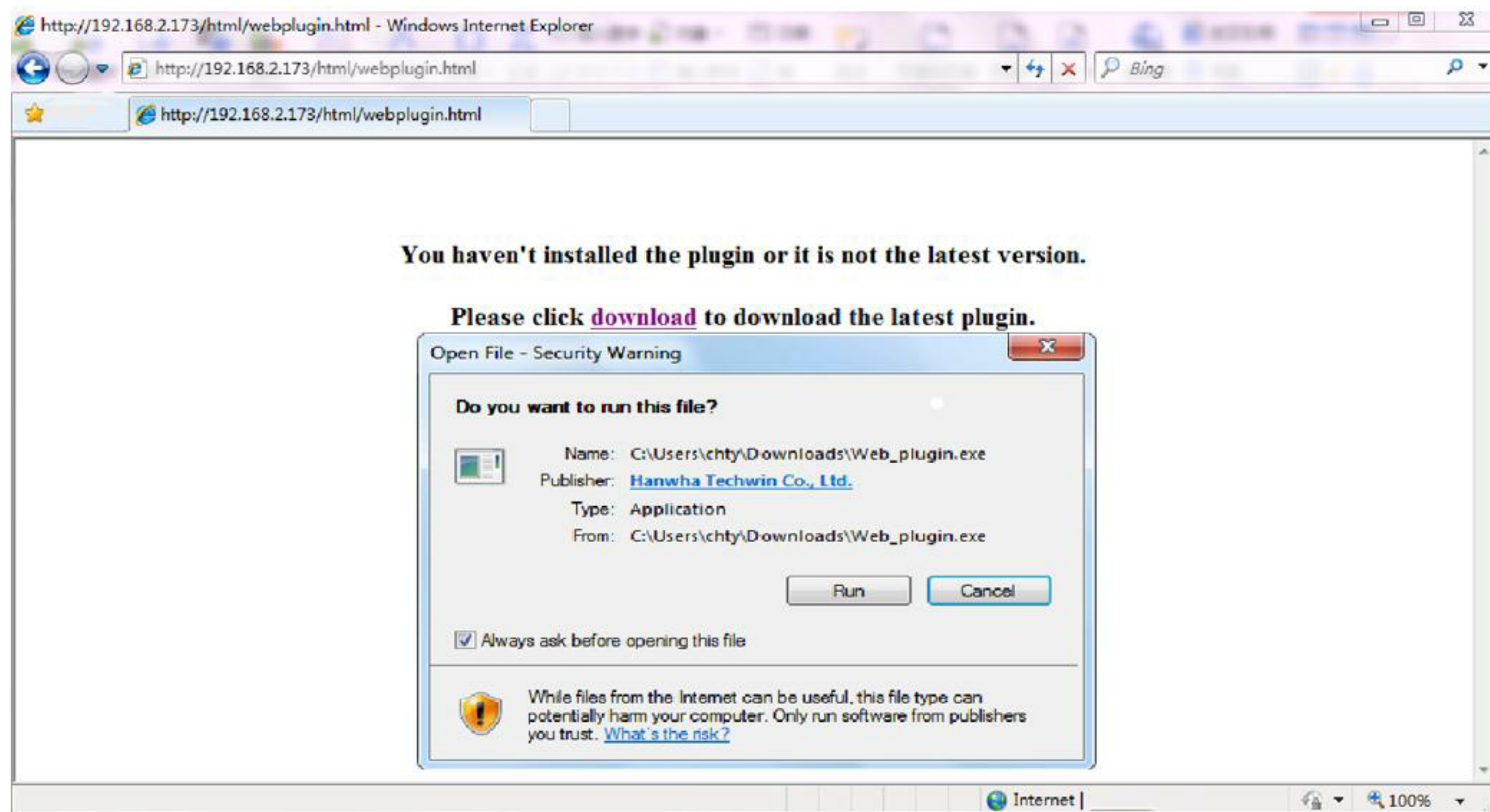

Click on "Install" in the dialog box "Setup-Web Plugin".

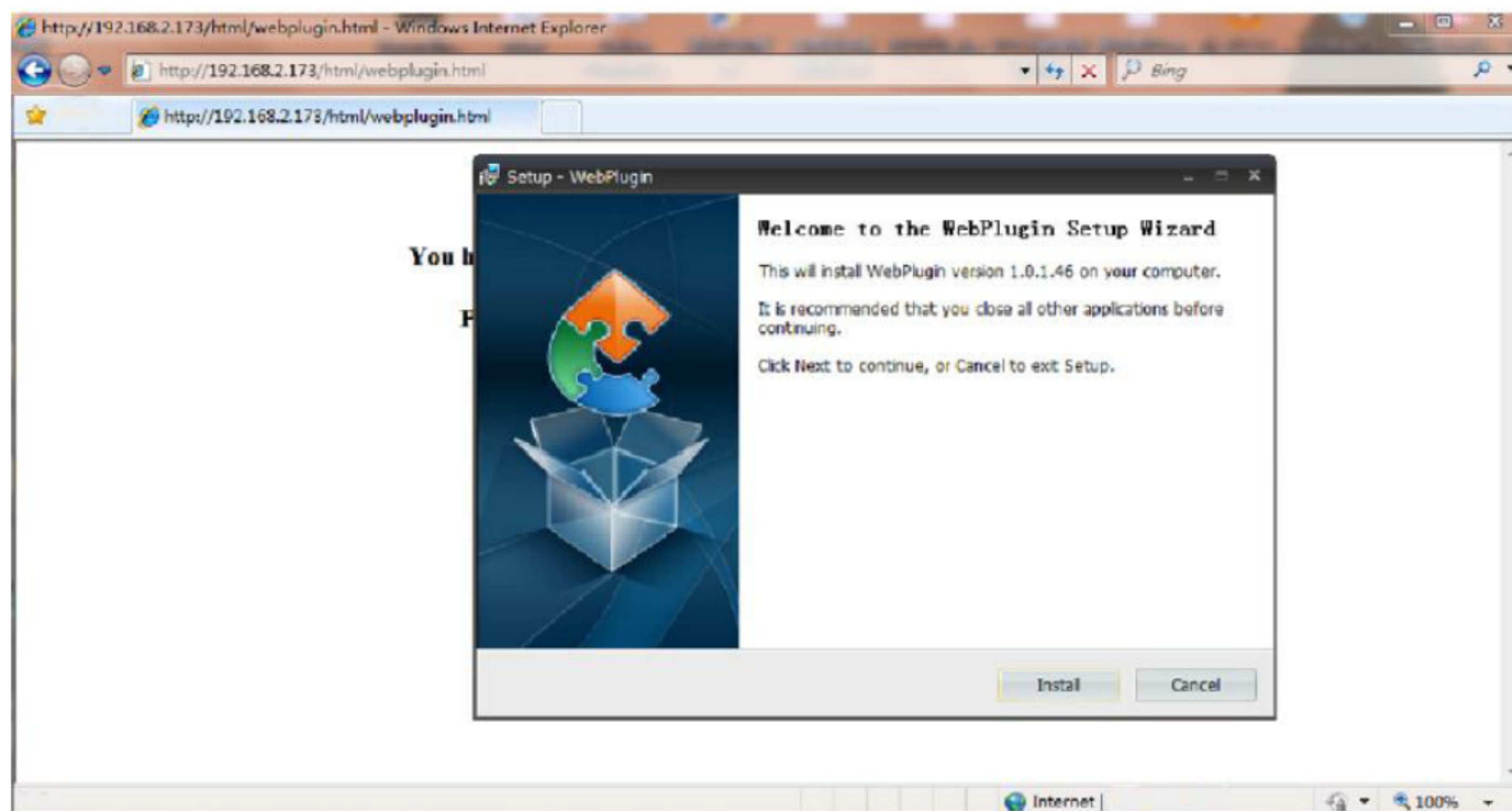

Shut down IE browser and restart it, and then enter IP address of DVR in address bar to access login page.

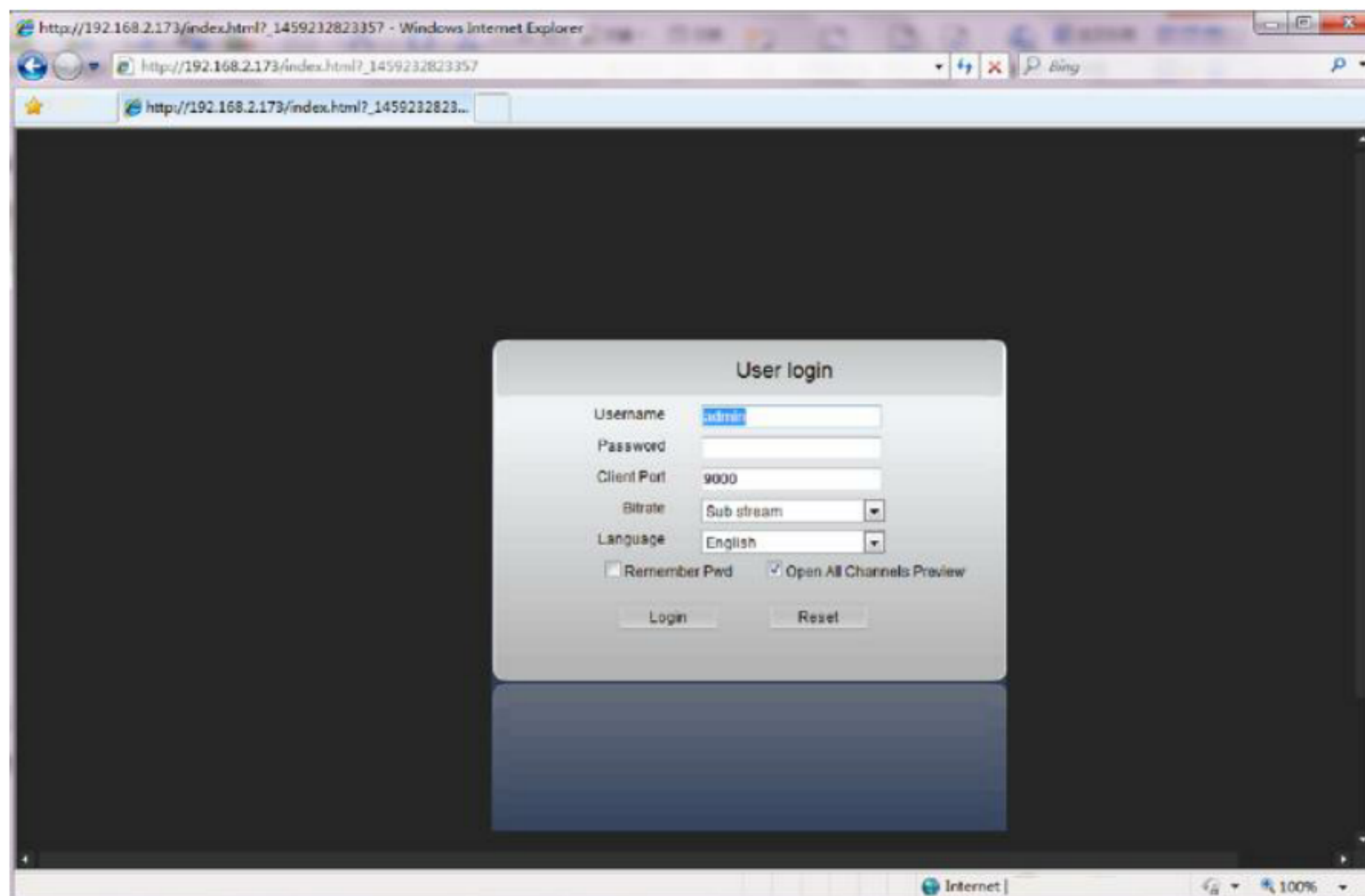

2. Download and installation of plugin for Mac SAFARI.

Enter IP address of DVR in address bar of Mac SAFARI, for example, http://192.168.2.173:80, and click on "download" to download the plugin.

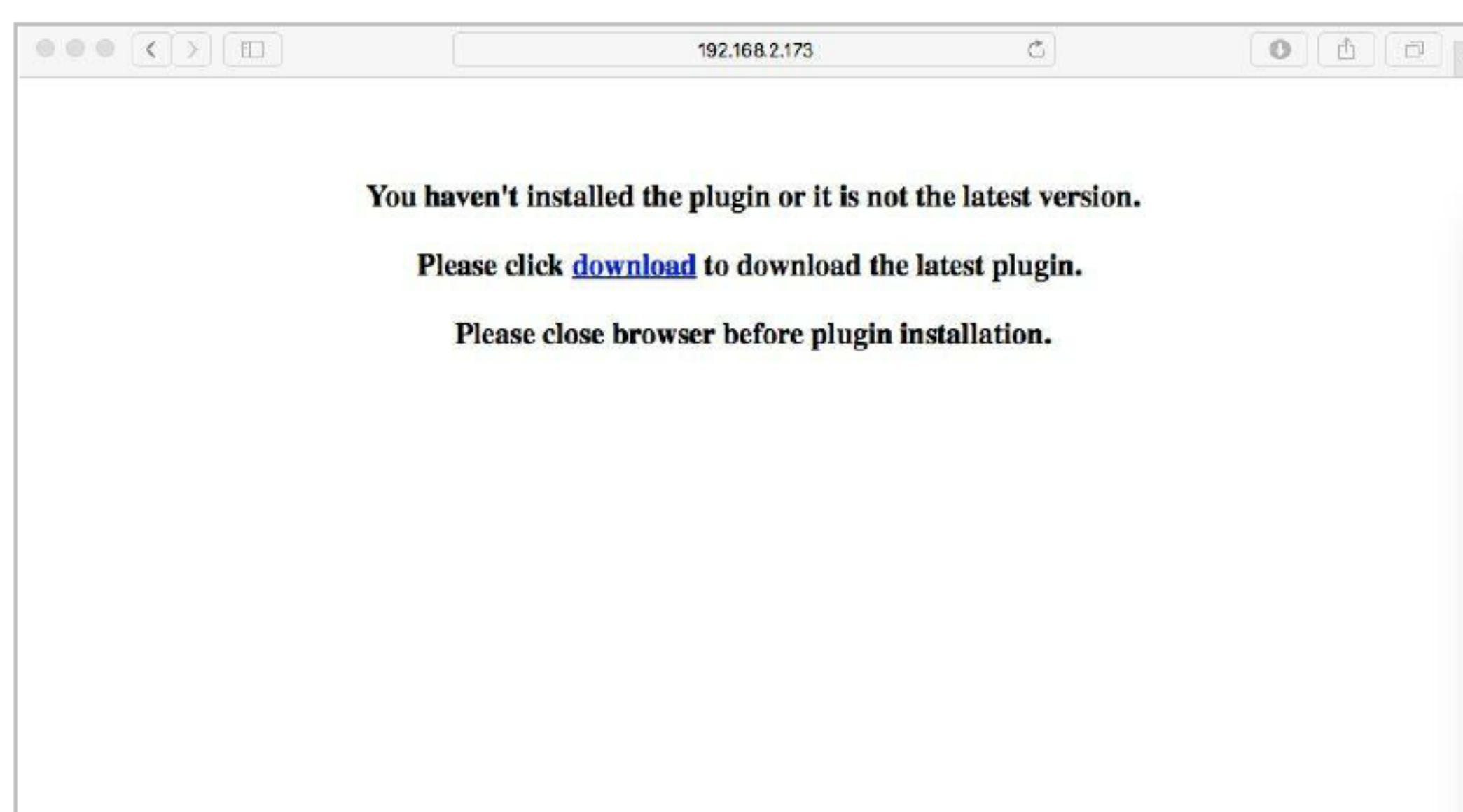

Locate the downloaded plugin "SurveillanceClient.dmg" and double click on it

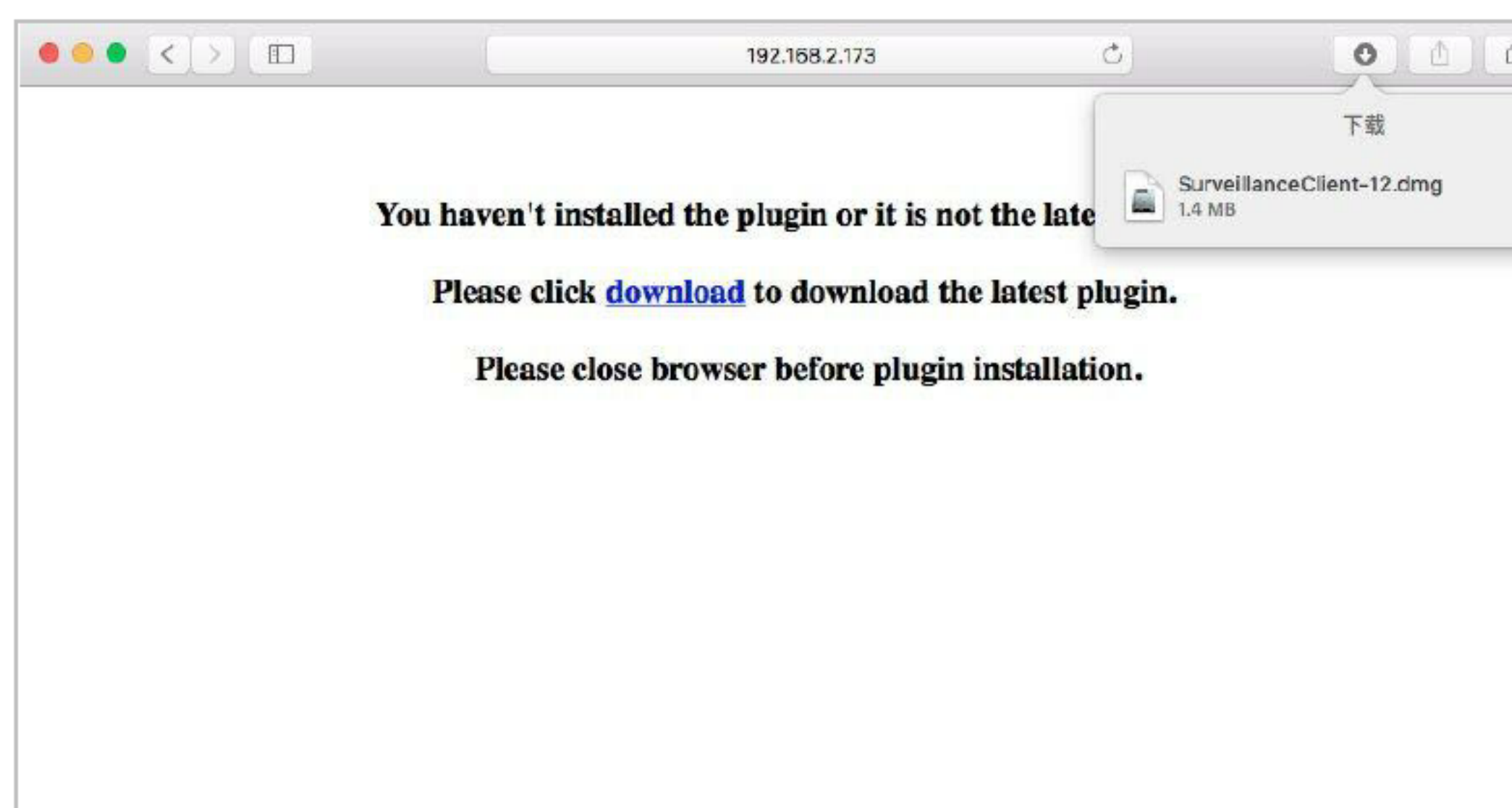

Install the plugin by double clicking on "SurveillanceClient. pkg."

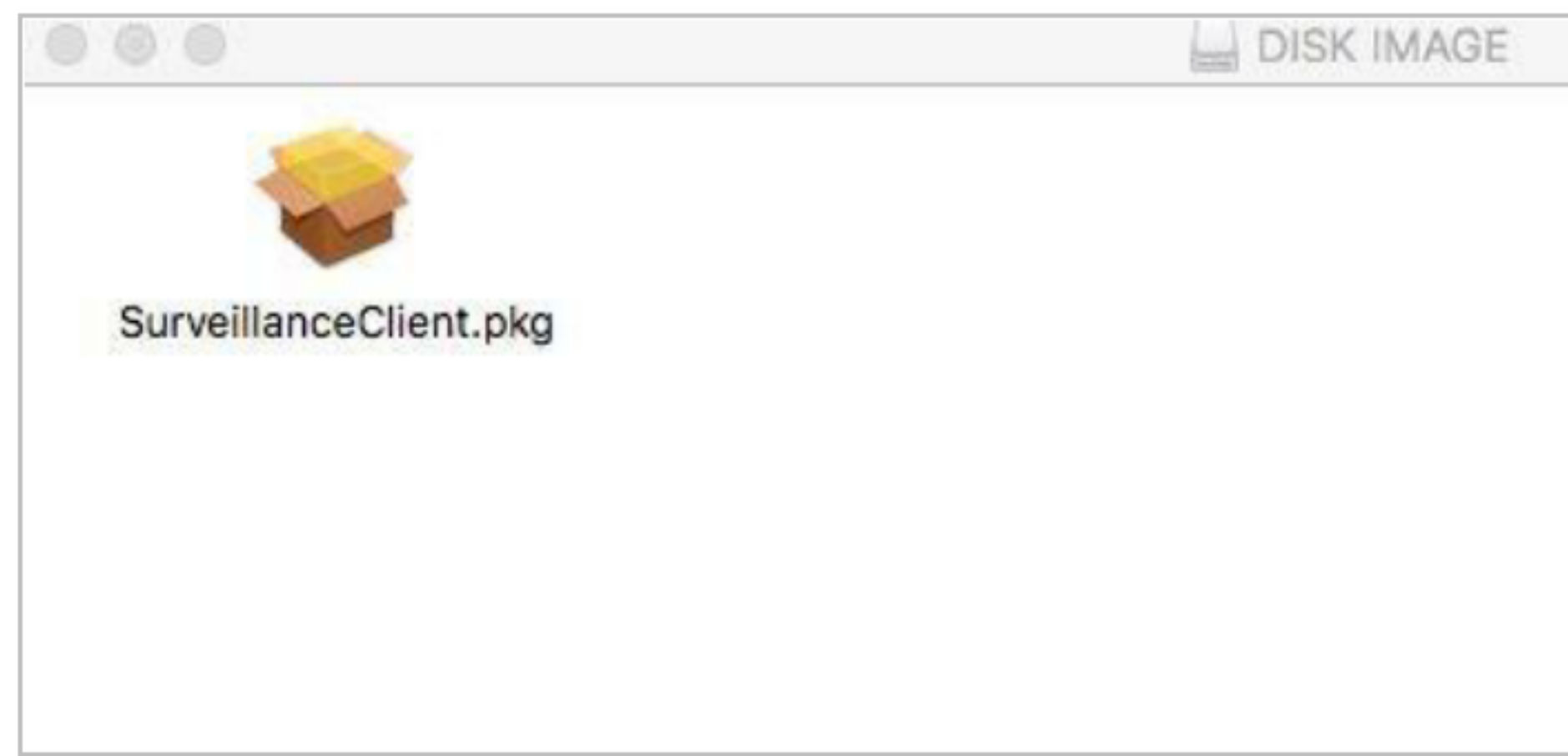

Click on "Continue" > "Install". Enter user name and password for login to Apple computer.

Click on "Install" > "Shut down" to finish installation.

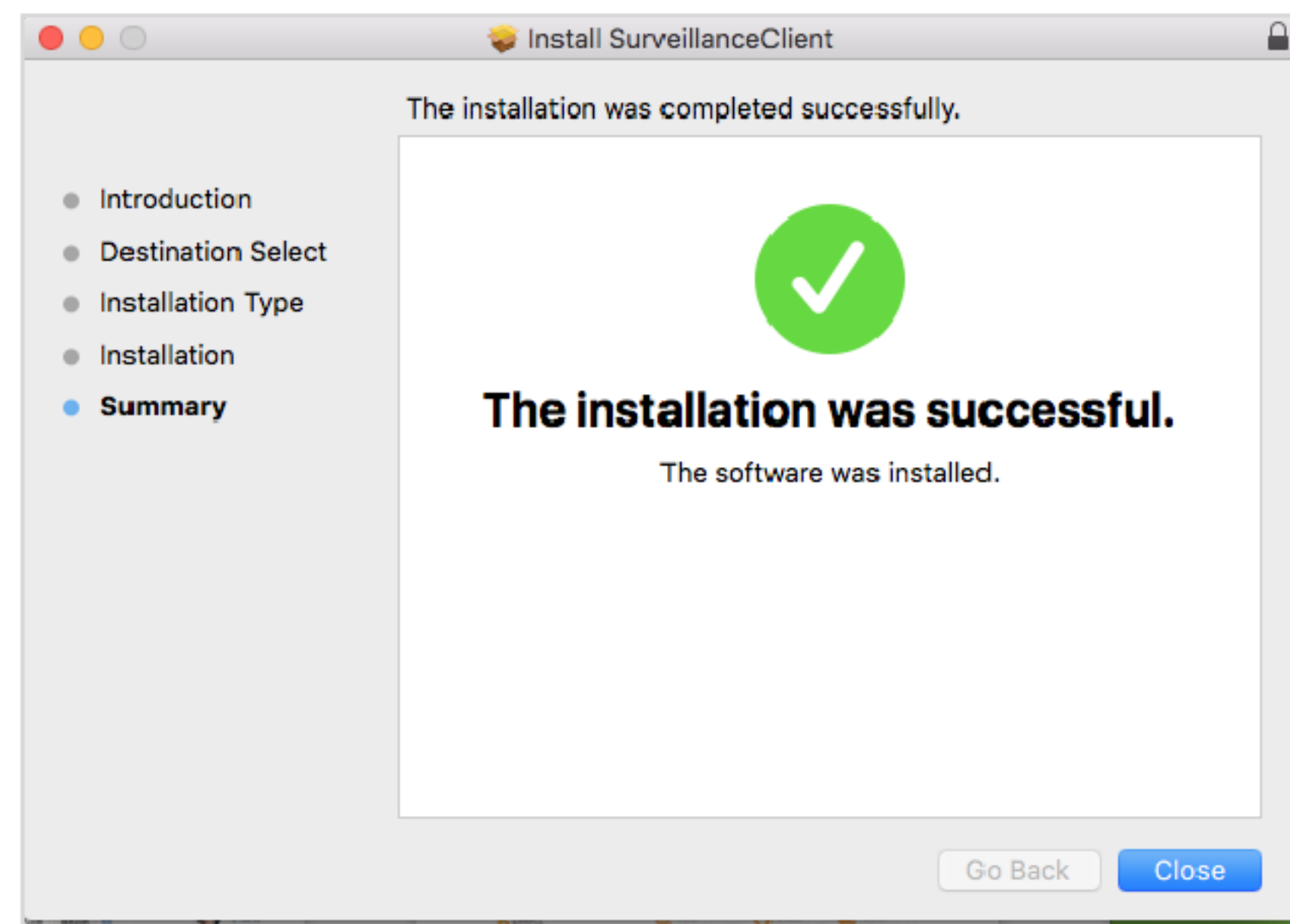
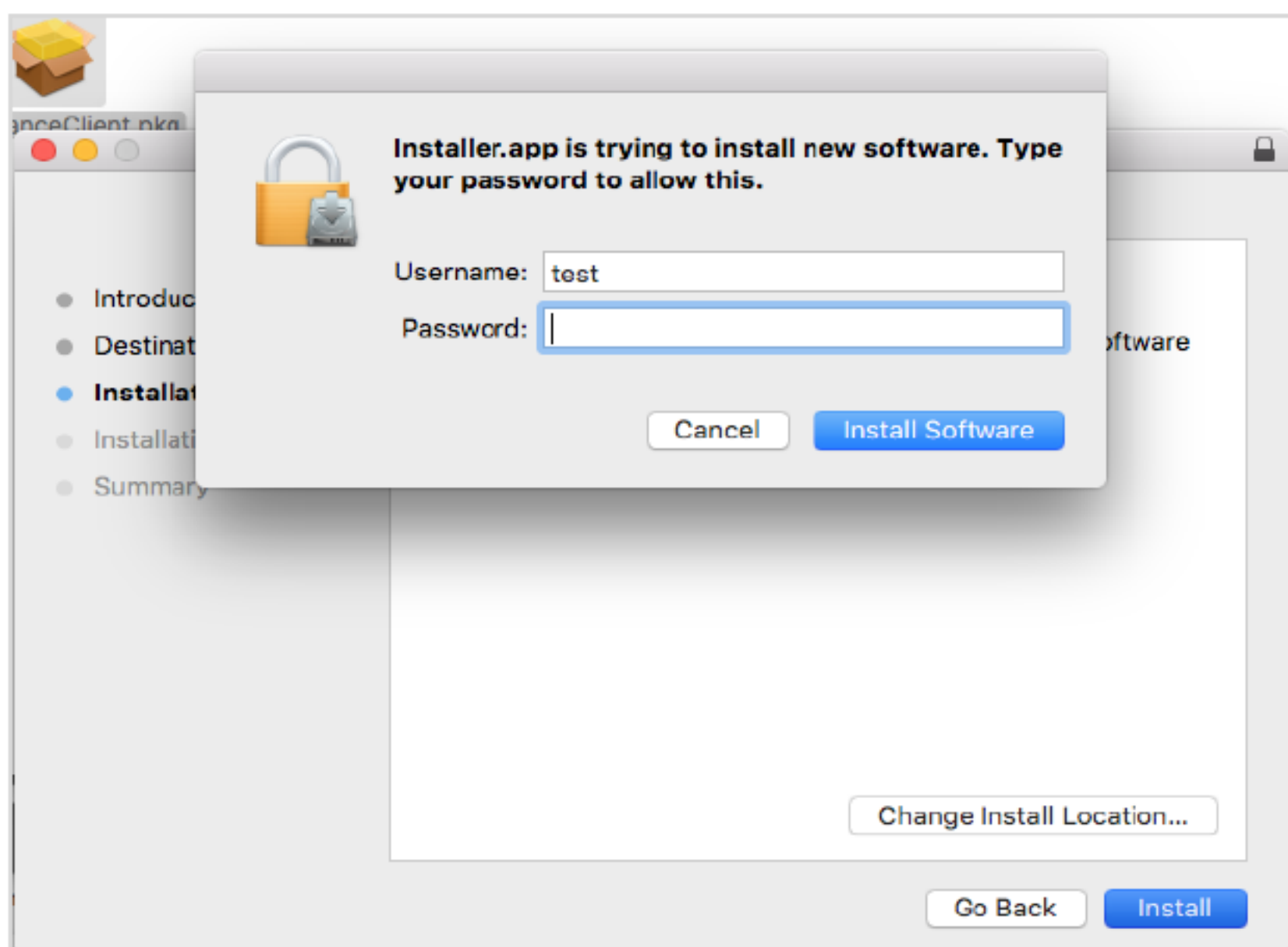
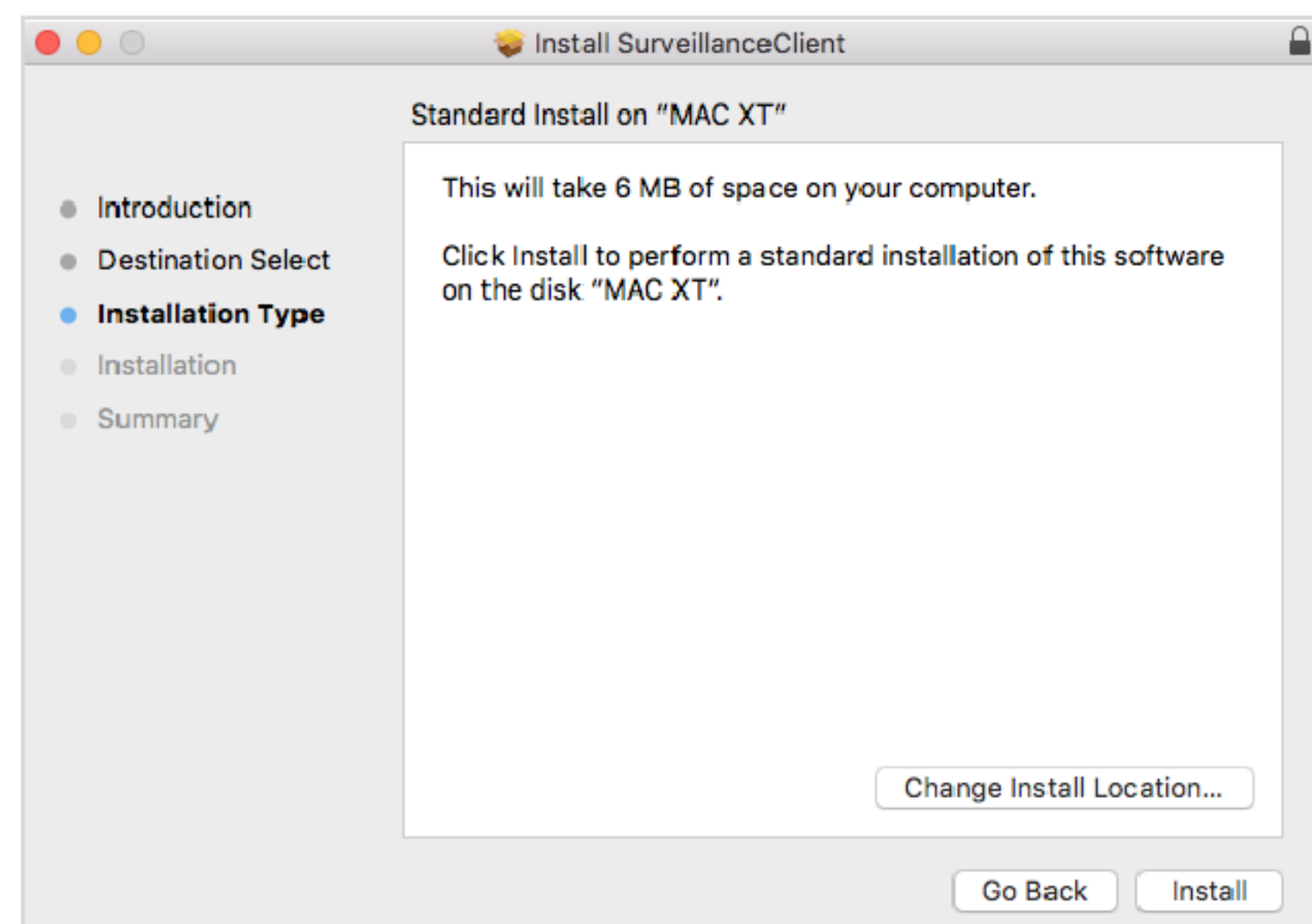
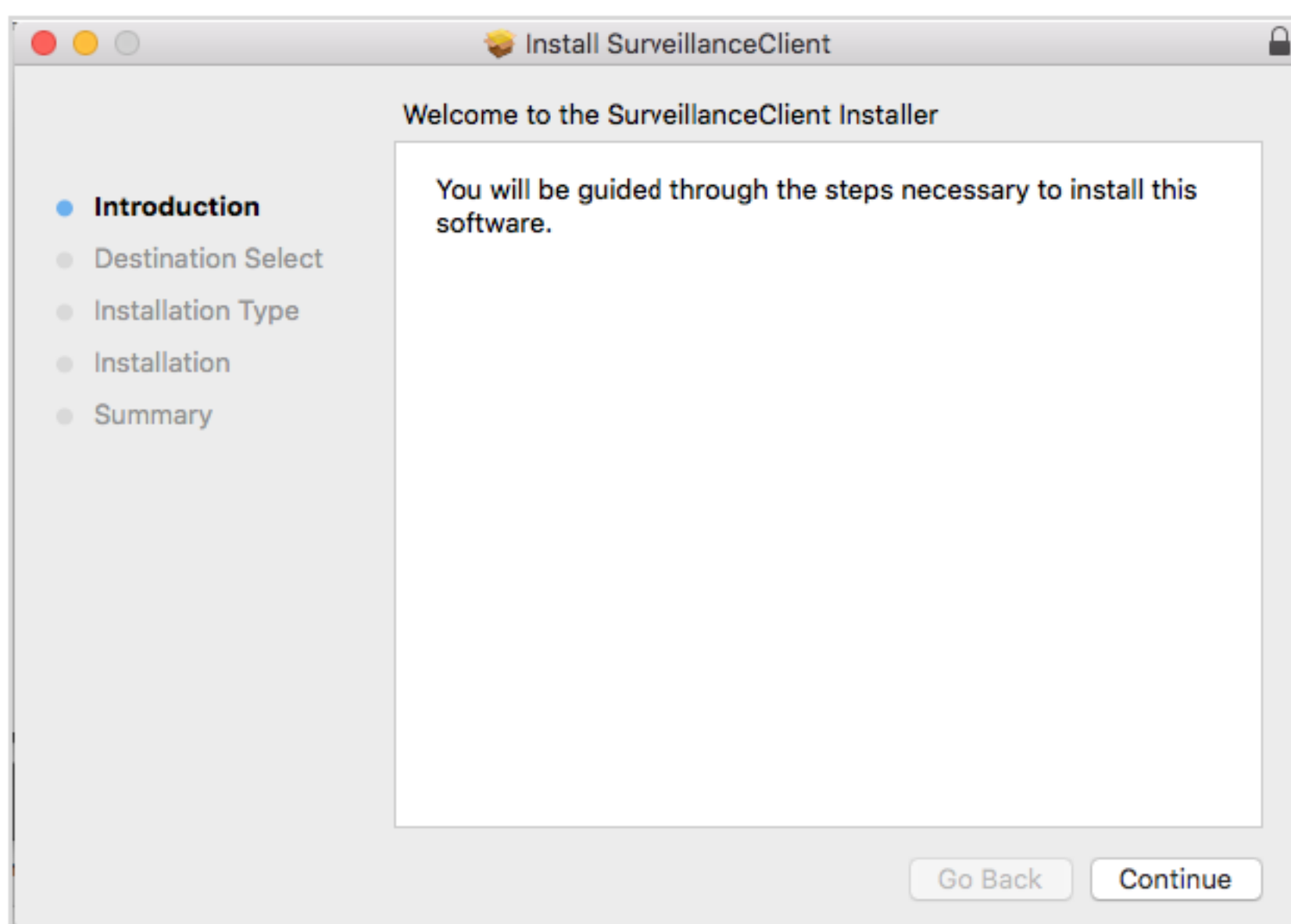

Shut down Mac SAFARI browser and restart it, and then enter IP address of DVR in address bar to access login page.

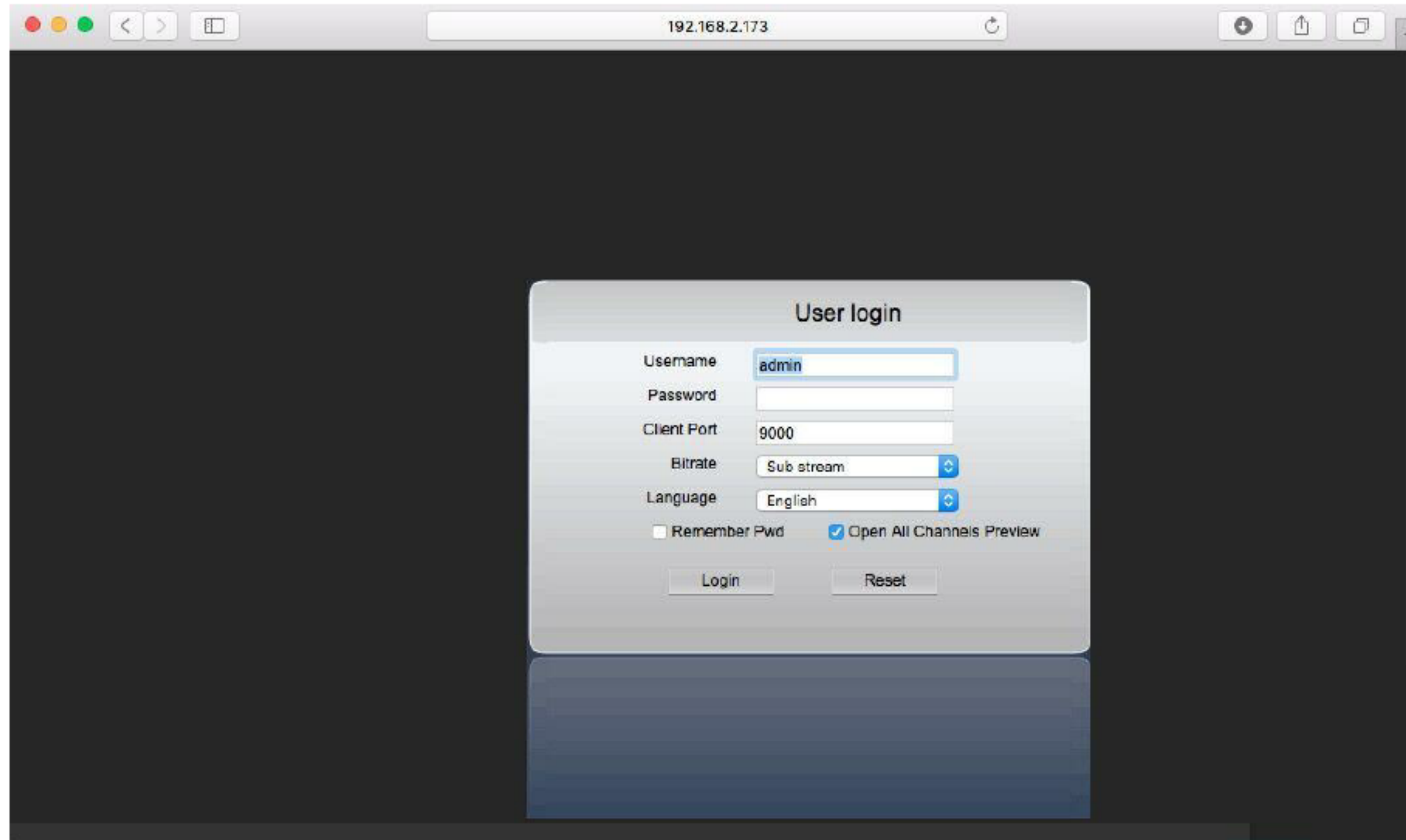

Note: The above instruction is to install the initial plug in. You can use the same plugin for IE, for Google Chrome and Firefox. If plugin for windows OS was installed on IE, Firefox or Google Chrome once, you can use IE which needs to be run as administrator, Firefox or Google Chrome to log in to DVR.

If you use Google Chrome to log in, please use Version 41 or lower. If you use V42 to V44 to log in, you need to enable NPAPI plugins. You can enter `chrome://flags/#enable-npapi` on URL bar of Google Chrome to find and enable NPAPI. Please note that it doesn't support V45 or above.

When you download and install plugin on Firefox, please close Firefox when it is prompted to. After installation is finished, you can restart Firefox to log in to the DVR.

When you do a firmware upgrade, please close the browsers in order to have the new plug in replace the old one. Depending on your situation, the plugin may not be work on your browser. In this case, please install the plugin unavailable on the CD provided. (`Web_plugin_Windows_YYYY_MM_DD.exe` for Windows system, and `SurveillanceClient_Mac_YYYY_MM_DD.dmg` for Mac).

4.2 Web Application Manager Login

After web plugins installation, please input user name and password, select Main Stream or Sub Stream (In general, select main stream for intranet and sub stream for extranet), and input HTTP port number and select language in the interface. There is an option for opening all channel preview, select it to open all live pictures. Press Login to log in client and remotely visit DVR. The default password is blank and administrator is authorized to modify the password. Set password as per introductions of user management in system setting.

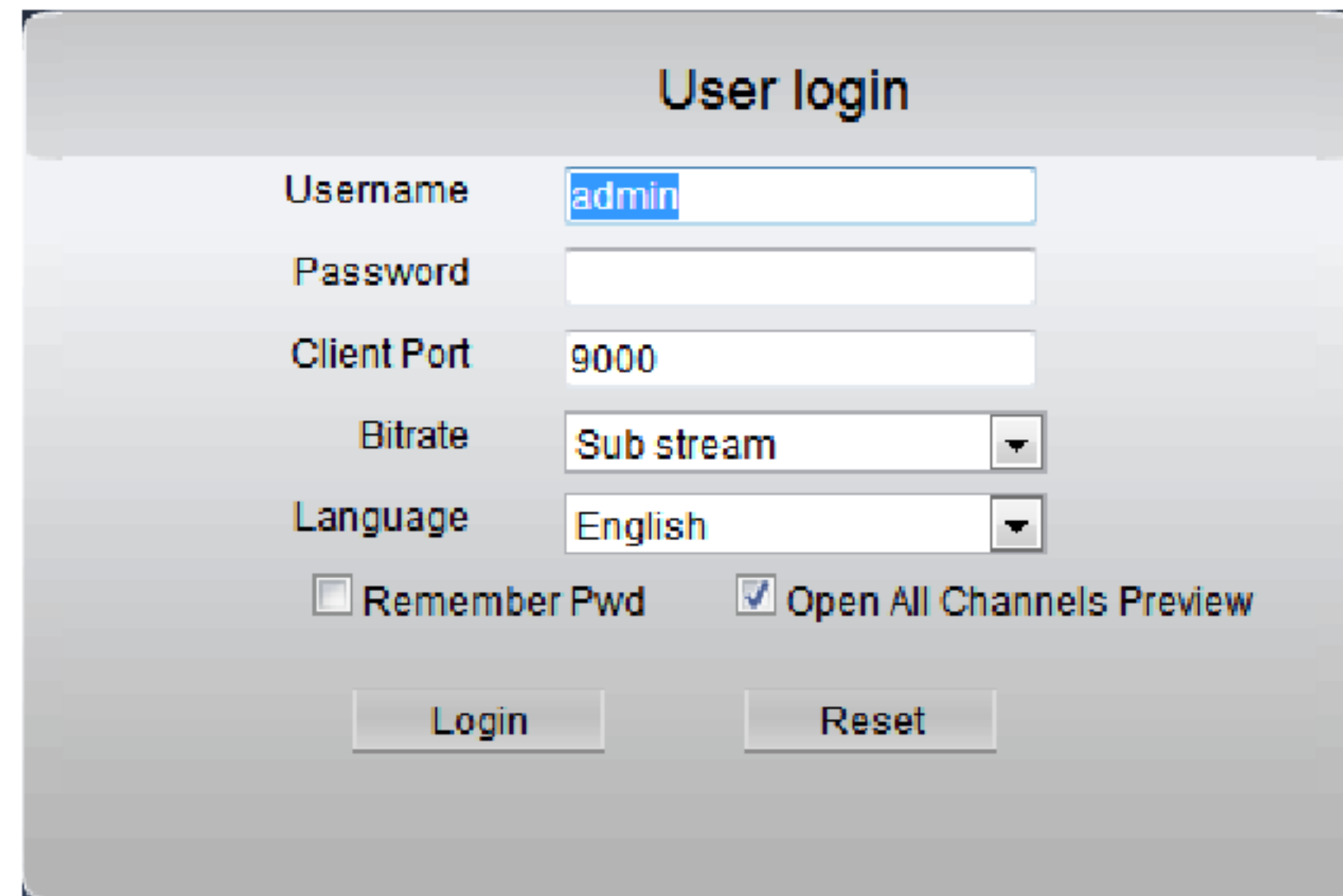

The image shows a 'User login' form with the following fields and options:

- Username:** admin
- Password:** (empty)
- Client Port:** 9000
- Bitrate:** Sub stream
- Language:** English
- Remember Pwd
- Open All Channels Preview
- Login** button
- Reset** button

After successfully log in, it will enter the real-time monitoring interface and connect video automatically.

4.3 Live Interface

Log in and enter into the live interface.

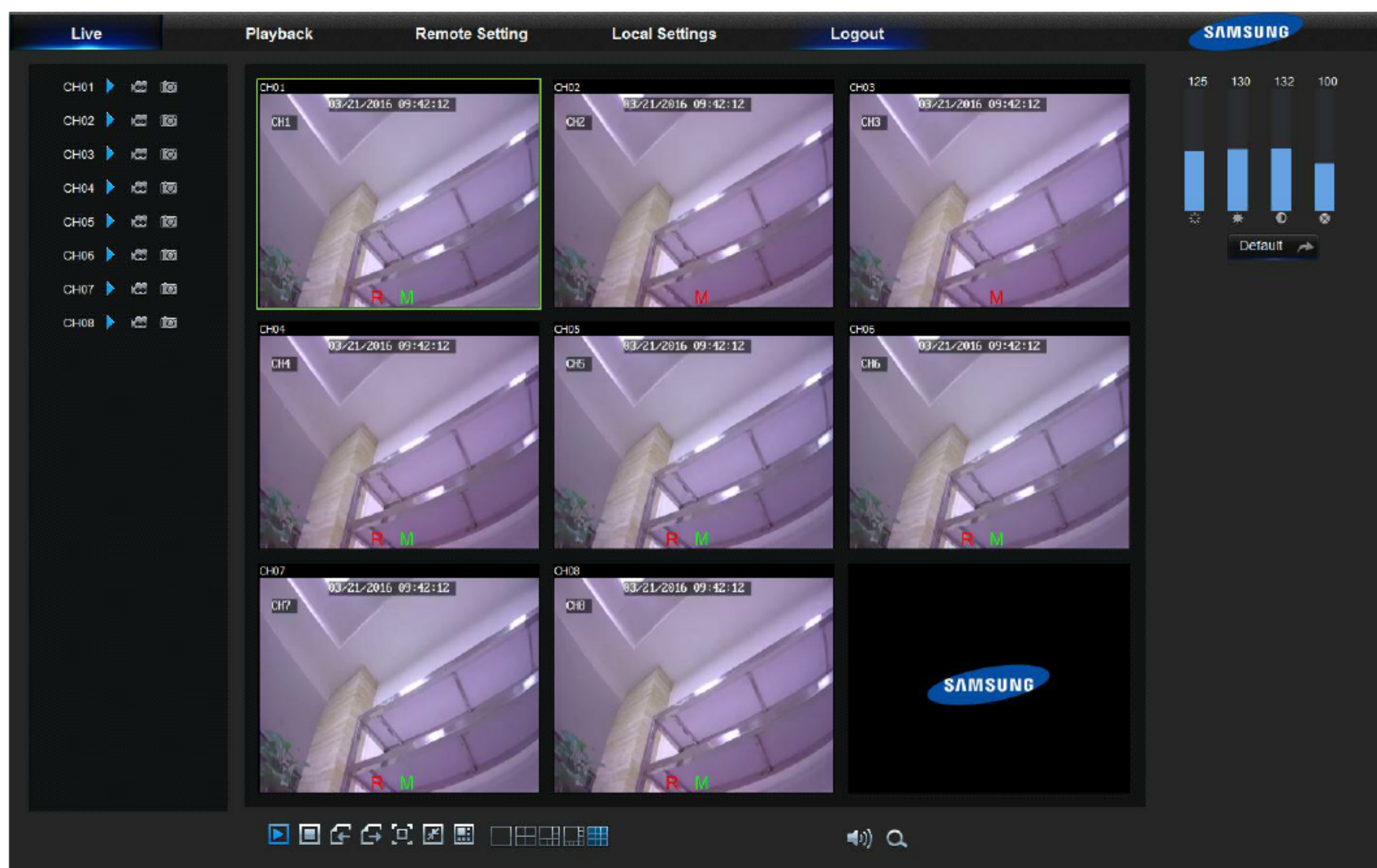

4.3.1 Menu Bar

Menu Bar: Live, Replay, Configuration, Local Setting and Logout.

1. Live Display

Log in the Web Application Manager, system will be defaulted to enter into <Live> interface. You can click [Play] button to Open/close live images, on-spot record, capture, and many live display modes.

Buttons on a single live interface:



: Volume switch



: Record switch: the remote record switch of client. Record will be automatically saved to a specified position on PC after the function is enabled.



: Snapshot: Capture the selected live image and save it to a specified position on PC. The image is saved as *.bmp format.



: Open or close the images on Live window.



: Switch display mode in channel window



: Open all the Live channels.



: Close all the Live channels



: Display previous group of channels



: Display next group of channels



: Click to maximize the current window to full screen. Right click to popup menu option and select Exit Full Screen.

2. Video Control

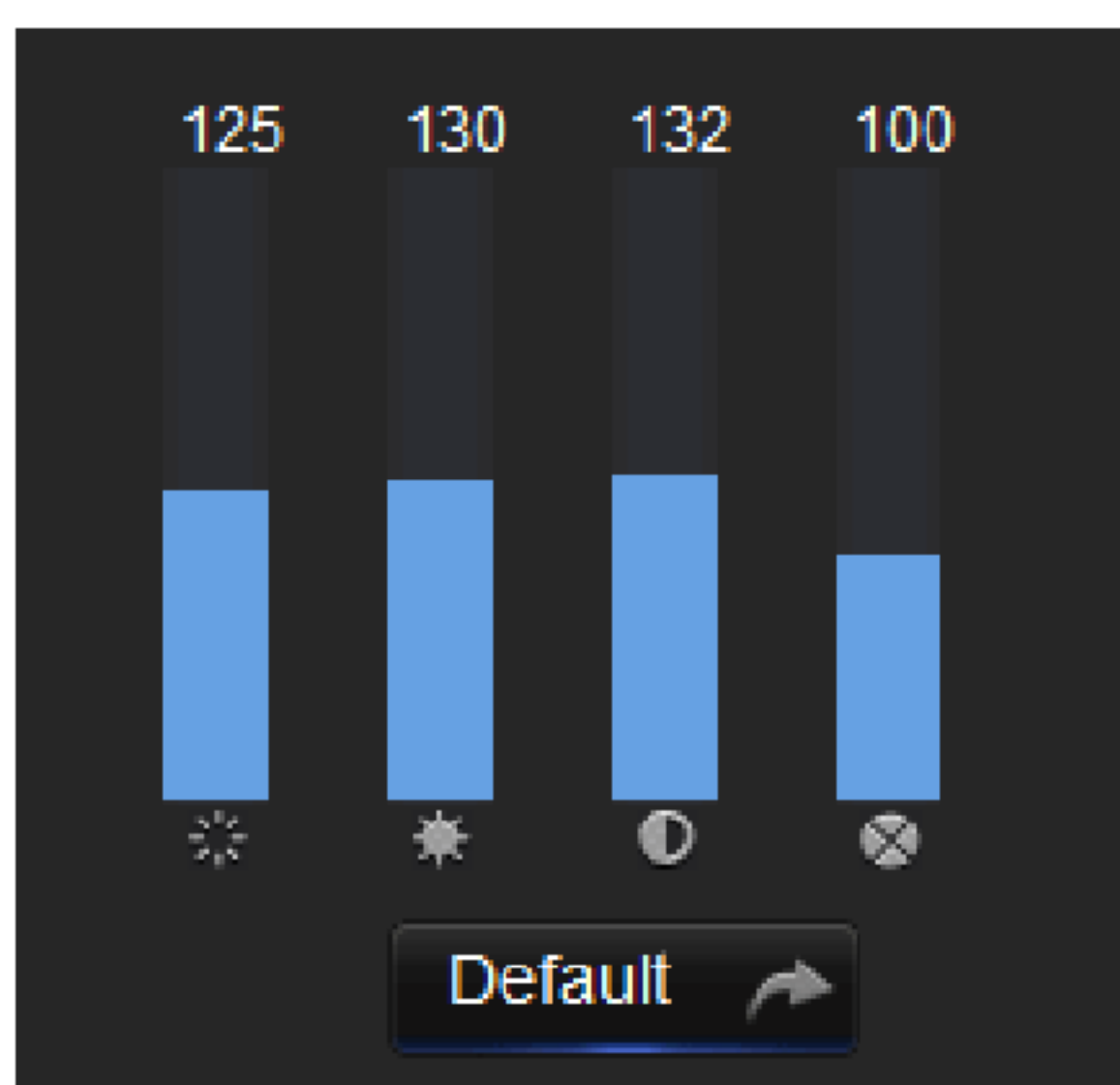

: Adjust the chromaticity of video



: Adjust the brightness of video



: Adjust the contrast of video



: Adjust the saturation of video

4.3.2 Playback

Click  to enter into Playback interface to remotely view the records in DVR HDD.

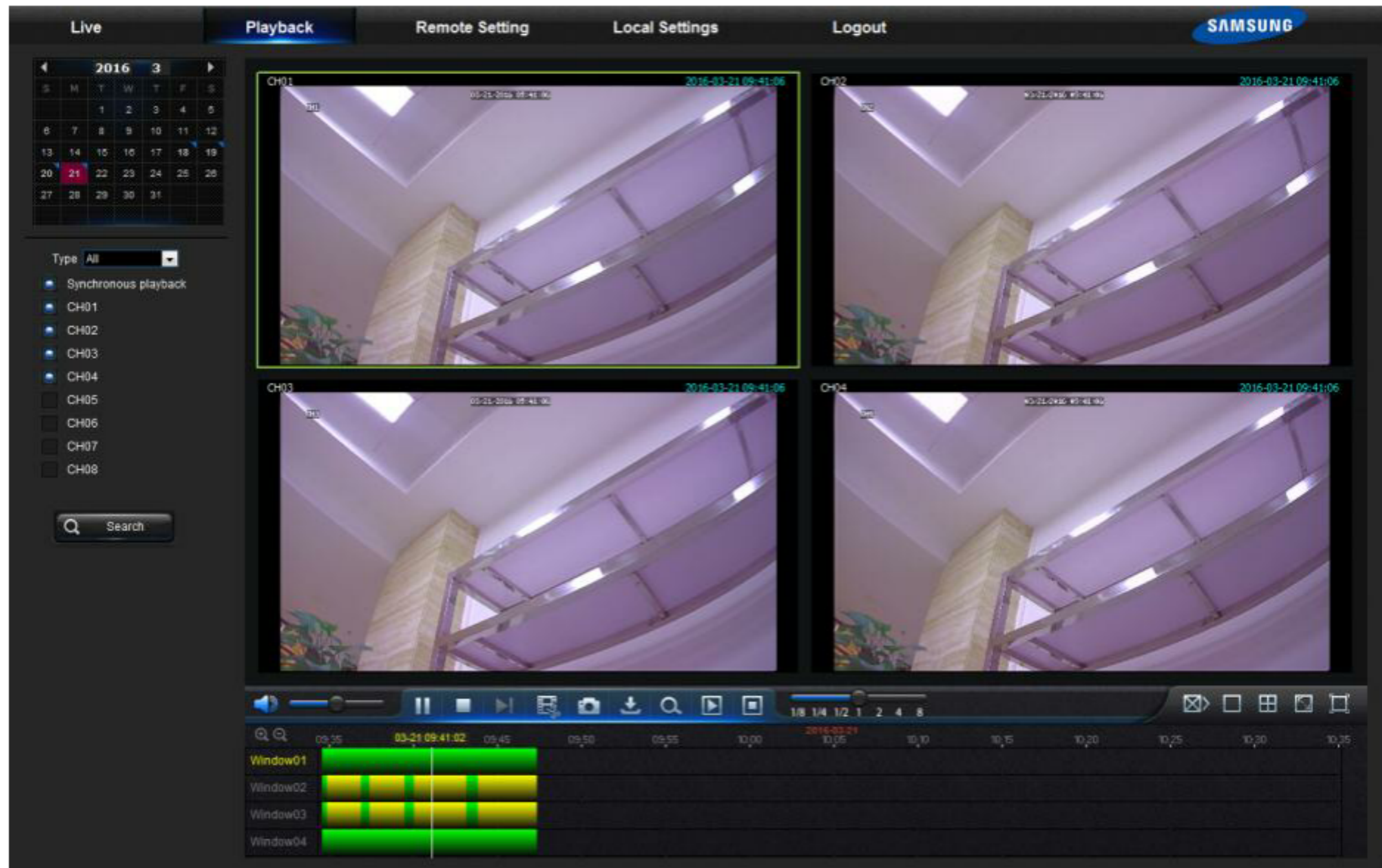

It supports 1 to 4 channel record playback.

1. Record Search

Record playback procedure

Firstly, select the date you want to check and tick 1 to 4 channels. Any record files in current channel at current date will be displayed in the status bar of the interface.

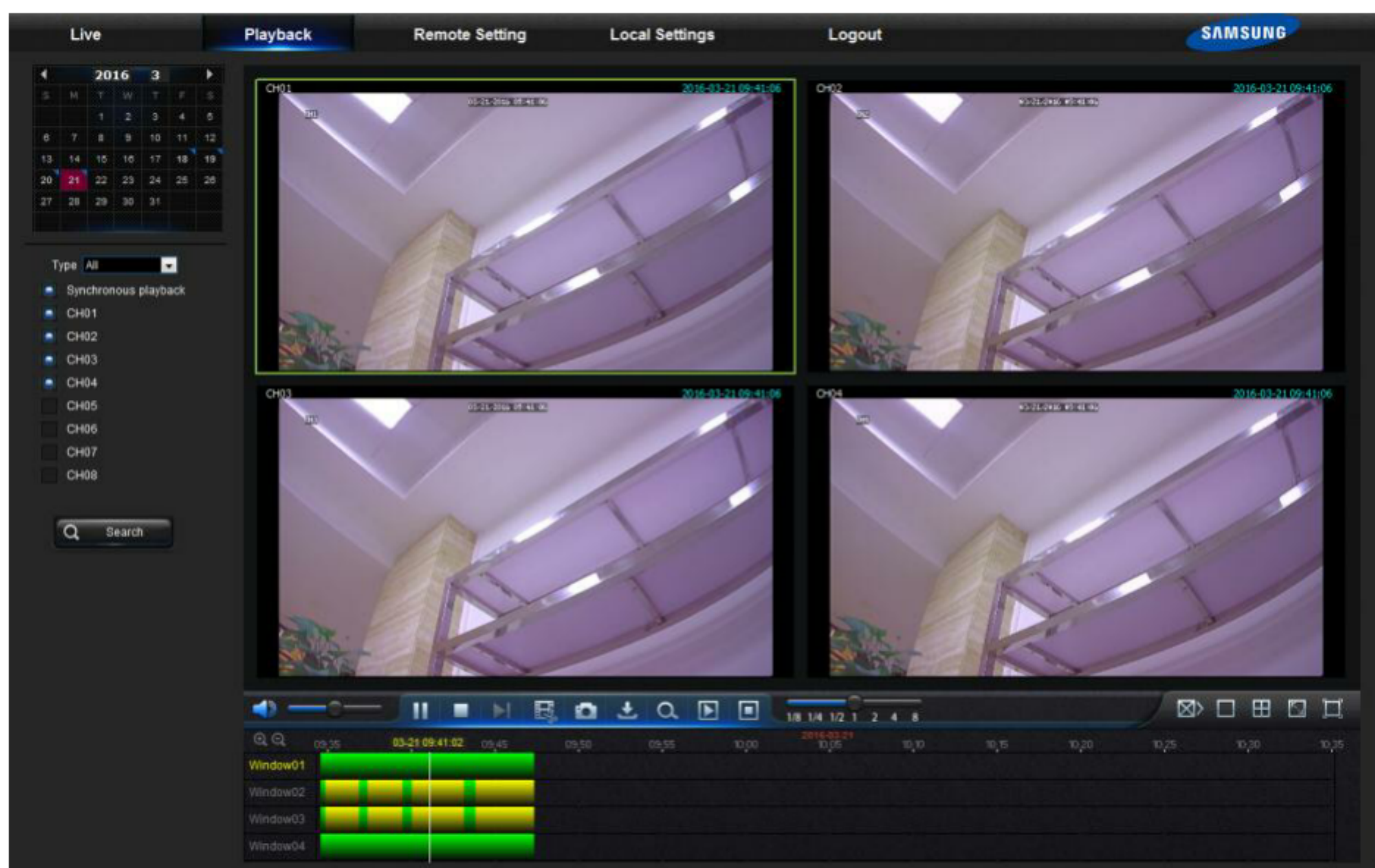

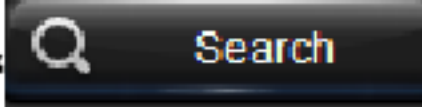

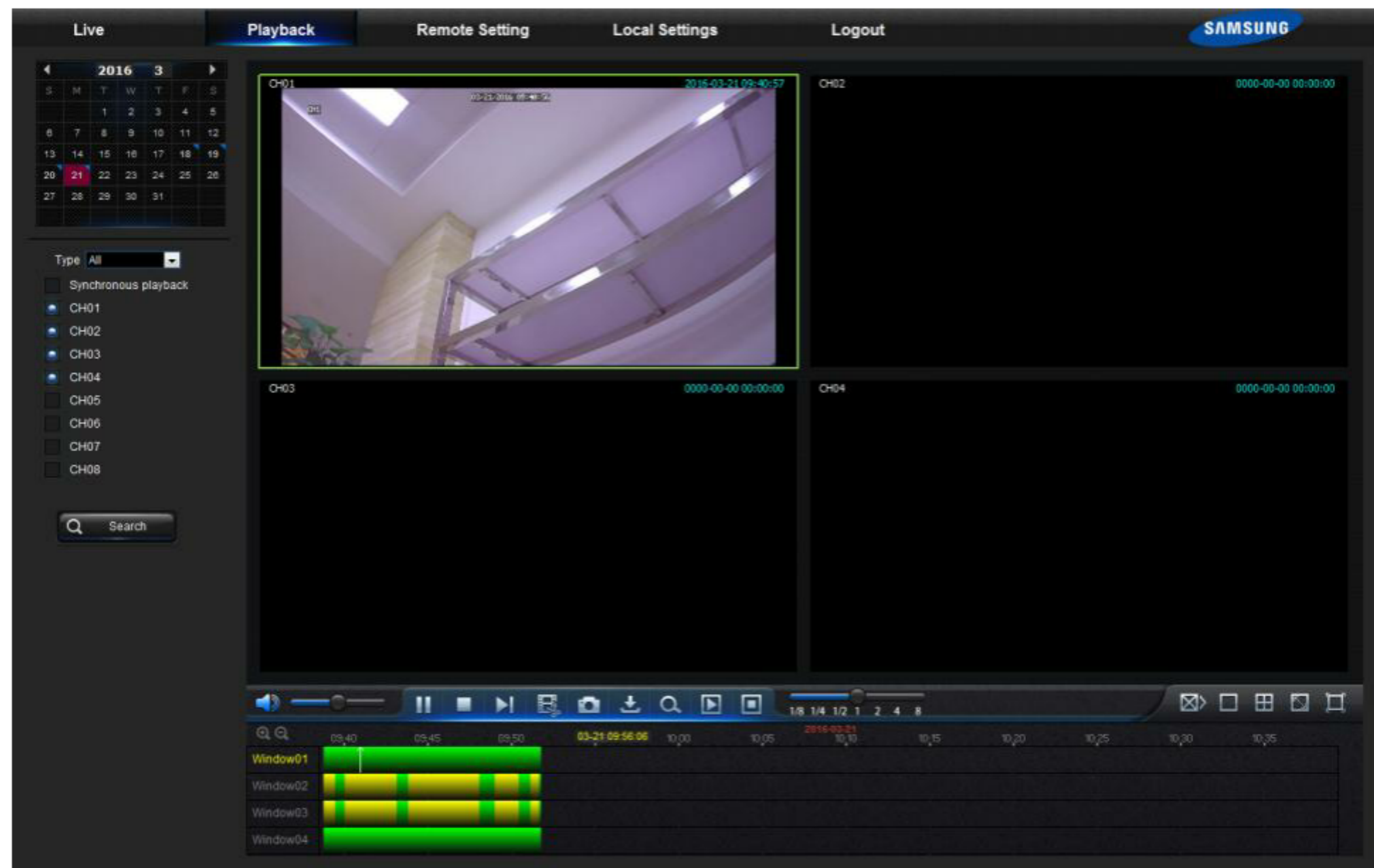
Secondly, select record type (Normal record, Motion and All) and channels, and then click , and time axis panel will display specific time quantum. On the time axis, red part stands for Motion, yellow stands for normal record and original part stands for no record during this period.



Before playback, choose to enable playback 4 channels synchronously. If you tick-select  **Synchronous playback**, that means the selected channel will playback synchronously; otherwise, you could separately control the channels playback.

Thirdly, start playback

Click  to start record playback. When mouse cursor is moving on the time axis, the time point of current position will be displayed on the time axis screen. Click to locate the record.

Click the icon  or  to zoom in/out the time bar display ratio.

2. Playback Control

Playback control bar,

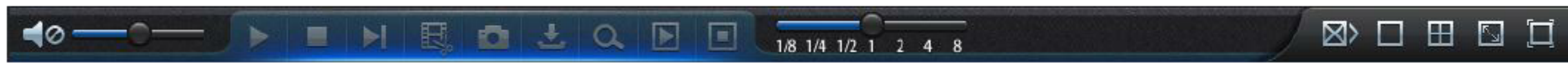

Detailed brief description is shown as below list

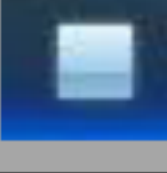
Key	Description	Key	Description
	Play		Enable the volume switch
	Pause		Volume adjustment bar
	Stop		Slow playing 1/2, 1/4, 1/8, Fast playing 1/2/4/8
	By frame		Stop playing all the files
	Record Clip		Single channel mode
	Snap		Quad mode
	Download		Full Screen
	Open all the playback channels		Stop playing all the playback

Record file clip

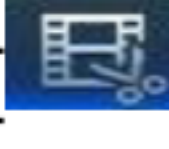
After opening playback, click [] icon to clip the selected file; and click again to stop the clip function. Then playback clip is successfully done. Record clip file will be saved as *.264 format.

Snapshot function

Move the mouse cursor to the channel you want to capture, and click [] icon to capture the live images remotely. After capturing the images successfully, a path prompt box will be popped up.

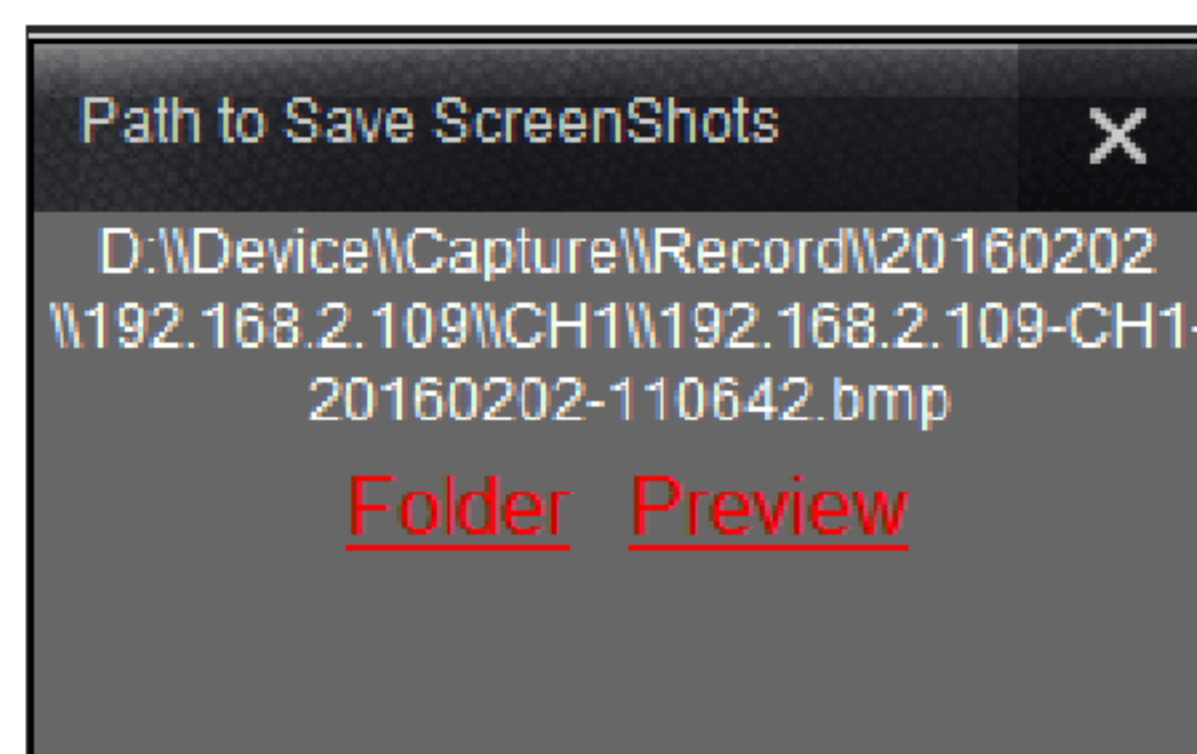

The captured file will be saved as .bmp format.

Record file download

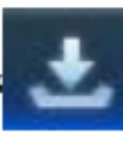
Click download icon “” on the control bar to display all the matched record file according to the search conditions of channels.

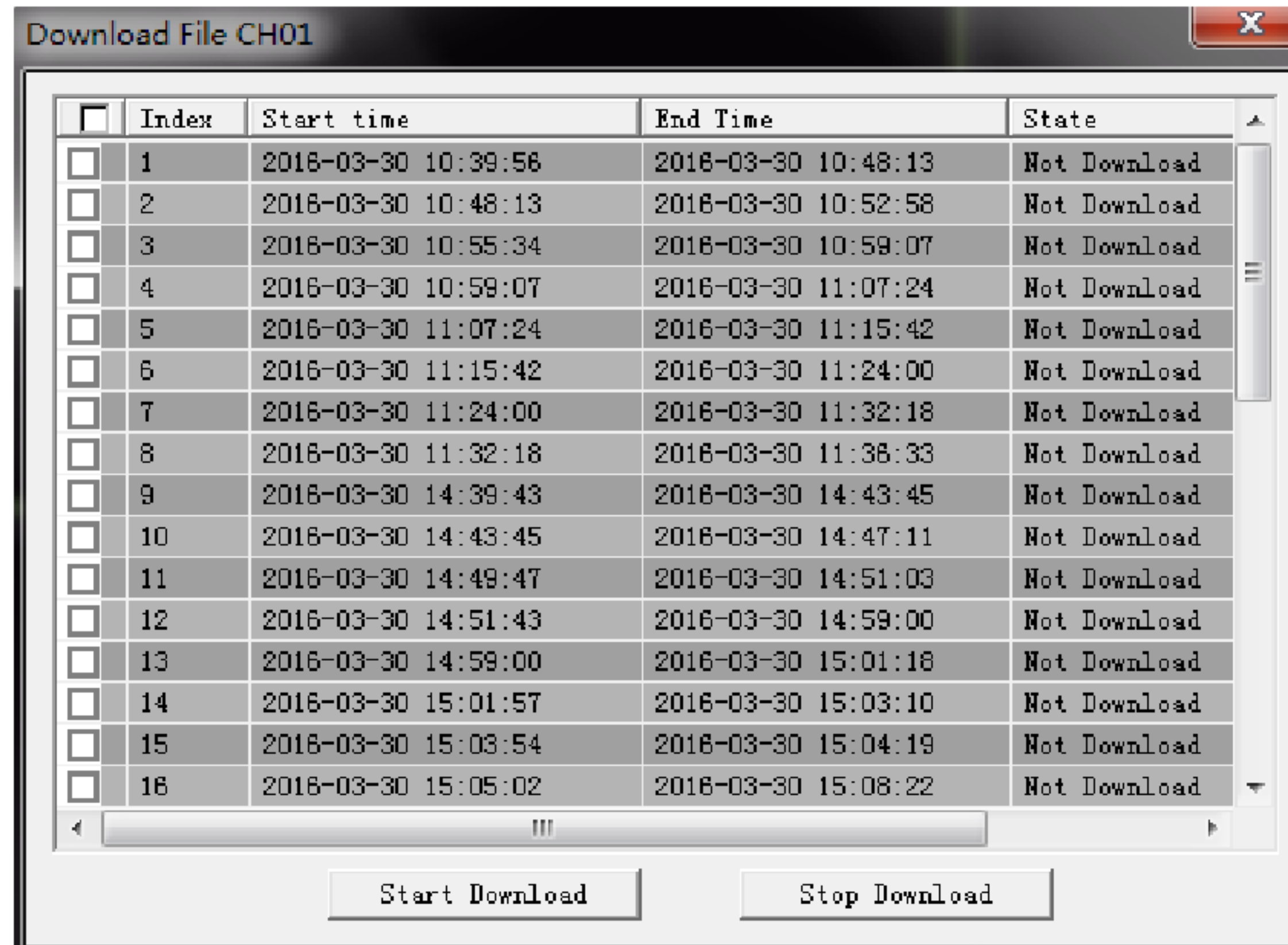

Tick-select the record file you want to download and click [Start download] .System will download the record file in sequence and save to local PC. The downloading file will be displayed in percentage form. After downloading finishes, “Complete” will be displayed on the status bar.

4.3.3 Remote Setting

Click Remote Setting to enter into the interface shown, including Display, Record, Network, Alarm, Device, System and Advance.

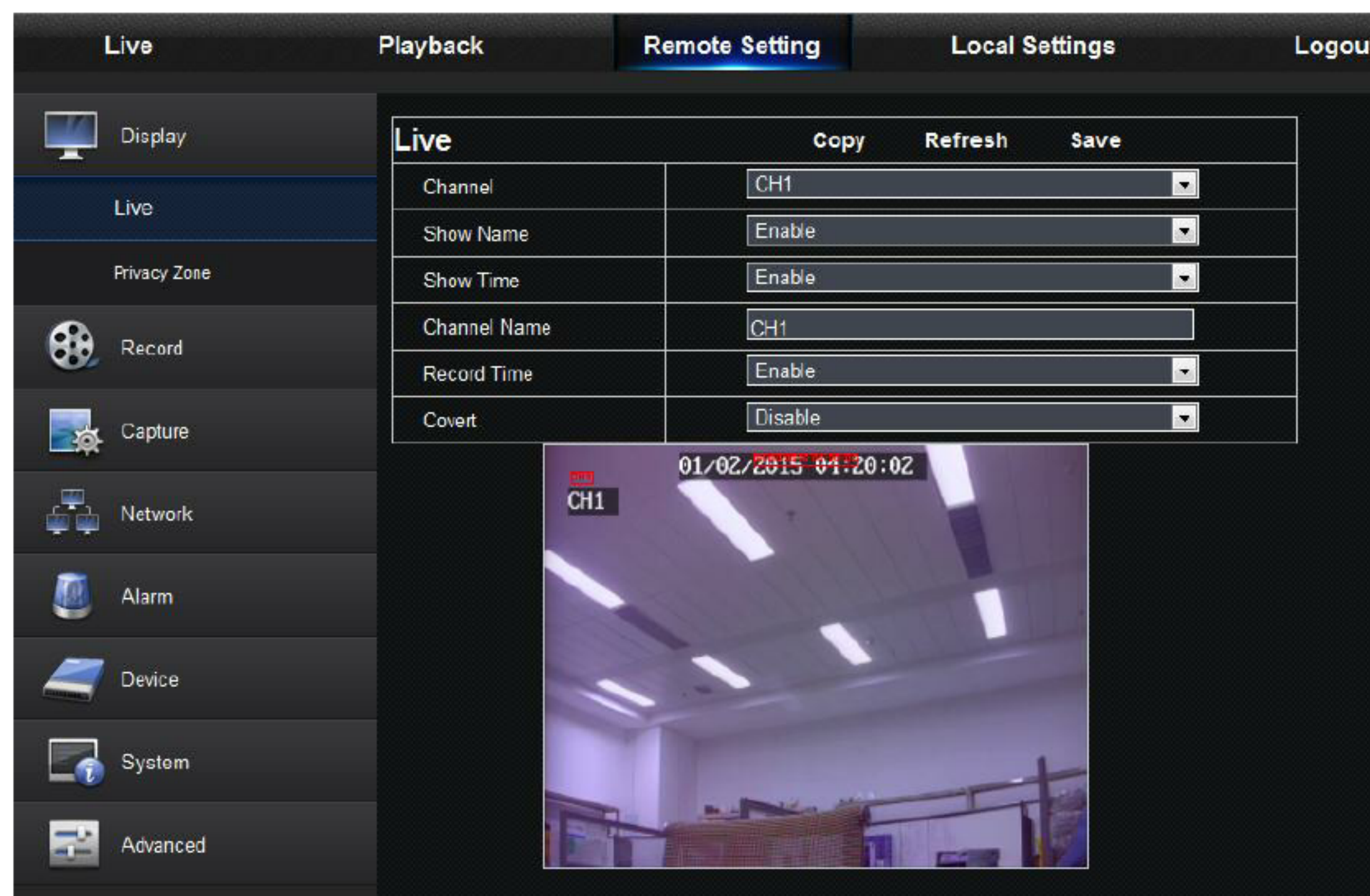

1. Display

1) Live

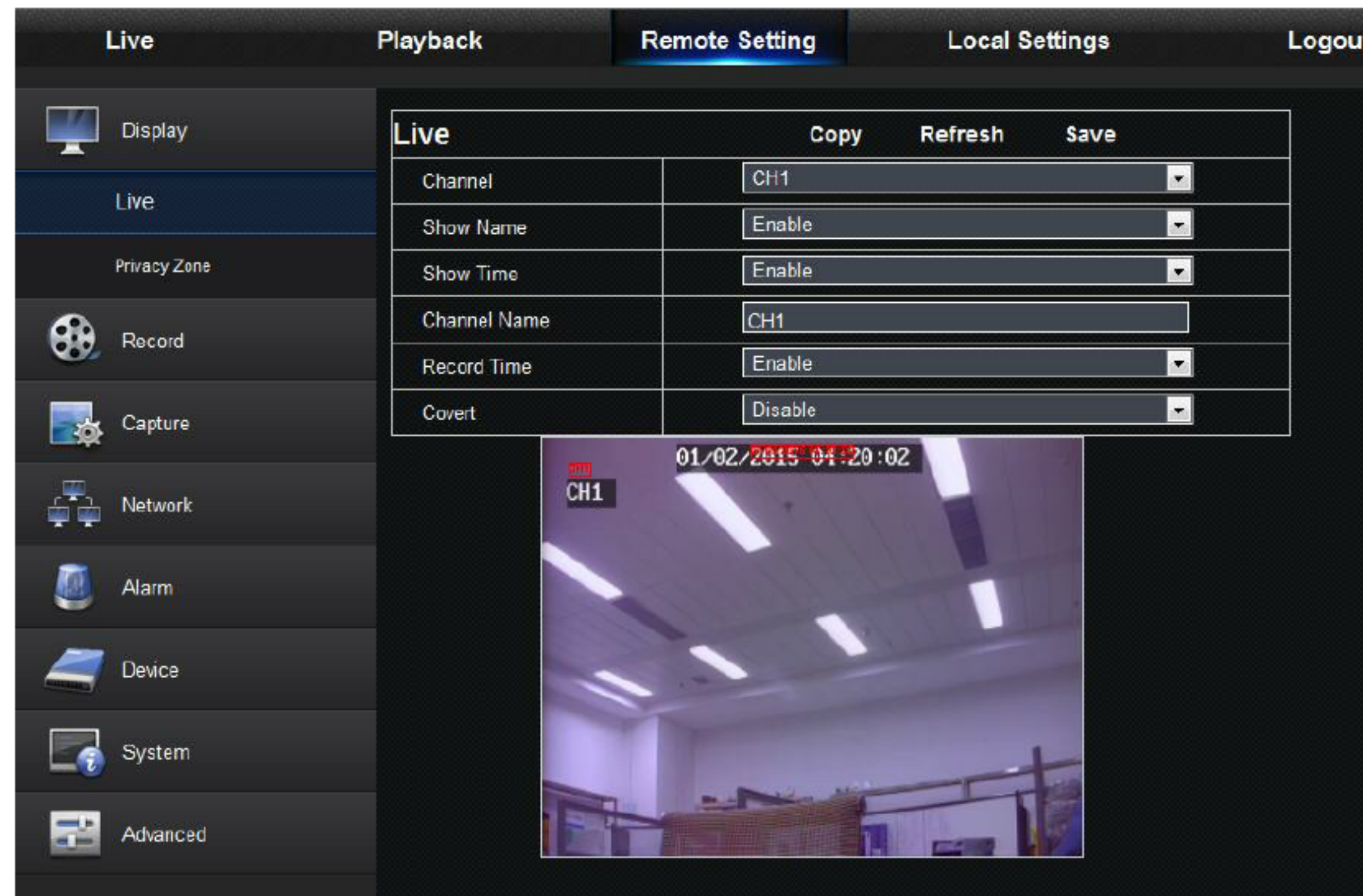

Channel: Select analog channel or digital channel.

Show Name: Enable or Disable display camera name.

Show Time: Enable or Disable time display.

Channel Name: Define a camera name for the camera.

Record Time: When enable, the time will be recorded on your video.

Covert: Enable or Disable video covert.

2) Privacy Zone

Each channel can set 4 privacy zones. The relevant parameters should be consistent with DVR local setting. Select zones to be deleted and click "Delete" and click "Save" at up-right corner.

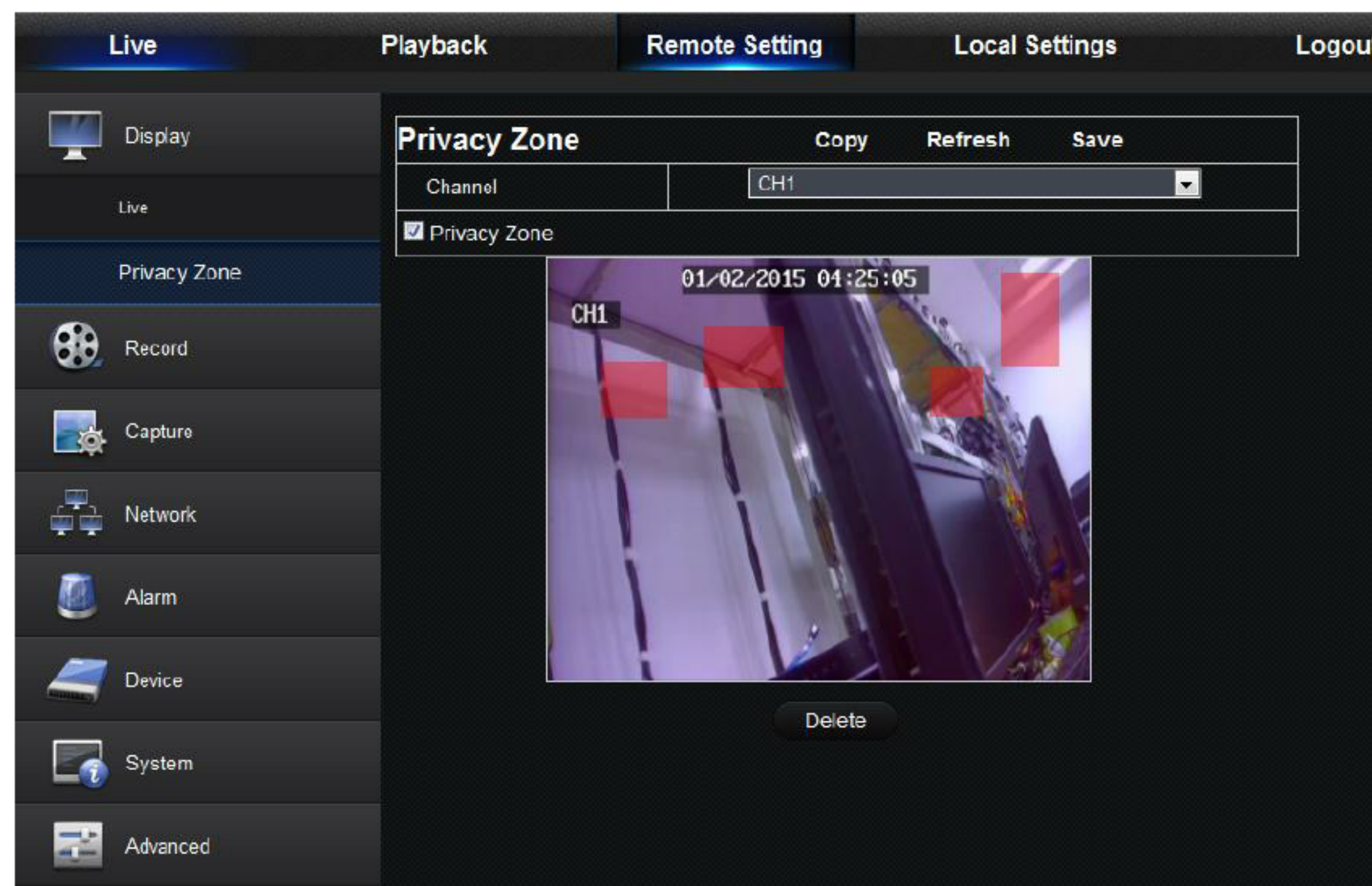

2. Record

Click <Record> option to unfold its sub-options: Record parameter and Schedule.

1) Record Parameters. The parameters should be consistent with DVR local setting.



2) Record Schedule. The parameters should be consistent with DVR local setting.

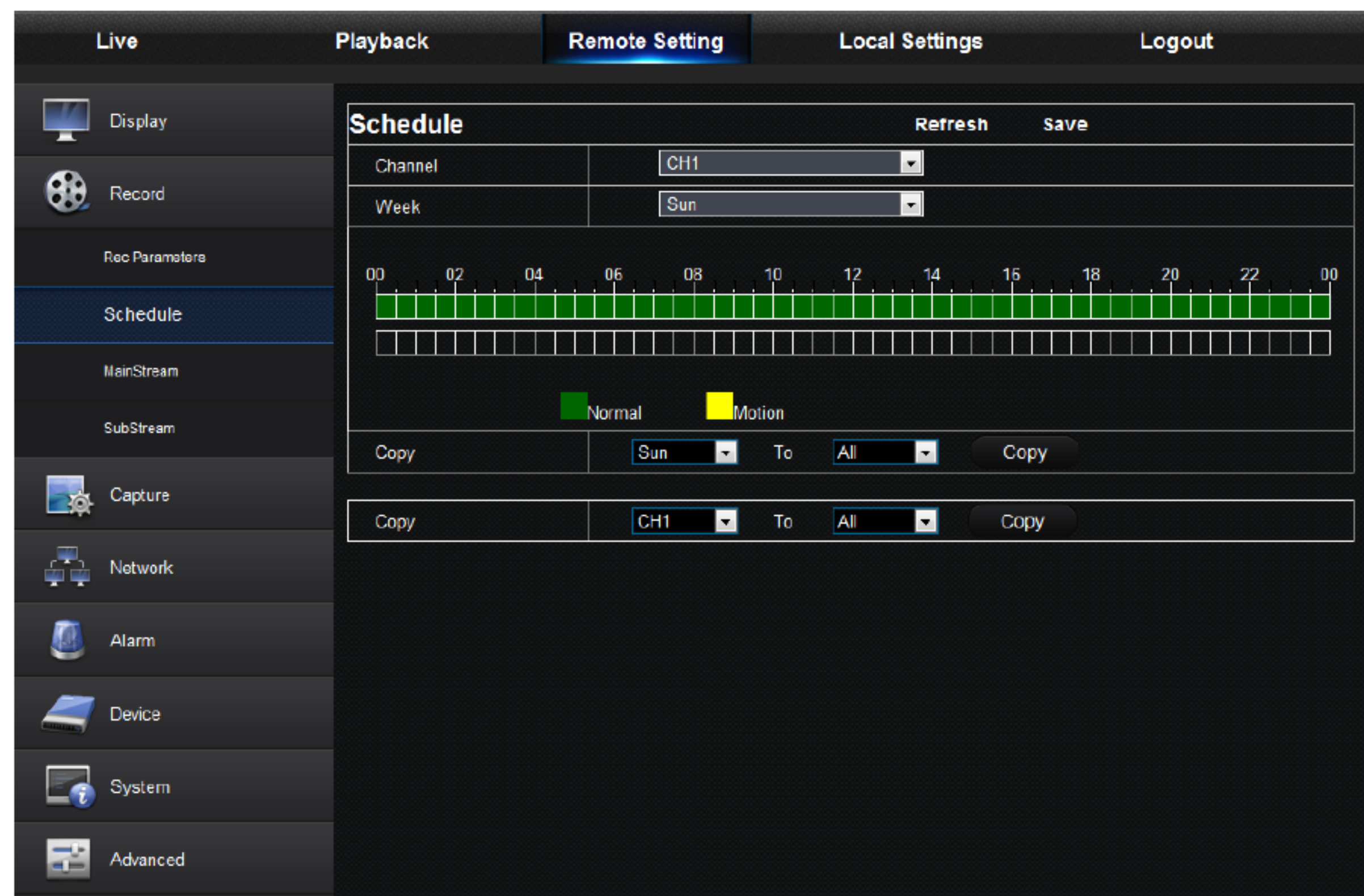

Green stands for Normal record; Yellow stands for Motion detection.

3) Mainstream: User may set Mainstream. The relevant parameters should be consistent with DVR local setting.



4) Substream:



- **Channel:** Select analog channel or digital channel.
- **Resolution:** Select recording resolution.
- **FPS:** Select recording frame rate.
- **Bitrate Mode:** Select default or custom bit rate.
- **Bitrate:** Select recording bit rate.

1) Capture:

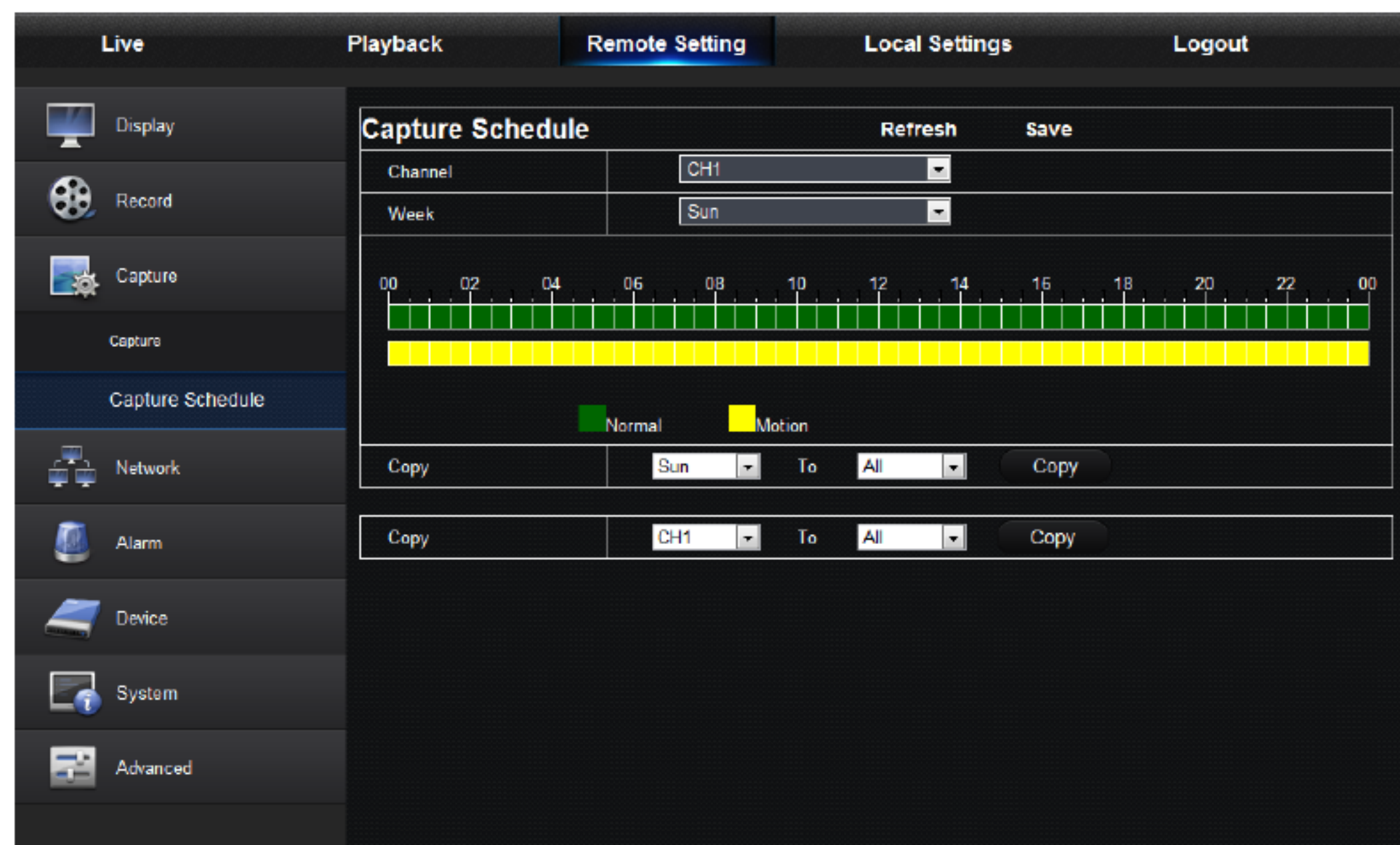

- **Channel:** Select analog channel or digital channel.
- **Auto Capture:** Enable/Disable auto capture
- **Stream Mode:** Select main stream or sub stream of capture.
- **Alarm Interval:** Select interval time of alarm capture
- **Manual Capture:** Enable/Disable manual capture

2) Capture Schedule:

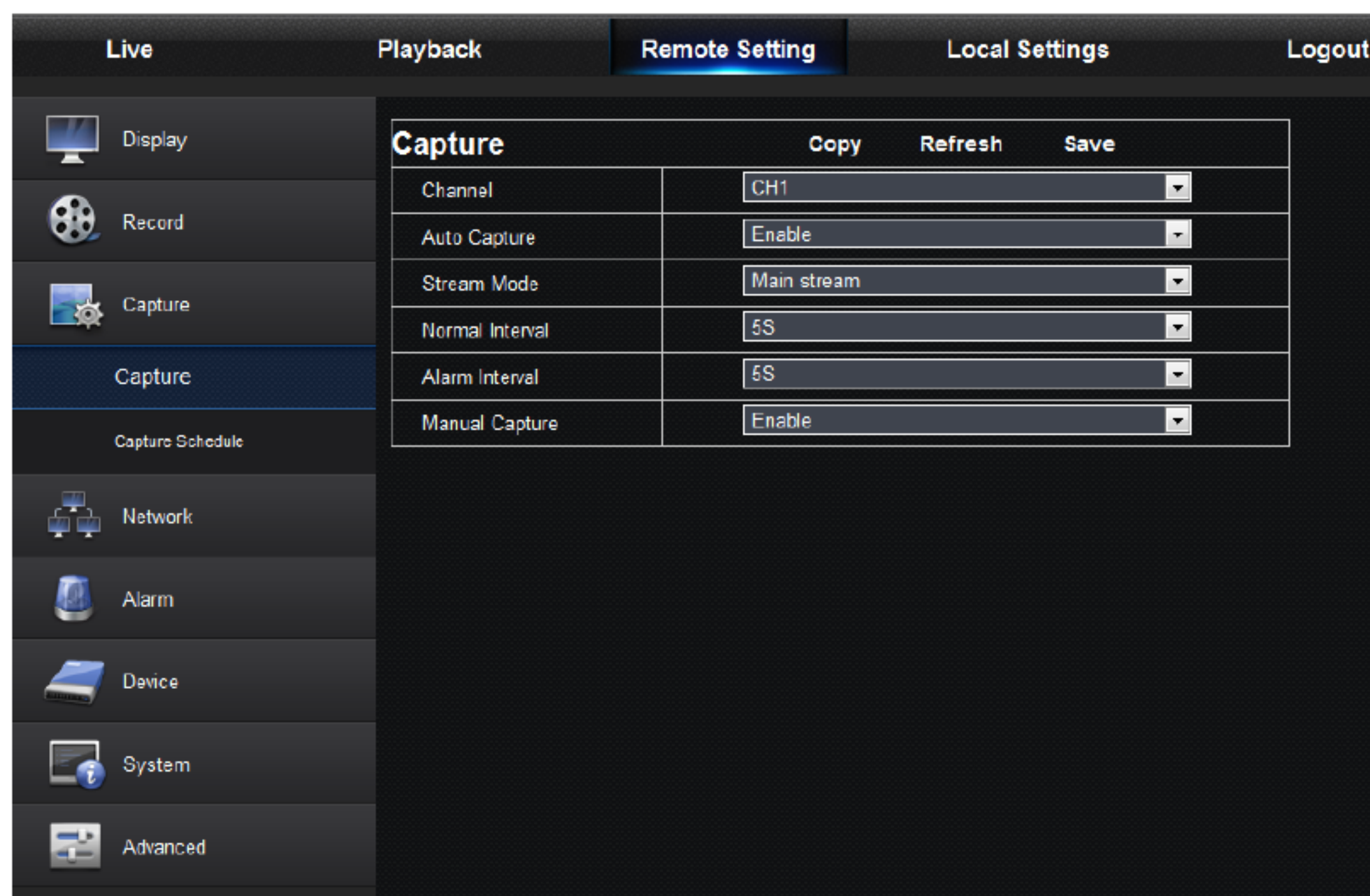

- **Channel:** Select analog channel or digital channel
- **Normal:** Conventional capture setting
- **Motion:** Motion detect capture setting

4.3.4 Network

Unfold <Network> to show its sub-options: Network, Email, and DDNS configuration.

1. LAN setting

DVR supports Static/DHCP/PPPOE modes. System default network type is <DHCP>. User can set parameters as required. After the network parameters are modified successfully, DVR will automatically restart to make the setting effective.

The screenshot shows the 'Remote Setting' tab in the DVR interface. The 'Network' menu item is selected in the left sidebar. The main content area displays the 'Network' configuration table with the following parameters:

Network		Refresh	Save
Type	DHCP		
Client Port	9000		
HTTP Port	80		
IP Address	192.168.2.109		
Subnet Mask	255.255.255.0		
Gateway	192.168.2.1		
DNS 1	221.5.88.88		
DNS 2	8.8.8.8		
UPNP	Disable		

2. Email

Email: Set DVR alarm Email configuration parameters, including Email address, SSL, Email Enable, and Interval etc. Detailed parameters should be consistent with DVR local setting.

The screenshot shows the 'Remote Setting' tab in the DVR interface. The 'Email' menu item is selected in the left sidebar. The main content area displays the 'Email' configuration table with the following parameters:

Email		Refresh	Save
Email	Enable	Schedule	
SSL	Disable		
SMTP Port	25		
SMTP Server			
Sender			
Sender Password			
Receiver			
Interval	3Min		

Below the table, there is a 'Test Email' button.

3. DDNS

DDNS: After user applies for DDNS service, you could enable <DDNS> function under any one network type mode (Static, DHCP and PPPoE). And you may remotely visit the DVR through domain name (http://domain name: HTTP port No.). When visiting DVR by using DDNS, user should make sure port and current IP can be normally connected in public network. Details settings, including server address, host, user, and password, should be consistent with DVR local setting.

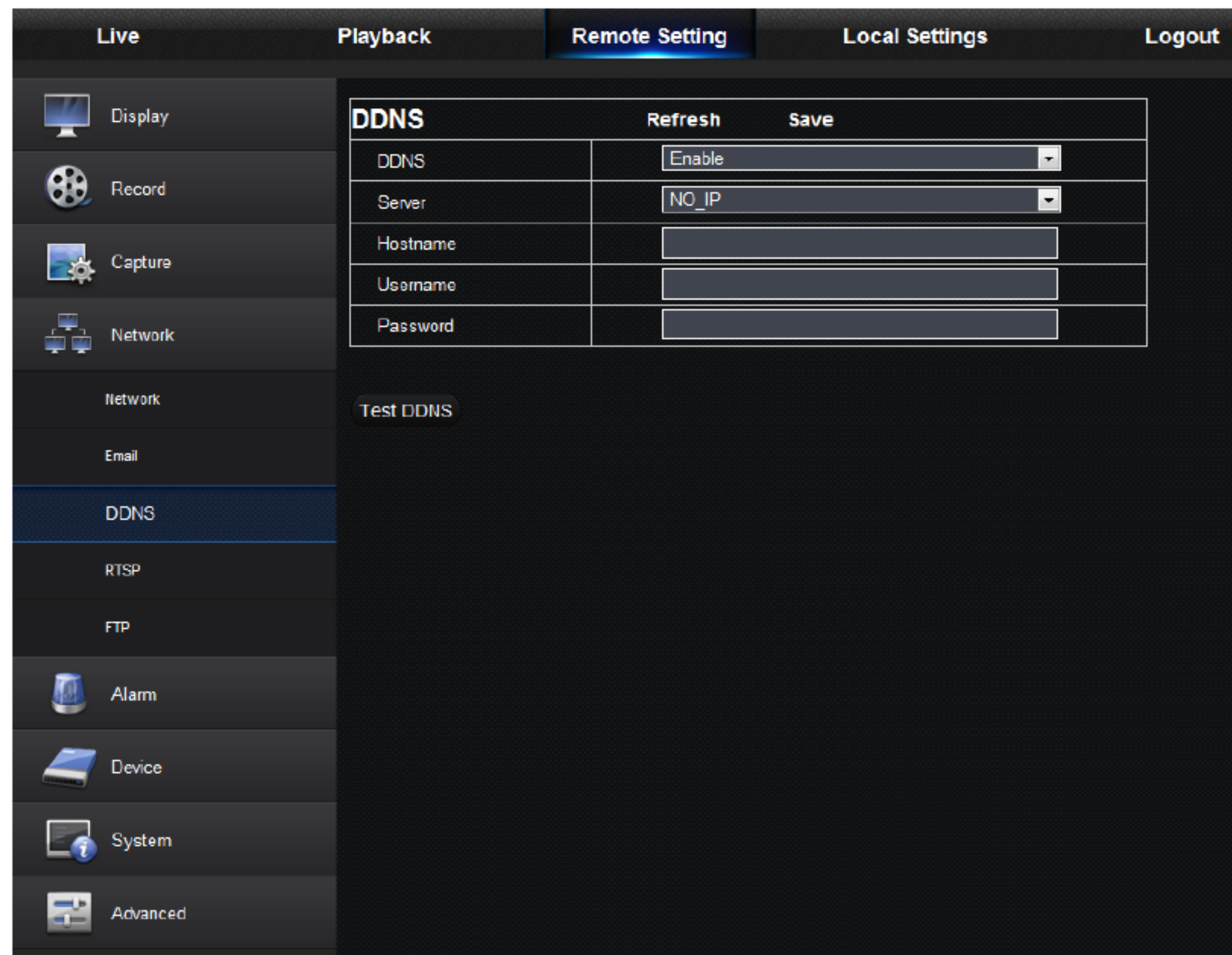

Click on "Test DDNS". If connection succeeds, it will be indicated that "DDNS Test is Successful!"

4. RTSP

The relevant parameters should be consistent with DVR local setting.

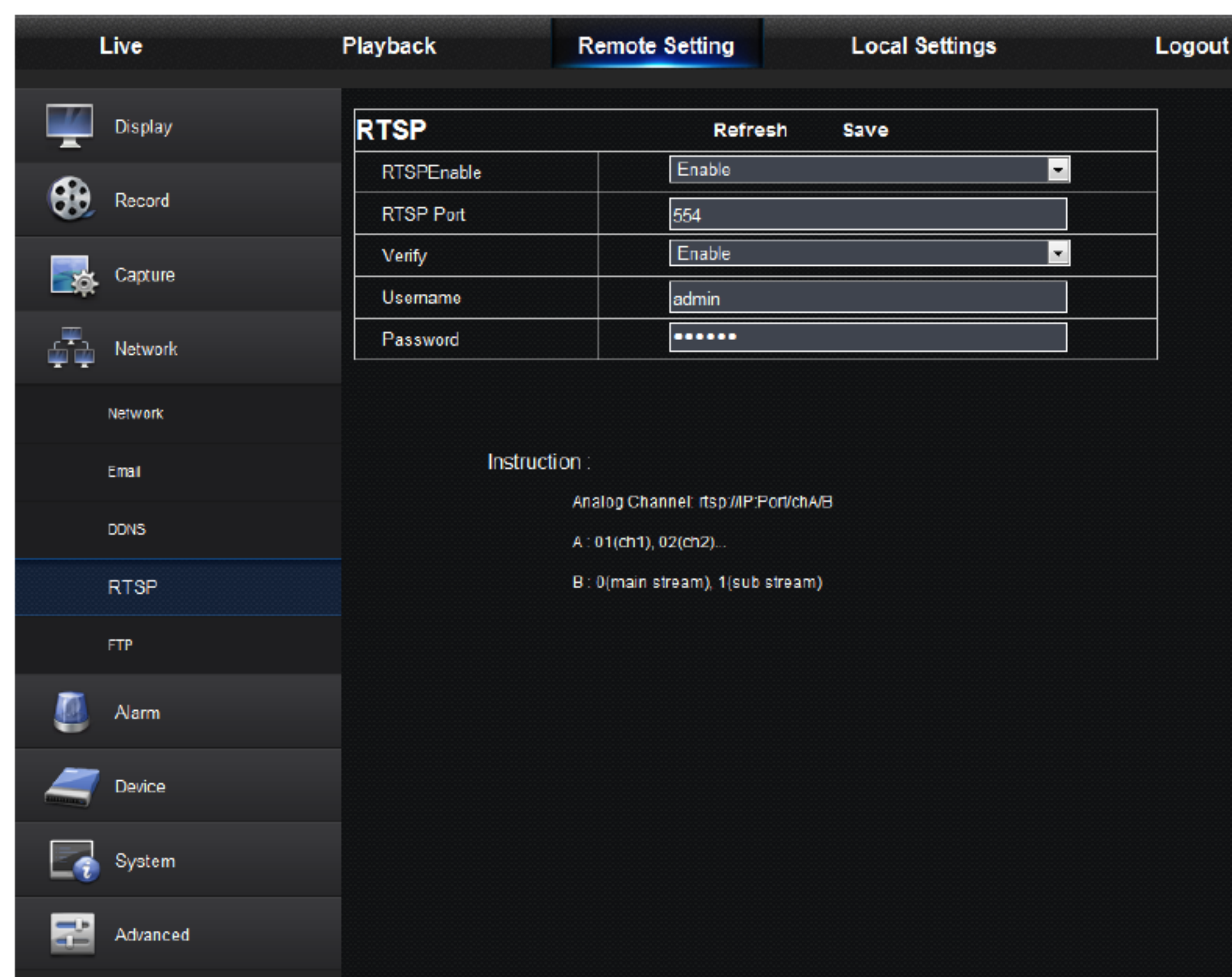

5. FTP

The relevant parameters should be consistent with DVR local setting.

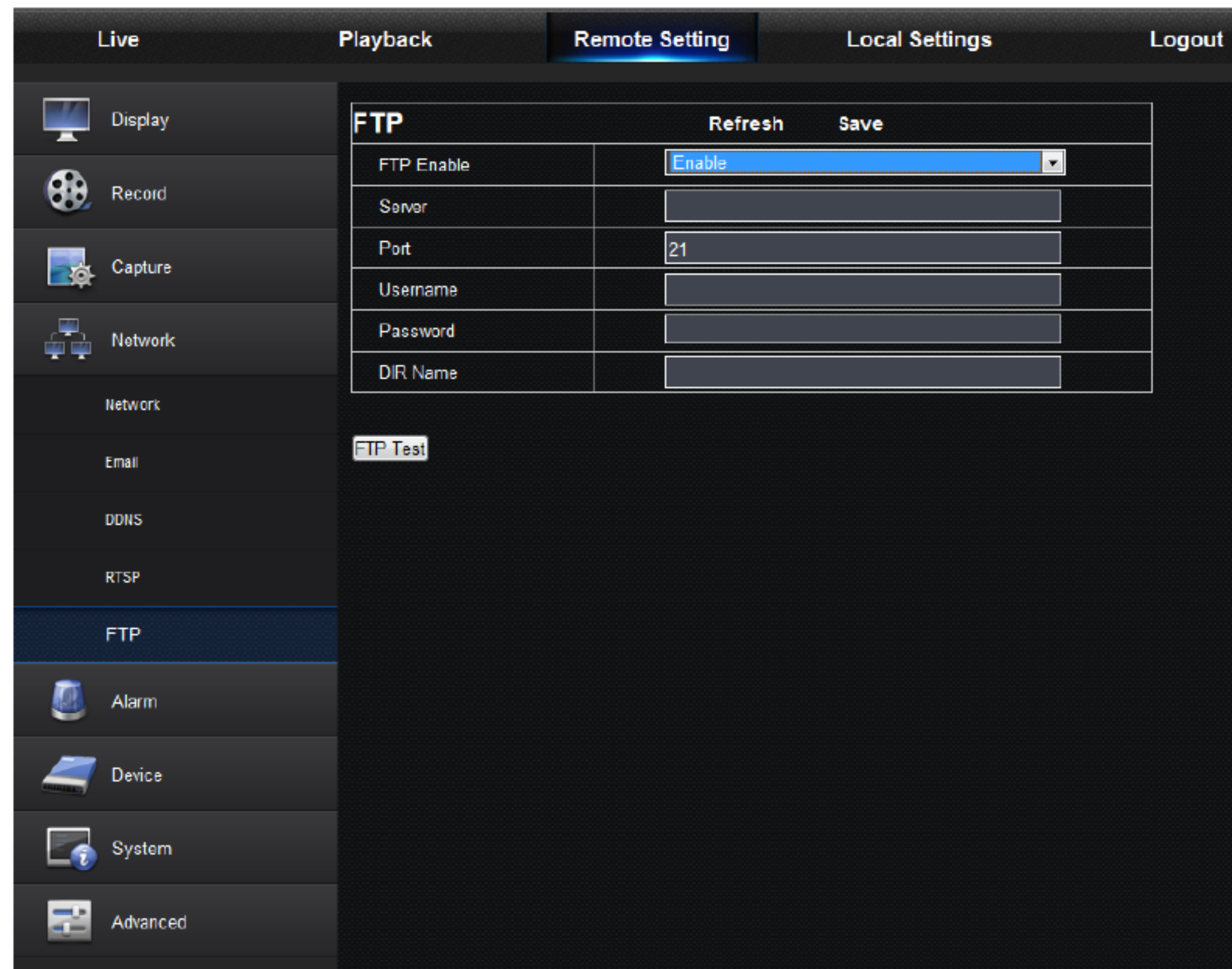

Note

It is recommended to use FTP software Filezilla with open source free of charge. Use of other FTP software may cause the image abnormal.

4.3.5 Alarm

Alarm setting includes Motion Detection Parameters.

1. Motion Detection

Configure Sensitivity, Alarm out, Alarm Record and Alarm Capture, etc. Detailed setting should be consistent with DVR local setting.

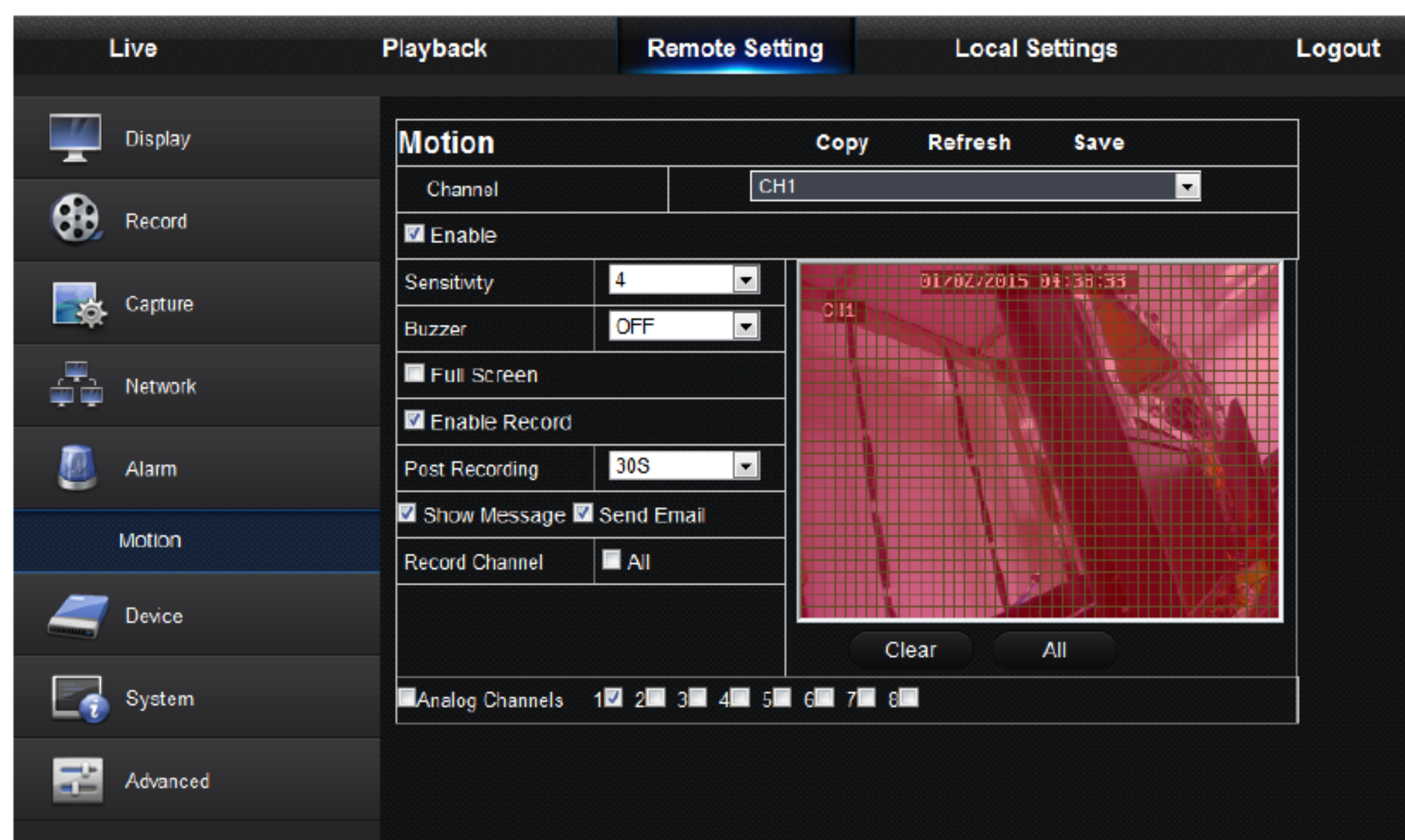

4.3.6 Device

Click <Device> to unfold its sub-options: HDD and Cloud Storage

1. HDD

User may check HDD status of DVR and overwritten time. Detail setting should be consistent with DVR local setting.

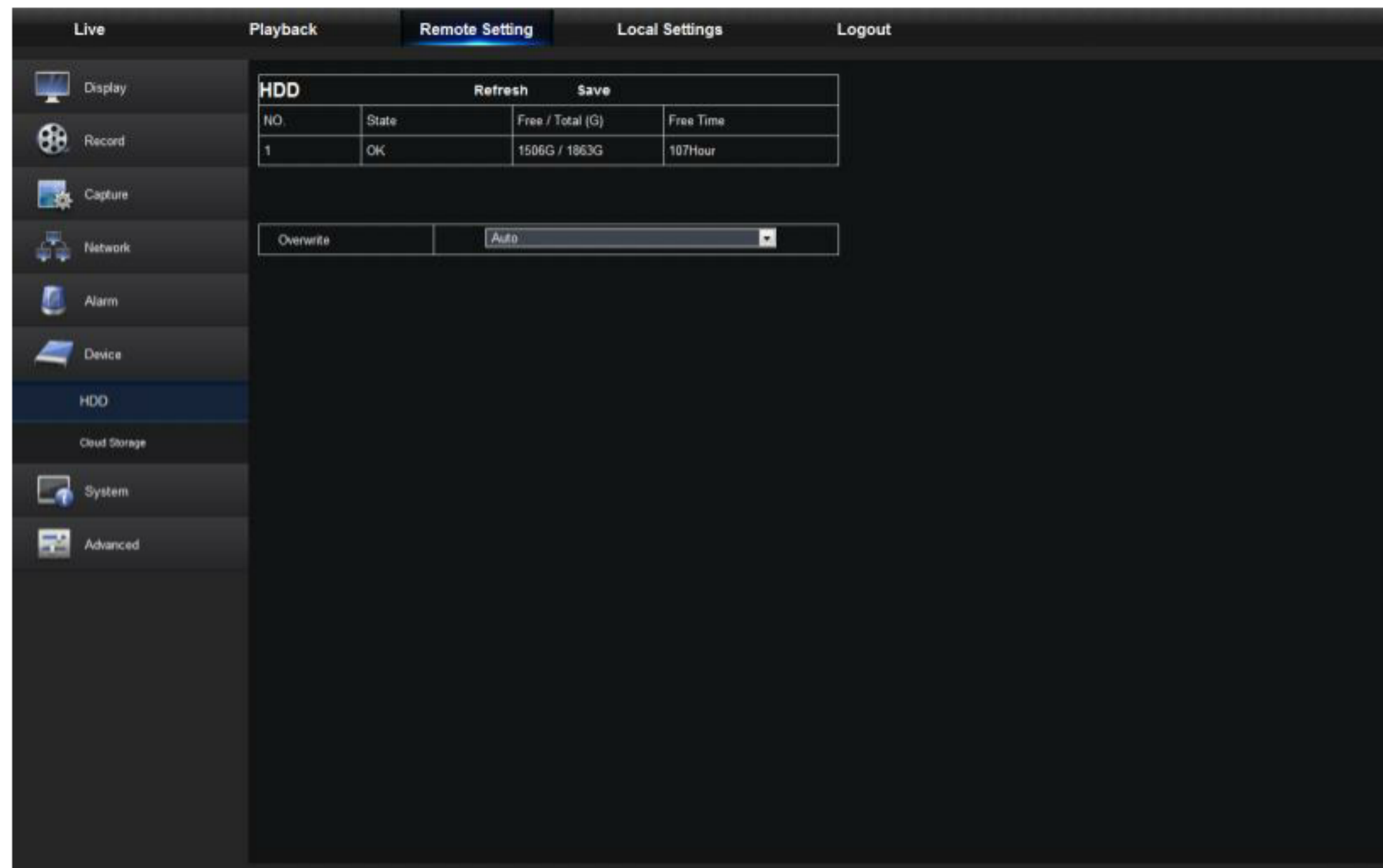

2. Cloud Storage

User may set the relevant parameters of Cloud Storage. Detail setting should be consistent with DVR local setting.

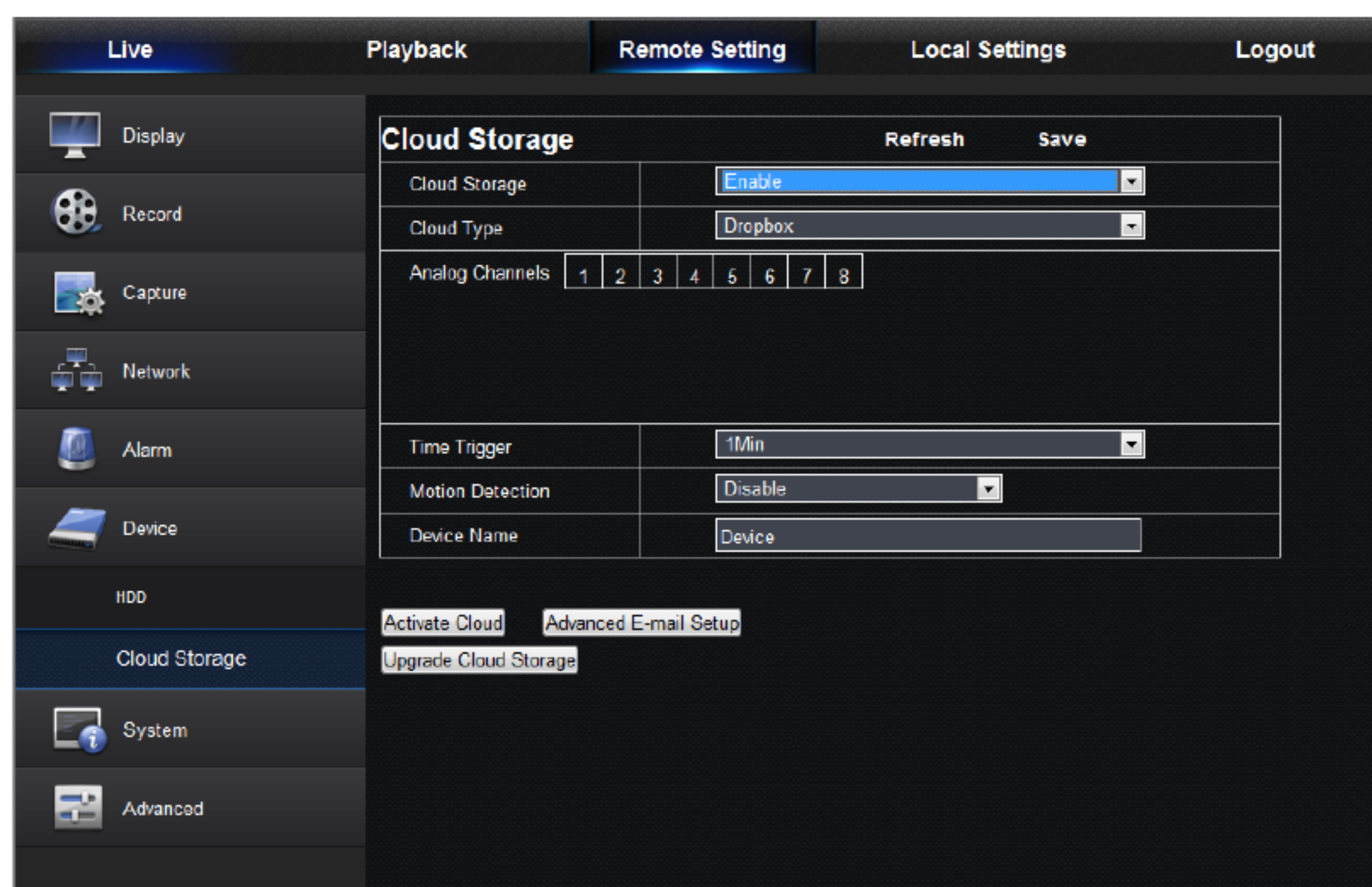

4.3.7 System

Click <System> option to unfold its sub-options: General, Users and Information.

1. General

User may check DVR language and video system and date format, menu display time, DST and NTP parameters. Detailed setting should be consistent with DVR local setting.



2. Users

User may configure user name and password and detailed setting should be consistent with DVR local setting.

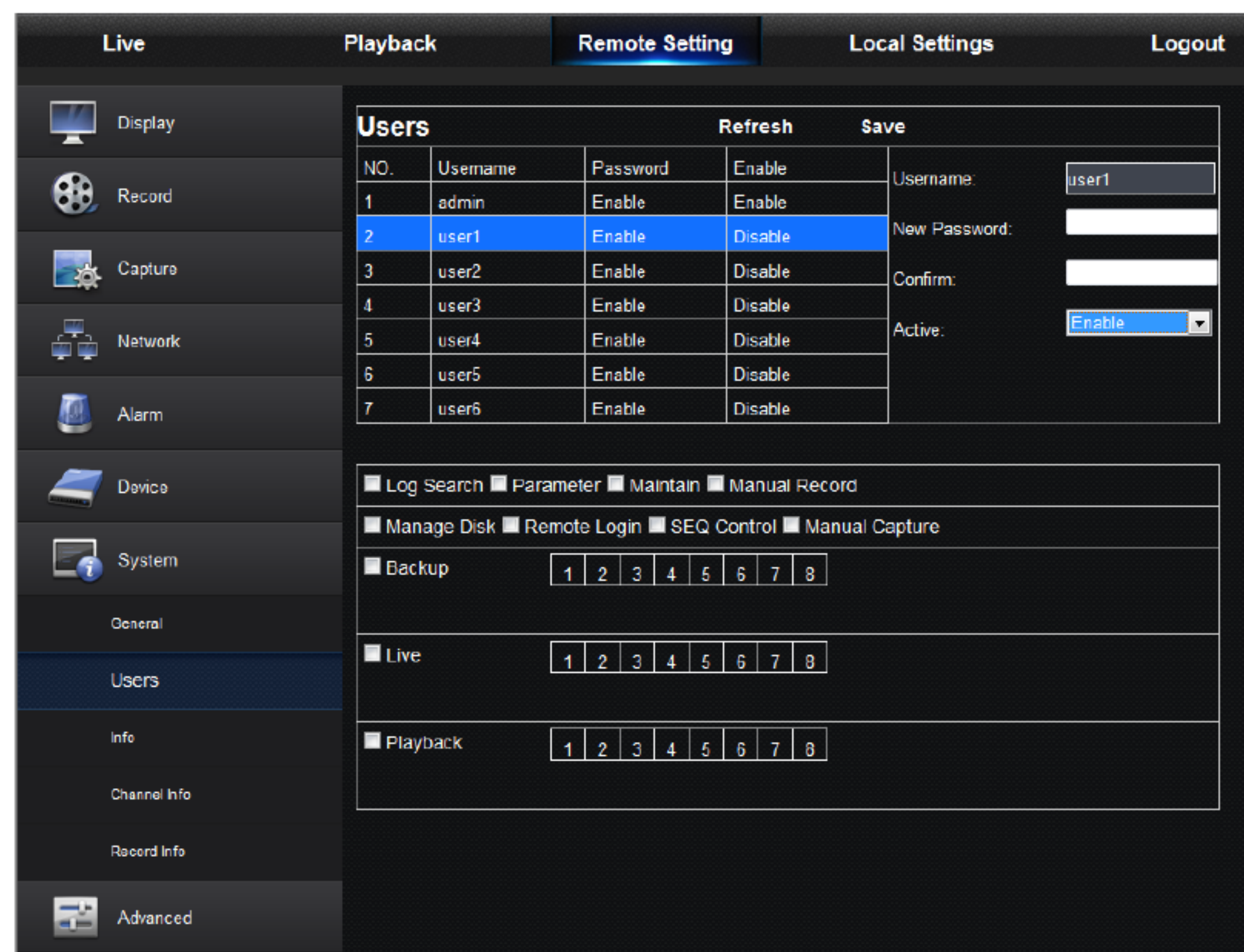

3. Information

User may search device name, device number, device type, MAC address, software version, IE version and hardware version of DVR.

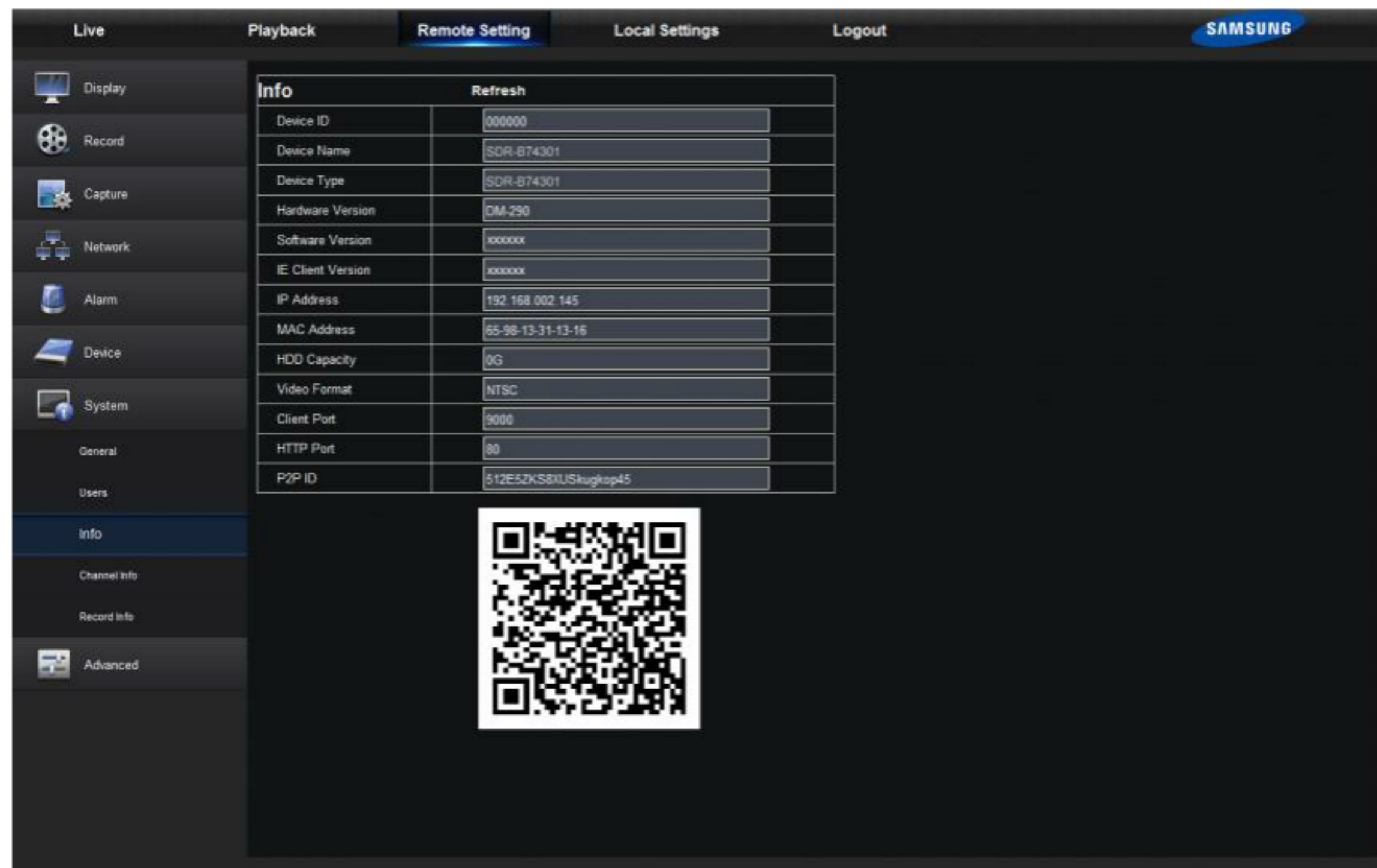

4. Channel Info

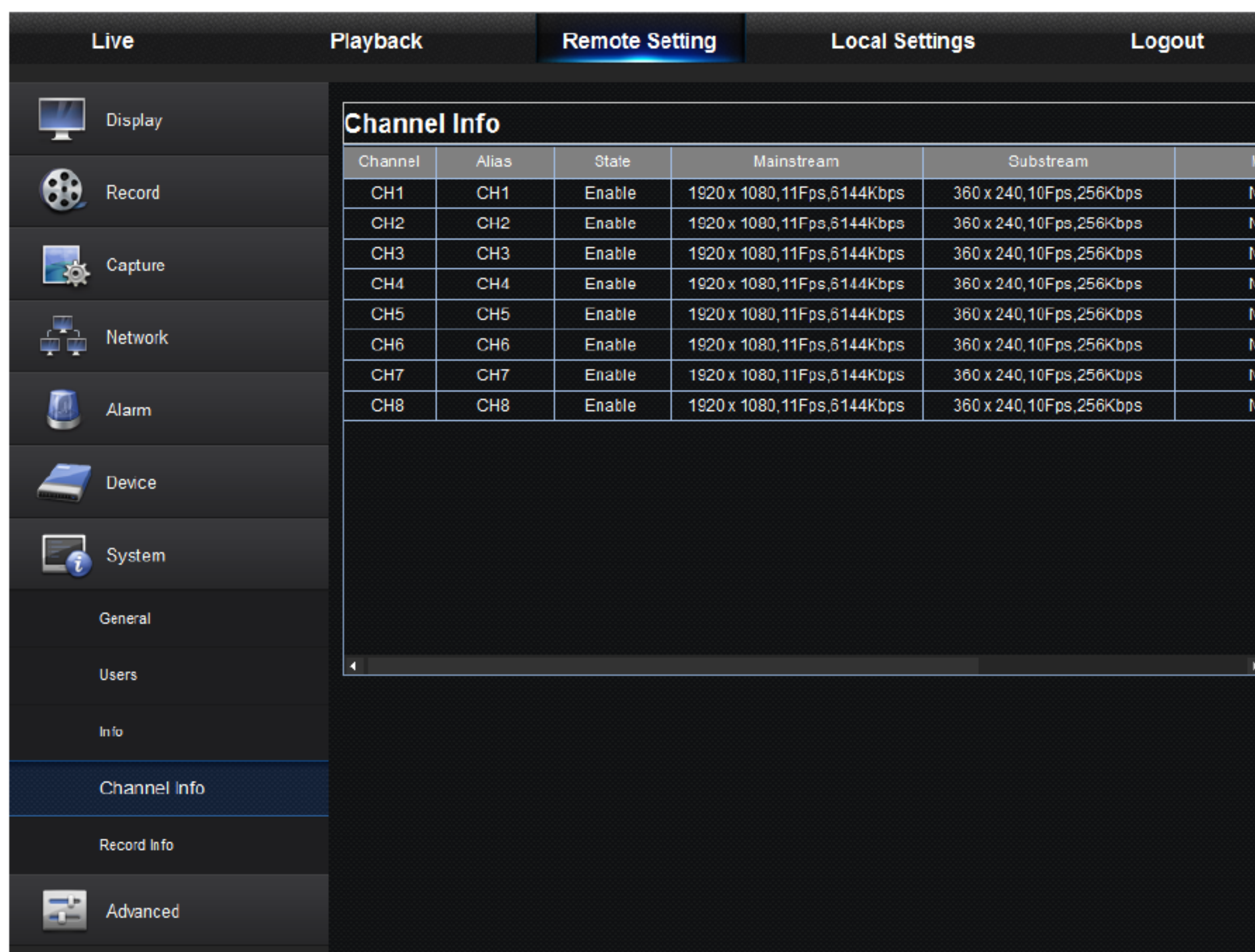

Displays all channels camera relevant information

5. Record Info

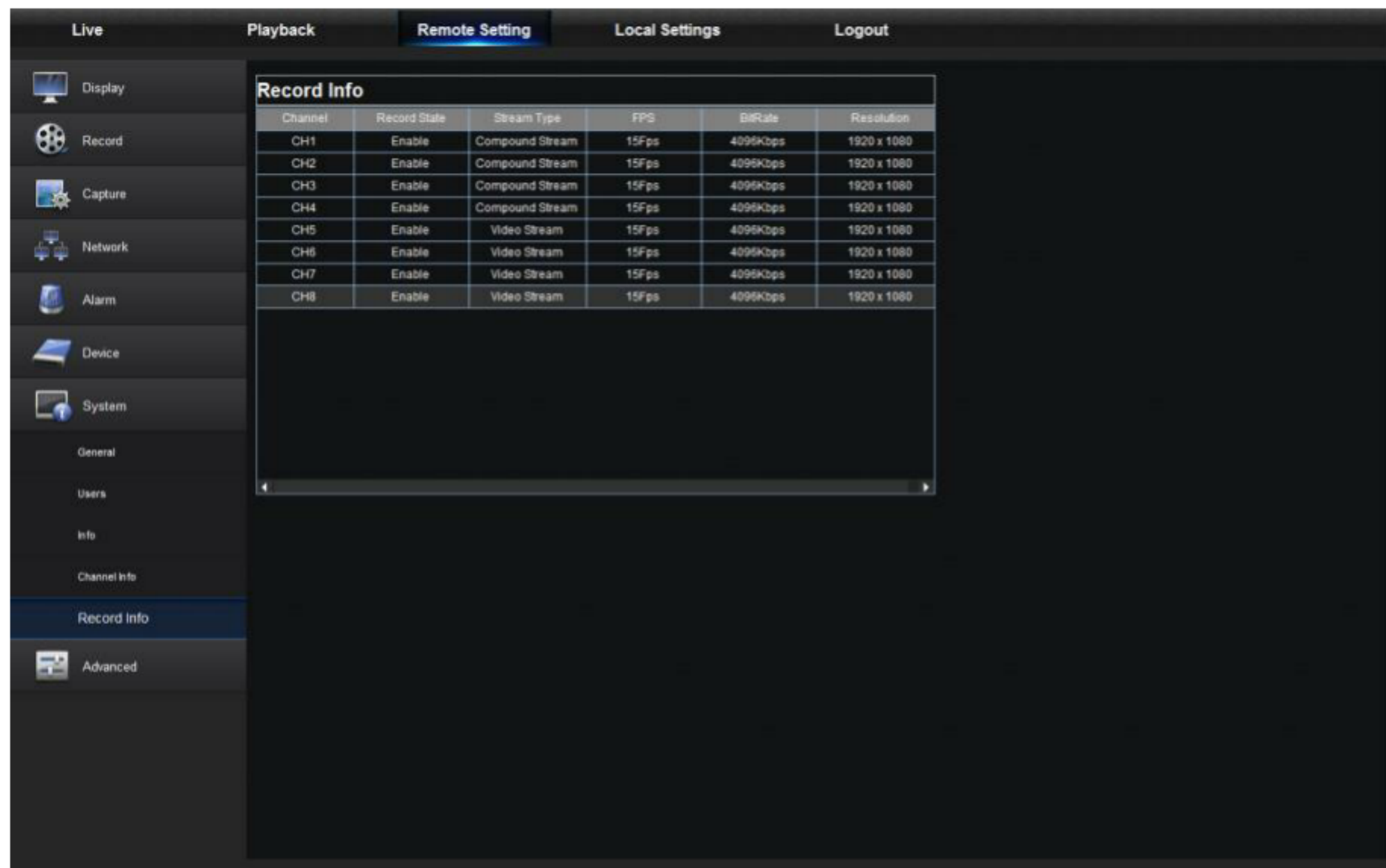

Display relevant information on video from all cameras.

4.3.8 Advanced

Click Advance to unfold its sub-options: Firmware Update, Load default, Events and Maintain.

1. Firmware Update

User may remotely update DVR system.

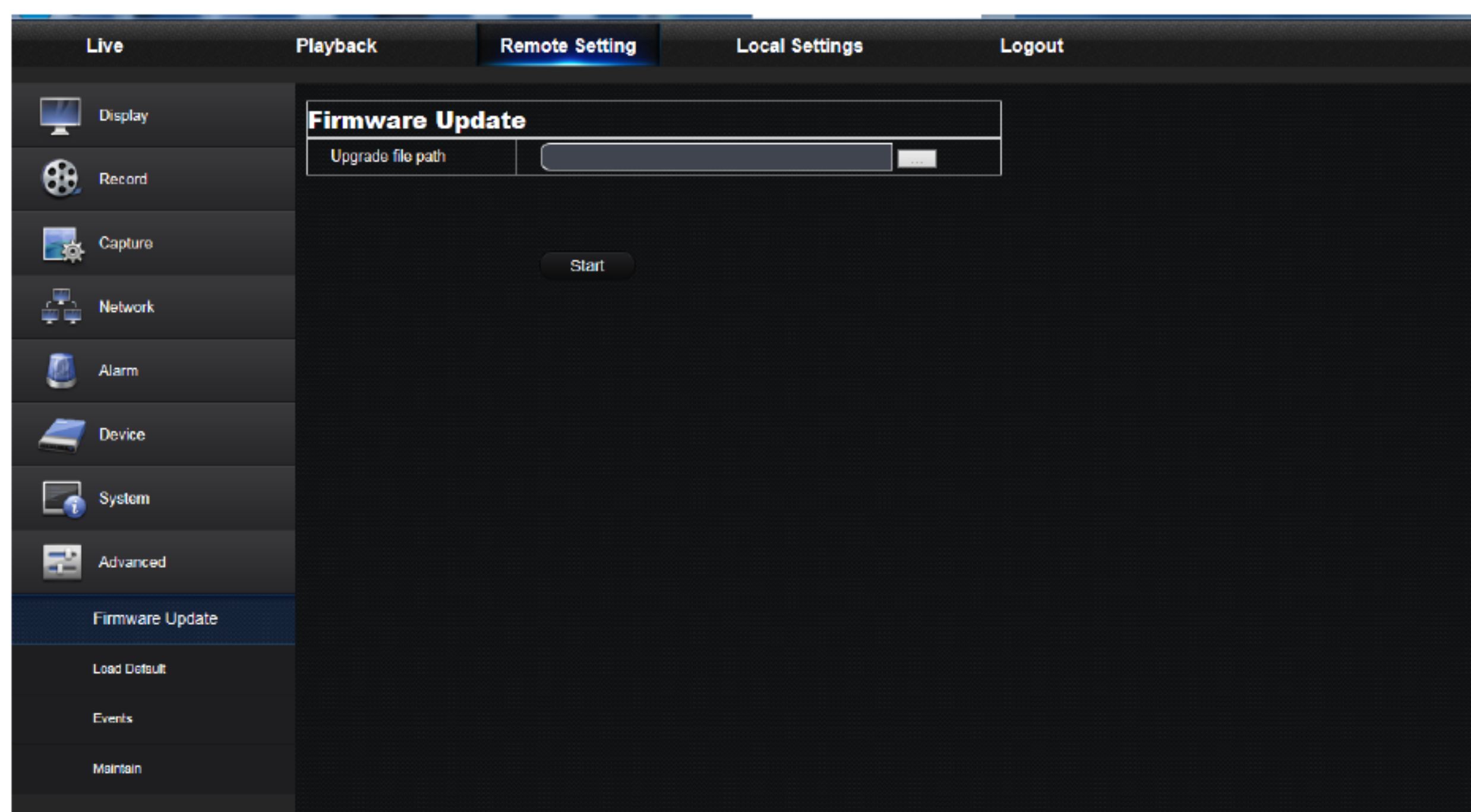

Updating procedure:

Firstly, select the update file path. The file format is .sw.

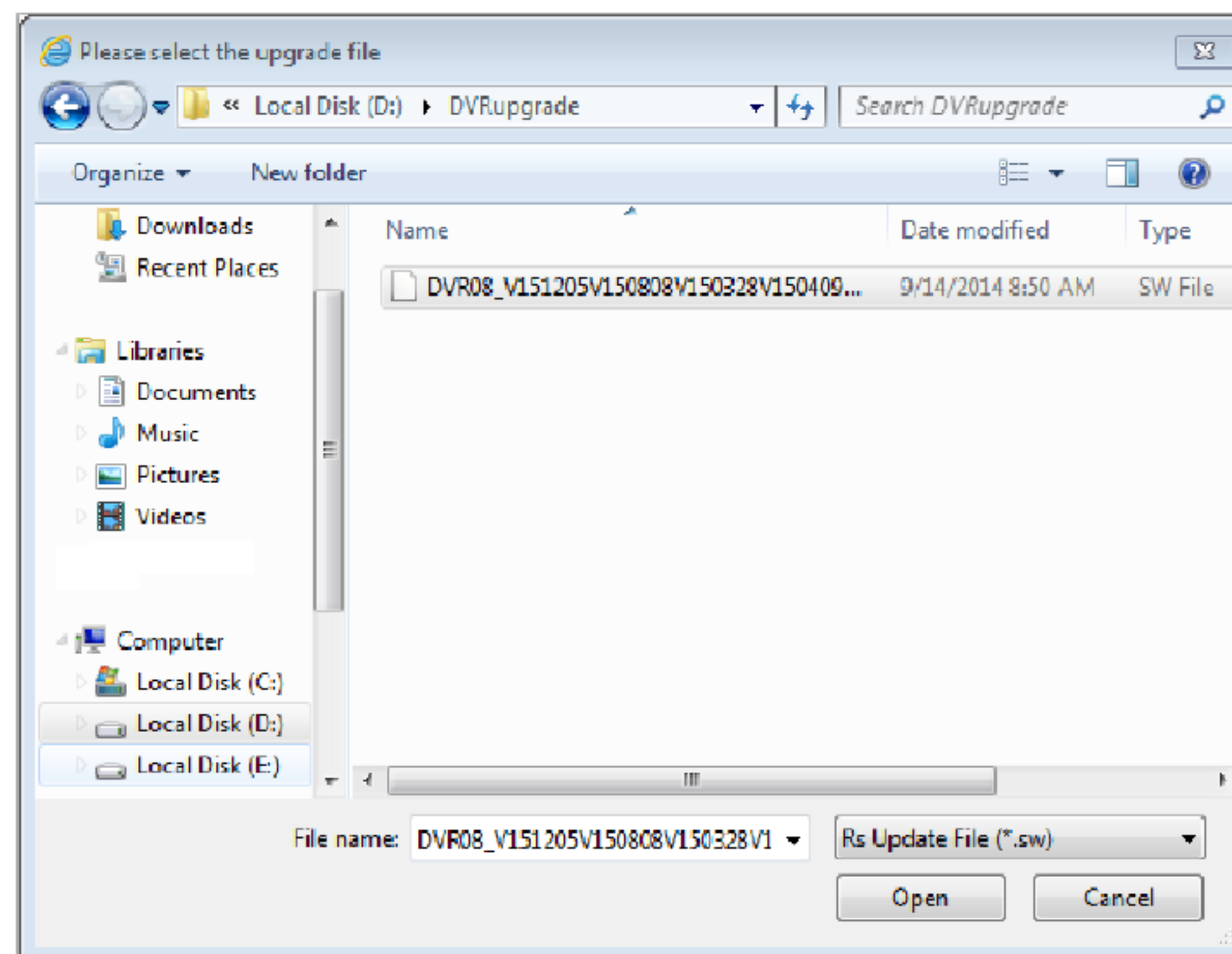

Secondly, click "Start" to start updating. The updating progress can be seen on the screen.

2. Load Default

User may remotely restore default parameters of DVR, with same setting method as that of DVR.

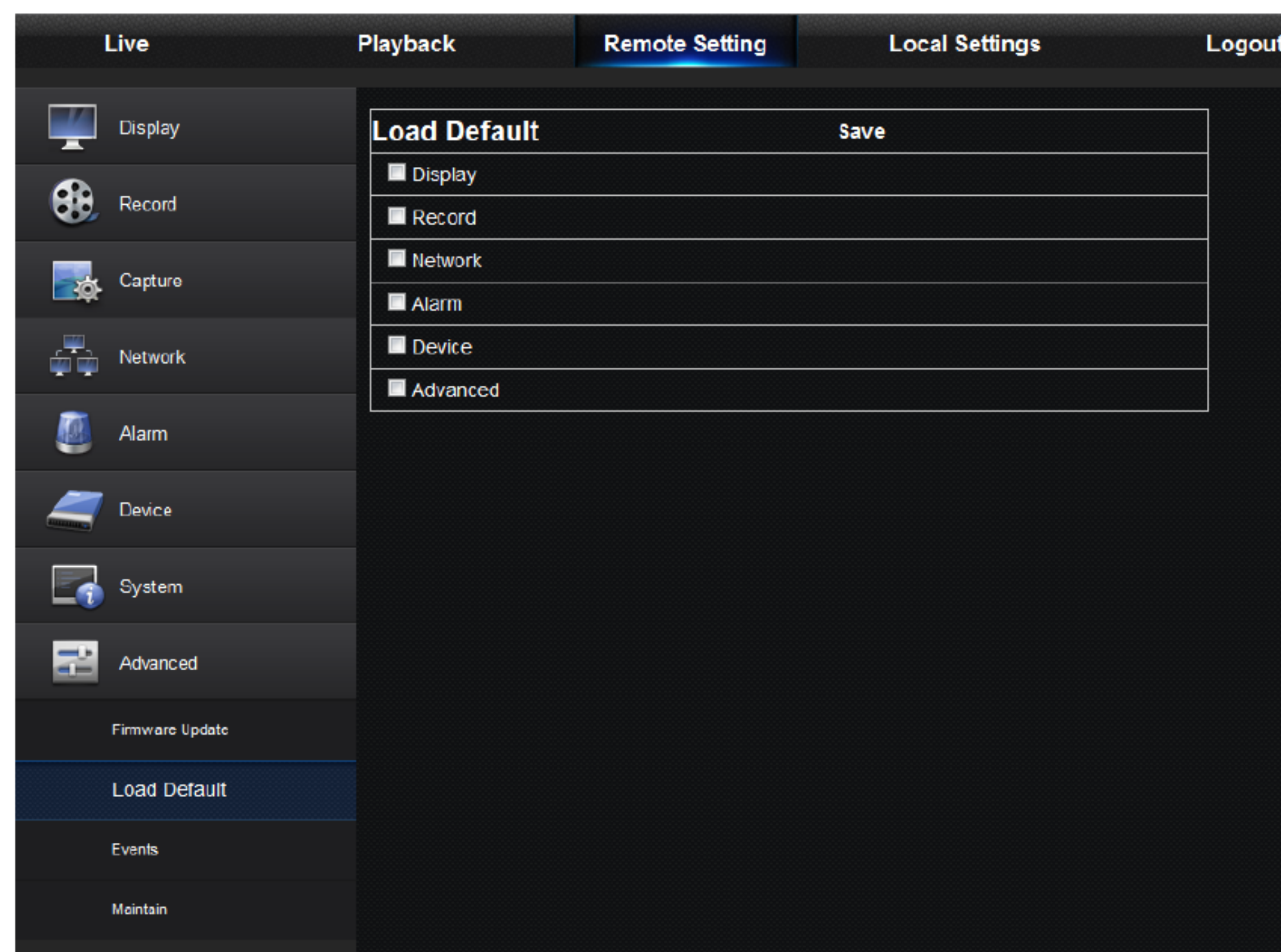

3. Events

User may configure Event Type, Buzzer, Send Email, Show Message and other parameters. Detailed setting should be consistent with DVR local setting.

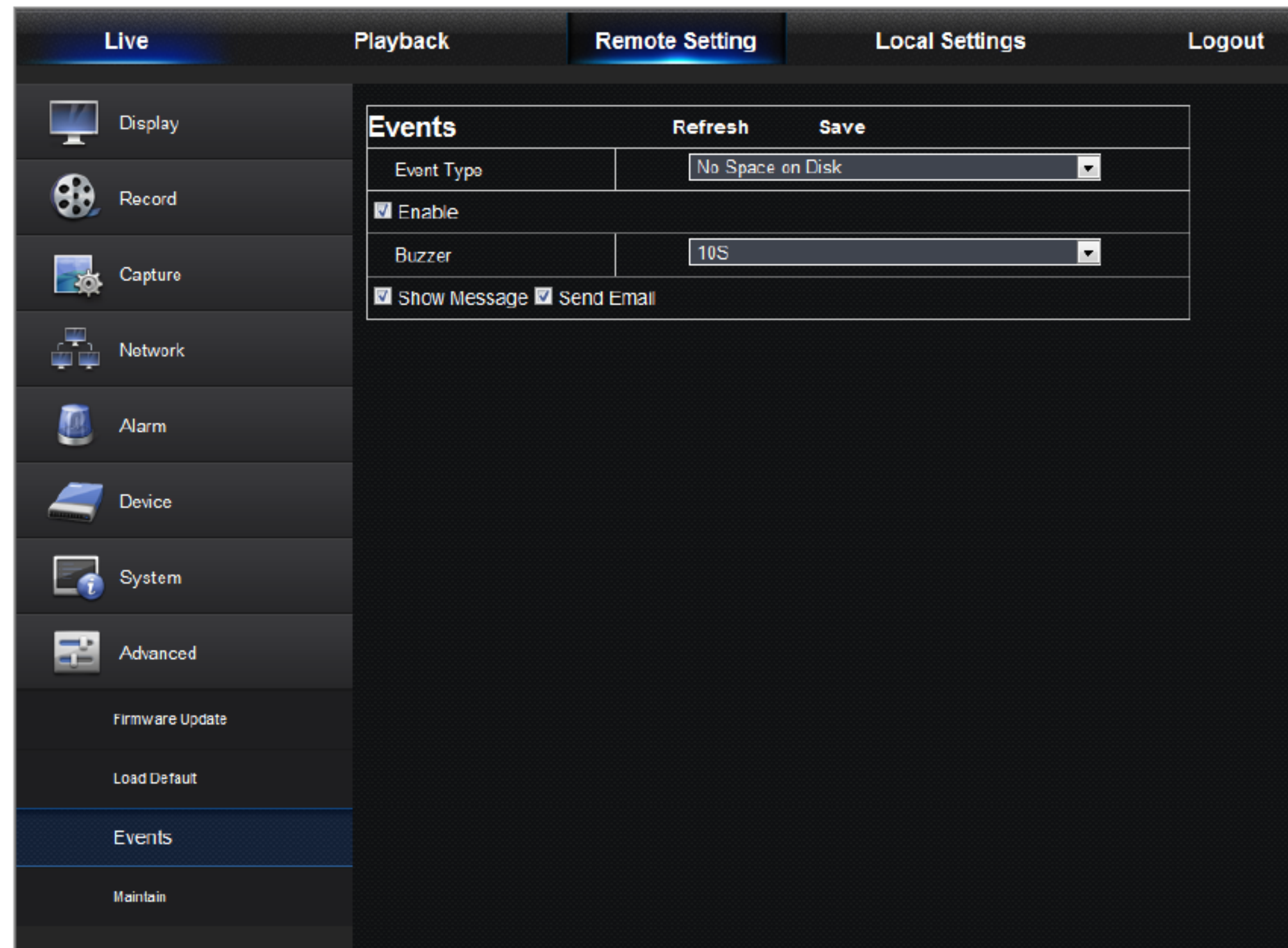

4. Maintain

Allow you remotely set auto maintain time for DVR. Detailed setting should be consistent with DVR local setting.

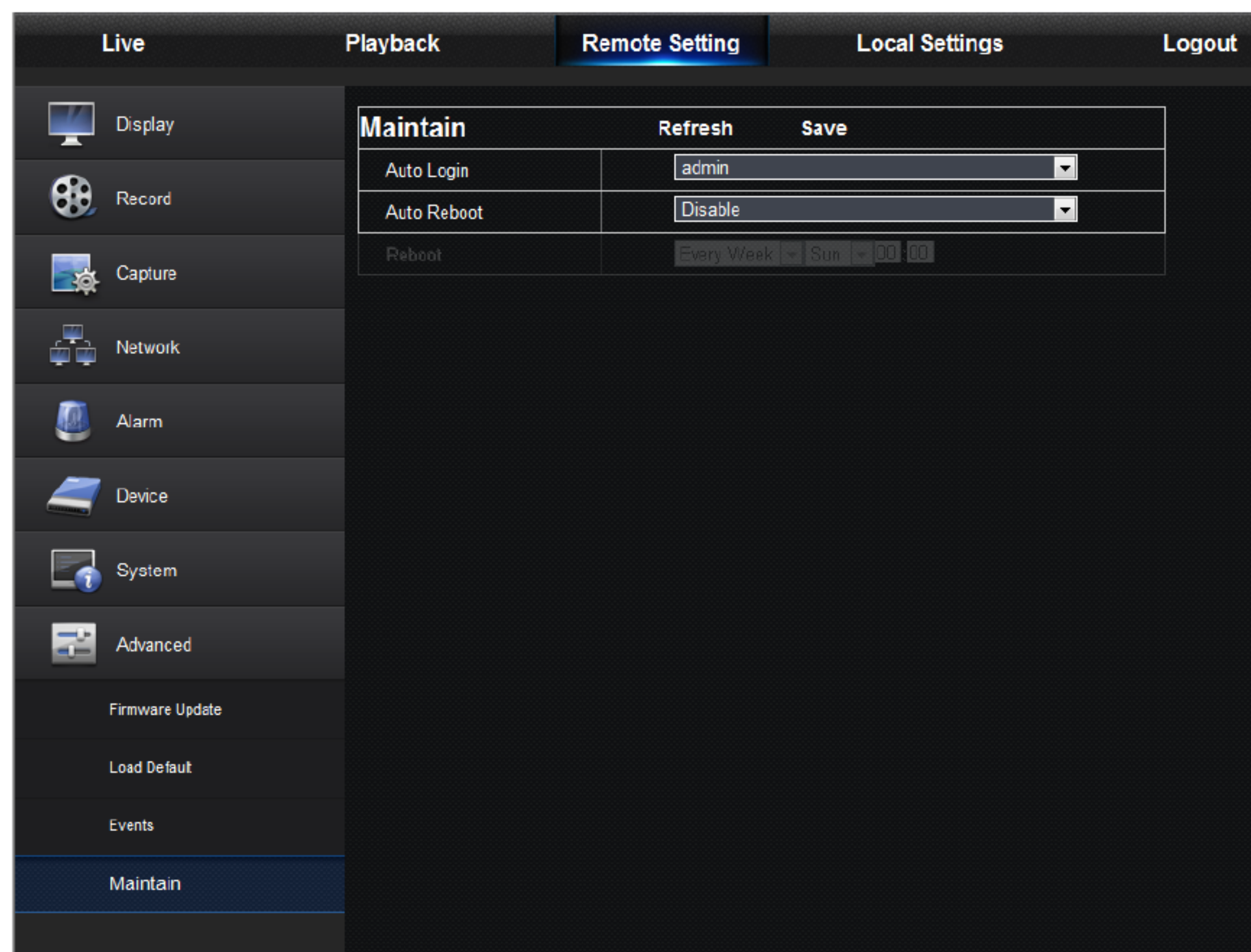

4.3.9 Local Setting

User may set Record Path (save Live record and Playback clip file), Download Path for remote file, Snapshot Path for captured pictures, Interval for switching record files (Packaging time), and File type (H264 and AVI).

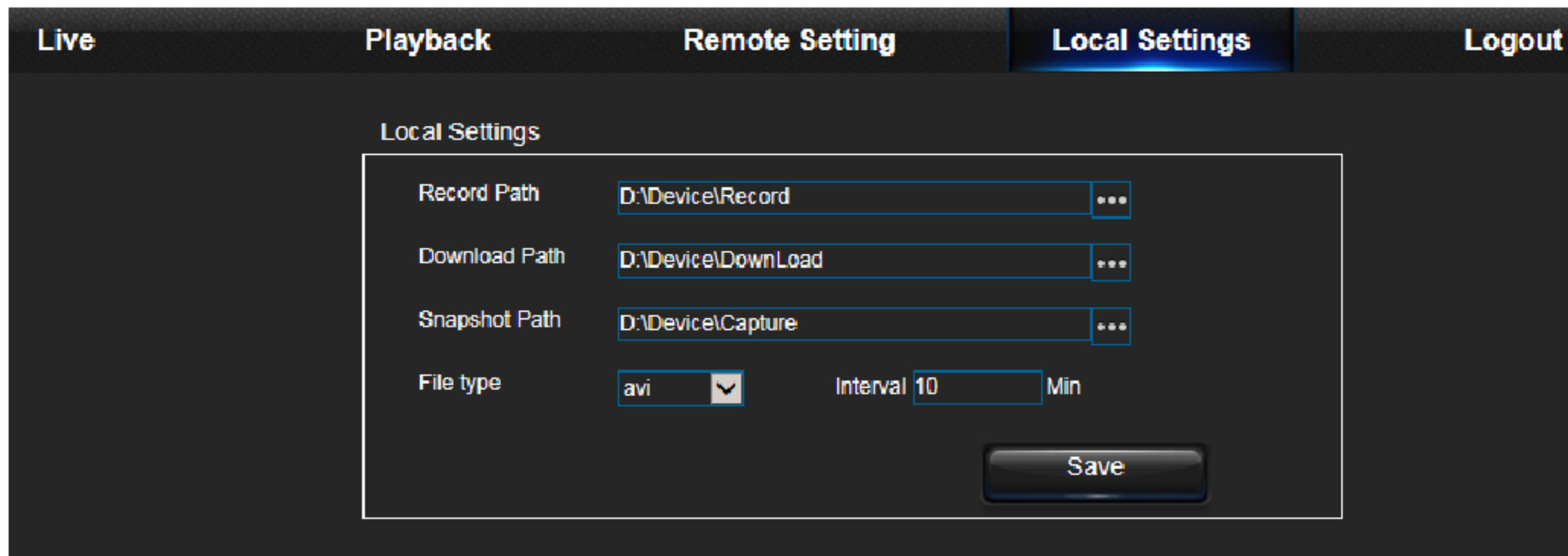

4.3.10 Logout

Click **Logout** to log out and return to the login interface.

Chapter 5 Mobile App

Android Phones/Tablets

- 1) Open Play Store to search WiseView and click 'INSTALL' to install.

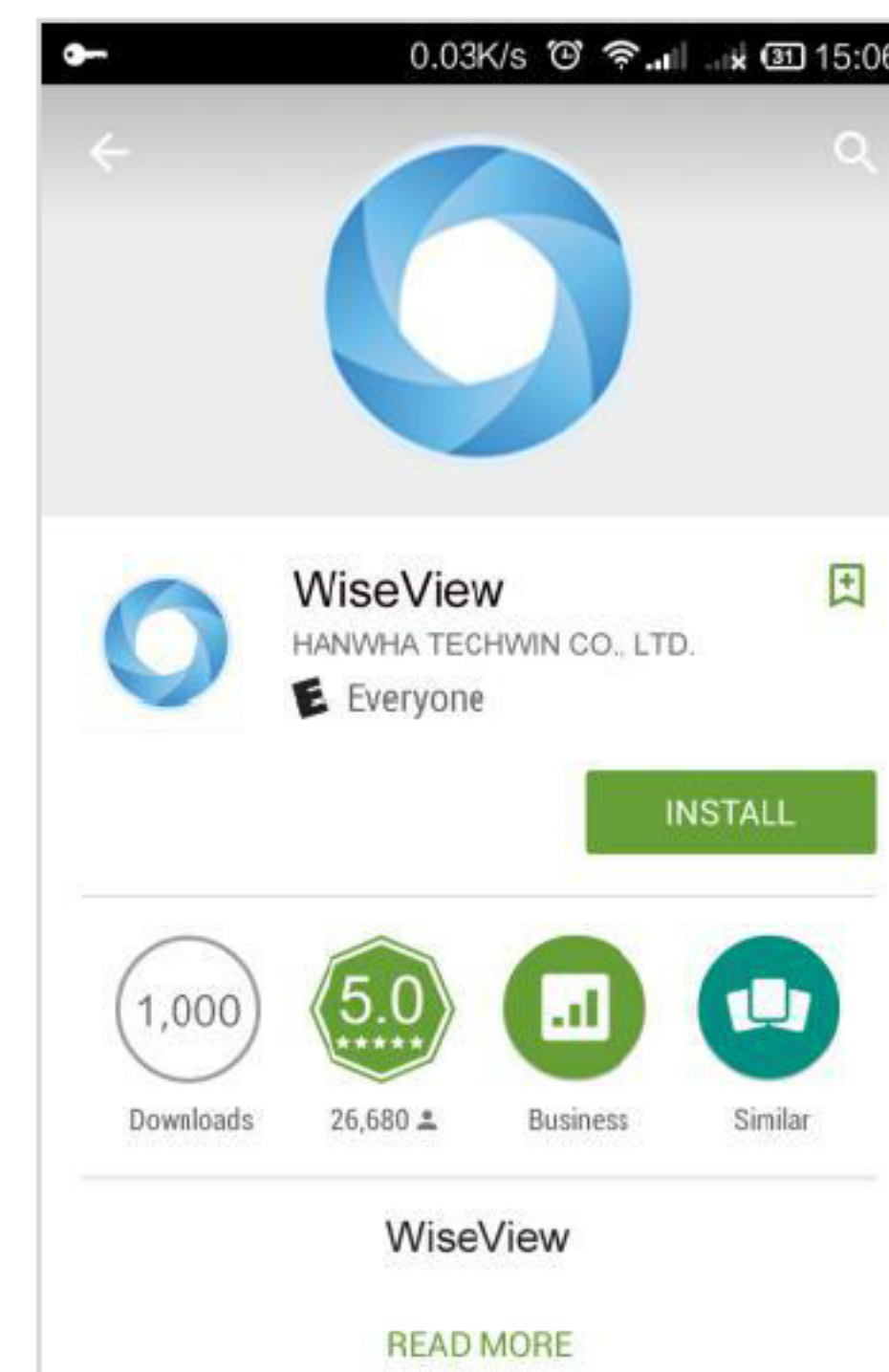
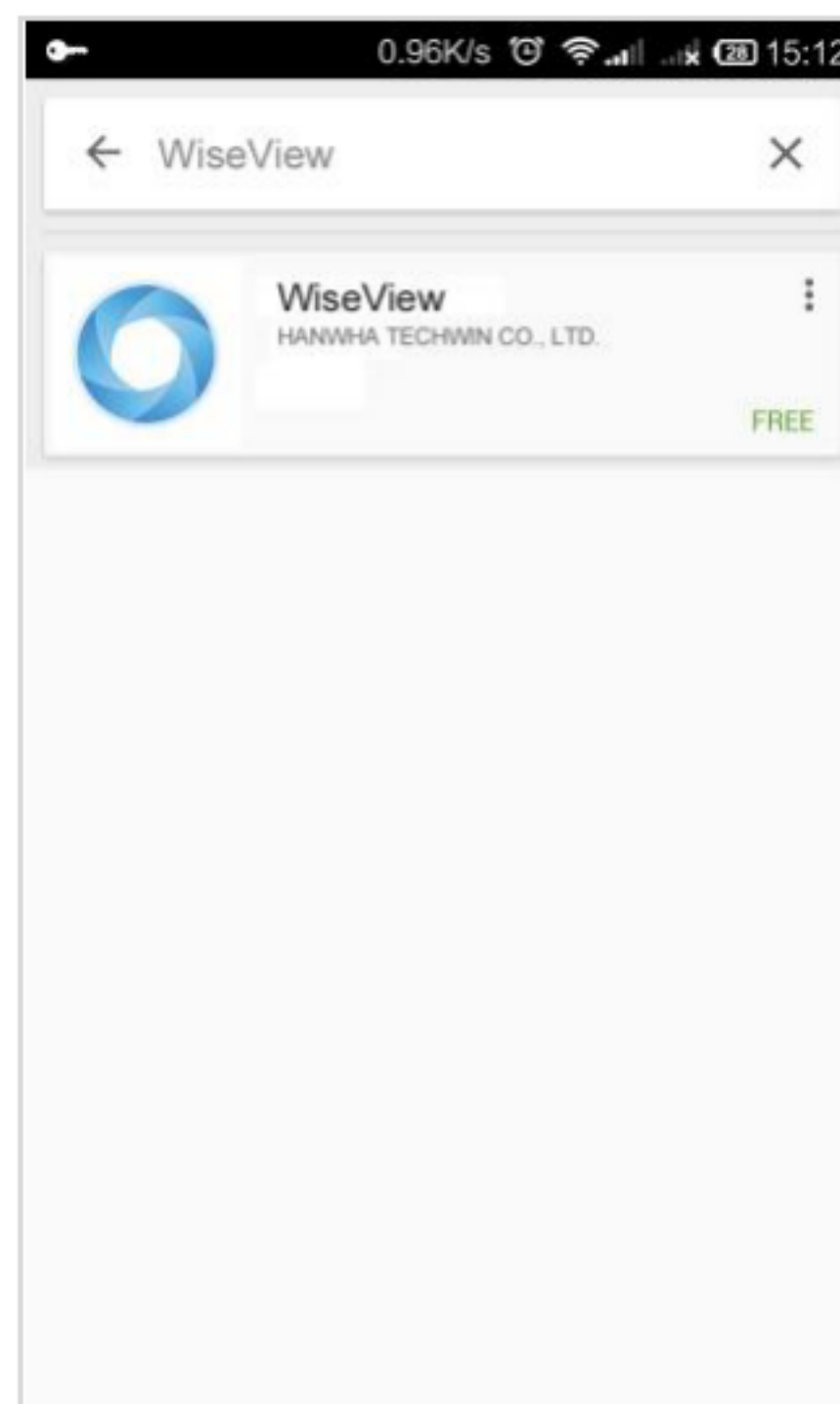
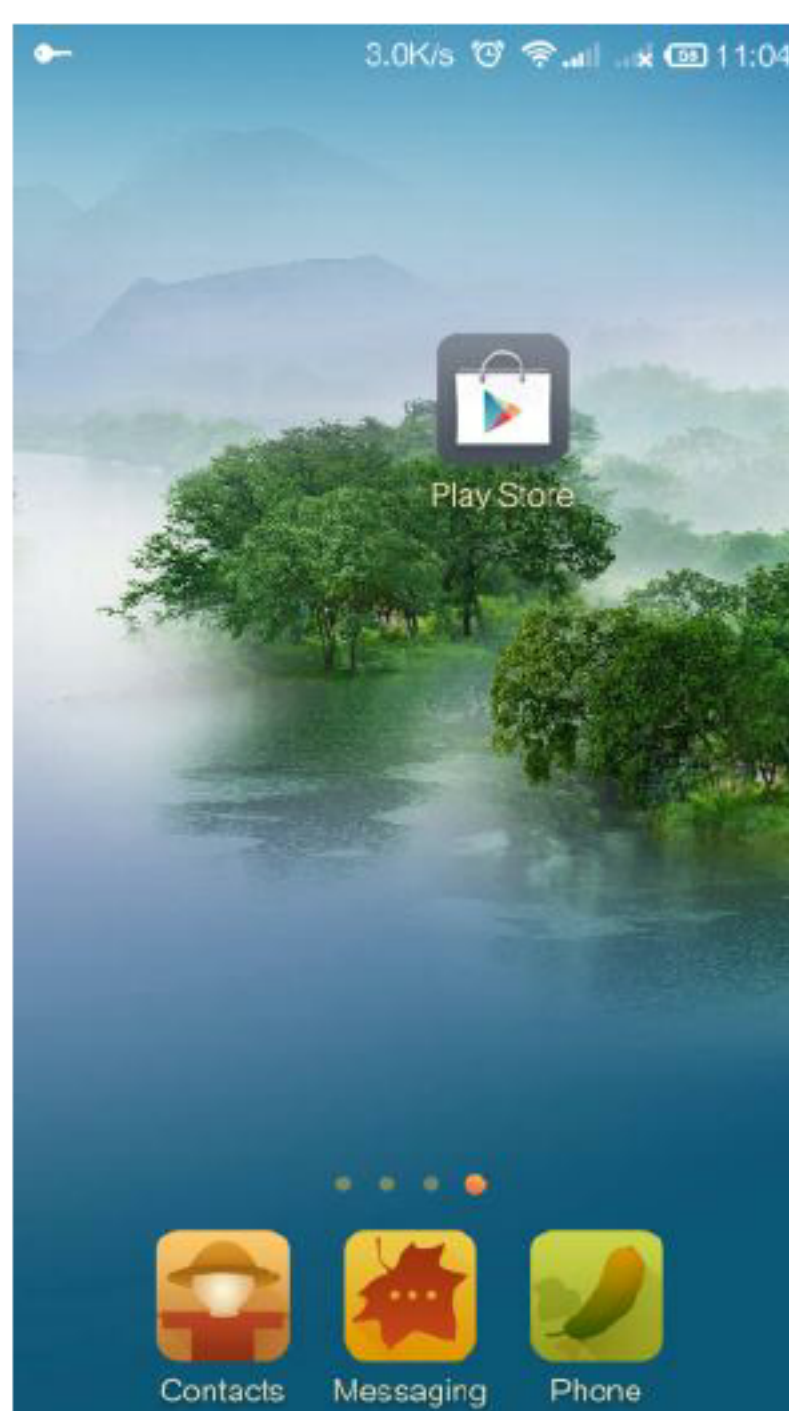

2) After installation, open WiseView and select 'Device'. Then click '+' to add new device. Scan QR code under Information page of system on local DVR. Then input client port, user name and password, and then click Save to log in to the device.

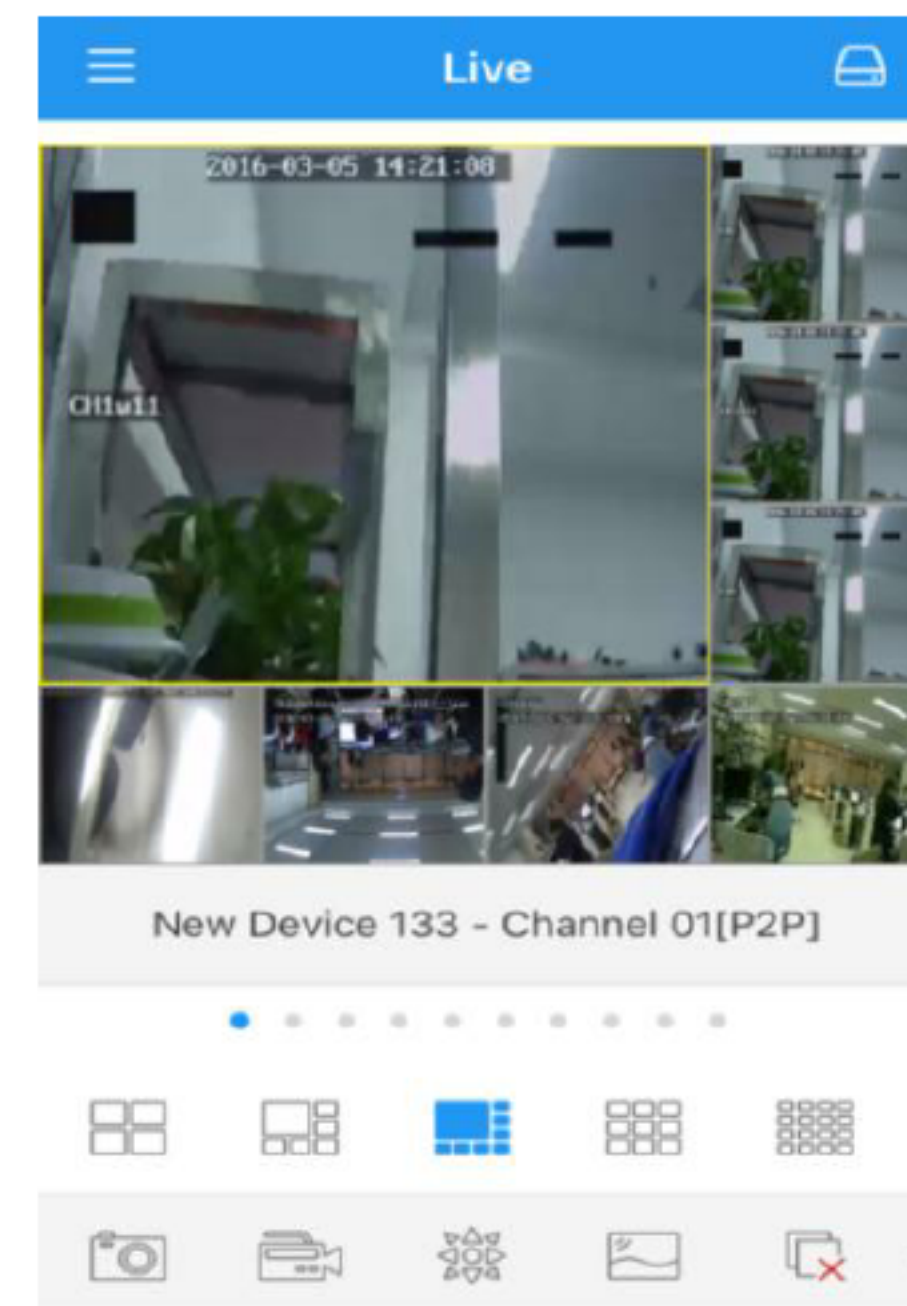
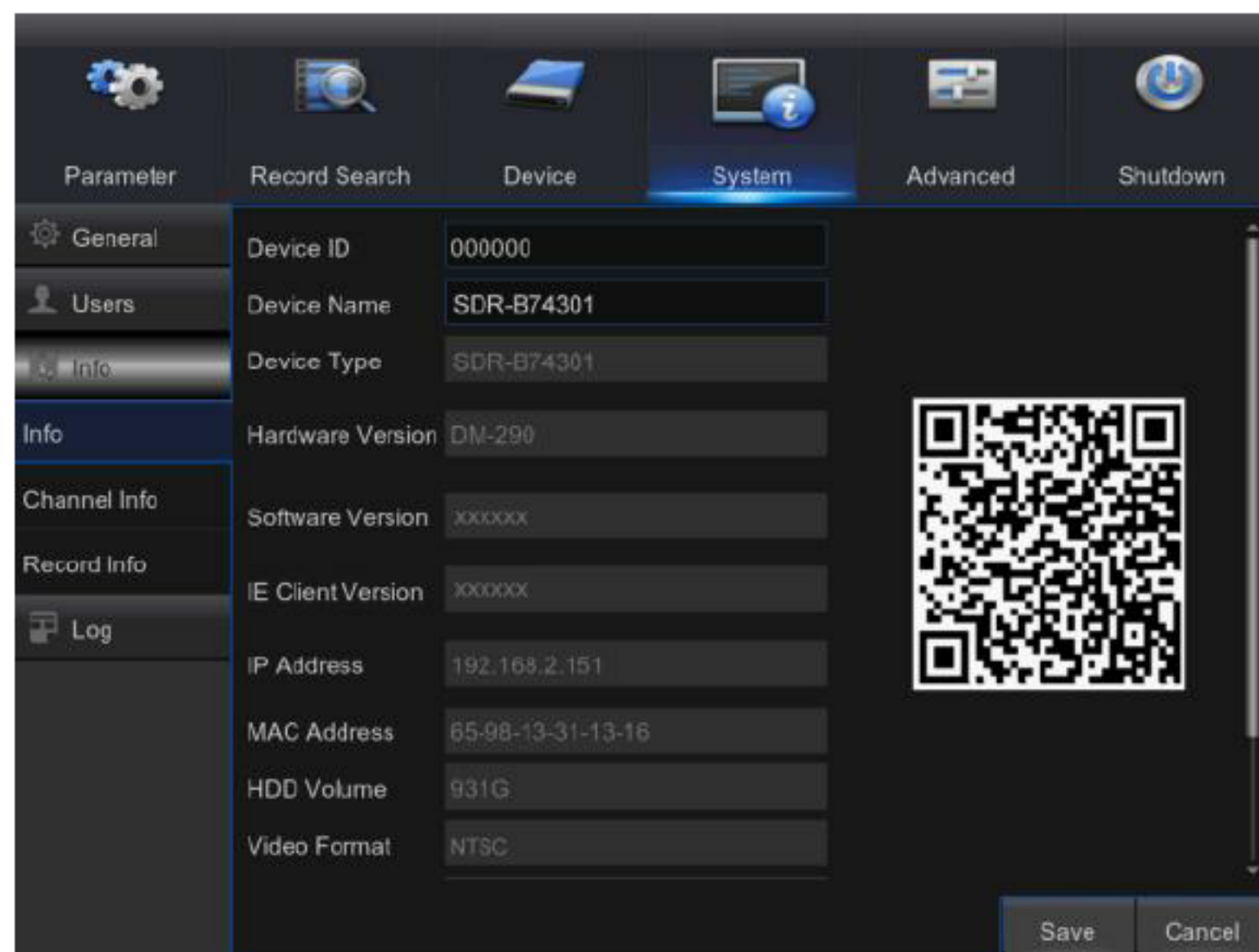
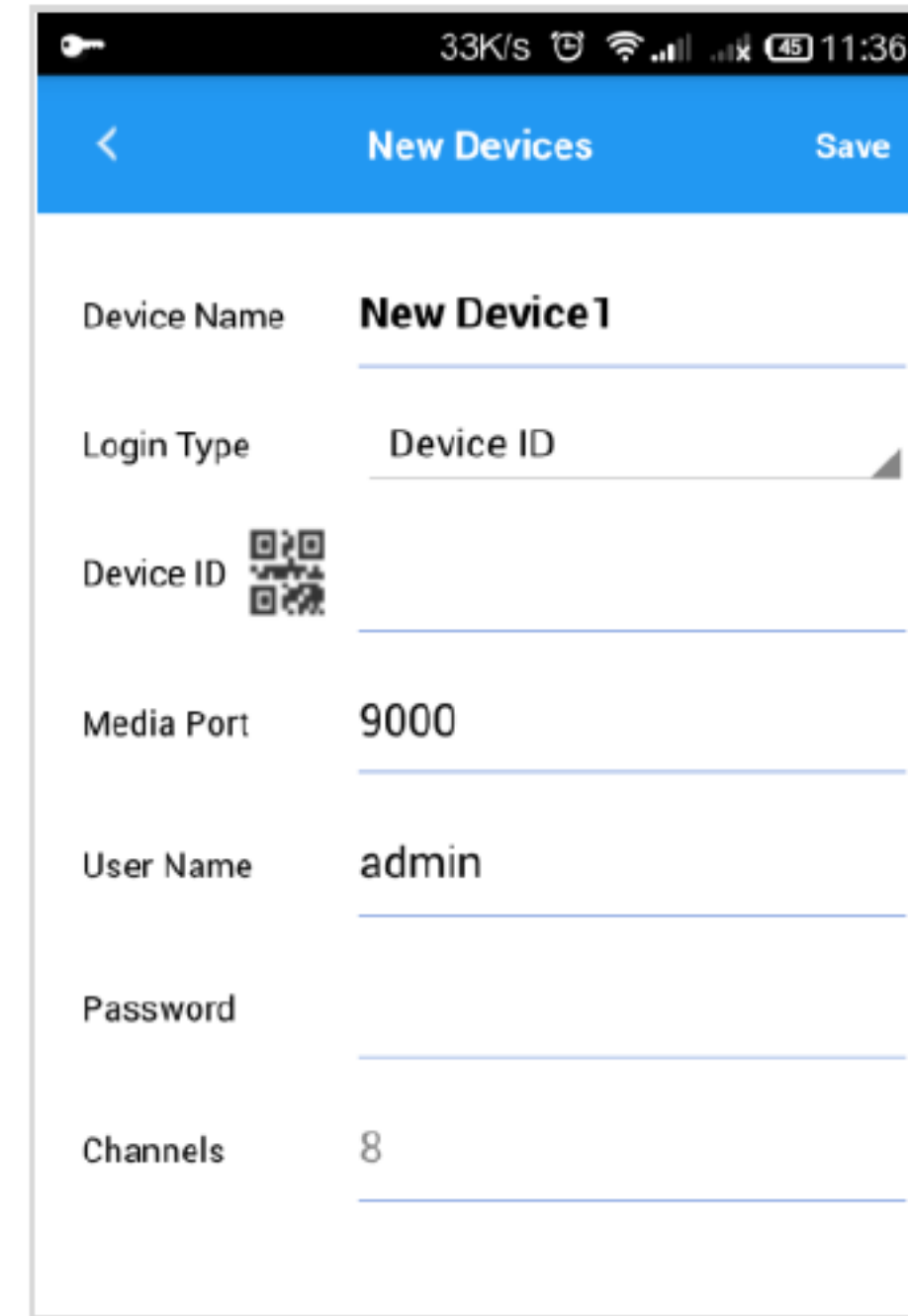
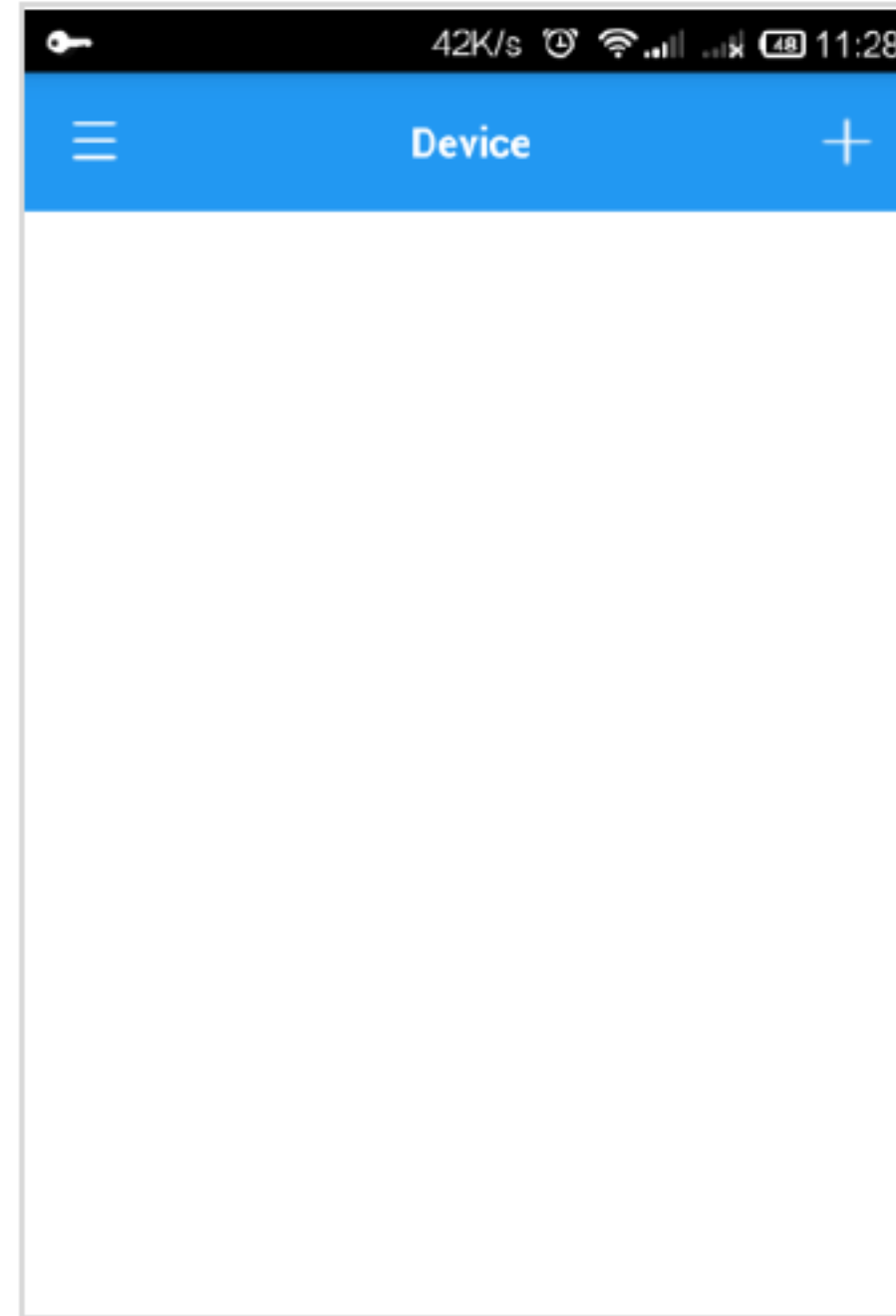
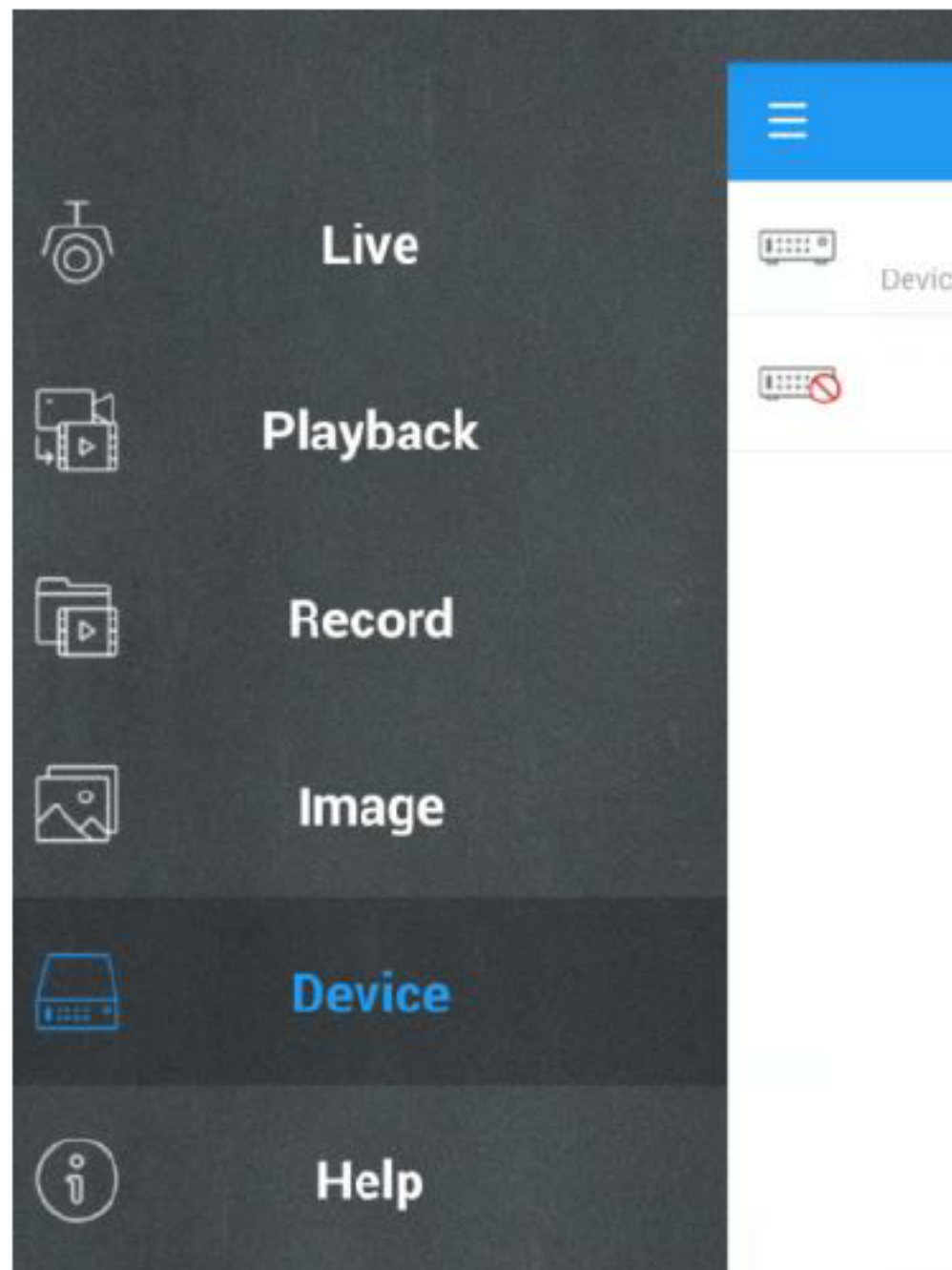

iPhone/iPad

1. Open App Store to search WiseView, and click icon  to install.

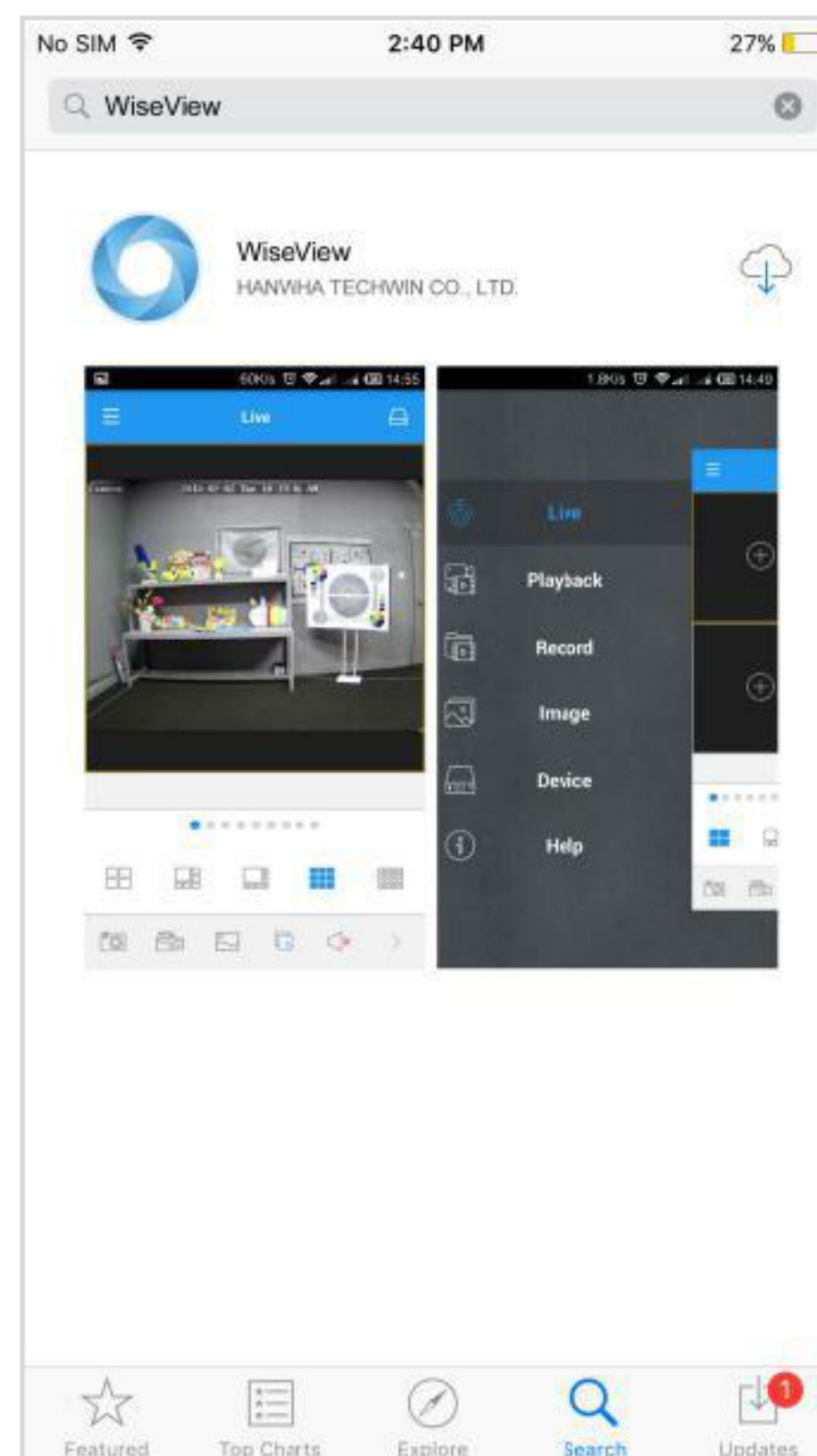
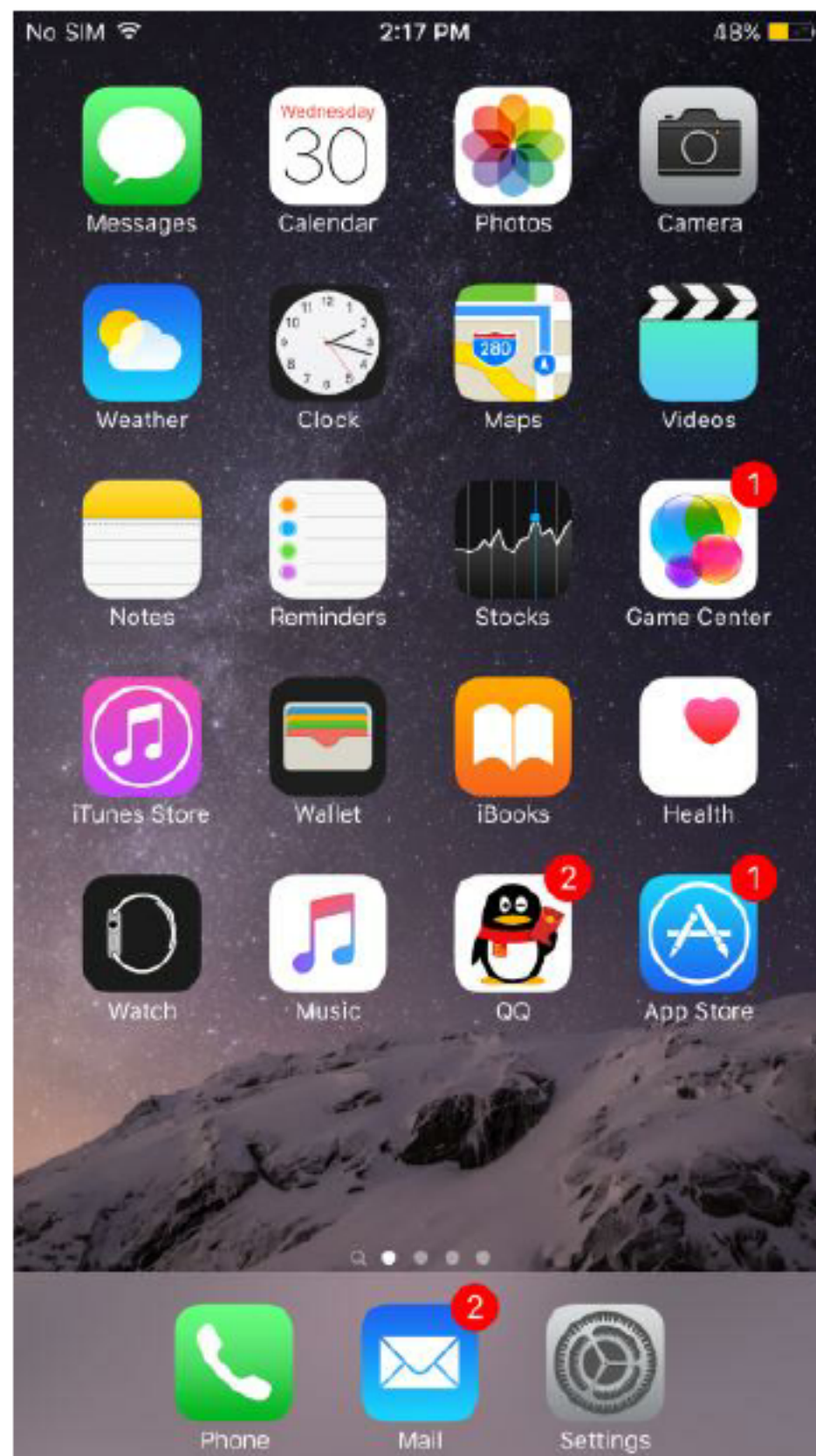

2. Open WiseView, and go to Device. Click '+' to add new device. Scan QR code under Information page of system on local DVR. Then input client port, user name and password, and then click Save to log in to the device.

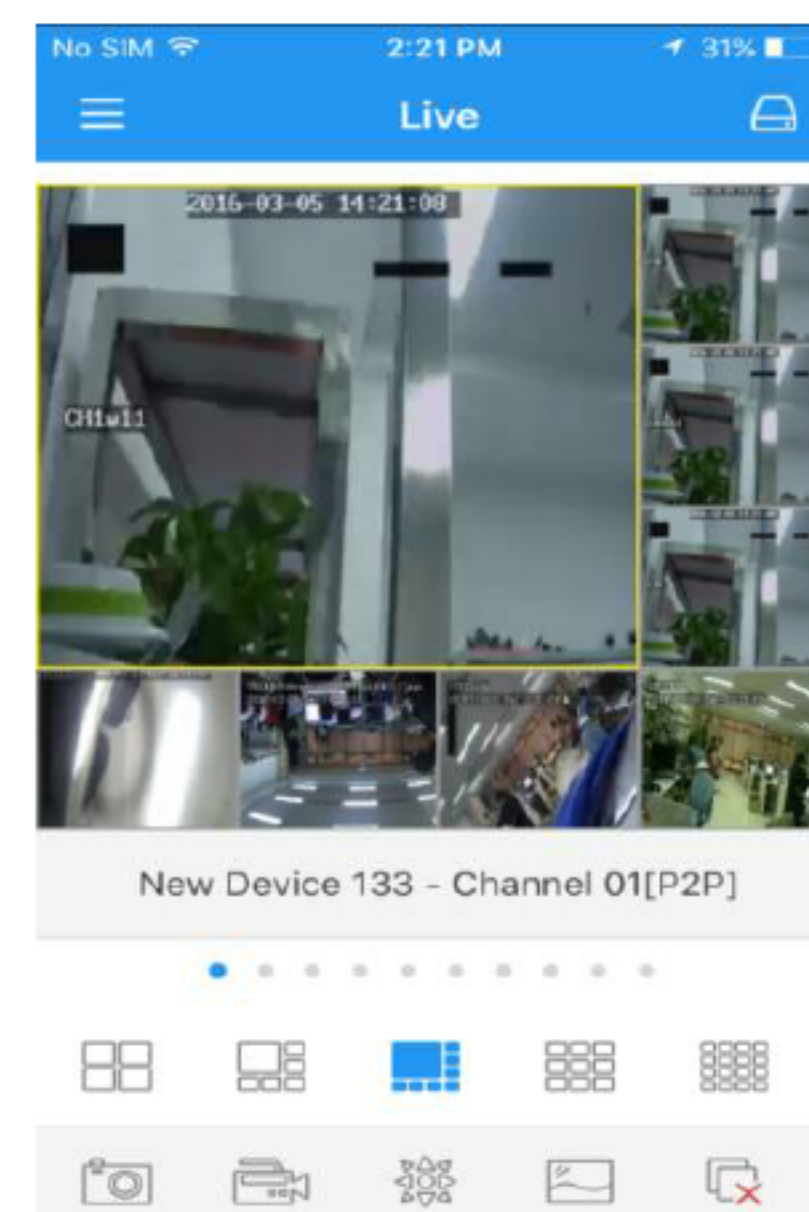
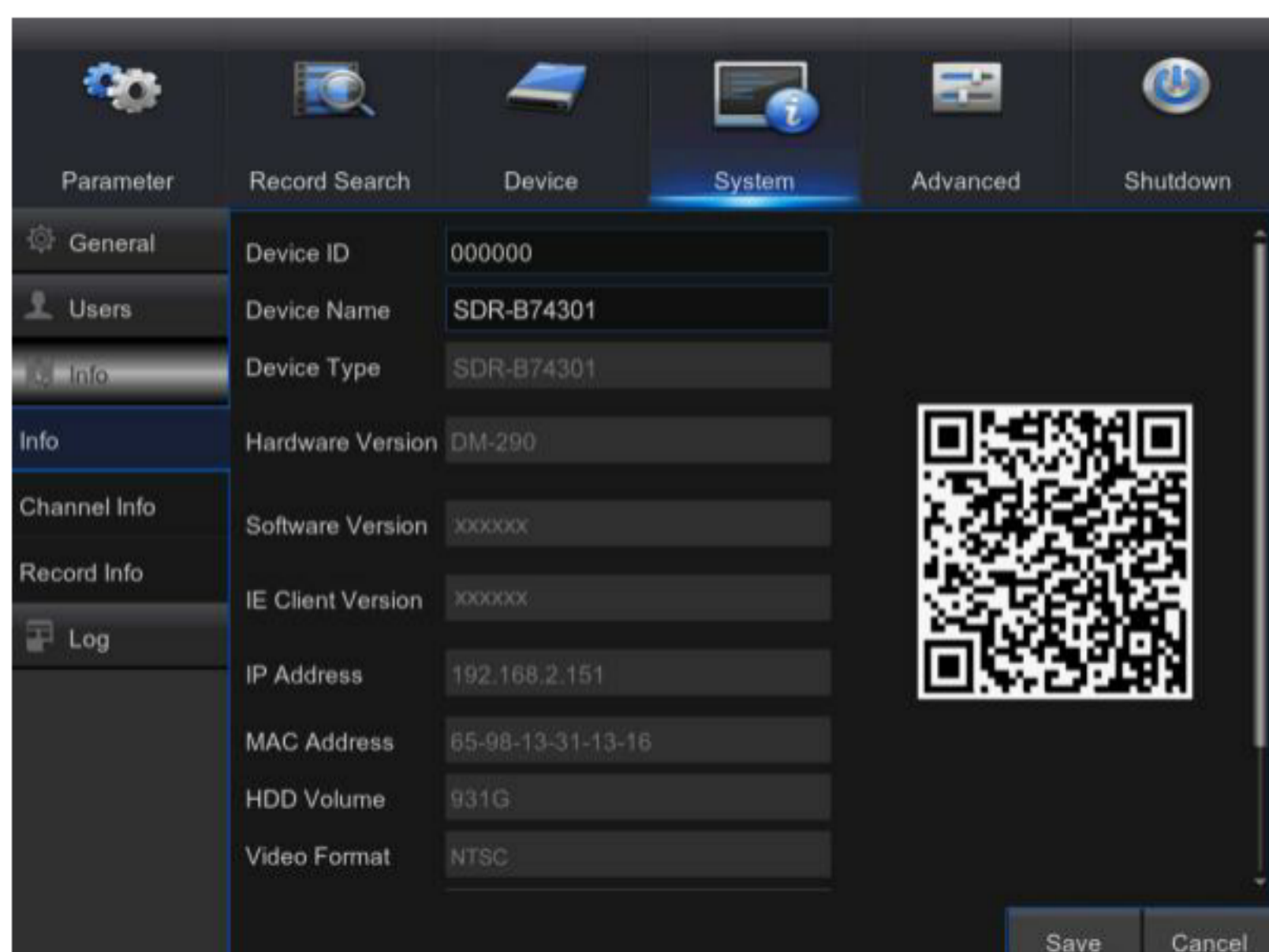
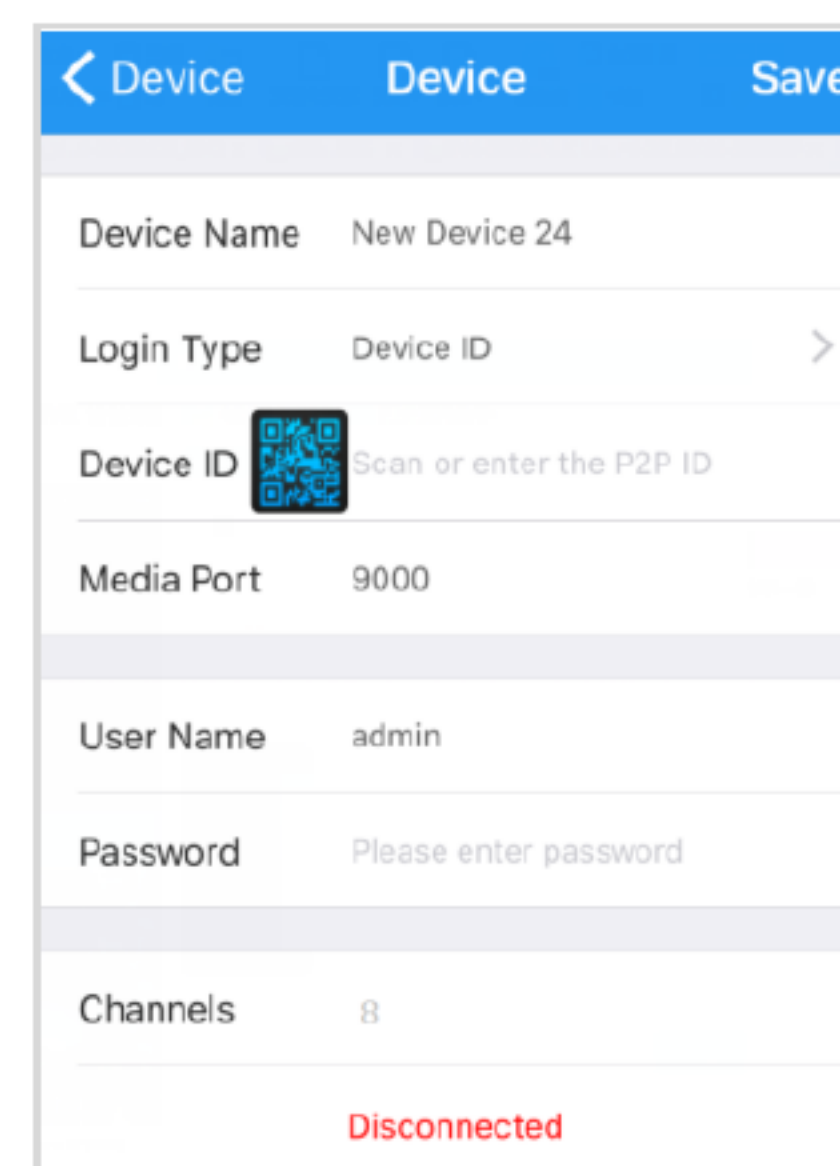
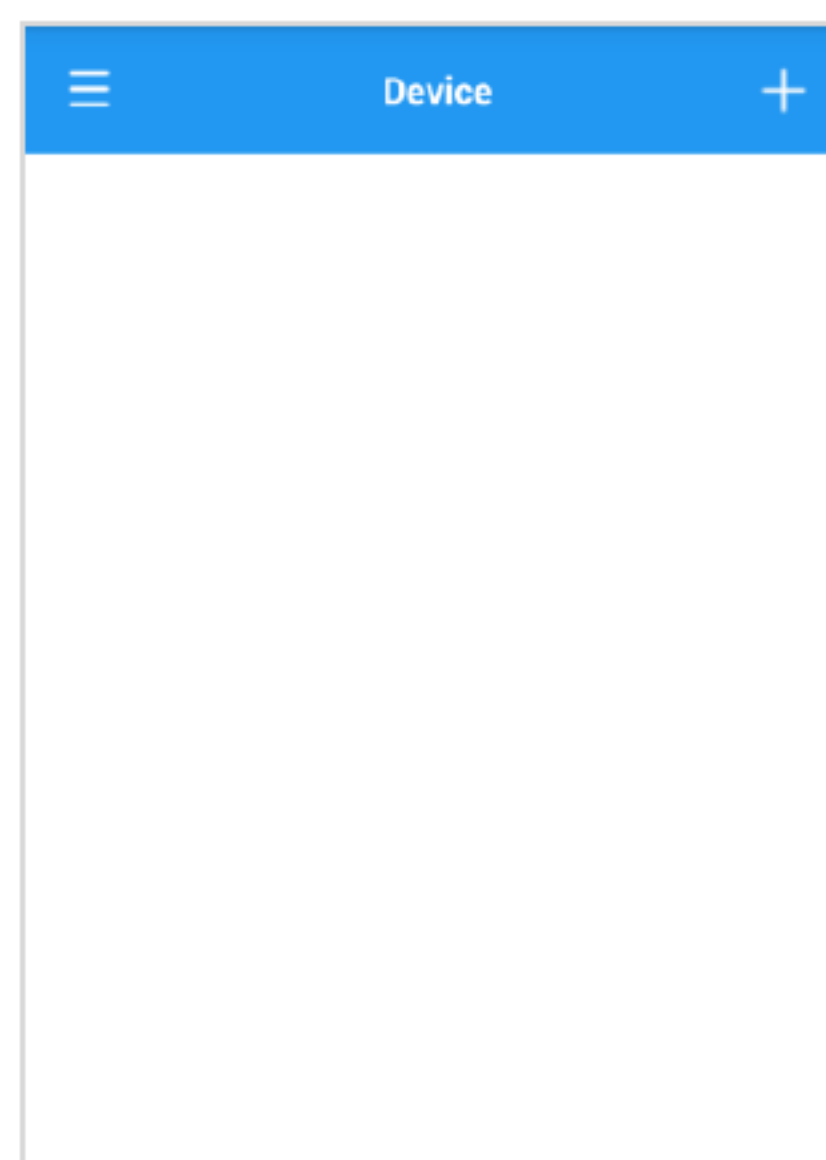
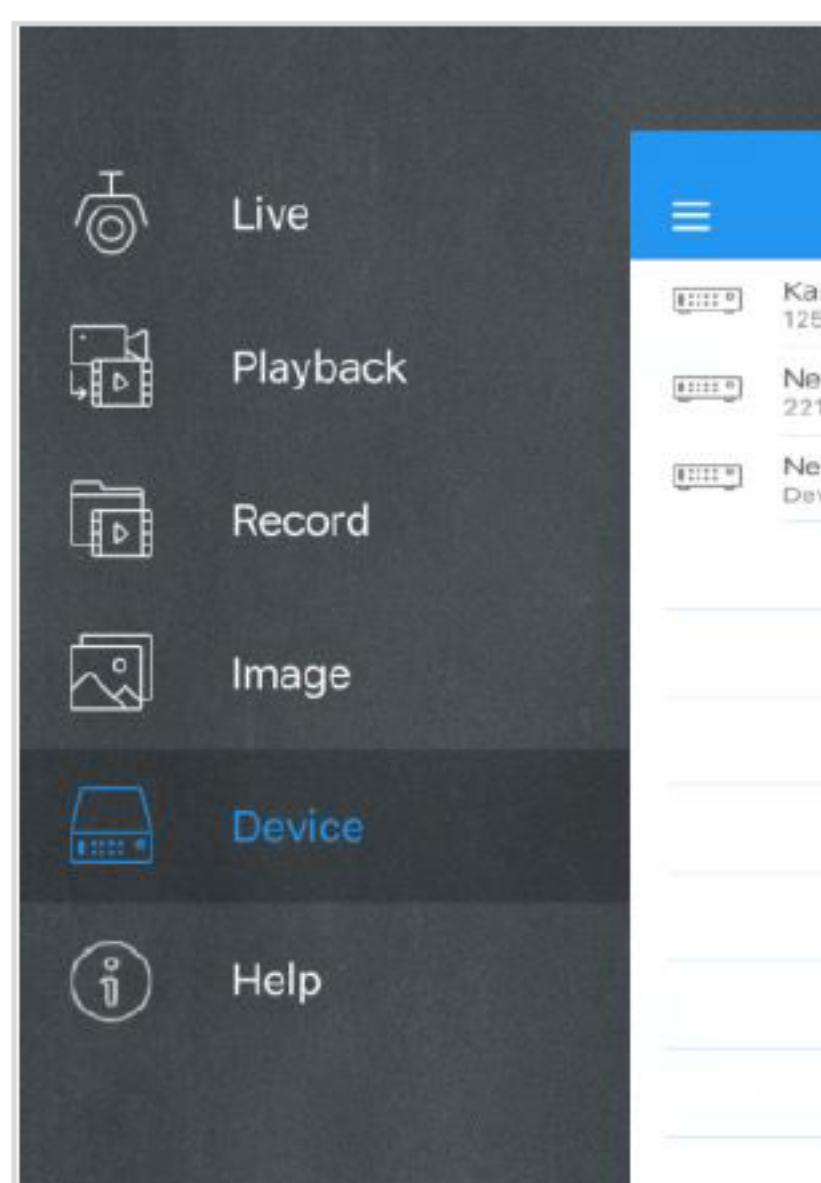

Chapter 6 Appendix

6.1 Troubleshooting

1. Q: What can I do if the system does not detect the HDD?
A: Check if the power supply system is properly connected and data cord and power cables are securely connected, and if something wrong with the HDD interface. Or you may check if your HDD is supported by referring to the specifications or descriptions.
2. Q: I have changed the password but forget the new password, how can I access the system?
A: If you forget system password, please consult with our technical personnel. We strongly suggest user to set password easily to be remembered and relatively safe.
3. Q: We see abnormal video signal or even no video signal by connecting the DVR and camera together. Power supply for both devices is OK. What is wrong?
A: Check network cable on DVR side to see if the cable is firmly connected and if it is worn out and needs to be replaced, or to check if NTSC or PAL is selected consistently.
4. Q: How to prevent DVR from being influenced by heat?
A: The DVR needs to dissipate heat while it is running. Please place the DVR in a place with good air circulation and away from heat sources to ensure stability and life of the DVR.
5. Q: The remote controller of DVR doesn't work while the monitor screen is OK and panel keys are functional. Why?
A: Operate again by aiming the remote controller at the IR receiver on front panel. If it still doesn't work, please check if the batteries in the remote controller are dying. If not, check if the remote controller is broken.
6. Q: I want to take out HDD from my PC and install it in DVR. Can it work?
A: All HDDs supported by the system can be used. But remember, once DVR runs, the data on your HDD will be lost.
7. Q: Can I playback while recording?
A: Yes. The system supports the function of playing while recording.
8. Q: Can I clear some records on HDD of DVR?
A: In consideration of the file security, you may not clear part of records. If you want to remove all the records, you can format HDD.
9. Q: Why can't I log in DVR client?
A: Please check if the network connection settings are correct and check if your account and password are correctly input.
10. Q: Why can't I find any records during playback?
A: Please check if the data line connection for HDD is OK and system time is properly adjusted. Try a few times and restart. If it still doesn't work, check if the HDD is broken.
11. Q: Why doesn't dynamic detection work?
A: Please check if the motion detection sensitivity level set is too low and motion detection area setting is correct.
12. Q: Why does buzzer keep alarming?
A: Please check the alarm setting, check if motion detection function is enabled and object motion is detected all the time. Besides, refer to corresponding HDD alarm setting.

6.2 Usage Maintenance

1. To shut down DVR, please firstly shut down the system and then turn off the power. Do not turn off the power directly or HDD data will be lost or damaged.
2. Please keep DVR away from heat sources or places.
3. Clean the internal dust regularly. Make sure the good ventilation of DVR so as to ensure the good heat dissipation.
4. Please do not hot plugging audio and video cables, otherwise the ports will be damaged.
5. Please check the HDD cable and data cable regularly to see if they are ageing.
6. Please prevent the audio and video signals of DVR from being intervened by other electronic devices, and prevent the HDD from being damaged by static electricity and induced voltage.
If the network cable is frequently plugged, it is suggested to replace connecting line regularly, or the input signal may be unstable.
7. This is A class product. it maybe bring wireless interference in life. Under this situation, it need user to make measures.

6.3 Specifications

CAMERA MODEL: SDC-9443BC

Video		SDC-9443BC
Imaging Device		2M CMOS (1/2.7")
Effective Pixels		1920(H) x 1080(V)
Scanning System		Progressive, 30fps/25fps
Synchronization		Internal
Horizontal Resolution		1080P
Min. Illumination		0 Lux (IR LED ON)
Camera Output		1CH BNC
		Max. Transmission Length: 180ft (3EA attached 60ft camera cable combined)
Lens		
Focal Length		3.6mm
Max. Aperture Ratio		F2.1
Angular Field of View(H / V / D)		D:105°/H:88°/V:46°
Operational		
Shutter Mode		Auto(Rolling Shutter)
Gain Control		Auto
White Balance		Auto (1800~10500°K)
Wide Dynamic Range		N/A
Contrast Enhancement		Auto
Digital Noise Reduction		3DNR
OSD		N/A
Flickerless		Auto
Day & Night		TRUE D/N, Auto
IR Distance		82ft(Total Darkness)/130ft(Ambient Lighting)
Environmental		
Operating Temperature / Humidity		-10°C ~ +50°C (+14°F ~ +122°F) / Less than 90% RH
Ingress Protection		IP66
Electrical		
Input Voltage		DC 12V
Power Consumption		4W(IR LEDS ON)
Mechanical		
Color / Material		White /Metal
Dimension (Ø x H)		Ø68x149mm (2.68" x 5.87")
Weight		0.32kg
Accessory	Bracket	one body (assembled)
	Screw	3 EA (per Cam)
	Anchor	3 EA (per Cam)
	Hex Key	1 EA (per Cam)
	Cable	60ft BNC Cable 4 EA(SDH-B74041) 60ft BNC Cable 8 EA(SDH-B74081)

DVR

Description		SDR-B74301
Video	Inputs	8ch BNC
	Resolution	1080P/720P/960H
Live	Frame rate	NTSC:240fps@ 1920 x 1080 / 240fps@1280 x 720 / 240fps@960 x 480 PAL:200fps@ 1920 x 1080 / 200fps@1280 x 720 / 200fps@960 x 480
	Resolution	1080P/720P/960H
	Multi Screen display	single/ Quad/Eight/S.E.Q.
Performance		
Operating System	Embedded	Linux
	Installation wizard	support
Recording	Compression	H.264
	Record Rate	up to 120fps@1920x1080
		up to 240fps@1280x720
		up to 240fps@960x480
	Mode	Manual, Schedule (Continuous/Event), Event(Pre/Post)
	Event	Video Loss, Motion(Sensitivity Level 1~8)
	Overwrite modes	Off/On(Auto/1/3/7/14/30/90days)
	Pre-alarm	Min. 1S
	Post-Alarm	Up to 5min (30 sec,1,2,5min)
Search & Playback	Search mode	Date/time, Event,Motion
	Playback function	Fast forward / backward (2x, 4x, 8x, 16x) Slow forward(1/2x, 1/4x, 1/8x,1/16x) Step Forward (applicable for local DVR only)
Network (IPv4)	Transmission speed	Max. 1080P 120fps
	Bandwidth	Up to 32Mbps
	Bandwidth control	Fixed
	Live stream	Max. 1080P 120fps
	Max. Remote Users	20 (Max. bandwidth 32M)
	Protocol support	TCP/IP, UDP/IP, RTP(UDP), RTP(TCP), RTSP, NTP, HTTP, DHCP, PPPoE, SMTP, DNS, DDNS, uPnP
	Monitoring	Webviewer, Mobile Viewer

Smart phone	Web / App viewer	Supported OS - PC : Windows® Vista, Windows® 7 Windows® 8 Mac OS X® 10.9 and above - Mobile : Android Ver3.0 or above iOS® 7.0 or above Supported Browser - Microsoft Internet Explorer (Ver. 11,10,9,8), Mozilla Firefox43.0.4, Google Chrome™ V42 Safari®5.1 and above
	Protocol support	TCP/IP, UDP/IP, UDP, P2P
	Transmission speed	CIF Max.25fps (Single channel)
	Remote users Maximum	20 (Max. bandwidth 32M)
Storage	Internal HDD	1TB(SDH-B74041)/2TB(SDH-B74081)
	USB (Back-up)	2 USB Ports
	File Format (Back-up)	H.264, AVI, MP4
Security	Password Protection	1 Admin and 6 Users
Interface		
Monitors	VGA	1 VGA (1024x768, 1280x1024, 1280x720, 1440x900, 1920x1080)
	HDMI	1 HDMI (1024x768, 1280x1024, 1280x720, 1440x900, 1920x1080)
	Simultaneous Output	VGA and HDMI
Audio	Inputs/Output	4CH RCA in/ 1CH RCA out
	Compression	G.711
	Sampling Rate	8KHz
Alarm	Remote notification	Notification via e-mail
Connections	Ethernet	1 RJ45 10/100 Base-T
	USB	USB 2.0, 2 ports (Front/Rear)
	Application Support	Mouse
General		
Electrical	Input Voltage/Current	12V/2A DC Adaptor
	Power consumption	10W(HDD pre-installed)
Environmental	Operating Temperature/ Humidity	0°C~+40°C (32°F ~ 104°F) / 20% ~ 85%RH
Mechanical	Dimension (WxHxD)	300X220X52mm (11.81" x 8.66" x 2.05")
	Weight (With hard disks)	1.44kg

OSD Language		English, French, Spanish
Accessory	Printed Material	Quick Guide
	LAN Cable	1.5m
	HDMI Cable	1.8m (6ft)
	Mouse	1 EA
	Remote Control	1 EA
	Battery	AAA size 2 EA
	Power Adapter FREE VOLT (110V~240V)	2 EA (12V 2A), 1EA for DVR, 1EA for 4 cameras(SDH-B74041) 1 EA (12V 2A) for DVR, 1 EA (12V 3A) for 8 cameras(SDH-B74081)
	Power splitter	1 to 4 way splitter 1 EA(SDH-B74041) 1 to 8 way splitter 1 EA(SDH-B74081)
	CD	User Manual
		Router Guide
Software for Windows(English)		
Software for MAC(English)		

6.4 Dimension

DVR

Unit: mm (inch)

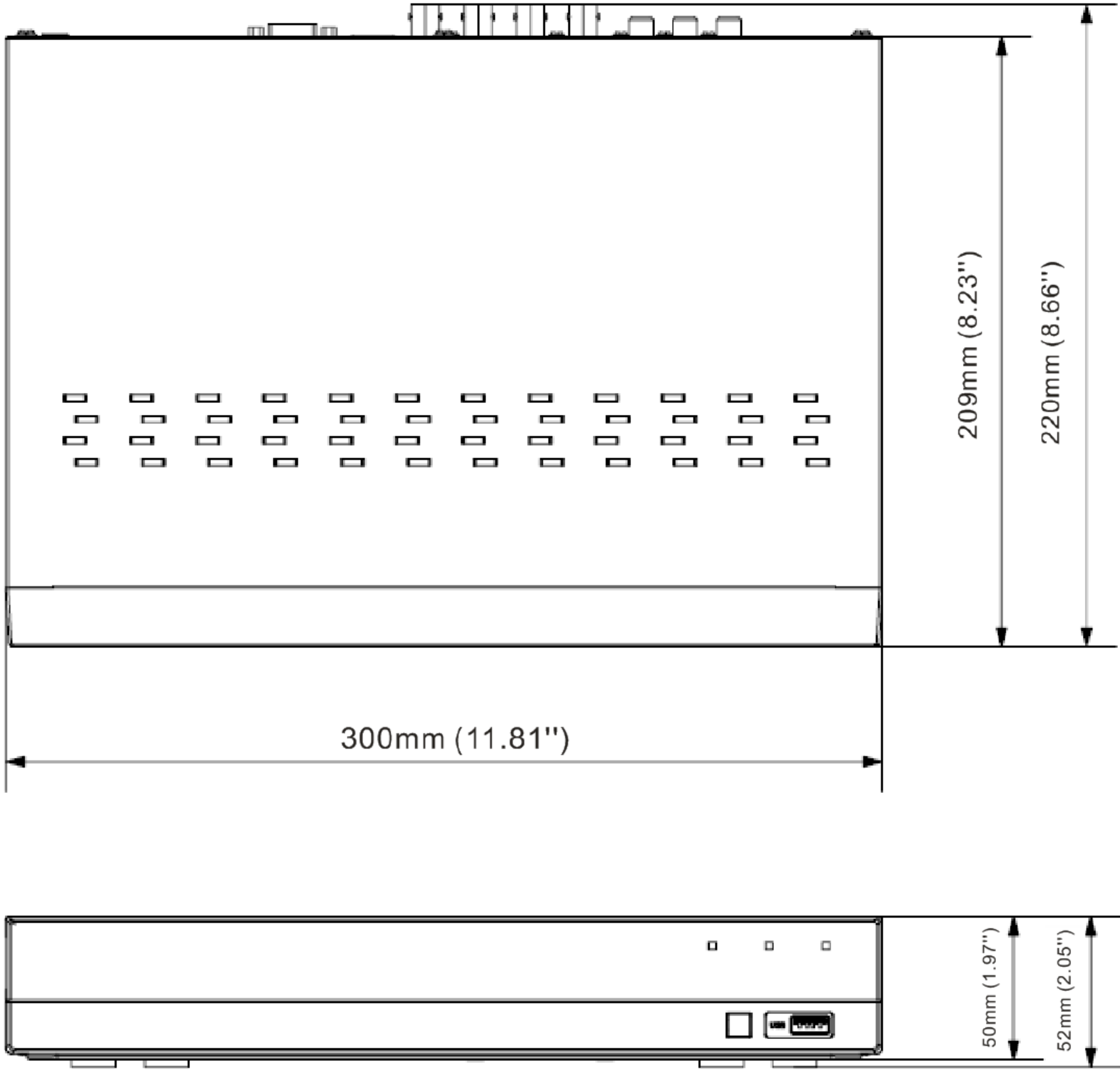

CAMERA

Unit: mm (inch)

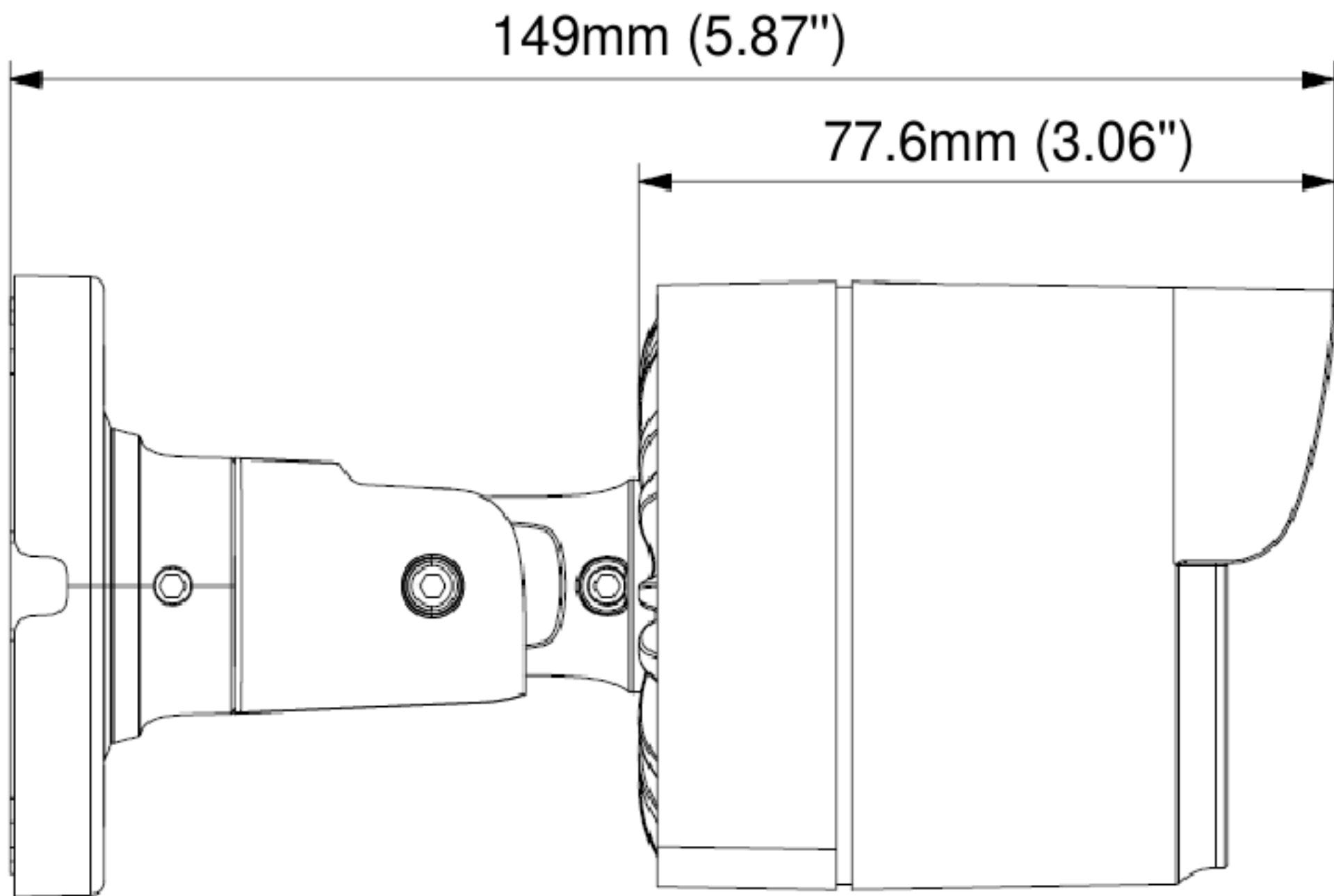
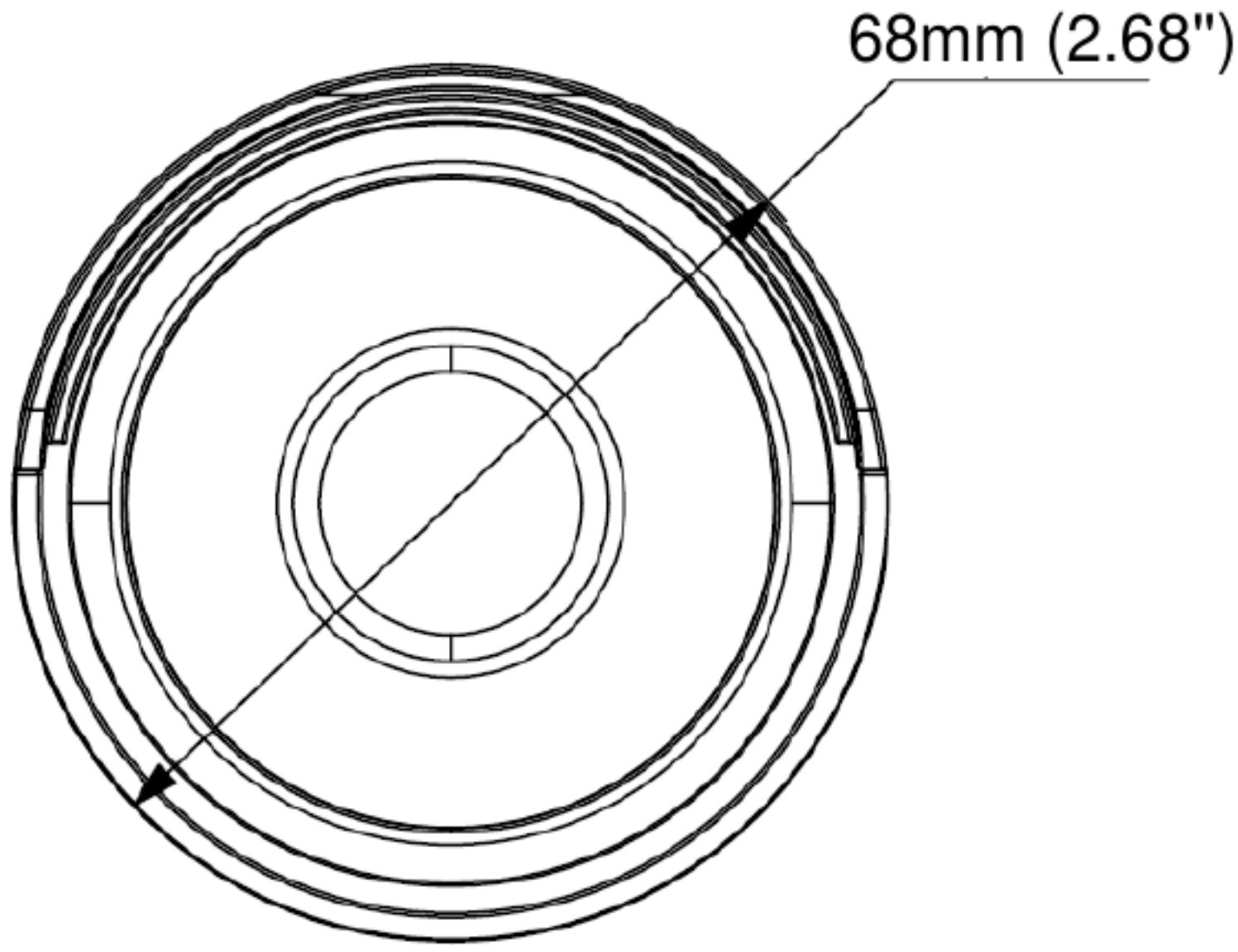
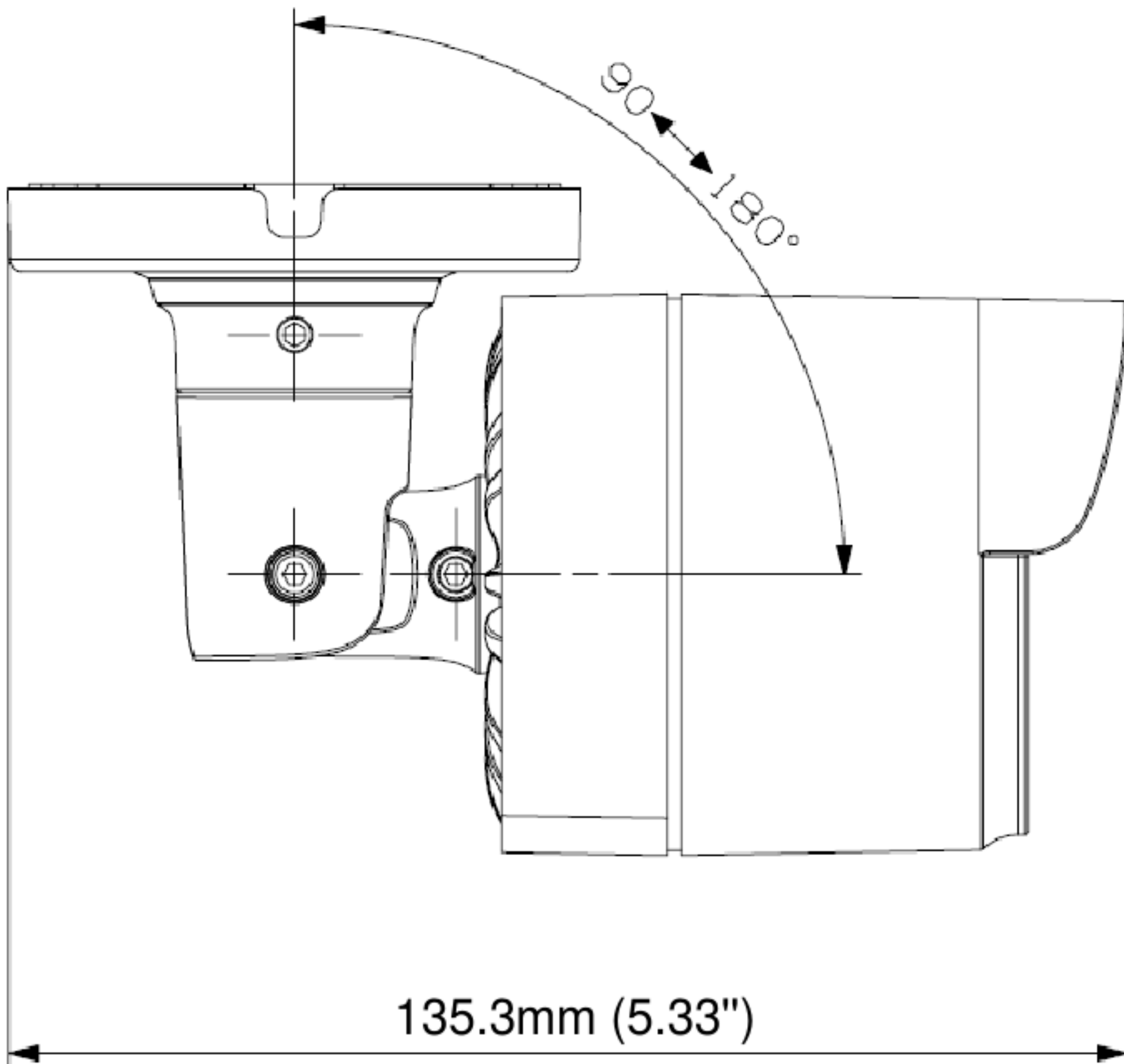

6.4 Accessories Attached

SDH-B74041



DVR



AHD Camera



Screw & Anchor & Hex key



USB Mouse



Quick Guide



Remote Control AAA Battery



60ft Camera Cable



HDMI Cable



12V 2A Power Adaptor for DVR
 12V 2A Power Adaptor for 4 cameras



1 to 4 Way Power Splitter



RJ45 Cable



CD

SDH-B74081



DVR



AHD Camera



Screw & Anchor & Hex key



USB Mouse



Quick Guide



Remote Control AAA Battery



60ft Camera Cable



HDMI Cable



12V 2A Power Adaptor for DVR
 12V 3A Power Adaptor for 8 cameras



1 to 8 Way Power Splitter



RJ45 Cable



CD



Samsung cares for the environment at all product manufacturing stages, and is taking measures to provide customers with more environmentally friendly products. The Eco mark represents Samsung's devotion to creating environmentally friendly products, and indicates that the product satisfies the EU RoHS Directive.



Correct Disposal of This Product (Waste Electrical & Electronic Equipment)

(Applicable in the European Union and other European countries with separate collection systems)

This marking on the product, accessories or literature indicates that the product and its electronic accessories (e.g. charger, headset, USB cable) should not be disposed of with other household waste at the end of their working life. To prevent possible harm to the environment or human health from uncontrolled waste disposal, please separate these items from other types of waste and recycle them responsibly to promote the sustainable reuse of material resources.

Household users should contact either the retailer where they purchased this product, or their local government office, for details of where and how they can take these items for environmentally safe recycling.

Business users should contact their supplier and check the terms and conditions of the purchase contract. This product and its electronic accessories should not be mixed with other commercial wastes for disposal.



Correct disposal of batteries in this product

(Applicable in the European Union and other European countries with separate battery return systems.)

This marking on the battery, manual or packaging indicates that the batteries in this product should not be disposed of with other household waste at the end of their working life. Where marked, the chemical symbols Hg, Cd or Pb indicate that the battery contains mercury, cadmium or lead above the reference levels in EC Directive 2006/66. If batteries are not properly disposed of, these substances can cause harm to human health or the environment.

To protect natural resources and to promote material reuse, please separate batteries from other types of waste and recycle them through your local, free battery return system.



SALES NETWORK

HANWHA TECHWIN CO., LTD

6, Pangyo-ro 319beon-gil, Bundang-gu, Seongnam-si, Gyeonggi-do, SEOUL 463-400 Rep. of KOREA

Tel : +82-70-7147-8753, 8764 Fax : +82-31-8018-3740

www.samsungsecurity.com

SAMSUNG TECHWIN AMERICA Inc.

100 Challenger Rd. Suite 700 Ridgefield Park, NJ 07660

Toll Free : +1-877-213-1222 Direct : +1-201-325-6920

Fax : +1-201-373-0124

www.samsung-security.com

SAMSUNG TECHWIN EUROPE LTD.

2nd Floor, No. 5 The Heights, Brooklands, Weybridge, Surrey,

KT13 0NY, UK

Tel : +44-1932-82-6700 Fax : +44-1932-82-6701

www.samsungsecurity.co.uk

www.samsungtechwin.com

www.samsungsecurity.com

www.samsungipolis.com