

The Samsung logo is located in the top left corner of the blue cover. It consists of the word "SAMSUNG" in a bold, white, sans-serif font, enclosed within a white oval shape. The background of the cover is a solid blue color with a subtle pattern of concentric, overlapping circles and lines that create a sense of depth and movement.

SAMSUNG

User Manual

SL605

Thank you for buying a Samsung Camera. This manual will help you learn to capture images, share or print your photos, and edit photos with the accompanying software. Please read this manual thoroughly.

Instructions

Use this camera in the following order.

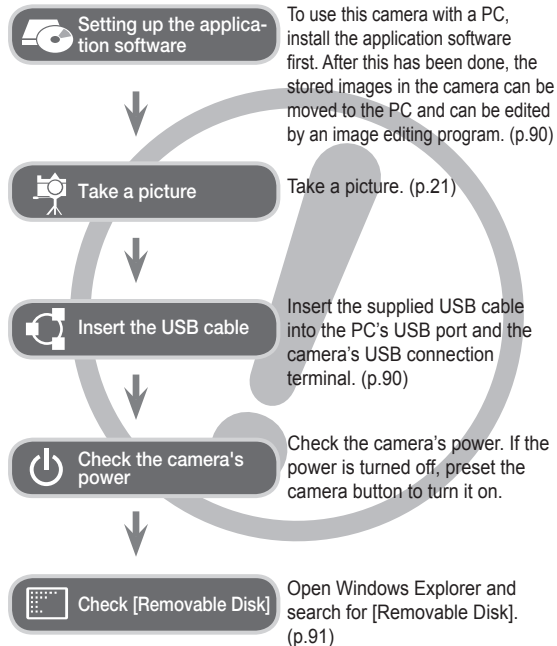

Getting to know your camera

Thank you for buying a Samsung Digital Camera.

- Prior to using this camera, please read the user manual thoroughly.
 - If you require After Sales service, please bring the camera and the cause of the camera malfunction (such as battery, memory card etc.) to an Authorised Service center.
 - Please check that the camera is operating properly prior to when you intend to use it (e.g. for a trip or an important event) to avoid disappointment. Samsung takes no responsibility for any loss or damage that may result from camera malfunction.
 - Keep this manual in a safe place.
 - If you use a card reader to copy the images on the memory card to your PC, the images could be damaged. When transferring the images taken with the camera to your PC, be sure to use the supplied USB cable to connect the camera to your PC. Please note that the manufacturer holds no responsibility for loss or damage of images on the memory card due to the use of a card reader.
 - The contents and illustrations of this manual are subject to change without prior notice for upgrading the camera functions.
- ※ Microsoft, Windows and Windows logo are registered trademarks of Microsoft Corporation incorporated in the United States and/or other countries.
- ※ Adobe and Reader are either trademarks or registered trademarks in the United States and/or other countries.
- ※ All brand and product names appearing in this manual are registered trademarks of their respective companies.
- ※ For Open Source License information, refer to the "OpenSourceInfo.pdf" in the provided CD-ROM.

Danger

DANGER indicates an imminently hazardous situation which, if not avoided, will result in death or serious injury.

- Do not attempt to modify this camera in any way. To do so may result in fire, injury, electric shock or severe damage to you or your camera. Internal inspection, maintenance and repairs should only be carried out by your dealer or Samsung Camera Service center.
- Please do not use this product in close proximity to flammable or explosive gases, as this could increase the risk of explosion.
- Should any form of liquid or a foreign object enter the camera, do not use it. Switch off the camera, and then disconnect the power source. You must contact your dealer or Samsung Camera Service center. Do not continue to use the camera as this may cause a fire or electric shock.
- Do not insert or drop metallic or inflammable foreign objects into the camera through access points e.g. the memory card slot and battery chamber. This may cause a fire or electric shock.
- Do not operate this camera with wet hands. This could pose a risk of electric shock.

Warning

WARNING indicates a potentially hazardous situation which, if not avoided, could result in death or serious injury.

- Do not use the flash in close proximity to people or animals. Positioning the flash too close to your subject's eyes may cause eyesight damage.
- For safety reasons keep this product and accessories out of reach of children or animals to prevent accidents e.g.:
 - Swallowing battery or small camera accessories. If an accident should occur, please consult a doctor immediately.
 - There is the possibility of injury from the camera's moving parts.
- Battery and camera may become hot during prolonged use and it may result in camera malfunction. Should this be the case, allow the camera to sit idle for a few minutes to allow it time to cool.
- Do not leave this camera in places subject to extremely high temperatures, such as a sealed vehicle, direct sunlight or other places of extremes in temperature. Exposure to extreme temperatures may adversely affect the camera's internal components and could cause a fire.
- When in use, do not cover the camera or charger. This may cause heat to build up and distort the camera body or cause a fire. Always use the camera and its accessories in a well ventilated area.

Caution

CAUTION indicates a potentially hazardous situation which, if not avoided, may result in a minor or moderate injury.

- Leaking, overheating or damaged battery could result in fire or injury.
 - Use battery with the correct specification for the camera.
 - Do not short circuit, heat or dispose of battery in fire.
 - Do not insert the battery with the polarities reversed.
- Remove the battery when not planning to use the camera for a long period of time. Otherwise the battery may leak corrosive electrolyte and permanently damage the camera's components.
- Do not fire the flash while it is in contact with hands or objects. Do not touch the flash after using it continuously. It may cause burns.
- Do not move the camera while it is switched on if you are using the AC adapter. After use, always switch off the camera before unplugging the cable from the wall socket. Then make sure that any connector cords or cables to other devices are disconnected before moving the camera. Failure to do so may damage the cords or cables and cause a fire or electric shock.
- Take care not to touch the lens or lens cover to avoid taking an unclear image and possibly causing camera malfunction.
- Avoid obstructing the lens or the flash when you capture an image.
- When using this camera in low temperatures, you may experience the following. These are not camera malfunctions and usually recover at normal temperature.
 - It takes longer to turn on the LCD monitor and the color may differ from the subject.
 - When changing the composition, there may be an after image on the LCD monitor.
- Credit cards may be demagnetized if left near the case. Avoid leaving magnetic strip cards near the case.
- Never connect the 20 pin connector to the USB port of a PC. This carries a high risk of computer malfunction.

Contents

READY	007	System chart
	007	Package Contents
	007	Sold Separately
	008	Identification of features
	008	Front & Top
	009	Back
	010	Bottom
	010	5 Function button
	011	Self-timer lamp
	011	Camera Status Lamp
	011	Mode icon
	012	Connecting to a Power Source
	015	Inserting the memory card
	015	Using the Anti-scratch Mask
	016	Instructions on how to use the memory card
	018	When using the camera for the first time
RECORDING	019	LCD monitor indicator
	020	How to use the menu
	021	Starting the recording mode
	021	Selecting modes
	021	How to use the Smart Auto mode
	023	How to use the Program mode
	023	How to use the DIS mode
	024	Using the Photo Help Guide mode
	025	How to use the Scene modes

Contents

026	How to use the Movie mode	045	Auto Focus type
027	Recording the movie clip without sound	045	Metering
027	Pausing while recording a movie clip (Successive Recording)	046	Photo Style Selector
028	How to use the Smart Night Mode	047	Image Adjust
029	Things to watch out for when taking pictures	048	ACB
030	Using the camera buttons to set the camera	048	Drive mode
030	POWER button	049	Voice Memo
030	SHUTTER button	049	Voice Recording
030	ZOOM button	050	Recording the movie clip without voice
032	Info (DISP) / Up button		
032	Macro / Down button		
034	Focus lock	SETUP	051 Sound
034	Flash / Left button	051	Volume
036	Self-timer / Right button	051	Start up sound
038	MENU button	051	Shutter sound
038	OK button	051	Beep sound
038	Shooting	052	AF sound
039	How to enable functions using the MENU button	052 Display	
039	Photo Size / Movie Size	052	Language
040	Quality / Frame rate	052	Function Description
040	Exposure compensation	053	Start up image
041	ISO	053	Display Brightness
041	White balance	053	Quick View
042	Face Detection	053	Display Save
044	Face Tone	054 Settings	
044	Face Retouch	054	Formatting the memory
		054	Initialization
		055	Setting up the Date / Time / Date type

Contents

055	Time Zone	068	Edit
055	File name	068	Resize
056	Imprinting the recording date	069	Rotating an image
056	Auto power off	069	Photo Style Selector
057	Auto Focus lamp	070	Image Adjust
057	Selecting Video out type	072 Starting the Multi Slide Show	
058	Setting the USB	072	Start the Multi Slide Show
		072	Selecting Images
		073	Configure Multi Slide show effects
		073	Setting play interval
		073	Setting Background Music
PLAY	059 Starting play mode	074 File Options	
	059 Playing back a still image	074	Deleting images
	059 Playing back a movie clip	074	Protecting images
	060 Movie clip capture function	075	Voice memo
	060 Playing back a recorded voice	076	DPOF
	060 Playing back a voice memo	078	Copy to Card
	061 LCD monitor Indicator	079 PictBridge	
	062 Using the camera buttons to set the camera	080 PictBridge : Picture Selection	
	062 Thumbnail / Enlargement button	080 PictBridge : Print Setting	
	062 Smart Album	081 PictBridge : Reset	
	064 Info (DISP) / Up button	081 Important notes	
	064 Play & Pause / OK button	083 Warning indicator	
	065 Left / Right / Down / MENU button	084 Before contacting a service center	
	065 Delete button	086 Specifications	
	066 Setting up the play back function using the LCD monitor		

Contents

SOFTWARE	089	Transferring files to your computer (for Windows)
	089	For Windows users
	093	Transferring files to your computer (for Mac)
	093	For Mac users
	095	FAQ

System chart

Please check that you have the correct contents before using this product. The contents can vary depending on the sales region. To buy the equipment contact your nearest Samsung dealer or Samsung service center. Parts and accessories illustrated below may differ from exact appearance.

Package Contents



Camera



Rechargeable battery
(AD43-00194A)



AC adapter (AD44-00143A) /
USB cable (AD39-00165A)



Camera strap
(Black : AD63-02604A/
Silver : AD63-02596A)



Software CD
(User manual included)
(AD46-00333A)



Quick Start Manual
(AD68-04873A)



Anti-scratch Mask
(AD63-05007A)

Sold Separately



SD/SDHC memory card
(see p.17)



Camera case



AV cable
(AD39-00146A)



Battery charger
(AD44-00164A)

Identification of features

Front & Top

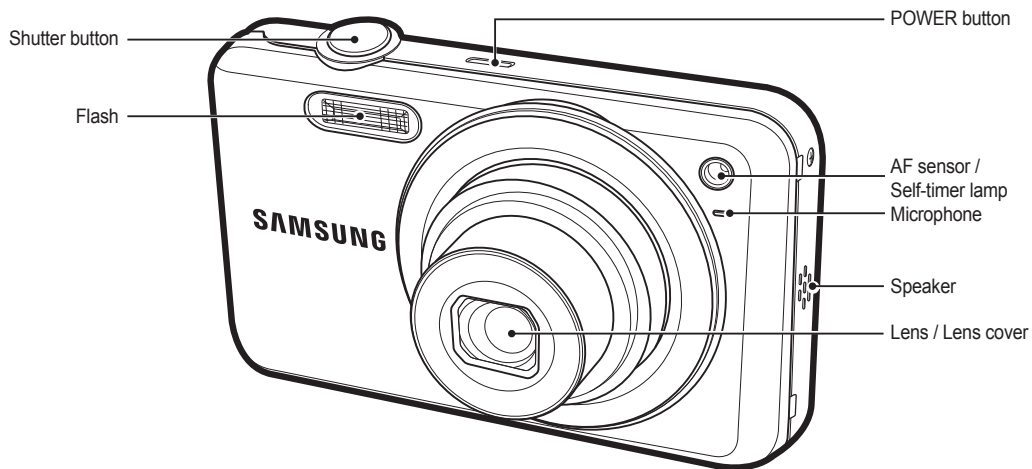

Identification of features

Back

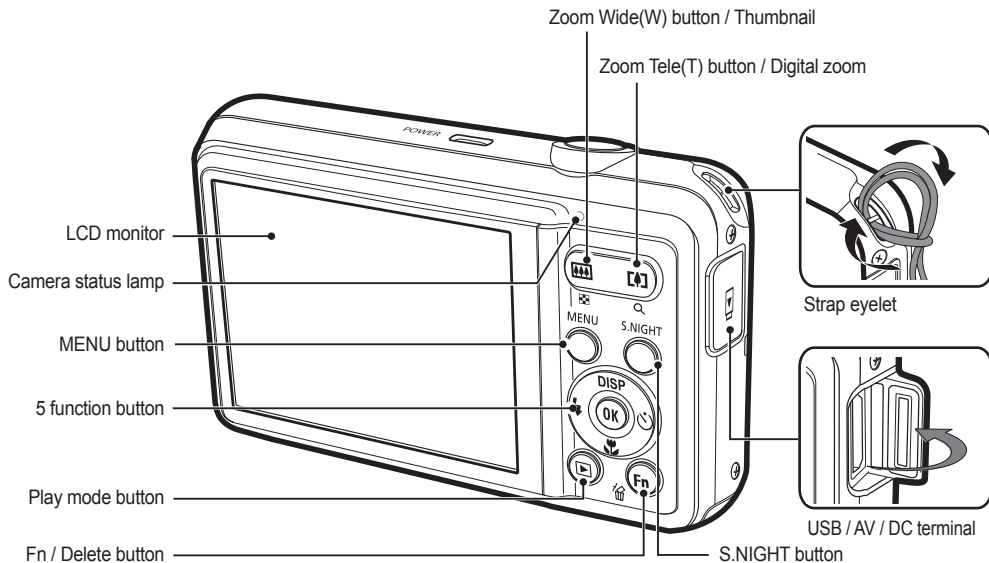

Identification of features

Bottom

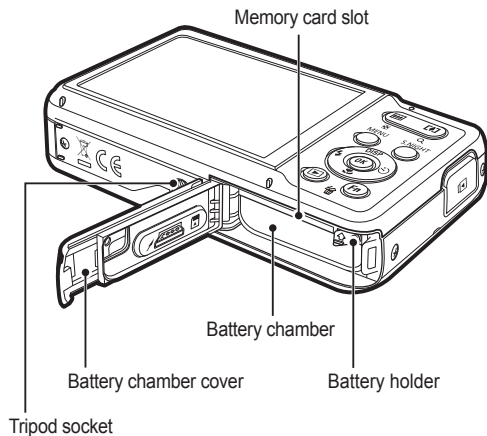



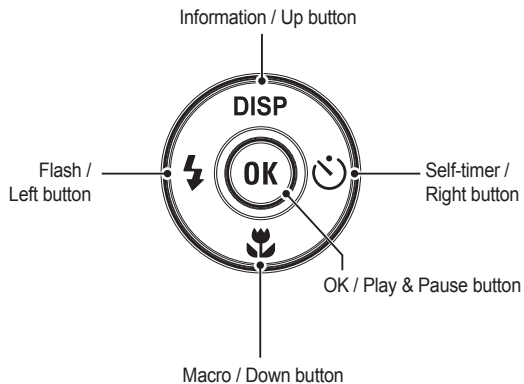

5 Function button



Identification of features

Self-timer lamp







Icon	Status	Description
	Blinking	- For the first 8 seconds, the lamp blinks at 1 second intervals. - For the final 2 seconds, the lamp blinks quickly at 0.25 seconds intervals.
	Blinking	For the 2 seconds, the lamp blinks quickly at 0.25 seconds intervals.
	Blinking	A picture will be taken after about 10 seconds and 2 seconds later a second picture will be taken.
	Blinking	After pressing the Shutter button, the image is taken in accordance with the subject's movement.













Camera Status Lamp

Status	Description
Power on	The lamp turns on and off when the camera is ready to take a picture
After taking a picture	The lamp blinks while saving the image data and turns off when the camera is ready to take a picture
When flash battery is charging	The lamp blinks
When the USB cable is inserted to a PC	The lamp lights up (LCD monitor turns off after initializing the device)
Transmitting Data with a PC	The lamp blinks (LCD monitor turns off)
When the USB cable is inserted into a printer	The lamp is off
When the printer is printing	The lamp blinks
When the AF activates	The lamp turns on (The camera focus on the subject)
	The lamp blinks (The camera doesn't focus on the subject)

Mode icon

Refer to p.21 for more information about the camera mode setting.

MODE	Smart Auto	Program	DIS	Photo Help Guide
ICON				
MODE	Scene	Movie	Smart Night	
ICON				

MODE	SCENE			
	Beauty Shot	Frame Guide	Night	Portrait
ICON				
MODE	Children	Landscape	Close up	Text
ICON				
MODE	Sunset	Dawn	Backlight	Fireworks
ICON				
MODE	Beach&Snow			
ICON				

Connecting to a Power Source

You should use the rechargeable battery BP70A supplied with the camera. Be sure to charge the battery before using the camera.

■ BP70A rechargeable battery Specification

Model	BP70A
Type	Lithium Ion
Capacity	740mAh
Voltage	3.7V
Charging time	Approximately 150 Minutes

■ Number of images and battery life: Using the BP70A

	Battery life / Number of images	Conditions
Still image	Approx. 125 MIN / Approx. 250 shots	Using the fully charged battery, Default settings, Program mode, Shot to shot interval: 30Sec. Changing the zoom position between the Wide and the Tele after every shot. Using the flash on every second shot. Using the camera for 5 minutes and then powering it off for 1 minute.
Movie	Approx. 110 MIN	Using the fully charged battery 640x480 image size 30fps frame rate

※ These figures are measured under Samsung's standard conditions and shooting conditions and may vary depending on the user's methods.



Important information about battery usage.

- When camera is not in use, turn off the power.
- Please remove the battery if the camera will not be used for long periods. Batteries can lose power over time and are prone to leaking if kept inside the camera.
- Low temperatures (below 0°C) can affect the performance of the battery and you may experience reduced battery life.
- Batteries will usually recover at normal temperatures.
- During extended use of the camera, the camera body may become warm. This is perfectly normal.

- Connecting the AC adapter with the USB cable can be used as an AC cable, and you can charge the rechargeable battery with the AC cable.

- Using an AC cable
: Connect the AC adapter to the USB cable. It can be used as a power cable.

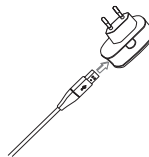

- Using a USB cable
: Remove the AC adapter.
You can download stored images to your PC (p.90) or supply the power to your camera through the USB cable.

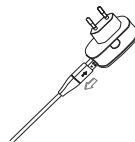

Connecting to a Power Source



Important information about USB cable usage.

- Use a USB cable with the correct specification.
- If the camera is connected to the PC through a USB hub : connect the camera directly to the PC.
- If the camera and other devices are connected to the PC at the same time : remove other device.
- Camera can not be detected using the front side USB port of computer. In this case, use the back side USB port of computer.
- If the USB port of the PC doesn't meet the power output standard (5V, 500mA), the battery may not be charged.

■ How to charge the rechargeable battery

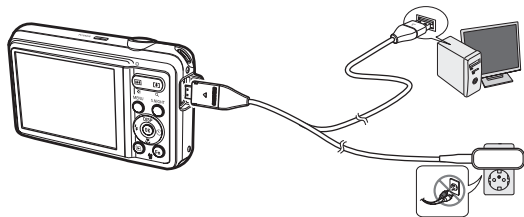

- Before inserting any cables or AC adapter, check the directions and do not insert by force. It may cause breakage of cable or camera.
- If the charging LED of the AC Charger does not turn on or blink after inserting the rechargeable battery, please check whether the battery is inserted correctly.
- If you charge the battery with the camera power on, the battery won't be fully charged. Turn the camera off while charging the battery.

■ Charging LED of the AC charger

	Charging LED
Being Charged	Red LED is on
Charging is complete	Green LED is on
Charging error	Orange LED is off or blinking

- If you insert the fully discharged battery to charge it, do not turn on the camera at the same time. The camera may not be turned on because of the low battery capacity. Charge the battery for more than 10 minutes before using the camera.
- Do not use the flash frequently or take a movie clip with the fully discharged battery charged for a short time. Even if the charger is inserted, the camera power may be turned off because the rechargeable battery is discharged again.

Connecting to a Power Source



When using the battery, please keep the following guidelines. Failure to do so may cause the generation of heat, fire or explosion

- If you find the battery shape distorted in size, try to contact a service center. It may present physical dangers.
- Use only the recommended battery charger.
- Do not place the product close to the fire device.
- Do not insert the product into the microwave oven.
- Do not place the product inside a car during the summer.
- Do not place the product in a space with hot temperature and high humidity range.
- Do not use the product for long time on the carpet, comforter or electronic mattress.
- Do not leave the product turned on where the air cannot be circulated.
- Be careful about the battery slot not to be connected with accessories like necklace, coin, key, watch and so on.
- Use only authentic, manufacturer-recommended, Lithium-ion replacement batteries.
- Do not try to disassemble or perforate the product by using a sharp pin.
- Do not apply pressure to the product.
- Do not let the product fall down from the height, or do not give a shock to the product.
- Do not exposure the product to the high temperature over 60°C (140°F) degree.
- Do not exposure the product to the water or humidity.
- Battery shall not be exposed to excessive heat such as sunshine, fire or the like.



Guidelines of disposal

- Do not throw away the over used battery.
- Destruction by fire is not allowed for disposal of battery.
- The disposal instruction may differ depending on the nation or the specific region. Please follow the given method of disposal.

Guideline of recharging the battery

- Do not recharge the battery by using the different method other than the user manual indicates. Failure to follow the correct procedure may result in fire or explosion.

Connecting to a power source

■ Insert the battery as shown

- If the camera does not turn on after you have inserted battery, please check whether the battery (+ / -) direction is right.
- When the battery chamber cover is open do not force the battery chamber cover, this may damage it.

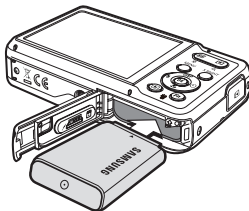

■ There are 4 indicators for battery condition that are displayed on the LCD monitor.

Battery indicator				
Battery status	The battery is fully charged	Low battery capacity (Prepare to recharge or use spare battery)	Low battery capacity (Prepare to recharge or use spare battery)	Battery empty (Recharge or use spare battery)

※ When using the camera and the battery in a place that is excessively cold or hot, the battery status on the LCD may be different from the actual battery status.

Inserting the memory card

■ Insert the memory card as shown.

- Turn off the camera's power before inserting the memory card.
- Have the front label of the memory card facing toward the front of the camera (Lens) and the card pins toward the back of the camera (LCD monitor).
- Do not insert the memory card the wrong way around. Doing so may damage the memory card slot.

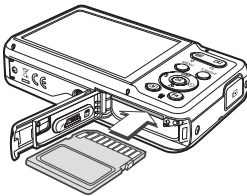

Using the Anti-scratch Mask

■ Insert the anti-scratch mask as shown.

- Using the anti-scratch mask can protect the camera from accidental scratches. Make sure three points of holes in the camera body are connected to the anti-scratch mask.

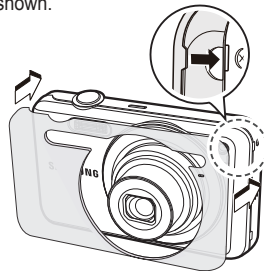

Instructions on how to use the memory card

- Be sure to format the memory card (see p.54) if you are using a newly purchased memory card for the first time, if it contains data that the camera cannot recognize, or if it contains images captured with a different camera.
- Turn off the camera power whenever the memory card is being inserted or removed.
- Repeated use of the memory card will eventually reduce the memory card's performance. Should this be the case, you will need to purchase a new memory card. Wear and tear on the memory card is not covered by the Samsung warranty.
- The memory card is an electronic precision device. Do not bend, drop or subject the memory card to any heavy impact.
- Do not store the memory card in an environment with strong electronic or magnetic fields, e.g. near loud speakers or TV receivers.
- Please do not use or store in an environment where there are extremes in temperature.
- Do not allow the memory card to become dirty or to come into contact with any liquid. Should this happen, clean the memory card with a soft cloth.
- Please keep the memory card in its case when not in use.
- During and after periods of extended use, you may notice that the memory card is warm. This is perfectly normal.
- Do not use a memory card that is used in another digital camera. To use the memory card in this camera, format the memory card before using this camera.
- Do not use a memory card formatted by another digital camera or memory card reader.
- If the memory card is subjected to any of the following, the recorded data may become corrupted :
 - When the memory card is used incorrectly.
 - If the power is switched off or the memory card is removed while recording, deleting (formatting) or reading.
- Samsung cannot be held responsible for lost data.
- It is advisable to copy important data onto other media as backup e.g. hard disks, CD etc.
- If there is insufficient memory available :
A [Memory Full] message will appear and the camera will not operate. To optimize the amount of memory in the camera, replace the memory card or delete unnecessary images stored on the memory card.



- Don't remove the memory card when the camera status lamp is blinking as this may cause damage to data on the memory card.

Instructions on how to use the memory card

The camera can use SD/SDHC Memory Cards.

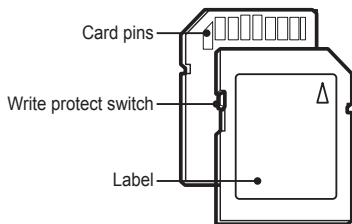

[SD (Secure Digital) memory card]

- The SD/SDHC memory card has a write protect switch that prevents image files from being deleted or formatted. By sliding the switch to the bottom of the SD/SDHC memory card, the data will be protected. By sliding the switch to the top of the SD/SDHC memory card, the data protection will be cancelled.
- Slide the switch to the top of the SD/SDHC memory card before taking a picture.

When using a 1GB SD memory, the specified shooting capacity will be as follows. These figures are approximate as image capacities can be affected by variables such as subject matter and memory card type.

Recorded image size	Super Fine	Fine	Normal	30 FPS	15 FPS	
Still image	12M	About 147	About 284	About 403	-	-
	10M	About 167	About 309	About 441	-	-
	9M	About 202	About 367	About 528	-	-
	8M	About 211	About 374	About 537	-	-
	5M	About 339	About 566	About 792	-	-
	3M	About 532	About 802	About 1065	-	-
	2M	About 870	About 1144	About 1437	-	-
	1M	About 1471	About 1670	About 1872		
Movie clip	640	-	-	-	About 9'54"	About 18'58"
	320	-	-	-	About 26'24"	About 49'23"



- The zoom button doesn't function during the movie recording.
- The recording times can be changed by the zoom operation.
- You can record videos of up to 4GB or 2hours each.

When using the camera for the first time

- Charge the rechargeable battery fully before using the camera for the first time.
- When the camera is turned on for the first time, a menu will be displayed on the LCD monitor to set date, time, time zone and language. This menu will not be displayed again after setting up the date, time, time zone and language. Set up the date, time, time zone and language before using this camera.

■ Setting up the language

1. Select the [Language] menu by pressing the Up/Down button and press the Right button.
2. Select the desired sub menu by pressing the Up/Down button and press the OK button.



■ Setting up the date, time and date type

1. Select the [Date&Time] menu by pressing the Up/Down button and press the Right button.
2. Select the desired sub menu by pressing the Up/Down/Left/Right button and press the OK button.

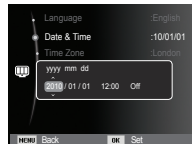

Left/Right button : Selects world time/year/month/day/hour/minute/date type.

Up/Down button : Changes the value of each item.

■ Setting up the Time Zone

1. Select the [Time Zone] menu by pressing the Up/Down button and press the Right button.
2. Press the Left/Right button to select the desired mode.

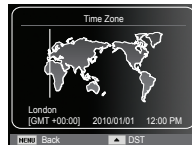

※ For more information about the World Time, refer to the p.55.

LCD monitor indicator

- The LCD monitor displays information about the shooting functions and selections.

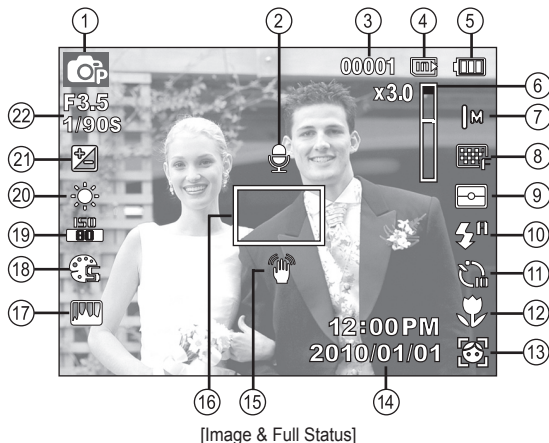

No.	Description	Icons	Page
1	Recording mode		p.21
2	Voice Memo		p.49
3	Number of available shots remaining	00001	p.17
	Remaining time	00:00:00	p.17
4	Memory card icon / Internal memory icon		-

No.	Description	Icons	Page
5	Battery		p.15
6	Optical / Digital Zoom bar / Digital Zoom rate	x3.0	p.30
7	Photo Size / Movie Size		p.39
8	Image Quality / Frame Rate		p.40
9	Metering		p.45
10	Flash		p.34
11	Self-timer / Drive mode		p.37/ 48
12	Macro		p.32
13	Face Detection · Self-Portrait · Smile Shot · Blink Detection		p.42
14	Date / Time	2010/01/01 12:00 PM	p.55
15	Camera shake warning		p.29
16	Auto Focus Frame		p.45
17	Image adjust		p.47
18	Photo Style Selector		p.46
19	ISO / Face Retouch / Without voice		p.41/44 50
20	White Balance / Face Tone		p.41/ 44
21	Exposure compensation		p.40
22	Aperture Value / Shutter Speed	F3.5 1/90S	-

How to use the menu

1. Turn on the camera and press the MENU button. A menu for each camera mode appears.

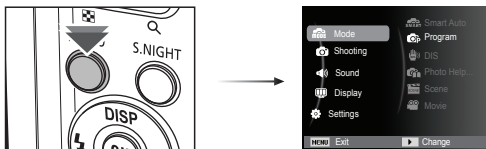

2. Use the up or down button to navigate through the menus.

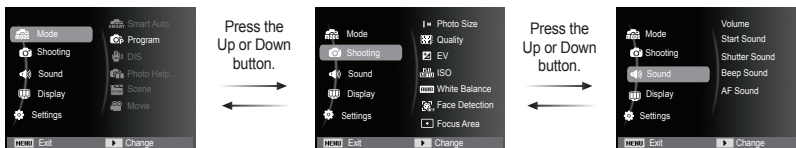

3. Use the left or right button to select a sub menu.

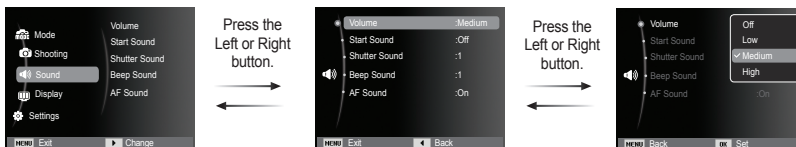

4. Select a submenu and click the OK button to save settings and return to the previous window.

Starting the recording mode

Selecting modes

You can select the shooting modes by using the MENU button on the back of your camera.

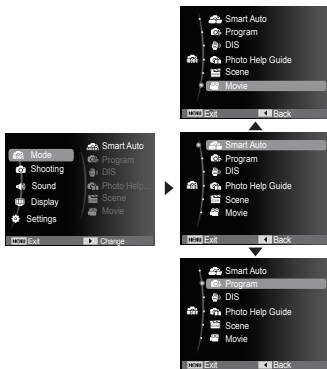
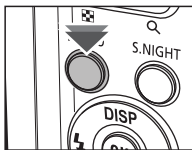

■ How to use the MENU button

1. Press the MENU button and a menu will be displayed.
2. Press the Up / Down button to select the [Mode] menu and press the Right button.
3. Select a desired mode by pressing the Up / Down button and then press the OK button.



How to use the Smart Auto mode()

The camera automatically chooses the appropriate camera settings based on a detected type of scene. It will be helpful if you are not familiar with the camera settings for various scenes.

















1. Insert the battery (p.15). Insert the battery taking note of the polarity (+ / -). 
2. Insert the memory card (p.15). As this camera has a 9.9MB internal memory, you do not need to insert the memory card. If the memory card is not inserted, an image will be stored on the internal memory. If the memory card is inserted, an image will be stored on the memory card. 
3. Close the battery chamber cover.
4. Press the POWER button to turn on the camera.
5. Select the Smart Auto mode by pressing the MENU button.
6. Point the camera towards the subject and compose the image by using the LCD monitor.
7. Press the Shutter button to capture an image.

Starting the recording mode



- If the camera does not recognize a proper scene mode, the default settings will be used.
- Even if there is a face detected, the camera may not select a portrait mode depending on the subject's position or lighting.
- The camera may not select the correct scene depending on shooting environments, such as camera shake, lighting and distance to the subject.
- The [Night] mode recognizes scenes only when the flash is set to off. The camera operates the [Tripod] mode after checking the shooting condition on the tripod for a certain time.
- Despite using a tripod, the camera may not select a tripod mode depending on the subject's movement.

- Each scene is recognized in the following conditions;

[Landscape]	()	: When shooting outdoor scenes
[White]	()	: When shooting a white background
[Night]	()	: When shooting the nighttime scenes
[Night Portrait]	()	: When shooting people in a dark outdoor place
[Backlight]	()	: When shooting a backlit scenery without a portrait
[Backlight Portrait]	()	: When shooting a backlit portrait
[Portrait]	()	: When shooting a portrait
[Macro]	()	: When shooting close-ups
[Macro Text]	()	: When shooting texts in a close focus
[Tripod]	()	: When shooting a subject that doesn't move for a certain time after the camera is mounted on the tripod (available only when the camera recognizes it as nighttime)
[Action]	()	: When shooting a subject making frequent movements
[Macro Portrait]	()	: When shooting close-up portrait shot
[Blue Sky]	()	: When shooting blue sky
[Sunset Sky]	()	: When shooting sunset
[Macro Color]	()	: When shooting close-up shot for the subject with various colors
[Natural Green]	()	: When shooting nature such as forest and leaves

Starting the recording mode

How to use the Program mode ()

Selecting the automatic mode will configure the camera with optimal settings. You can still manually configure all functions except the aperture value and shutter speed.

1. Select the Program mode by using the MENU button. (p.21)
2. Press the MENU button to configure advanced functions.



How to use the DIS mode ()



Digital Image Stabilization (DIS) mode.

This mode will reduce the effect of camera shake and help you get a well exposed image in dim conditions.

1. Select the DIS mode by using the MENU button. (p.21)
2. Point the camera towards the subject and compose the image by using the LCD monitor.
3. Press the Shutter button to capture an image.



■ Things to watch out for using the DIS mode

1. The digital zoom will not operate in the DIS mode.
2. If the lighting condition is brighter than fluorescent lighting conditions, the DIS will not activate.
3. If the lighting condition is darker than fluorescent lighting conditions, camera shake warning indicator () will display. For best results only take pictures in situations where the camera shake warning indicator () is not displayed.
4. If the subject is moving, the captured image may be blurred.
5. As the DIS uses the camera's digital signal processor, it may take a little longer for the camera to process and save the images.

Starting the recording mode

Using the Photo Help Guide mode ()

Helps the user learn the correct picture taking method and includes solutions for potential problems that may occur. This also enables the user to practice the best way to take the pictures.



Available functions of the photo help guide

- Functions that can be used when focusing is difficult
- Functions that can be used when the image is blurred
- Functions that can be used when filming in the dark
- Functions that can be used when adjusting the picture brightness
- Functions that can be used when adjusting the picture color

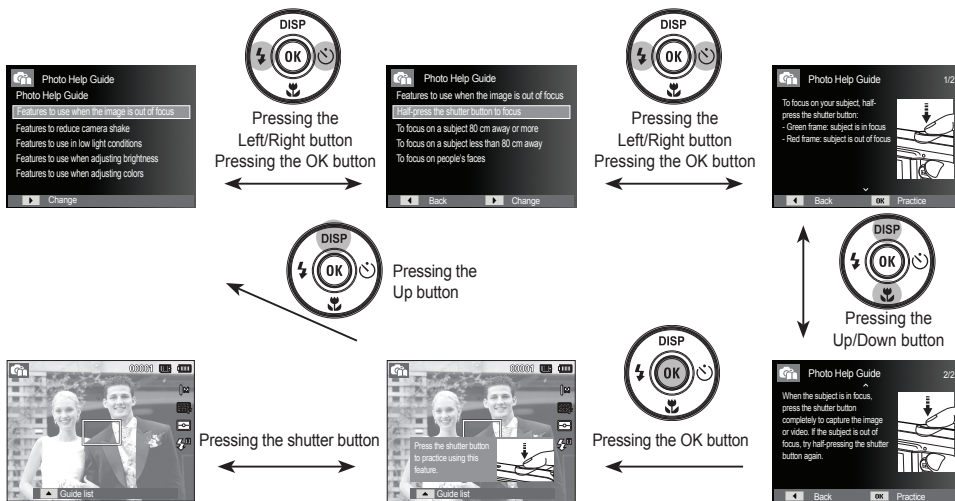

[Function that can be used when focusing is difficult]

Starting the recording mode







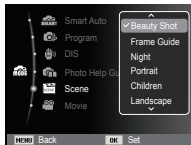





How to use the Scene modes ()

Use the menu to easily configure optimal settings for a variety of shooting situations.

1. Select the Scene mode by using the MENU button. (p.21)
2. Press the Right button, then press the Up/Down button to select the desired mode.
3. Point the camera towards the subject and compose the image by using the LCD monitor.
4. Press the shutter button to capture an image.



 The scene modes are listed below.

- [Beauty Shot] () : Take a photo of portraits by setting options to clear facial imperfections.
- [Frame Guide] () : Use this mode when you want someone else to take a picture for you from the angle you choose.
- [Night] () : Use this for shooting still images at night or in other dark conditions.
- [Portrait] () : To take a picture of a person.
- [Children] () : To take a picture of fast moving objects, for example: children.
- [Landscape] () : To take pictures of distant scenery.
- [Close Up] () : Close-up shooting for small objects such as plants and insects.
- [Text] () : Use this mode to shoot a document.
- [Sunset] () : For taking pictures of sunsets.
- [Dawn] () : Daybreak scenes.
- [Backlight] () : Portrait without shadows caused by backlight.
- [Fireworks] () : Firework scenes.
- [Beach&Snow] () : For ocean, lake, beach and snowscape scenes.

Starting the recording mode

■ How to use the [Frame Guide] mode

Set [Frame Guide] mode when you want someone else to take a picture for you from the angle you choose.

1. Take a picture from the angle you choose.
- A guide appears around the sides of the picture.
2. Then another person can take the picture by aligning the edge of the picture to be taken with the guide framing the sides of the window.

Guide

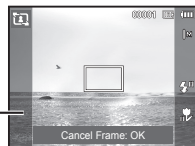

How to use the Movie mode ()

A movie clip can be recorded for as long as the available recording time of the memory capacity allows. (Max.2 hours)

1. Select the Movie mode by using the MENU button. (p.21)
2. Point the camera towards the subject and compose the image by using the LCD monitor.
3. Press the shutter button once and movie clips are recorded for as long as the available recording time (Max.2 hours) allows. Movie clips will still be recorded if the shutter button is released. If you wish to stop recording, press the shutter button again.



※ Movie clip size and type are listed below.

- Movie clip size : 640x480, 320x240 (selectable)
- Movie clip file type : AVI (MJPEG)
- Frame Rate : 30 FPS, 15 FPS (selectable)

Starting the recording mode

Recording the movie clip without sound

You can record the movie clip without sound.

Steps from 1-3 are the same as those for Movie mode.

4. Press the MENU button.
5. Press the Up / Down button to select the [Movie] menu and press the Right button.
6. Select the [Voice] menu by pressing the Up / Down button and press the OK button.
7. Select the [Off] menu by pressing the Left / Right button.
8. Press the OK button. You can record a movie without sound.

※ See p.50 for further details.



Pausing while recording a movie clip (Successive Recording)

This camera allows you to temporarily stop during unwanted scenes while recording a movie clip. Using this function, you can record your favorite scenes into a movie clip without having to create multiple movie clips.

■ Using Successive Recording

Steps from 1-2 are the same as those for Movie mode.

3. Press the shutter button and movie clips are recorded for as long as the available recording time. (Max.2 hours)
Movie clips will still be recorded if the shutter button is released.
4. Press the OK button to pause recording.
5. Press the OK button again to resume the recording.
6. If you wish to stop recording, press the shutter button again.



Starting the recording mode

How to use the Smart Night Mode (🌙)

This mode will help you take photos easily in the night scenes.

1. Press the S.NIGHT button.
2. Press the Flash button, then press the Left/Right button to select a desired flash mode. By using the Up / Down button, you can set the intensity of the flash.
3. Point the camera towards the subject and compose the image by using the LCD monitor.
4. Press the shutter button to capture an image.



- This function is the same as Night mode and Night Portrait mode in Smart Auto mode.
- By pressing the S.NIGHT button, you can set on/off the Smart Night Mode at any mode.
- When the Smart Night Mode is turned off, the camera will be back to the previous mode.

Things to watch out for when taking pictures

- Pressing the shutter button down half way.
Lightly press the shutter button to confirm focus and flash battery charge. Press the shutter button all way down to take the picture.

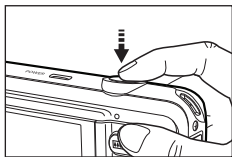

[Lightly press the shutter button]

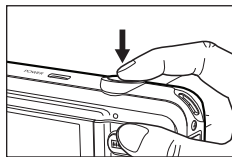

[Press the shutter button]

- The available memory capacity may vary depending on shooting conditions and camera settings.
- When the Flash Off, Slow synchro mode or DIS mode is selected in a low lighting condition, the camera shake warning indicator () may appear on the LCD monitor. In this case use a tripod to support the camera on a solid surface or change to flash shot mode.
- Shooting against the light : It is best to take pictures with the sun behind you. Taking pictures against the sun may make the picture come out dark. To take a picture against the light, please use the [Backlight] in scene shooting mode (p.25), fill-in flash (p.34), spot metering (p.45), exposure compensation (p.40) or ACB (p.48) function.
- Avoid obstructing the lens or the flash when you capture an image.
- Compose the image by using the LCD monitor.
- Under certain conditions the auto focus system may not perform as expected.
 - When photographing a subject that has little contrast.
 - If the subject is highly reflective or shiny.
 - If the subject is moving at high speed.
 - When there is strong reflected light, or when the background is very bright.
 - When the subject matter has only horizontal lines or the subject is very narrow (such as a stick or flagpole).
 - When the surroundings are dark.

Using the camera buttons to set the camera

The recording mode function can be set up by using the camera buttons.

POWER button

Used for turning the camera's power on / off. If there is no operation during the specified time, the camera's power will be turned off automatically to save battery life. Refer to p.56 for more information about the auto power off function.

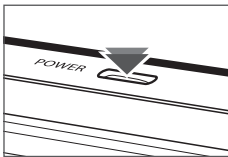

SHUTTER button

Used for taking an image or recording a movie clip in the Recording mode.

• In Movie mode

Pressing the shutter button down fully starts the process for recording a movie clip. Press the shutter button once and the movie clip is recorded for as long as the available recording time on the memory allows. If you wish to stop recording, press the shutter button again.

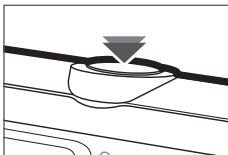

• In Still image mode

Pressing the shutter button down halfway activates the autofocus and checks the condition of the flash. Pressing the shutter button down fully takes and stores the image. If you select voice memo recording, the recording will start after the camera has finished storing the image data.

ZOOM button

If the menu is not displayed, this button works as the OPTICAL ZOOM or DIGITAL ZOOM button.

This camera has a 5X optical zoom and a 3X digital zoom function. Using both will offer a total zoom ratio of 15X.

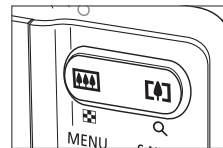

■ TELE Zoom

Optical zoom TELE : Pressing the ZOOM T button. This will zoom into the subject i.e. the subject will appear nearer.

Digital zoom TELE : When the maximum (5X) optical zoom is selected, pressing the ZOOM T button activates the digital zoom software. Releasing ZOOM T button stops the digital zooming at the required setting. Once the maximum digital zoom (3X) is achieved, pressing the ZOOM T button will have no effect.

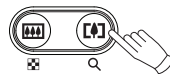

ZOOM button

■ WIDE Zoom

Optical zoom WIDE

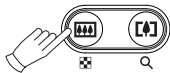

: Pressing the ZOOM W button. This will zoom out from the subject i.e. the subject will appear further away. Pressing the ZOOM W button continuously will set the camera to its minimum zoom setting i.e. the subject appears at its furthest from the camera.

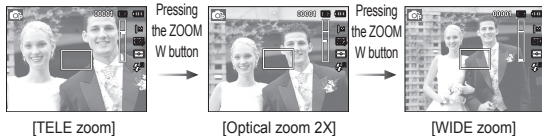

Digital zoom WIDE

: When the digital zoom is in operation, pressing the ZOOM W button will reduce the digital zooming in steps. Releasing ZOOM W button stops digital zooming. Pressing the ZOOM W button will reduce the digital zoom and then it will continue to reduce the optical zoom until the minimum setting is reached.

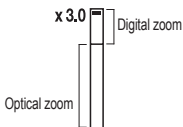

- Images taken using the digital zoom may take a little longer for the camera to process. Allow time for this to take place.
- If the ZOOM buttons are being pressed during the Movie shots, the voice will not be recorded.
- You may notice a decrease in image quality when using the digital zoom.
- To view a clearer digital zoom image, press the shutter button halfway at the maximum optical zoom position and press the ZOOM T button again.
- The digital zoom can't be activated in some Scene modes ([Beauty Shot], [Night], [Portrait], [Children], [Close up], [Text], [Fireworks]), DIS mode, Movie mode, Smart Night Mode, [Self-Portrait], [Smile Shot], [Blink Detection] and [Face Detection].
- Take care not to touch the lens to avoid taking an unclear image and possibly causing camera malfunction. If the image is dim, turn the camera power off and on again to modify the lens position.
- Take care not to press the lens as this may cause the camera to malfunction.
- When the camera is turned on, take care not to touch the camera's moving lens parts as this may cause the resulting image to be dim and unclear.
- Take care not to touch the lens when operating the zoom button.

Info (DISP) / Up button

While the menu is showing, the Up button operates as a direction button. In the recording modes or playback mode, pressing this button will display the image information.

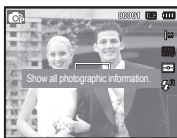

[Filming screen]



[Information screen]

Macro (🌸) / Down button

While the menu is showing, the Down button operates as a direction button.

When the menu is not showing, you can use the Macro (🌸) / Down button to take macro pictures.

The focus ranges are shown on the next page.

Press the Macro button until the desired macro mode indicator appears on the LCD monitor.



[Auto Focus]



[Macro (🌸)]



[Auto Macro (M🌸)]

Macro (🌸) / Down button

- Types of focus mode and focus range (W : Wide, T : Tele)

(Unit: cm)

Mode	Program (📷)	
Focus Type	Macro (🌸)	Normal
Focus range	W : 5 ~ 80 T : 100 ~ 150	W : 80 ~ Infinity T : 100 ~ Infinity

Mode	DIS Mode (👉)	
Focus Type	Auto macro (📷)	Normal
Focus range	W : 5 ~ Infinity T : 100 ~ Infinity	W : 80 ~ Infinity T : 100 ~ Infinity



- When the macro mode is selected, be particularly careful to avoid camera shake.
- When you take a picture within 40cm (Wide zoom) or 100cm (Tele zoom) in the Macro mode, select the Flash off mode.

- Available focusing method, by recording mode

(o : Selectable, ∞ : Infinity focus range)

Mode	Auto macro	Macro	Normal
		o	o
	o		o
		o	o
		o	o
Mode	SCENE		
	Auto macro	Macro	Normal
	o		
	o		
			o
			o
			o
			o
		o	
T	o		
			o
			o
			o
			∞
			o

Focus lock

To focus on a subject not positioned in the center of the picture, use the focus lock function.

■ Using the Focus Lock

1. Ensure the subject is in the center of the autofocus frame.
2. Press the shutter button halfway. When the green auto focus frame lights up, it means the camera is focused on the subject. Be careful not to press the shutter button all the way down to avoid taking an unwanted picture.
3. With the shutter button still pressed down only halfway, move the camera to recompose your picture as desired, and then press the shutter button completely to take the picture. If you release your finger from the shutter button, the focus lock function will be cancelled.



1. The image to be captured.



2. Press the shutter button halfway and focus on the subject.



3. Recompose the picture and fully depress the shutter button.

Flash () / Left button

When the menu is displayed on the LCD monitor, pressing the Left button makes the cursor shift to the left tab.

When the menu is not displayed on the LCD monitor, the Left button operates as the Flash () button.



[Selecting the Auto flash]

■ Selecting the flash mode

1. Select a desired Recording mode, except the [Movie] mode and the [DIS] mode. (p.21)
2. Press the Flash button until the desired flash mode indicator is displayed on the LCD monitor.
3. A flash mode indicator will be displayed on the LCD monitor. Use the correct flash to suit the environment.

■ Flash range

(Unit: m)









ISO	Normal		Macro		Auto macro	
	WIDE	TELE	WIDE	TELE	WIDE	TELE
AUTO	0.8~2.68	0.8~1.59	0.2~0.8	0.5~0.8	0.2~2.68	0.5~1.59

Flash () / Left button































- If you press the shutter button after selecting the flash, the first flash fires to check the shooting condition (Flash range and Power ratio of flash). Do not move the camera until the second flash fires.
- Using the flash frequently will reduce the life of the battery.
- Under normal operating conditions the recharging time for the flash is usually within 4 seconds. If the battery is weak, the charging time will be longer.
- In the DIS mode, [Landscape], [Close up], [Text], [Sunset], [Dawn], [Fireworks] scene modes and the Movie mode, the flash function will not operate.
- Take photographs within the flash range.
- The image quality is not guaranteed if the subject is too close or highly reflective.
- When taking an image in poorly lit conditions with the flash, there may be a white speck in the captured image. The speck is caused by the flash light reflecting off atmospheric dust.





■ Flash mode indicator

Icon	Flash mode	Description
	Flash off	The flash does not fire. Select this mode when capturing images in a place or situation where flash photography is prohibited. When you capture an image in poorly lit conditions, the camera shake warning indicator () will appear on the LCD monitor.
	Red-eye reduction	When a shot with "red eye" is detected, this mode will reduce the red-eye effect automatically.
	Slow synchro	The flash operates with a slow shutter speed to obtain a balanced correct exposure. In poor lighting conditions the camera shake warning indicator () will display on the LCD monitor.
	Fill in flash	The flash fires regardless of the available light. The intensity of the flash will be automatically controlled to suit the prevailing conditions.
	Auto & Red eye reduction	If a subject or background is dark, the camera flash will work automatically and will reduce the red-eye effect by using the red-eye reduction function.
	Auto flash	If the subject or background is dark, the camera flash will operate automatically.

Flash () / Left button

■ Available flash mode, by recording mode (o : Selectable)

Mode						
	o	o	o	o	o	o
						o
	o	o	o	o	o	o
						o
Mode	SCENE					
						
		o			o	o
	o				o	o
				o	o	o
		o			o	o
		o				o
						o
						o
						o
						o
						o
			o			
						o
	o					

-  • Smart Auto Flash () icon will appear in [Smart Auto] mode.
-  • Smart Night Flash () icon will appear in [Smart Night] mode.

Self-timer () / Right button

When the menu is displayed on the LCD monitor, pressing the Right button makes the cursor shift to the right tab.

When the menu is not displayed on the LCD monitor, the Right button operates as the Self-timer () button. This function is used when the photographer would also like to be in the image.



- If you operate the self-timer button during the self-timer operation, the self-timer function is cancelled.
- Use a tripod to prevent the camera from shaking.
- In Movie mode, only the 10 Sec self-timer will work.
- Depending on the selected face detection option, the timer is not available or some timer options are not available.

Self-timer () / Right button

■ Selecting the self-timer

1. Select a Recording mode with the exception of Voice recording mode.(p.21)
2. Press the Self-timer / Right () button until the desired mode indicator displays on the LCD monitor. A 10 second, 2 second, Double self-timer or Motion timer icon appears on the LCD monitor.
3. When you press the shutter button, the picture will be taken after the specified time has elapsed.

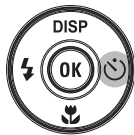

[Selecting the 10 SEC self-timer]

■ Self-timer mode indicator

Icon	Mode	Description
	10 Sec self-timer	Pressing the shutter button will allow an interval of 10 seconds before the image is taken.
	2 Sec self-timer	Pressing the shutter button will allow an interval of 2 seconds before the image is taken.
	Double self-timer	A picture will be taken after about 10 seconds and 2 seconds later a second picture will be taken. When using the flash, the 2-second self-timer may be delayed for longer than 2 seconds depending on the flash charging time.
	Motion Timer	The camera detects the subject's movement 6 seconds after pressing the Shutter button, and the picture is taken when the movement is stopped.

■ Motion Timer

Motion	Icon & Self-timer lamp
Pressing the Shutter button after setting the Motion Timer	Blink (1 second interval)
Detecting the subject's movement	Blink (0.25 second interval)
No movement is detected	Turn on and the image is taken after 2 seconds

■ The Motion Timer flows are as followings. (Movie mode excluded)

Selecting the Motion Timer → Pressing the Shutter button → Confirming the composition (Within 6 sec.)^{*1} → Starting the detection (Swing your hands fully)^{*2} → Stopping the detection (Do not move) → Taking an image (after 2 sec.)

*1: The camera detects the subject's movement 6 seconds after pressing the Shutter button, so confirm the composition within 6 seconds.

*2: Move your body or hands fully.



In the following cases, the Motion Timer may not operate.

- The focus distance is over 3m.
- The exposure is too bright or too dark.
- In backlight conditions.
- The movement is insignificant.
- The movement is detected beyond the center part (50%) of the sensor where the movement is recognized.
- If the camera doesn't sense any movement for 30 seconds, or the camera doesn't sense stillness after sensing movement.

The detection range of Motion Timer



MENU button

- When you press the MENU button, a menu related to each camera mode will be displayed on the LCD monitor. Pressing it again will return the LCD to the initial display.
- A menu option can be displayed when the following are selected :
Movie and Still image mode. There is no menu available when the voice recording function is selected.

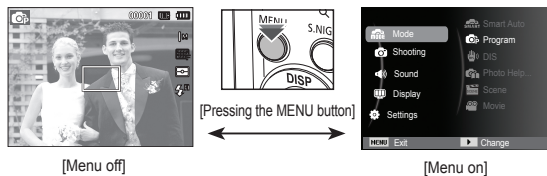

OK button

- When the menu is displayed on the LCD monitor, this button is used for shifting the cursor to the sub menu or for confirming data.



Shooting ()

Use the menu that enables the functions, or the Fn button to bring up the menus below:

Mode	Menu	Available mode	Page
	Photo Size / Movie Size		p.39
	Quality / Frame Rate		p.40
	EV		p.40
	ISO		p.41
	White Balance		p.41
	Face Detection		p.42
	Face Tone		p.44
	Face Retouch		p.44
 (Shooting)	Focus Area		p.45
	Metering		p.45
	Photo Style Selector		p.46
	Image Adjust		p.47
	ACB		p.48
	Drive		p.48
	Voice		p.49~50

Shooting (📷)

How to enable functions using the MENU button

1. Press the MENU button in an available mode.
2. Press the Up / Down button to select the [Shooting] menu and press the Right/OK button.



3. Select a desired menu by pressing the Up / Down button and then press the OK button.

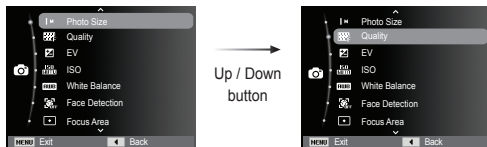

4. Select a desired menu by pressing the Left / Right button and then press the OK button.

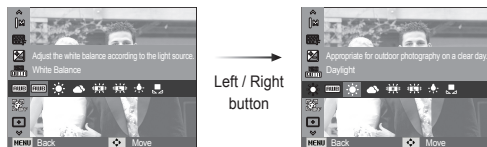

📄 Use the Fn button on the rear of the camera to bring up the menus that enable frequently used functions faster.

Photo Size / Movie Size

You can select the photo size / movie size appropriate for your application.

(Unit: pixel)

Still image mode	Icon	12M	10M	9M	8M	5M	3M	2M	1M
	Size	4000X3000	3984X2656	3840X2160	3264X2448	2560X1920	2048X1536	1920X1080	1024X768
Movie mode	Icon	640				320			
	Size	640 x 480				320 x 240			

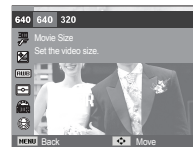





- The higher the resolution, the lower the number of shots available because high resolution images require more memory.

Shooting ()

Quality / Frame rate

You can select the compression ratio appropriate for your application of the captured images. The higher the compression ratio, the lower the picture quality.

Mode	STILL IMAGE mode			MOVIE mode	
Icon					
Sub menu	Super Fine	Fine	Normal	30 FPS	15 FPS
File Format	jpeg	jpeg	jpeg	avi	avi

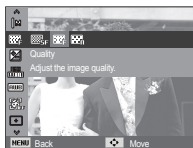

[Still image mode]

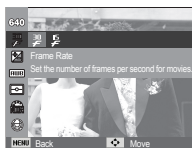

[Movie mode]





- This file format complies with the DCF (Design rule for Camera File system).
- JPEG (Joint Photographic Experts Group) :
JPEG is the image compression standard developed by the Joint Photographic Experts Group. This type of compression is most commonly used for compressing photos and graphics because it can compress the files efficiently.

Exposure compensation

This camera automatically adjusts the exposure according to the ambient lighting conditions.

You can also select the exposure value by using the [EV] menu.

■ Compensating Exposure

1. Click the Up/Down button from the Shooting menu to select [EV] ().
2. Use the Left and Right buttons to set the desired exposure compensation factor.
3. Press the OK button. The value you set will be saved and the Exposure Compensation setup mode will be closed. If you change the exposure value, the exposure indicator () will be displayed on the left of the LCD monitor.



- ※ A negative exposure compensation value reduces the exposure. Note that a positive exposure compensation value increases the exposure and the LCD monitor will appear white or you may not get good pictures.

Shooting ()

ISO

You can select the ISO sensitivity when taking pictures. The speed or specific light-sensitivity of a camera is rated by ISO numbers.

[Auto] : The camera's sensitivity is automatically changed by variables such as lighting value or subject brightness.

[ISO 80, 100, 200, 400, 800, 1600] :

You can increase the shutter speed while the same amount of light is present, by increasing the ISO sensitivity. However, the image may be saturated in high luminance.

The higher the ISO value, the higher the camera's sensitivity to light and therefore the greater its capacity to take pictures in dark conditions. However, the noise level in the image will increase as the ISO value increases, making the image appear coarse.

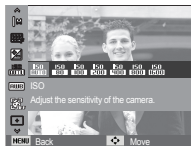





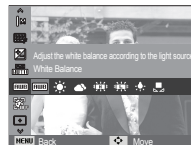

- ※ When [Motion Capture] is set, ISO speed will be set to Auto.
- ※ [ISO] is enabled only in [Program] or [Photo Help Guide] mode.

White balance

The white balance control allows you to adjust the colors to appear more natural.



Mode	Icon	Description
Auto WB		The camera automatically selects the appropriate white balance settings, depending on the prevailing lighting conditions.
Daylight		For taking images outside.
Cloudy		For taking images under a cloudy and overcast sky.
Fluorescent_H		For shooting under daylight fluorescent types of three-way fluorescent lighting.
Fluorescent_L		Shooting under white fluorescent lighting.
Tungsten		For shooting under tungsten (standard light bulb) lighting.
Custom Set		Allows the user to set the white balance according to the shooting condition.

- ※ Different lighting conditions may cause a color cast on your images.

Shooting ()

■ Using the Custom White Balance

White balance settings may vary slightly depending on the shooting environment. You can select the most appropriate white balance setting for a given shooting environment by setting up the custom white balance.

1. Select the Custom () menu of the White Balance and place a sheet of white paper in front of the camera so that the LCD monitor shows only white.

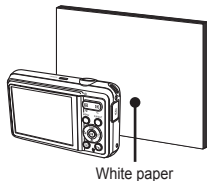

2. OK button : Selects previous custom white balance.

Shutter button : saves new custom white balance.

- The custom white balance value will be applied, starting with the next picture you take.
- The user configured white balance will remain effective until it is overwritten.

Face Detection

If you use face detection options, your camera can detect a human face. When focusing on a human face, the brightness of the face is also adjusted. You can also capture natural facial expressions by using self portrait.

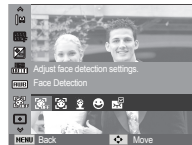

■ Normal

This mode detects the face position of the subject automatically and then sets the focus and exposure. Select this mode for quick and easy face picture.

※ Selectable modes: Program, DIS, Photo Help Guide, Beauty Shot, Portrait, Children, Beach & Snow

1. The size and position of the auto focus frame is set at the face of the subject automatically.



2. Press the shutter button halfway.
The focus frame turns to green when the focus is activated.



3. Press the shutter button fully to take a picture.

Shooting ()



- This function can detect up to 10 persons.
- When the camera recognizes many people at the same time, it will focus on the nearest person.
- The Digital zoom is not activated in this mode.
- When the camera detects a target face, the white color focus frame will be displayed over the target face and the grey color focus frame appears over the remaining faces.
Press the shutter button halfway down to focus on the face and the white focus frame turns green.
- Return to previous AF mode if face detection was failure.
- In some conditions this function cannot work properly.
 - When a person wears dark glasses or some part of the face is hidden.
 - When the person being taken does not look at the camera.
 - Camera doesn't detect a face as the brightness is too dark or too bright.
 - The distance between the camera and object is far.
- The maximum available Face Detection range is 2.5m (Wide).
- The nearer the subject, the faster the camera can recognize the subject.
- In [Beauty Shot], [Portrait], and [Children] mode, the [Face Detection] function setting is set to its default value.

■ Self Portrait

When taking pictures of yourself, the area of your face is automatically detected so that you can take self pictures more easily and quickly.

※ Selectable modes: Program, DIS, Photo Help Guide, Beauty Shot, Portrait, Beach & Snow

1. For self-filming, set the camera lens towards the face of the object. It automatically detects the face of the object, and emits a guiding sound.
2. Start filming by pressing the shutter button.

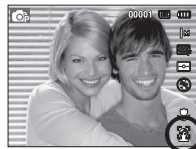

- When locating the face in the center of the screen, it repeatedly emits a faster sound unlike the sounds that are emitted when the face is not in the center.

Shooting ()

■ Smile Shot

※ Selectable modes: Program, DIS, Photo Help Guide, Beauty shot, Portrait, Children, Beach & Snow

The camera automatically takes a picture by detecting the face of the subject although you don't press the Shutter button.

If you press the Shutter button, the picture is taken in the normal way. When taking a picture of smile shot, showing teeth or keeping the smiley face of your subject helps detecting the smile face of the subject.



■ Blink Detection

※ Selectable modes: Program, Photo Help Guide, Portrait, Children, Beach & Snow

If the eyes of the subject are closed when the shutter button is pressed, the camera takes 2 continuous shots and then the images are saved. The camera takes only one picture if the eyes of the subject are open when the Shutter button is pressed.



- Detecting the smiling face or the blinking eyes may not be available if any of the following situations occurs:
 - If the subject is wearing sunglasses.
 - When the subject is not facing directly to the camera.
 - If the environmental light is too bright or too dark to detect the face of the subject.
 - When the camera is far from the subject. (Orange colored focusing mark)
 - If there is reflection of the light or the backlight that are too bright.

Face Tone

This menu allows you to control the skin tone in images in beauty shot mode. The higher the level you select, the brighter the skin tone.

1. Select [Face Tone] by pressing the Up/Down button.
2. Select a desired face tone by pressing the Left / Right button and then press the OK button.
3. Press the Shutter button to take an image.

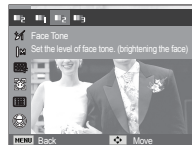

Face Retouch

This menu allows you to make skin appear clear and beautiful before recording in beauty shot mode. The higher the level selected, the more effective the control.

1. Select [Face Retouch] by pressing the Up/Down button.
2. Select a desired face retouch by pressing the Left / Right button and then press the OK button.
3. Press the Shutter button to take an image.

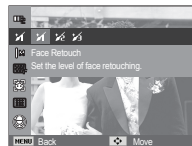

Shooting ()

Auto Focus type

You can select your preferred Focus Area according to the shooting conditions.

[Center AF] () : The rectangular area in the center of the LCD monitor will be focused

[Multi AF] () : This camera selects all of available AF point from the 9 AF points.

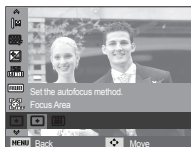



※ When the camera focuses on the subject, the auto focus frame turns to green. When the camera doesn't focus on the subject, the auto focus frame turns to red.

Metering

If you cannot obtain suitable exposure conditions, you can change the metering method to take brighter pictures.

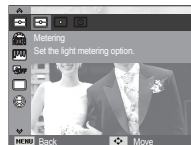
[Multi] () : Exposure will be calculated based on an average of the available light in the image area. However, the calculation will be biased towards the center of the image area. This is suitable for general use.



[Spot] () : Only the rectangular area in the center of the LCD monitor will be metered for light. This is suitable when the subject in the center is exposed correctly, regardless of the back lighting.

[Center-weighted] () : Exposure will be calculated based on an average of the available light in the image area. However, the calculation will be biased towards the center of the image area. This is suitable for taking a picture of small object like a flower or insects.

※ If the subject is not the center of the focus area, do not use the spot metering as this may result in an exposure error. In this circumstance, it is better to use exposure compensation.







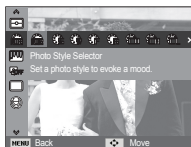



Shooting ()

Photo Style Selector

You can add various effects to the image without using image editing software.



1. Select the desired Photo style selector by pressing the Left/Right button and press the OK button.
2. Press the Shutter button to take an image.

Style mode	Icon	Description
Normal		No style effect is applied.
Soft		Soft style is applied.
Vivid		Vivid style is applied.
Forest		Forest style is applied.
Retro		Sepia style is applied.
Cool		Cool style is applied.
Calm		Calm style is applied.
Classic		Black & white effect is applied.
Negative		Negative effect is applied.
Custom RGB		Define an RGB tone to create your own photo style.

- Custom RGB : You can change the R (Red), G (Green) and B (Blue) values of the image.

- Up/Down button : Selects R, G, B
- Left/Right button : Changes the values



- When picture style is set, face detection is not available.
- When Photo Style Selector is set, Image Adjust function is not available.

Shooting ()

Image Adjust

■ Contrast

You can change the contrast of the image.

1. Select [Contrast] by pressing the Up/Down button.
2. Change the contrast by pressing the Left/Right button.
3. Press the Shutter button to take an image.

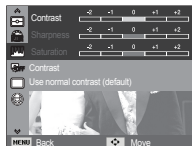

■ Sharpness

You can adjust the sharpness of the picture you are about to take.

You cannot check the sharpness effect on the LCD monitor before you take a picture, because this function is applied only when the captured image is stored on the memory.

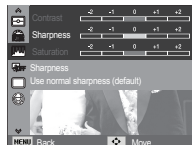

1. Select [Sharpness] by pressing the Up/Down button.
2. Change the Sharpness by pressing the Left/Right button.
3. Press the Shutter button to take an image.

■ Saturation

You can change the saturation of the image.

1. Select [Saturation] by pressing the Up/Down button.
2. Change the saturation by pressing the Left/Right button.
3. Press the Shutter button to take an image.

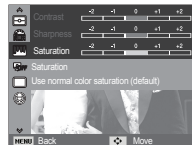

- When Image Adjust is set, Photo Style Selector function is not available.
- When Saturation is set, Face Detection is not available.

Shooting (📷)

ACB

This function is to adjust the contrast automatically when taking photos in an environment with big exposure difference i.e. backlight or contrast. This function adjusts the brightness automatically and allows the subject to be photographed clearly.

- [ACB] Sub menus: [Off], [On]

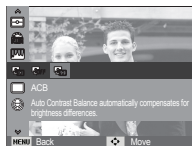

※ The ACB function is available in [Program], [Portrait] or [Photo Help Guide] recording mode. ACB function always operates in the [Portrait] recording mode.



Drive mode

You can select continuous shot, and AEB (Auto Exposure Bracketing).

[Single] (📷) : Take one picture only.

[Continuous] (📷) : Images will be taken continuously until the shutter button is released.

[Motion Capture] (📷)

: This takes about 6 shots per second, when the shutter is pressed and held down. After completing the continuous shooting, images are saved and the images play back on the Rear LCD. The maximum number of shots is 30 and the image size is fixed as VGA.

[AEB] (📷)

: Take three consecutive photos with varying exposure values. Use this mode if it is hard to decide exposure of the object.



- High resolution and picture quality increases file saving time, which increases stand-by time.
- If the [Continuous], [Motion Capture], [AEB] sub menu is selected, the flash will be off automatically.
- If less than 3 pictures are available on the memory, the AEB shooting is not available.
- If less than 30 pictures are available on the memory, the motion capture is not available.
- It is best to use a tripod for the AEB shooting as the time to save each image file is longer and blurring caused by camera shake may occur.

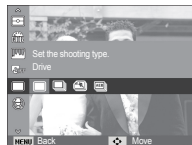

Shooting ()

Voice Memo

You can add your voice-over to a stored still image. (Max. 10 sec.)

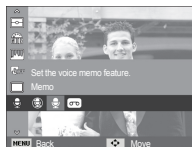

- If the voice memo indicator is displayed on the LCD monitor, the setting is completed.

- Press the Shutter button and take a picture. The picture is stored on the memory card.

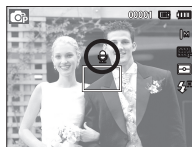

- Voice memo will be recorded for ten seconds from the moment the picture is stored. In the middle of the sound recording, pressing the shutter button will stop the voice memo.

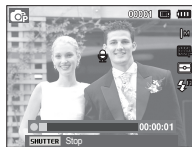

Voice Recording

A voice can be recorded for as long as the available recording time (Max. 10 hours) allows.

Press the shutter button to record a voice.

- Press the shutter button once and voice is recorded for as long as the available recording time (Max.10 hours) allows. The recording time will be displayed on the LCD monitor. Voice will still be recorded if the Shutter button is released.

- If you wish to stop recording, press the Shutter button again.

- File type : *.wav

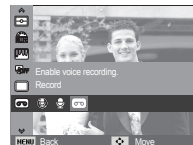

[Voice recording mode]

Shooting (📷)

■ Pausing while recording a voice

Using this function, you can record your favorite voice clips into a voice recording file without having to create multiple voice recording files.



[Voice recording mode]

1. Press the OK button to pause recording.
2. Press the OK button again to resume the recording.
3. If you wish to stop recording, press the Shutter button again.



- A distance of 40cm between you and the camera (microphone) is the best distance to record sound.
- If the camera power is turned off while the voice recording is paused, the voice recording is cancelled.

Recording the movie clip without voice

You can record the movie without voice.

Select [Off] of [Voice] menu in the Movie mode. (🔇) icon will appear on the LCD monitor. Press the Shutter button and a movie will record for as long as the memory capacity allows without voice.

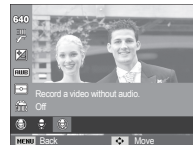

Sound ()

- The items indicated by * are default settings.
- ※ Menus are subject to change without prior notice.

Volume

You can select a volume of start up sound, shutter sound, beep sound and AF sound.

- [Volume] sub menus : [Off], [Low], [Medium]*, [High]

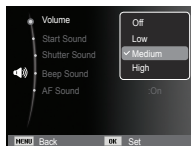

Start up sound

You can select the sound that is activated whenever the camera is turned on.

- Start up sound : [Off]*, [1], [2], [3]



Shutter sound

You can select the shutter sound.

- Shutter sound : [Off], [1]*, [2], [3]

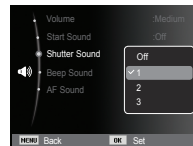

Beep sound

If you set sound to ON, a beep will sound when buttons are pressed, letting you know the camera operation status.

- [Beep Sound] sub menus : [Off], [1]*, [2], [3]

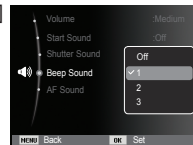

Sound ()

AF sound

If you set AF sound to on, AF sound will be activated when the Shutter button is pressed down half way so that you can be aware of the camera operation status.

- [AF sound] sub menus : [Off], [On]*

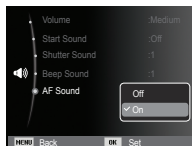

Display ()

■ The items indicated by * are default settings.

※ Menus are subject to change without prior notice.

Language

There is a choice of language that can be displayed on the LCD monitor. Even if the battery is removed and inserted again, the language setting will be preserved.



Function Description

You can select whether the function description can be displayed on the window in recording mode.

- Function Description sub menus
[Off] : The function description function can't be activated.

[On]* : The name and description of the option is displayed.



Display ()

Start up image

You can select the image that is first displayed on the LCD monitor whenever the camera is turned on.

- Sub menus : [Off]*, [Logo], [User Image]
- Use a saved image for the start-up image with the [Start Image] in the [Resize] menu in the play mode.
- The start-up image will not be deleted by [Delete] or [Format] menu.
- The user images will be deleted by [Reset] menu.

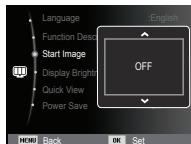

Display Brightness

You can adjust the LCD brightness.

- Sub menus : [Auto]*, [Dark], [Normal], [Bright]

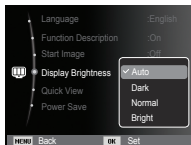

Quick View

If you enable Quick View before capturing an image, you can view the image you just captured on the LCD monitor for the duration set in the [Quick View] setup. Quick view is possible only with still images.

- Sub menus
[Off] : The quick view function can't be activated.
[0.5 sec]*, [1 sec], [3 sec] : The captured image is briefly displayed during the selected time.

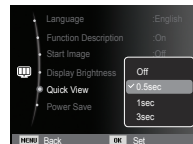

Display Save

If you set the [Power Save] to On and the camera isn't operated during the specified time, the LCD monitor will be turned off automatically.

- Sub menus
[Off]*: The LCD monitor will not be turned off.
[On] : If the camera isn't operated during the specified time (about 30 SEC.), the camera power will be idle (Camera status lamp:Blinking) automatically.

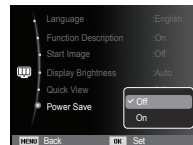

※ You can't set the [Power Save] menu of Playback Mode.

Settings ()

- The items indicated by * are default settings.
- ※ Menus are subject to change without prior notice.

Formatting the memory

This is used for formatting the memory. If you run [Format] on the memory, all images, including the protected images will be deleted. Be sure to download important images to your PC before formatting the memory.

- Sub menus

[Yes] : A window for confirming the selection displays. Select the [Yes] menu. A [Formatting] message appears and the memory will be formatted.

A [Format is completed] message appears and formatting is finished.

[No]* : The memory will not be formatted.



- Be sure to run [Format] on the following types of memory card.
 - A new memory card or an unformatted memory card.
 - A memory card that has a file this camera can't recognize or one that has been taken from another camera.
 - Always format the memory card using this camera. If you insert a memory card that has been formatted using other cameras, memory card readers or PCs you will get a [Card Error] message.

Initialization

All camera menu and function settings will be restored to their default values. However, values for Date & Time, Language and Video Out will not be changed.

- Sub menus

[Yes] : A window to confirm the selection will be displayed. Select the [Yes] menu and all settings will be restored to their defaults.

[No]* : Settings will not be restored to their defaults.

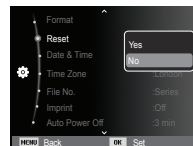

Settings (⚙)

Setting up the Date / Time / Date type

You can change the date and time that will be displayed on the captured images and set up the date type. Setting [Time Zone] enables you to display the local date and time on the LCD monitor when travelling overseas.

- Date type : [yyyy/mm/dd], [mm/dd/yyyy], [dd/mm/yyyy], [Off]*

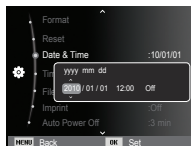

Time Zone

■ Available cities:

London, Cape Verde, Mid-Atlantic, Buenos Aires, Sao Paulo, Newfoundland, Caracas, La Paz, NewYork, Miami, Chicago, Dallas, Denver, Phoenix, LA, San Francisco, Alaska, Honolulu, Hawaii, Samoa, Midway, Wellington, Auckland, Okhotsk, Guam, Sydney, Darwin, Adelaide, Seoul, Tokyo, Beijing, Hong Kong, Bankok, Jakarta, Yangon, Almaty, Kathmandu, Mumbai, New Delhi, Tashkent, Kabul, Abu Dhabi, Teheran, Moscow, Athens, Helsinki, Rome, Paris, Berlin

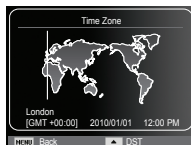

※ DST : Daylight Saving Time

File name

This function allows the user to select the file naming format.

[Reset] : After using the reset function, the next file name will be set from 0001 even after formatting, deleting all or inserting a new memory card.

[Series]* : New files are named using numbers that follow the previous sequence, even when a new memory card is used, or after formatting, or after deleting all pictures.

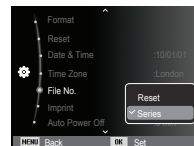

- The first stored folder name is 100PHOTO, and the first file name is SAM_0001.
- File names are assigned sequentially from SAM_0001 → SAM_0002 → ~ → SAM_9999.
- The folder number is assigned sequentially from 100 to 999 as follows: 100PHOTO → 101PHOTO → ~ → 999PHOTO.
- Maximum numbers of files in a folder are 9999.
- The files used with the memory card conform to the DCF (Design rule for Camera File systems) format. If you change the image file name, the image may not play back.

Settings ()

Imprinting the recording date

There is an option to include Date&Time on still images.

- Sub menus

[Off]* : The Date&Time will not be imprinted on the image file.

[Date] : Only the Date will be imprinted on the image file.

[Date & Time] : The Date&Time will be imprinted on the image file.

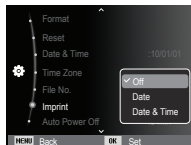

※ The Date & Time are imprinted at the bottom right side of the still image.

※ The imprint function is applied only to still images.

※ Depending on the manufacturer and print mode, the date printed on an image may not be printed correctly.

Auto power off

This function switches the camera off after a set amount of time in order to prevent unnecessary battery drainage.

- Sub menus

[Off] : The power off function will not operate.

[1 min], [3 min]*, [5 min], [10 min]

: The power will turn off automatically if not used for the period of time specified.

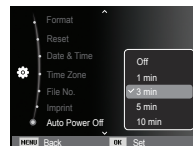

- After replacing the battery, the power off setting will be preserved.

- Note that the automatic power off function will not operate if the camera is in the PC / Printer mode, slide show, playing back a voice recording and playing back a movie clip.

Settings ()

Auto Focus lamp

You can turn on and off the Auto Focus lamp.

- Sub menus

[Off] : The AF lamp will not light up in low light conditions.

[On]* : The AF lamp will light up in low light conditions.

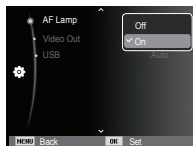

Selecting Video out type

The Video output signal from the camera can be NTSC or PAL. Your choice of output will be governed by the type of device (monitor or TV, etc.) to which the camera is connected. PAL mode can support only BDGHI.

■ Connecting to an external monitor

When the camera is connected to an external monitor, the image and menus on the LCD monitor will be visible on the external monitor.

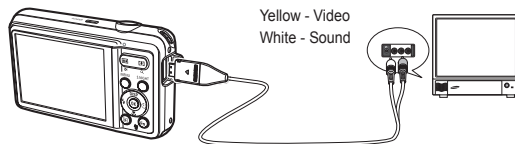

Settings ()

- NTSC : U.S.A, Canada, Japan, South Korea, Taiwan, Mexico etc.
- PAL : Australia, Austria, Belgium, China, Denmark, Finland, Germany, U.K., Holland, Italy, Kuwait, Malaysia, New Zealand, Singapore, Spain, Sweden, Switzerland, Thailand, Norway etc.
- When using a TV as an external monitor, you will need to select the external or AV channel of the TV.
- There will be digital noise on the external monitor, but it is not a malfunction.
- If the image is not in the center of the screen, use the TV controls to center it.
- When the camera is connected to an external monitor, some parts of the image may not be displayed.
- When the camera is connected to an external monitor, the menu will be visible on the external monitor and the menu functions are the same as those indicated on the LCD monitor.

Setting the USB

If the camera fails to automatically connect with a PC or a printer using a USB cable, you can manually set [Computer] or [Printer].

- [USB] sub menus:

[Auto]* : Automatically enables an external device connected with a USB cable.

[Computer]: Sets computer connection mode if the connected external device cannot be recognized automatically.

[Printer] : Sets printer connection mode if the connected external device cannot be recognized automatically.



Starting play mode

Turn the camera on and select Play mode by pressing the play mode button (). The camera can now play back the images stored on the memory. If the memory card is inserted in the camera, all the camera functions apply only to the memory card.

If the memory card is not inserted in the camera, all the camera functions apply only to the internal memory.

■ Manner mode

To select the Manner mode, press the Play mode button for more than 5 seconds. In the Manner mode, Operating sound, Effect sound, Start-up sound and Shutter sound will not be generated. To cancel the Manner mode turn on the camera by pressing the POWER button.

Playing back a still image

1. Select the Play mode by pressing the play mode button ().



2. The last image stored on the memory is displayed on the LCD monitor.

3. Select an image that you want to view by pressing the Left / Right button.



※ Press and hold the Left or Right button to play back the images quickly.

Playing back a movie clip

1. Select the recorded movie clip that you want to play back by using the Left / Right button.
2. Press the OK button to play back a movie clip file.



- To pause a movie clip file while playing it back, press the OK button again.
- Pressing the OK button again will cause the movie clip file to restart.
- To rewind the movie clip while it is playing, press the Left button. To fast forward the movie clip, press the Right button.
- To stop playback of the movie clip, press the OK button, and then press the Left or Right button.

Starting play mode

Movie clip capture function

You can capture still images from the movie clip.

■ How to capture the movie clip

1. Press the OK button while playing the movie clip. Then press the Down button.
2. The paused movie clip is saved as a new file name.

※ The captured movie clip file is the same size as the original movie clip (640x480, 320x240).

※ When you press the down button at the beginning of the movie clip, the first frame of the movie clip will be saved as a still image.



[Paused]

Playing back a recorded voice

1. Select the recorded voice that you want to play back by using the Left / Right button.
2. Press the OK button to play back a recorded voice file.
 - To pause a recorded voice file, while playing it back, press the OK button again.
 - To resume playback of the voice file, press the OK button.
 - To rewind the voice file while it is playing, press the Left button.
 - To fast forward the voice file, press the Right button.
 - To stop playback of the voice memo, press the Down button.

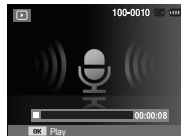

Playing back a voice memo

1. Select a still image that has the voice memo.
2. Press the OK button to play back the voice memo.
 - To pause the voice memo, while playing it back, press the OK button again.
 - To resume playback of the voice memo, press the OK button.



LCD monitor Indicator

The LCD monitor displays shooting information about the displayed image.

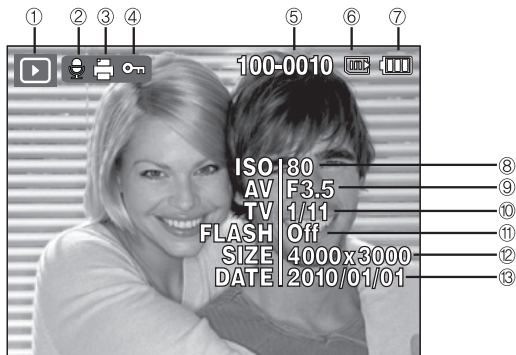

No.	Description	Icon	Page
1	Playback mode		p.59
2	Voice Memo		p.75
3	DPOF		p.76
4	Protect		p.74
5	Folder name & File name	100-0010	p.55
6	Memory indicator		-
7	Battery		p.15
8	ISO	80~1600	p.41
9	Aperture value	F3.5 ~ F15	-
10	Shutter speed	8 ~ 1/2,000	-
11	Flash	On/Off	p.34
12	Photo Size / Movie Size	4000x3000 ~ 320x240	p.39
13	Recording date	2010/01/01	p.55

Using the camera buttons to set the camera

In Play mode, you can use the buttons on the camera to conveniently set up the Play mode functions.

Thumbnail () / Enlargement () button



Smart Album

You can view multiple pictures, enlarge a selected picture, and crop and save a selected area of an image.

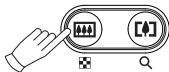
1. Once a picture has been played back, press the Thumbnail button to run Smart Album mode.
2. Press the Left / Right buttons to move to a desired image.
3. Press the Digital Zoom button to return to the normal display mode.



[Highlighted image]

Pressing the thumbnail button ()
Pressing the enlargement button ()



[Smart Album 3-Thumbnail Window]

Thumbnail () / Enlargement () button

■ Searching or Deleting Files

1. Press the Thumbnail button in Smart Album.
2. Each time you press the Thumbnail button, the files in a category are displayed in Smart Album screen.
3. Select the file by pressing the Up / Down / Left / Right buttons.
4. Press the Delete () button to delete the selected file.

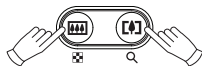

[3-Thumbnail Window]



[9-Thumbnail Window]



[20-Thumbnail Window]



- When Smart Album feature runs or a category is selected, it may take few seconds depends on recorded data volume. However, it is not a malfunction please wait until Smart Album screen appears.

■ Smart Album Filter

1. Press the MENU button in Smart Album mode.
2. Selecting the desired category enables to categorize and search the files by using the Up / Down button.

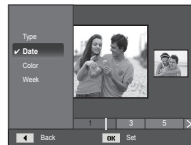

Thumbnail () / Enlargement () button

■ Details of Each Category



Category	Description	File Format
Type	Categorized depending on the file type (e.g., picture, video, or voice)	Pictures, Videos, Voice
Date	Categorized depending on the sequence of recorded dates.	
Color	Categorized depending on the main color.	
Week	Categorized depending on the sequence of recorded weeks.	

■ Image enlargement

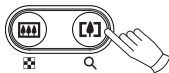
1. Select an image that you want to enlarge and press the enlargement button.
2. Different parts of the image can be viewed by pressing the 5 function button.
3. Pressing the thumbnail button will zoom back to the original full sized image.
 - You can tell whether the image displayed is an enlarged view by checking the image enlargement indicator shown at the top left of the LCD monitor. (If the image is not an enlarged view, the indicator will not be displayed.) You can also check the area of enlargement.
 - Movie clips and WAV files can't be enlarged.
 - If an image is enlarged, a loss of quality may occur.



■ The maximum enlargement rate in proportion to the image size

Image size	12M			8M	5M	3M		1M
Maximum enlargement rate	X12.5	X10.4	X10.0	X10.2	X8.0	X6.4	X5.0	X3.2

■ Trimming : You can extract part of the image that you want and save it separately.

1. Select an image that you want to enlarge and press the enlargement button. Press the OK button and a message will be displayed.
2. Select a desired sub menu by pressing the Up / Down button and press the OK button.
 - [Yes] : The trimmed image will be saved as a new file name, and appear on the LCD monitor.
 - [No] : The trimming menu will disappear.

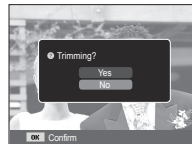

- ※ If there is not enough memory space to save the trimmed image, the image can't be trimmed.

Info (DISP) / Up button

When the menu is displayed on the LCD monitor, the Up button operates as a direction button.

When the menu is not displayed on the LCD monitor, pressing the Info button will display image information on the LCD monitor.

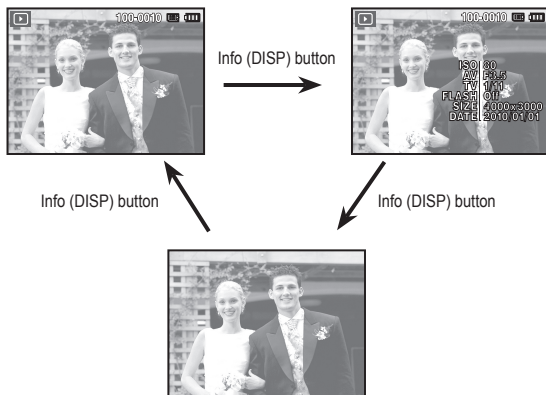

Play & Pause / OK button

In Play mode, the play & pause / OK button works as follows:

- When the menu is displayed on the LCD monitor, the OK button is used for confirming data that is changed by using the 5 function button.
- If a still image with a voice memo, a voice file or a movie clip is playing
 - In Stop mode : Plays a still image with a voice memo, a voice file or a movie clip.
 - During playback : Temporarily stops playback.
 - In Pause mode : Resumes playback



Left / Right / Down / MENU button

Left / Right / Down / MENU buttons activate the following.

- Left button : While the menu is showing, the Left button operates as a direction button. While the menu is not showing, press the Left button to select the previous image.
- Right button : While the menu is showing, the Right button operates as a direction button. While the menu is not showing, press the Right button to select the next image.
- Down button : While the menu is showing, the Down button operates as a direction button.
- MENU button : When you press the MENU button, the play mode menu will be displayed on the LCD monitor. Pressing it again will return the LCD to the initial display.

Delete () button

This deletes images stored on the memory.

1. Select an image that you want to delete by pressing the Left / Right button and press the Delete () button.

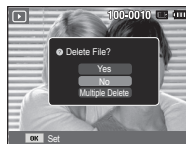

[Single Image]

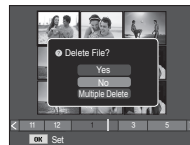

[Thumbnail Image]

2. To add images to delete, select the [Multiple Delete] menu.

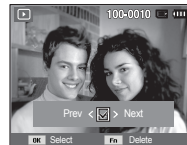

- Left / Right button : Selects images
- OK button : checks for deletion
- Fn button : deletes the selected images.





3. Select the submenu values by pressing the Up / Down button and then press the OK button.
 - If [Yes] is selected : deletes the selected images.
 - If [No] is selected : cancels "Delete Image".

Setting up the play back function using the LCD monitor

Play mode functions can be changed by using the LCD monitor. In the Play mode, pressing the MENU button displays the menu on the LCD monitor. The menus you can set up in Play mode are as follows. To capture an image after setting up the play menu, press the Play mode button or shutter button.

Menu Tab	Main Menu	Sub Menu		Page
Edit ()	Resize	2560x1920	2048x1536	p.68
		1024X768	2592X1728	
		1776X1184	2560X1440	
		1920X1080	Start Image	
	Rotate	Right 90°	Left 90°	p.69
		180°	Horizontal	
		Vertical	-	
	Photo Style Selector	Normal	Soft	p.69
		Vivid	Forest	
		Retro	Cool	
		Calm	Classic	
		Negative	Custom RGB	
	Image Adjust	Off	ACB	p.70
		Red-eye Fix	Face Retouch	
Brightness		Contrast		
Saturation		Add Noise		
Multi Slide Show ()	Start	Play / Repeat	-	p.72
	Images	All	Date	p.72
		Select	-	

Menu Tab	Main Menu	Sub Menu		Secondary Menu	Page
Multi Slide Show ()	Effect	Off	Calm	-	p.73
		Sweet	Rural	-	
		Vivid	Lively	-	
		Shine	Relax	-	
	Interval	1, 3, 5, 10 sec		-	p.73
	Music	Off	Mist	-	p.73
		Muse	Fall	-	
		Dawn	Party	-	
Drops		Trip	-		
File Options ()	Delete	Select		-	p.74
		All		Yes / No	
	Protect	Select		-	p.74
		All		Unlock / Lock	
	Voice memo	Off	-		p.75
		On	-		
	DPOF	Standard		Select / All / Reset	p.76 ~ p.77
		Index		Yes / No	
		Size		Select / All / Reset	
	Copy to Card	Yes		-	p.78
No		-			

Setting up the play back function using the LCD monitor

This menu is available while the camera is connected to a PictBridge supporting printer (direct connection to the camera, sold separately) with a USB cable.

Menu Tab	Main Menu	Sub Menu	Secondary Menu	Page
	Images	One Photo	-	p.80
		All Photos	-	
	Size	Auto	-	p.80
		PostCard	-	
		Card	-	
		4X6	-	
		L	-	
		2L	-	
		Letter	-	
		A4	-	
		A3	-	
		Layout	Auto	
	Full		-	
	1		-	
	2		-	
	4		-	
	8		-	
	9		-	
	16		-	
Index	-			

Menu Tab	Main Menu	Sub Menu	Secondary Menu	Page
	Type	Auto	-	p.80
		Plain	-	
		Photo	-	
		Fast Photo	-	
	Quality	Auto	-	
		Draft	-	
		Normal	-	
		Fine	-	
	Date	Auto	-	
		Off	-	
		On	-	
	File Name	Auto	-	
		Off	-	
		On	-	
Reset	Yes	-	p.81	
	No	-		

※ Menus are subject to change without prior notice.

Edit ()

Resize

Change the resolution (size) of pictures taken. Select [Start image] to save an image to be the start-up image.

1. Press the play mode button and press the MENU button.
2. Click the Up / Down button from the Edit menu to select [Resize] () menu tab and press the OK button.
3. Select a desired sub menu by pressing the Left / Right button and press the OK button.



■ Image Resize Types

(o : Selectable)

	5M	3M	1M	
12M	o	o	o	o
8M	o	o	o	o
5M		o	o	o
3M			o	o
1M				o

	4M	2M	
9M	o	o	o
2M			o

	4M	2M	
10M	o	o	o

- A large sized image can be resized to a smaller sized image, but not vice versa.
- Only JPEG images can be resized. Movie clip (AVI), Voice recording (WAV) files can't be resized.
- You can change the resolution of only those files compressed in the JPEG 4:2:2 format.
- The resized image will have a new file name.
- The [Start Image] image is stored not on the memory card but on the internal memory.
- If a new user image is saved, the original user image will be deleted.
- If the memory capacity is insufficient to store the resized image, a [Memory Full] message will appear on the LCD monitor and the resized image can't be stored.

Edit ()

After using [Edit] feature, the edited image will be saved as a smaller size than the original image. (Only with image size from 8M)

Rotating an image

You can rotate the stored images by various degrees.

1. Press the play mode button and press the MENU button.
2. Click the Up / Down button from the Edit menu to select [Rotate] () menu tab and press the OK button.
3. Select a desired sub menu by pressing the Left / Right button and press the OK button.

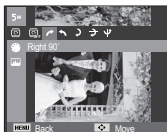
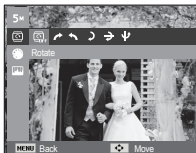

[] : Right 90°
: Rotate picture in a clock-wise direction



[] : Left 90°
: Rotate picture in a counter-clock-wise direction

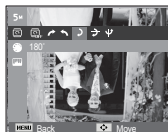

[] : 180°
: Rotate picture 180 degrees

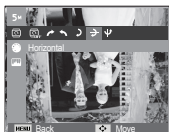

[] : Horizontal
: Rotate picture horizontally



[] : Vertical
: Rotate picture vertically











※ If you display the rotated image on the LCD monitor, empty spaces may appear to the left and right of the image.

Photo Style Selector

It is possible to add various effects to your images by using this function.

1. Press the play mode button and press the MENU button.
2. Click the Up / Down button from the Edit menu to select [Photo Style Selector] () menu tab and press the OK button.
3. Select a desired sub menu by pressing the Left / Right button and press the OK button.



Style mode	Icon	Description
Normal		No style effect is applied.
Soft		Soft style is applied.
Vivid		Vivid style is applied.
Forest		Forest style is applied.
Retro		Sepia style is applied.
Cool		Cool style is applied.
Calm		Calm style is applied.
Classic		Black & white effect is applied.
Negative		Negative effect is applied.
Custom RGB		Define an RGB tone to create your own photo style.

4. The changed image is saved as a new file name.

Edit ()

■ Custom RGB

You can change the R (Red), G (Green) and B (Blue) values of the image.

- OK button : Select / setup the Custom Color
- Up / Down button : Selects R, G, B
- Left / Right button : Change the values



■ Red eye Removal

Red eye effect can be removed from the captured image.



1. Select () by pressing the Left / Right button and press the OK button.
2. The [Making New Image] message is displayed and the image is saved as a new file name.



Image Adjust

1. Press the play back button and press the MENU button.
2. Click the Up / Down button from the Edit menu to select [Image Adjust] () menu tab and press the OK button.

■ ACB

You can automatically adjust the brightness of the dark area, caused by under exposure to the light source.

1. Select () by pressing the Left / Right button and press the OK button.
2. The [Making New Image] message is displayed and the image is saved as a new file name.



■ Face Retouch

You can make the skin in an image appear clear and beautiful.

1. Select () by pressing the Left / Right button and press the OK button. Then a bar for selecting the face retouch will be displayed.
2. Change the face retouch by pressing the Left / Right button.
3. Press the OK button and the image will be saved as a new file name.



Edit (🔧)

■ Brightness control

You can change the brightness of the image.

1. Select (☀️) by pressing the Left / Right button and press the OK button. Then a bar for selecting the brightness will be displayed.
2. Change the brightness by pressing the Left / Right button.
3. Press the OK button and the image will be saved as a new file name.



■ Saturation control

You can change the saturation of the image.

1. Select (🌈) by pressing the Left / Right button and press the OK button. Then a bar for selecting the saturation will be displayed.
2. Change the saturation by pressing the Left / Right button.
3. Press the OK button and the image will be saved as a new file name.



■ Contrast control

You can change the contrast of the image.

1. Select (⦿) by pressing the Left / Right button and press the OK button. Then a bar for selecting the contrast will be displayed.
2. Change the contrast by pressing the Left / Right button.
3. Press the OK button and the image will be saved as a new file name.



■ Noise effect

You can add noise to an image to add a more classic feel to your photo.

1. Select (🔲) by pressing the Left / Right button and press the OK button.
2. The [Making New Image] message is displayed and the image is saved as a new file name.



Starting the Multi Slide Show ()

Images can be displayed continuously at preset intervals. You can view the Multi Slide Show by connecting the camera to an external monitor.

1. Press the play mode button and press the MENU button.
2. Press the Up / Down button and select the [Multi Slide Show] menu tab and press the OK button.

Start the Multi Slide Show

The Multi Slide Show can start only in the [Start] menu.

1. Use the Up / Down button to select the [Start] menu and press the Right button.

2. Select a desired sub menu by pressing the Up / Down button.

[Play] : The Multi Slide Show is closed after one cycle.

[Repeat] : The Slide show is repeated until cancelled.

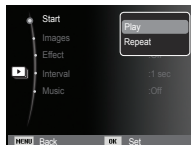

3. Press the OK button and the slide show will be started.
 - To pause the slide show while playing it back, press the OK button again.
 - Pressing the OK button again will cause the Multi Slide Show restart.
 - To stop playback of the Multi Slide Show, press the OK button, and then press the Left or Right button.

Selecting Images

You can select image to view

1. Use the Up / Down button to select the [Images] menu and press the Right button.
2. Select a desired sub menu by pressing the Up / Down button.

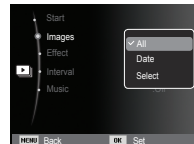

[All] : All images saved on the memory are played back.

Press the OK button and the settings are saved.

[Date] : Images taken in a specified date are played back.

Press the OK button and the settings are saved.

[Select] : Play only the selected images. If you press the Up / Down button, you can select the desired images to play back. The selected image can be saved as [Select1], [Select2] and [Select3]. If you save the selected image with the [New Select] command, it will be saved as [Select1]. But when a new image is saved again using [New Select], the former image which had been saved as [Select1] will be saved as [Select2] automatically. You can change and cancel the images which were saved as [Select1], [Select2] and [Select3]. Press the Fn button and the settings are saved.

3. Select [Play] or [Repeat] in the [Start] menu to start the multi slide show.

Starting the Multi Slide Show ()

Configure Multi Slide show effects

Unique screen effects can be used for the Multi Slide Show.

1. Select the [Effect] sub menu by pressing the Up / Down button and press the Right button.
2. Use the Up / Down button to select the type of effect.
3. Press the OK button to confirm the setting.

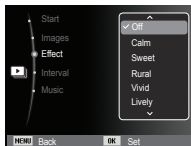

Setting play interval

Set the Multi Slide Show play interval.

1. Select the [Interval] sub menu by pressing the Up / Down button and press the Right button.
2. Use the Up / Down button to select the desired interval.
3. Press the OK button to save the configuration.

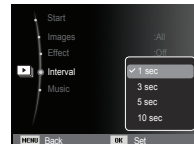

- The loading time depends on the image size and quality.
- While the Multi Slide Show is playing, the Movie clips and voice recording files will not display.
- The interval menu functions only when the Effect is set to [Off].

Setting Background Music

Set the Multi Slide Show music.

1. Select the [Music] sub menu by pressing the Up / Down button and press the Right button.
2. Use the Up / Down button to select the desired Music.
3. Press the OK button to save the configuration.

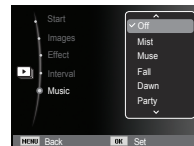

File Options ()

1. Press the play mode button and press the MENU button.
2. Press the Up / Down button and select the [File Options] menu tab and press the OK button.

Deleting images

This deletes images stored on the memory.

1. Press the Up / Down button and select the [Delete] menu tab. And then press the Right button.

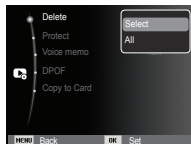

2. Select a desired sub menu by pressing the Up / Down button and press the OK button. [Select] : Selection window for an image to delete is displayed.

- Up / Down / Left / Right : Select an image
- OK button : Select the image for deletion.
(✓ mark)



- Fn button : Press the Fn button to display the confirmation message. Select the [Yes] menu and press the OK button to delete marked images.



[All] : Displays confirmation window.

Select the [Yes] menu and press the OK button to delete all unprotected images. If there aren't any protected images, all the images are deleted and a [No Image File] message will appear.

3. After deletion, the screen will be changed to the play mode screen.



- Of all the files stored on the memory, the unprotected files in the DCIM subfolder will be deleted. Remember that this will permanently delete unprotected images. Important shots should be stored on a computer before deletion takes place. The startup image is stored on the camera's internal memory (i.e., not on the memory card) and it will not be deleted even if you delete all files on the memory.

Protecting images

This is used to protect specific shots from being accidentally erased (Lock). It also unprotects images that have been previously protected (Unlock).

1. Press the Up / Down button and select the [Protect] menu tab. And then press the Right button.

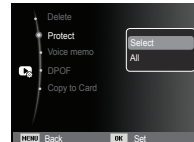

2. Select a desired sub menu by pressing the Up / Down button and press the OK button.

[Select] : Selection window for an image to be protected / released is displayed.

- Up / Down / Left / Right : Select an image

- OK button : Protect / release the image
- Fn button : Your changes will be saved and the menu will disappear.



File Options ()

- [All] : Protect / release all saved images
- If you protect an image, the protect icon will be displayed on the LCD monitor. (An unprotected image has no indicator)
 - An image in LOCK mode will be protected from the delete function or [Delete] function, but will NOT be protected from the [Format] function.

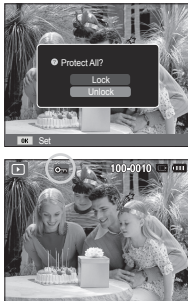

Voice memo

You can add your voice to a stored still image.



[Voice memo menu]

[Ready for recording]

[Voice is recording]

- Press the shutter button, the voice will record for 10 seconds.
- To stop the recording, press the shutter button.

File Options ()

DPOF

- DPOF(Digital Print Order Format) allows you to embed printing information on your memory card's MISC folder. Select the pictures to be printed and how many prints to make.
- The DPOF indicator will display on the LCD monitor when an image that has DPOF information plays back. Images can then be printed on DPOF printers, or at an increasing number of photo labs.
- This function is not available for Movie clips and Voice recording files.
- When the wide angle image is printed as a wide angle print, 8% of the left and right side of the image may not be printed. Check that your printer can support the wide angle image when you print the image. When you print the image at a photo lab, request that the image is printed as a wide angle image. (Some photo labs may not support the wide angle size print.)

-  Depending on the printer, the image saved in portrait orientation may not be printed in portrait orientation.

■ Standard

This function allows you to embed printing quantity information on a stored image.

1. Press the Up / Down button and select the [DPOF] menu tab. And then press the Right button.

2. Press the Right button again and [Standard] sub menu will display.

3. Select a desired sub menu by pressing the Up / Down button and press the OK button.

[Select] : Selection window for an image to print is displayed.

- Up / Down / Left / Right : Select an image to print.

- Zoom button : Select the number of prints.

[All] : Configure number of prints for all pictures except movie and voice files.

- Up / Down button : Select a number of prints

[Reset] : Cancel the print setup.

4. Press the OK button to confirm the setting. If an image carries DPOF instruction, the DPOF indicator () will show.

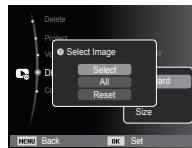

File Options ()

■ Index

Images (except for movie clips and voice files) are printed as index type.

1. Press the Up / Down button and select the [DPOF] menu tab. And then press the Right button.
2. Select the [Index] menu and press the Right button again. Sub menu will display.

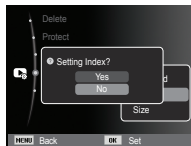

3. Select a desired sub menu by pressing the Up / Down button.
If [Yes] is selected : The image will be printed in index format.
If [No] is selected : Cancel the index print setting.
4. Press the OK button to confirm the setting.

■ Print size

You can specify the print size when printing images stored on the memory card. The [Size] menu is available only for DPOF 1.1 compatible printers.

1. Press the Up / Down button and select the [DPOF] menu tab. And then press the Right button.
2. Select the [Size] menu and press the Right button again. Sub menu will display.

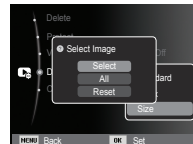

3. Select a desired sub menu by pressing the Up / Down button and press the OK button.

[Select] : Selection window to change the printed size of the image is displayed.

- Up / Down / Left / Right : Select an image.
- Zoom W/T Button : Change the print size.
- Fn button : Your changes will be saved and the menu will disappear.

[All] : Change print size of all saved images.

- Up / Down button : Select a print size
- OK button : Confirm the changed setting.
- [Reset] : Cancel all of the print size settings.



※ DPOF [Size] secondary menu : Cancel, 3X5, 4X6, 5X7, 8X10



- Depending on the manufacturer and print model, cancelling the printing may take a little longer for the printer to process.

File Options ()

Copy to Card

This enables you to copy image files, movie clips and voice recording files to the memory card.

1. Select the [Copy to Card] menu tab by pressing the Up / Down button. And then press the Right button.
2. Select a desired sub menu by pressing the Up / Down button and press the OK button.

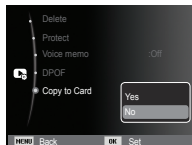

- [Yes] : All images, movie clips and voice recording files saved in the internal memory are copied to the memory card after the [Copying] message is displayed. After copying has been completed, the screen will return to play mode.
- [No] : Cancels "Copy to Card".



- If there is not enough space available on the memory card to copy saved images on the internal memory (About 9.9MB), the [Copy to Card] command will copy only some of the images and display [Memory Full] message. Then the system will return to the playback mode. Please be sure to delete any unnecessary files to free up space before inserting the memory card into the camera.
- When you move the images that are stored on the internal memory by doing [Copy to Card] to the card, the next number of file names will be created on the card to avoid duplication of the file name.
 - When the [Reset] of the [File No.] setup menu is set : The copied file names start from after the last stored file name.
 - When the [Series] of the [File No.] setup menu is set : The copied file names start from after the last captured file name. After completing [Copy to Card], the last stored image of the last copied folder is displayed on the LCD monitor.

PictBridge

You can use the USB cable to connect this camera to a printer that supports PictBridge (sold separately) and print the stored images directly. Movie clips and voice files cannot be printed.

■ Setting up the camera for connection to the printer

1. Connect the camera and printer with USB cable.
2. Once the camera is turned on, the camera automatically recognizes the printer and is connected to it.

※ If automatic connection fails, set the [USB] menu to [Printer]. (p.58)

※ For a printer that can enable removable disk, set the [USB] menu to [Printer].

■ Connecting the Camera to a Printer

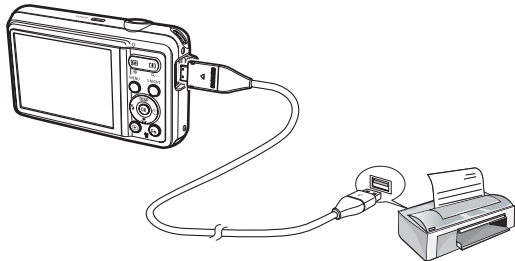

■ Easy printing

When you connect the camera to printer in the Play back mode, you can print a picture easily.

- Pressing the Left / Right button :
Selects a previous / next image.
- Pressing the OK button :

Currently displayed image will be printed with the printer's default settings.

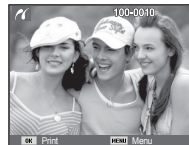

PictBridge : Picture Selection

You can select images you want to print.

■ Setting the Number of Copies to Print

1. Press the MENU button and the PictBridge menu will display.
2. Use the Up / Down button to select the [Images] menu and press the Right button.
3. Use the Up / Down button to select a desired sub menu and press the OK button.

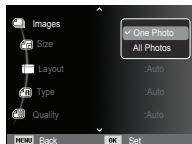

- Select [One Photo] or [All Photos]. A screen where you can set the number of copies to print will appear as shown below.



[When [One Photo] is selected]



[When [All Photos] is selected]

- Press the Up / Down button to select the number of prints.
- When [One Photo] is selected : Use the Left / Right button to select another picture. After selecting another picture, select the number of prints for another picture.
- After setting the number of prints, press the OK button to save.
- Press the Shutter button to return to the menu without setting the number of prints.

4. Press the play mode button () and images will be printed.

PictBridge : Print Setting

You can select the Paper Size, Print Format, Paper Type, Print Quality, Date Print and File Name Print menus for printed pictures.

1. Press the MENU button and the PictBridge menu will display.
2. Use the Up / Down button to select the desired menu, and then press the Right button.
3. Use the Up / Down button to select the desired sub menu value, and then press the OK button.

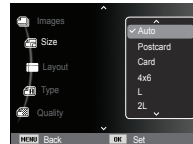

Menu	Function	Sub menu
Size	Set the size of the printing paper	Auto, PostCard, Card, 4X6, L, 2L, Letter, A4, A3
Layout	Set the number of pictures to be printed on a sheet of paper	Auto, Full, 1, 2, 4, 8, 9, 16, Index
Type	Set the quality of the printing paper	Auto, Plain, Photo, Fast Photo
Quality	Set the quality of the picture to be printed	Auto, Draft, Normal, Fine
Date	Set whether to print the date	Auto, Off, On
File Name	Set whether to print the file name	Auto, Off, On

- ※ Some menu options are not supported on all printers. If not supported, the menus are still displayed on the LCD, but are not selectable.

PictBridge : Reset

Initializes user-changed configurations.

1. Use the Up / Down button to select the [Reset] menu tab. And then press the Right button.
2. Use the Up / Down button to select the desired sub menu and then press the OK button.



If [Yes] is selected : All print and image settings will be reset.

If [No] is selected : Settings will not be reset.

- ※ Default print setting varies depending on the printer manufacturer. For your printer's default setting, refer to the user's guide that came with your printer.

Important notes

Be sure to observe the following precautions!

- **This unit contains precision electronic components. Do not use or store this unit in the following locations.**
 - Areas exposed to severe changes in temperature and humidity.
 - Areas exposed to dust and dirt.
 - Areas exposed to direct sunlight or the inside of a vehicle in hot weather.
 - Environments where there is high magnetism or excessive vibration.
 - Areas with high explosives or highly flammable materials.
- **Do not leave this camera in places subject to dust, chemicals (like naphthalene and mothballs), high temperature and high humidity. Keep this camera with silica gel in a hermetically sealed box when not planning to use the camera for a long period of time.**
- **Sand can be particularly troublesome to cameras.**
 - Do not let sand get inside the camera when using it on beaches, coastal dunes, or other areas where there is lots of sand.
 - Doing so may result in failure or may permanently render the camera unusable.
- **Handling the camera**
 - Never drop the camera or subject it to severe shocks or vibrations.
 - Protect the large size LCD monitor from an impact. When this camera is not used, keep it in the camera case.
 - Avoid obstructing the lens or the flash when you capture an image.
 - This camera is not waterproof.
To avoid dangerous electrical shocks, never hold or operate the camera with wet hands.
 - If you use this camera in wet places, such as beach or pool, do not let water or sand get inside the camera. Doing so may result in failure or may permanently damage the unit.

Important notes

- **Extremes in temperature may cause problems.**

- If the camera is transferred from a cold to a warm and humid environment, condensation can form on the delicate electronic circuitry. If this occurs, turn the camera off and wait for at least 1 hour until all moisture is dispersed. Moisture built up can also occur on the memory card. If this happens, turn off the camera and remove the memory card. Wait until the moisture has dispersed.

- **Caution on Using the Lens**

- If the lens is subjected to direct sunlight, it could result in the discoloration and deterioration of the image sensor.
- Take care not to get fingerprints or foreign substances on the surface of the lens.

- **If the digital camera is not used for a long period, an electric discharge can occur. It is a good idea to remove the battery and the memory card if you do not intend using the camera for an extended period of time.**

- **If the camera is exposed to electronic interference, it will turn itself off to protect the memory card.**

- **Camera Maintenance**

- Use a soft brush (available from photo stores) to gently clean the lens and LCD assemblies. If this does not work, lens cleaning paper with lens cleaning fluid can be used. Clean the camera body with a soft cloth. Do not allow this camera to come into contact with solvent materials such as benzol, insecticide, thinners etc. This may damage the body shell of the camera and also affect its performance. Rough handling can damage the LCD monitor. Take care to avoid damage and keep the camera in its protective carry case at all times when not in use.

- **Do not attempt to disassemble or modify the camera.**

- **Under certain conditions, static electricity can cause the flash unit to fire. This is not harmful to the camera and is not a malfunction.**

- **When images are uploaded or downloaded, the data transfer may be affected by static electricity. In this case, disconnect and re-connect the USB cable before trying the transfer again.**

- **Before an important event or going on a trip, you should check the camera condition.**

- Take a picture for testing the camera condition and prepare extra battery.

- **If the digital camera is not used for a long period, the date and time may adopt the default settings by automatical battery discharged. In this case, reset the date and time correctly before the recording.**

Warning indicator

There are several warnings that may appear on the LCD display.

[Card Error]

- Memory card error
 - Turn off the camera power and turn it on again
 - Insert the memory card again
 - Insert and format the memory card (p.54)

[Card Locked]

- The memory card is locked
 - SD/SDHC memory card : Slide the write protect switch to the top of the memory card

[Memory Full]

- The memory card or internal memory is full
 - Insert new memory card
 - Delete unnecessary image files

[No Image File]

- There are no images stored on the memory
 - Take images
 - Insert a memory card that is storing some images

[File Error]

- File error
 - Delete the file
- Memory card error
 - Contact a camera service center

[Low Battery]

- There is low battery capacity
 - Insert fresh battery

Before contacting a service center

Please check the following.

The camera doesn't switch on

- There is low battery capacity
→ Insert fresh battery (p.15)
- Battery is inserted incorrectly with the polarities reversed
→ Insert the battery according to the polarity marks (+, -)

The camera power ceases while in use

- The battery is exhausted
→ Insert fresh battery
- The Camera is turned off automatically
→ Turn on the camera power again
- Operation has ceased in a low temperature outside of the camera usage temperature range
→ Make the camera and battery warm by placing them in your pocket, etc. and then immediately before shooting, place the battery in the camera and then shoot

Camera does not take images when pressing the Shutter button

- There is insufficient memory capacity
→ Delete unnecessary image files
- The memory card has not been formatted
→ Format the memory card (p.54)
- The memory card is exhausted
→ Insert a new memory card
- The memory card is locked
→ Refer to [Card Locked] error message (p.83)
- The camera's power is off
→ Turn the camera power on
- The battery is exhausted
→ Insert fresh battery (p.15)
- Battery is inserted incorrectly with the polarities reversed
→ Insert the battery according to the polarity marks (+, -)

The camera suddenly stops working while in use

- The camera stopped due to a malfunction
→ Remove / reinsert battery and switch the camera on

The images are unclear

- A picture was taken of the subject without setting an appropriate macro mode
→ Select an appropriate macro mode to take a clear image
- Taking a picture beyond the flash range
→ Take a picture within the flash range
- The lens is smudged or dirty
→ Clean the lens

Before contacting a service center

The flash does not fire

- Flash off mode has been selected
→ Disengage flash off mode
- The camera mode can't use the flash
→ Refer to the FLASH instruction (p.34)

Incorrect date and time is displayed

- The date and time have been set incorrectly or the camera has adopted the default settings
→ Reset the date and time correctly

The camera buttons do not operate

- Camera malfunction
→ Remove / reinsert battery and switch the camera on

A card error has occurred while the memory card is in the camera

- Incorrect memory card format
→ Reformat the memory card

The images don't play back

- Incorrect file name (Violation of DCF format)
→ Do not change the image file name

Color of image is different to the original scene

- White balance or effect setting is incorrect
→ Select appropriate White balance and effect

Images are too bright

- Exposure is excessive
→ Reset exposure compensation

No image on external monitor

- The external monitor has not been connected properly with the camera
→ Check the connection cables
- There are incorrect files on the memory card
→ Insert a memory card that has correct files

When using the PC's explorer, the [Removable Disk] file does not show

- Cable connection is incorrect
→ Check the connection
- The camera is off
→ Turn the camera on
- The operating system is not Windows XP, Vista, 7 / Mac OS 10.3. Alternatively the PC does not support USB
→ Install Windows XP, Vista, 7 / Mac OS 10.3 to PC that supports USB

A part of the LCD screen does not occasionally turn on or a spot appears

- Although the LCD screen is manufactured with high precision technology, the precision pixels are not occasionally lighted or the red, white and blue spots appear
→ This phenomenon does not affect the quality of the recorded image and it is not a malfunction

A vertical line appears on the LCD screen when taking a picture of a bright object

- If a subject is exposing bright lights, a gray, black, red or purple vertical line may appear
→ This is a phenomenon called smear and it does not affect the quality of the recorded image. This is not a malfunction

Specifications

Image Sensor - Type : 1/2.33" CCD
 - Effective Pixels : Approx. 12.2 Mega-pixels
 - Total Pixels : Approx. 12.3 Mega-pixels

Lens - Focal Length : SAMSUNG Lens f = 4.9 ~ 24.5mm
 (35mm film equivalent : 27 ~ 135mm)
 - F No. : F3.5(W) ~ F5.9(T)
 - Digital Zoom : Still Image mode : 1.0X ~ 3.0X
 Play mode : 1.0X ~ 12.5X
 (depends on image size)

Image Stabilization - DIS (Digital Image Stabilization)

LCD Monitor - 2.7" color TFT LCD (230,000 dots)

Focusing - Type : TTL auto focus (Multi AF, Center AF, Face Detection AF)
 - Range

	Normal	Macro	Auto Macro
Wide	80cm ~ Infinity	5cm ~ 80cm	5cm ~ Infinity
Tele	100cm ~ Infinity	100cm ~ 150cm	100cm ~ Infinity

Shutter - Smart Auto : 8 ~ 1/2,000 sec., Program : 1 ~ 1/2,000 sec.,
 Night : 8 ~ 1/2,000 sec., Fireworks : 2 sec.

Exposure - Control : Program AE
 - Metering : Multi, Spot, Center-Weighted,
 Face Detection AE
 - Compensation : $\pm 2EV$ (1/3EV steps)
 - ISO : Auto, 80, 100, 200, 400, 800, 1600

Flash - Modes : Auto, Auto & Red-eye reduction, Fill-in
 flash, Slow sync, Flash off, Red-eye Fix
 - Range : Wide : 0.2m ~ 2.68m
 Tele : 0.5m ~ 1.59m (ISO AUTO)
 - Recharging Time : Approx. 4 sec

Sharpness - Soft+, Soft, Normal, Vivid, Vivid+

White Balance - Auto, Daylight, Cloudy, Fluorescent_H,
 Fluorescent_L, Tungsten, Custom

Voice Recording - Voice Recording (max. 10 hours)
 - Voice Memo in Still Image (max. 10 sec.)

Date Imprinting - Date, Date & Time, Off (user selectable)

Shooting - Still Image
 - Mode : Smart Auto, Program, DIS, Smart Night
 Photo Help Guide, Scene
 - Scene : Beauty Shot, Frame Guide, Night, Portrait,
 Children, Landscape, Close-up, Text,
 Sunset, Dawn, Backlight, Fireworks,
 Beach & Snow
 - Smart Auto : Macro, Macro Text, White, Landscape,
 Action, Tripod, Night, Night Portrait,
 Backlight, Backlight Portrait, Portrait,
 Macro Portrait, Blue Sky, Sunset Sky,
 Macro Color, Natural Green
 - Smart Night : Night Portrait, Night
 - Shooting : Single, Continuous, Motion Capture, AEB
 - Self-timer : 10 sec., 2 sec., Double,
 Motion Timer

Specifications

- Movie clip
 - With Audio or without Audio
(user selectable, recording time : max 2 hours)
 - Size : 640x480, 320x240
 - Frame rate : 30 fps, 15 fps
 - 5X Optical Zoom and Mute in Zooming
 - Movie Editing (Embedded): Pause during recording, Still Image Capture

Storage

- Media
 - Internal memory : About 9.9MB flash memory
 - External memory (Optional) :
SD card (Up to 2GB guaranteed)
SDHC card (Up to 8GB guaranteed)
- File Format
 - Still Image : JPEG (DCF), EXIF 2.21, DPOF 1.1,
PictBridge 1.0
 - Movie clip : AVI (MJPEG)
 - Audio : WAV
- Image Size

12M	10M	9M	8M	5M	3M	2M	1M
4000x 3000	3984x 2656	3840x 2160	3264x 2448	2560x 1920	2048x 1536	1920x 1080	1024x 768

- Capacity (1GB Size)

	12M	10M	9M	8M	5M	3M	2M	1M
Super Fine	About 147	About 167	About 202	About 211	About 339	About 532	About 870	About 1471
Fine	About 284	About 309	About 367	About 374	About 566	About 802	About 1144	About 1670
Normal	About 403	About 441	About 528	About 537	About 792	About 1065	About 1437	About 1872

※ These figures are measured under Samsung standard conditions and may vary depending on shooting conditions and camera settings.

- Effect
 - Shooting : Photo Style Selector, Image Adjust (Sharpness, Contrast, Saturation)
 - Editing : Resize, Rotate, Photo Style Selector, Image Adjust (ACB, Face Retouch, Red-Eye Fix, Brightness, Contrast, Saturation, Add Noise)

- Image Play
 - Type : Single image, Thumbnails, Smart Album, Multi slide show, Movie clip

※ Multi slide show : Slide show with Effect & Music

- Interface
 - Digital output connector : USB 2.0
 - Audio : Microphone: Mono,
Internal Speaker: Mono
 - Video output : NTSC, PAL (user selectable)
 - DC power input connector : 4.2 V

Specifications

Power Source	- Rechargeable battery : BP70A, 3.7V (740mAh) ※ Included battery may vary depending on sales region.
Dimensions (WxHxD)	- 96.3 X 58.3 X 21.7mm (excluding protrusions)
Weight	- Approx. 126.2g (without battery and card)
Operating Temperature	- 0 ~ 40°C
Operating Humidity	- 5 ~ 85%
Software	- Intelli-studio, Adobe Reader

※ Specifications are subject to change without prior notice.

※ All trademarks are the property of their respective owners.

Transferring files to your computer (for Windows)

For Windows users

Transfer files by connecting your camera to your PC.

■ Installing programs

Hardware and software requirements

Item	Requirements
CPU	Intel® Pentium®4 3.0 GHz or higher AMD Athlon™ FX 2.2 GHz or higher
RAM	512 MB or more (1 GB or more recommended)
OS	Windows XP/Vista/7
Others	- USB port - CD-ROM drive - nVIDIA Geforce 7600GT or higher Ati X1600 series or higher - 1024 X 768 pixels, 16-bit color display compatible monitor (1280 X 1024 pixels, 32-bit color display recommended) - Microsoft DirectX 9.0c or later

■ Programs contained on the CD

Program	Purpose
Intelli-studio	Edit photos and videos.
Adobe Reader	View the user manual.



- Using a self-assembled PC or a PC and OS that are not supported may void your warranty.
- The programs may not work properly on 64-bit Edition of Windows XP, Vista and 7.
- Intelli-studio may not perform correctly on some computers, even when the computer meets the requirements.
- If your computer does not meet the requirements, videos may not play correctly or it may take longer to edit videos.
- Install DirectX 9.0c or above before you use the program.

Transferring files to your computer (for Windows)

1. Insert the installation CD in a compatible CD-ROM drive.
2. When the setup screen is displayed, click **Samsung Digital Camera Installer** to start installation.



3. Select programs to install and follow the onscreen instructions.
4. Click **Exit** to complete the installation and restart your computer.

■ Transferring files to your PC

Once you connect the camera to your PC, the camera will be recognized as a removable drive.



- The battery will be charged while the camera is connected to a PC with the USB cable.

1. Connect your camera to your PC with the USB cable.



- You must plug the end of the cable with the indicator light (▲) into your camera. If the cable is reversed, it may damage your files. The manufacturer is not responsible for any loss of data.

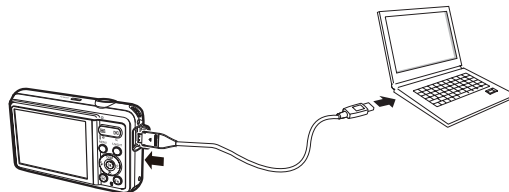

Transferring files to your computer (for Windows)

2. Turn on the camera.

- The computer recognizes the camera automatically.



- If the camera fails to connect, a pop-up window will appear. Select **Computer**.

3. On your PC, select [**My Computer** → **Removable Disk** → **DCIM** → **100PHOTO**].

4. Select the files you want and drag or save them to your PC.

■ Disconnecting the camera (for Windows XP)

The way to disconnect the USB cable for Windows Vista/7 is similar.

1. If the status lamp on your camera is blinking, wait until it stops.
2. Click  on the tool bar at the bottom right of your PC screen.



3. Click the pop-up message.
4. Remove the USB cable.

Transferring files to your computer (for Windows)

■ Using Intelli-studio

Once you have installed the Intelli-studio on your PC, the Intelli-studio starts automatically when a camera is connected with your PC. If the Intelli-studio does not start after you have connected the camera to your PC, double-click the Intelli-studio icon on your Windows desktop. The Intelli-studio allows you to play back and edit files. You can also upload files to websites, such as Flickr or YouTube. For details, select [**Help** → **Help**] in the program.



- You cannot edit files directly on the camera. Transfer files to a folder on your computer before editing.
- You cannot copy files in your computer to the camera.
- Intelli-studio supports the following formats:
 - Videos: AVI(MJPEG), MP4 (Video: H.264, Audio: AAC), WMV (WMV 7/8/9)
 - Photos: JPG, GIF, BMP, PNG, TIFF

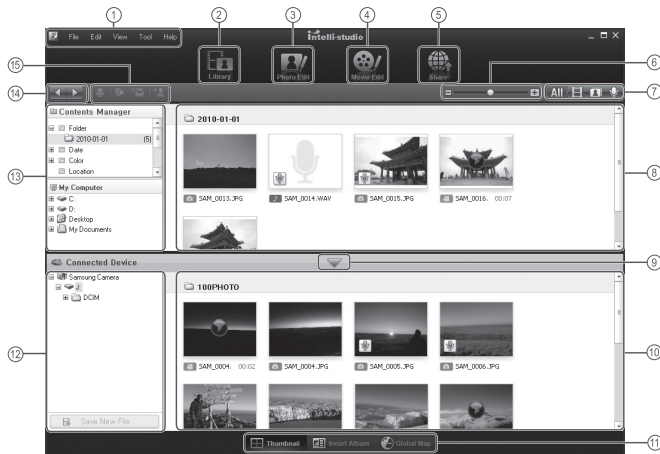

Transferring files to your computer (for Windows)

Icon	Description
1	Open menus
2	Display files in the selected folder
3	Change to the Photo edit mode
4	Change to the Video edit mode
5	Change to the Sharing mode (You can send files by email or upload files to websites, such as Flickr or YouTube.)
6	Enlarge or reduce the thumbnails in the list
7	Select a file type
8	View files of the selected folder on your computer
9	Show or hide files of the connected camera
10	View files of the selected folder on the camera
11	View files as thumbnails, in Smart Album, or on a map
12	Browse folders in the connected device
13	Browse folders in your computer
14	Move to the previous or next folder
15	Print files, view files on a map, store files in My Folder, or register faces

Transferring files to your computer (for Mac)

For Mac users

When you connect the camera to a Macintosh computer, the computer will recognize the device automatically. You can transfer files directly from the camera to the computer without installing any programs. MAC OS 10.3 or later is supported.

1. Connect your camera to a Macintosh computer with the USB cable.



- You must plug the end of the cable with the indicator light (▲) into your camera. If the cable is reversed, it may damage your files. The manufacturer is not responsible for any loss of data.

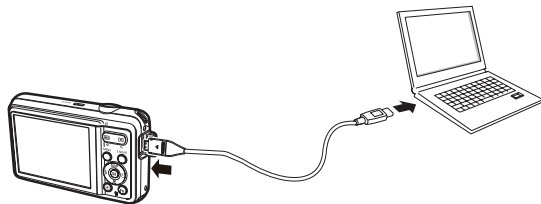

Transferring files to your computer (for Mac)

2. Turn on the camera.
 - The computer recognizes the camera automatically and a removable disk icon will be displayed.
3. Double click the removable disk icon.
4. Transfer photos or videos to the computer.

FAQ

Please check the following if the USB connection malfunctions.

Case 1 USB cable is not connected or it is not the supplied USB cable.

→ Connect the supplied USB cable.

Case 2 The camera is not recognized by your PC. Sometimes, the camera may appear under [Unknown Devices] in Device Manager.

→ Turn off the camera, remove the USB cable, plug in the USB cable again, and then turn on the camera.

Case 3 There is an unexpected error during file transfer.

→ Turn the camera power off and on again. Transfer the file again.

Case 4 When using the USB hub.

→ There may be a problem in connecting the camera to the PC through the USB hub if the PC and the hub are not compatible. Wherever possible, connect the camera to the PC directly.

Case 5 Are other USB cables connected to the PC?

→ The camera may malfunction when it is connected to the PC at the same time as another USB cable. In this case, disconnect the other USB cable, and connect only one USB cable to the camera.

Case 6 When I open the Device Manager (by clicking Start → (Settings) → Control Panel → (Performance and Maintenance) → System → (Hardware) → Device Manager), there are Unknown Devices or Other Devices entries with a yellow question mark(?) beside them or devices with an exclamation mark(!) beside them.

→ Right-click on the entry with the question(?) or exclamation (!) mark and select "Remove". Restart the PC and connect the camera again.

Case 7 In some security programs (Norton Anti Virus, V3, etc.), the computer may not recognize the camera as a removable disk.

→ Stop the security programs and connect the camera to the computer. Refer to the security program instructions about how to temporarily disable the program.

Case 8 The camera is connected to the USB port located on the front of the computer.

→ When the camera is connected to the USB port located on the front of the computer, the computer may not recognize the camera. Connect the camera to the USB port located on the back of the computer.

FAQ

- When the DirectX 9.0c or later is not installed
 - Install the DirectX 9.0c or later
 - 1) Insert the CD provided with the camera
 - 2) Run the windows explorer and select the [CD-ROM drive:\ DirectX] folder and click the DXSETUP.exe file.
The DirectX will be installed.
Visit the Microsoft website for downloading the DirectX.
- If a PC connected with the camera stops responding while Windows is starting.
 - In this case, disconnect the PC and the camera and Windows will start. If the problem happens continuously, set the Legacy USB Support to disable and re-start the PC. The Legacy USB Support is in the BIOS setup menu. (The BIOS setup menu differs from the PC manufacturers and some BIOS menus don't have Legacy USB Support) If you can't change the menu by yourself, contact to the PC manufacturer or BIOS manufacturer.

FCC notice

■ NOTE:

- This equipment has been tested and found to comply with the limits for a Class B digital device, pursuant to part 15 of the FCC Rules. These limits are designed to provide reasonable protection against harmful interference in a residential installation. This equipment generates, uses and can radiate radio frequency energy and, if not installed and used in accordance with the instructions, may cause harmful interference to radio communications. However, there is no guarantee that interference will not occur in a particular installation. If this equipment does cause harmful interference to radio or television reception, which can be determined by turning the equipment off and on, the user is encouraged to try to correct the interference by one or more of the following measures:
- Reorient or relocate the receiving antenna.
 - Increase the distance between the equipment and receiver.
 - Connect the equipment into an outlet on a circuit different from that to which the receiver is connected.
 - Consult the dealer or an experienced radio / TV technician for help.

■ CAUTION:

Changes or modifications not expressly approved by the manufacturer responsible for compliance could void the user's authority to operate the equipment.

FCC notice

■ Declaration of Conformity

Trade Name : SAMSUNG ELECTRONICS AMERICA, INC.
Model No. : Samsung SL605
Responsible Party: SAMSUNG ELECTRONICS AMERICA, INC.
Address : 105 Challenger Road Ridgefield Park NJ
Telephone No. : 1-800-SAMSUNG(726-7864)

This device complies with Part 15 of the FCC Rules. Operation is subject to the following two conditions: (1) This device may not cause harmful interference, and (2) this device must accept any interference received, including interference that may cause undesired operation.



Samsung Eco-mark

It is Samsung's own symbol mark is used to effectively communicate Samsung's environmental friendly product activities to the consumers. The mark represents Samsung's continuous effort on development of environmental conscious products.



Please refer to the warranty that came with the product you purchased,
or go to our website <http://www.samsung.com/> for after-sales service or inquiries.

