

SyncMaster 933HD Plus

LCD TV MONITOR

user manual

imagine the possibilities

Thank you for purchasing this Samsung product.
To receive more complete service, please
register your product at

www.samsung.com/register

Model _____ Serial No. _____



❑ Important Warranty Information Regarding Television Format Viewing

- ☑ See the warranty card for more information on warranty terms.

Wide screen format LCD Displays (16:9, the aspect ratio of the screen width to height) are primarily designed to view wide screen format full-motion video. The images displayed on them should primarily be in the wide screen 16:9 ratio format, or expanded to fill the screen if your model offers this feature and the images are constantly moving. Displaying stationary graphics and images on screen, such as the dark sidebars on nonexpanded standard format television video and programming, should be limited to no more than 5% of the total television viewing per week.

Additionally, viewing other stationary images and text such as stock market reports, video game displays, station logos, web sites or computer graphics and patterns, should be limited as described above for all televisions. Displaying stationary images that exceed the above guidelines can cause uneven aging of LCD Displays that leave subtle, but permanent burned-in ghost images in the LCD picture. To avoid this, vary the programming and images, and primarily display full screen moving images, not stationary patterns or dark bars.

On LCD models that offer picture sizing features, use these controls to view different formats as a full screen picture.

Be careful in the selection and duration of television formats used for viewing. Uneven LCD aging as a result of format selection and use, as well as burned-in images, are not covered by your Samsung limited warranty.

❑ Precautions When Displaying a Still Image

A still image may cause permanent damage to the TV screen

- Do not display a still image on the LCD panel for more than 2 hours as it can cause screen image retention. This image retention is also known as "screen burn". To avoid such image retention, reduce the degree of brightness and contrast of the screen when displaying a still image.
-  Watching the LCD TV in 4:3 format for a long period of time may leave traces of borders displayed on the left, right and center of the screen caused by the difference of light emission on the screen. Playing a DVD or a game console may cause a similar effect to the screen. Damages caused by the above effect are not covered by the Warranty.
- Displaying still images from Video games and PC for longer than a certain period of time may produce partial after-images.
To prevent this effect, reduce the 'brightness' and 'contrast' when displaying still images.

CONTENTS

General Information

- Accessories 2
- Viewing the Control Panel 2
- Viewing the Connection Panel 3
- Remote Control 4
- Installing Batteries in the Remote Control ... 4

Connections

- Connecting VHF and UHF Antennas 5
- Connecting Cable TV 6
- Connecting a DVD / Blu-Ray player / Satellite receiver (Set-Top Box) via HDMI ... 7
- Connecting a DVD / Blu-Ray player / Satellite receiver (Set-Top Box) via DVI 8
- Connecting a VCR 8
- Connecting a Camcorder 9
- Connecting a PC 10

Operation

- Turning the TV On and Off 11
- Plug & Play Feature 11

CHANNEL CONTROL

- Configuring the Channel Menu 12
- Managing Channels 13

Picture Control

- Configuring the Picture Menu (TV / AV / HDMI) 15
- Using Your TV as a Computer (PC) Display 18
- Setting up the TV with your PC 19

Sound Control

- Configuring the Sound Menu 20

Setup

- Configuring the Setup Menu 21

Input / Support

- Configuring the Input Menu 26
- Configuring the Support Menu 27

Anynet+

- Connecting Anynet+ Devices 28
- Setting Up Anynet+ 29
- Switching between Anynet+ Devices 30
- Troubleshooting for Anynet+ 31

Installing the Software

- Installing the Device Driver 32
- Natural Color 32
- MultiScreen 33

Appendix

- TV Monitor Self-Diagnosis 34
- Troubleshooting 34
- FAQ 36
- Installing the Stand 37
- Disconnecting the Stand 37
- Wall Mount Kit Specifications (VESA) 37
- Using the Anti-Theft Kensington Lock 38
- Securing the Installation Space 39
- Specifications 40
- Power Saving Function 40

□ License



Manufactured under license from Dolby Laboratories. Dolby and the double-D symbol are trademarks of Dolby Laboratories.

□ Symbol



Note



One-Touch Button



TOOLS Button

GENERAL INFORMATION

Accessories

Please make sure the following items are included with your LCD TV. If any items are missing, contact your dealer.



Remote Control / Batteries (AAA x 2) (Not available in all locations) / Power Cord / Cleaning Cloth / User Manual (CD, Book) / Quick Setup Guide / Warranty Card (Not available in all locations) / Cable holder / Stand Base

- ☑ The items color and shape may vary depending on the model.
- ☑ Cleaning Cloth is only provided for highly polished black products as a product feature.

Viewing the Control Panel

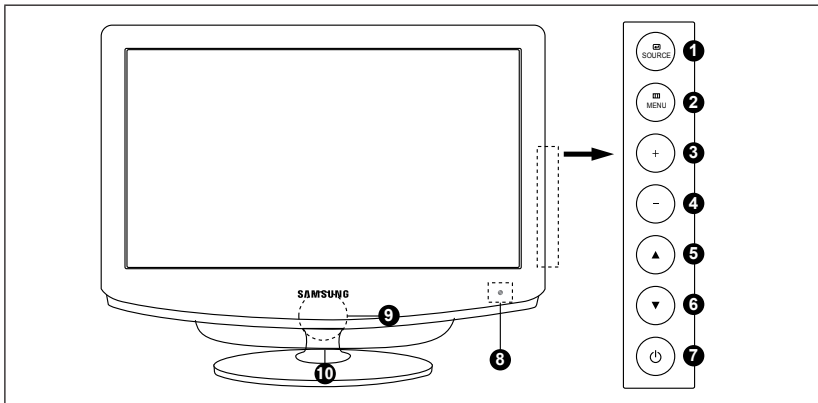
- ☑ The product color and shape may vary depending on the model.



- ❶ **SOURCE** : Toggles between all the available input sources. In the on-screen menu, use this  button as you use the button on the remote control.
- ❷ **MENU** : Press to see an on-screen menu of your TV's features.
- ❸, ❹ **+ / -**: Moves from one menu item to another horizontally or adjusts selected menu values. Adjusts the audio volume.
- ❺, ❻ **▲, ▼**: Moves from one menu item to another vertically or adjusts selected menu values. In TV mode, selects TV channels.
- ❼ **⏻ (POWER)**: Press to turn the TV on and off.
- ❽ **REMOTE CONTROL SENSOR**: Aim the remote control towards this spot on the TV.
- ❾ **POWER INDICATOR**: Blinks and turns off when the power is on and lights up in stand-by mode.
- ❿ **SPEAKERS**

Viewing the Connection Panel

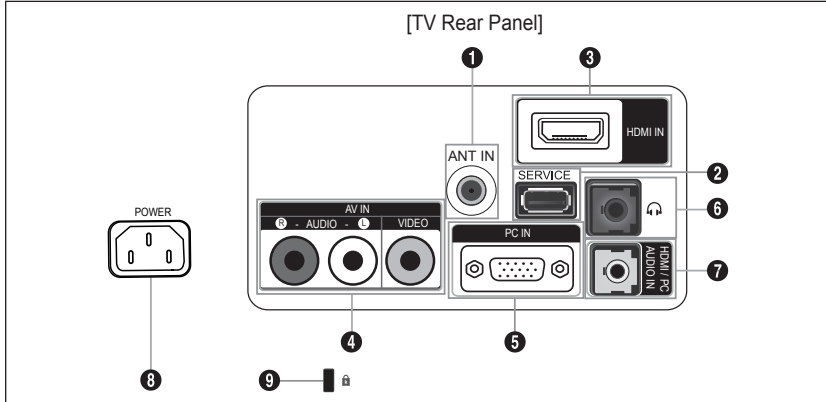

 The product color and shape may vary depending on the model.

1 ANT IN

- Connects to an antenna or cable TV system.

2 SERVICE

- Connector for service only.

3 HDMI IN

- Connects to the HDMI jack of a device with an HDMI output.
 No sound connection is needed for an HDMI to HDMI connection.

4 AV IN

- Video and audio inputs for external devices, such as a camcorder or VCR.

5 PC IN

- Connects to the video jacks on your PC.

6

- Connect your headphones to the Headphone connection terminal.

7 HDMI / PC AUDIO IN

- Connect the HDMI / PC AUDIO IN terminal at the back of your product to your computer's sound card.

8 POWER INPUT

- Connects the supplied power cord.



9 KENSINGTON LOCK

- The Kensington Lock (optional) is a device used to physically fix the system when used in a public place. If you want to use a locking device, contact the dealer where you purchased the TV.

 The location of the Kensington Lock may be different depending on its model.

Remote Control

- ☑ You can use the remote control up to a distance of about 23 feet from the TV.
- ☑ The performance of the remote control may be affected by bright light.

- 1 **POWER**: Turns the TV on and off.
- 2 **NUMERIC BUTTONS**: Press to change the channel.
- 3 **—**: Press to select additional channels (digital) being broadcast by the same station. For example, to select channel '54-3', press '54', then press '-' and '3'.
- 4 **VOL + / VOL -**: Press to increase or decrease the volume.
- 5 **CH LIST**: Used to display Channel Lists on the screen.
- 6 **TOOLS**: Use to quickly select frequently used functions.
- 7 **UP ▲ / DOWN ▼ / LEFT ◀ / RIGHT ▶ / **: Use to select on-screen menu items and change menu values.
- 8 **INFO**: Press to display information on the TV screen.
- 9 **COLOR BUTTONS**: Use these buttons in the Channel list, etc.
- 10 **P.SIZE**: Picture size selection.
- 11 **MTS**: Press to choose stereo, mono or Separate Audio Program (SAP broadcast).
- 12 **TV**: Selects the TV mode directly.
- 13 **PRE-CH**: This button is used to return to the previous channel viewed.
- 14 **MUTE **: Press to temporarily cut off the sound.
- 15 **^ CH v**: Press to change channels.
- 16 **SOURCE**: Press to display and select the available video sources.
- 17 **FAV.CH**: Press to switch to your favorite channels.
- 18 **MENU **: Displays the main on-screen menu.
- 19 **RETURN**: Returns to the previous menu.
- 20 **EXIT**: Press to exit the menu.
- 21 **CC**: Controls the caption decoder.

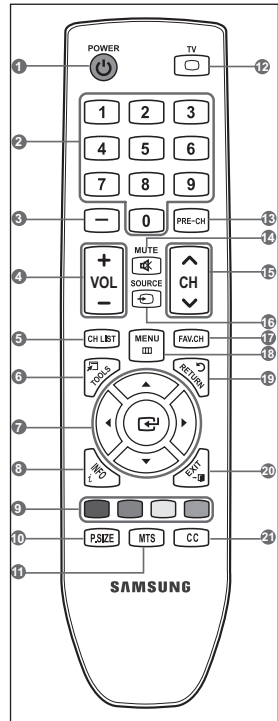

Installing Batteries in the Remote Control

1. Lift the cover at the back of the remote control upward as shown in the figure.
2. Install two AAA size batteries.
 - ☑ Make sure to match the "+" and "-" ends of the batteries with the diagram inside the compartment.
3. Replace the cover.

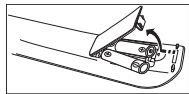

- ☑ Remove the batteries and store them in a cool, dry place if you won't be using the remote control for a long time. (Assuming typical TV usage, the batteries should last for about one year.)
- ☑ If the remote control doesn't work, check the following:
 - Is the TV power on?
 - Are the plus and minus ends of the batteries reversed?
 - Are the batteries drained?
 - Is there a power outage or is the power cord unplugged?
 - Is there a special fluorescent light or neon sign nearby?

CONNECTIONS

Connecting VHF and UHF Antennas

If your antenna has a set of leads that look like the diagram to the right, see 'Antennas with 300 Ω Flat Twin Leads' below.

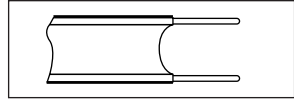

If your antenna has one lead that looks like the diagram to the right, see 'Antennas with 75 Ω Round Leads'.

If you have two antennas, see 'Separate VHF and UHF Antennas'.

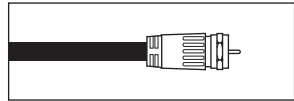

Antennas with 300 Ω Flat Twin Leads

If you are using an off-air antenna (such as a roof antenna or 'rabbit ears') that has 300 Ω twin flat leads, follow the directions below.

1. Place the wires from the twin leads under the screws on a 300-75 Ω adaptor (not supplied). Use a screwdriver to tighten the screws.
2. Plug the adaptor into the **ANT IN** terminal on the back of the TV.

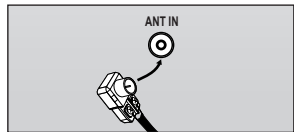
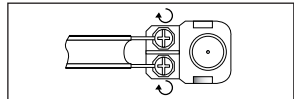

Antennas with 75 Ω Round Leads

Plug the antenna lead into the **ANT IN** terminal on the back of the TV.

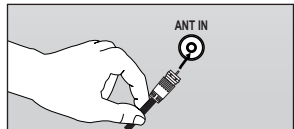

Separate VHF and UHF Antennas

If you have two separate antennas for your TV (one VHF and one UHF), you must combine the two antenna signals before connecting the antennas to the TV. This procedure requires an optional combiner-adaptor (available at most electronics shops).

1. Connect both antenna leads to the combiner.
2. Plug the combiner into the **ANT IN** terminal on the bottom of the rear panel.

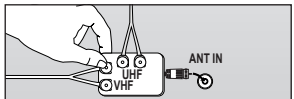
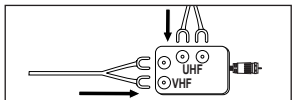

Connecting Cable TV

To connect to a cable TV system, follow the instructions below.

Cable without a Cable Box

Plug the incoming cable into the **ANT IN** terminal on the back of the TV.

- ☑ Because this TV is cable-ready, you do not need a cable box to view unscrambled cable channels.

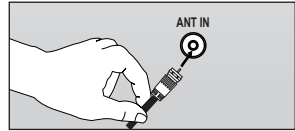

Connecting to a Cable Box that Descrambles All Channels

1. Find the cable that is connected to the **ANT OUT** terminal on your cable box.

- ☑ This terminal might be labeled 'ANT OUT', 'VHF OUT' or simply, 'OUT'.

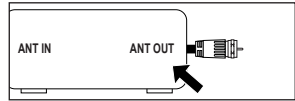

2. Connect the other end of this cable to the **ANT IN** terminal on the back of the TV.

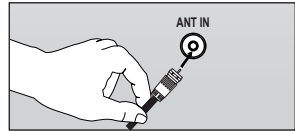

Connecting to a Cable Box that Descrambles Some Channels

If your cable box descrambles only some channels (such as premium channels), follow the instructions below. You will need a two-way splitter, an RF (A/B) switch and four lengths of RF cable. (These items are available at most electronics stores.)

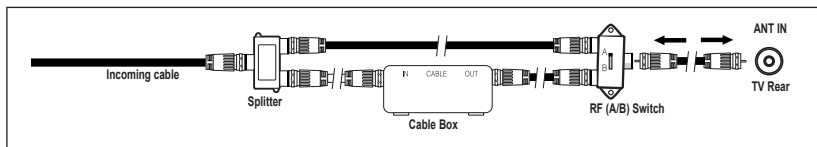

1. Find and disconnect the cable that is connected to the **ANT IN** terminal on your cable box.
 - ☑ This terminal might be labeled 'ANT IN', 'VHF IN' or simply, 'IN'.
2. Connect this cable to a two-way splitter.
3. Connect an RF cable between the **OUTPUT** terminal on the splitter and the **IN** terminal on the cable box.
4. Connect an RF cable between the **ANT OUT** terminal on the cable box and the **B-IN** terminal on the **RF(A/B) switch**.
5. Connect another cable between the other **OUT** terminal on the splitter and the **A-IN** terminal on the **RF (A/B) switch**.
6. Connect the last RF cable between the **OUT** terminal on the **RF (A/B) switch** and the **ANT IN** terminal on the rear of the TV.

After you have made this connection, set the A/B switch to the 'A' position for normal viewing. Set the A/B switch to the 'B' position to view scrambled channels. (When you set the A/B switch to 'B', you will need to tune your TV to the cable box's output channel, which is usually channel 3 or 4.)

Connecting a DVD / Blu-Ray player / Satellite receiver (Set-Top Box) via HDMI

This connection can only be made if there is an HDMI Output connector on the external device.

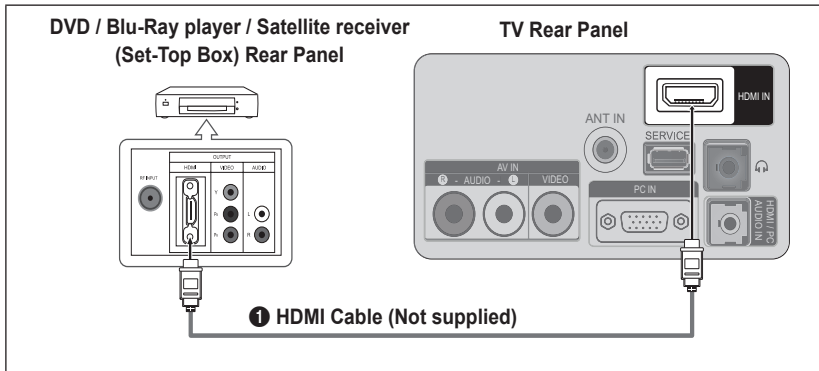

What is HDMI?

- HDMI (High-Definition Multimedia Interface), is an interface that enables the transmission of digital audio and video signals using a single cable.
- The difference between HDMI and DVI is that the HDMI device is smaller in size and has the HDCP (High Bandwidth Digital Copy Protection) coding feature installed.
- ☑ Each DVD / Blu-Ray player / Satellite receiver (Set-Top Box) has a different back panel configuration.
- ☑ The TV may not output sound and pictures may be displayed with abnormal color when DVD / Blu-Ray player / Satellite receiver (Set-Top Box) supporting HDMI versions older than 1.3 are connected. When connecting an older HDMI cable and there is no sound, connect the HDMI cable to the **HDMI IN** jack and the audio cables to the **HDMI / PC AUDIO IN** jacks on the back of the TV. If this happens, contact the company that provided the DVD / Blu-Ray player / Satellite receiver (Set-Top Box) to confirm the HDMI version, then request an upgrade.
- ☑ HDMI cables that are not 1.3 may cause annoying flicker or no screen display.

Connecting a DVD / Blu-Ray player / Satellite receiver (Set-Top Box) via DVI

This connection can only be made if there is a DVI Output connector on the external device.

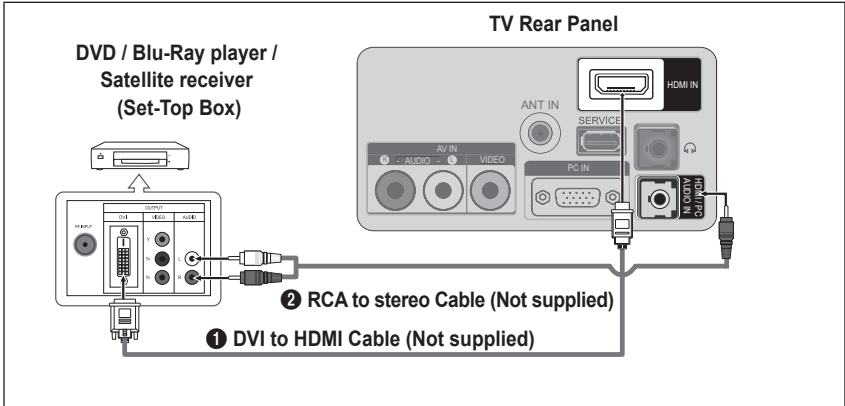

- Each DVD / Blu-Ray player / Satellite receiver (Set-Top Box) has a different back panel configuration.
- When connecting a DVD / Blu-Ray player / Satellite receiver (Set-Top Box), match the color of the connection terminal to the cable.

Connecting a VCR

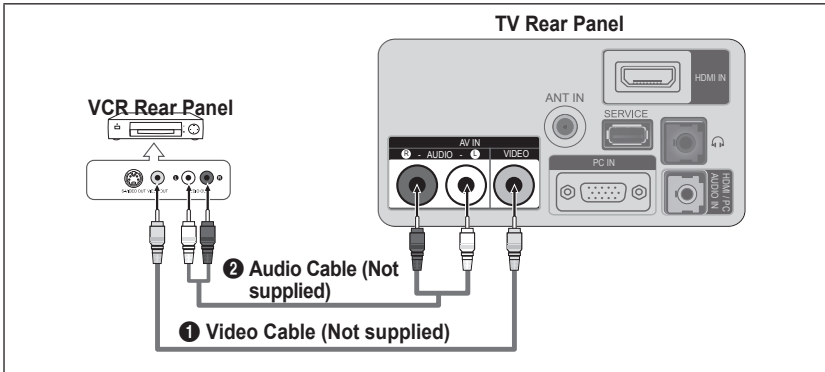

- If you have a 'mono' (non-stereo) VCR, use a Y-connector (not supplied) to connect to the right and left audio input jacks of the TV. Alternatively, connect the cable to the 'R' jack. If your VCR is stereo, you must connect two cables.
- Each VCR has a different back panel configuration.
- When connecting a VCR, match the color of the connection terminal to the cable.

Connecting a Camcorder

Using a Video Cable

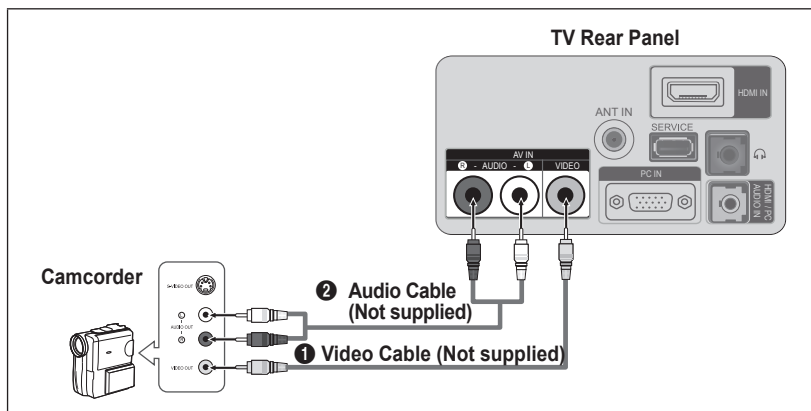

- ✓ Each Camcorder has a different back panel configuration.
- ✓ When connecting a Camcorder, match the color of the connection terminal to the cable.

Using an HDMI Cable

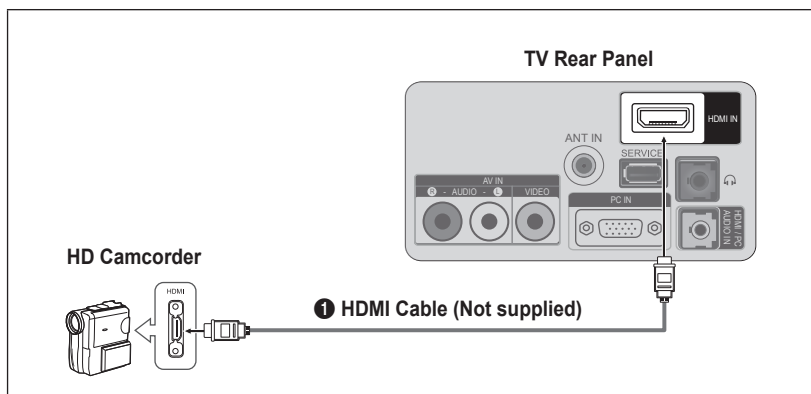

1. Connect an HDMI Cable between the HDMI IN jack on the TV and the HDMI OUT jack on the camcorder.

Connecting a PC

Using the D-Sub Cable

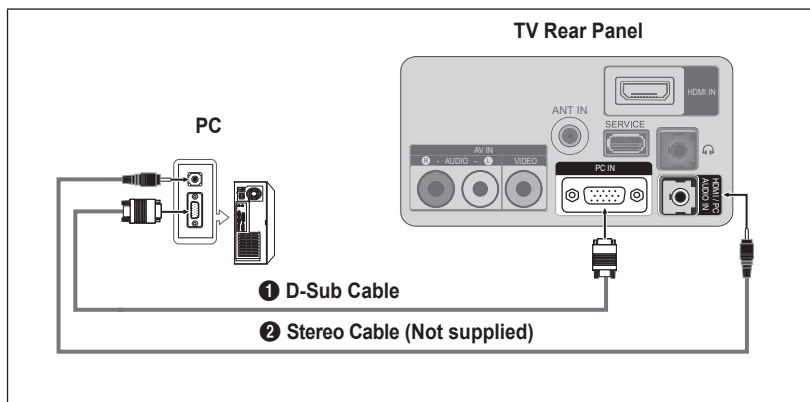

☑ When connecting a PC, match the color of the connection terminal to the cable.

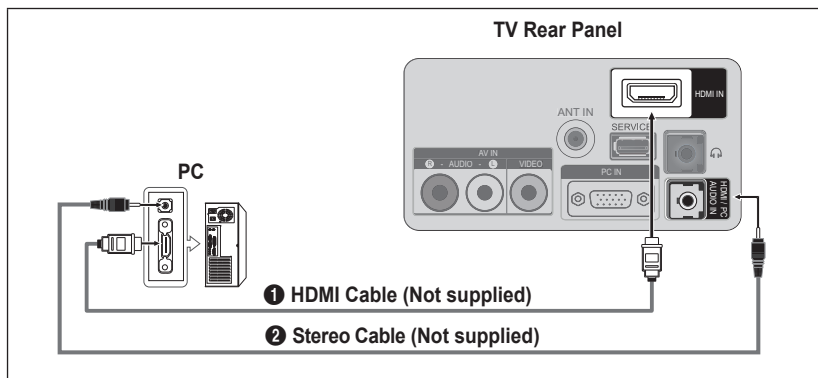

Using the HDMI Cable



☑ Each PC has a different back panel configuration.

OPERATION

Turning the TV On and Off



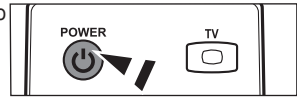





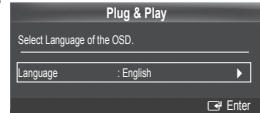



















Press the **POWER**  button on the remote control. You can also use the  button on the TV.













Plug & Play Feature

When the TV is initially powered on, basic settings proceed automatically and subsequently.



1. Press the **POWER**  button on the remote control.
 -  You can also use the  button on the TV.
2. Press the  button, then **Select Language of the OSD.** menu is automatically displayed.
3. Press the  or  button to select language, then press the  button. The message **Select 'Home Use' when installing this TV in your home.** is displayed.
4. Press the  or  button to select **Store Demo** or **Home Use**, then press the  button. The message **Select the Antenna source to memorize.** is displayed.
 -  We recommend setting the TV to **Home Use** mode for the best picture in your home environment.
 -  **Store Demo** mode is only intended for use in retail environments. If the unit is accidentally set to **Store Demo** mode and you want to return to **Home Use** (Standard): Press the volume button on the TV. When the volume OSD is displayed, press and hold the **MENU** button on the TV for 5 seconds.
5. Press the  or  button to memorize the channels of the selected connection. Press the  button to select **Start**.
 -  **Air:** **Air** antenna signal. / **Cable:** **Cable** antenna signal. / **Auto:** **Air** and **Cable** antenna signals.
 -  In Cable mode, you can select the correct signal source among **STD**, **HRC**, and **IRC** by pressing the , ,  or  button, then press the  button. If you have Digital cable, select the cable system signal source for both Analog and Digital. Contact your local cable company to identify the type of cable system that exists in your particular area.
6. Press the  button to select **Start**. The TV will begin memorizing all of the available channels.
 -  To stop the search before it has finished, press the  button with **Stop** selected.
 -  After all the available channels are stored, it starts to remove scrambled channels. The Auto program menu then reappears. Press the  button when channel memorization is complete. The message **Set the Clock Mode.** is displayed.
7. Press the  button.

Press the  or  button to select **Auto**, then Press the  button. The message **Set to daylight saving time.** is displayed. If you select **Manual**, **Set current date and time** is displayed.
8. Press the  or  button to select **Off**, **On** or **Auto**, then press the  button.
9. Press the  or  button to highlight the time zone for your local area. Press the  button. If you have received a digital signal, the time will be set automatically.
10. The connection method to provide the best quality HD is offered. After confirming the method, press the  button.
11. The message **Enjoy your TV.** is displayed. When you have finished, press the  button.

If you want to reset this feature...

1. Press the **MENU** button to display the menu. Press the **▲** or **▼** button to select **"Setup"**, then press the **☑** button.
2. Press the **☑** button again to select **"Plug & Play"**. For further details on setting up options.
 - ☑ The **"Plug & Play"** feature is only available in the TV mode.

CHANNEL CONTROL

Configuring the Channel Menu

☐ Antenna → Air / Cable

Before your television can begin memorizing the available channels, you must specify the type of signal source that is connected to the TV (i.e. an Air or a Cable system).

- ☑ Press the **TOOLS** button to display **"Tools"** menu. You can also set the Antenna by selecting **"Tools → Switch to Cable (or Switch to Air)"**.



☐ Auto Program

- **Air: Air antenna signal. / Cable: Cable antenna signal. / Auto: Air and Cable antenna signals**

- ☑ When selecting the Cable TV system: Selects the cable system. STD, HRC and IRC identify various types of cable TV systems. Contact your local cable company to identify the type of cable system that exists in your particular area. At this point the signal source has been selected.
- ☑ After all the available channels are stored, it starts to remove scrambled channels (Clearing Scrambled Channels). The Auto program menu then reappears.
- ☑ If you want to stop Auto Programming, press the **☑** button. The **"Stop Auto Program?"** message will be displayed. Select **"Yes"** by pressing the **◀** or **▶** button, then press the **☑** button.

☐ Clearing Scrambled Channels (digital channels only)

This function is used to filter out scrambled channels after **"Auto Program"** is completed. This process may take up to 20~30 minutes.

- ☑ To stop searching scrambled channels: Press the **☑** button to select **"Stop"**. Press the **◀** button to select **"Yes"**, then press the button.
- ☑ This function is only available in **"Cable"** mode.

☐ Channel List

For the detailed procedures on using the **"Channel List"**, refer to the **'Managing Channels'** instructions.

- ☑ You can select these options by simply pressing the **CH LIST** button on the remote control.

☐ Fine Tune (analog channels only)

Use fine tuning to manually adjust a particular channel for optimal reception.

- ☑ If you do not store the fine-tuned channel in memory, adjustments are not saved.
- ☑ **"**"** will appear next to the name of fine-tuned channels.
- ☑ To reset the fine tuning setting, press the **▼** button to select **"Reset"**, then press the **☑** button.

Managing Channels

Channel List

Using this menu, you can add / delete or set favorite channels and use the program guide for digital broadcasts.

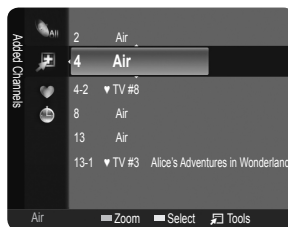

All Channels

Shows all currently available channels.

Added Channels

Shows all added channels.

Favorite

Shows all favorite channels.

To select the favorite channels you have set up, press the **FAV.CH** button on the remote control.

Programmed

Shows all current reserved Programs.

Select a channel in the **All Channels**, **Added Channels** or **Favorite** screen by pressing the ▲ / ▼ buttons, and pressing the . Then you can watch the selected channel.

Using the Color buttons with the Channel List

- **Green (Zoom):** Enlarges or shrinks a channel number.
- **Yellow (Select):** Selects multiple channel lists. You can perform the add / delete or add to Favorite / delete from Favorite function for multiple channels at the same time. Select the required channels and press the yellow button to set all the selected channels at the same time. The ✓ mark appears to the left of the selected channels.
- **TOOLS (Tools):** Displays the **Add** (or **Delete**), **Add to Favorite** (or **Delete from Favorite**), **Timer Viewing**, **Channel Name Edit**, **Select All** (or **Deselect All**) and **Auto Program** menus (The Options menus may differ depending on the situation.)

Channel Status Display Icons

- ♥ : A channel set as a Favorite.
- ✓ : A channel selected by pressing the yellow button.
- : A Program currently being broadcast.
- : A reserved program

Channel List Option Menu (in All Channels / Added Channels / Favorite)

Press the **TOOLS** button to use the option menu.

Option menu items may differ depending on the channel status.

Add / Delete

You can delete or add a channel to display the channels you want.

All deleted channels will be shown on **All Channels** menu.

A gray-colored channel indicates the channel has been deleted.

The **Add** menu only appears for deleted channels.

You can also delete a channel from the **Added Channels** or **Favorite** menu in the same manner.

■ Add to Favorite / Delete from Favorite

You can set channels you watch frequently as Favorite.

- ✎ Press the **TOOLS** button to display the Tools menu. You can also set the add to (or delete from) Favorites by selecting **Tools** → **Add to Favorite** (or **Delete from Favorite**).

- ☑ The ♥ symbol will be displayed and the channel will be set as a favorite.
- ☑ All favorite channels will be shown in the **Favorite** menu.

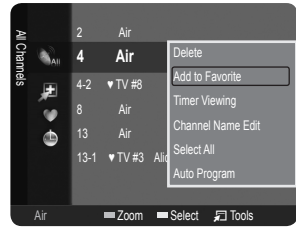

■ Timer Viewing

If you reserve a program you want to watch, the channel is automatically switched to the reserved channel in the Channel List; even when you are watching another channel. To reserve a program, set the current time first.

- ☑ Only memorized channels can be reserved.
- ☑ You can set the channel, month, day, year, hour and minute directly by pressing the number buttons on the remote control.
- ☑ Reserving a program will be shown in the **Programmed** menu.
- ☑ **Digital Program Guide and Viewing Reservation**
- ☑ When a digital channel is selected, and you press the ► button, the Program Guide for the channel appears. You can reserve a program according to the procedures described above.

■ Channel Name Edit (analog channels only)

Channels can be labeled so that their call letters appear whenever the channel is selected.

- ☑ The names of digital broadcasting channels are automatically assigned and cannot be labeled.

■ Select All / Deselect All

- **Select All**: You can select all the channels in the channel list.
- **Deselect All**: You can deselect all the selected channels.

- ☑ You can only select **Deselect All** when there is a selected channel.

■ Auto Program

- ☑ For further details on setting up options, refer to page 12.

Channel List Option Menu (in Programmed)

You can view, modify or delete a reservation.

- ☑ Press the **TOOLS** button to use the option menu.

■ Change Info

Select to change a viewing reservation.

■ Cancel Schedules

Select to cancel a viewing reservation.

■ Information

Select to view a viewing reservation. (You can also change the reservation information.)

■ Select All

Select all reserved Programs.

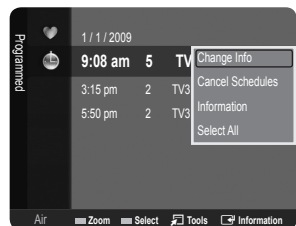

PICTURE CONTROL

Configuring the Picture Menu (TV / AV / HDMI)

Mode

You can select the type of picture which best corresponds to your viewing requirements.

Dynamic

Selects the picture for increased definition in a bright room.

Standard

Selects the picture for the optimum display in a normal environment.

Movie

Selects the picture for viewing movies in a dark room.

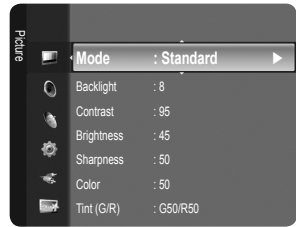

Backlight / Contrast / Brightness / Sharpness / Color / Tint (G/R)

Your television has several setting options that allow you to control the picture quality.

- **Backlight:** Adjusts the brightness of LCD back light.
 - **Contrast:** Adjusts the contrast level of the picture.
 - **Brightness:** Adjusts the brightness level of the picture
 - **Sharpness:** Adjusts the edge definition of the picture.
 - **Color:** Adjusts color saturation of the picture.
 - **Tint (G/R):** Adjusts the color tint of the picture.
- When you make changes to “**Backlight**”, “**Contrast**”, “**Brightness**”, “**Sharpness**”, “**Color**” or “**Tint (G/R)**” the OSD will be adjusted accordingly.
- Settings can be adjusted and stored for each external device you have connected to an input of the TV.
- The energy consumed during use can be significantly reduced if the level of Backlight is reduced, and that this will reduce the overall running cost.

Advanced Settings

Samsung's new TVs allow you to make even more precise picture settings than previous models.

- Advanced Settings** is available in **Standard** or **Movie** mode.
- In PC mode, you can only make changes to **Gamma** and **White Balance** from among the **Advanced Settings** items.

Black Tone → Off / Dark / Darker / Darkest

You can select the black level on the screen to adjust the screen depth.

Dynamic Contrast → Off / Low / Medium / High

You can adjust the screen contrast so that the optimal contrast is provided.

Gamma

You can adjust the primary color (red, green, blue) Intensity. (-3 ~ +3)

Color Space

Color space is a color matrix composed of red, green and blue colors. Select your favorite color space to experience the most natural color.

- **Native:** Native Color Space offers deep and rich color tone.
- **Auto:** Auto Color Space automatically adjusts to the most natural color tone based on program sources.

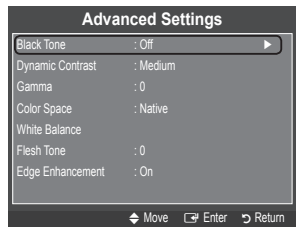

■ White Balance

You can adjust the color temperature for more natural picture colors.

- **R-Offset / G-Offset / B-Offset / R-Gain / G-Gain / B-Gain:** You can adjust the Color 'temperature' in the light areas by changing the values of R, G, B. Recommended for advanced users only.
- **Reset:** The previously adjusted white balance will be reset to the factory defaults.
- ☑ Changing the adjustment value will refresh the adjusted screen.

■ Flesh Tone

You can emphasize the pink 'flesh tone' in the picture.

- ☑ Changing the adjustment value will refresh the adjusted screen.

■ Edge Enhancement → Off / On

You can emphasize object boundaries in the picture.

□ Picture Options

- ☑ In PC mode, you can only make changes to the "Color Tone" and "Size" from among the items in "Picture Options".

■ Color Tone → Cool / Normal / Warm1 / Warm2

- ☑ **Warm1** or **Warm2** is only activated when the picture mode is **Movie**.
- ☑ Settings can be adjusted and stored for each external device you have connected to an input of the TV.

■ Size

Occasionally, you may want to change the size of the image on your screen. Your TV comes with six screen size options, each designed to work best with specific types of video input. Your satellite receiver may have its own set of screen sizes as well. In general, though, you should view the TV in 16:9 mode as much as possible.

- ☑ Alternately, you can press the **P.SIZE** button on the remote control repeatedly to change the picture size.

- **16:9** : Sets the picture to 16:9 wide mode.
- **Zoom1**: Magnifies the size of the picture on the screen.
- **Zoom2**: Magnifies the size of the picture more than "Zoom1".
- **Wide Fit**: Enlarges the aspect ratio of the picture to fit the entire screen.
- **4:3** : Sets the picture to 4:3 normal mode.
- **Screen Fit**: Use the function to see the full image without any cutoff when HDMI (720p/1080i/1080p) or DTV (1080i) signals are input.

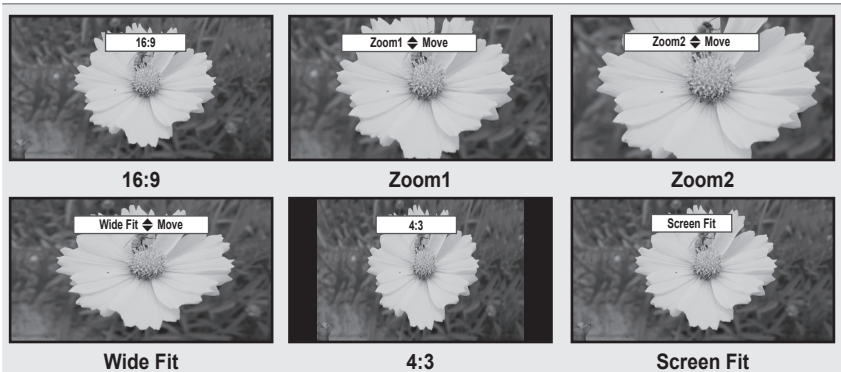
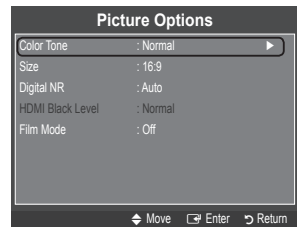

- ☑ Temporary image retention may occur when viewing a static image on the set for more than two hours.
- ☑ After selecting "**Zoom1**", "**Zoom2**" or "**Wide Fit**": Press the ◀ or ▶ button to select "**Position**", then press the ⏏ button. Press the ▲ or ▼ button to move the picture up and down.
Reset: Press the ◀ or ▶ button to select "**Reset**", then press the ⏏ button. You can initialize the setting.
- ☑ HD (High Definition): 16:9 - 1080i/1080p (1920x1080), 720p (1280x720)
- ☑ Settings can be adjusted and stored for each external device you have connected to an input of the TV.

Input Source	Picture Size
TV, AV	16:9, Zoom1, Zoom2, 4:3
DTV(1080i), HDMI (720p, 1080i, 1080P)	16:9, 4:3, Wide Fit, Screen Fit

■ Digital NR → Off / Low / Medium / High / Auto

If the broadcast signal received by your TV is weak, you can activate the Digital Noise Reduction feature to help reduce any static and ghosting that may appear on the screen.

- ☑ When the signal is weak, select one of the other options until the best picture is displayed.

■ HDMI Black Level → Normal / Low

You can select the black level on the screen to adjust the screen depth.

- ☑ This function is active only when an external device is connected to the TV via HDMI. The "**HDMI Black Level**" function may not be compatible with all external devices.

■ Film Mode → Off / Auto

The TV can be set to automatically sense and process film signals from all sources and adjust the picture for optimum quality.

- ☑ "**Film Mode**" is supported in TV and HDMI (480i / 1080i).

□ Reset → Reset Picture Mode / Cancel

Resets all picture settings to the default values.

- ☑ **Reset Picture Mode:** Current picture values return to default settings.

Using Your TV as a Computer (PC) Display

Setting Up Your PC Software (Based on Windows XP)

The Windows display-settings for a typical computer are shown below. The actual screens on your PC will probably be different, depending upon your particular version of Windows and your particular video card. However, even if your actual screens look different, the same basic set-up information will apply in almost all cases. (If not, contact your computer manufacturer or Samsung Dealer.)

1. First, click on 'Control Panel' on the Windows start menu.
2. When the control panel window appears, click on 'Appearance and Themes' and a display dialog-box will appear.
3. When the control panel window appears, click on 'Display' and a display dialog-box will appear.
4. Navigate to the 'Settings' tab on the display dialog-box.

The correct size setting (resolution): Optimum: 1360 X 768 pixels

If a vertical frequency option exists on your display settings dialog box, the correct value is "60" or "60 Hz". Otherwise, just click "OK" and exit the dialog box.

Display Modes

If the signal from the system equals the standard signal mode, the screen is adjusted automatically. If the signal from the system doesn't equal the standard signal mode, adjust the mode by referring to your videocard user guide; otherwise there may be no video. For the display modes listed below, the screen image has been optimized during manufacturing.

■ Timing modes(PC, DVI-D and HDMI input)

Mode	Resolution	Horizontal Frequency (kHz)	Vertical Frequency (Hz)	Pixel Clock Frequency (MHz)	Sync Polarity (H / V)
IBM	640 x 350	31.469	70.086	25.175	+ / -
	640 x 480	31.469	59.940	25.175	- / -
	720 x 400	31.469	70.087	28.322	- / +
MAC	640 x 480	35.000	66.667	30.240	- / -
	832 x 624	49.726	74.551	57.284	- / -
VESA	640 x 480	37.861	72.809	31.500	- / -
	640 x 480	37.500	75.000	31.500	- / -
	800 x 600	35.156	56.250	36.000	+ / +
	800 x 600	37.879	60.317	40.000	+ / +
	800 x 600	48.077	72.188	50.000	+ / +
	800 x 600	46.875	75.000	49.500	+ / +
	1024 x 768	48.363	60.004	65.000	- / -
	1024 x 768	56.476	70.069	75.000	- / -
	1024 x 768	60.023	75.029	78.750	+ / +
	1360 x 768	47.712	60.015	85.500	+ / +

Setting up the TV with your PC

Preset: Press the **SOURCE** button to select PC mode.

MagicBright : Entertain / Internet / Text / Dynamic Contrast / Custom

MagicBright is a feature providing optimum viewing environment depending on the contents of the image you are watching. Currently five different modes are available: Entertain, Internet, Text, Dynamic Contrast and Custom. Each mode has its own pre-configured brightness value.

Contrast / Brightness / Sharpness

- Contrast: Adjusts the contrast level of the picture.
- Brightness: Adjusts the brightness level of the picture.
- Sharpness: Adjusts the edge definition of the picture.

Auto Adjustment

Use the Auto Adjust function to have the TV set automatically adjust the video signals it receives. The function also automatically fine-tunes the settings and adjusts the frequency values and positions.

Press the **TOOLS** button to display "Tools" menu. You can also set the Auto Adjustment by selecting "**Tools → Auto Adjustment**".

This function do work in PC mode only

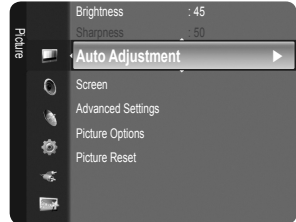

Screen

The purpose of the picture quality adjustment is to remove or reduce picture noise. If the noise is not removed by fine tuning alone, then make the vertical frequency adjustments on your PC and fine tune again. After the noise has been reduced, re-adjust the picture so that it is aligned on the center of the screen.

■ **Coarse / Fine**

The purpose of picture quality adjustment is to remove or reduce picture noise. If the noise is not removed by Fine-tuning alone, then adjust the frequency as best as possible (Coarse) and Fine-tune again. After the noise has been reduced, readjust the picture so that it is aligned on the center of screen.

■ **PC Position**

Adjust the PC's screen positioning if it does not fit the TV screen. Press the **▲** or **▼** button to adjusting the Vertical-Position. Press the **◀** or **▶** button to adjust the Horizontal-Position.

■ **Image Reset**

You can replace all image settings with the factory default values.

Picture Options

■ **Color Tone : Cool / Normal / Warm / Custom**

■ **R-Gain / G-Gain / B-Gain**

- R-Gain: Adjusts the red color brightness.
- G-Gain: Adjusts the green color brightness.
- B-Gain: Adjusts the blue color brightness.

■ **Size: 16:9 / 4:3**

Alternately, you can press the **P.SIZE** button on the remote control repeatedly to change the picture size.

16:9 : Sets the picture to 16:9 wide mode.

4:3 : Sets the picture to 4:3 normal mode.

Reset : Reset Picture Mode / Cancel

Resets all picture settings to the default values.

Reset Picture Mode: Current picture values return to default settings.

SOUND CONTROL

Configuring the Sound Menu

❑ **Mode** → **Standard / Music / Movie / Clear Voice / Custom**

You can select a sound mode to suit your personal preferences.



❑ **Equalizer**

The sound settings can be adjusted to suit your personal preference.

■ **Mode**

Selects the sound mode among the predefined settings.

■ **Balance L/R**

Adjusts the balance between the right and left speaker.

■ **100Hz / 300Hz / 1kHz / 3kHz / 10kHz (Bandwidth Adjustment)**

To adjust the level of different bandwidth frequencies.

■ **Reset**

Resets the equalizer settings to the default values.

❑ **Preferred Language (only digital channel)**

Digital-TV broadcasts are capable of simultaneous transmission of many audio tracks (for example, simultaneous translations of the program into foreign languages).

📖 You can listen in a language other than the “Preferred Language” by pressing the **MTS** button on the remote control.

📖 “Preferred Language” is available only in Digital TV mode.

📖 You can only select the language from among the actual languages being broadcast.

❑ **Multi-Track Sound (MTS) (only analog channel)**

📖 Press the **MTS** button on the remote control repeatedly to select “Mono”, “Stereo” or “SAP”.

- **Mono**: Choose for channels that are broadcasting in mono or if you are having difficulty receiving a stereo signal.

- **Stereo**: Choose for channels that are broadcasting in stereo.

- **SAP**: Choose to listen to the Separate Audio Program, which is usually a foreign-language translation.

📖 “Multi-Track Sound” is available only in Analog TV mode.

📖 Depending on the particular program being broadcast, you can listen to “Mono”, “Stereo” or “SAP”.

❑ **Auto Volume** → **Off / On**

Each broadcasting station has its own signal conditions, and so it is not easy to adjust the volume every time the channel is changed. This feature lets you automatically adjust the volume of the desired channel by lowering the sound output when the modulation signal is high.

❑ **Sound Reset** → **Reset All / Reset Sound Mode / Cancel**

You can restore the Sound settings to the factory defaults.

📖 **Reset Sound Mode**: Current sound values return to default settings.

SETUP

Configuring the Setup Menu

□ Language

You can set the menu language.

□ Time

■ Clock

Setting the clock is necessary in order to use the various timer features of the TV.

- 📄 The current time will appear every time you press the **INFO** button.
- 📄 If you disconnect the power cord, you have to set the clock again.
 - **Clock Mode**
 - **Auto**: Set the current time automatically using the time from the digital broadcast.
 - **Manual**: Set the current time to a manually specified time.
 - 📄 Depending on the broadcast station and signal, the auto time may not be set correctly. If this occurs, set the time manually.
 - 📄 The Antenna or cable must be connected in order to set the time automatically.
 - **Clock Set**
 - You can set the current time manually.
 - 📄 This function is only available when “**Clock Mode**” is set to “**Manual**”.
 - 📄 You can set the month, day, year, hour and minute directly by pressing the number buttons on the remote control.
 - **Time Zone**
 - Select your time zone.
 - 📄 This function is only available when “**Clock Mode**” is set to “**Auto**”.
 - **DST** (Daylight Saving Time) → **Off / On / Auto**
 - Switches the Daylight Saving Time function on or off.
 - 📄 This function is only available when “**Clock Mode**” is set to “**Auto**”.

■ Sleep Timer

The sleep timer automatically shuts off the TV after a preset time (30, 60, 90, 120, 150 and 180 minutes).

- 📄 Press the **TOOLS** button to display “**Tools**” menu. You can also set the sleep timer by selecting “**Tools** → **Sleep Timer**”.
- 📄 To cancel the “**Sleep Timer**” function, select “**Off**”.



■ Timer 1 / Timer 2 / Timer 3

Three different on / off timer settings can be made. You must set the clock first.

- **On Time:** Set the Hour, Minute, am/pm, and Activate/Inactivate. (To activate timer with the setting you've chosen, set to "**Activate**".)
- **Off Time:** Set the Hour, Minute, am/pm, and Activate/Inactivate. (To activate timer with the setting you've chosen, set to "**Activate**".)
- **Volume:** Set the required volume level.
- **Antenna:** View antenna type. (Air or Cable)
- ☑ You can set the Antenna by selecting Channel → Antenna.
- **Channel:** Select the desired channel.
- **Repeat:** Select "**Once**", "**Everyday**", "**Mon~Fri**", "**Mon~Sat**", "**Sat~Sun**" or "**Manual**".
- ☑ When "**Manual**" is selected, press the ► button to select the desired day of the week. Press the ◀ button over the desired day and the ✓ mark will appear.
- ☑ You can set the hour, minute and channel by pressing the number buttons on the remote control.
- ☑ **Auto Power Off**
When you set the timer On, the television will eventually turn off, if no controls are operated for 3 hours after the TV was turned on by the timer. This function is only available in timer On mode and prevents overheating, which may occur if a TV is on for too long time.

□ Game Mode → Off / On

When connecting to a game console such as PlayStation™ or Xbox™, you can enjoy a more realistic gaming experience by selecting the game menu.

- ☑ Restrictions on game mode (Caution)
 - To disconnect the game console and connect another external device, set **Game Mode to Off** in the setup menu. If you display the TV menu in **Game mode**, the screen shakes slightly.
- ☑ If **Game Mode** is **On** :
 - Picture mode is automatically changed to **Standard** and cannot be changed.
 - Sound mode is automatically changed to **Custom** and cannot be changed. Adjust the sound using the equalizer.
- ☑ **Game Mode** is not available in regular TV and PC mode.
- ☑ If the picture is poor when external device is connected to TV, check if **Game Mode** is **On**. Set **Game Mode** to **Off** and connect external devices.

□ V-Chip

☑ U.S.A and Canada Only

The V-Chip feature automatically locks out programs that are deemed inappropriate for children. The user must enter a PIN (personal ID number) before any of the V-Chip restrictions are set up or changed.

- ☑ "V-Chip" function is not available in HDMI or PC mode.
- ☑ The default PIN number of a new TV set is '0-0-0-0'
- ☑ If you forget the PIN, press the remote-control buttons in the following sequence, which resets the pin to 0-0-0-0 : **POWER** (off) → **MUTE** → 8 → 2 → 4 → **POWER** (on).
- ☑ **Allow all:** Press to unlock all TV ratings. / **Block all:** Press to lock all TV ratings.

■ V-Chip Lock → Off / On

You can block rated TV Programs.

■ TV Parental Guidelines

You can block TV programs depending on their rating. This function allows you to control what your children are watching.

- **TV-Y:** Young children / **TV-Y7:** Children 7 and over / **TV-G:** General audience /
- **TV-PG:** Parental guidance / **TV-14:** Viewers 14 and over / **TV-MA:** Mature audience
- **ALL:** Lock all TV ratings. / **FV:** Fantasy violence / **V:** Violence / **S:** Sexual situation / **L:** Adult Language / **D:** Sexually Suggestive Dialog

- ☑ The V-Chip will automatically block certain categories that are more restrictive. For example, if you block "TV-Y" category, then TV-Y7 will automatically be blocked. Similarly, if you block the TV-G category, then all the categories in the young adult group will be blocked (TV-G, TV-PG, TV-14 and TV-MA). The sub-ratings (D, L, S, V) work together similarly.
- ☑ The V-chip will automatically block certain categories that are 'More restrictive'. For example, if you block "L" sub-rating in TV-PG, then the "L" sub-ratings in TV-14 and TV-MA will automatically be blocked.

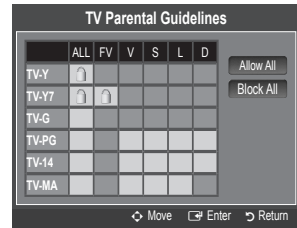

■ MPAA Rating

You can block movies depending on their MPAA rating. The Motion Picture Association of America (MPAA) has implemented a rating system that provides parents or guardians with advance information on which films are appropriate for children.

- **G:** General audience (no restrictions).
- **PG:** Parental guidance suggested.
- **PG-13:** Parents strongly cautioned.
- **R:** Restricted. Children under 17 should be accompanied by an adult.
- **NC-17:** No children under age 17.
- **X:** Adults only.
- **NR:** Not rated.

- ☑ The V-Chip will automatically block any category that is 'More restrictive'. For example, if you block the "PG-13" category, then "R", "NC-17" and "X" will automatically be blocked also.

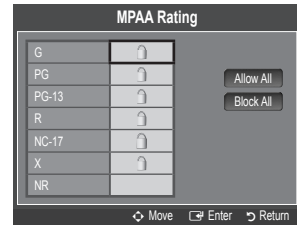

■ Canadian English

- **C:** Programming intended for children under age 8.
- **C8+:** Programming generally considered acceptable for children 8 years and over to watch on their own.
- **G:** General programming, suitable for all audiences.
- **PG:** Parental Guidance.
- **14+:** Programming contains themes or content which may not be suitable for viewers under the age of 14.
- **18+:** Adult programming.

- ☑ The V-Chip will automatically block any category that is 'More restrictive'. For example, if you block G category, then PG, 14+ and 18+ will automatically be blocked also.

■ Canadian French

- **G:** General
 - **8 ans+:** Programming generally considered acceptable for children 8 years and over to watch on their own.
 - **13 ans+:** Programming may not be suitable for children under the age of 13.
 - **16 ans+:** Programming is not suitable for children under the age of 16.
 - **18 ans+:** Programming restricted to adults.
- ☑ The V-Chip will automatically block any category that is 'More restrictive'. For example, if you block **8 ans+** category, then **13 ans+**, **16 ans+** and **18 ans+** will automatically be blocked also.

■ Downloadable U.S. Rating

Parental restriction information can be used while watching DTV channels

- ☑ If information is not downloaded from the broadcasting station, the "**Downloadable U.S. rating**" menu is deactivated.
- ☑ Parental restriction information is automatically downloaded while watching DTV channels. It may take several seconds.
- ☑ The "**Downloadable U.S. rating**" menu is available for use after information is downloaded from the broadcasting station. However, depending on the information from the broadcasting station, it may not be available for use.
- ☑ Parental restriction levels differ depending on the broadcasting station. The default menu name and Downloadable US rating changes depending on the downloaded information.
- ☑ Even if you set the On-screen display to your desired language, the "**Downloadable U.S. Rating**" menu will appear in English only.
- ☑ The rating will automatically block certain categories that are more restrictive.
- ☑ The rating titles (For example: Humor Level..etc) and TV ratings (For example: **DH**, **MH**, **H**..etc) may differ depending on the broadcasting station.

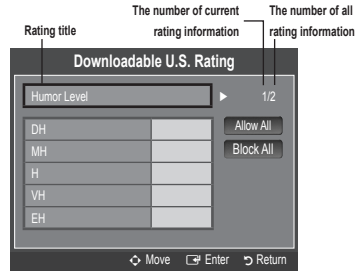

■ Change PIN

The **Change PIN** screen will appear. Choose any 4 digits for your PIN and enter them.

As soon as the 4 digits are entered, the **Confirm New PIN** screen appears. Re enter the same 4 digits. When the Confirm screen disappears, your PIN has been memorized.

- ☑ If you forget the PIN, press the remote-control buttons in the following sequence, which resets the pin to 0-0-0-0 : **POWER** (off) → **MUTE** → 8 → 2 → 4 → **POWER** (on).

How to Reset the TV after the V-Chip Blocks a Channel (“Emergency Escape”)

If the TV is tuned to a restricted channel, the V-Chip will block it. The screen will go blank and the following message will appear:

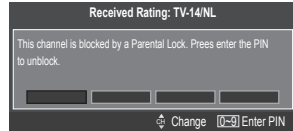

1. Enter your PIN, then press the **[OK]** button and press the **▲** or **▼** button to temporarily disable the V-Chip Lock.
 - ☑ If you forget the PIN, press the remote-control buttons in the following sequence, which resets the pin to 0-0-0-0 : **POWER** (off) → **MUTE** → **8** → **2** → **4** → **POWER** (on)

□ **Caption (On-Screen Text Messages)**

■ **Caption → Off / On**

You can switch the caption function on or off. If captions are not available, they will not be displayed on the screen.

- ☑ Press the **CC** button on the remote control to turn the Caption on or off.
- ☑ The Caption feature doesn't work in HDMI , PC or DVI modes.

■ **Caption Mode**

You can select the desired caption mode.

- ☑ The availability of captions depends on the program being broadcast.
 - **Default / CC1~CC4 / Text1~Text4** (analog channels only)
The Analog Caption function operates in either analog TV channel mode or when a signal is supplied from an external device to TV. (Depending on the broadcasting signal, the Analog Caption function may operate on digital channels.)
 - **Default / CC1~CC4 / Text1~Text4 / Service1~Service6** (digital channels only)
The Digital Captions function operates on digital channels.
 - ☑ Service1~6 in digital caption mode may not be available depending on the broadcast.

■ **Digital Caption Options (digital channels only)**

- **Size:** This option consists of “Default”, “Small”, “Standard” and “Large”. The default is “Standard”.
- **Font Style:** This option consists of “Default”, “Style0 ~ Style 7”. You can change the font you want. The default is “Style 0”.
- **Foreground Color:** This option consists of “Default”, “White”, “Black”, “Red”, “Green”, “Blue”, “Yellow”, “Magenta” and “Cyan”. You can change the color of the letter. The default is “White”.
- **Background Color:** This option consists of “Default”, “White”, “Black”, “Red”, “Green”, “Blue”, “Yellow”, “Magenta” and “Cyan”. You can change the background color of the caption. The default is “Black”.
- **Foreground Opacity:** This option consists of “Default”, “Transparent”, “Translucent”, “Solid” and “Flashing”. You can change the opacity of the letter.
- **Background Opacity:** This option consists of “Default”, “Transparent”, “Translucent”, “Solid” and “Flashing”. You can change the background opacity of the caption.
- **Return to Default:** This option sets each of “Size”, “Font Style”, “Foreground Color”, “Background color”, “Foreground Opacity” and “Background Opacity” to its default.
- ☑ “Digital Caption Options” are available only when “Default” and “Service1~Service6” can be selected in “Caption Mode”.
- ☑ The availability of captions depends on the program being broadcast.
- ☑ “Default” means to follow the standard set by the broadcaster.
- ☑ Foreground and Background cannot be set to have the same color.
- ☑ “Foreground Opacity” and “Background Opacity” cannot be both set to Transparent.

❑ Light Level

Use to adjust the light level i.e., the brightness of the light.

❑ Melody → Off / Low / Medium / High

A melody sound can be set to come on when the TV is powered On or Off.

☑ The Melody does not play.

- When no sound is output from the TV because the **MUTE** button has been pressed.
- When no sound is output from the TV because the volume has been reduced to minimum with the **VOL –** button.
- When the TV is turned off by Sleep Timer function.

❑ Energy Saving → Off / Low / Medium / High / Auto

This feature adjusts the brightness of the TV in order to reduce power consumption. When watching TV at night, set the “**Energy Saving**” mode option to “**High**” to reduce eye fatigue as well as power consumption.

INPUT / SUPPORT

Configuring the Input Menu

❑ Source List

Use to select TV or other external input sources such as DVD / Blu-Ray players / Satellite receivers (Set-Top Box) connected to the TV. Use to select the input source of your choice.

☑ Press the **SOURCE** button on the remote control to view an external signal source.

■ PC / TV / AV / HDMI

☑ You can choose only those external devices that are connected to the TV. In the “**Source List**”, connected inputs will be highlighted and sorted to the top. Inputs that are not connected will be sorted to the bottom.

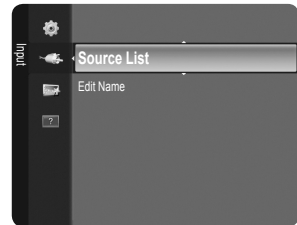

❑ Edit Name

Name the device connected to the input jacks to make your input source selection easier.

■ VCR / DVD / Cable STB / Satellite STB / PVR STB / AV Receiver / Game / Camcorder / PC / DVI PC / DVI / TV / IPTV / Blu-Ray / HD DVD / DMA

☑ When a PC with a resolution of 1920X1080@60Hz and 640x480@60Hz is connected to the **HDMI IN** port, you should set the “**HDMI1/DVI**” mode to “**PC**” in the “**Edit Name**” of the “**Input**” mode. Configuring the Support Menu. Configuring the Support Menu

Configuring the Support Menu

Self Diagnosis

Picture Test

If you think you have a picture problem, perform the picture test. Check the color pattern on the screen to see if the problem still exists.

- **Yes:** If the test pattern does not appear or there is noise in the test pattern, select **Yes**. There may be a problem with the TV. Contact Samsung's call center for assistance.
- **No:** If the test pattern is properly displayed, select **No**. There may be a problem with your external equipment. Please check your connections. If the problem still persists, refer to the external device's user manual.



Sound Test

If you think you have a sound problem, please perform the sound test. You can check the sound by playing a built-in melody sound through the TV. 'Does the problem still exist with this sound test?' appears on the screen.

- **Yes:** If during the sound test you can hear sound only from one speaker or not at all, select **Yes**. There may be a problem with the TV. Contact Samsung's call center for assistance.
- **No:** If you can hear sound from the speakers, select **No**. There may be a problem with your external equipment. Please check your connections. If the problem still persists, refer to the external device's user manual.

Signal Strength (digital channels only)

Unlike analog channels, which can vary in reception quality from 'snowy' to clear, digital (HDTV) channels have either perfect reception quality or you will not receive them at all. So, unlike analog channels, you cannot fine tune a digital channel. You can, however, adjust your antenna to improve the reception of available digital channels.

- ☑ If the signal strength meter indicates that the signal is weak, physically adjust your antenna to increase the signal strength. Continue to adjust the antenna until you find the best position with the strongest signal.

Software Upgrade

Samsung may offer upgrades for TV's firmware in the future. Please visit Samsung.com or contact the Samsung call center at 1-800-SAMSUNG (726-7864) to receive information about downloading upgrades and using a USB drive. Upgrades will be possible by connecting a USB drive to the **SERVICE** port located on your TV.

- ☑ Insert a USB drive containing the firmware upgrade into the **SERVICE** port on the side of the TV.
- ☑ Please be careful to not disconnect the power or remove the USB drive while upgrades are being applied. The TV will turn off and turn on automatically after completing the firmware upgrade. Please check the firmware version after the upgrades are complete. When software is upgraded, video and audio settings you have made will return to their default (factory) settings. We recommend you write down your settings so that you can easily reset them after the upgrade.

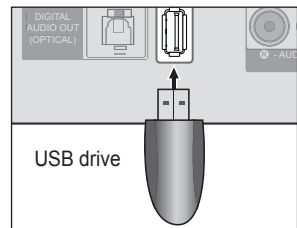

❑ HD Connection Guide

This menu presents the connection method that provides the optimal quality for the HD TV. Refer to this information when connecting external devices to the TV.

❑ Contact Samsung

View this information when your TV does not work properly or when you want to upgrade the software. You can view the information regarding the call center, product and software file download method.

ANYNET+

Connecting Anynet+ Devices

Anynet+ is a function that enables you to control all connected Samsung devices that support Anynet+ with your Samsung TV's remote.

The Anynet+ system can be used only with Samsung devices that have the Anynet+ feature. To be sure your Samsung device has this feature, check if there is an Anynet+ logo on it.

To connect to a TV

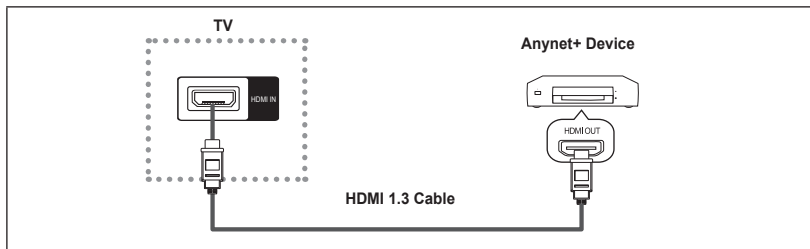

1. Connect the **HDMI IN** jack on the TV and the HDMI OUT jack of the corresponding Anynet+ device using an HDMI cable.
 - ☑ Connect only one Home Theater.
 - ☑ You can connect an Anynet+ device using the HDMI 1.3 cable. Some HDMI cables may not support Anynet+ functions.
 - ☑ Anynet+ works when the AV device supporting Anynet+ is in the Standby or On status.
 - ☑ Anynet+ supports up to 10 AV devices in total. Note that you can connect up to 4 devices of the same type.

Setting Up Anynet+

- Press the **TOOLS** button to display the **Tools** menu. You can also display Anynet+ menu by selecting **Tools** → **Anynet+ (HDMI-CEC)**.

Setup

Anynet+ (HDMI-CEC) → Off / On

To use the Anynet+ Function, Anynet+ (HDMI-CEC) must be set to On.

- When the **Anynet+ (HDMI-CEC)** function is disabled, all the Anynet+ related operations are deactivated.



Auto Turn Off → No / Yes

Setting an Anynet+ Device to turn Off Automatically when the TV is Turned Off

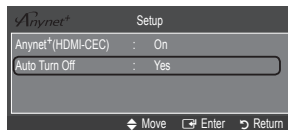
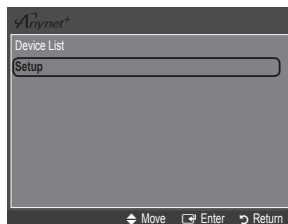
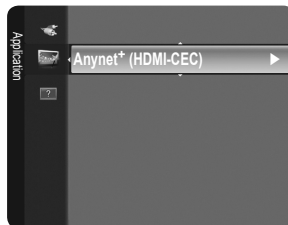
- The active source on the TV remote must be set to TV to use the Anynet+ function.
- If you set **Auto Turn Off** to **Yes**, connected external devices are also turned off when the TV is turned off. If an external device is still recording, it may or may not turn off.



Switching between Anynet+ Devices

1. Press the **TOOLS** button. Press the  button to select **Anynet+ (HDMI-CEC)**.
2. Press the **▲** or **▼** button to select **Device List**, then press the  button.
 - Anynet+ devices connected to the TV are listed.
 - If you cannot find a device you want, press the red button to scan for devices.
3. Press the **▲** or **▼** button to select a particular device and press the  button. It is switched to the selected device.
 - Only when you set **Anynet+ (HDMI-CEC)** to On in the **Application** menu, the **Device List** menu appears.
 - Switching to the selected devices may take up to 2 minutes. You cannot cancel the operation during the switching operation.
 - The time required to scan for devices is determined by the number of connected devices.
 - When the device scan is complete, the number of devices found are not displayed.
 - Although the TV automatically searches the device list when the TV is turned on via the power button, devices connected to the TV when the TV is on or under some conditions are not automatically displayed in the device list. Press the red button to search for the connected device.
 - If you have selected external input mode by pressing the **SOURCE** button, you cannot use the Anynet+ function. Make sure to switch to an Anynet+ device by using the **Device List**.



Anynet+ Menu

The Anynet+ menu changes depending on the type and status of the Anynet+ devices connected to the TV.

Anynet+ Menu	Description
View TV	Anynet+ mode changes to TV broadcast mode.
Device List	Shows the Anynet+ device list.
(device_name) Menu	Shows the connected device menus. E.g. If a DVD recorder is connected, the disc menu of the DVD recorder will appear.
(device_name) Operation	Shows the play menu of the connected device. E.g. If a DVD recorder is connected, the play menu of the DVD recorder will appear.
Record: (*recorder)	Starts recording immediately using the recorder. (This is only available for devices that support the recording function.)
Stop Recording: (*recorder)	Stops recording.
Receiver	Sound is played through the receiver.

- If more than one recording device is connected, they are displayed as (*recorder) and if only one recording device is connected, it will be represented as (*device_name).

Troubleshooting for Anynet+

Problem	Possible Solution
Anynet+ does not work.	<ul style="list-style-type: none"> ● Check if the device is an Anynet+ device. The Anynet+ system supports Anynet+ devices only. ● Connect only one receiver (home theater). ● Check if the Anynet+ device power cord is properly connected. ● Check the Anynet+ device's Video/Audio/HDMI 1.3 cable connections. ● Check whether Anynet+ (HDMI-CEC) is set to On in the Anynet+ setup menu. ● Check whether the TV remote control is in TV mode. ● Check whether it is Anynet+ exclusive remote control. ● Anynet+ doesn't work in certain situations. (Searching channels, Operating, Plug & Play, etc.) ● When connecting or removing the HDMI 1.3 cable, please make sure to search devices again or turn your TV off and on again. ● Check if the Anynet+ Function of Anynet+ device is set on.
I want to start Anynet+.	<ul style="list-style-type: none"> ● Check if the Anynet+ device is properly connected to the TV and check if the Anynet+ (HDMI-CEC) is set to On in the Anynet+ Setup menu. ● Press the TV button on the TV remote control to switch to TV. Then press the TOOLS button to show the Anynet+ menu and select a menu you want.
I want to exit Anynet+.	<ul style="list-style-type: none"> ● Select View TV in the Anynet+ menu. ● Press the SOURCE button on the TV remote control and select a device other than Anynet+ devices. ● Press ∨ CH ∧, CH LIST, PRE-CH, and FAV.CH to change the TV mode. (Note that the channel button operates only when a tuner-embedded Anynet+ device is not connected.)
The message Connecting to Anynet+ device... appears on the screen.	<ul style="list-style-type: none"> ● You cannot use the remote control when you are configuring Anynet+ or switching to a view mode. ● Use the remote control when the Anynet+ setting or switching to view mode is complete.
The Anynet+ device does not play.	<ul style="list-style-type: none"> ● You cannot use the play function when Plug & Play is in progress.
The connected device is not displayed.	<ul style="list-style-type: none"> ● Check whether or not the device supports Anynet+ functions. ● Check whether or not the HDMI 1.3 cable is properly connected. ● Check whether Anynet+ (HDMI-CEC) is set to On in the Anynet+ setup menu. ● Search Anynet+ devices again. ● You can connect an Anynet+ device using the HDMI 1.3 cable only. Some Some HDMI cables may not support Anynet+ functions. ● If it is terminated by an abnormal situation such as disconnecting the HDMI cable or power cord or a power failure, please repeat the device scan.
The TV program cannot be recorded.	<ul style="list-style-type: none"> ● Check whether the antenna jack on the recording device is properly connected.
The TV sound is not output through the receiver.	<ul style="list-style-type: none"> ● Connect the optical cable between TV and the receiver.

INSTALLING THE SOFTWARE

Installing the Device Driver

- ☑ If you install the device driver, you can set up the appropriate resolution and frequency for the product. The device driver is included on the CD supplied with the product. If the supplied drive file is corrupted, please visit the Samsung Electronics website (www.samsung.com), and download the driver.
1. Insert the driver installation CD into the CD-ROM drive.
 2. Click on Windows Driver.
 3. Select the model of your product from the model list.

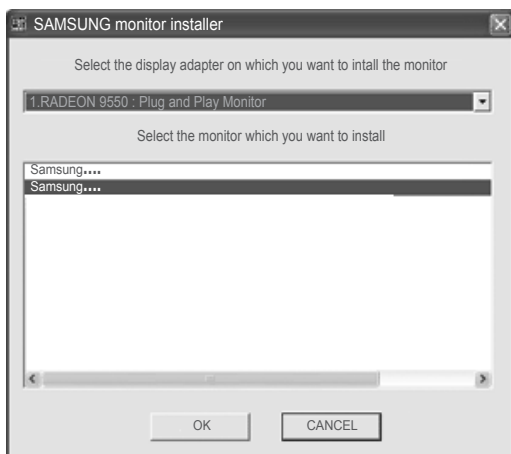

4. Complete the remaining installation steps according to the instructions displayed on the screen.
5. Check if the appropriate resolution and screen refresh rate are displayed in the Control Panel settings. For more information, refer to the document about the Windows operating system.

Natural Color

This software is for Samsung products only and enables you to adjust the displayed colors on the product so they more closely match the colors of printed pictures. For more information, refer to the online help of the software (F1).

- ☑ Natural Color is provided online. You can download it from the website below and install; http://www.samsung.com/us/consumer/learningresources/monitor/naturalcolorexpert/pop_download.html

MultiScreen

MultiScreen enables you to partition multiple sections on the Monitor.

- **Installing the Software**

1. Insert the installation CD into the CD-ROM drive.
2. Select the MultiScreen setup program.

If the pop-up screen for the software installation does not appear on the main screen, find and double-click the MultiScreen setup file on the CD-ROM.

3. When the Installation Wizard appears, click [Next].

4. Complete the remaining software installation steps according to the instructions displayed on the screen.

The software may not work properly if you do not restart the computer after the installation.

The MultiScreen icon may not appear depending on the computer system and the product specifications.

If the shortcut icon does not appear, press the F5 key.

- **MultiScreen Installation Requirements**

The MultiScreen installation may be affected by the graphics card, motherboard and the networking environment.

- **Operating System**

OS	<ul style="list-style-type: none">• Windows 2000• Windows XP Home Edition• Windows XP Professional• Windows Vista <p><input checked="" type="checkbox"/> For MultiScreen, Windows 2000 or later operating systems are recommended.</p>
Hardware	<ul style="list-style-type: none">• At least 32MB of memory• At least 60MB of free space on the hard disk drive

- **Removing the Software**

Click [Start], select [Settings]/[Control Panel], and then double-click [Add or Remove Programs]. Select MultiScreen from the program list and click the [Add/Delete] button.

APPENDIX

TV Monitor Self-Diagnosis

- ☑ You can check if the product is working properly using the Self-Diagnosis function.
- ☑ If a blank screen is displayed and the Power LED blinks even if the product and the PC are properly connected, perform the selfdiagnosis function according to the procedures below.
 1. Turn the product and the PC off.
 2. Remove the D-Sub cable from the product.
 3. Turn the product on.
 4. If the product is working properly, the <Check Signal Cable> message appears.
In this case, if a blank screen is displayed again, make sure that there is no problem with the PC and the connection.

Troubleshooting

If the TV seems to have a problem, first try this list of possible problems and solutions. If none of these troubleshooting tips apply, call Samsung customer service at 1-800-SAMSUNG.

Problem	Possible Solution
Poor picture.	Try another channel. / Adjust the antenna. / Check all wire connections.
Poor sound quality.	Try another channel. / Adjust the antenna.
No picture or sound.	Try another channel. / Press the SOURCE button. Make sure the TV is plugged in. / Check the antenna connections.
No sound or sound is too low at maximum volume.	First, check the volume of units connected to your TV (digital broadcasting receiver, DVD, cable broadcasting receiver, VCR, etc.). Then, adjust the TV volume accordingly.
The TV operates erratically.	Unplug the TV for 30 seconds, then try operating it again.
The TV won't turn on.	Make sure the wall outlet is working.
Remote control malfunctions.	Replace the remote control batteries. Clean the upper edge of the remote control (transmission window). Check the battery terminals.
'Check signal cable' message.	Ensure that the signal cable is firmly connected to the PC and DVI source.
'Not Supported Mode' message.	Check the maximum resolution and connected device's Video frequency. Compare these values with the data in the Display Modes.
Digital broadcasting screen problem.	Please check the digital signal strength and input antenna.
The image is too light or too dark.	Adjust the Brightness and Contrast. / Adjust the Fine tuning.

Problem	Possible Solution
Black bars on the screen.	Make sure the broadcast you're receiving is High Definition (HD). HD channels sometimes broadcast Standard Definition (SD) programming, which can cause black bars. Set your cable/satellite box to stretch or widescreen mode to eliminate the bars.
Picture has a Red/Green or Pink tint.	Make sure the Component cables are connected to the correct jacks.
Closed Captioning not working.	If you are using a Cable/Satellite box, you must set Closed Captioning on the box, not your TV.
Snowy picture.	Your cable box may need a firmware upgrade. Please contact your Cable company.
Ghosting on picture.	This is sometimes caused by compatibility issues with your cable box. Try connecting Component cables instead.
Screen is black and power indicator light blinks steadily.	On your computer check: Power, Signal Cable. The TV is using its power management system. Move the computer's mouse or press any key on the keyboard.
Image is not stable and may appear to vibrate when you have a computer connected to the PC input.	If the setting is not correct, use your computer utility program to change the display settings. Your TV supports multiscan display functions within the following frequency domain: - Horizontal frequency (kHz): 30 ~ 81 kHz - Vertical frequency (Hz): 56 ~ 75 Hz - PC Maximum refresh rate (at 60 Hz): 1360 X 768
Image is not centered on the screen.	Adjust the horizontal and vertical position. The screen position must be adjusted on the output source (i.e. STB) with a digital signal.
The picture appears distorted in the corner of the screen.	If " Screen Fit " is selected with some external devices, the picture may appear distorted in the corner of the screen. This symptom is caused by the external devices, not TV.
The 'Resets all settings to the default values.' message appears.	This appears when you press and hold the EXIT button for a while. The product settings are reset to the factory defaults.

- ☑ This TFT LCD panel uses a panel consisting of sub pixels (3,133,440) which require sophisticated technology to produce. However, there may be few bright or dark pixels on the screen. These pixels will have no impact on the performance of the product.

FAQ

FAQ	PLEASE TRY THE FOLLOWING!
How can I change the frequency of the video signal?	You have to change the frequency of the graphics card. (For more information, refer to the User Manual of the computer or the graphics card.)
How can I change the resolution?	Windows XP: Change the resolution by selecting Control Panel→Appearance and Themes→Display→Settings. Windows ME/2000 : Change the resolution by selecting Control Panel→Appearance and Themes→Display→Settings. (For more information, refer to the User Manual of the computer or the graphics card.)
How can I use the power saving function?	Windows XP: Configure it by selecting Control Panel→Appearance and Themes→Display→Screen Saver Setting or configure it in the BIOS SETUP of the computer. Windows ME/2000 : Configure it by selecting Control Panel→Appearance and Themes→Display→Screen Saver Setting or configure it in the BIOS SETUP of the computer. For more information, refer to the Windows user manual for the computer.
How can I clean the outer case/ LCD Panel?	Disconnect the power cord and then clean the monitor with a soft, dry or slightly damp cloth. Do not leave any detergent or scratches on the case. Do not let any water enter the monitor.
Can I watch digital TV broadcasting with an analog TV?	No. The analog TV cannot interpret digital signals. Therefore, a digital TV is required to watch digital TV broadcasting.
Can I use my present antenna to receive digital broadcasting?	As for existing analog TV, digital TV is designed so that digital broadcasting signals are received via both indoor and outdoor antennas. If signal reception is very good in your environment, you can watch digital broadcasts with your existing indoor antenna. If not, it is better to install an outdoor antenna.

Installing the Stand

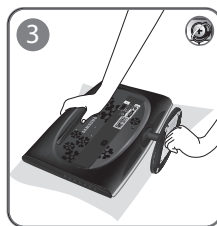
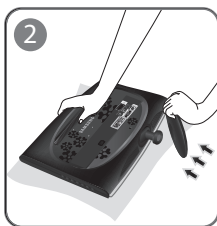

1. Place the front of the TV onto a soft cloth or cushion on a table.
 Align the TV bottom along the table edge.
2. Insert the Stand Connector into the Stand in the direction shown by the figure.
3. Turn the connecting screw at the bottom of the stand fully so that it is completely fixed.

Disconnecting the Stand

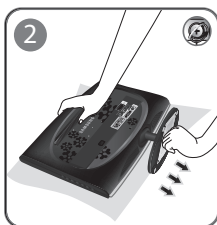
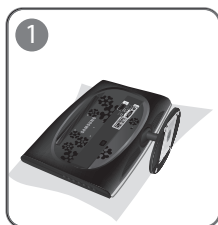

1. Place the front of the TV onto a soft cloth or cushion on a table.
 Align the TV bottom along the table edge.
2. Turn the connecting screw at the bottom of the stand to separate it.
 Do not lift the product holding only the stand.

Wall Mount Kit Specifications (VESA)

Install your wall mount on a solid wall perpendicular to the floor. When attaching to other building materials, please contact your nearest dealer. If installed on a ceiling or slanted wall, it may fall and result in severe personal injury.

- ☑ When purchasing our wall mount kit, a detailed installation manual and all parts necessary for assembly are provided.
- ☑ Do not use screws longer than the standard dimension, as they may cause damage to the inside of the TV set.
- ☑ For wall mounts that do not comply with the VESA standard screw specifications, the length of the screws may differ depending on their specifications.
- ☑ Do not use screws that do not comply with the VESA standard screw specifications.
- ☑ Do not fasten the screws too strongly, this may damage the product or cause the product to fall, leading to personal injury. Samsung is not liable for these kinds of accidents.
- ☑ Samsung is not liable for product damage or personal injury when a non-VESA or non-specified wall mount is used or the consumer fails to follow the product installation instructions.

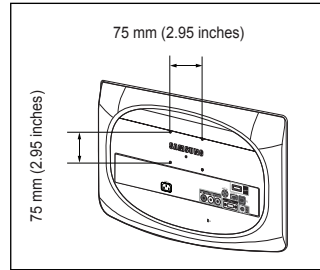

Do not install your Wall Mount Kit while your TV is turned on. It may result in personal injury due to electric shock.

Using the Anti-Theft Kensington Lock

The Kensington Lock is a device used to physically fix the system when using it in a public place. The appearance and locking method may differ from the illustration depending on the manufacturer.

Refer to the manual provided with the Kensington Lock for proper use. The locking device has to be purchased separately.

- ☑ The location of the Kensington Lock may be different depending on its model.

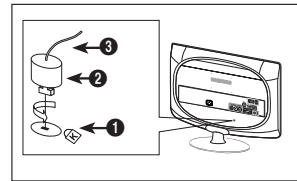

1. Insert the locking device into the Kensington slot on the LCD TV (1) and turn it in the locking direction (2).
2. Connect the Kensington Lock cable (3).
3. Fix the Kensington Lock to a desk or a heavy stationary object.

Securing the Installation Space

Keep the required distances between the product and other objects (e.g. walls) to ensure proper ventilation.

Failing to do so may result in fire or a problem with the product due to an increase in the internal temperature of the product.

Install the product so the required distances shown in the figure are kept.

- ☑ When using a stand or wall-mount, use parts provided by Samsung Electronics only.
 - If you use parts provided by another manufacturer, it may result in a problem with the product or an injury due to the product falling.
 - If you use parts provided by another manufacturer, it may result in a problem with the product or fire due to an increase in the internal temperature of the product due to poor ventilation.
- ☑ The appearance may differ depending on the product.

When installing the product with a stand

When installing the product with a wall-mount

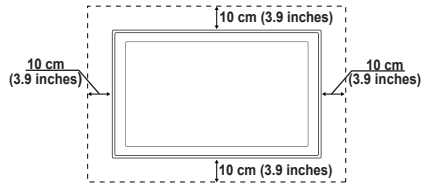
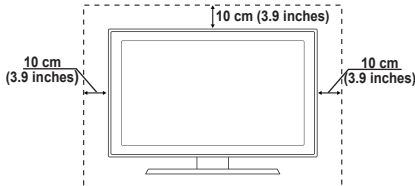

Specifications

Model Name	933HD Plus
Screen Size Diagonal	18.5 inches (47 cm)
Display area	409.8 mm (H) x 230.4 mm(V) (16.13 inches X 9.07 inches)
Pixel Pitch	0.3 mm (H) x 0.3 mm (V) (0.01 inches X 0.01 inches)
Display Color	16.7M
Maximum Pixel Clock	85.000 MHz (Analog, Digital)
Power Supply	This product supports 100 – 240 V. Since the standard voltage may differ from country to country, please check the label on the back of the product.
PC Resolution	1360 X 768 @ 60 Hz
Sound Output	3W x 2
Dimensions (WxDxH) Body With stand	454.5 x 307 x 67.5 mm (17.9 x 12.1 x 2.7 inches) 454.5 x 353.5 x 177 mm (17.9 x 14.0 x 7.0 inches)
Weight With Stand	4.0 kg (8.8 lbs)
Environmental Considerations Operating Temperature Operating Humidity Storage Temperature Storage Humidity	50°F to 104°F (10°C to 40°C) 10% to 80%, non-condensing -4°F to 113°F (-20°C to 45°C) 5% to 95%, non-condensing
VESA Mounting Interface	75 mm x 75 mm (2.95 x 2.95 inches)

- ☑ Design and specifications are subject to change without prior notice.
- ☑ This device is a Class B digital apparatus.
- ☑ For the power supply and Power Consumption, refer to the label attached to the product.

Power Saving Function

This product provides a power saving function that automatically turns the screen off when the product is not used for a predetermined period of time to reduce power consumption. If the product enters power saving mode, the power LED turns to a different color to indicate that the product is in power saving mode. When the product is in power saving mode, the power is not turned off and you can turn the screen on again by pressing any key or clicking the mouse. However, the power saving function only works when the product is connected to a computer that provides the power saving function.

POWER SAVING FUNCTION	NORMAL OPERATION	POWER SAVING MODE	POWER OFF (POWER BUTTON)
Power LED	On	Blinks	Off
Power Consumption	34 watts	less than 2 watts	less than 1 watts

- ☑ If there is no power cut-off switch, the power consumption is "0" only when the power cord is disconnected.



Contact SAMSUNG WORLDWIDE

If you have any questions or comments relating to Samsung products, please contact the SAMSUNG customer care center.

Country	Customer Care Center ☎	Web Site
ARGENTINA	0800-333-3733	www.samsung.com/ar
BRAZIL	0800-124-421 4004-0000	www.samsung.com/br
CHILE	800-SAMSUNG(726-7864)	www.samsung.com/cl
COLOMBIA	01-8000112112	www.samsung.com.co
COSTA RICA	0-800-507-7267	www.samsung.com/latin
ECUADOR	1-800-10-7267	www.samsung.com/latin
EL SALVADOR	800-6225	www.samsung.com/latin
GUATEMALA	1-800-299-0013	www.samsung.com/latin
HONDURAS	800-7919267	www.samsung.com/latin
JAMAICA	1-800-234-7267	www.samsung.com/latin
PANAMA	800-7267	www.samsung.com/latin
PUERTO RICO	1-800-682-3180	www.samsung.com/latin
REP. DOMINICA	1-800-751-2676	www.samsung.com/latin
NICARAGUA	00-1800-5077267	www.samsung.com/latin
MEXICO	01-800-SAMSUNG(726-7864)	www.samsung.com/mx
TRINIDAD & TOBAGO	1-800-SAMSUNG(726-7864)	www.samsung.com/latin
VENEZUELA	0-800-100-5303	www.samsung.com/latin

IMPORTADO POR:
AV. PRESIDENTE MASARIK #111 INT701
COL. CHAPULTEPEC MORALES C.P.11570
DELEGACION MIGUEL HIDALGO MEXICO. DISTRITO FEDERAL
Tel: 01-55-5747-5100 / 01-800-726-7864